

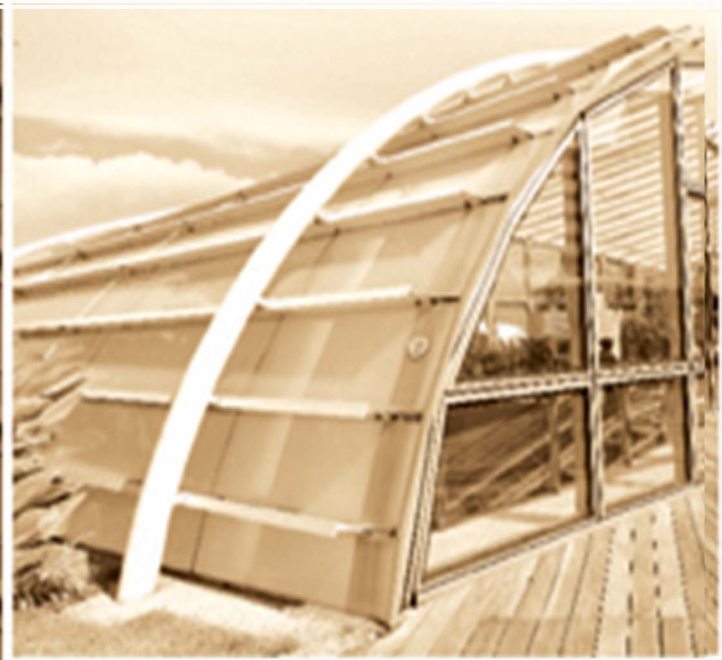

IS /ISO 9001 : 2008
ALUMINIUM WINDOW

Experience the Quality



Changing
the face of the world

JINDAL ALUMINIUM LIMITED
BANGALORE, INDIA

PROFILE CATALOGUE-2016

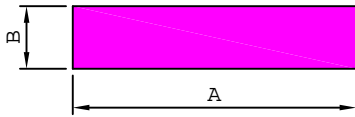
BARS & RODS**FLAT BARS**

SL. No.	Section No.	A	B	Weight kg/m
1	S4834	6.40	5.90	0.102
2	10372	7.00	5.50	0.104
3	10171	8.00	2.00	0.043
4	10318	8.50	8.00	0.183
5	10277	10.00	8.00	0.216
6	10351	11.50	6.35	0.197
7	10001	12.00	2.00	0.065
8	10061	12.00	3.00	0.097
9	10164	12.00	4.00	0.130
10	10110	12.50	6.00	0.202
11	10036	12.70	5.00	0.171
12	10369	12.70	8.50	0.291
13	10207	14.00	4.00	0.151
14	10153	15.00	2.00	0.081
15	10452	15.00	2.00	0.081
16	10087	15.00	3.00	0.122
17	10144	15.00	8.00	0.324
18	10103	15.00	8.55	0.346
19	10278	15.87	2.34	0.100
20	10135	16.95	4.15	0.190
21	10220	17.00	4.00	0.183
22	S4833	17.00	4.15	0.190
23	10160	17.50	1.80	0.085
24	10344	17.50	5.40	0.255
25	10122	18.00	1.55	0.075
26	10109	18.00	2.50	0.121
27	10288	18.75	4.00	0.202
28	10279	19.00	1.82	0.093
29	10003	19.00	5.00	0.257
30	10035	19.00	9.50	0.487
31	10458	19.00	12.70	0.651
32	10123	19.05	2.25	0.116
33	10004	19.05	2.95	0.152
34	10005	19.05	3.18	0.163
35	10006	19.05	4.78	0.246
36	10007	19.05	6.35	0.327
37	10280	19.60	1.10	0.058
38	10118	20.00	1.60	0.086
39	10365	20.00	2.10	0.113
40	10008	20.00	3.00	0.162
41	10223	20.00	4.00	0.215
42	10065	20.00	5.00	0.270
43	10106	20.00	6.00	0.324
44	10009	20.00	8.00	0.432
45	10138	20.00	10.00	0.540
46	10302	20.00	15.00	0.810
47	S4401	20.60	4.00	0.222
48	10500	21.00	18.00	1.020
49	10129	22.00	2.00	0.118

SL. No.	Section No.	A	B	Weight kg/m
50	S4844	22.00	4.00	0.237
51	10408	22.35	2.81	0.169
52	10091	23.00	2.50	0.155
53	S4826	24.00	4.00	0.259
54	10095	25.00	1.00	0.068
55	10116	25.00	1.50	0.101
56	10281	25.00	2.80	0.189
57	10010	25.00	3.00	0.203
58	10178	25.00	5.00	0.337
59	10011	25.00	6.00	0.405
60	10270	25.00	6.50	0.439
61	10107	25.00	8.00	0.540
62	10506	25.00	10.00	0.675
63	10197	25.00	15.00	1.013
64	10222	25.00	16.00	1.080
65	10075	25.40	2.00	0.137
66	10080	25.40	2.30	0.158
67	10012	25.40	2.95	0.202
68	10013	25.40	3.18	0.218
69	10411	25.40	3.18	0.218
70	10034	25.40	4.00	0.274
71	10014	25.40	6.35	0.435
72	10152	25.40	9.52	0.652
73	10102	25.40	12.75	0.874
74	10391	25.40	15.88	1.089
75	10191	25.40	19.05	1.304
76	10101	25.45	4.78	0.328
77	10094	27.00	15.00	1.093
78	S4143	27.00	18.00	1.312
79	10396	27.00	24.00	1.749
80	10273	28.00	15.00	1.134
81	S4192	29.00	20.00	1.566
82	10168	30.00	2.00	0.162
83	10265	30.00	2.90	0.235
84	10189	30.00	3.00	0.243
85	10015	30.00	5.00	0.405
86	10142	30.00	8.00	0.648
87	10441	30.00	10.00	0.809
88	10375	30.00	13.00	1.053
89	10274	30.00	15.00	1.215
90	10195	30.00	20.00	1.620
91	S4885	30.00	6.00	0.486
92	10017	30.18	3.96	0.322
93	10079	31.75	2.30	0.197
94	10018	31.75	2.95	0.253
95	10347	31.75	3.18	0.272
96	10077	31.75	4.78	0.410
97	10019	31.75	6.35	0.544
98	10086	31.75	9.52	0.816
99	10524	31.75	12.70	1.088
100	10258	31.75	15.88	1.361
101	10198	31.75	19.05	1.633
102	10193	31.75	25.40	2.177
103	10409	31.85	3.18	0.273
104	10226	32.00	6.00	0.518
105	10227	32.00	10.00	0.864
106	10504	32.00	12.00	1.036
107	10120	33.50	12.00	1.085

SL. No.	Section No.	A	B	Weight kg/m
108	S5090	34.00	15.00	1.377
109	10348	34.92	3.18	0.299
110	10211	35.00	2.96	0.279
111	10397	35.00	5.00	0.472
112	10399	35.00	21.00	1.984
113	10243	36.00	2.65	0.257
114	10356	37.00	2.00	0.199
115	10477	38.00	1.50	0.154
116	10126	38.00	2.00	0.205
117	10190	38.00	3.00	0.308
118	10029	38.00	3.20	0.328
119	10181	38.00	5.00	0.513
120	10511	38.00	16.00	1.641
121	10336	38.00	20.00	2.052
122	10020	38.10	3.18	0.327
123	10410	38.10	3.18	0.327
124	10421	38.10	3.81	0.392
125	10033	38.10	4.78	0.492
126	10405	38.10	5.08	0.522
127	10021	38.10	6.35	0.653
128	10088	38.10	9.52	0.979
129	10104	38.10	12.70	1.306
130	10199	38.10	25.40	2.613
131	10267	38.10	31.75	3.226
132	10140	40.00	1.60	0.173
133	10031	40.00	3.00	0.324
134	10047	40.00	4.00	0.432
135	10048	40.00	5.00	0.540
136	10503	40.00	6.00	0.648
137	10165	40.00	6.50	0.702
138	10148	40.00	8.00	0.864
139	10057	40.00	10.00	1.080
140	10083	40.00	12.00	1.296
141	10093	40.00	15.00	1.620
142	10466	40.00	16.00	1.728
143	10137	40.00	20.00	2.160
144	S4173	40.00	32.00	3.456
145	10359	40.00	33.00	3.564
146	10459	41.50	4.00	0.448
147	10022	42.00	6.00	0.680
148	10307	42.00	27.00	3.061
149	10358	43.00	2.00	0.232
150	10373	44.00	16.00	1.900
151	10023	44.45	3.18	0.382
152	10366	44.45	12.70	1.524
153	10068	44.45	19.05	2.286
154	10218	44.45	25.40	3.048
155	10380	45.00	6.00	0.729
156	10162	45.00	25.00	3.037
157	12146	45.00	32.00	3.888
158	10067	47.00	2.00	0.254
159	10143	50.00	3.00	0.405
160	10030	50.00	4.00	0.540
161	10072	50.00	5.00	0.675
162	10069	50.00	6.00	0.810
163	10251	50.00	6.50	0.877
164	10100	50.00	8.00	1.080
165	10042	50.00	10.00	1.350
166	10232	50.00	12.00	1.619

BARS & RODS**FLAT BARS**

SL. No.	Section No.	A	B	Weight kg/m
167	10113	50.00	13.70	1.850
168	10145	50.00	15.00	2.025
169	10286	50.00	20.00	2.700
170	10379	50.00	30.00	4.050
171	10510	50.80	3.18	0.436
172	10024	50.80	6.35	0.870
173	10037	50.80	9.52	1.306
174	10038	50.80	12.70	1.742
175	10071	50.80	15.88	2.178
176	10200	50.80	19.05	2.613
177	10217	50.80	25.40	3.483
178	10475	50.80	32.00	4.389
179	10467	50.80	38.10	5.225
180	10259	50.80	44.45	6.096
181	10515	51.00	46.00	6.334
182	10527	52.00	42.00	5.896
183	10256	54.00	3.30	0.481
184	10173	55.00	35.00	5.198
185	10201	57.15	12.70	1.960
186	10487	59.00	21.00	3.345
187	10293	59.54	6.35	1.020
188	10312	59.95	3.33	0.539
189	10053	60.00	6.00	0.972
190	10039	60.00	10.00	1.620
191	10505	60.00	15.00	2.430
192	10196	60.00	20.00	3.240
193	10156	60.00	30.00	4.860
194	10480	60.30	32.00	5.210
195	10208	61.00	43.00	7.082
196	10389	63.00	8.00	1.360
197	10390	63.00	12.00	2.041
198	10184	63.00	38.00	6.464
199	10325	63.50	4.76	0.816
200	10025	63.50	6.35	1.089
201	10073	63.50	9.52	1.632
202	10468	63.50	12.70	2.177
203	10494	63.50	15.88	2.722
204	10202	63.50	19.05	3.266
205	10192	63.50	22.22	3.810
206	10194	63.50	25.40	4.355
207	10260	63.50	31.75	5.443
208	10203	63.50	44.45	7.621
209	10268	63.50	50.80	8.709
210	10050	64.00	12.00	2.074
211	10413	64.00	34.00	5.875
212	10368	64.50	4.00	0.696
213	10131	65.00	50.00	8.775
214	10098	66.00	9.00	1.604
215	10295	66.50	14.20	2.550
216	10216	69.85	50.80	9.580
217	10343	69.90	64.00	12.078
218	10225	70.00	3.18	0.601
219	S5002	70.00	6.00	1.134
220	10245	70.00	12.00	2.268
221	10331	70.00	20.00	3.780
222	10188	70.00	30.00	5.670
223	10482	70.00	40.00	7.560
224	10206	72.00	52.00	10.109
225	10269	73.00	2.70	0.532

SL. No.	Section No.	A	B	Weight kg/m
226	10166	75.00	5.00	1.013
227	10382	75.00	6.00	1.215
228	10332	75.00	8.00	1.620
229	10125	75.00	10.00	2.025
230	10084	75.00	12.00	2.430
231	10111	75.00	12.50	2.531
232	10052	76.00	15.00	3.078
233	10026	76.20	6.35	1.306
234	10059	76.20	9.52	1.958
235	10058	76.20	12.70	2.613
236	10476	76.20	16.00	3.291
237	10204	76.20	19.05	3.919
238	10285	76.20	25.40	5.225
239	10205	76.20	31.75	6.532
240	10315	76.20	38.10	7.838
241	10362	76.20	50.80	10.451
242	10518	76.20	63.50	13.064
243	10287	80.00	4.00	0.864
244	10520	80.00	5.00	1.080
245	10049	80.00	6.00	1.296
246	10054	80.00	8.00	1.728
247	10060	80.00	10.00	2.160
248	10531	80.00	12.00	2.592
249	S4950	80.00	15.00	3.240
250	10261	80.00	20.00	4.320
251	10154	80.00	30.00	6.480
252	10130	80.00	70.00	15.120
253	10489	82.00	2.00	0.442
254	10133	85.00	65.00	14.918
255	10478	85.00	68.00	15.606
256	10136	85.72	34.92	8.082
257	10490	86.00	2.00	0.464
258	10236	88.00	45.00	10.692
259	10404	88.90	25.40	6.096
260	10321	88.90	76.20	18.290
261	10367	89.20	20.00	4.816
262	10516	89.50	44.50	10.753
263	10497	90.00	12.00	2.916
264	S5126	90.00	25.00	6.075
265	10350	90.00	30.00	7.290
266	10353	91.00	8.00	1.965
267	10117	95.00	5.00	1.282
268	10415	98.00	7.80	2.064
269	10486	100.00	1.50	0.450
270	10383	100.00	6.00	1.620
271	10376	100.00	8.00	2.160
272	10064	100.00	10.00	2.700
273	10045	100.00	12.00	3.240
274	10082	100.00	12.50	3.375
275	10055	100.00	15.00	4.050
276	10096	100.00	20.00	5.400
277	10147	100.00	25.00	6.750
278	10324	100.00	30.00	8.100
279	10186	100.00	50.00	13.500
280	10499	100.00	70.00	18.900
281	10158	100.00	80.00	21.600
282	10305	100.30	16.00	4.333
283	10028	101.60	6.35	1.742
284	10349	101.60	3.18	0.872

SL. No.	Section No.	A	B	Weight kg/m
285	10046	101.60	12.70	3.484
286	10215	101.60	22.22	6.095
287	10283	130.00	65.00	22.815
288	10407	132.00	19.00	6.771
289	10214	101.60	25.40	6.967
290	10469	101.60	32.00	8.778
291	10470	101.60	40.00	10.972
292	10262	101.60	50.80	13.935
293	10361	101.60	76.20	20.903
294	10304	102.00	36.00	9.914
295	10276	102.00	82.00	22.583
296	10424	103.00	7.40	2.058
297	10406	103.00	43.00	11.958
298	10309	103.00	53.00	14.739
299	10363	103.00	63.00	17.520
300	10310	103.50	6.80	1.899
301	10423	105.00	5.00	1.417
302	10043	105.00	15.00	4.253
303	10301	107.50	2.65	0.769
304	10090	110.00	12.00	3.564
305	10169	110.00	30.00	8.910
306	10235	112.00	60.00	18.144
307	10496	114.30	9.53	2.941
308	10239	115.00	3.30	1.025
309	10127	115.00	25.00	7.762
310	10257	115.00	60.00	18.630
311	10308	117.00	42.00	13.267
312	10374	118.00	31.00	9.876
313	10395	120.00	4.00	1.296
314	10393	120.00	6.00	1.944
315	10394	120.00	8.00	2.296
316	10051	120.00	10.00	3.240
317	10124	120.00	25.00	8.100
318	10444	120.00	69.00	22.356
319	10355	120.00	80.00	25.920
320	10402	120.00	95.00	30.780
321	10163	121.00	12.00	3.920
322	10299	122.00	12.70	4.183
323	10298	122.00	17.00	5.600
324	10271	122.00	38.10	12.550
325	10303	123.00	2.90	0.963
326	S4949	123.00	15.00	4.981
327	10445	125.00	6.00	2.025
328	10436	125.00	10.00	3.375
329	10498	125.00	20.00	6.750
330	10228	125.00	50.80	17.145
331	10213	127.00	3.00	1.028
332	10076	127.00	6.35	2.177
333	10041	127.00	9.52	3.264
334	10151	127.00	12.70	4.355
335	10488	127.00	15.88	5.445
336	10471	127.00	20.00	6.858
337	10472	127.00	25.40	8.709
338	10473	127.00	32.00	10.972
339	10474	127.00	40.00	13.716
340	10263	127.00	50.80	17.419
341	10159	127.00	76.20	26.129
342	10317	130.00	10.00	3.510
343	10172	130.00	13.00	4.563

BARS & RODS**FLAT BARS & HEXAGONAL BARS**

SL. No.	Section No.	A	B	Weight kg/m
344	10519	134.00	10.00	3.618
345	10230	135.00	44.45	16.202
346	10231	135.00	82.55	30.089
347	10416	136.00	4.00	1.468
348	10417	136.00	4.80	1.762
349	10337	136.00	6.50	2.386
350	10403	136.00	43.00	15.789
351	10420	137.00	4.60	1.701
352	10300	137.00	20.00	7.398
353	10132	140.00	10.00	3.780
354	10316	140.00	15.80	5.972
355	10442	140.00	16.50	6.237
356	10170	140.00	50.00	18.900
357	10492	140.00	57.00	21.546
358	10085	150.00	6.00	2.430
359	10128	150.00	7.50	3.037
360	10292	150.00	8.00	3.240
361	10066	150.00	10.00	4.050
362	10089	150.00	12.00	4.860
363	10294	150.00	16.00	6.480
364	10097	150.00	19.00	7.695
365	10174	150.00	20.00	8.100
366	10070	150.00	25.00	10.125
367	10134	150.00	30.00	12.150
368	10185	150.00	40.00	16.200
369	10249	150.00	45.00	18.225
370	10517	150.00	50.00	20.250
371	10284	150.00	75.00	30.375
372	10105	152.40	6.40	2.633
373	10179	152.40	12.70	5.225
374	10252	152.40	31.75	13.064
375	10264	152.40	50.80	20.903
376	10360	152.40	63.50	26.129
377	10451	152.40	101.60	41.806
378	10176	154.00	2.00	0.832
379	10522	154.00	12.60	5.239
380	10352	158.00	8.50	3.626
381	10443	158.00	16.00	6.825
382	10229	158.00	35.00	14.930
383	10401	159.00	3.00	1.288
384	10250	160.00	6.00	2.592
385	10418	160.00	6.40	2.764
386	10523	160.00	10.00	4.320
387	10247	160.00	18.00	7.776
388	10167	160.00	25.00	10.800
390	10525	160.00	45.00	19.440
391	10526	160.00	50.00	21.600
392	10240	160.00	55.00	23.800
393	10115	162.00	10.00	4.374
394	10238	165.00	14.00	6.236
395	S4951	165.00	15.00	6.682
396	10493	165.00	50.00	22.275
397	10297	167.00	22.00	9.920
398	10319	167.00	30.00	13.527
399	10320	167.00	68.00	30.661
400	10387	170.00	12.00	5.508
401	10221	170.00	32.00	14.688
402	10272	172.00	12.00	5.572

SL. No.	Section No.	A	B	Weight kg/m
403	10233	173.00	14.00	6.539
404	10398	175.00	3.00	1.417
405	10187	175.00	50.00	23.625
406	10210	175.00	52.00	24.570
407	10507	175.00	65.00	30.712
408	10501	177.00	16.00	7.646
409	10392	177.80	9.52	4.570
410	10254	178.00	10.50	5.045
411	10244	178.00	19.50	9.371
412	10484	180.00	15.00	7.290
413	10412	180.00	19.00	9.234
414	10182	180.00	40.00	19.440
415	10183	190.00	4.00	2.052
416	10209	190.00	50.00	25.650
417	10483	190.50	9.53	4.901
418	10313	195.00	30.00	15.795
419	10326	200.00	8.00	4.320
420	10255	200.00	10.00	5.400
421	10502	200.00	12.00	6.480
422	10180	200.00	13.00	7.020
423	10485	200.00	15.00	8.100
424	10341	200.00	25.00	13.500
425	10514	200.00	40.00	21.600
426	10266	203.20	12.70	6.967
427	10289	203.00	16.00	8.770
428	10224	204.00	5.00	2.754
429	10237	208.00	45.00	25.272
430	10333	210.00	12.00	6.804
431	10338	210.00	15.00	8.505
432	10495	220.00	8.00	4.752
433	10456	220.00	8.15	4.841
434	10381	220.00	16.00	9.504
435	10426	222.00	4.75	2.847
436	10425	222.00	5.90	3.536
437	10455	222.00	10.25	6.143
438	10521	227.00	91.00	55.774
439	10323	228.60	26.50	16.356
440	10400	229.00	19.00	11.747
441	10453	230.00	5.00	3.105
442	10371	230.00	6.00	3.726
443	10431	230.00	9.75	6.054
444	10440	230.00	112.00	69.552
445	10334	232.00	42.00	26.308
446	10491	235.00	152.00	96.444
447	10290	238.00	16.00	10.282
448	10508	240.00	90.00	58.320
449	10386	244.00	7.00	4.611
450	10433	245.00	5.25	3.473
451	10241	245.00	18.00	11.907
452	10330	246.00	20.00	13.284
453	10432	250.00	5.65	3.813
454	10457	250.00	6.25	4.218
455	10327	250.00	10.00	6.750
456	10481	250.00	12.00	8.100
457	10435	250.00	19.00	12.825
458	10354	250.00	100.00	67.500
459	10454	252.00	10.30	7.008
460	10346	254.00	12.70	8.709

SL. No.	Section No.	A	B	Weight kg/m
461	10385	254.00	25.40	17.419
462	10434	255.00	5.25	3.614
463	10447	255.00	6.25	4.303
464	10446	257.00	7.00	4.857
465	10430	258.00	6.80	4.737
466	10427	258.00	7.40	5.154
467	10429	258.00	7.40	5.154
468	10448	258.00	7.50	5.224
469	10449	258.00	9.00	6.269
470	10439	258.00	9.75	6.791
471	10460	258.00	10.00	6.966
472	10242	258.00	18.00	12.539
473	S4294	260.00	6.00	4.212
474	10428	262.00	8.00	5.659
475	10340	270.00	10.00	7.290
476	10357	285.00	16.00	12.312
477	10329	290.00	20.00	15.660
478	10384	300.00	25.00	20.250
479	10388	300.00	28.00	22.680
480	10322	304.80	26.50	21.808
481	10450	305.00	14.00	11.529
482	10509	305.00	16.00	13.176
483	10513	305.00	18.00	14.823
484	10342	312.00	8.00	6.739
485	10364	316.50	23.50	20.082
486	10314	320.00	20.00	17.280
487	10370	340.00	22.00	20.196
488	10378	350.00	22.50	21.262
489	10377	351.00	30.50	28.904
490	10512	425.00	8.20	9.409
491	10479	425.00	25.00	28.687

BARS & RODS

ROUND RODS

HEXAGONAL BARS

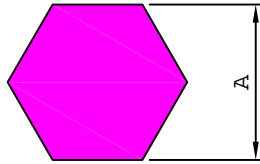

SL. No.	Section No.	A	Weight kg/m
1	11851	5.00	0.058
2	11892	5.90	0.081
3	11852	7.00	0.115
4	11871	8.00	0.150
5	11853	9.00	0.189
6	11854	9.52	0.212
7	11855	11.00	0.283
8	11872	12.00	0.337
9	11856	12.70	0.377
10	11881	13.00	0.395
11	11887	13.85	0.449
12	11857	14.00	0.458
13	11864	16.00	0.599
14	11876	16.85	0.664
15	11858	17.00	0.675
16	11870	18.00	0.758
17	11870	18.00	0.758
18	11874	18.85	0.831
19	11869	18.90	0.835
20	11866	19.10	0.853
21	11867	22.00	1.132
22	11878	22.10	1.142
23	11890	22.25	1.157
24	11873	23.85	1.330
25	11862	24.00	1.347
26	11859	25.00	1.461
27	11893	25.40	1.508
28	11875	26.85	1.686
29	11868	27.00	1.705
30	11889	27.15	1.723
31	11865	29.00	1.966
32	11891	30.19	2.131
33	11884	30.50	2.175
34	11860	32.00	2.394
35	11879	36.00	3.030
36	11886	37.50	3.288
37	11885	38.10	3.394
38	11880	41.00	3.930
39	11883	41.27	3.984
40	S4316	46.00	4.948
41	11863	50.00	5.846

ROUND RODS

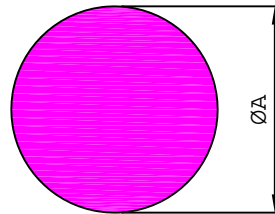

SL. No.	Section No.	ØA	Weight kg/m
1	11041	4.00	0.034
2	11042	5.00	0.053
3	11047	6.00	0.076
4	11001	6.35	0.086
5	11044	6.40	0.087
6	11139	7.00	0.104
7	11059	7.20	0.110
8	11081	7.65	0.124
9	11002	7.94	0.134
10	11029	8.00	0.136
11	11003	8.50	0.153
12	11184	8.76	0.163
13	11068	8.85	0.166
14	11185	8.97	0.171
15	11004	9.00	0.172
16	11186	9.08	0.175
17	11067	9.18	0.179
18	11187	9.21	0.180
19	11046	9.30	0.183
20	11188	9.40	0.187
21	11005	9.52	0.192
22	11189	9.53	0.193
23	11069	9.66	0.198
24	11190	9.67	0.198
25	11106	9.80	0.203
26	11191	9.92	0.209
27	11006	10.00	0.212
28	11192	10.63	0.240
29	11070	10.80	0.247
30	11007	11.00	0.257
31	11193	11.13	0.263
32	11128	11.20	0.266
33	11194	11.35	0.273
34	11071	11.53	0.282
35	11195	11.60	0.285
36	11082	11.70	0.290
37	11008	12.00	0.305
38	11009	12.70	0.342
39	11010	13.00	0.358
40	11011	13.50	0.386
41	11116	14.00	0.416
42	11022	14.30	0.434
43	11012	14.50	0.446
44	11085	15.00	0.477

SL. No.	Section No.	ØA	Weight kg/m
45	11066	15.30	0.496
46	11083	15.60	0.516
47	11129	15.70	0.523
48	11013	15.88	0.535
49	11025	16.00	0.543
50	11133	16.25	0.560
51	11079	16.70	0.591
52	11135	17.00	0.613
53	11026	17.50	0.649
54	11206	17.70	0.664
55	11023	18.00	0.687
56	11096	18.30	0.710
57	11113	19.00	0.765
58	11014	19.05	0.770
59	11168	19.70	0.823
60	11033	20.00	0.848
61	11015	21.00	0.935
62	11130	21.50	0.980
63	11030	22.00	1.027
64	11021	22.20	1.045
65	11117	23.00	1.122
66	11112	24.00	1.221
67	11107	24.50	1.272
68	11034	25.00	1.325
69	11016	25.40	1.368
70	11137	25.50	1.379
71	11024	25.80	1.412
72	11040	26.30	1.467
73	11036	27.00	1.546
74	11165	27.80	1.639
75	11031	28.00	1.662
76	11091	28.57	1.731
77	11035	30.00	1.908
78	11150	30.40	1.960
79	11132	30.90	2.025
80	11027	31.80	2.144
81	11028	32.00	2.171
82	11198	32.00	2.171
83	11199	32.00	2.171
84	11162	32.40	2.226
85	11077	33.00	2.309
86	11173	33.50	2.380
87	11045	34.92	2.585
88	11103	35.60	2.688
89	11084	36.00	2.748
90	11174	36.70	2.856
91	11147	37.50	2.982
92	11032	38.00	3.062
93	11017	38.10	3.078
94	11167	38.50	3.143
95	11065	39.00	3.225
96	11202	39.70	3.342
97	11018	40.00	3.393

BARS & RODS**ROUND RODS**

SL. No.	Section No.	ØA	Weight kg/m
98	11149	40.90	3.547
99	11048	42.00	3.741
100	11175	42.86	3.895
101	11020	43.00	3.920
102	11037	44.45	4.190
103	11056	44.70	4.237
104	11086	45.00	4.294
105	11172	45.50	4.390
106	11136	48.10	4.906
107	11180	48.50	4.988
108	S4976	48.50	4.988
109	11019	50.00	5.301
110	11038	50.80	5.472
111	11049	51.75	5.679
112	11057	53.50	6.070
113	11169	53.98	6.179
114	11205	54.00	6.184
115	11073	55.00	6.415
116	11060	56.00	6.650
117	11090	57.15	6.926
118	11076	60.00	7.634
119	11164	60.32	7.716
120	11114	62.60	8.310
121	11050	63.50	8.550
122	11088	65.00	8.959
123	11126	65.40	9.070
124	11151	66.68	9.429
125	11111	68.20	9.863
126	11102	68.30	9.892
127	11118	69.20	10.155
128	11119	69.40	10.213
129	11087	70.00	10.390
130	11063	71.00	10.690
131	11105	72.00	10.993
132	11166	73.00	11.301
133	11204	73.66	11.506
134	11094	75.00	11.928
135	11051	76.20	12.312
136	11120	79.40	13.369
137	11061	80.00	13.571
138	S4411	81.00	13.913
139	11115	82.55	14.450
140	11092	85.00	15.321
141	11122	88.90	16.759
142	11062	90.00	17.176
143	11163	91.00	17.560
144	11123	95.25	19.239
145	11176	97.00	19.952
146	11080	100.00	21.206
147	11052	101.60	21.890
148	11148	105.00	23.379
149	11093	107.95	24.711
150	11074	110.00	25.659

SL. No.	Section No.	ØA	Weight kg/m
151	11183	110.60	25.940
152	11181	111.40	26.316
153	11141	114.30	27.704
154	11095	115.00	28.045
155	S4387	117.00	29.029
156	11207	118.00	29.527
157	11039	120.00	30.536
158	11124	120.65	30.868
159	11055	125.00	33.134
160	11127	127.00	34.203
161	11089	130.00	35.838
162	11152	133.35	37.709
163	11099	135.00	38.647
164	11178	139.50	41.267
165	11075	140.00	41.563
166	11104	143.00	43.364
167	11208	145.00	44.585
168	11101	146.00	45.202
169	11196	146.00	45.202
170	11064	150.00	47.713
171	11179	151.50	48.672
172	11197	151.60	48.736
173	11125	152.40	49.252
174	11097	153.00	49.640
175	11143	155.00	50.947
176	11182	156.00	51.606
177	11144	160.00	54.287
178	11078	162.00	55.652
179	11109	165.00	57.732
180	11100	170.00	61.285
181	11153	171.45	62.335
182	11134	175.00	64.942
183	11154	177.80	67.037
184	11058	180.00	68.706
185	11155	184.15	71.911
186	11098	190.00	76.552
187	11140	190.50	76.956
188	11108	200.00	84.823
189	11131	203.00	87.387
190	11159	203.20	87.559
191	11142	208.00	91.745
192	11138	211.00	94.410
193	11156	215.90	98.846
194	11171	220.00	102.636
195	11160	228.60	110.817
196	11145	230.00	112.178
197	11161	241.30	123.472
198	11203	245.00	127.288
199	11201	250.00	132.536
200	11146	254.00	136.811
201	11157	260.35	143.737
202	11177	264.00	147.796
203	11200	268.00	152.308

204	11158	279.40	165.541
205	11170	281.94	168.565

BARS & RODS

ROUND RODS

SQUARE BARS

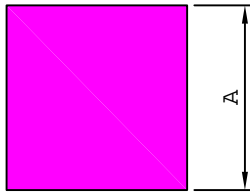

46	11730	130.00	45.630
----	-------	--------	--------

SL. No.	Section No.	ØA	Weight kg/m
1	11723	5.00	0.068
2	11701	6.35	0.109
3	11702	7.93	0.170
4	11709	8.00	0.173
5	11703	9.53	0.245
6	11704	10.00	0.270
7	11722	12.00	0.389
8	11705	12.70	0.435
9	11711	15.00	0.608
10	11706	15.88	0.681
11	11735	17.00	0.780
12	11707	19.05	0.980
13	11708	20.00	1.080
14	11710	25.00	1.688
15	11719	25.50	1.756
16	11726	30.00	2.430
17	11716	31.75	2.722
18	11721	32.00	2.765
19	11732	35.00	3.308
20	11713	38.10	3.920
21	11717	40.00	4.320
22	11744	42.00	4.762
23	11740	44.45	5.334
24	11725	45.00	5.467
25	11714	50.00	6.750
26	11733	50.80	6.967
27	11743	54.00	7.873
28	11727	60.00	9.720
29	11724	63.00	10.716
30	11739	63.50	10.887
31	11746	65.00	11.407
32	11741	67.00	12.120
33	11712	69.85	13.173
34	11736	72.00	13.996
35	11718	76.25	15.698
36	11745	79.00	16.850
37	11720	80.00	17.280
38	11734	83.00	18.600
39	11742	88.90	21.338
40	11747	100.00	27.000
41	11738	101.00	27.542
42	11715	101.60	27.870
43	11728	110.00	32.670
44	11729	120.00	38.880
45	11737	124.00	41.515

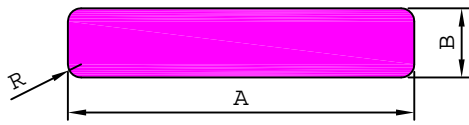
BARS & RODS**MISCELLANEOUS BARS**

SL. No.	Section No.	A	B	R	Weight kg/m
1	12163	17.90	14.90	2.25	0.708
2	12280	28.00	9.00	1.50	0.675
3	12180	30.00	16.00	1.00	1.294
4	12258	40.00	10.00	0.80	1.079
5	12134	40.00	10.00	3.00	1.059
6	12279	40.00	11.00	1.50	1.183
7	12147	40.00	26.00	3.00	2.787
8	12086	50.00	8.00	3.00	1.059
9	12217	50.00	8.00	3.00	1.059
10	12135	50.00	10.00	3.00	1.329
11	12096	50.00	12.00	3.00	1.599
12	12186	50.05	8.00	3.00	1.060
13	12278	55.00	15.00	2.00	2.218
14	S4708	60.00	8.00	1.00	1.294
15	12128	60.00	10.00	1.00	1.618
16	12136	60.00	10.00	3.00	1.559
17	12092	65.00	8.00	3.00	1.383
18	12215	65.00	8.00	3.00	1.383
19	12185	65.05	8.00	3.00	1.383
20	12243	75.00	10.00	3.00	2.004
21	12023	80.00	10.00	3.00	2.138
22	12265	80.00	40.00	0.60	8.639
23	12200	88.90	50.80	1.00	12.191
24	12201	88.90	63.50	1.00	15.240
25	12131	90.00	75.00	0.50	18.225
26	12137	100.00	10.00	3.00	2.679
27	12114	100.00	12.00	3.00	3.219
28	12069	101.60	9.52	1.50	2.606
29	12199	101.60	15.88	1.00	4.354
30	12206	101.60	44.45	1.00	12.191
31	12250	110.50	12.00	1.00	3.578
32	12212	110.50	77.00	1.00	22.971
33	12202	114.30	88.90	1.00	27.433
34	12165	115.00	79.00	1.00	24.527
35	12172	116.00	88.00	1.00	27.559
36	12141	120.00	10.00	3.00	3.219
37	12113	120.00	12.00	3.00	3.867
38	12115	120.00	16.00	3.00	5.163
39	12105	120.00	45.00	1.00	14.578
40	12080	120.00	100.00	2.00	32.391
41	12203	127.00	101.60	1.20	34.835
42	12124	130.00	17.00	1.00	5.965
43	12091	130.00	100.00	1.00	35.098
44	12138	140.00	10.00	3.00	3.759
45	12159	140.00	35.00	1.00	13.228
46	12263	140.00	40.00	1.00	15.118
47	12262	140.00	90.00	1.00	34.018
48	12145	140.00	110.00	1.00	41.578

SL. No.	Section No.	A	B	R	Weight kg/m
49	12221	144.00	74.00	2.00	28.762
50	12133	145.00	4.80	1.00	1.877
51	12252	145.00	27.00	1.00	10.568
52	12251	145.00	68.00	1.00	26.620
53	12170	148.00	93.00	1.00	37.160
54	12224	150.00	22.00	1.00	8.908
55	12230	150.00	100.00	1.00	40.498
56	12219	151.00	7.80	2.00	3.171
57	12104	151.00	111.00	2.00	45.245
58	12253	152.00	16.00	1.00	6.564
59	12127	152.00	80.00	1.00	32.830
60	12205	152.40	76.20	1.00	31.352
61	12232	155.00	13.00	1.00	5.438
62	12130	155.00	58.00	1.00	24.271
63	12098	160.00	10.00	3.00	4.299
64	12168	160.00	85.00	1.00	36.718
65	12126	160.00	90.00	1.00	38.878
66	12255	160.00	115.00	1.00	49.678
67	12179	161.00	40.00	1.00	17.386
68	12171	163.00	39.00	1.00	17.162
69	12260	165.00	6.35	3.00	2.808
70	12264	165.00	55.00	1.00	24.500
71	12055	165.00	85.00	2.00	37.858
72	12160	165.00	120.00	1.00	53.458
73	12140	168.00	133.00	1.00	60.326
74	12132	169.00	4.80	1.00	2.188
75	S5203	169.00	7.80	2.00	3.550
76	12112	169.00	47.00	1.00	21.444
77	12169	170.00	77.00	1.00	35.341
78	12259	170.00	80.00	2.00	36.711
79	12109	180.00	10.00	3.00	4.839
80	12242	180.00	30.00	2.00	14.571
81	12241	180.00	63.00	1.00	30.616
82	12071	185.00	15.00	1.00	7.490
83	12283	200.00	6.00	0.70	3.239
84	12139	200.00	10.00	3.00	5.379
85	12268	200.00	20.00	0.50	10.799
86	12065	200.00	20.00	1.00	10.800
87	12285	200.00	22.00	1.00	11.878
88	12118	200.00	32.00	1.00	17.278
89	12226	200.00	55.00	2.00	29.691
90	12190	203.00	52.00	1.00	28.499
91	12191	203.00	62.00	1.00	33.980
92	12087	203.20	9.52	3.00	5.202
93	12284	203.20	101.60	1.00	55.740
94	12207	204.00	26.00	2.00	14.312
95	12070	205.00	15.00	1.00	8.300
96	12204	208.00	12.70	1.00	7.130
97	12083	212.00	38.00	2.00	21.742
98	12177	215.00	76.20	1.00	44.232
99	12173	220.00	12.30	2.00	7.297
100	12078	222.00	32.00	1.50	19.176
101	12103	223.00	18.00	1.00	10.835

BARS & RODS

MISCELLANEOUS BARS

SL. No.	Section No.	A	B	R	Weight kg/m
102	12129	225.00	17.50	3.00	10.610
103	12213	225.00	50.00	2.00	30.366
104	S4668	230.00	65.00	1.00	40.363
105	12074	233.00	17.00	1.00	10.692
106	12084	250.00	18.00	1.50	12.145
107	12054	250.00	30.00	2.50	20.236
108	12167	254.00	21.50	1.00	14.742
109	12266	254.00	50.80	0.60	34.838
110	12097	255.00	17.50	1.50	12.044
111	12063	255.00	23.00	1.00	15.833
112	12090	256.00	4.82	2.00	3.322
113	12088	256.00	9.52	2.00	6.571
114	12188	260.00	22.00	2.00	15.435
115	12081	260.00	23.00	2.00	16.137
116	12110	265.00	18.00	2.00	12.879
117	12235	267.00	22.00	2.00	15.851
118	S4980	268.00	18.00	3.00	13.004
119	12196	270.00	22.00	4.00	16.001
120	12064	276.00	23.00	2.00	17.130
121	12082	284.00	18.00	2.00	13.793
122	12085	285.00	23.00	2.00	17.699
123	12195	290.00	29.00	4.00	22.670
124	12236	292.00	23.00	4.00	18.096
125	12222	300.00	36.00	1.00	29.158
126	12056	305.00	6.00	1.00	4.939
127	12057	305.00	8.00	1.00	6.586
128	12197	305.00	20.00	1.00	16.468
129	12267	380.00	10.00	1.00	10.258
130	12218	425.00	5.00	1.00	5.735
131	12244	426.00	30.00	6.00	34.423

FLAT BAR WITH FULL RADIUS

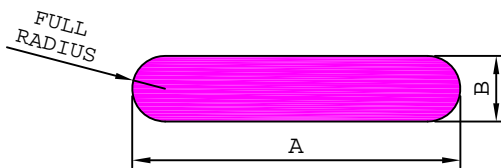

SL. No.	Section No.	A	B	Weight kg/m
1	12030	25.20	6.30	0.405
2	12209	30.00	13.00	0.955
3	12261	32.00	9.00	0.731
4	S4408	40.00	6.00	0.627
5	12039	40.00	10.00	1.022
6	12231	40.00	15.00	1.490
7	12269	50.00	5.00	0.661
8	12117	50.00	6.00	0.789
9	12001	50.00	10.00	1.292
10	12111	50.00	12.00	1.537
11	12046	50.40	6.30	0.834
12	S5105	51.00	25.60	3.145
13	S4344	55.00	25.60	3.422
14	12229	60.00	5.00	0.796
15	12245	60.00	6.00	0.951
16	12075	60.00	6.20	0.982
17	12270	60.00	8.00	1.259
18	12198	61.00	7.50	1.203
19	12041	63.50	6.35	1.065
20	12116	75.00	6.00	1.194
21	12150	76.20	9.52	1.906
22	12234	80.00	3.00	0.643
23	12271	80.00	8.00	1.691
24	12100	100.00	6.00	1.599
25	12246	100.00	6.00	1.599
26	12272	100.00	8.00	2.123
27	12144	100.00	12.00	3.157
28	12050	101.60	6.35	1.720
29	12238	120.00	3.00	0.967
30	12237	120.00	5.00	1.606
31	12211	120.00	6.00	1.923
32	12273	120.00	8.00	2.555
33	12274	120.00	12.00	3.805
34	12227	140.00	6.00	2.247
35	12102	150.00	6.00	2.409
36	12193	150.00	10.00	3.992
37	12042	152.40	6.35	2.590
38	12275	160.00	10.00	4.262
39	12276	160.00	14.00	5.934
40	12239	175.00	6.00	2.814
41	12228	185.00	6.00	2.976
42	S5225	200.00	10.00	5.342
43	12068	200.00	12.00	6.397
44	12208	240.00	6.00	3.867
45	12216	240.00	6.00	3.867
46	12192	300.00	10.00	8.042

BARS & RODS

MISCELLANEOUS BARS

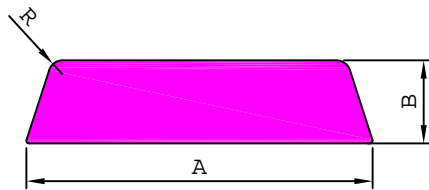

SL. No.	Section No.	A	B	R1	Weight kg/m
1	12120	50.00	12.00	2.00	1.501
2	12121	50.00	12.00	8.00	1.469
3	12122	40.00	8.00	2.00	0.812

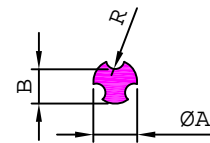

SL. No.	Section No.	A	B	R	Weight kg/m
1	12049	5.60	4.55	1.25	0.052
2	12024	5.80	4.30	1.50	0.045
3	12004	6.00	4.75	1.25	0.057
4	12021	6.00	4.50	1.20	0.053

SQUARE BARS WITH RADIUS

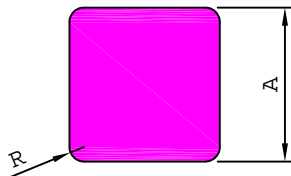

SL. No.	Section No.	A	R	Weight kg/m
1	12282	10.00	1.20	0.267
2	12233	85.00	1.00	19.505
3	12142	90.00	3.00	21.849
4	12161	127.00	1.00	43.546
5	12019	140.00	3.00	52.898
6	12175	152.40	1.50	62.704
7	12240	155.00	1.20	64.864
8	12162	165.10	1.00	73.594
9	12220	175.00	1.20	82.684
10	12254	178.60	1.50	86.119

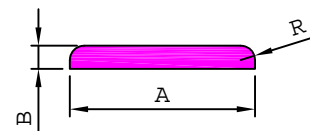

SL. No.	Section No.	A	B	R	Weight kg/m
1	12010	25.40	3.18	1.98	0.213
2	12089	25.00	2.95	2.00	0.194

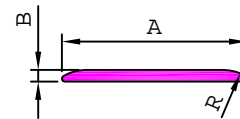

SL. No.	Section No.	A	B	R	Weight kg/m
1	12016	25.40	1.60	6.00	0.104
2	12017	25.40	1.88	6.00	0.120
3	12095	24.75	1.17	1.00	0.077

BARS & RODS

MISCELLANEOUS BARS

<p>12002 0.403 kg/m</p>	<p>12006 0.483 kg/m</p>	<p>12007 0.584 kg/m</p>
<p>12008 0.801 kg/m</p>	<p>12009 0.399 kg/m</p>	<p>12011 0.040 kg/m</p>
<p>12026 0.197 kg/m</p>	<p>12047 2.009 kg/m</p>	<p>12093 0.381 kg/m</p>
<p>12106 0.424 kg/m</p>	<p>12107 0.495 kg/m</p>	<p>12149 1.120 kg/m</p>
<p>12151 0.267 kg/m</p>	<p>12152 0.811 kg/m</p>	<p>12154 0.116 kg/m</p>
<p>12155 0.066 kg/m</p>	<p>12156 0.035 kg/m</p>	<p>12166 1.271 kg/m</p>

BARS & RODS

MISCELLANEOUS BARS

12153

6.610 kg/m

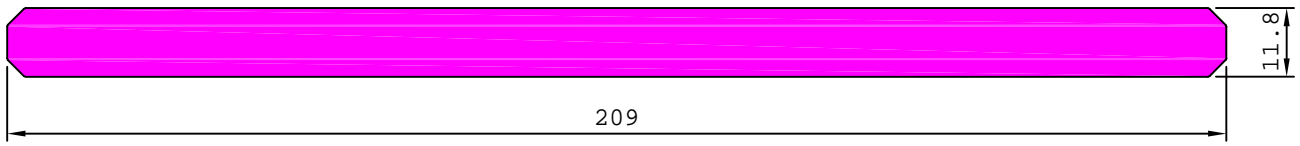

12158

2.191 kg/m

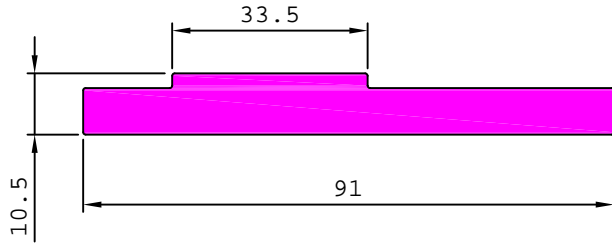

12174

2.311 kg/m

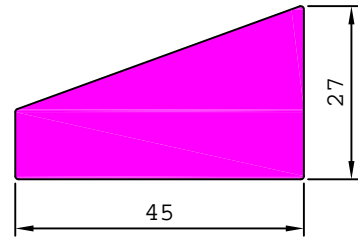

12176

0.191 kg/m

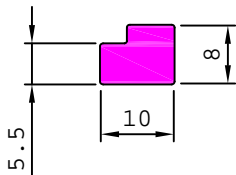

12178

2.089 kg/m

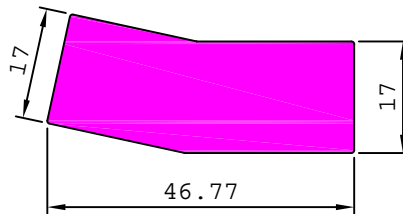

12181

0.161 kg/m

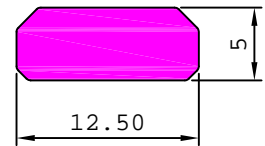

12184

2.505 kg/m

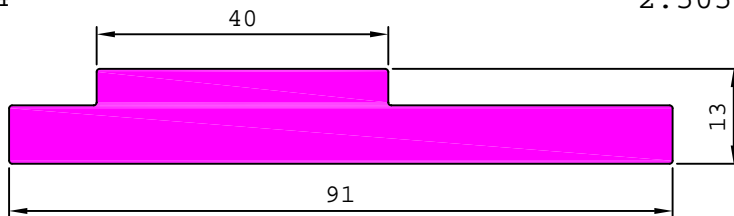

12189

0.144 kg/m

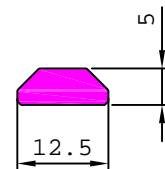

12194

0.168 kg/m

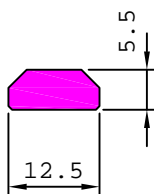

12094

0.196 kg/m

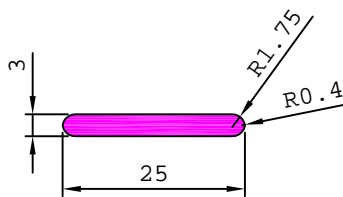

12223

0.115 kg/m

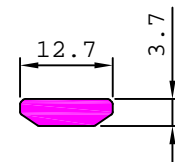

12214

10.435 kg/m

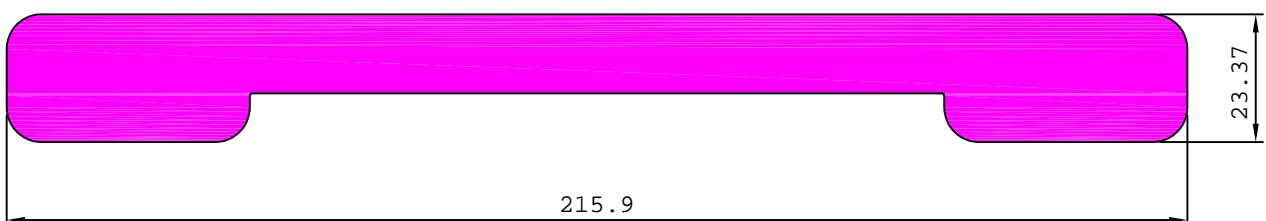

BARS & RODS

MISCELLANEOUS BARS

12225 0.253 kg/m

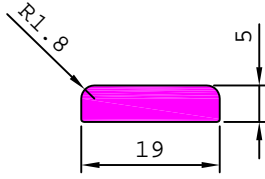

12247 0.031 kg/m

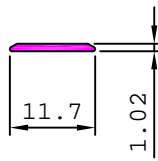

12248 0.068 kg/m

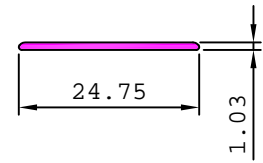

12249 0.093 kg/m

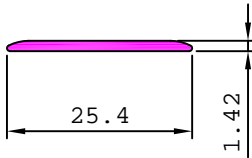

S4164 0.063 kg/m

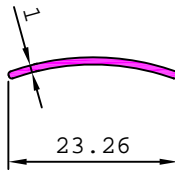

S5165 0.044 kg/m

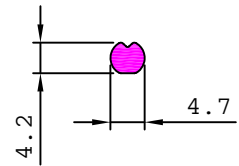

12256 19.570 kg/m

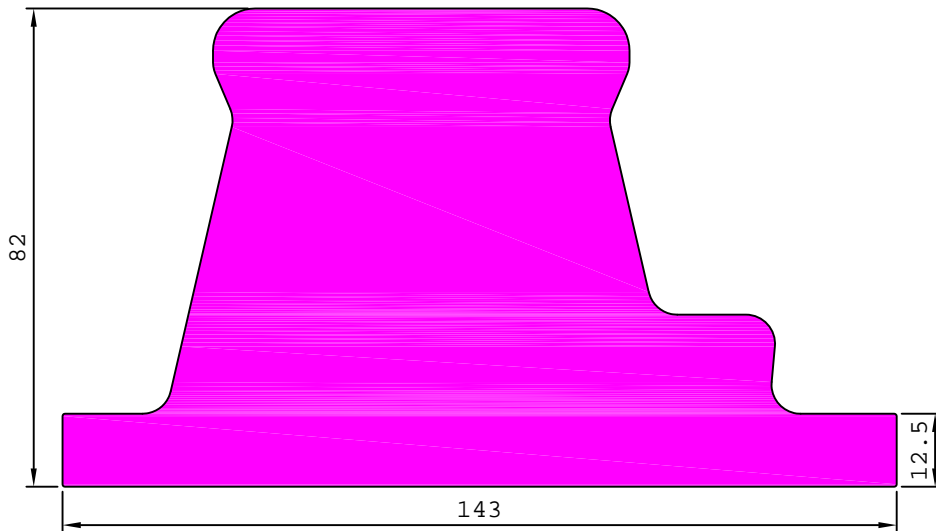

12277 0.266 kg/m

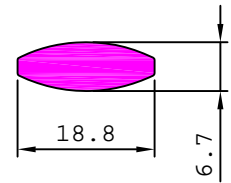

28924 0.116 kg/m

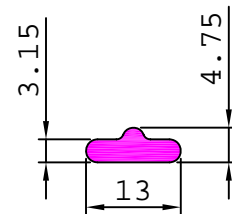

12257 21.016 kg/m

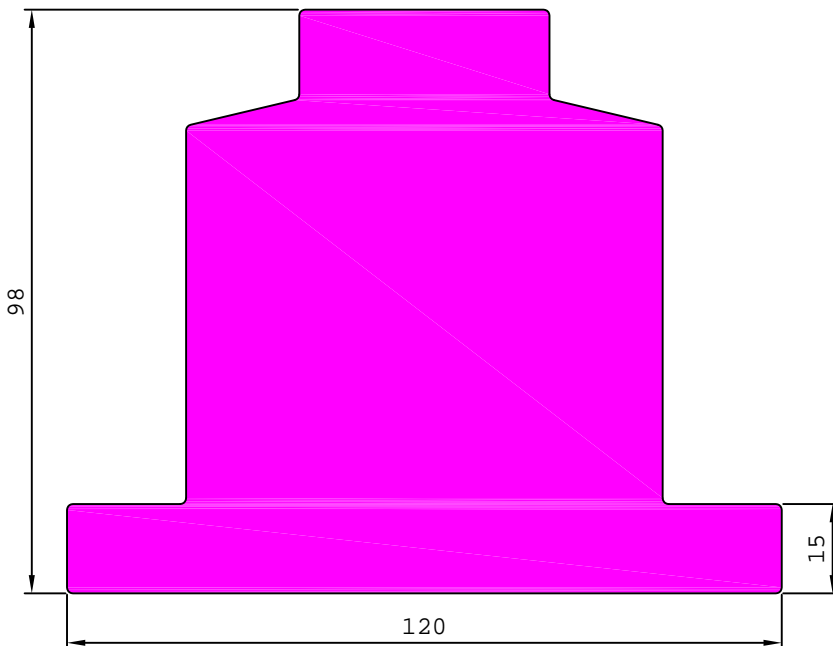

29006 0.117 kg/m

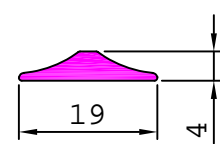

29007 0.149 kg/m

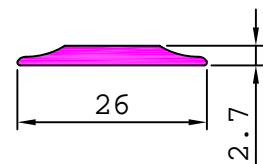

29008 0.110 kg/m

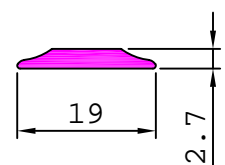

BARS & RODS

MISCELLANEOUS BARS

12281 18.652 kg/m

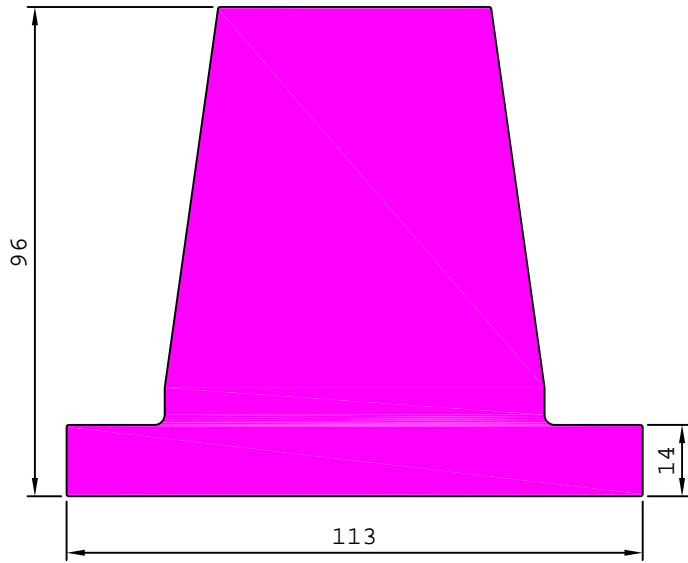

27974 3.347 kg/m

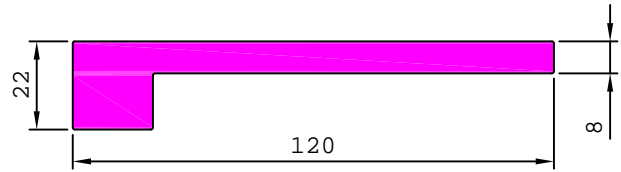

28931 6.312 kg/m

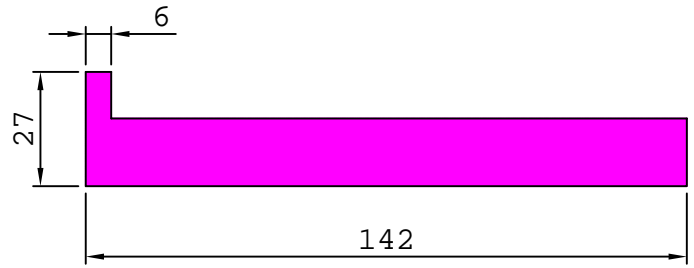

27946 15.700 kg/m

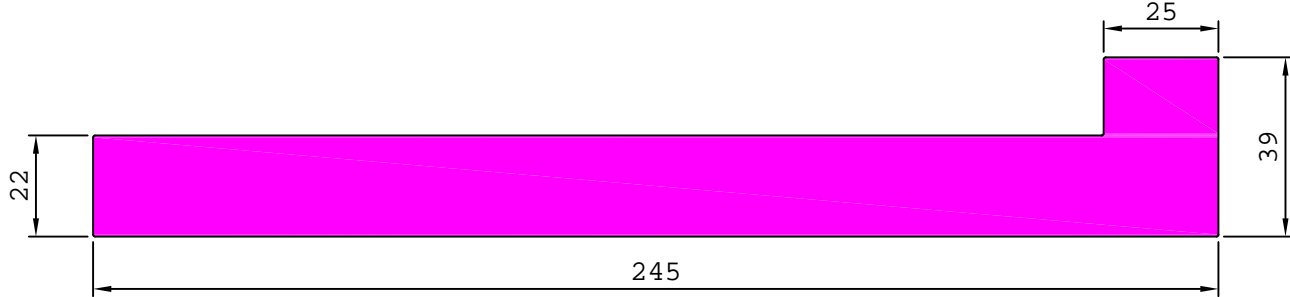

29065 3.022 kg/m

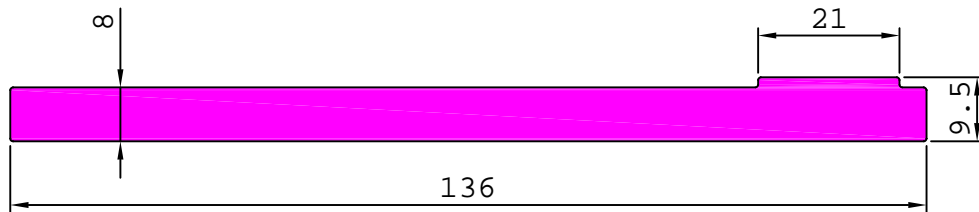

S4238 1.228 kg/m

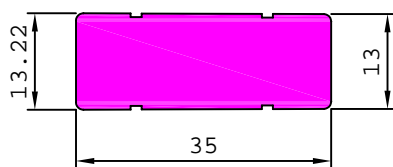

S4264 0.149 kg/m

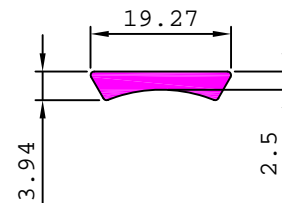

S4282 0.720 kg/m

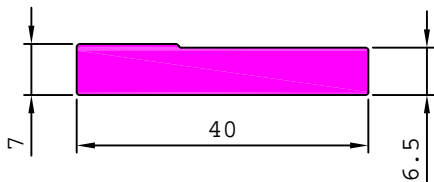

S4329 0.139 kg/m

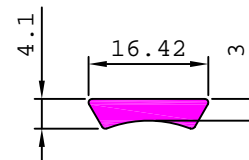

BARS & RODS

MISCELLANEOUS BARS

S4547

41.431 kg/m

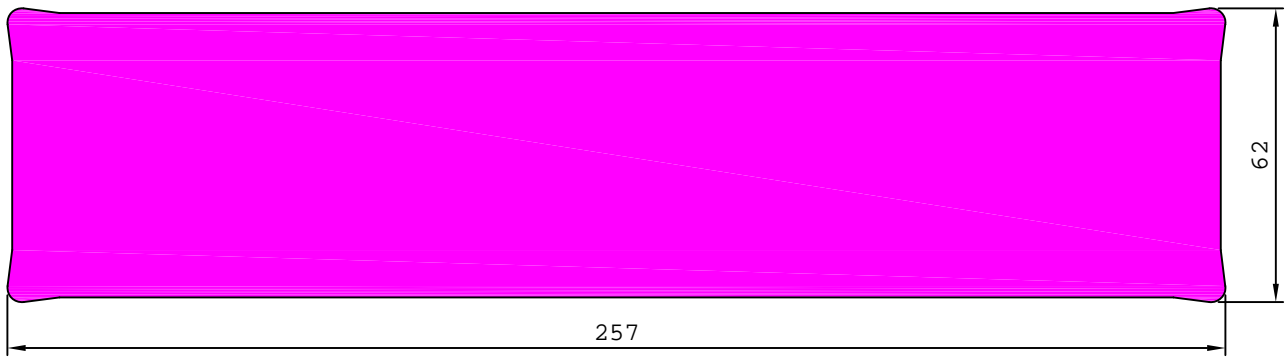

S4836

43.465 kg/m

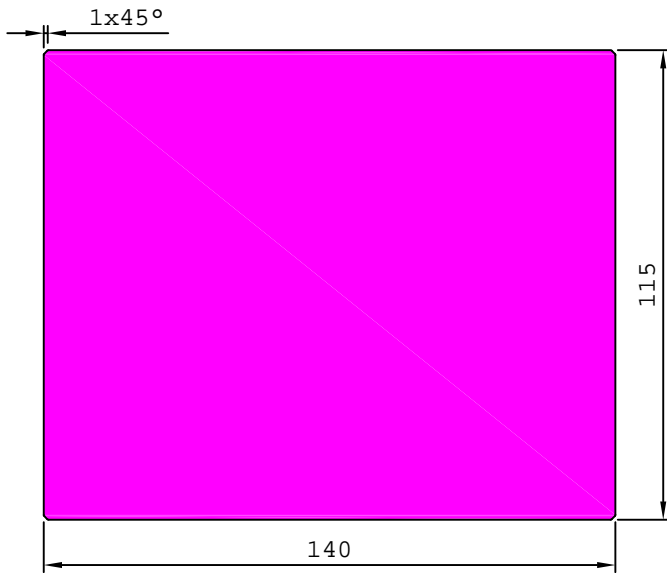

S5056

22.708 kg/m

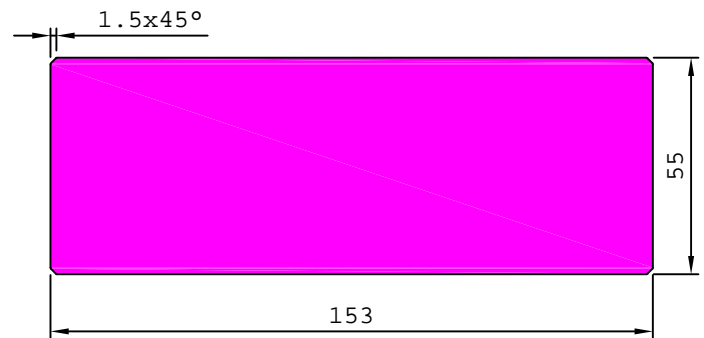

TUBES**ROUND TUBES, IRRIGATION TUBES & SQUARE TUBES**

SL. No.	Section No.	ØA	B	Weight kg/m
521	13534	146.00	17.50	19.075
522	13426	147.00	4.50	5.439
523	13361	150.00	2.00	2.511
524	13509	150.00	5.00	6.150
525	13644	150.00	6.50	7.912
526	13501	150.00	13.60	15.735
527	13476	152.00	10.00	12.045
528	13400	152.00	31.00	31.817
529	13499	153.00	22.50	24.906
530	13484	153.50	13.25	15.763
531	13547	153.60	44.00	40.905
532	13406	154.00	4.00	5.089
533	13563	154.00	5.00	6.319
534	13522	155.00	2.50	3.234
535	13373	155.00	16.00	18.865
536	13663	155.00	30.50	32.209
537	13594	156.00	8.00	10.043
538	13456	156.00	29.50	31.654
539	13543	158.00	4.00	5.225
540	13246	159.00	4.50	5.897
541	13123	160.00	5.50	7.208
542	13440	160.00	5.50	7.208
543	13428	160.00	6.00	7.838
544	13402	160.00	8.00	10.314
545	13511	160.00	13.00	16.210
546	13559	160.00	25.50	29.092
547	13529	160.00	35.00	37.110
548	13528	160.40	4.00	5.307
549	13249	162.00	11.00	14.089
550	13538	165.00	4.50	6.126
551	13474	165.00	44.50	45.484
552	13351	168.00	4.50	6.240
553	13415	168.00	7.50	10.210
554	13648	168.00	9.00	12.138
555	13518	168.00	25.00	30.324
556	13660	168.30	3.50	4.893
557	13502	168.30	10.97	14.640
558	13544	169.00	4.50	6.279
559	13550	170.00	5.00	6.998
560	13650	170.00	8.00	10.993
561	S4268	170.00	8.50	11.644
562	13290	172.00	10.00	13.741
563	13287	172.00	17.00	22.350
564	13537	173.00	19.00	24.819
565	13285	173.00	24.00	30.333
566	13161	173.80	6.40	9.087
567	13425	175.00	15.00	20.358
568	13573	175.00	22.50	29.105
569	13289	177.80	12.70	17.785
570	13516	178.00	20.50	27.387
571	13433	180.00	6.50	9.566
572	13275	180.00	15.00	20.993
573	13352	184.00	4.50	6.851
574	13356	184.50	6.00	9.084
575	13535	185.00	11.00	16.235
576	13247	190.00	5.00	7.846
577	13560	190.00	9.00	13.818
578	13627	192.00	42.50	53.894
579	13503	195.00	13.50	20.784

SL. No.	Section No.	ØA	B	Weight kg/m
580	13350	195.00	17.50	26.348
581	S4348	195.00	20.00	29.688
582	13629	195.00	23.00	33.556
583	13354	195.00	25.00	36.050
584	13452	195.00	29.50	41.413
585	13353	200.00	4.50	7.462
586	13631	200.00	5.00	8.270
587	S4515	200.00	6.00	9.873
588	13403	200.00	8.00	13.029
589	13622	200.00	10.00	16.116
590	13497	202.00	9.53	15.559
591	13472	202.00	18.50	28.795
592	13623	203.20	6.35	10.603
593	13539	205.00	5.00	8.482
594	13280	205.00	27.00	40.765
595	13418	206.00	8.50	14.240
596	13464	207.00	28.50	43.152
597	13545	210.00	5.00	8.694
598	13557	210.00	5.00	8.694
599	13513	210.00	15.00	24.811
600	13575	219.30	4.20	7.663
601	13519	220.00	6.50	11.771
602	13590	220.00	8.00	14.386
603	13580	220.00	9.50	16.962
604	13642	220.00	10.00	17.813
605	13532	220.00	17.50	30.059
606	13619	224.00	11.00	19.874
607	13478	225.00	5.00	9.331
608	13434	225.00	6.50	12.047
609	13572	225.00	20.00	34.777
610	13475	226.00	11.00	20.061
611	13656	226.00	42.00	65.551
612	13596	227.00	12.50	22.743
613	13551	230.00	5.00	9.543
614	13636	230.00	25.00	43.472
615	13635	230.00	28.00	47.976
616	S4336	230.00	13.00	23.929
617	13568	234.00	27.00	47.408
618	13410	235.00	8.00	15.404
619	13463	242.00	19.50	36.803
620	13574	245.00	35.00	62.345
621	13651	246.00	30.00	54.965
622	13482	250.00	5.00	10.391
623	S4516	250.00	8.00	16.422
624	S4163	252.00	11.00	22.487
625	13473	252.00	17.00	33.887
626	13555	252.00	17.00	33.887
627	13546	260.00	5.00	10.815
628	13558	270.00	5.00	11.239
629	13514	270.00	14.00	30.401
630	13431	271.00	8.00	17.847
631	S4403	275.00	5.00	11.451
632	13435	275.00	7.50	17.018
633	13634	282.00	8.50	19.719
634	13554	290.00	5.00	12.087

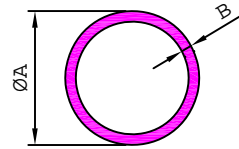
IRRIGATION TUBES

SL. No.	Section No.	ØA	B	Weight kg/m
1	13981	50.80	1.27	0.534
2	13982	76.20	1.27	0.807
3	13983	101.60	1.27	1.080
4	13984	127.00	1.32	1.407
5	13985	152.40	1.47	1.882
6	13986	203.20	1.92	3.278

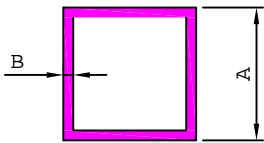
TUBES**ROUND TUBES, IRRIGATION TUBES & SQUARE TUBES****SQUARE TUBES**

SL. No.	Section No.	A	B	Weight kg/m
1	14490	11.00	0.60	0.067
2	14519	12.00	0.55	0.068
3	14481	12.00	0.64	0.078
4	14527	12.20	1.20	0.143
5	14485	12.70	0.81	0.104
6	14451	12.70	1.22	0.151
7	14452	12.70	1.63	0.195
8	14502	15.88	1.27	0.200
9	14491	16.00	1.00	0.162
10	14478	17.00	0.62	0.109
11	14474	17.50	1.44	0.245
12	14472	18.00	1.22	0.221
13	14531	18.00	2.00	0.345
14	14512	18.15	0.64	0.121
15	14486	18.50	0.69	0.133
16	14496	18.50	0.90	0.171
17	14544	19.00	3.00	0.518
18	14482	19.05	1.13	0.219
19	14453	19.05	1.22	0.235
20	14542	19.05	1.57	0.296
21	14454	19.05	1.63	0.307
22	14521	20.00	1.50	0.299
23	14509	20.00	1.70	0.335
24	14536	20.00	3.25	0.588
25	14532	22.50	0.52	0.123
26	14483	22.50	0.55	0.130
27	14479	22.50	0.63	0.148
28	14487	23.00	0.76	0.182
29	14477	23.50	0.87	0.212
30	14469	23.50	1.02	0.247
31	14520	24.50	0.67	0.172
32	14470	25.00	1.50	0.381
33	14504	25.00	1.80	0.451
34	14516	25.00	2.80	0.671
35	14476	25.40	0.82	0.219
36	14541	25.40	0.91	0.241
37	14466	25.40	1.25	0.326
38	14455	25.40	1.63	0.418
39	14456	25.40	2.00	0.505
40	14465	25.40	2.41	0.598
41	14505	30.00	1.80	0.548
42	14497	30.00	3.00	0.874
43	14467	31.75	1.25	0.412
44	14457	31.75	1.63	0.530
45	14458	31.75	2.00	0.643
46	14540	32.00	0.58	0.197
47	14529	32.00	1.70	0.556
48	14475	32.00	2.60	0.825
49	S4433	34.00	1.50	0.504
50	14488	35.00	0.93	0.342

SL. No.	Section No.	A	B	Weight kg/m
51	14513	35.00	2.00	0.712
52	14539	36.00	0.70	0.267
53	14535	37.35	4.70	1.657
54	14524	37.50	0.80	0.317
55	14468	38.10	1.25	0.497
56	14511	38.10	1.37	0.547
57	14459	38.10	1.63	0.642
58	14460	38.10	2.13	0.827
59	14461	38.10	2.41	0.929
60	14533	38.10	5.00	1.787
61	14534	38.10	6.35	2.177
62	14518	40.00	0.80	0.339
63	14506	40.00	1.80	0.743
64	14480	40.00	3.00	1.198
65	14514	40.00	2.85	1.143
66	14522	44.45	2.00	0.917
67	14473	44.46	3.20	1.426
68	14471	50.00	1.18	0.621
69	14525	50.00	1.50	0.785
70	14510	50.00	1.70	0.887
71	14462	50.00	2.00	1.037
72	14515	50.00	2.30	1.185
73	14503	50.00	2.70	1.379
74	S4767	50.00	3.00	1.523
75	14463	50.80	2.40	1.254
76	14464	50.80	3.05	1.573
77	14543	50.80	3.18	1.635
78	14498	60.00	4.00	2.419
79	14500	62.00	3.80	2.388
80	14489	62.00	5.00	3.078
81	14492	63.50	2.38	1.571
82	14507	75.00	2.70	2.108
83	14526	75.00	3.20	2.481
84	14538	76.00	4.76	3.662
85	14493	76.20	2.38	1.897
86	14494	87.00	3.80	3.415
87	14484	87.00	4.00	3.586
88	14495	87.00	5.00	4.428
89	14508	100.00	3.00	3.142
90	14517	101.60	3.18	3.374
91	14528	150.00	3.00	4.763
92	S4822	150.00	5.00	7.830
93	14537	178.00	9.00	16.427
94	14530	200.00	4.00	8.467

TUBES

RECTANGULAR TUBES

RECTANGULAR TUBES

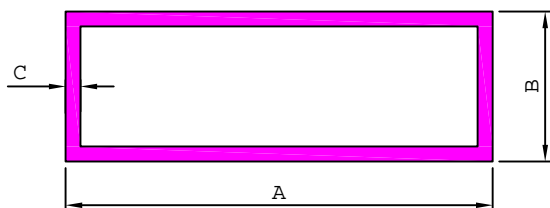

SL. No.	Section No.	A	B	C	Weight kg/m
1	S4183	12.00	9.16	2.00	0.185
2	14145	20.00	10.00	0.75	0.115
3	14059	20.00	10.00	1.20	0.179
4	14058	20.00	10.00	1.50	0.219
5	S5101	20.00	13.00	2.00	0.313
6	14136	25.00	10.00	2.50	0.405
7	14020	25.40	12.70	1.22	0.235
8	14060	25.40	12.70	0.81	0.160
9	14014	25.40	19.05	0.85	0.195
10	14051	25.40	19.05	1.08	0.247
11	14001	25.40	19.05	1.63	0.363
12	14138	30.00	20.00	2.00	0.497
13	14150	35.00	15.00	1.60	0.404
14	14046	36.00	23.50	0.64	0.202
15	14132	36.00	23.50	0.56	0.177
16	14146	36.00	24.00	0.70	0.221
17	14147	36.00	24.00	0.78	0.246
18	14148	36.00	24.00	0.88	0.276
19	14149	36.00	24.00	0.96	0.301
20	14095	36.50	24.50	0.70	0.225
21	14042	37.00	24.00	0.80	0.260
22	14102	38.10	19.05	1.50	0.439
23	14028	38.10	25.40	0.95	0.316
24	14015	38.10	25.40	1.10	0.364
25	14067	38.10	25.40	1.44	0.471
26	14002	38.10	25.40	2.00	0.643
27	14010	38.10	25.40	2.41	0.764
28	14086	38.10	25.40	3.18	0.980
29	14159	38.10	25.40	5.00	1.445
30	14012	40.00	15.00	1.50	0.421
31	14117	40.00	20.00	1.20	0.373
32	14115	40.00	20.00	1.80	0.548
33	14019	40.00	20.00	2.00	0.604
34	14088	40.00	20.00	2.80	0.823
35	14043	44.45	25.40	3.20	1.096
36	14133	46.50	23.50	0.62	0.230
37	14047	46.50	23.50	0.74	0.273
38	14105	47.00	40.00	2.15	0.960
39	14041	48.00	24.00	0.80	0.304
40	14045	48.00	24.00	1.06	0.402
41	14083	48.00	24.00	1.80	0.665
42	14096	49.00	24.50	0.75	0.292
43	14091	49.84	25.94	2.00	0.775
44	14144	50.00	25.00	2.00	0.767
45	14151	50.00	28.00	3.00	1.166
46	14142	50.00	38.00	1.50	0.688
47	14161	50.00	38.00	2.00	0.907
48	14137	50.00	40.00	1.60	0.750

SL. No.	Section No.	A	B	C	Weight kg/m
49	14141	50.80	25.40	0.85	0.342
50	14027	50.80	25.40	0.95	0.381
51	14093	50.80	25.40	1.04	0.414
52	14036	50.80	25.40	1.13	0.451
53	14100	50.80	25.40	1.20	0.478
54	14068	50.80	25.40	1.44	0.570
55	14011	50.80	25.40	1.50	0.593
56	14112	50.80	25.40	1.60	0.631
57	14003	50.80	25.40	2.03	0.791
58	14009	50.80	25.40	2.41	0.929
59	14118	50.80	25.40	3.00	1.137
60	14004	50.80	38.10	3.05	1.363
61	14119	53.00	38.10	1.20	0.574
62	14089	53.00	38.10	1.80	0.850
63	14016	55.00	35.00	3.00	1.360
64	14048	60.00	36.00	0.76	0.390
65	14152	60.00	40.00	4.00	1.987
66	14080	61.00	37.00	0.90	0.471
67	14039	61.00	37.00	1.10	0.569
68	14054	62.00	24.00	0.84	0.382
69	14044	63.00	38.10	1.14	0.608
70	14070	63.00	38.10	1.47	0.781
71	14069	63.00	38.10	2.10	1.093
72	14005	63.00	38.10	2.95	1.516
73	14055	63.50	38.10	1.02	0.547
74	14029	63.50	38.10	1.20	0.643
75	14073	63.50	38.10	1.70	0.901
76	14013	63.50	38.10	2.00	1.054
77	14030	65.00	25.00	0.98	0.466
78	14031	65.00	25.00	1.25	0.590
79	14101	68.50	38.10	1.75	0.974
80	14106	70.00	20.00	2.00	0.929
81	14099	70.00	35.00	1.50	0.826
82	14076	72.00	24.00	0.81	0.414
83	14025	72.00	24.00	1.20	0.606
84	14026	74.80	25.10	1.63	0.851
85	14153	75.00	12.00	1.80	0.811
86	14158	75.00	20.00	2.50	1.215
87	14097	75.00	24.50	0.80	0.423
88	14056	75.00	25.00	1.03	0.547
89	14034	75.00	25.00	1.15	0.607
90	14155	75.00	25.00	1.50	0.786
91	14017	75.00	25.00	2.00	1.036
92	14032	75.00	25.00	2.80	1.427
93	14140	75.00	25.00	3.25	1.641
94	14033	75.00	35.00	2.80	1.578
95	14120	75.00	36.00	0.80	0.472
96	S5147	75.00	38.00	2.00	1.177
97	14024	76.20	44.46	3.20	1.974
98	14090	77.50	37.50	0.80	0.489
99	14082	78.00	35.00	1.00	0.600
100	14061	78.00	38.00	1.00	0.615
101	14139	80.00	20.00	2.00	1.037
102	14128	80.00	50.00	2.00	1.360
103	14022	81.25	38.10	0.95	0.607
104	14072	81.25	38.10	1.25	0.781
105	14071	81.25	38.10	1.75	1.093
106	14006	81.25	38.10	2.64	1.626

TUBES**RECTANGULAR TUBES**

SL. No.	Section No.	A	B	C	Weight kg/m
107	14110	82.50	40.50	1.30	0.845
108	14007	82.60	38.10	3.25	2.004
109	14092	89.22	45.66	2.00	1.414
110	14131	90.00	36.00	0.85	0.571
110	14121	92.00	36.00	0.90	0.613
111	S3840	94.00	54.00	3.50	2.665
112	14052	95.00	24.00	0.95	0.601
113	14053	95.00	24.00	1.17	0.738
114	14063	95.00	38.00	0.90	0.637
115	14129	99.00	52.00	3.00	2.349
116	14103	100.00	15.00	2.00	1.198
117	14065	100.00	20.00	1.40	0.886
118	S4858	100.00	25.00	1.50	0.988
119	14114	100.00	35.00	3.00	2.089
120	14062	100.00	40.00	1.10	0.818
121	14023	100.00	40.00	1.30	0.976
122	14074	100.00	40.00	1.54	1.139
123	14018	100.00	40.00	2.00	1.469
124	14154	100.00	50.00	1.40	1.113
125	S4859	100.00	50.00	1.50	1.190
126	14066	100.00	50.00	1.70	1.345
127	S4409	100.00	50.00	2.00	1.576
128	14087	100.00	50.00	2.80	2.183
129	14064	100.00	50.00	3.00	2.332
130	14085	100.00	50.00	3.25	2.518
131	14143	100.00	50.00	6.00	4.471
132	14077	101.60	25.40	1.10	0.739
133	14037	101.60	25.40	1.35	0.906
134	14050	101.60	25.40	1.63	1.089
135	14035	101.60	44.75	1.35	1.051
136	14075	101.60	44.75	1.75	1.367
137	14021	101.60	44.75	2.40	1.834
138	14008	101.60	44.75	3.18	2.404
139	14049	101.60	50.80	4.78	3.686
140	14124	101.60	50.80	6.35	4.790
141	14130	101.60	44.75	2.00	1.537
142	14104	113.42	58.81	2.10	1.905
143	S5148	116.00	38.00	2.00	1.620
144	14122	120.00	60.00	5.00	4.590
145	14057	123.00	24.00	1.06	0.828
146	S4487	123.00	24.00	2.00	1.544
147	14113	124.00	48.75	4.00	3.559
148	14040	127.00	25.40	1.30	1.052
149	14094	127.00	25.40	1.79	1.439
150	14157	127.00	25.40	3.18	2.508
151	14079	127.00	38.10	1.20	1.051
152	14038	127.00	38.10	1.35	1.184
153	14078	127.00	38.10	1.74	1.518
154	14081	127.00	44.45	3.18	2.834
155	14134	127.00	44.45	5.00	4.359
156	14111	127.00	50.80	4.76	4.325
157	S5033	127.00	63.50	4.00	3.942
158	14156	146.00	58.00	2.50	2.686
159	S4478	150.00	25.00	1.50	1.393
160	S5149	150.00	38.00	2.00	1.987
161	14135	150.00	44.45	3.18	3.230
162	14116	150.00	50.00	2.00	2.116
163	14125	150.00	50.00	4.78	4.916

SL. No.	Section No.	A	B	C	Weight kg/m
164	14109	150.00	75.00	2.00	2.386
165	14123	150.00	75.00	3.50	4.120
166	14126	200.00	100.00	5.00	7.830
167	14127	200.00	125.00	8.00	13.349
168	14107	203.20	50.80	3.20	4.279

TUBES

FLUTED ROUND TUBES, OVAL TUBES & MISCELLANEOUS TUBES

FLUTED ROUND TUBES

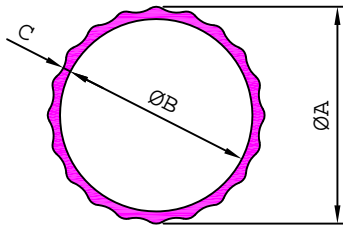

SL. No.	Section No.	ØA	ØB	C	Weight kg/m
1	14904	18.50	16.75	0.67	0.114
2	14907	18.50	17.33	0.38	0.074
3	14913	18.80	16.70	0.70	0.127
4	14901	19.05	16.90	0.70	0.130
5	14910	20.50	17.70	0.90	0.186
6	14909	20.70	19.20	0.52	0.109
7	14915	24.00	22.62	0.49	0.114
8	14903	24.80	22.60	0.70	0.179
9	14916	24.80	22.97	0.67	0.156
10	14906	24.80	23.56	0.416	0.107
11	14921	24.80	22.84	0.40	0.148
12	14902	25.40	20.34	1.83	0.410
13	14914	25.40	22.01	0.93	0.252
14	14912	25.40	22.07	0.90	0.247
15	14908	25.40	22.20	0.79	0.226
16	14917	25.40	22.68	0.60	0.189
17	14919	25.40	20.80	1.60	0.370
18	14905	28.00	25.50	0.80	0.237
19	14911	28.00	26.32	0.63	0.171
20	14918	32.06	27.00	1.83	0.533
21	14920	37.00	33.00	1.50	0.511

SQUARE TUBE WITH CORNER RADIUS

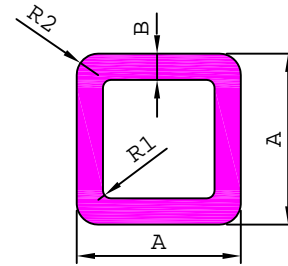

SL. No.	Section No.	A	B	R1	R2	Weight kg/m
1	15226	18.00	2.00	0.40	1.50	0.341
2	15113	19.00	1.50	0.40	1.60	0.277
3	15228	25.40	1.63	2.40	4.00	0.395
4	15185	32.00	3.00	1.50	3.00	0.924
5	15232	40.00	1.50	0.40	2.00	0.615
6	15251	40.00	2.00	2.00	4.00	0.793
7	15221	44.00	4.00	4.00	4.00	1.728
8	15239	50.80	6.35	3.18	6.35	2.978
9	15220	53.00	4.00	4.00	8.00	2.006
10	15252	76.20	4.00	0.50	3.00	3.099
11	15143	101.60	3.18	1.58	4.76	3.333
12	15260	120.00	12.00	5.00	0.40	14.054
13	15238	150.00	15.00	0.40	2.00	21.861
14	15267	25.00	2.00	4.00	6.00	0.450
15	S5112	126.46	2.00	17.48	19.48	2.517

OVAL TUBES

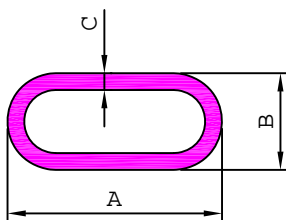

SL. No.	Section No.	A	B	C	Weight kg/m
1	15008	6.80	4.35	1.00	0.042
2	15005	24.00	11.10	1.60	0.240
3	15007	27.70	12.00	1.25	0.220
4	15006	35.15	19.56	1.14	0.273
5	15009	45.00	22.50	3.00	0.861
6	15004	65.00	25.00	1.60	0.663

TUBES

FLUTED ROUND TUBES, OVAL TUBES & MISCELLANEOUS TUBES

RECTANGULAR TUBE WITH CORNER RADIUS

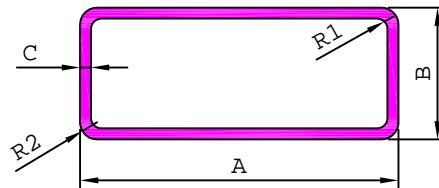

SL. No.	Section No.	A	B	C	R1	R2	Weight kg/m
1	15189	25.00	15.00	3.00	0.40	3.00	0.530
2	15247	30.00	15.00	0.80	1.20	2.00	0.182
3	15230	30.00	18.00	1.20	0.40	1.50	0.290
4	15123	33.00	20.00	1.20	0.40	1.50	0.323
5	15187	33.00	20.00	1.20	1.30	2.50	0.317
6	15198	40.00	20.00	2.00	0.50	2.50	0.591
7	15256	45.00	20.00	3.00	0.40	3.00	0.935
8	15142	49.80	20.00	1.20	1.30	2.50	0.426
9	15212	49.80	20.00	1.20	1.30	2.50	0.426
10	15258	50.00	25.00	2.00	4.00	6.00	0.720
11	15241	50.80	25.40	2.50	0.40	3.20	0.939
12	15197	55.00	20.00	1.30	1.70	3.00	0.494
13	15249	65.00	24.00	1.20	4.10	5.30	0.535
14	15151	76.20	38.10	4.78	1.00	1.00	2.704
15	15155	80.00	40.00	4.00	2.00	2.00	2.419
16	15207	80.38	41.84	4.56	3.17	0.40	3.201
17	15179	100.00	80.00	2.80	1.20	4.00	2.603
18	15157	120.00	110.00	3.65	2.00	2.00	4.389
19	15186	140.00	120.00	4.00	5.00	9.00	5.313
20	15214	168.00	72.00	4.00	4.00	8.00	4.900
21	15229	245.00	97.00	3.50	0.40	1.00	6.330
22	15264	254.00	89.60	5.00	4.80	9.80	8.838
23	15264	254.00	89.60	5.00	4.80	9.80	8.838

TUBES

MISCELLANEOUS TUBES

15101

1.230 kg/m

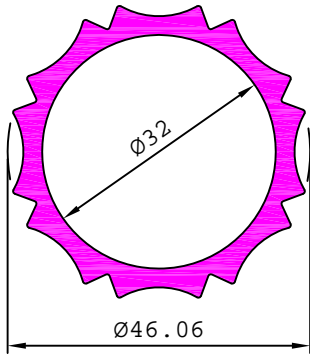

15106

0.164 kg/m

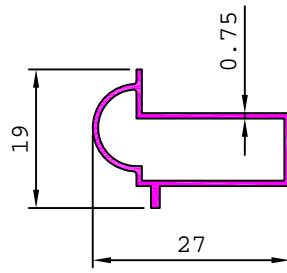

15109

0.460 kg/m

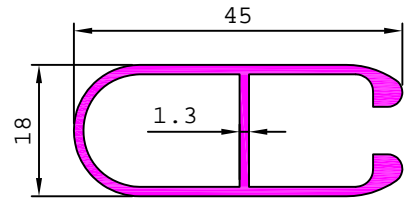

15117

4.478 kg/m

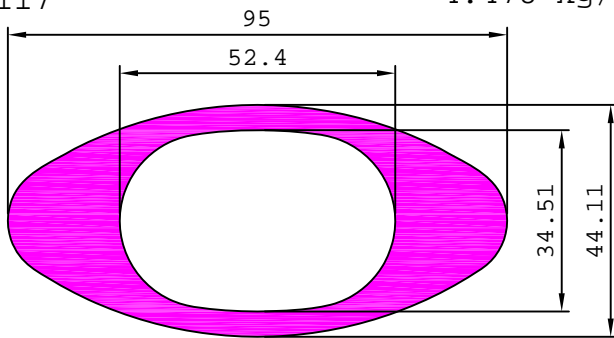

15125

1.111 kg/m

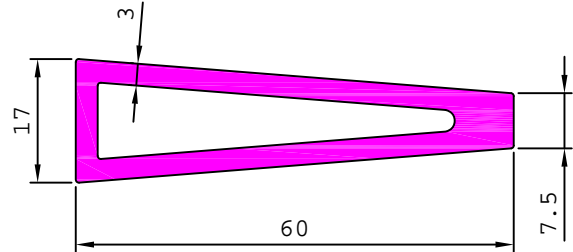

15118

1.570 kg/m

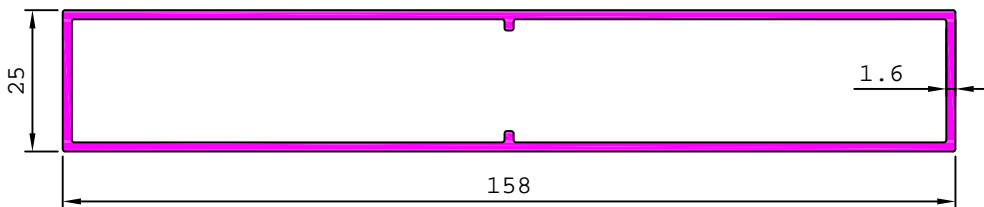

15121

0.075 kg/m

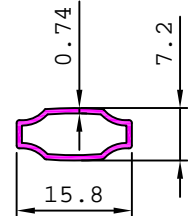

15130

0.621 kg/m

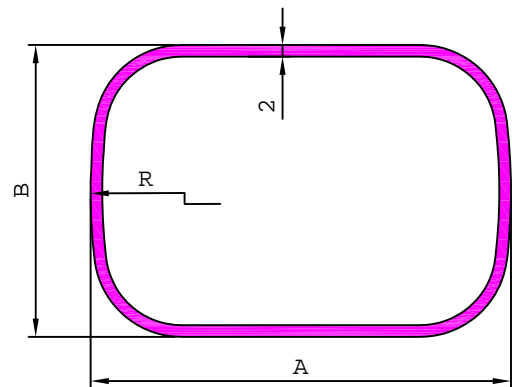
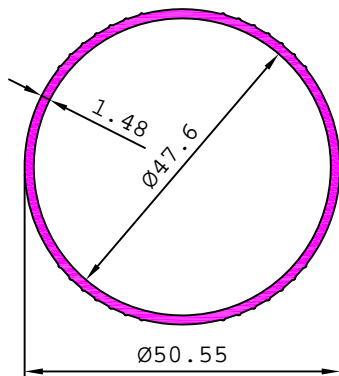

15135

0.869 kg/m

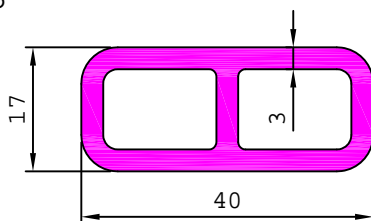

SL. No.	Section No.	A	B	R	Weight kg/m
1	15140	72.00	50.00	100.00	1.132
2	15141	50.00	40.00	50.00	0.804
2	15164	62.75	42.00	84.00	0.988

TUBES

MISCELLANEOUS TUBES

15136

0.137 kg/m

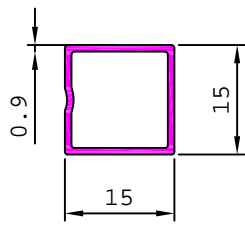

15148

0.575 kg/m

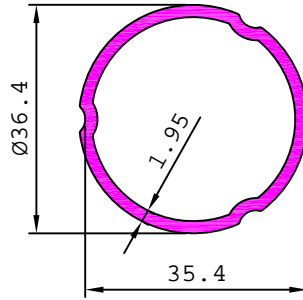

15156

0.329 kg/m

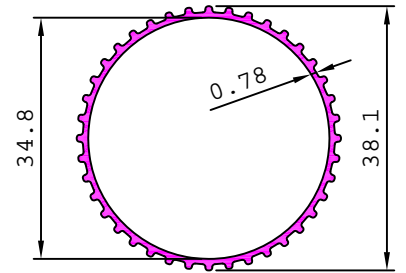

15145

4.780 kg/m

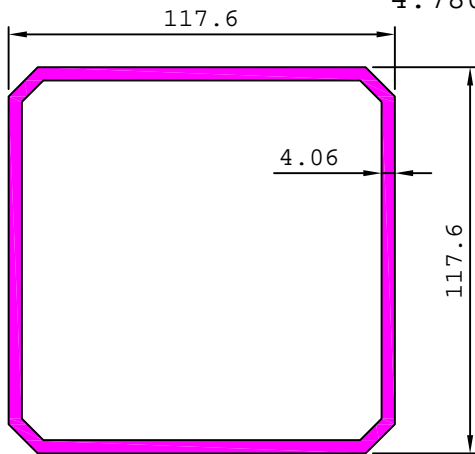

15175

2.894 kg/m

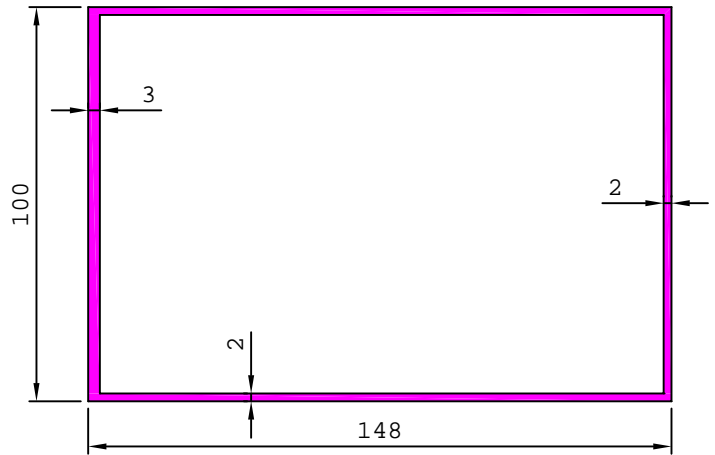

15150

0.300 kg/m

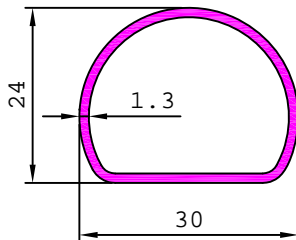

15152

0.271 kg/m

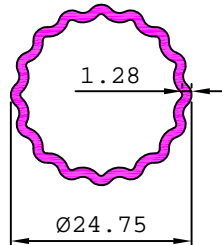

15163

0.310 kg/m

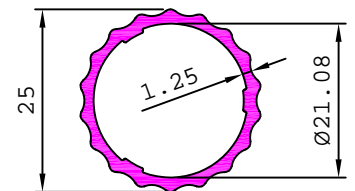

15167

0.087 kg/m

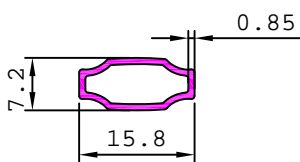

15176

0.282 kg/m

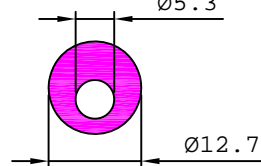

15190

0.058 kg/m

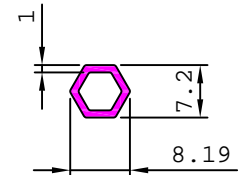

15188

1.704 kg/m

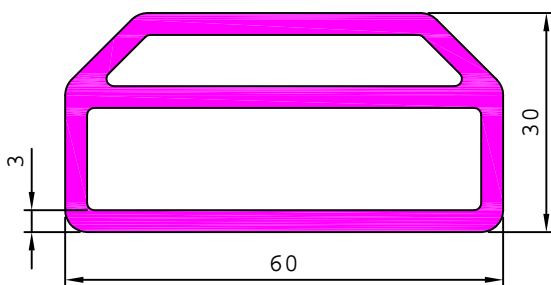

15181

0.984 kg/m

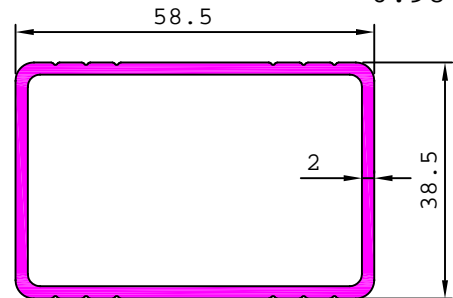

TUBES

MISCELLANEOUS TUBES

15180 4.780 kg/m

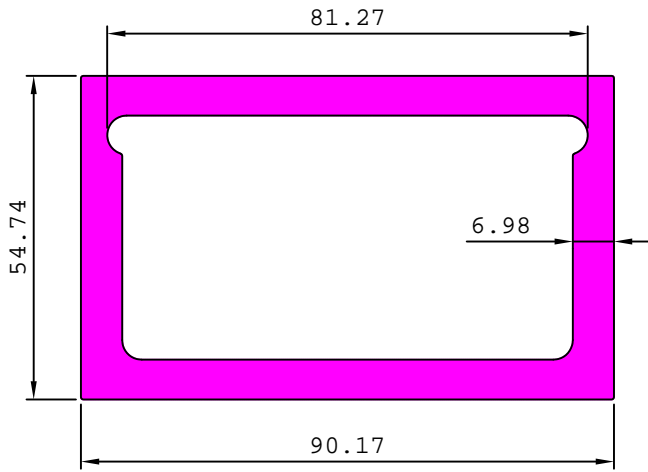

15199 0.700 kg/m

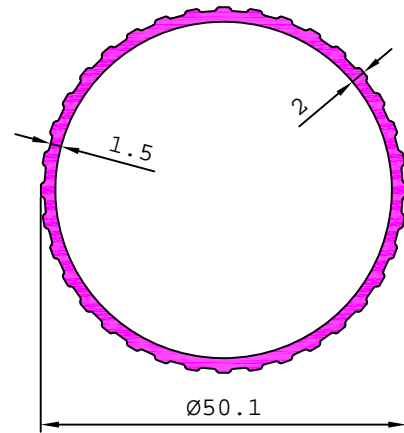

15203 0.391 kg/m

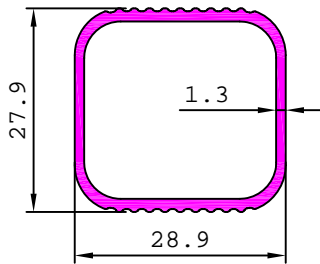

15204 0.377 kg/m

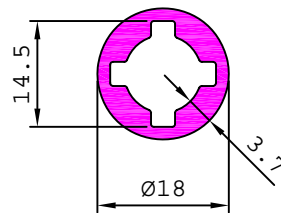

15215 0.287 kg/m

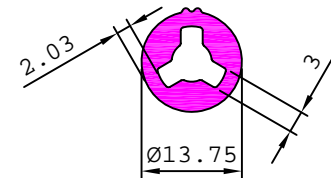

15205 0.944 kg/m

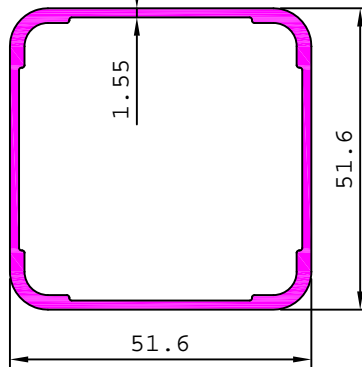

15206 1.119 kg/m

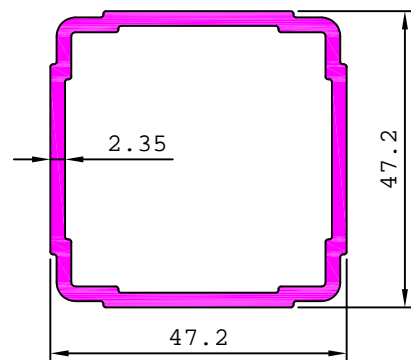

15202 0.695 kg/m

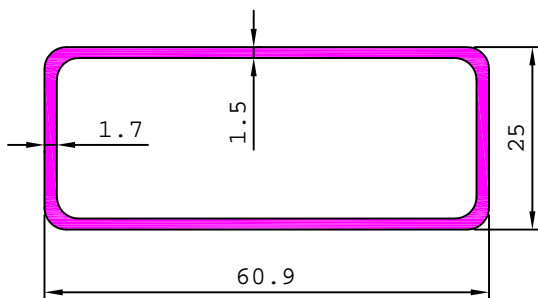

15210 7.375 kg/m

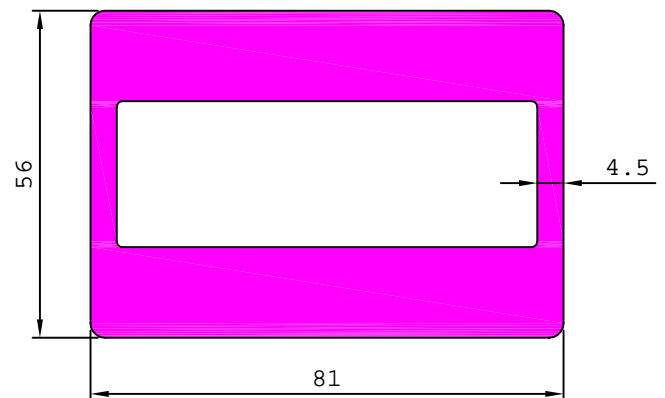

TUBES

MISCELLANEOUS TUBES

15216 69.928 kg/m

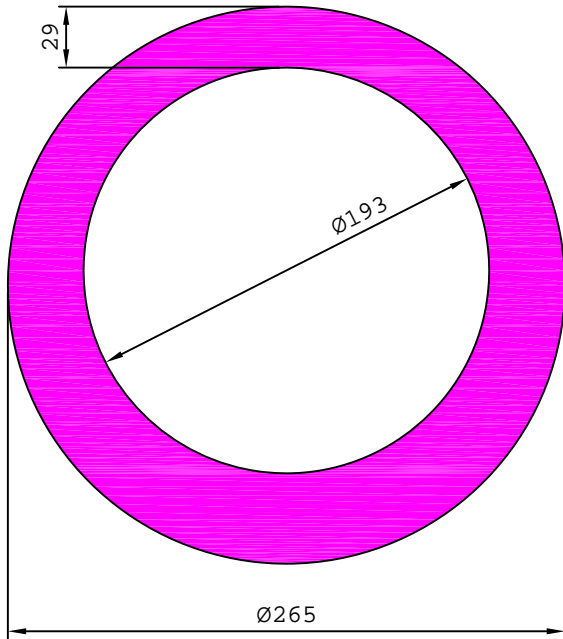

15217 21.131 kg/m

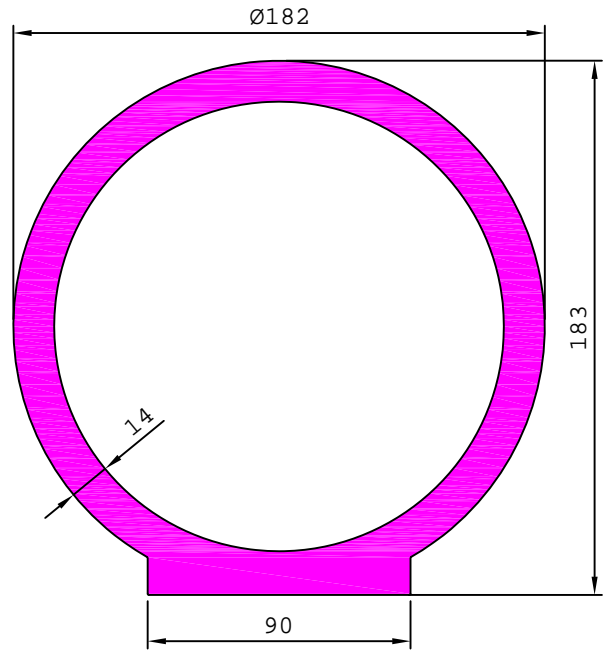

15218 1.350 kg/m

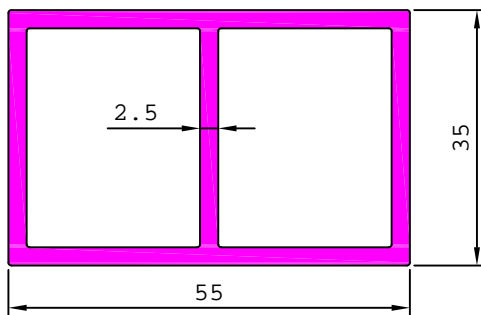

15219 1.509 kg/m

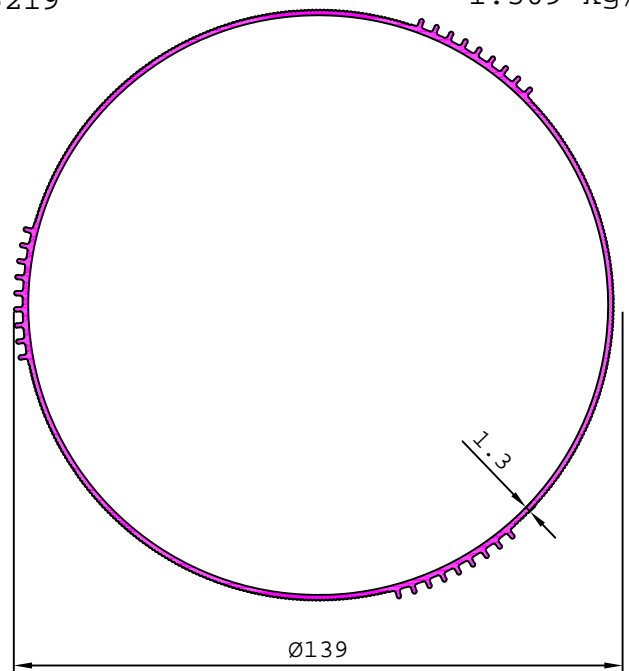

15222 0.962 kg/m

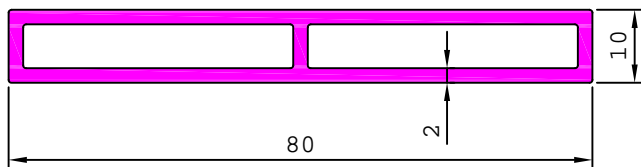

15227 2.676 kg/m

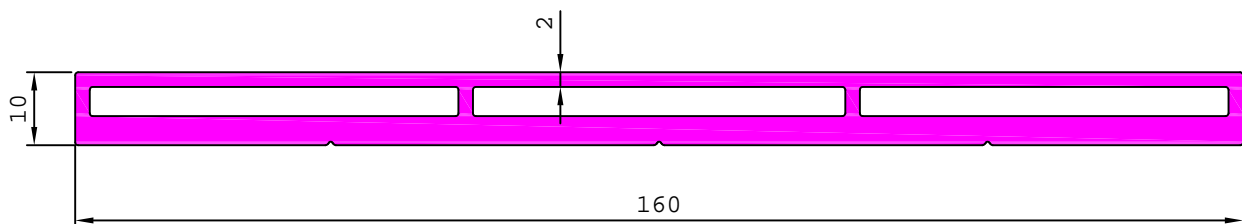

TUBES

MISCELLANEOUS TUBES

15223 0.298 kg/m

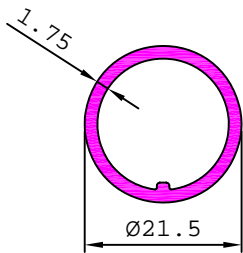

15224 0.852 kg/m

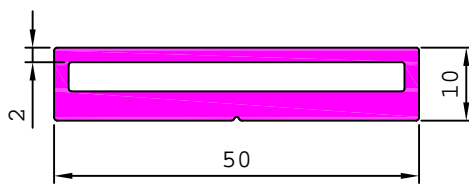

15233 0.307 kg/m

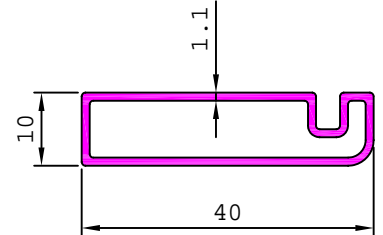

15225 1.501 kg/m

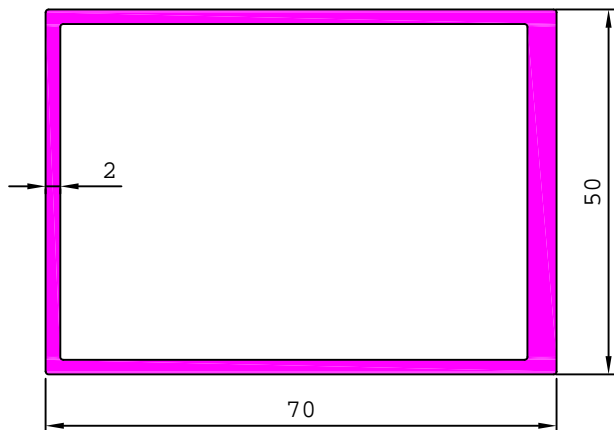

15234 0.488 kg/m

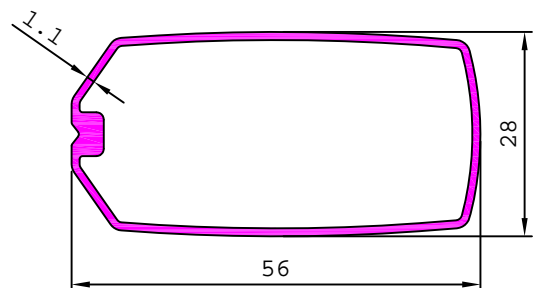

15240 0.504 kg/m

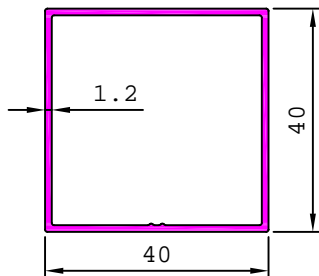

15235 0.333 kg/m

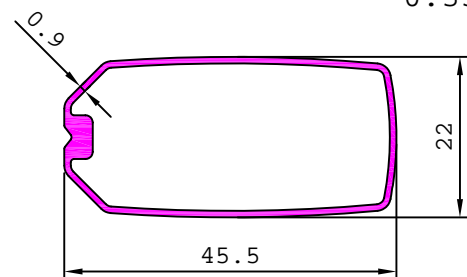

15236 0.161 kg/m

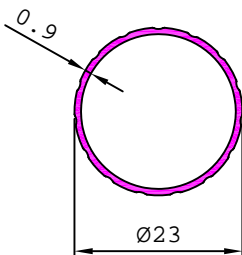

15237 0.172 kg/m

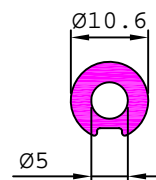

28654 0.713 kg/m

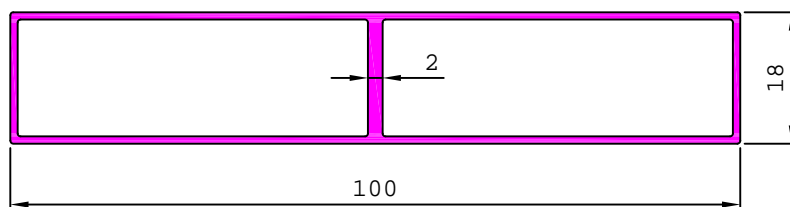

TUBES

MISCELLANEOUS TUBES

15242

1.350 kg/m

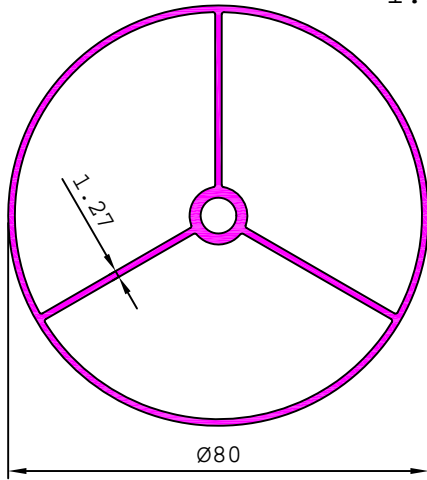

15243

0.207 kg/m

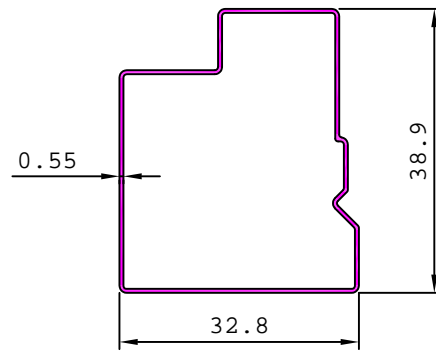

15244

81.729 kg/m

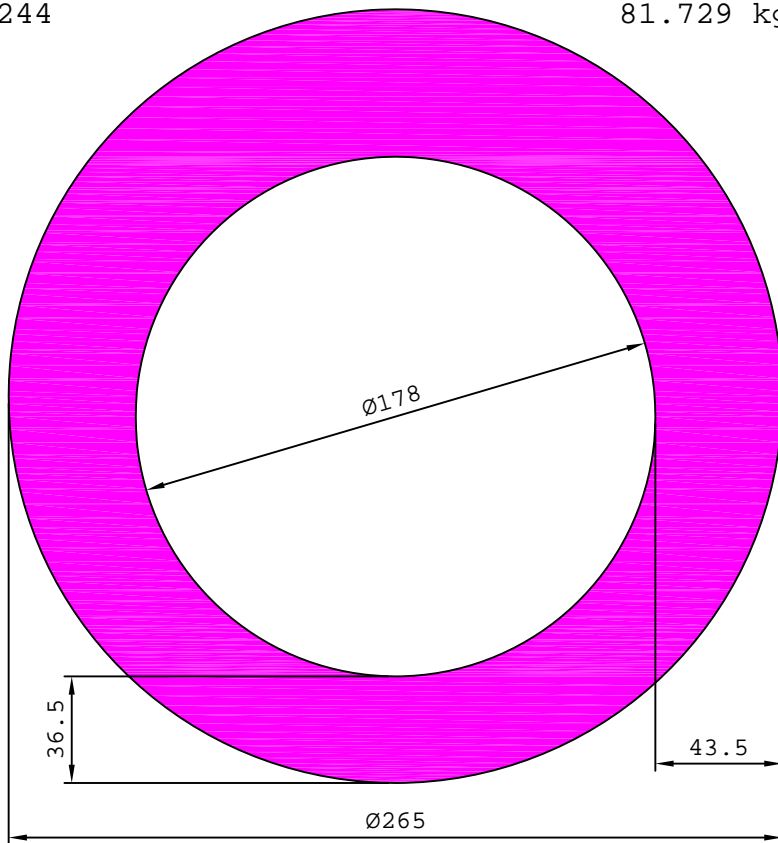

15246

0.488 kg/m

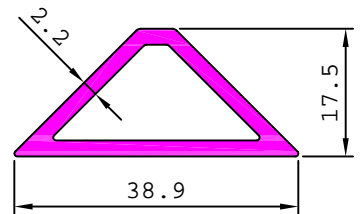

15248

1.768 kg/m

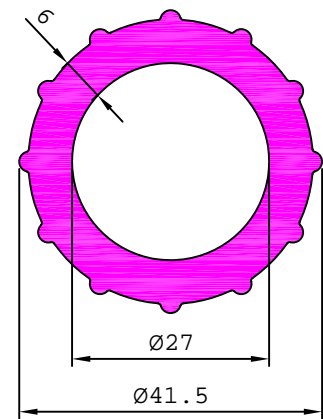

15250

0.322 kg/m

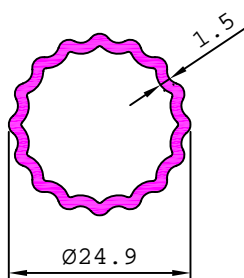

15253

0.738 kg/m

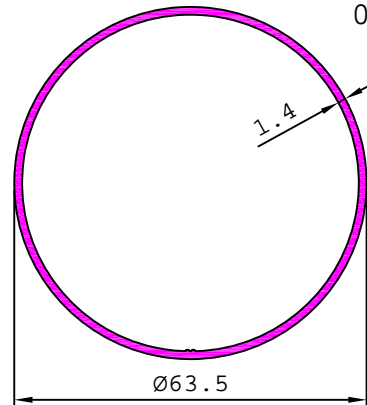

TUBES

MISCELLANEOUS TUBES

15254

0.153 kg/m

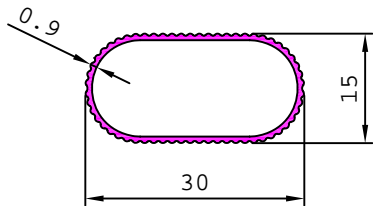

15255

0.175 kg/m

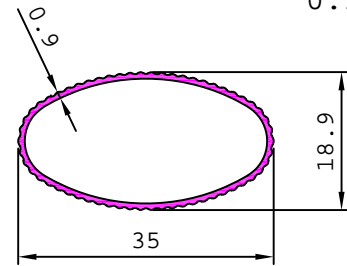

15257

0.761 kg/m

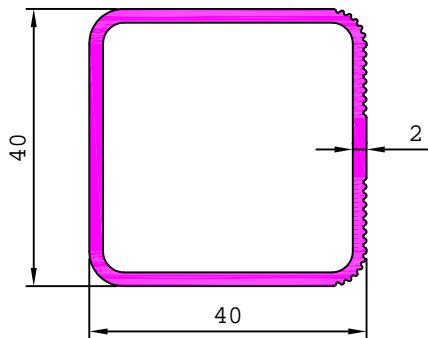

15262

0.330 kg/m

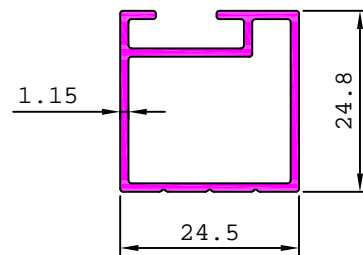

15259

5.104 kg/m

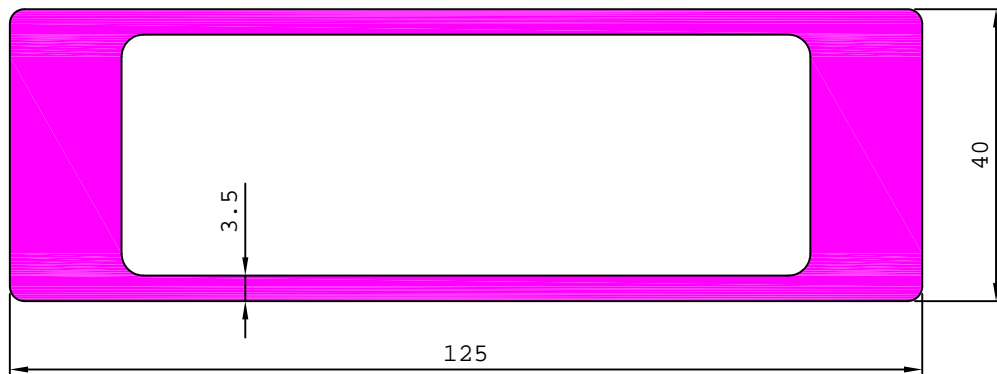

15261

2.887 kg/m

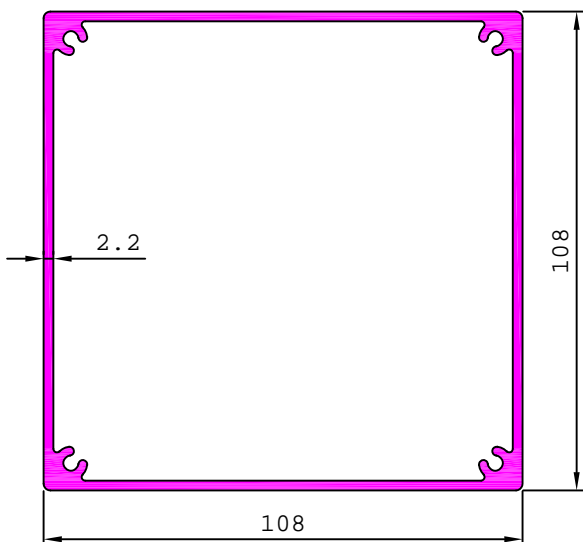

15263

2.330 kg/m

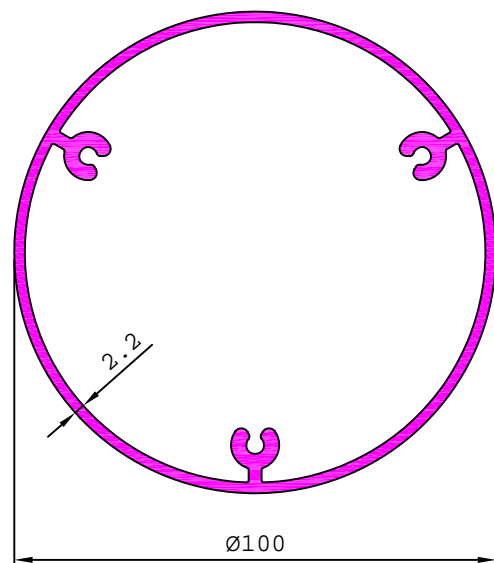

TUBES

MISCELLANEOUS TUBES

15265

7.107 kg/m

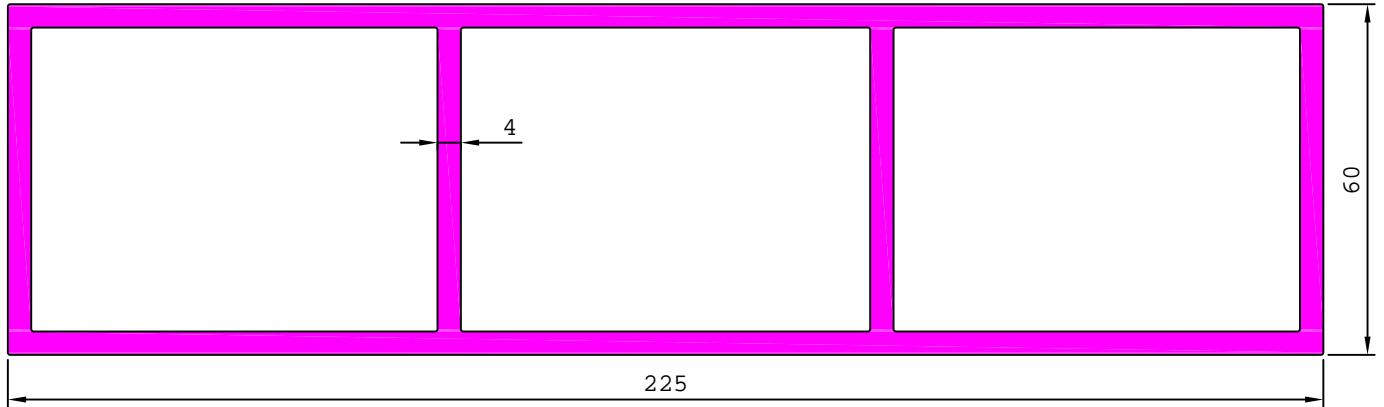

15268

0.846 kg/m

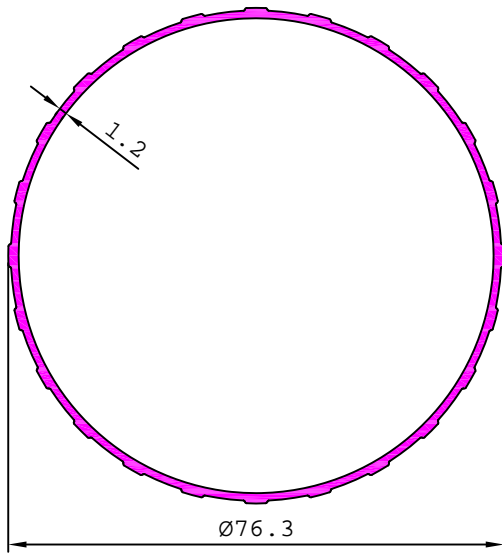

27612

2.984 kg/m

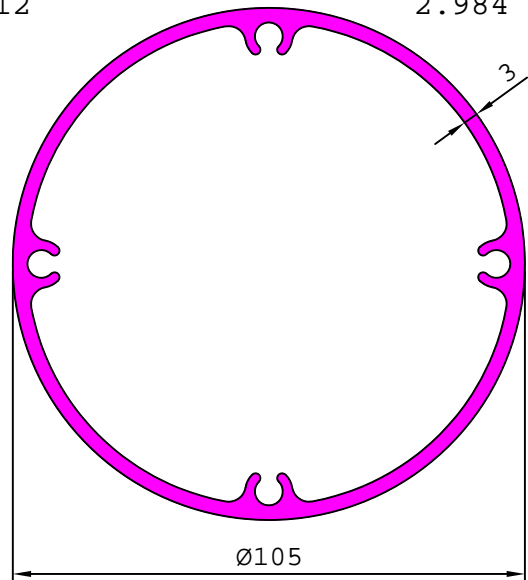

27518

4.200 kg/m

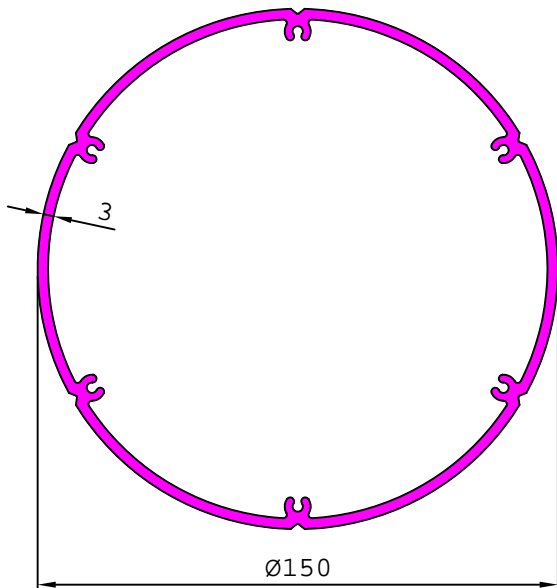

27563

6.100 kg/m

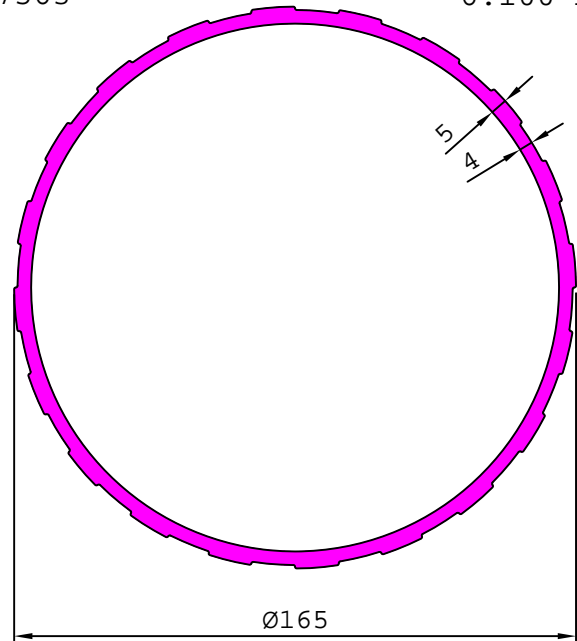

TUBES

MISCELLANEOUS TUBES

27576

5.106 kg/m

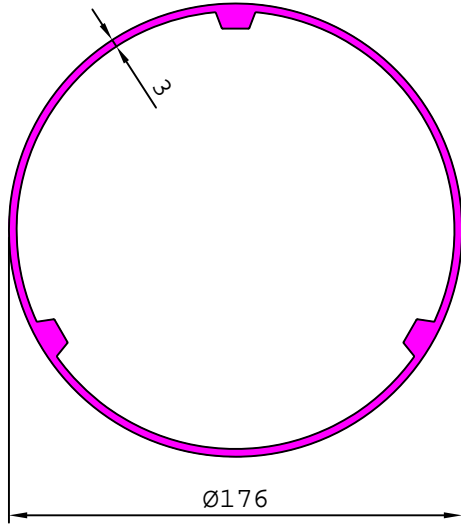

27583

3.609 kg/m

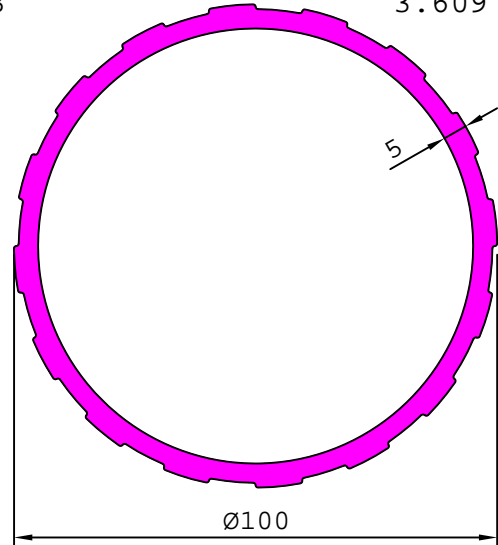

27388

1.467 kg/m

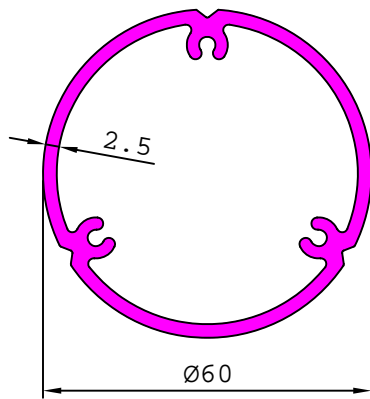

27916

4.970 kg/m

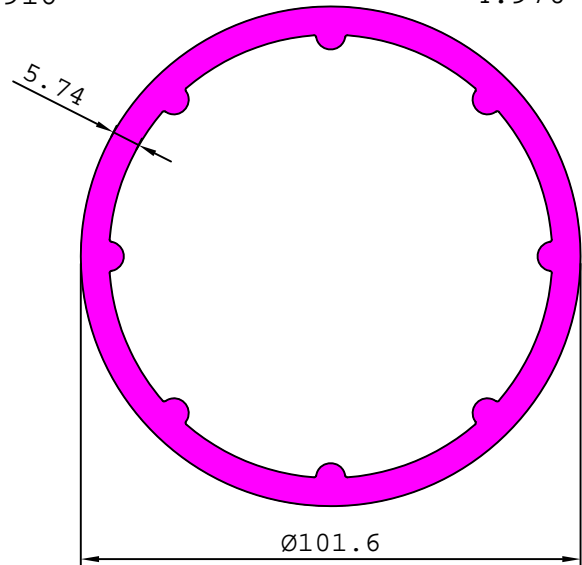

28897

2.348 kg/m

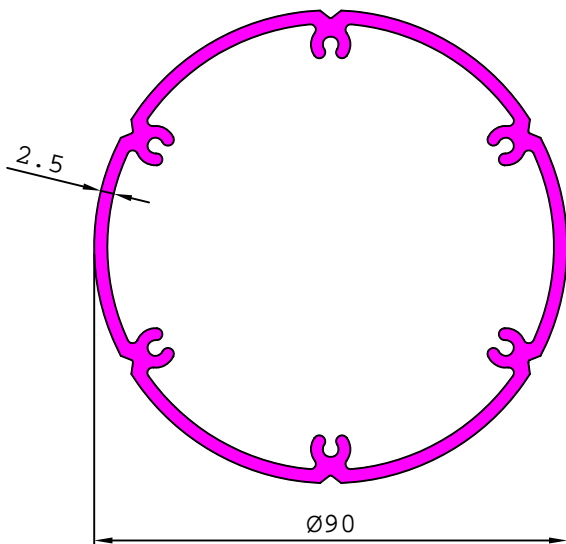

29289

3.766 kg/m

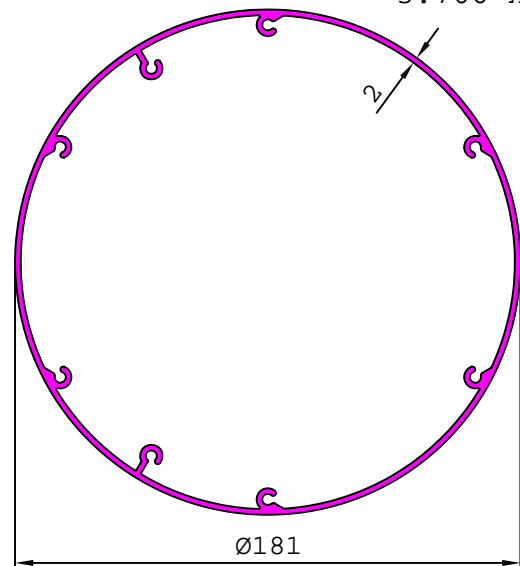

TUBES

MISCELLANEOUS TUBES

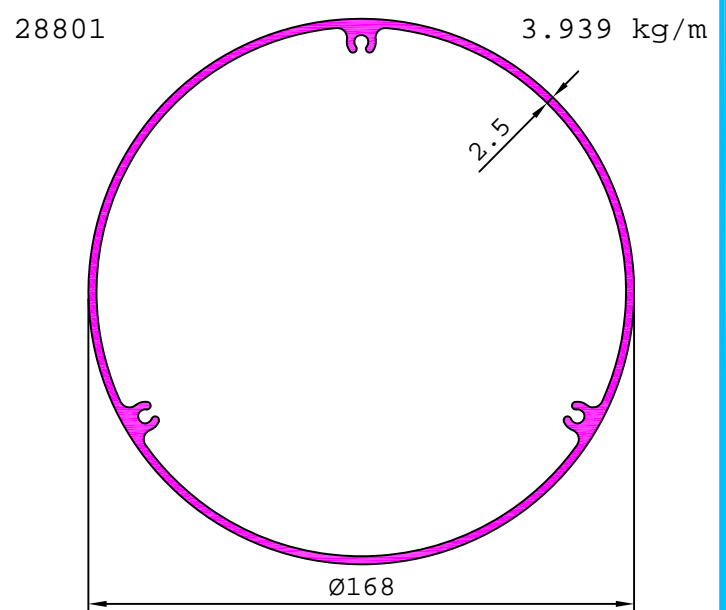
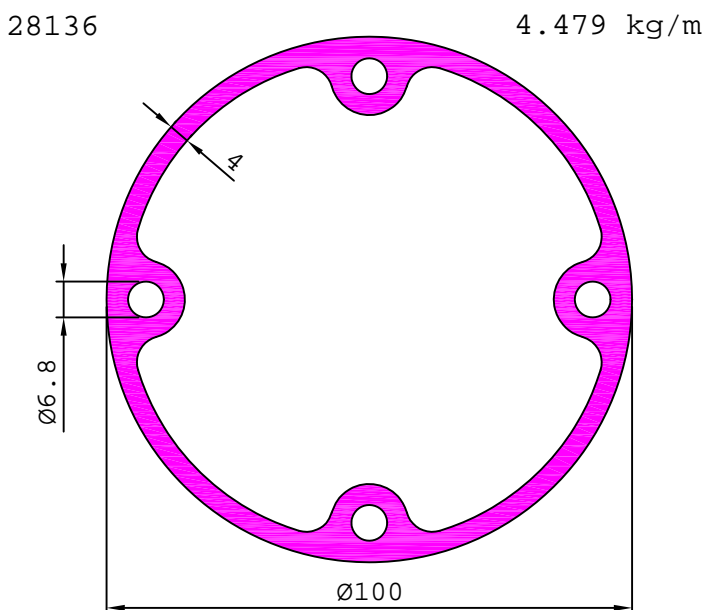
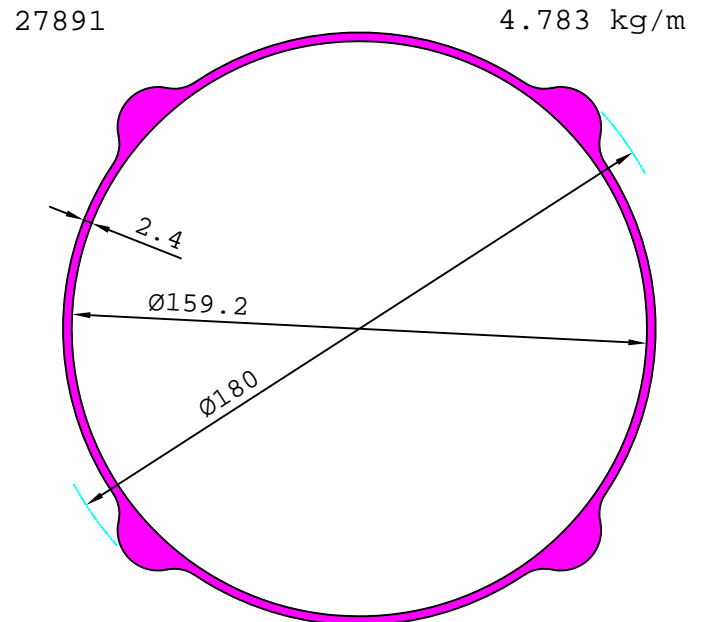
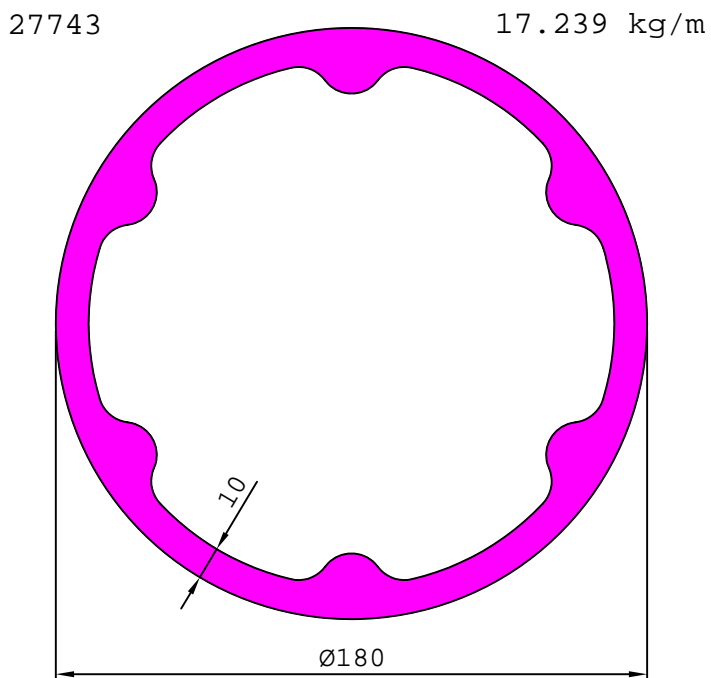
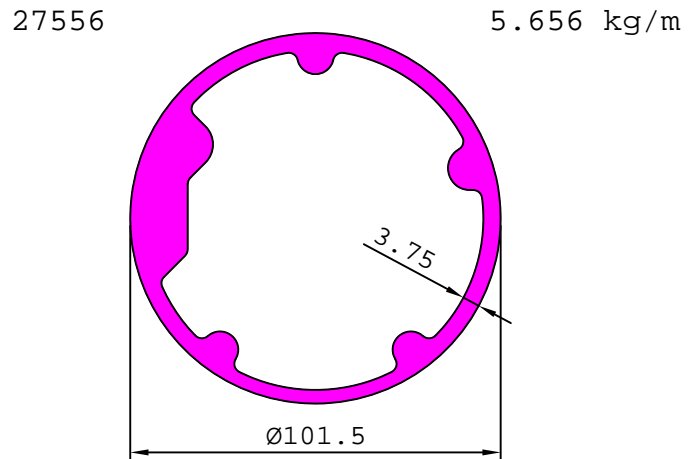
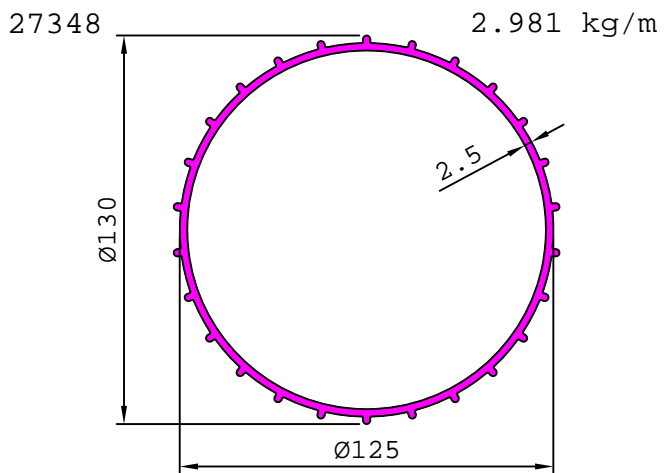

TUBES

MISCELLANEOUS TUBES

28955

3.599 kg/m

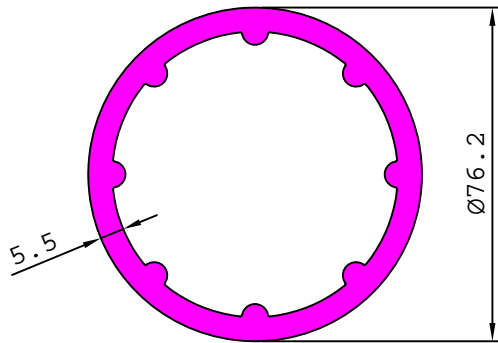

29576

2.450 kg/m

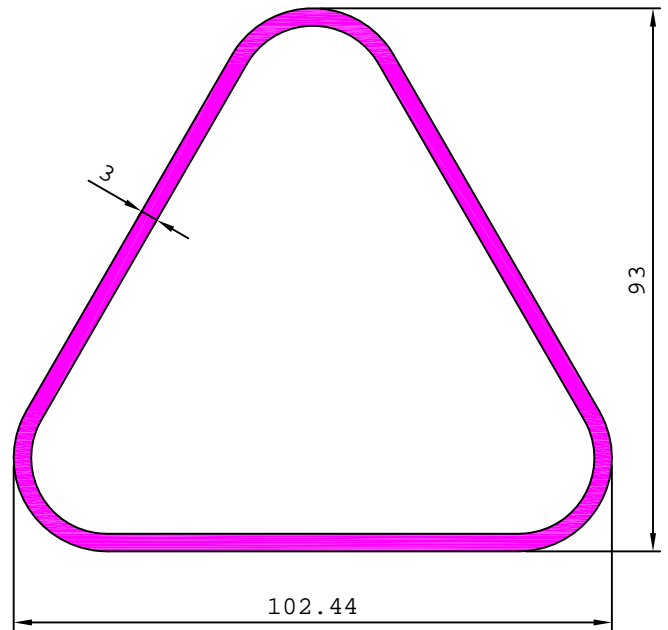

29608

1.212 kg/m

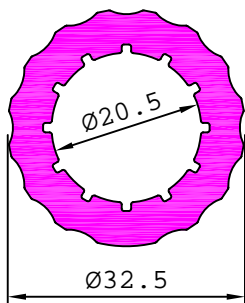

S4500

1.421 kg/m

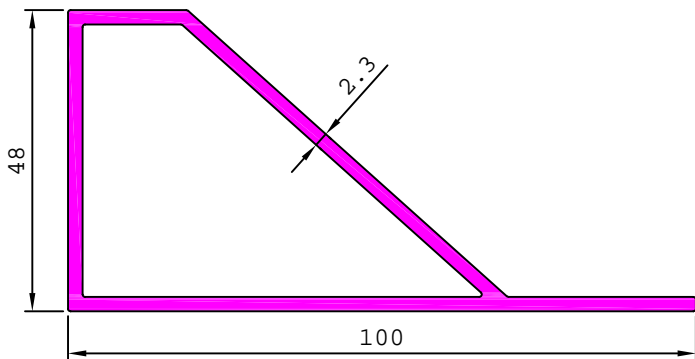

S4512

1.017 kg/m

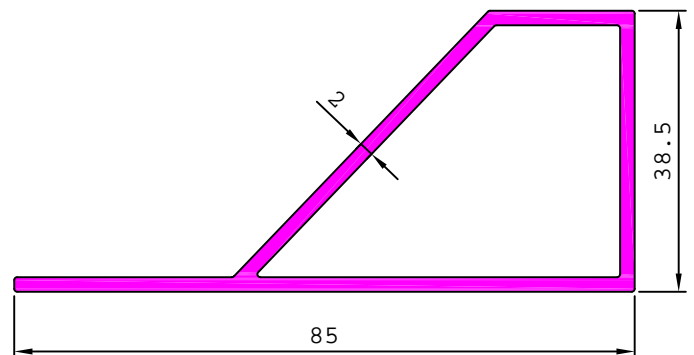

S4446

0.184 kg/m

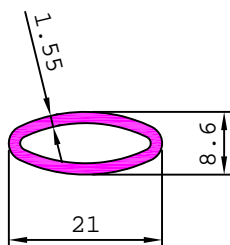

S5187

2.058 kg/m

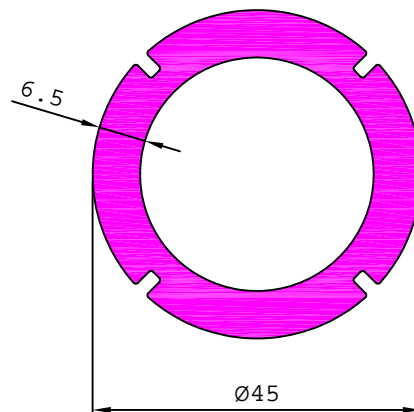

STRUCTURAL

CHANNELS - SQUARE FILLET

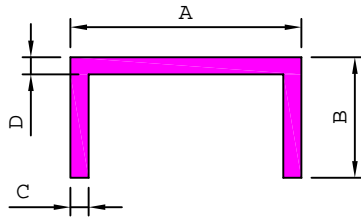

SL. No.	Section No.	A	B	C	D	Weight kg/m
1	15660	5.50	10.90	1.10	1.10	0.074
2	15601	6.25	10.30	1.30	2.00	0.092
3	15693	6.60	9.50	0.80	0.80	0.052
4	15679	7.50	7.50	0.60	0.60	0.034
5	15666	7.80	6.90	0.49	0.49	0.027
6	15626	8.00	6.00	1.50	1.50	0.069
7	15715	8.00	7.00	0.36	0.36	0.021
8	15602	8.75	9.50	1.20	1.50	0.087
9	15635	9.00	8.00	0.57	0.57	0.037
10	15776	9.30	9.30	0.55	0.55	0.040
11	15778	9.40	9.40	0.90	0.90	0.064
12	15771	8.75	9.50	1.10	1.40	0.081
13	S4739	8.75	9.75	1.50	1.50	0.102
14	15784	9.00	15.00	1.20	1.20	0.118
15	15603	9.52	9.52	0.57	0.57	0.042
16	15673	9.52	9.52	0.76	0.76	0.055
17	15702	9.52	9.52	0.95	0.95	0.068
18	15650	9.52	9.52	1.15	1.15	0.081
19	15604	9.52	9.52	1.60	1.60	0.110
20	15672	9.52	12.50	1.65	1.65	0.139
21	15706	10.00	12.00	2.80	2.80	0.214
22	15717	10.00	12.00	2.80	2.80	0.215
23	15668	11.70	11.70	0.51	0.51	0.047
24	15667	11.80	8.50	0.52	0.52	0.039
25	15622	12.00	9.00	0.62	0.62	0.048
26	15767	12.00	10.00	1.20	1.20	0.096
27	15724	12.00	15.00	1.80	1.80	0.186
28	15749	12.00	20.00	2.00	2.00	0.259
29	15740	12.50	15.00	1.00	1.00	0.109
30	15621	12.70	12.70	0.57	0.57	0.057
31	15674	12.70	12.70	0.85	0.85	0.083
32	15605	12.70	12.70	1.09	1.09	0.105
33	15606	12.70	12.70	2.38	2.38	0.213
34	15676	13.50	11.00	2.30	2.30	0.192
35	15726	14.00	14.00	1.00	1.00	0.108
36	15681	14.30	18.00	1.20	1.20	0.154
37	15692	14.50	14.50	0.90	0.90	0.101
38	15607	15.00	10.00	1.60	1.60	0.137
39	15630	15.00	12.00	1.10	1.10	0.109
40	15698	15.00	15.00	1.20	1.20	0.138
41	15659	15.00	15.00	2.00	2.00	0.221
42	15664	15.40	15.40	1.40	1.40	0.164
43	15783	16.00	4.00	1.50	1.50	0.085
44	15782	16.95	9.85	1.20	1.20	0.111
45	15696	16.00	16.00	1.20	1.20	0.148
46	15675	16.00	19.00	1.20	1.20	0.167
47	15669	16.80	10.50	0.49	0.49	0.049
48	15642	17.00	10.50	0.63	0.63	0.062
49	15629	18.00	12.00	1.10	1.10	0.118
50	15741	19.00	15.00	1.00	1.00	0.127

SL. No.	Section No.	A	B	C	D	Weight kg/m
51	15694	19.00	19.00	1.00	1.00	0.149
52	15619	19.05	12.70	1.25	1.25	0.141
53	15608	19.05	19.05	1.63	1.63	0.237
54	15684	20.00	10.00	1.40	1.40	0.140
55	15747	20.00	20.00	1.00	1.00	0.156
56	15665	20.00	20.00	3.00	3.00	0.438
57	15735	20.64	19.84	1.98	1.98	0.301
58	15670	22.00	10.00	0.62	0.62	0.069
59	15695	22.00	19.00	1.10	1.10	0.172
60	15712	22.00	20.00	1.10	1.10	0.178
61	15627	22.20	12.70	1.10	1.10	0.135
62	15719	22.40	14.22	1.52	1.52	0.195
63	15643	23.00	10.80	0.68	0.68	0.079
64	15646	23.00	11.00	1.19	1.19	0.136
65	15661	23.00	11.00	1.45	1.45	0.165
66	15662	23.00	11.00	1.62	1.62	0.182
67	15663	23.00	11.00	1.97	1.97	0.218
68	15742	23.00	15.00	1.00	1.00	0.137
69	15678	23.00	23.00	1.10	1.10	0.198
70	15632	24.00	11.00	1.20	1.20	0.141
71	15677	24.00	12.50	1.90	1.90	0.232
72	15700	24.60	4.00	1.10	1.20	0.096
73	15768	24.60	24.60	2.50	2.50	0.464
74	15763	25.00	15.00	5.00	6.00	0.661
75	15733	25.00	20.00	1.10	1.10	0.186
76	15769	25.00	30.00	2.50	2.50	0.540
77	15718	25.16	19.03	1.40	1.40	0.228
78	15710	25.20	4.10	1.00	1.00	0.085
79	15633	25.40	12.70	1.22	1.22	0.159
80	15705	25.40	12.70	1.88	1.88	0.238
81	15634	25.40	12.70	2.00	3.00	0.311
82	15610	25.40	12.70	3.18	3.18	0.381
83	27418	18.00	4.50	2.40	3.20	0.171
84	15611	25.40	19.05	3.18	3.18	0.491
85	15775	25.40	25.40	1.20	1.20	0.239
86	15612	28.58	25.40	3.00	3.00	0.594
87	15647	30.00	13.00	0.90	0.90	0.130
88	15657	30.00	30.00	3.00	3.00	0.681
89	15618	31.50	19.00	3.00	3.00	0.514
90	15686	31.75	12.70	1.56	1.56	0.228
91	15613	31.75	12.70	3.18	3.18	0.435
92	15685	32.00	3.50	1.20	1.50	0.142
93	28048	33.00	7.00	5.00	5.00	0.499
94	15648	37.00	15.00	0.85	0.85	0.147
95	15743	38.00	15.00	1.00	1.00	0.178
96	15748	38.00	25.00	3.00	3.00	0.664
97	15649	38.10	12.00	2.50	2.50	0.385
98	15732	38.10	19.05	1.59	1.59	0.313
99	15682	38.10	19.05	2.40	2.40	0.462
100	15614	38.10	19.05	3.22	3.22	0.607
101	15751	38.10	38.10	3.18	3.18	0.926
102	S4402	39.00	20.60	2.00	2.00	0.411
103	15739	40.00	20.00	1.10	1.10	0.231
104	15708	40.00	20.00	1.20	1.20	0.251
105	15774	40.00	20.00	1.50	1.50	0.311
106	15697	40.00	20.00	1.80	1.80	0.371
107	15658	40.00	40.00	4.00	4.00	1.210
108	15625	40.00	40.00	5.00	5.00	1.485

STRUCTURAL**CHANNELS AND TEES**

SL. No.	Section No.	A	B	C	D	Weight kg/m
109	15699	42.50	25.00	2.00	2.00	0.478
110	15744	44.00	15.00	1.00	1.00	0.194
111	15615	44.00	25.40	2.95	2.95	0.708
112	15781	44.00	28.00	1.78	1.78	0.463
113	15620	44.45	25.40	3.18	4.78	0.928
114	15738	45.00	20.00	1.10	1.10	0.246
115	15720	45.00	30.00	3.00	3.00	0.802
116	15713	45.00	37.00	2.00	2.00	0.621
117	15688	45.00	54.00	2.00	2.00	0.805
118	15745	50.00	15.00	1.00	1.00	0.210
119	15734	50.00	20.00	1.10	1.10	0.260
120	15730	50.00	25.00	1.80	1.80	0.468
121	15637	50.00	40.00	5.00	5.00	1.620
122	15683	50.80	25.40	3.00	3.00	0.773
123	15656	50.80	25.40	4.76	4.76	1.183
124	15701	50.80	25.40	6.59	7.35	1.650
125	15773	50.80	50.80	3.18	3.18	1.254
126	15728	67.00	39.00	2.80	2.80	1.053
127	15691	68.00	22.00	1.20	1.20	0.354
128	15765	75.00	35.00	4.00	4.00	1.479
129	15716	76.00	32.00	5.00	2.20	1.256
130	15617	76.20	50.80	3.18	3.18	1.472
131	15707	76.40	19.20	1.90	1.20	0.432
132	15770	90.00	75.00	12.50	17.50	8.133
133	15746	99.00	15.00	1.10	1.10	0.376
134	15762	100.00	25.00	1.50	1.50	0.595
135	15680	100.00	25.00	2.00	2.00	0.788
136	15709	100.00	30.00	1.10	1.10	0.468
137	15736	100.00	30.00	1.50	1.50	0.635
138	15766	100.00	50.00	10.00	10.00	4.860
139	S4410	100.00	103.00	2.50	2.50	2.031
140	15725	101.60	50.80	5.00	5.00	2.608
141	15723	101.60	50.80	6.35	6.35	3.266
142	15703	110.00	25.00	2.00	2.00	0.842
143	15780	120.00	50.00	8.00	8.00	4.406
144	15779	120.00	60.00	8.00	8.00	4.838
145	15729	130.00	67.50	11.60	11.60	7.573
146	15777	130.00	50.00	7.00	7.00	4.082
147	15764	134.00	32.00	10.00	8.00	4.190
148	15750	150.00	50.00	4.00	4.00	2.613
149	15772	152.40	63.50	7.60	4.60	4.310

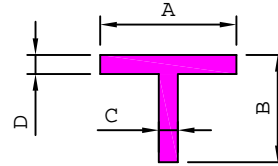
TEES - SQUARE FILLET TOES

SL. No.	Section No.	A	B	C	D	Weight kg/m
1	17720	9.00	30.50	7.00	9.00	0.625
2	16134	11.50	11.50	0.58	0.58	0.035
3	16127	12.70	12.70	0.56	0.56	0.038
4	16102	12.70	12.70	1.70	1.70	0.109
5	16135	17.00	17.00	0.51	0.51	0.046
6	16141	18.80	18.80	2.00	2.00	0.192
7	16139	18.80	18.80	2.30	2.30	0.219
8	16128	19.05	19.05	0.66	0.66	0.067
9	16103	19.05	19.05	1.45	1.45	0.144
10	16143	19.05	19.05	1.00	1.00	0.100
11	16104	19.05	19.05	3.18	3.18	0.299
12	16142	21.70	22.50	1.80	1.80	0.206
13	16124	24.00	24.00	2.16	2.16	0.268
14	16144	24.00	24.00	0.73	0.73	0.093
15	16153	24.00	27.00	10.50	6.00	0.984
16	16140	24.00	31.00	4.40	4.40	0.601
17	16154	25.00	15.00	1.00	1.00	0.105
18	16131	25.40	25.40	0.83	0.83	0.111
19	16129	25.40	25.40	1.22	1.22	0.163
20	16108	25.40	25.40	1.60	1.60	0.212
21	16125	25.40	25.40	2.60	2.60	0.338
22	28242	27.50	16.00	11.00	3.00	0.608
23	16152	31.00	19.35	1.75	1.75	0.229
24	16111	31.75	31.75	1.60	1.60	0.267
25	16112	31.75	38.10	1.60	1.60	0.294
26	28058	35.50	66.50	12.50	7.00	2.679
27	16136	38.00	38.00	2.00	2.00	0.400
28	16155	38.10	38.10	1.50	1.50	0.302
29	16118	38.10	38.10	1.60	1.60	0.322
30	16115	38.10	38.10	3.18	3.18	0.627
31	16121	38.10	38.10	4.80	4.80	0.925
32	16147	38.10	101.60	6.35	6.35	2.286
33	16145	38.61	76.20	6.35	6.35	1.859
34	27927	41.30	41.30	23.30	6.00	2.889
35	28076	41.30	42.30	22.20	6.00	2.845
36	16146	50.80	76.20	6.35	6.35	2.068
37	16148	50.80	101.60	6.35	6.35	2.504
38	16149	50.80	127.00	6.35	6.35	2.939
39	16151	50.80	127.00	7.94	7.94	3.641
40	16150	50.80	152.40	6.35	6.35	3.375
41	28056	52.00	66.50	31.00	7.00	5.963
42	16156	98.42	50.80	3.18	3.18	1.252

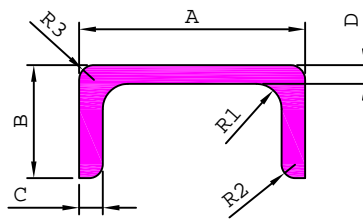
STRUCTURAL**CHANNELS AND TEES****CHANNELS - ROUND FILLET TOES**

SL. No.	Section No.	A	B	C	D	R1	R2	R3	Weight kg/m
1	16034	14.20	19.00	1.50	1.50	-	0.75	1.00	0.197
2	17521	22.60	10.80	1.30	1.20	1.25	-	3.00	0.137
3	17621	27.00	14.00	1.50	1.50	1.60	0.75	3.20	0.200
4	16014	50.80	31.75	6.65	4.40	3.25	-	-	1.597
5	16029	53.80	25.40	4.76	4.76	8.00	-	12.76	1.107
6	16030	63.00	32.00	5.00	5.00	1.00	-	-	1.580
7	16027	63.50	25.40	4.76	4.76	8.00	-	12.76	1.232
8	16036	65.00	35.00	3.00	3.00	1.00	-	1.50	1.043
9	16010	75.00	40.00	5.00	5.00	5.00	-	-	1.986
10	16026	76.00	38.00	5.00	3.00	7.00	-	-	1.617
11	16031	76.20	38.10	5.70	4.00	8.00	-	-	1.943
12	16003	76.20	38.10	7.94	6.35	8.50	4.50	-	2.728
13	16035	85.00	40.00	3.00	3.00	1.00	-	2.00	1.284
14	16004	100.00	25.00	2.00	2.00	2.00	-	-	0.792
15	16015	100.00	50.00	1.80	1.80	1.50	-	-	1.061
16	16007	101.60	41.83	6.68	6.68	9.52	-	-	3.205
17	16001	101.60	50.80	7.90	6.40	9.10	-	-	3.746
18	16033	102.00	50.00	8.00	8.00	9.00	-	-	4.111
19	16032	120.00	20.00	3.00	3.00	-	-	3.00	1.237
20	16011	125.00	55.00	6.50	6.50	6.00	-	-	3.938
21	16020	127.20	47.88	8.05	8.05	9.40	-	-	4.598
22	16006	140.00	50.00	8.00	8.00	6.00	-	-	4.881
23	16005	140.00	70.00	8.00	8.00	6.00	-	-	5.745
24	16021	152.40	51.60	8.10	8.10	11.20	-	-	5.380
25	16012	160.00	79.50	10.00	10.00	1.00	-	-	8.072
26	15737	177.80	58.40	9.98	9.98	11.11	-	-	7.543
27	16022	177.80	58.40	10.09	10.09	7.00	-	-	7.532
28	27565	177.80	95.25	12.70	12.70	3.17	3.17	15.87	11.455
29	16023	184.00	43.00	3.00	3.00	-	-	-	2.128
30	16017	203.20	65.00	11.84	11.84	12.70	-	-	10.081
31	16025	224.00	43.00	3.00	3.00	-	-	3.00	2.452
32	16018	250.00	75.00	5.00	5.00	10.00	-	-	5.380
33	16019	254.00	92.87	13.18	13.18	12.90	-	-	14.903
34	16024	254.00	92.87	13.18	13.18	12.90	-	8.00	14.829
35	16028	264.00	43.00	3.00	3.00	-	-	3.00	2.776

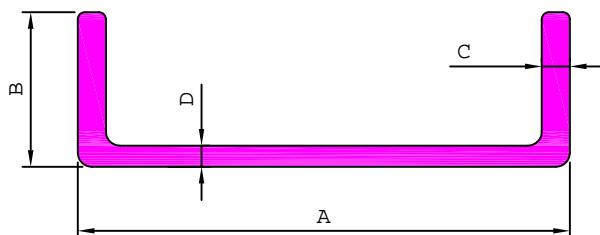

SL. No.	Section No.	A	B	C	D	Weight kg/m
1	27382	75.00	35.00	6.00	3.00	1.639
2	27383	100.00	40.00	6.50	3.50	2.221
3	27384	125.00	45.00	8.00	5.00	3.406
4	27385	150.00	50.00	10.00	5.00	4.446
5	27386	175.00	60.00	9.00	5.00	5.026
6	27387	200.00	65.00	9.00	5.00	5.607

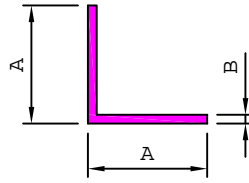
STRUCTURAL**EQUAL ANGLES****EQUAL ANGLES - SQUARE FILLET**

SL. No.	Section No.	A	B	Weight kg/m
1	S4683	6.00	1.50	0.042
2	16496	11.00	0.37	0.022
3	16442	11.00	0.47	0.027
4	16425	12.00	0.53	0.033
5	16500	12.00	1.30	0.079
6	16401	12.70	0.75	0.050
7	16402	12.70	1.52	0.098
8	16403	12.70	3.18	0.191
9	16459	15.00	1.30	0.100
10	16497	16.80	0.34	0.030
11	16443	16.80	0.39	0.035
12	16426	18.00	0.60	0.057
13	16454	19.00	0.80	0.079
14	16404	19.05	0.62	0.064
15	16462	19.05	1.00	0.099
16	16405	19.05	1.31	0.130
17	16450	19.05	1.60	0.158
18	16478	19.05	2.00	0.195
19	16460	19.05	2.25	0.218
20	16436	19.05	2.75	0.262
21	16406	19.05	3.18	0.299
22	16446	20.00	1.20	0.126
23	16486	20.00	2.00	0.205
24	16444	21.00	0.46	0.052
25	16498	23.00	0.55	0.067
26	16427	23.00	0.62	0.076
27	16433	23.50	1.90	0.231
28	16455	25.00	1.30	0.170
29	16424	25.00	1.50	0.196
30	16463	25.00	1.80	0.234
31	16422	25.00	2.00	0.259
32	16441	25.40	0.80	0.108
33	16408	25.40	1.01	0.137
34	16407	25.40	1.22	0.163
35	16451	25.40	1.60	0.213
36	16461	25.40	2.10	0.273
37	16474	25.40	2.25	0.295
38	16409	25.40	3.18	0.409
39	16449	25.40	5.00	0.618
40	16456	28.00	1.80	0.263
41	16457	28.00	2.50	0.360
42	16445	29.00	0.59	0.091
43	16464	30.00	1.80	0.283
44	16447	30.00	2.00	0.313
45	16468	30.00	2.80	0.432
46	16448	30.00	3.00	0.462
47	16418	30.00	5.00	0.742
48	16431	31.75	0.72	0.122
49	16410	31.75	1.57	0.262
50	16411	31.75	3.00	0.488
51	16472	32.00	5.00	0.797

SL. No.	Section No.	A	B	Weight kg/m
52	16428	35.00	1.10	0.204
53	16477	35.00	3.40	0.610
54	16489	35.00	4.00	0.712
55	16458	38.00	2.80	0.553
56	16482	38.00	5.00	0.959
57	16432	38.10	1.22	0.247
58	16499	38.10	1.50	0.302
59	16412	38.10	1.57	0.316
60	16479	38.10	2.25	0.449
61	16453	38.10	2.50	0.497
62	16483	38.10	2.76	0.546
63	16502	38.10	3.00	5.93
64	16413	38.10	3.18	0.627
65	16414	38.10	4.78	0.921
66	16421	38.10	6.35	1.197
67	16484	38.10	5.80	1.102
68	16452	40.00	2.50	0.523
69	16465	40.00	2.80	0.584
70	16438	40.00	3.00	0.623
71	16423	40.00	4.00	0.820
72	16435	40.00	5.00	1.013
73	16419	45.00	5.00	1.147
74	16437	50.00	1.00	0.267
75	16488	50.00	2.00	0.529
76	16469	50.00	2.80	0.735
77	16440	50.00	3.00	0.786
78	16491	50.00	4.00	1.036
79	16473	50.00	6.00	1.523
80	16481	50.00	8.00	1.987
81	16485	50.00	5.00	1.282
82	16487	50.80	1.60	0.432
83	16501	50.80	3.18	0.845
84	16415	50.80	4.78	1.249
85	16494	50.80	6.00	1.548
86	16430	50.80	6.35	1.633
87	16439	60.00	6.00	1.847
88	16503	60.00	8.00	2.419
89	16480	63.00	3.00	0.996
90	16416	63.50	4.78	1.577
91	16420	63.50	6.35	2.067
92	16470	75.00	2.70	1.074
93	16475	75.00	3.00	1.191
94	16417	75.00	4.78	1.873
95	16434	76.20	9.52	3.673
96	16429	80.00	8.00	3.283
97	16492	100.00	10.00	5.130
98	16490	114.30	6.35	3.810
99	16493	160.00	12.00	9.979

STRUCTURAL

ANGLES

UNEQUAL ANGLES - SQUARE FILLET

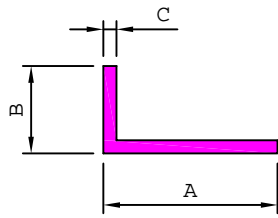

SL. No.	Section No.	A	B	C	Weight kg/m
1	16763	14.90	9.90	2.00	0.123
2	16756	16.00	10.00	0.41	0.028
3	16790	16.00	10.00	0.70	0.048
4	16732	16.50	10.50	0.49	0.035
5	16729	18.00	10.00	1.60	0.114
6	16757	19.00	12.00	1.23	0.098
7	16719	19.05	12.70	0.62	0.052
8	16701	19.05	12.70	0.79	0.066
9	16734	19.50	10.00	2.00	0.148
10	16760	19.50	15.88	2.38	0.212
11	16738	22.00	10.00	1.60	0.131
12	16744	22.00	12.70	3.00	0.257
13	16754	22.25	12.70	2.00	0.178
14	16733	22.50	11.00	0.50	0.044
15	16775	25.00	9.60	1.70	0.151
16	16780	25.00	11.00	0.80	0.076
17	16787	25.00	16.00	2.30	0.240
18	16717	25.00	16.00	2.50	0.259
19	16721	25.40	12.70	0.64	0.065
20	16720	25.40	12.70	1.22	0.121
21	16702	25.40	12.70	1.57	0.154
22	16773	25.40	19.05	1.60	0.185
23	16704	25.40	20.64	1.98	0.235
24	16777	28.04	21.69	2.64	0.335
25	16736	30.00	20.00	3.00	0.381
26	16769	30.00	25.00	3.00	0.421
27	16706	31.75	19.05	3.18	0.409
28	16723	37.00	24.00	0.80	0.130
29	16788	38.00	25.00	2.18	0.358
30	16743	38.10	22.22	2.50	0.390
31	16742	38.10	25.40	1.82	0.303
32	16749	38.10	25.40	2.36	0.390
33	16708	38.10	25.40	3.18	0.517
34	16726	38.10	25.40	4.75	0.753
35	16711	40.00	20.00	3.00	0.461
36	16771	44.00	22.00	2.00	0.345
37	16779	44.45	25.40	1.50	0.276
38	16765	45.00	25.00	4.00	0.712
39	16724	49.00	24.00	1.10	0.218
40	16748	50.00	25.00	2.30	0.451
41	16716	50.00	25.40	5.00	0.950
42	16768	50.00	25.00	3.00	0.583
43	16766	50.00	30.00	3.00	0.623
44	16772	50.00	40.00	4.00	0.928
45	16753	50.80	25.40	3.48	0.683
46	16709	50.80	38.10	6.35	1.415
47	16755	55.30	30.00	1.50	0.339
48	16758	55.30	28.30	2.50	0.547
49	16764	60.00	25.00	8.00	1.663
50	16747	60.00	30.00	1.40	0.335

SL. No.	Section No.	A	B	C	Weight kg/m
51	16739	60.00	40.00	3.00	0.786
52	16783	60.00	50.00	3.00	0.866
53	16737	60.00	50.00	8.00	2.203
54	16751	63.00	38.00	5.00	1.295
55	16718	63.50	19.05	1.22	0.268
56	16774	63.50	22.23	3.18	0.708
57	16761	68.15	15.05	3.00	0.649
58	16789	70.00	20.00	3.00	0.704
59	16782	75.00	50.00	5.00	1.620
60	16735	80.00	50.00	5.00	1.688
61	16792	100.00	20.00	4.00	1.252
62	16741	100.00	40.00	3.00	1.110
63	16791	100.00	50.00	5.00	1.957
64	16784	100.00	50.00	5.00	1.957
65	16785	100.00	50.00	6.00	2.332
66	16786	100.00	50.00	8.00	3.067
67	16762	101.00	76.00	6.35	2.925
68	16778	150.00	40.00	2.00	1.015
69	16776	152.40	38.10	3.18	1.608
70	16793	160.00	100.00	10.00	6.750
71	16781	160.00	100.00	12.00	8.035
72	16767	180.00	55.00	5.00	3.105

EQUAL ANGLES-ROUND FILLET TOES

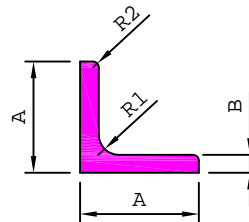

SL. No.	Section No.	A	B	R1	R2	Weight kg/m
1	16903	31.75	3.18	5.08	-	0.532
2	16906	38.10	4.78	4.76	-	0.934
3	16911	45.00	4.00	4.00	-	0.937
4	16912	50.80	6.20	6.50	-	1.621
5	16910	88.00	6.00	6.00	-	2.774

UNEQUAL ANGLES-ROUND FILLET TOES

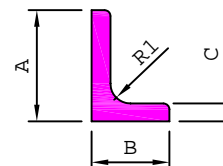

SL. No.	Section No.	A	B	C	R1	Weight kg/m
1	16952	63.50	50.80	4.78	5.50	1.448
2	16957	75.00	50.00	6.20	6.50	2.013
3	27390	101.60	31.75	3.80	2.40	1.330
4	25146	120.00	80.00	8.00	8.00	4.184

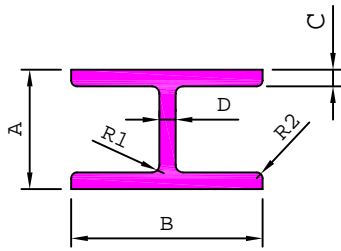
STRUCTURAL**H-SECTIONS, ROUND - BULBED TEES & TOP HATS****H-SECTIONS**

SL. No.	Section No.	A	B	C	D	R1	R2	Weight kg/m
1	17010	9.54	19.05	1.30	1.30	-	-	0.158
2	17008	28.00	22.00	1.85	1.85			0.341
3	17004	31.00	32.00	3.00	3.00	1.00	1.00	0.718
4	17016	40.00	20.00	4.90	4.00	-	1.00	0.851
5	17011	51.50	24.80	2.50	1.90	-	-	0.573
6	17007	76.20	63.50	5.08	3.30	6.35	-	2.424
7	27834	132.00	200.00	16.00	16.00	7.00	-	21.713

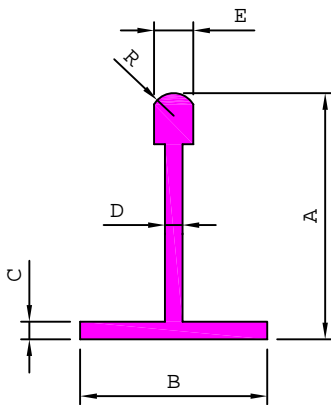
BULBED TEES - STRAIGHT HEAD

SL. No.	Section No.	A	B	C	D	E	R	Weight kg/m
1	17219	23.50	23.50	0.90	0.90	2.70	-	0.122
2	17210	23.50	23.50	1.20	1.20	3.00	-	0.171
3	17204	23.50	23.50	1.50	1.50	3.00	-	0.202
4	17222	25.00	24.50	0.45	0.45	1.80	-	0.066
5	17209	25.00	24.50	0.59	0.59	2.05	-	0.085
6	17213	25.00	24.50	0.65	0.65	2.30	-	0.097
7	17212	25.00	24.50	0.95	0.95	2.50	-	0.136
8	17217	25.00	24.50	0.74	0.74	2.50	-	0.109
9	17211	25.00	25.00	1.17	1.17	3.50	-	0.171
10	17214	25.00	25.00	1.35	1.35	3.50	-	0.195
11	17216	25.00	25.00	1.60	1.60	3.50	-	0.219
12	17218	25.45	40.00	1.45	1.45	2.80	1.40	0.258
13	17203	30.00	30.00	1.60	1.50	2.80	2.50	0.254
14	17215	32.00	32.00	1.45	1.45	2.80	2.50	0.254
15	17206	32.00	32.00	1.60	1.60	2.80	2.50	0.278
16	17208	35.00	23.50	1.50	1.50	3.00	-	0.249
17	17205	36.50	23.50	1.50	1.50	3.00	-	0.254
18	17221	38.00	25.00	1.40	1.40	2.80	1.40	0.249
19	17220	38.00	38.00	1.40	1.40	5.00	2.50	0.329
20	17201	38.10	38.10	1.50	1.60	5.10	2.55	0.357
21	17207	50.80	38.10	1.50	1.50	4.00	-	0.381
22	17202	63.50	38.10	2.03	1.60	5.10	2.55	0.519

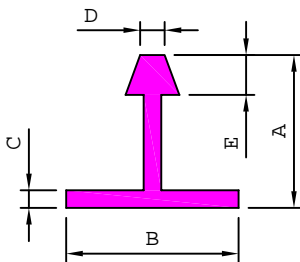
BULBED TEES - TAPERED HEAD

SL. No.	Section No.	A	B	C	D	E	Weight kg/m
1	17304	36.50	25.00	1.10	2.80	2.80	0.195
2	17302	36.50	25.00	1.60	2.80	2.80	0.270

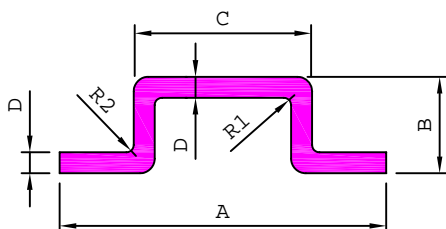
TOP HATS

SL. No.	Section No.	A	B	C	D	R1	R2	Weight kg/m
1	17459	34.00	7.15	12.50	1.20	--	--	0.148
2	17456	40.00	16.00	20.00	4.00	--	--	0.690
3	17452	57.15	28.50	23.81	2.39	0.50	0.50	0.706
4	17453	63.50	31.75	25.40	3.18	-	1.60	1.038
5	17455	88.90	44.45	44.45	3.18	3.18	3.18	1.495

STRUCTURAL

BULBED TEES & TOP HATS

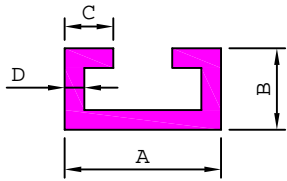

SL. No.	Section No.	A	B	C	D	Weight kg/m
1	17527	20.00	11.00	5.50	0.60	0.082
2	17506	20.84	11.70	5.92	1.00	0.140
3	17509	20.84	11.70	5.92	1.25	0.172
4	17512	20.84	11.70	5.92	1.62	0.216
5	17523	21.50	11.00	6.25	2.00	0.259
6	17522	22.00	10.00	4.00	1.00	0.124
7	17503	22.00	14.00	6.50	1.25	0.195
8	17570	22.50	14.00	6.75	1.00	0.163
9	17504	22.50	14.00	6.75	2.50	0.364
10	17651	32.00	18.00	8.25	3.00	0.587
11	17518	35.00	18.00	10.50	4.00	0.820

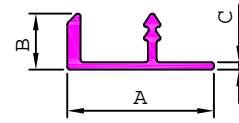

SL. No.	Section No.	A	B	C	Weight kg/m
1	17699	22.00	8.40	1.10	0.132
2	17698	24.00	8.40	1.10	0.138

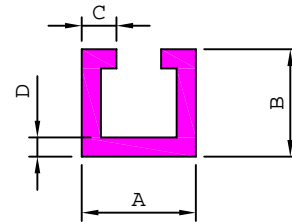

SL. No.	Section No.	A	B	C	D	Weight kg/m
1	17701	6.00	4.60	2.00	1.00	0.041
2	17696	14.10	21.10	4.90	2.80	0.415
3	17702	14.20	21.20	4.75	2.80	0.415
4	17566	17.50	17.50	5.75	1.20	0.190
5	17634	24.00	24.00	7.50	1.25	0.276

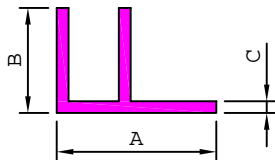

SL. No.	Section No.	A	B	C	Weight kg/m
1	17544	21.30	16.00	1.35	0.184
2	17719	21.50	16.00	0.75	0.105
3	S4977	23.00	15.00	2.00	0.264
4	17710	23.40	15.30	0.67	0.095
5	17555	23.40	15.30	0.97	0.136
6	17602	23.40	15.30	1.40	0.193
7	17697	25.00	16.00	1.30	0.191

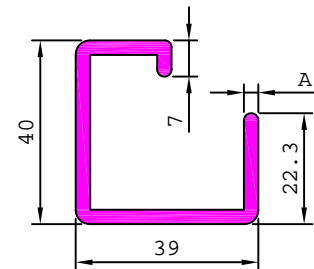

SL. No.	Section No.	A	Weight kg/m
1	17528	2.65	0.828
2	17532	1.95	0.621

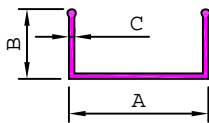

SL. No.	Section No.	A	B	R	Weight kg/m
1	17711	24.60	12.30	0.73	0.096
2	17579	24.60	12.30	0.95	0.123

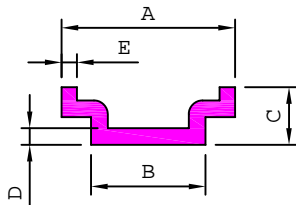

SL. No.	Section No.	A	B	C	D	E	Weight kg/m
1	17580	23.50	15.20	7.80	1.25	1.05	0.108
2	17558	24.50	15.80	7.80	1.55	1.10	0.126

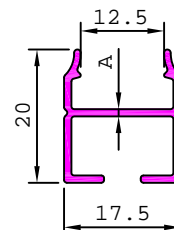

SL. No.	Section No.	A	Weight kg/m
1	17704	0.59	0.115
2	17638	0.70	0.134
3	17594	0.81	0.150
3	17569	1.10	0.195

STRUCTURAL

MISCELLANEOUS

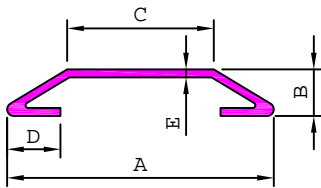

SL. No.	Section No.	A	B	C	D	E	Weight kg/m
1	17709	38.00	7.60	22.00	8.60	0.65	0.104
2	17617	38.00	7.60	22.00	8.60	0.70	0.112
3	17520	40.00	7.00	22.00	8.00	1.20	0.190
4	17703	60.00	9.00	43.00	9.50	0.66	0.151
5	17610	60.00	9.00	43.00	9.50	0.82	0.186
6	17519	63.00	9.00	40.00	10.00	1.60	0.364

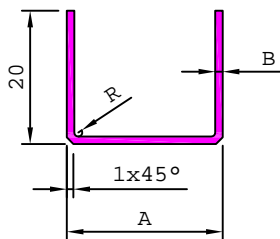

SL. No.	Section No.	A	B	R	Weight kg/m
1	17545	23.40	1.13	0.60	0.184
2	17539	23.90	1.65	0.80	0.268

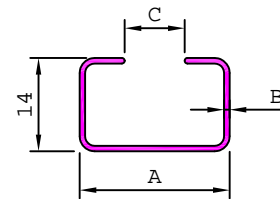

SL. No.	Section No.	A	B	C	Weight kg/m
1	17517	22.20	1.15	9.00	0.175
2	17647	22.50	0.70	9.00	0.109
3	17557	22.50	0.83	9.00	0.128

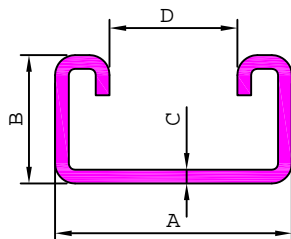

SL. No.	Section No.	A	B	C	D	Weight kg/m
1	17584	41.30	22.40	2.40	22.30	0.640
2	17582	41.30	41.30	2.40	22.30	0.885

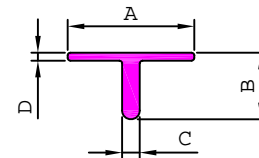

SL. No.	Section No.	A	B	C	D	Weight kg/m
1	17629	10.00	6.60	3.00	1.50	0.079
2	17626	12.90	6.60	3.00	1.50	0.091
3	17593	13.00	8.00	2.65	1.20	0.088
4	17627	15.90	7.80	3.00	1.40	0.109
5	17591	15.90	8.00	2.75	1.20	0.099
6	17592	19.00	10.00	2.65	1.20	0.122

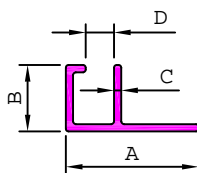

SL. No.	Section No.	A	B	C	D	Weight kg/m
1	17595	20.00	10.00	1.10	4.25	0.118
2	17624	19.90	9.90	1.30	4.20	0.137

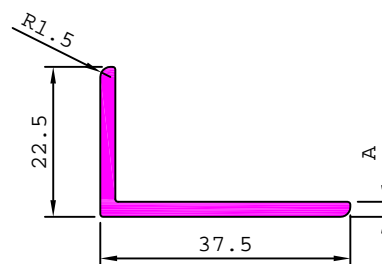

SL. No.	Section No.	A	Weight kg/m
1	17605	2.00	0.310
2	17606	2.25	0.348

STRUCTURAL

MISCELLANEOUS

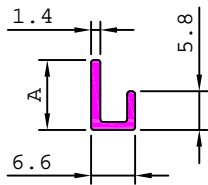

SL. No.	Section No.	A	Weight kg/m
1	17646	10.50	0.071
2	17645	14.00	0.084

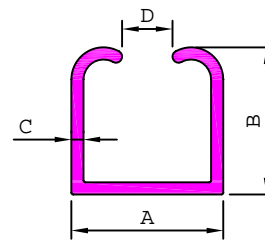

SL. No.	Section No.	A	B	C	D	Weight kg/m
1	17607	31.00	28.60	1.65	11.00	0.432
2	17611	33.10	32.10	2.65	11.00	0.741

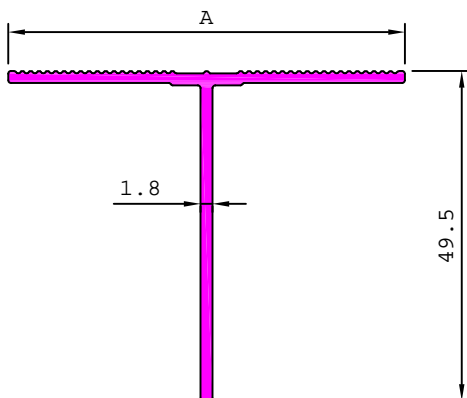

SL. No.	Section No.	A	Weight kg/m
1	22965	59.50	0.498
2	22966	119.50	0.761
3	22978	79.50	0.586
4	22977	99.50	0.674

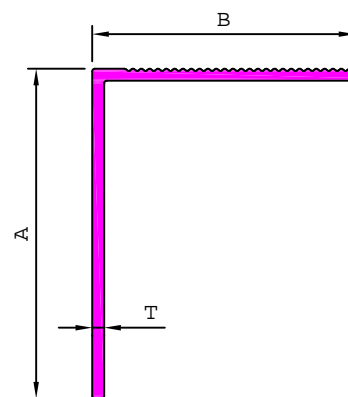

SL. No.	Section No.	A	B	T	Weight kg/m
1	23419	19.50	39.50	1.20	0.173
2	22964	49.50	39.50	1.80	0.407
3	22975	59.50	49.50	1.20	0.328

S4295

1.113 kg/m

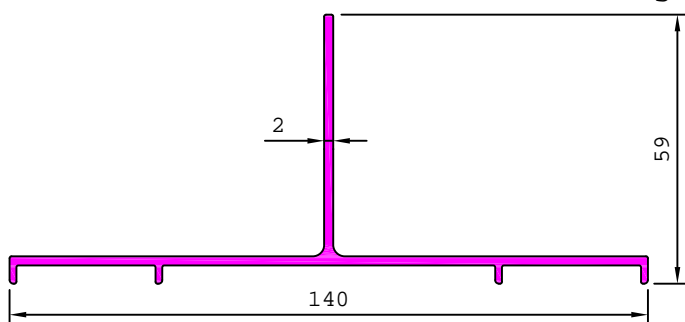

27679

1.185 kg/m

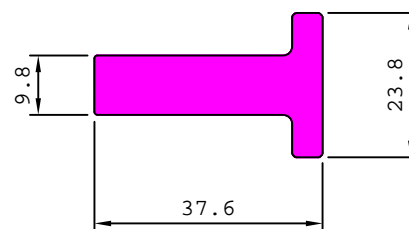

TEES - ROUND FILLET TOES

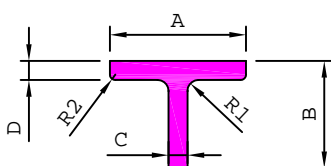

SL. No.	Section No.	A	B	C	D	R1	R2	Weight kg/m
1	16305	24.50	24.00	2.07	2.07	1.00	-	0.260
2	16304	24.50	24.00	2.40	2.40	2.50	-	0.306
3	16303	24.50	24.65	2.70	3.00	2.75	-	0.364
4	16301	25.40	25.40	3.18	3.18	4.57	3.00	0.422
5	16311	30.00	105.00	3.00	3.00	2.00	-	1.073
6	16308	38.00	38.00	4.00	4.00	4.00	-	0.796
7	16310	50.00	50.00	5.00	5.00	4.00	-	1.300
8	16307	80.00	150.00	5.00	8.00	4.00	1.00	3.660
9	16309	80.00	235.00	6.50	10.00	4.00	1.00	6.124

STRUCTURAL

MISCELLANEOUS

29589

1.498 kg/m

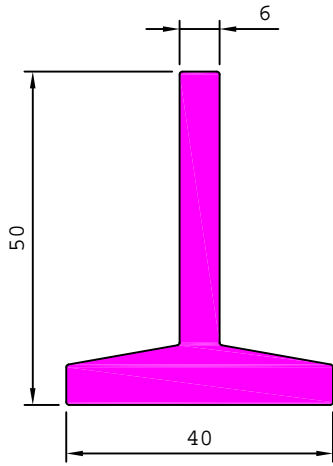

29590

3.118 kg/m

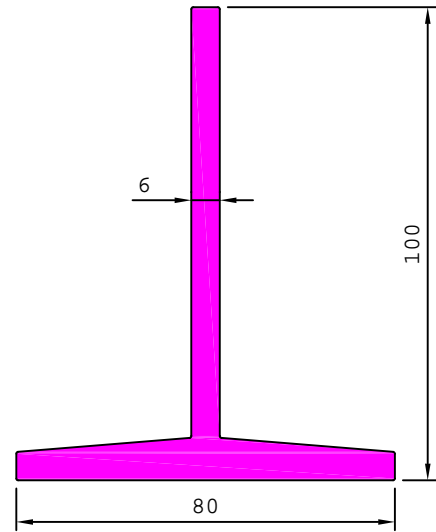

29293

0.256 kg/m

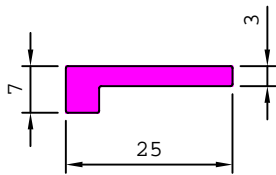

29561

3.747 kg/m

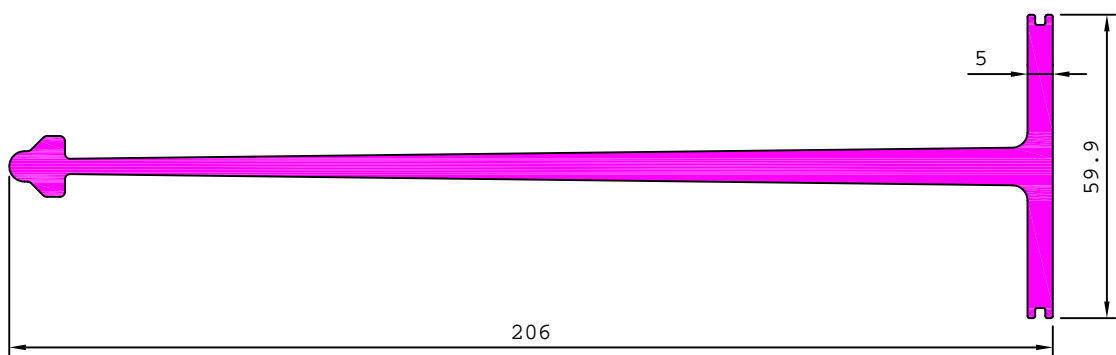

STRUCTURAL

MISCELLANEOUS

16770 2.984 kg/m

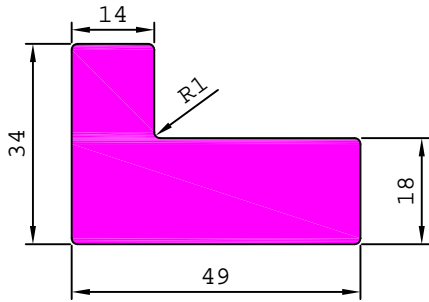

17102 0.212 kg/m

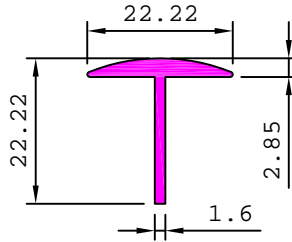

17502 0.036 kg/m

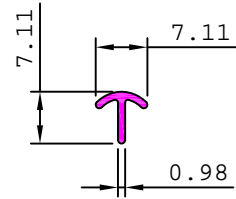

17511 0.151 kg/m

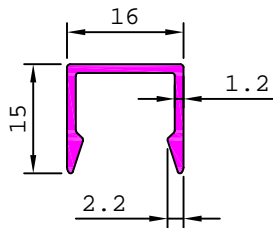

17515 0.283 kg/m

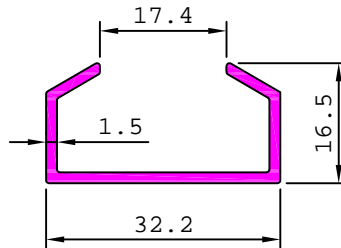

17508 0.175 kg/m

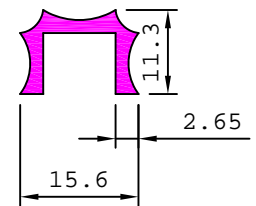

17529 0.891 kg/m

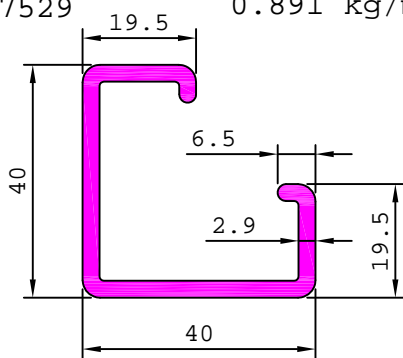

17533 0.133 kg/m

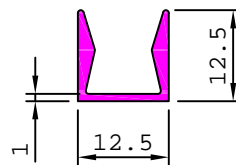

17537 0.742 kg/m

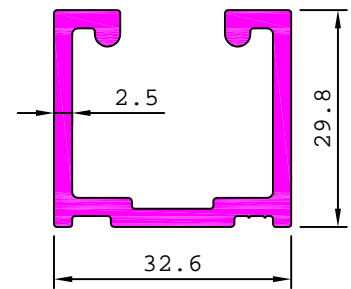

17538 0.381 kg/m

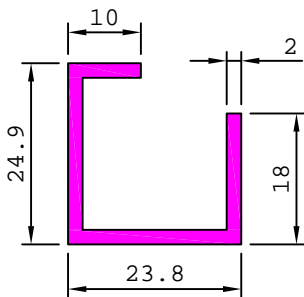

17541 0.231 kg/m

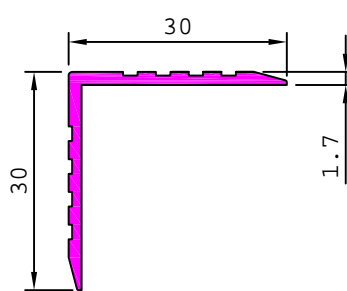

17546 1.000 kg/m

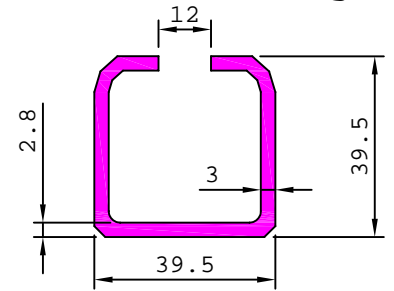

17547 0.673 kg/m

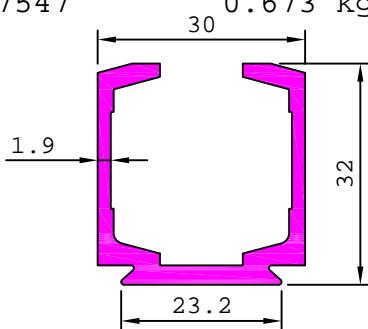

17549 0.360 kg/m

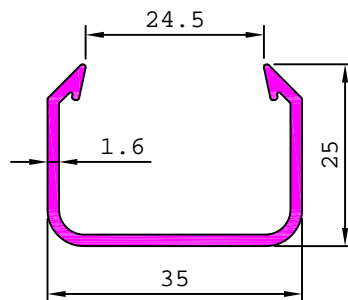

17550 0.720 kg/m

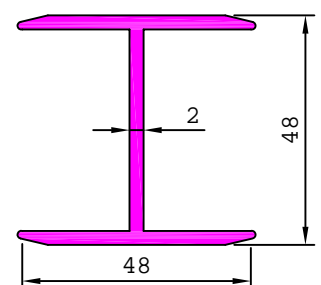

STRUCTURAL

MISCELLANEOUS

<p>17551 0.628 kg/m</p>	<p>17552 0.538 kg/m</p>	<p>17553 0.209 kg/m</p>	
<p>17554 0.309 kg/m</p>	<p>17556 0.628 kg/m</p>	<p>17572 0.657 kg/m</p>	
<p>17564 0.385 kg/m</p>		<p>17565 0.389 kg/m</p>	
<p>17573 0.300 kg/m</p>	<p>17574 0.203 kg/m</p>	<p>17576 0.193 kg/m</p>	
<p>17578 0.043 kg/m</p>	<p>17585 0.226 kg/m</p>	<p>17588 0.605 kg/m</p>	

STRUCTURAL

MISCELLANEOUS

17586 0.523 kg/m

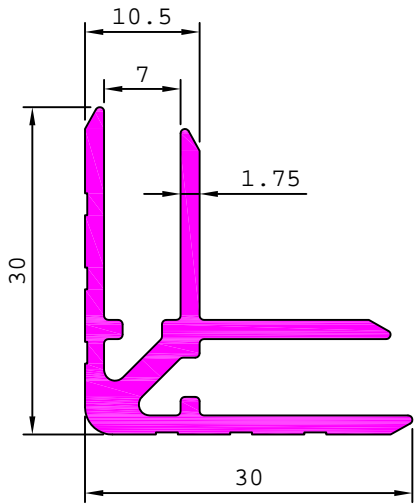

17587 1.147 kg/m

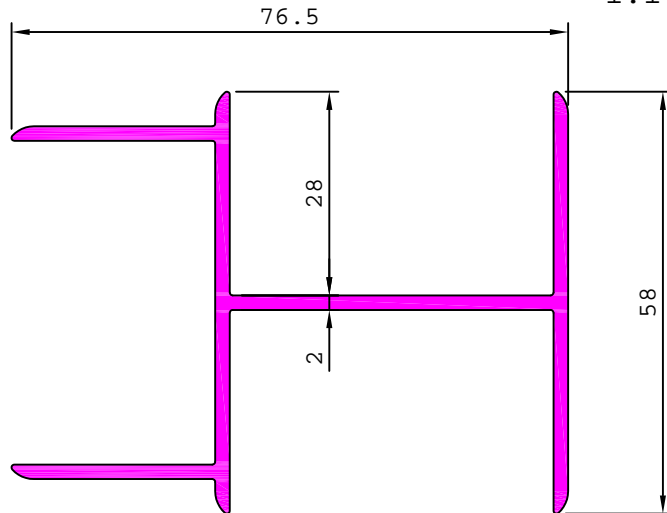

17590 0.584 kg/m

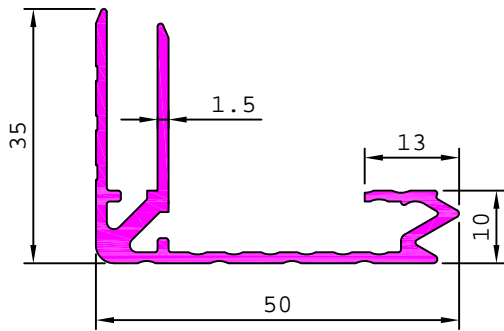

17597 1.853 kg/m

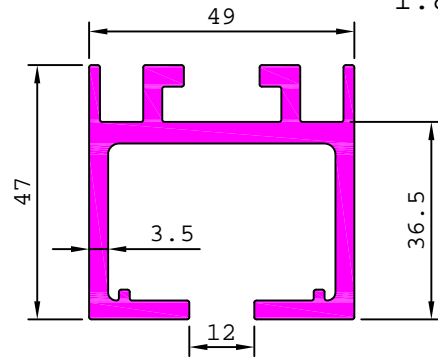

17601 0.112 kg/m

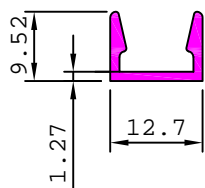

17603 0.249 kg/m

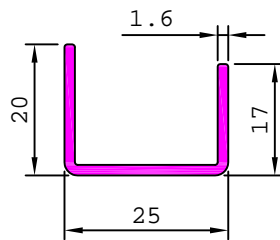

17604 0.204 kg/m

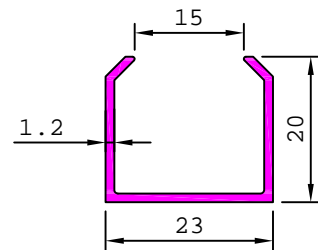

17608 0.288 kg/m

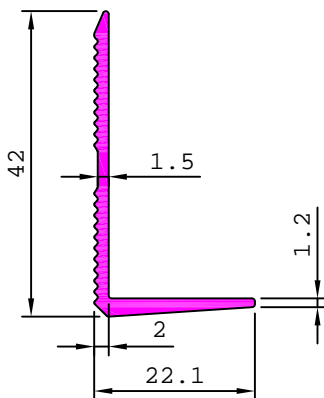

17609 0.561 kg/m

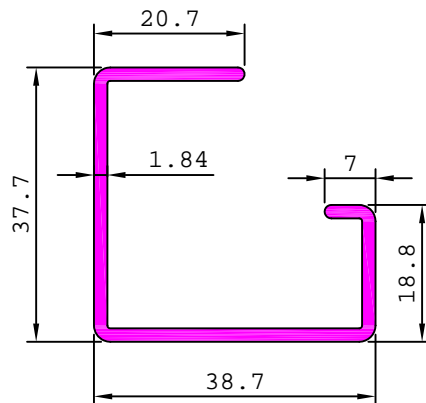

17612 0.146 kg/m

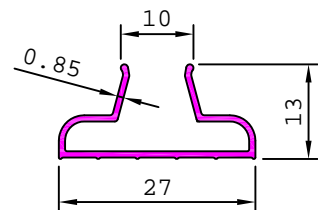

STRUCTURAL

MISCELLANEOUS

17614 0.162 kg/m

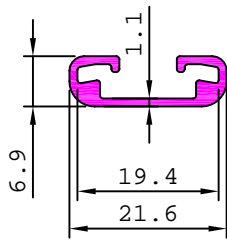

17615 0.597 kg/m

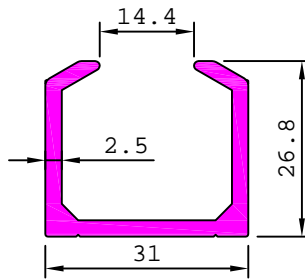

17619 0.331 kg/m

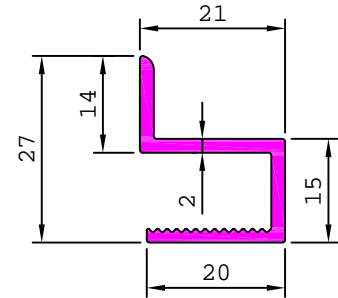

17618 0.762 kg/m

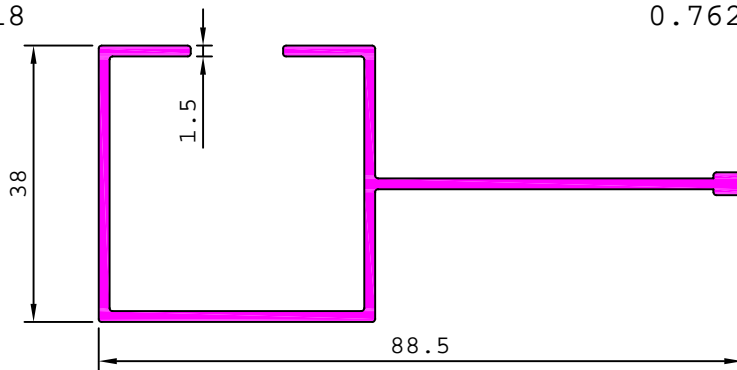

17630 0.632 kg/m

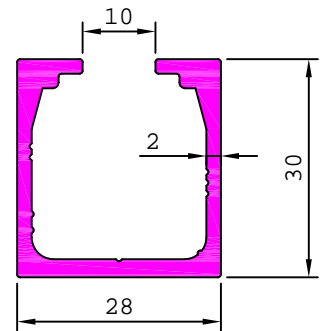

17625 0.096 kg/m

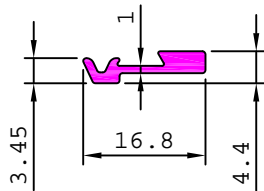

17635 0.123 kg/m

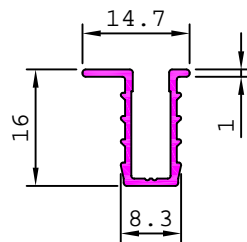

17642 0.169 kg/m

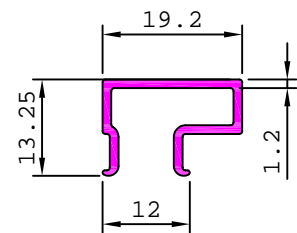

17641 1.190 kg/m

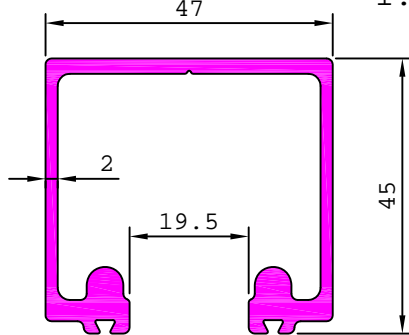

17652 1.540 kg/m

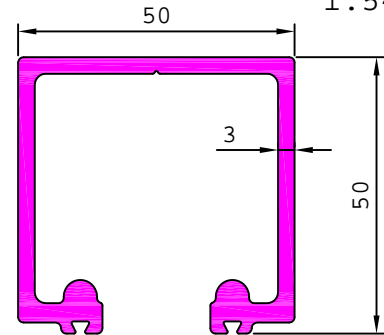

17644 0.218 kg/m

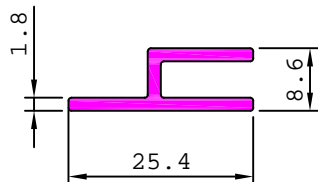

17648 0.221 kg/m

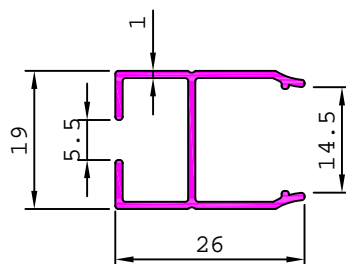

17654 1.435 kg/m

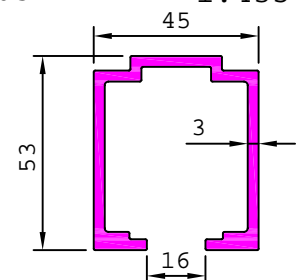

STRUCTURAL

MISCELLANEOUS

17655

4.275 kg/m

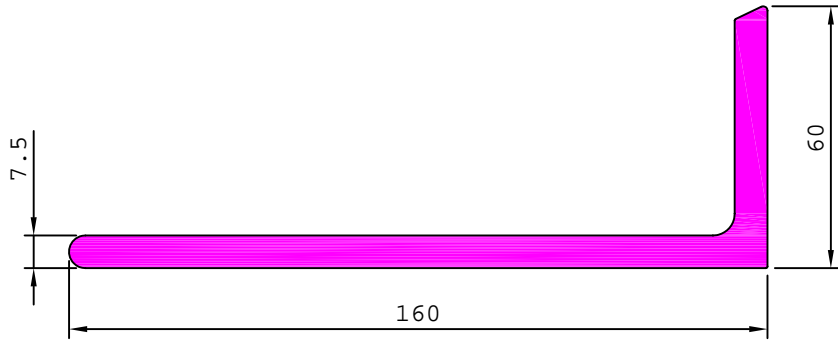

17656

1.761 kg/m

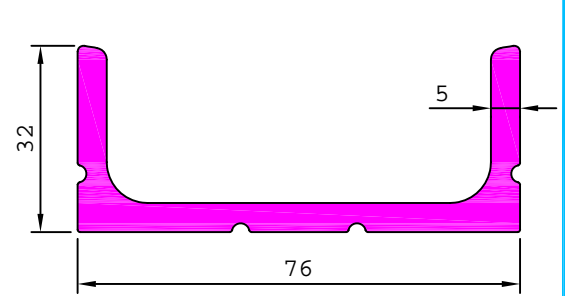

17657

0.509 kg/m

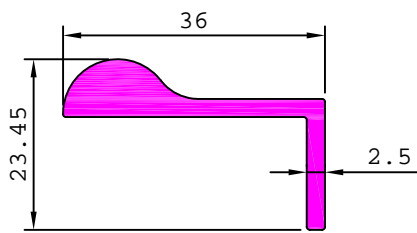

17658

0.495 kg/m

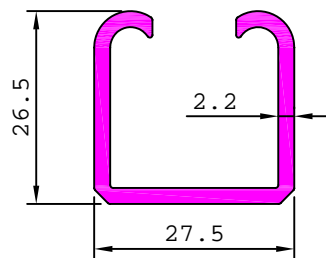

17659

0.207 kg/m

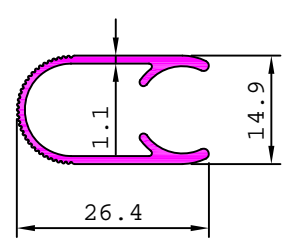

17660

0.222 kg/m

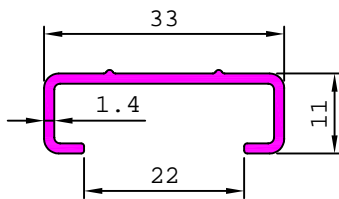

17661

0.702 kg/m

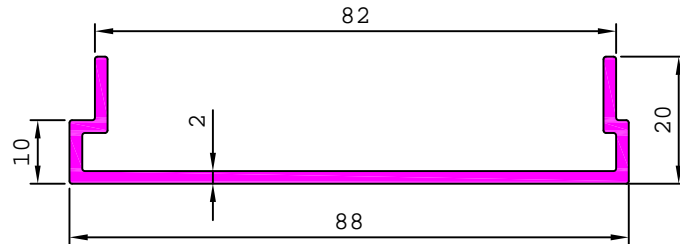

17662

0.953 kg/m

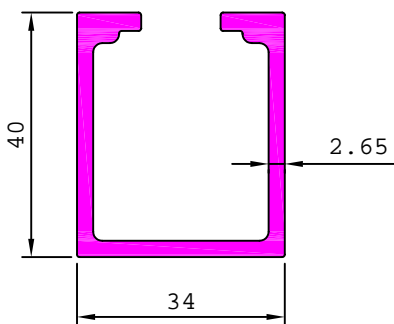

17664

0.248 kg/m

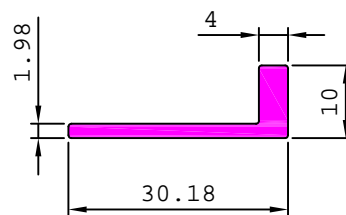

17670

0.852 kg/m

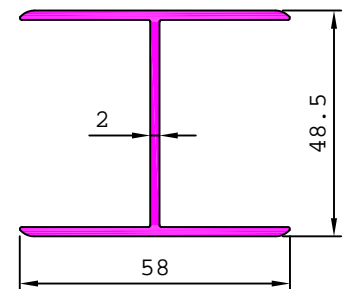

17665

0.133 kg/m

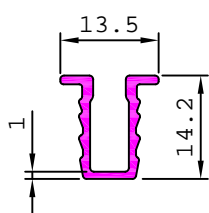

17666

0.245 kg/m

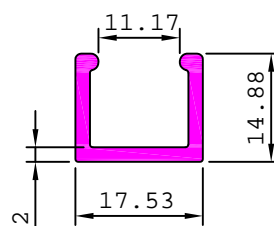

17667

0.090 kg/m

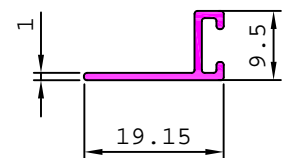

STRUCTURAL

MISCELLANEOUS

17668 0.237 kg/m

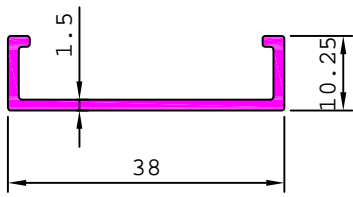

17669 0.108 kg/m

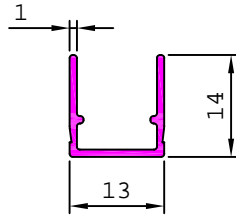

17675 0.237 kg/m

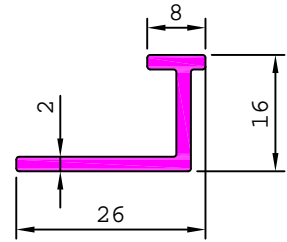

17671 0.712 kg/m

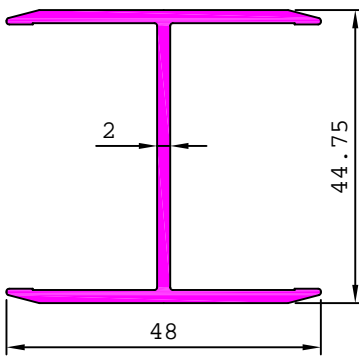

17672 0.618 kg/m

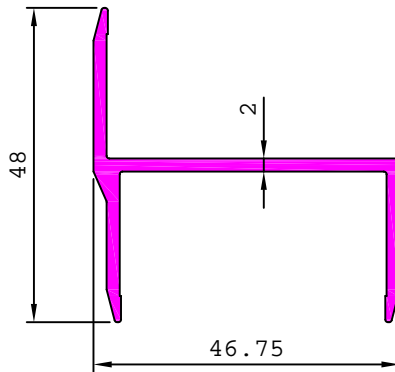

17673 0.525 kg/m

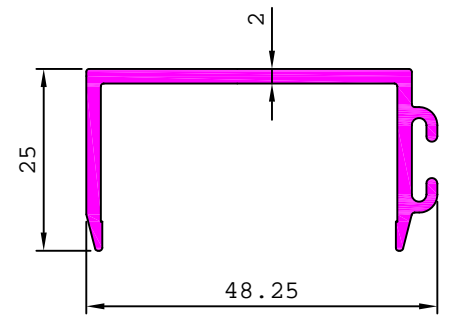

17676 0.619 kg/m

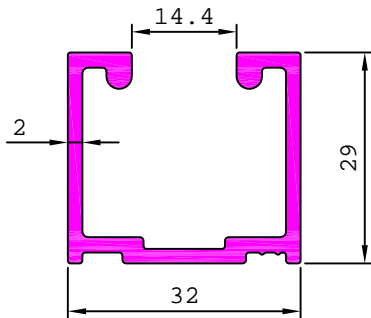

17677 1.038 kg/m

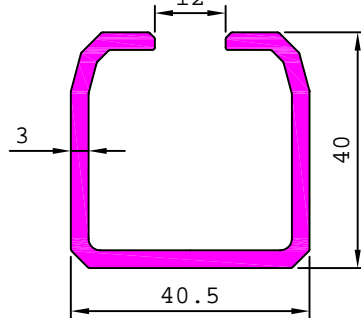

17678 0.241 kg/m

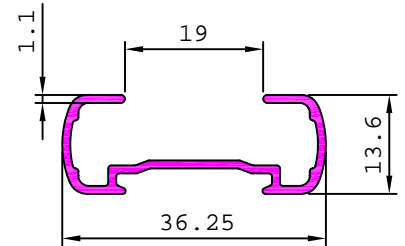

17680 0.108 kg/m

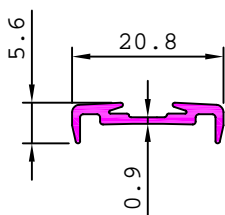

17681 0.114 kg/m

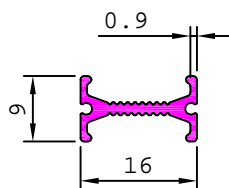

17682 1.483 kg/m

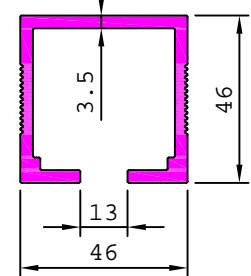

17683 0.801 kg/m

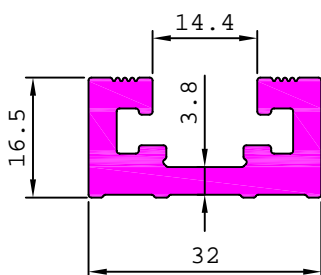

17684 0.155 kg/m

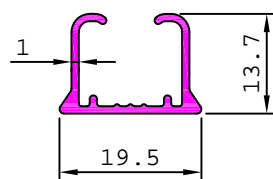

17685 0.184 kg/m

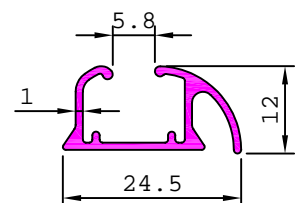

STRUCTURAL

MISCELLANEOUS

17679

0.618 kg/m

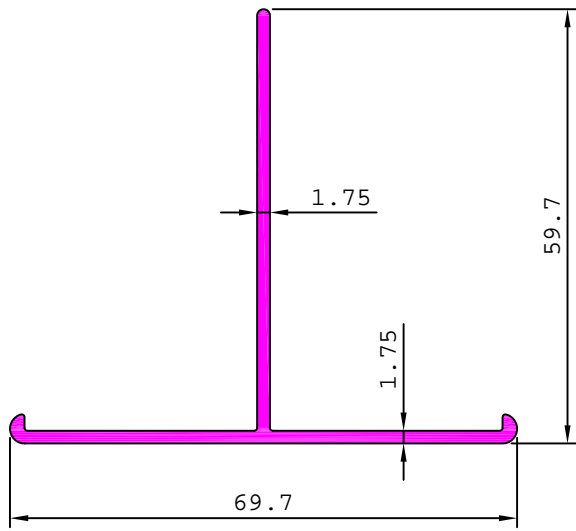

17686

1.261 kg/m

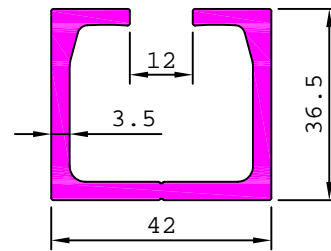

17688

2.142 kg/m

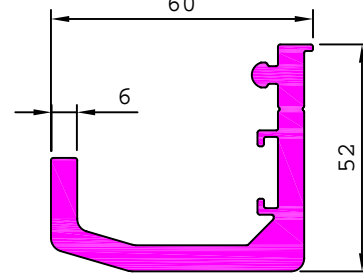

17689

1.890 kg/m

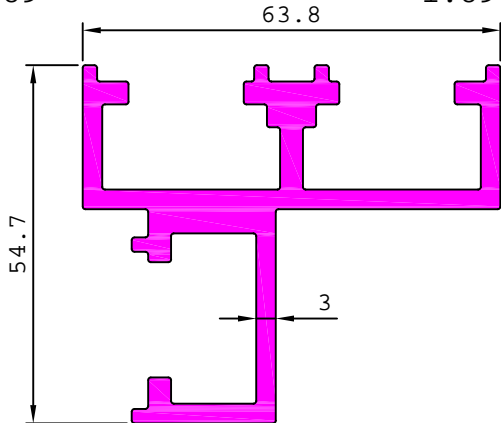

17690

1.820 kg/m

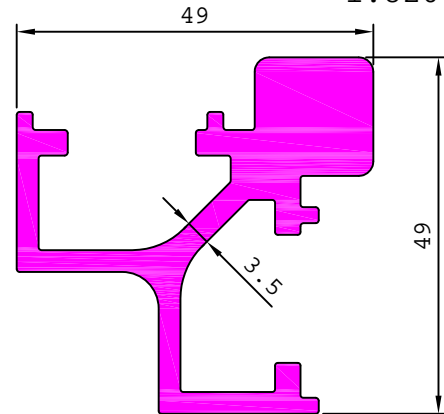

17691

2.243 kg/m

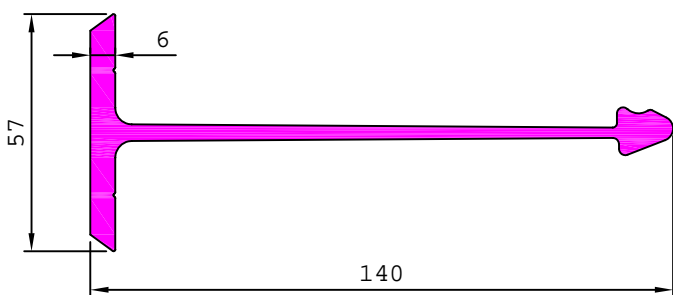

17692

2.024 kg/m

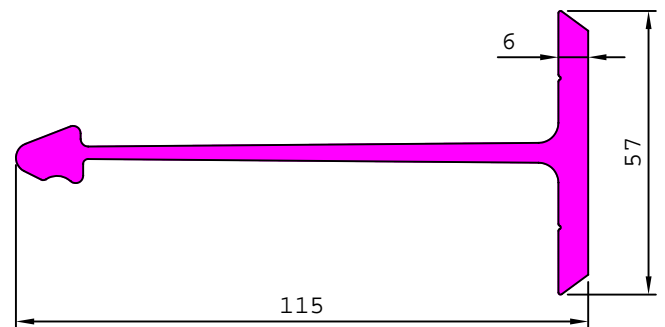

17693

0.124 kg/m

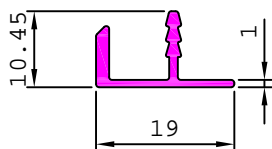

17700

0.136 kg/m

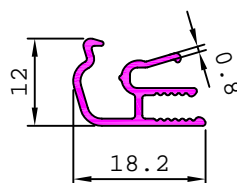

17706

0.078 kg/m

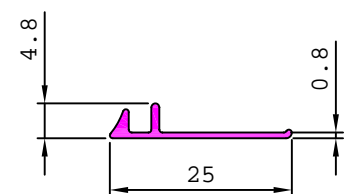

STRUCTURAL

MISCELLANEOUS

17694

0.736 kg/m

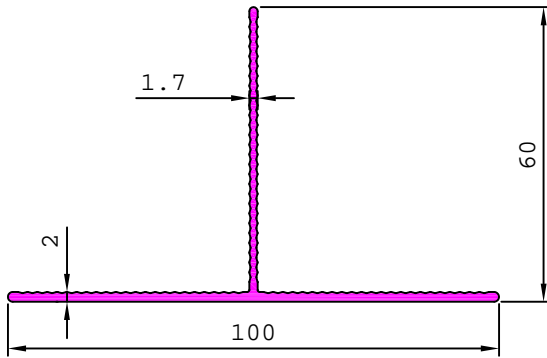

17695

0.481 kg/m

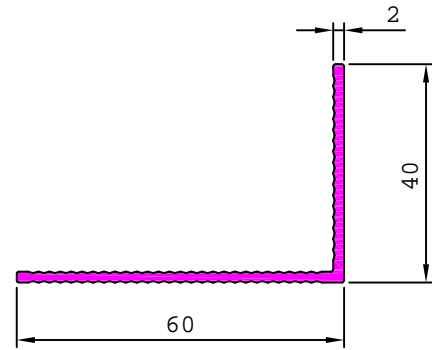

17705

0.200 kg/m

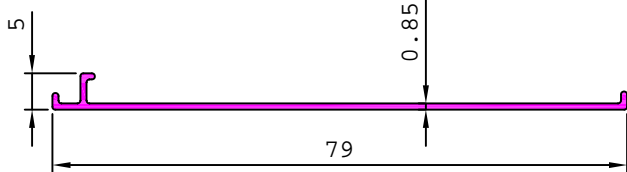

17707

1.223 kg/m

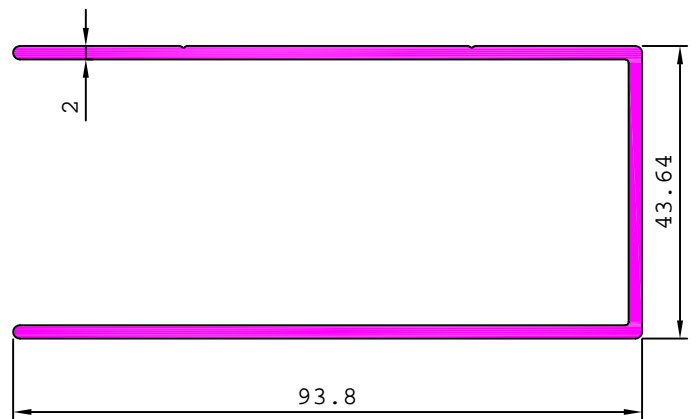

17708

0.188 kg/m

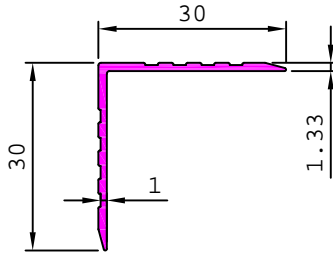

17712

0.652 kg/m

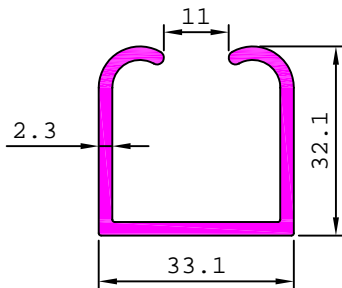

17713

0.325 kg/m

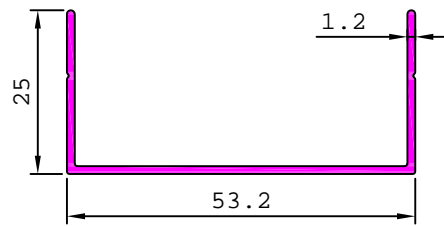

17714

0.648 kg/m

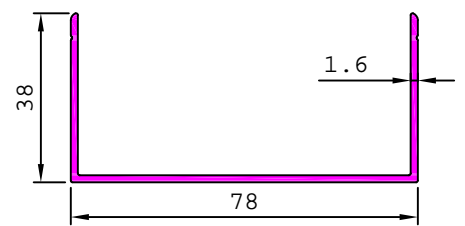

17715

0.873 kg/m

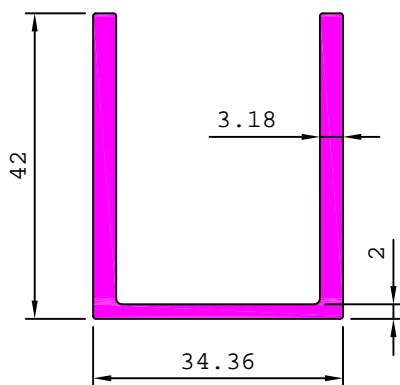

17716

0.186 kg/m

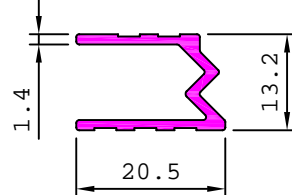

17724

0.171 kg/m

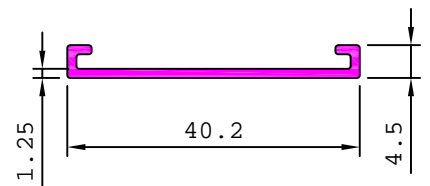

17722

0.110 kg/m

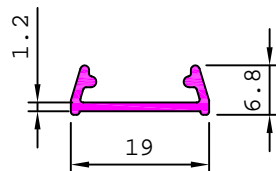

29308

0.112 kg/m

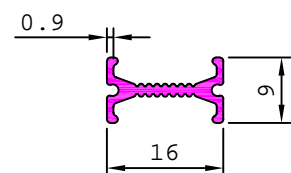

STRUCTURAL

MISCELLANEOUS

17721

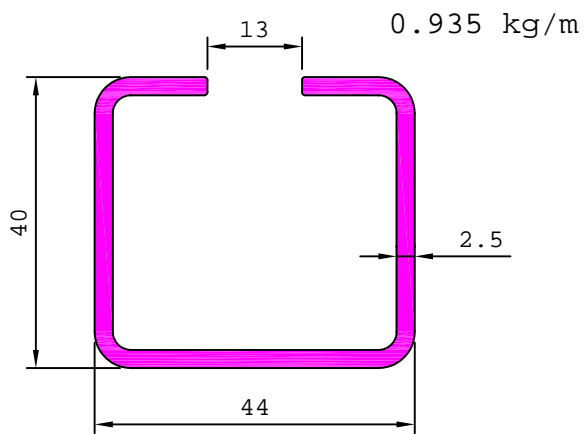

17718

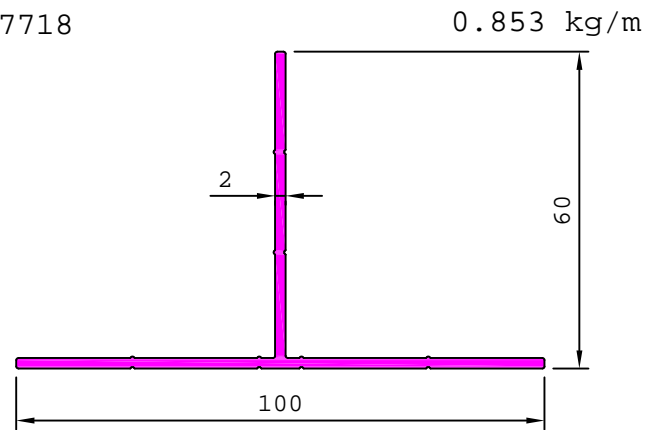

17726

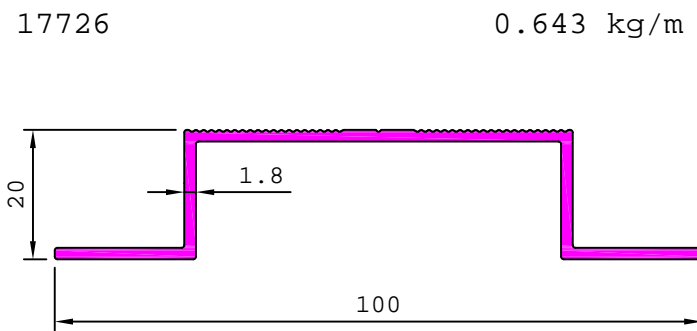

17725

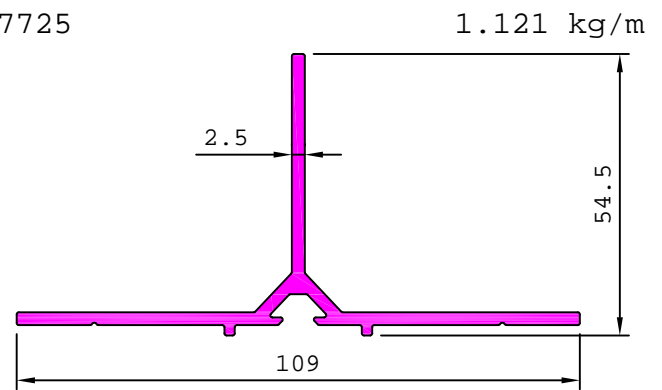

17723

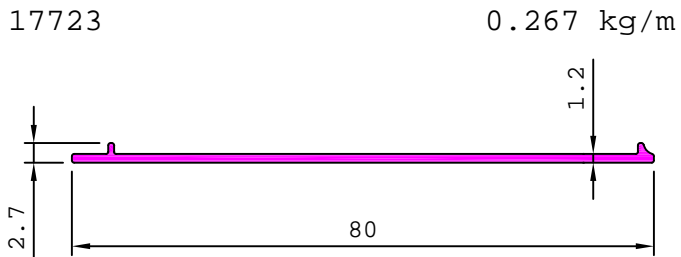

17727

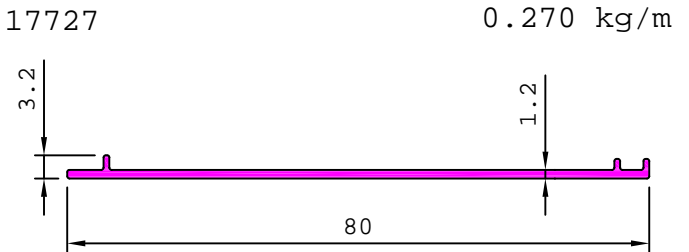

17728

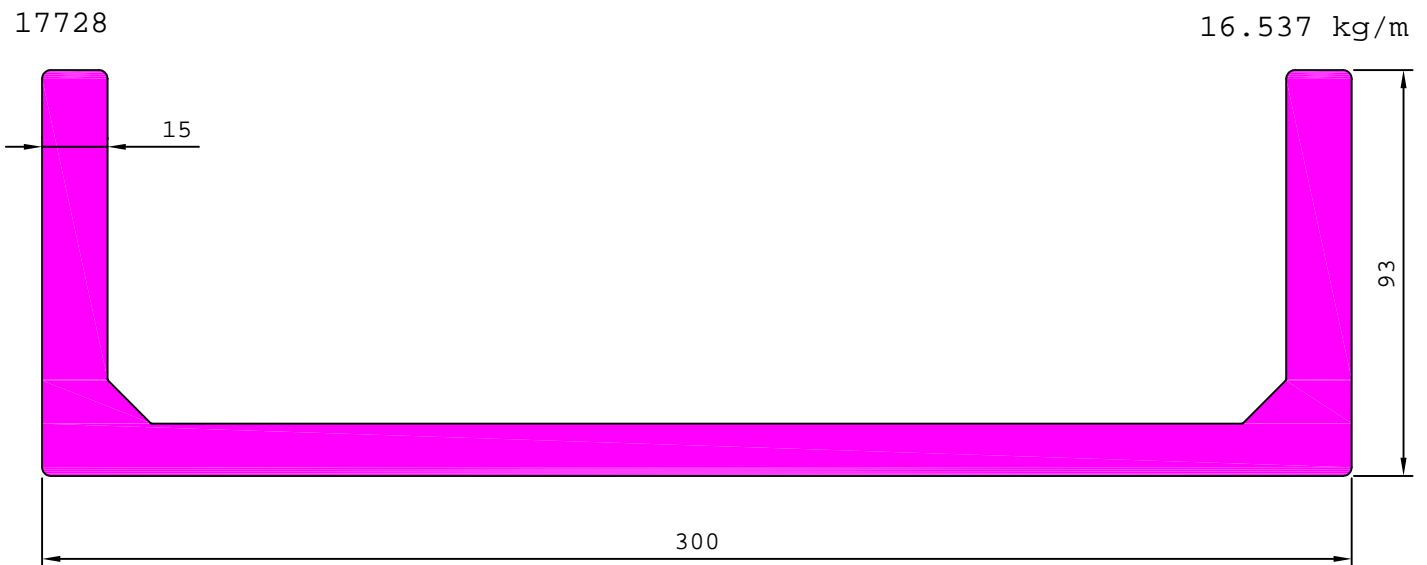

STRUCTURAL

MISCELLANEOUS

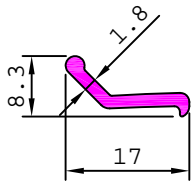
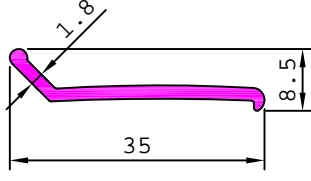
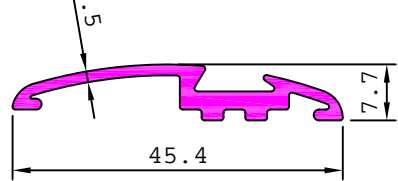
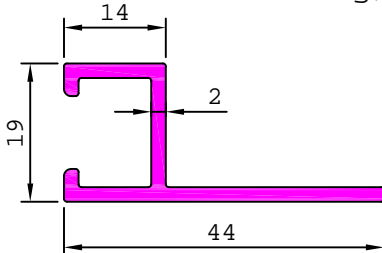
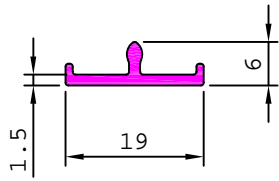
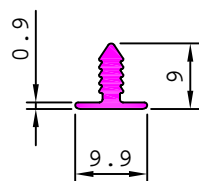
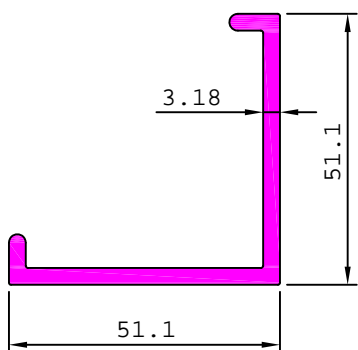
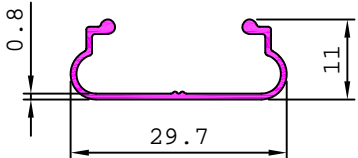
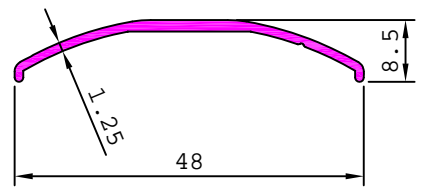
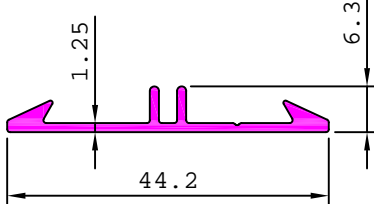
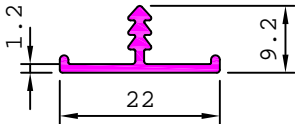
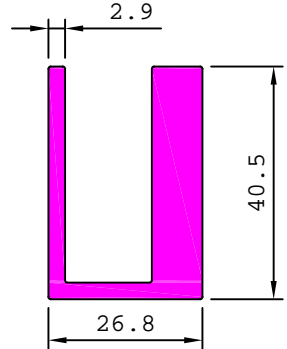
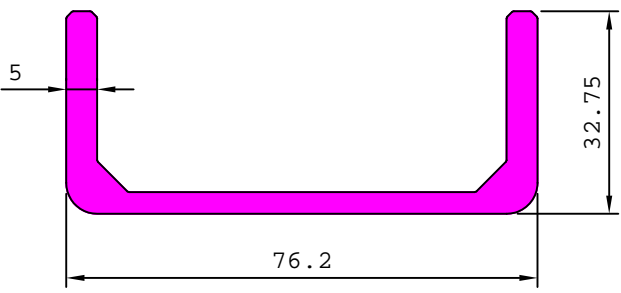
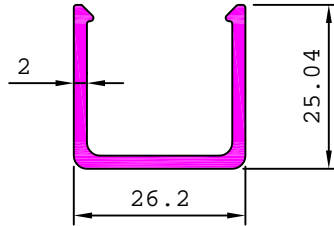
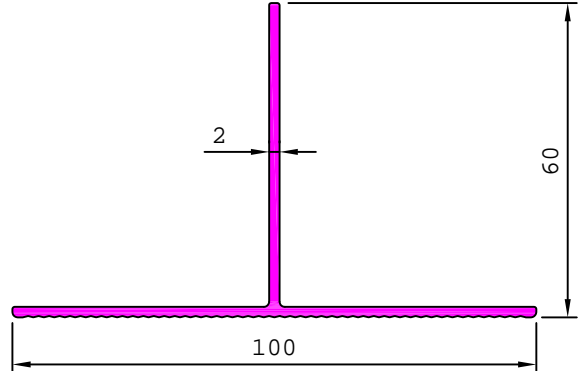
<p>29364 0.099 kg/m</p> 	<p>29365 0.185 kg/m</p> 	<p>29366 0.317 kg/m</p> 
<p>29378 0.420 kg/m</p> 	<p>29379 0.105 kg/m</p> 	<p>29436 0.081 kg/m</p> 
<p>29381 0.953 kg/m</p> 	<p>29517 0.128 kg/m</p> 	<p>34509 0.190 kg/m</p> 
<p>34510 0.232 kg/m</p> 	<p>34557 0.120 kg/m</p> 	<p>27828 1.397 kg/m</p> 
<p>27884 1.543 kg/m</p> 	<p>22936 0.395 kg/m</p> 	<p>22943 0.820 kg/m</p> 

STRUCTURAL

MISCELLANEOUS

29376 0.168 kg/m

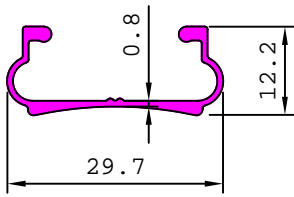

29377 0.274 kg/m

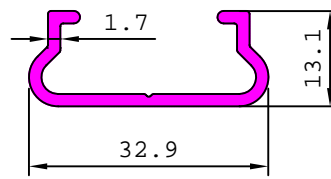

S4115 0.188 kg/m

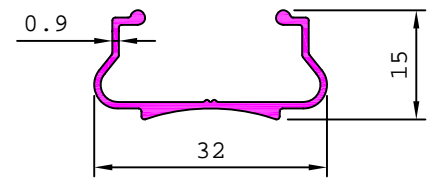

29509 0.137 kg/m

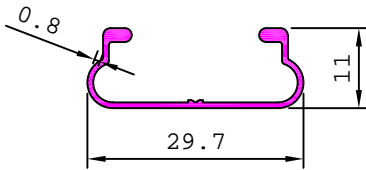

S5029 0.211 kg/m

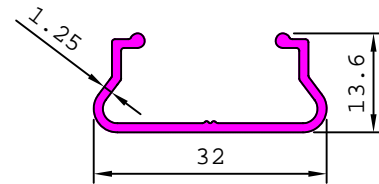

S4161 2.546 kg/m

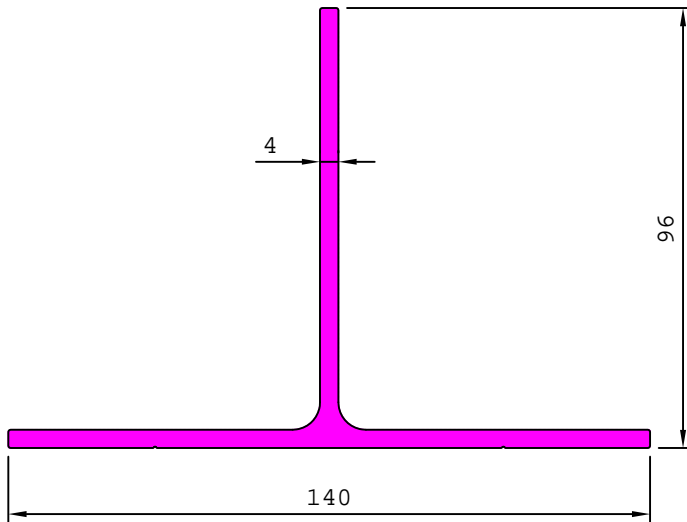

29547 0.301 kg/m

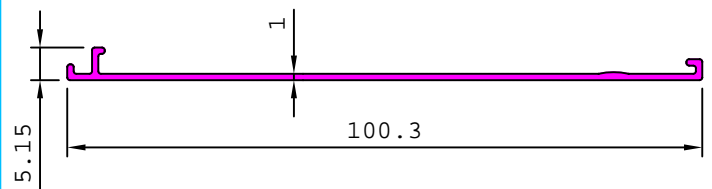

S4504 1.417 kg/m

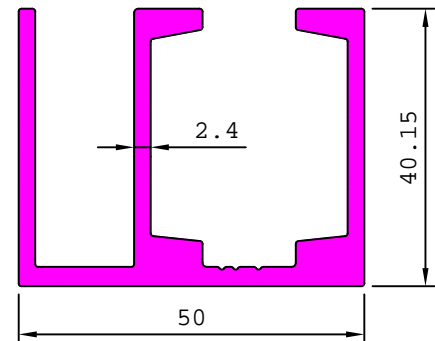

S4874 1.938 kg/m

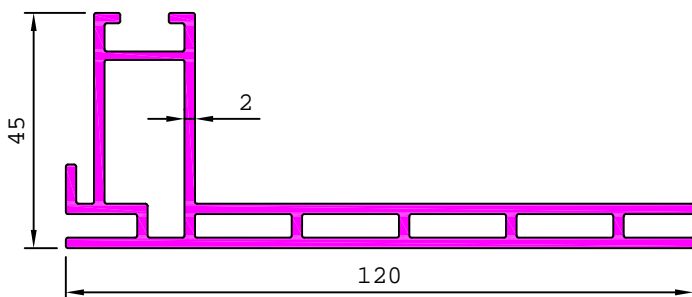

S4875 0.577 kg/m

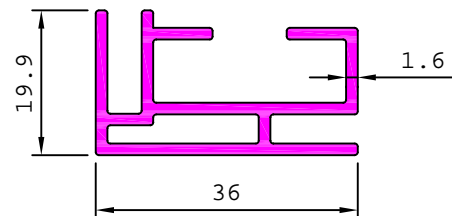

STRUCTURAL

MISCELLANEOUS

29539

1.632 kg/m

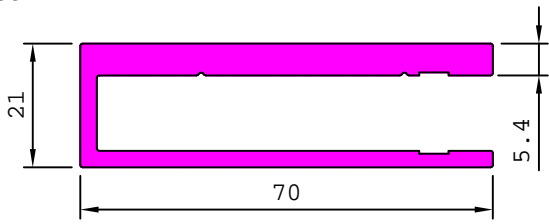

38534

0.141 kg/m

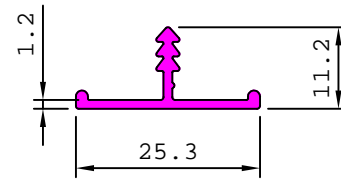

S4278

0.230 kg/m

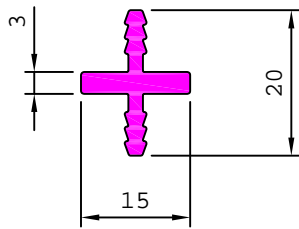

S4476

0.088 kg/m

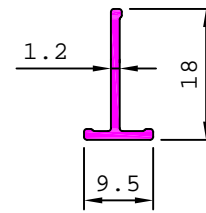

S4861

15.109 kg/m

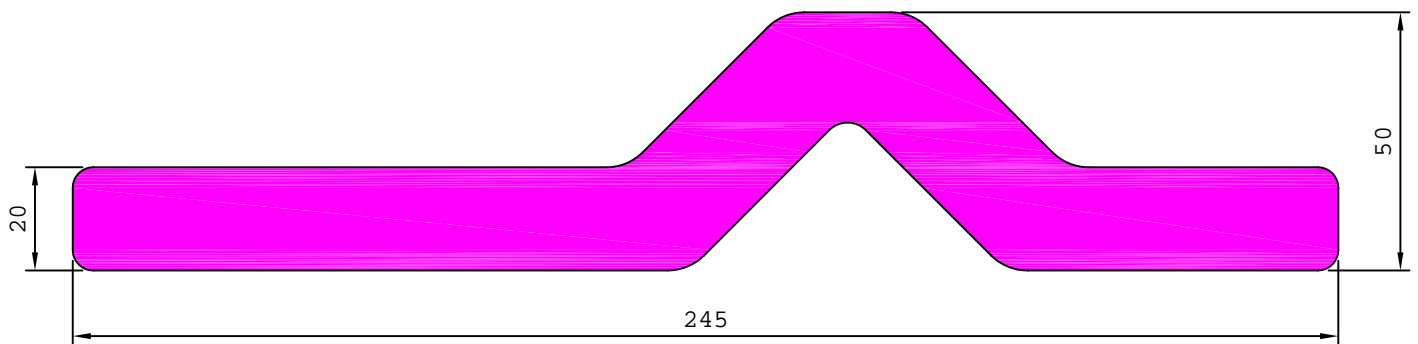

S4862

19.704 kg/m

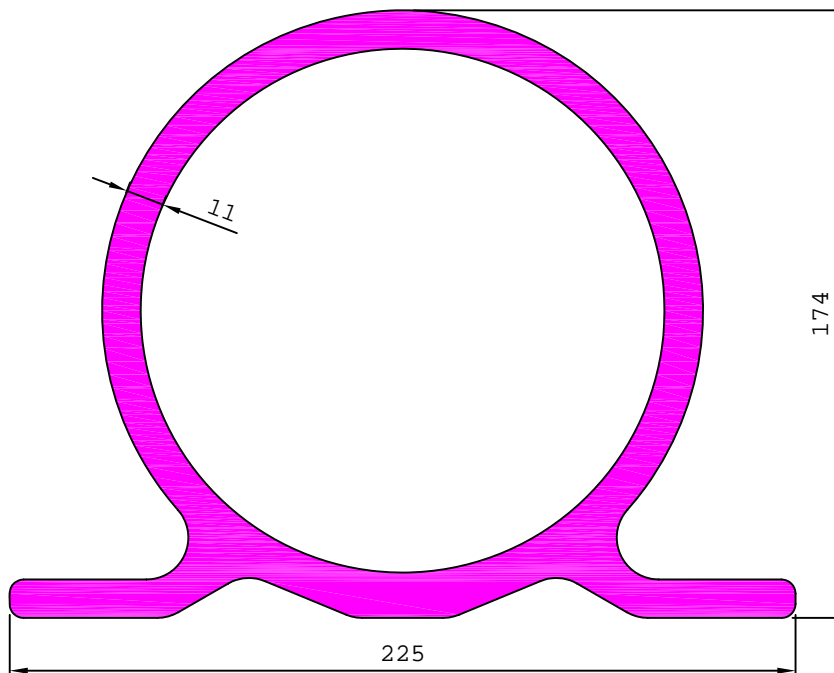

STRUCTURAL

MISCELLANEOUS

S5053

16.884 kg/m

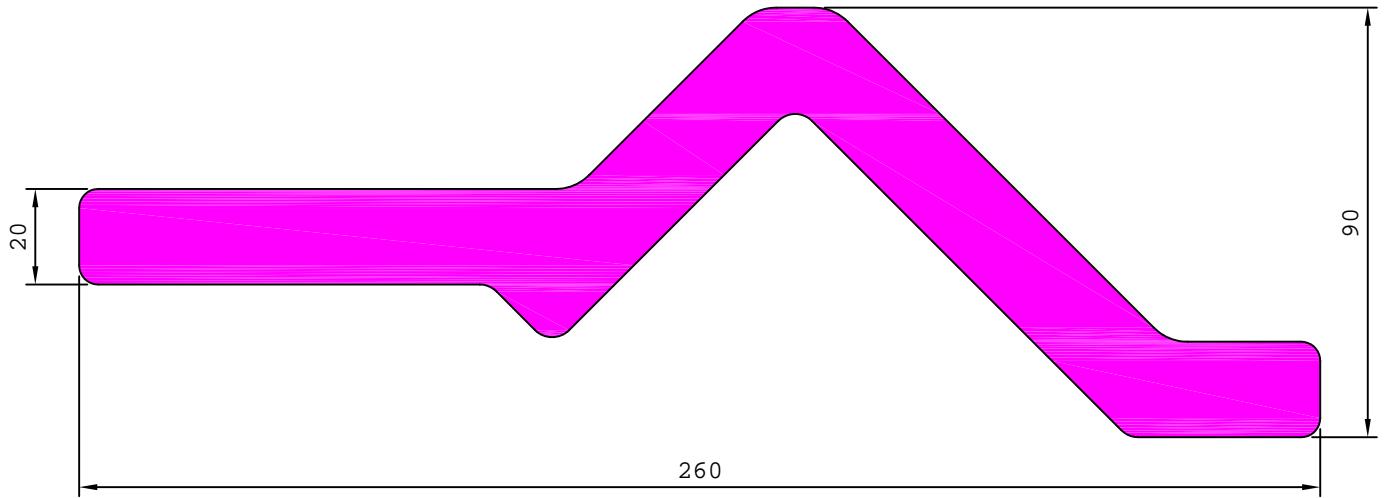

S4296

0.493 kg/m

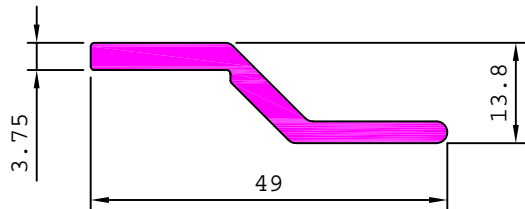

S4297

0.706 kg/m

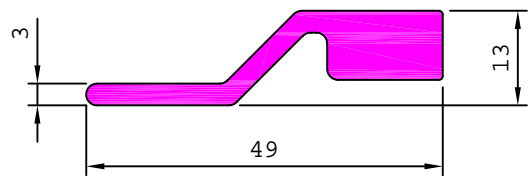

S4298

1.385 kg/m

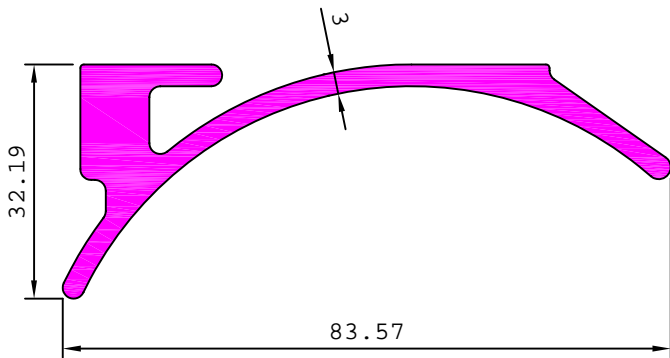

S4299

2.184 kg/m

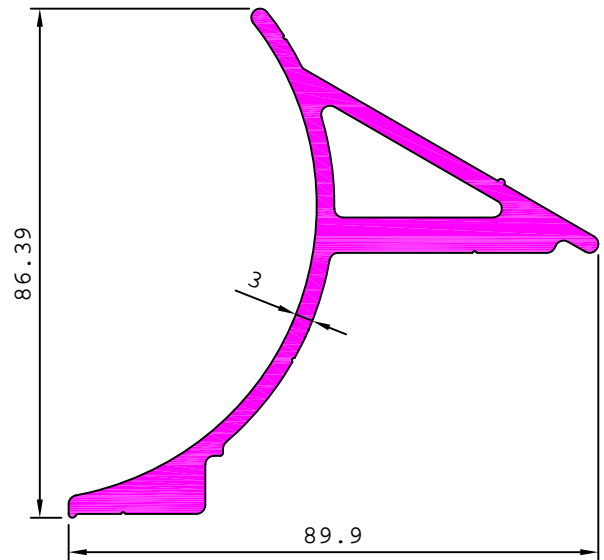

S4502

0.555 kg/m

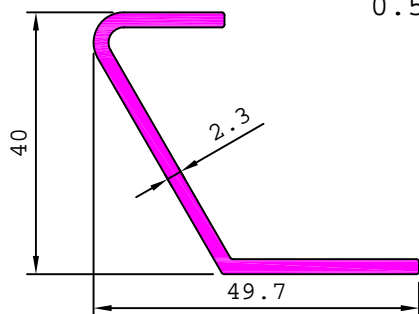

S4501

0.839 kg/m

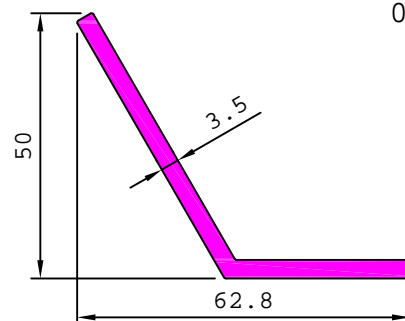

STRUCTURAL

MISCELLANEOUS

S4513

0.633 kg/m

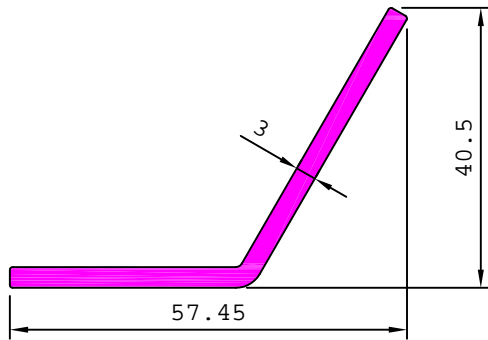

S4514

0.646 kg/m

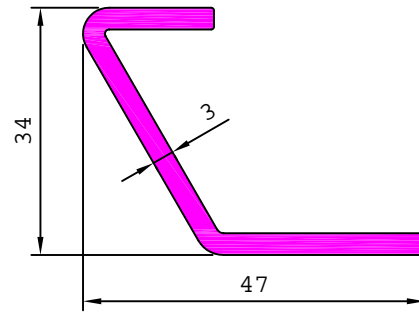

S4768

0.268 kg/m

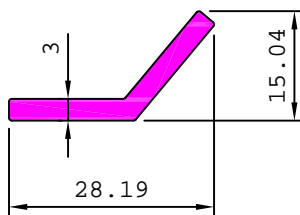

S4769

0.330 kg/m

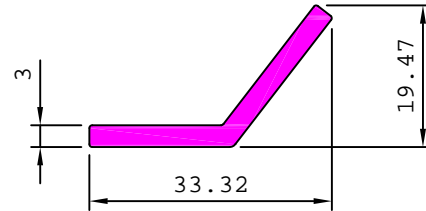

S4770

0.854 kg/m

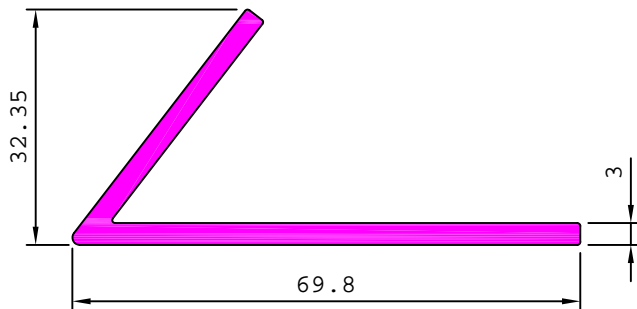

S4776

0.345 kg/m

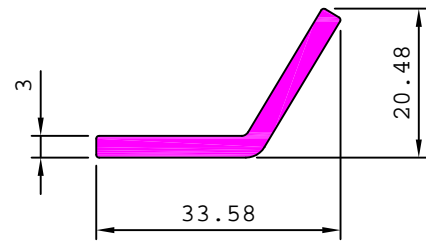

S4775

0.710 kg/m

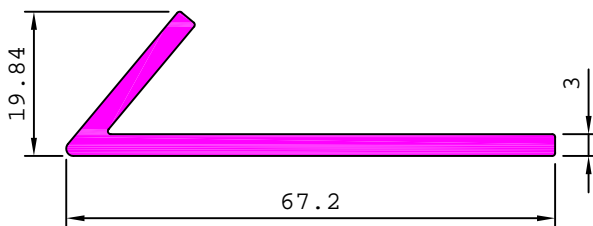

S4777

0.344 kg/m

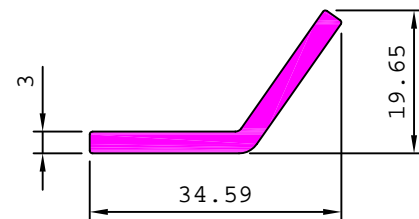

S4778

0.348 kg/m

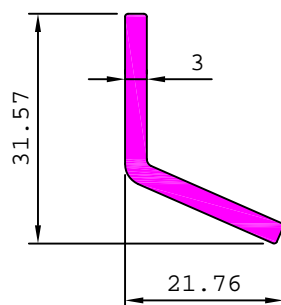

S4779

0.835 kg/m

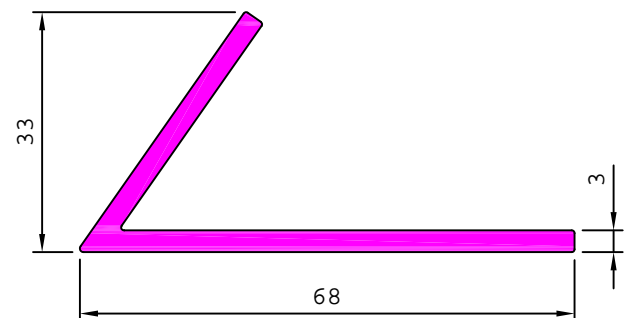

STRUCTURAL

MISCELLANEOUS

S4780

0.372 kg/m

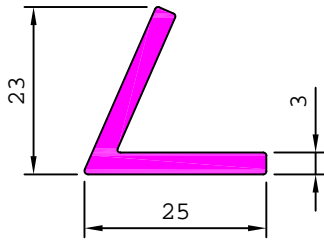

S4959

1.488 kg/m

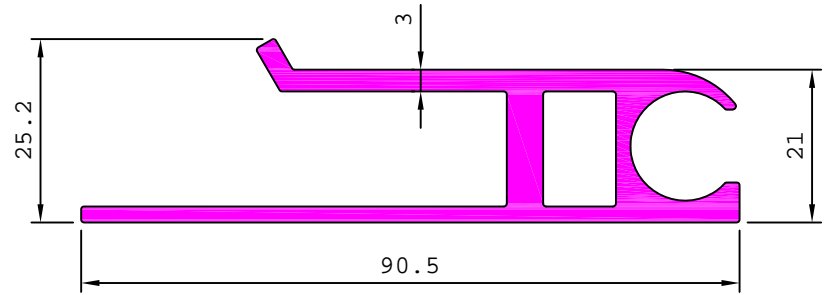

28137

0.255 kg/m

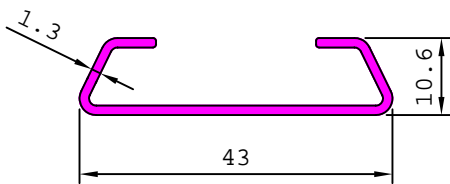

S4545

0.429 kg/m

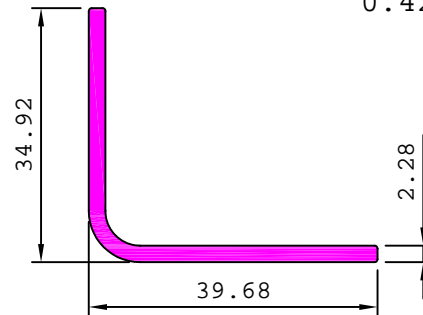

S4766

0.707 kg/m

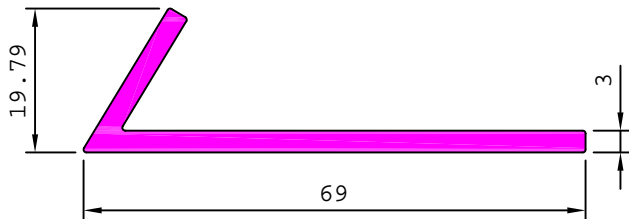

S4319

1.267 kg/m

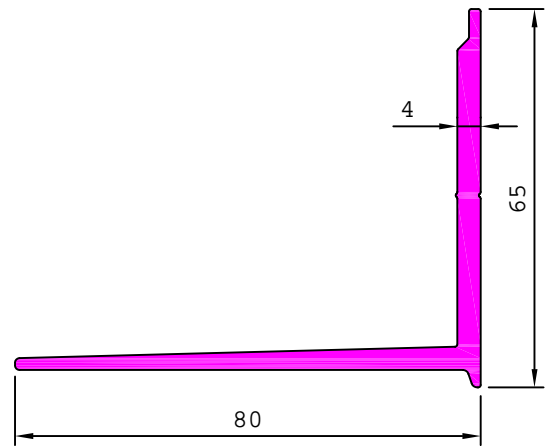

28848

1.664 kg/m

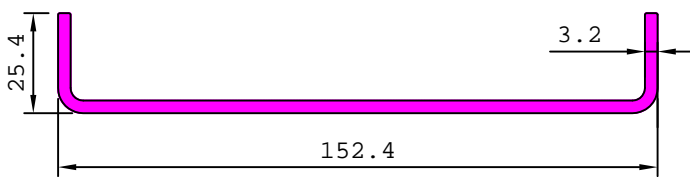

28923

0.480 kg/m

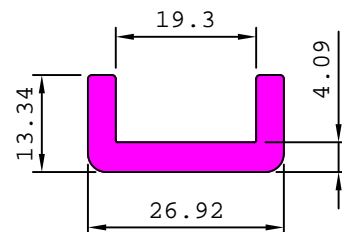

28877

0.265 kg/m

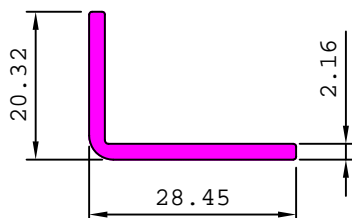

29634

0.210 kg/m

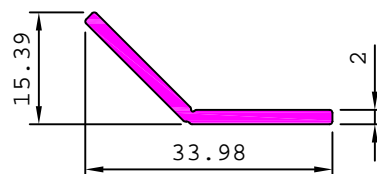

STRUCTURAL

MISCELLANEOUS

29451

0.901 kg/m

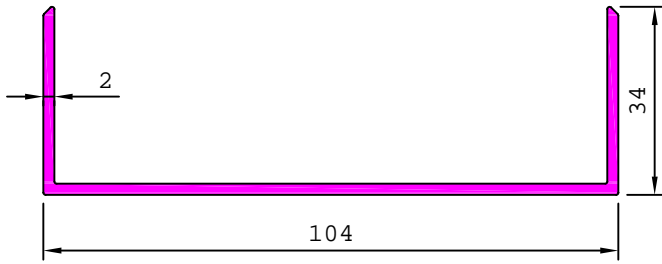

29584

0.793 kg/m

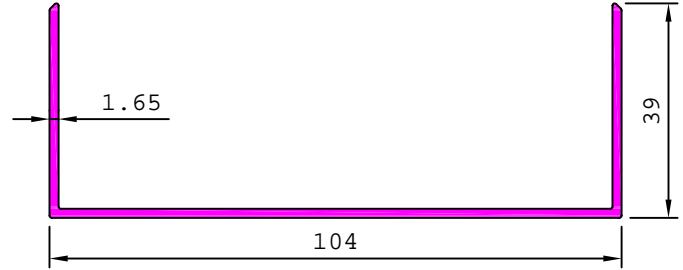

29637

2.046 kg/m

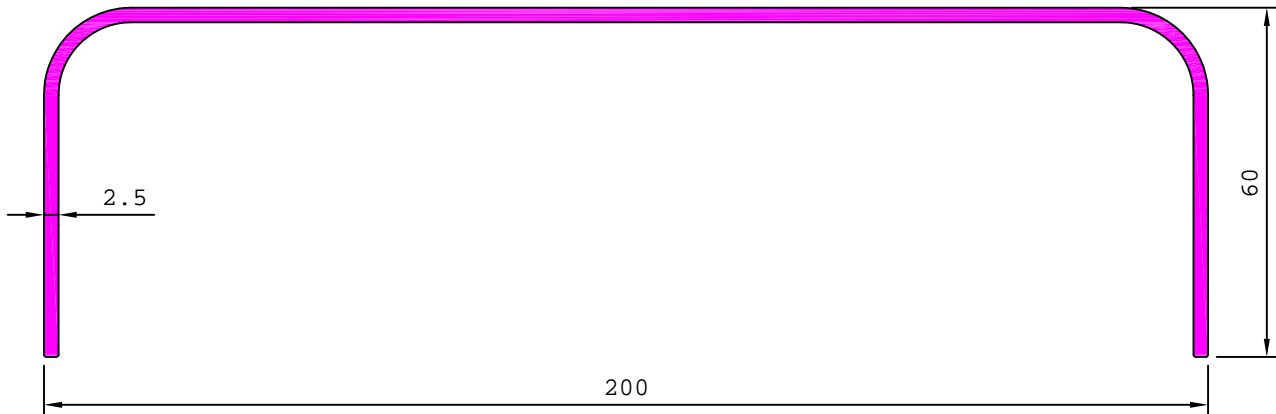

29638

1.976 kg/m

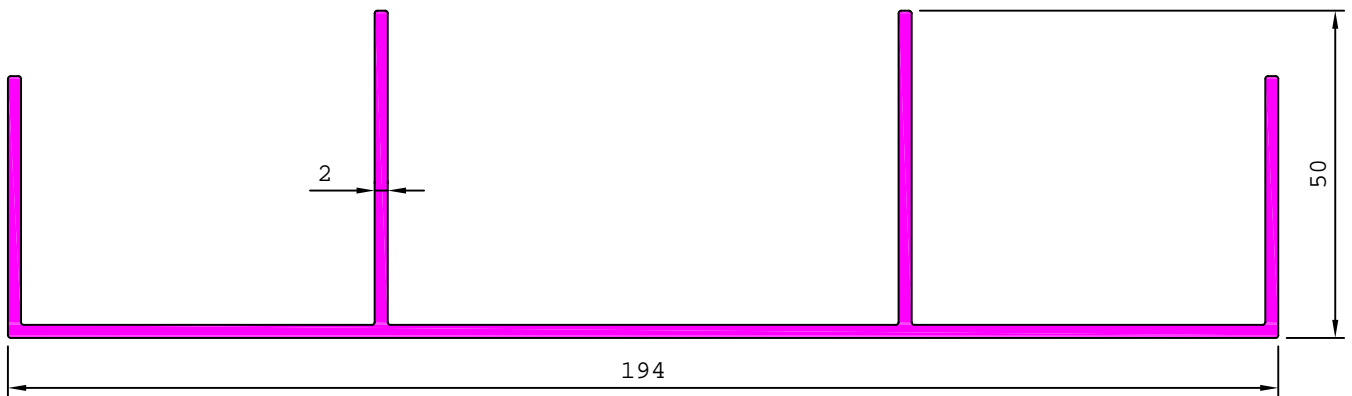

ARCHITECTURAL

TOWER BOLT

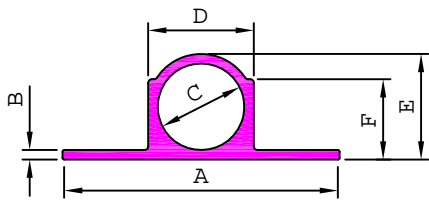

SI No	Section No	A	B	C	D	E	F	Weight kg/m
1	18001	24.50	0.75	8.63	10.10	10.10	8.15	0.121
2	18002	31.75	1.39	9.90	12.45	12.45	9.52	0.248
3	18003	32.00	1.60	11.00	14.00	14.00	11.00	0.302
4	18005	31.75	1.52	10.28	12.82	12.82	9.52	0.253
5	18006	38.00	2.50	13.00	18.00	18.00	14.00	0.570
6	18007	44.00	2.00	13.00	17.00	17.00	13.00	0.493
7	18008	30.00	0.75	9.90	11.40	11.40	9.50	0.156
8	18009	25.00	1.35	8.50	11.00	11.20	9.00	0.202
9	18013	37.50	1.70	12.40	15.70	15.80	12.00	0.379
10	18015	31.75	1.70	10.20	12.40	12.40	9.70	0.244
11	18016	38.00	2.30	12.60	17.10	17.10	13.00	0.506
12	18017	31.20	1.57	9.70	11.90	11.90	9.10	0.229
13	18022	30.75	1.02	9.50	11.30	11.30	9.00	0.176
14	18023	31.75	1.10	10.20	12.10	12.10	9.50	0.197
15	18027	37.50	2.00	12.80	16.50	16.50	13.50	0.439
16	18029	37.00	2.20	12.00	15.00	15.50	11.70	0.396
17	18036	36.00	1.85	12.00	14.90	14.90	11.00	0.342
18	18037	30.00	0.98	9.50	10.90	10.90	8.60	0.150
19	18038	44.00	2.00	13.40	16.40	16.50	14.50	0.450
20	18039	32.00	1.25	11.00	13.40	13.40	10.50	0.246
21	18040	37.00	1.83	12.00	15.00	15.00	11.70	0.354
22	18042	23.50	0.70	8.50	9.80	9.80	7.95	0.109
23	18043	28.00	0.59	9.50	10.68	10.68	8.00	0.113
24	18045	32.00	1.30	11.00	13.60	13.60	10.80	0.262
25	18049	38.00	2.35	13.00	17.50	17.50	13.20	0.520
26	18051	31.00	1.10	9.40	11.40	11.40	8.70	0.188
27	18052	31.50	1.20	10.80	12.80	12.80	10.10	0.216
28	18055	31.75	1.40	10.20	12.40	12.40	9.10	0.226
29	18056	31.20	1.35	9.70	11.70	11.70	9.00	0.206
30	18057	38.00	1.90	12.60	16.20	16.20	12.60	0.419
31	18060	44.00	1.65	12.80	15.80	15.80	13.80	0.406
32	18062	32.00	1.22	11.00	13.44	13.40	10.80	0.248
33	18068	31.75	2.00	10.20	12.40	12.40	9.70	0.261

SI No	Section No	A	B	C	D	E	Weight kg/m
1	18018	31.80	1.50	9.80	12.40	12.70	0.261
2	18019	32.00	1.35	10.80	13.10	13.50	0.255

18063 0.411 kg/m

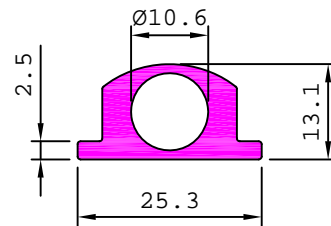

18064 0.361 kg/m

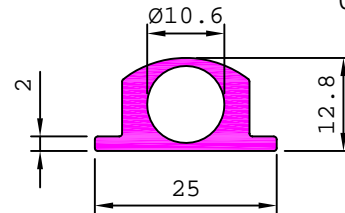

18065 0.381 kg/m

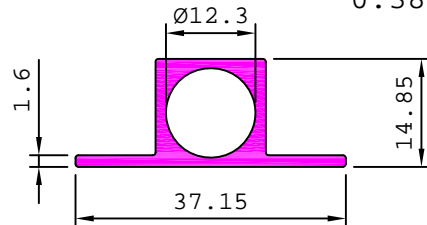

18066 0.203 kg/m

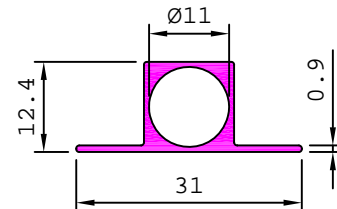

18067 0.184 kg/m

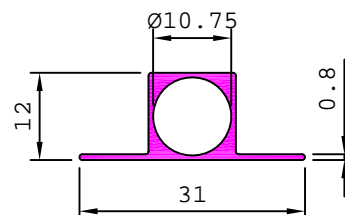

ARCHITECTURAL

HOLLOW HINGES & SPECIAL HINGES

HINGES - HOLLOW

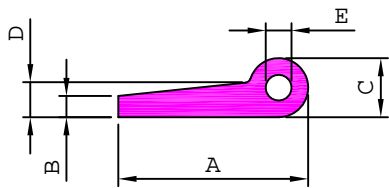

SL. No.	Section No.	A	B	C	D	E	Weight kg/m
1	18361	24.30	2.10	6.00	2.60	3.60	0.170
2	18353	35.76	3.10	9.52	3.60	5.00	0.390
3	18355	37.00	4.00	11.00	4.76	5.55	0.515

18357

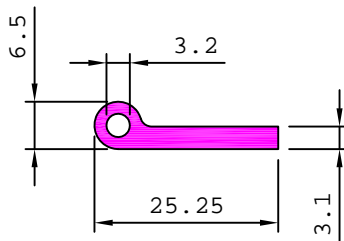

0.231 kg/m

18362

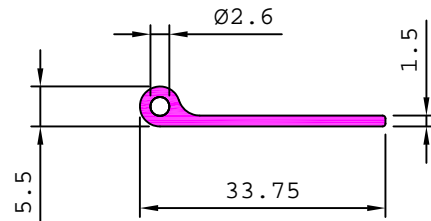

0.172 kg/m

18401

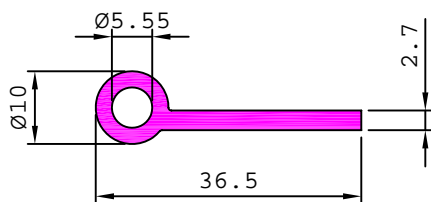

0.343 kg/m

18402

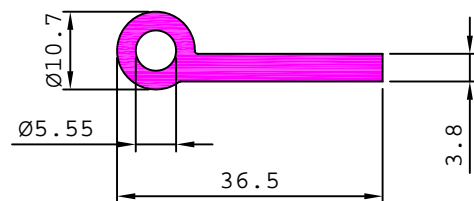

0.450 kg/m

18406

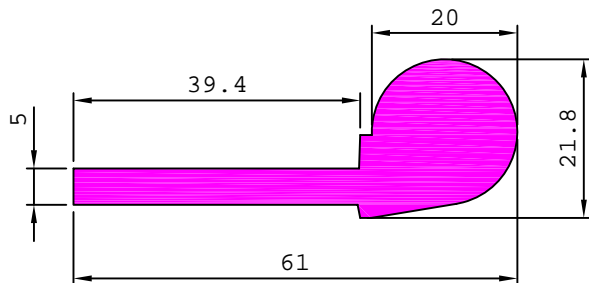

1.515 kg/m

18407

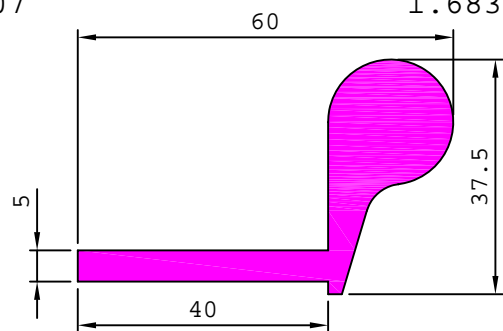

1.683 kg/m

18425

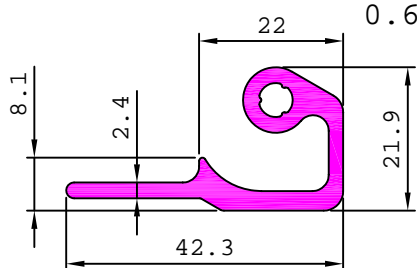

0.632 kg/m

18426

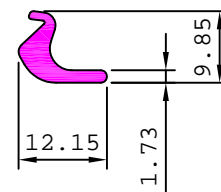

0.118 kg/m

18461

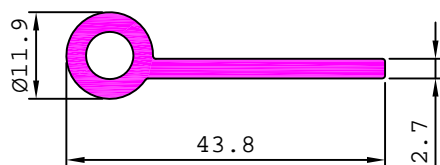

0.446 kg/m

18427

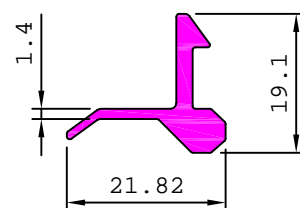

0.250 kg/m

ARCHITECTURAL

SPECIAL HINGES & ALDROP

S4459

0.257 kg/m

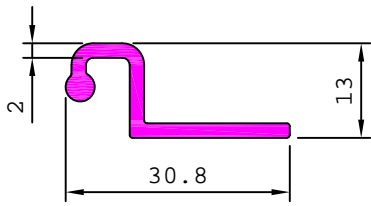

S4460

0.450 kg/m

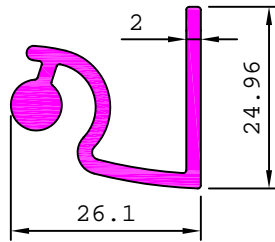

S5062

0.361 kg/m

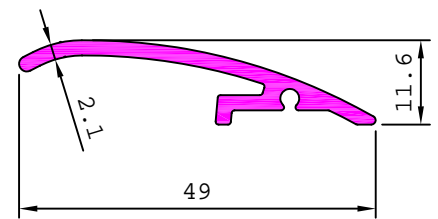

S5061

1.098 kg/m

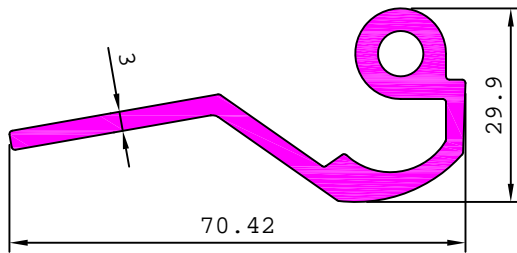

18502

0.832 kg/m

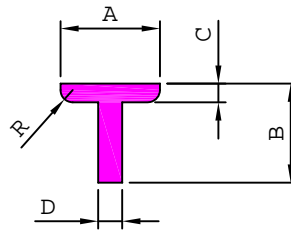
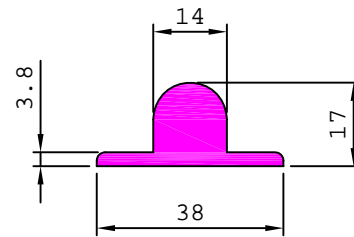

SL. No.	Section No.	A	B	C	D	R	Weight kg/m
1	18504	38.00	35.00	3.20	6.50	3.00	0.875
2	18509	41.50	41.50	3.85	6.80	2.50	1.115
3	18505	41.50	41.50	4.15	7.50	2.50	1.214
4	18508	42.00	38.00	3.25	6.75	2.00	0.997
5	18506	42.00	40.00	4.00	7.70	2.50	1.195
6	18501	42.00	40.00	4.20	8.00	2.50	1.242

S5163

1.851 kg/m

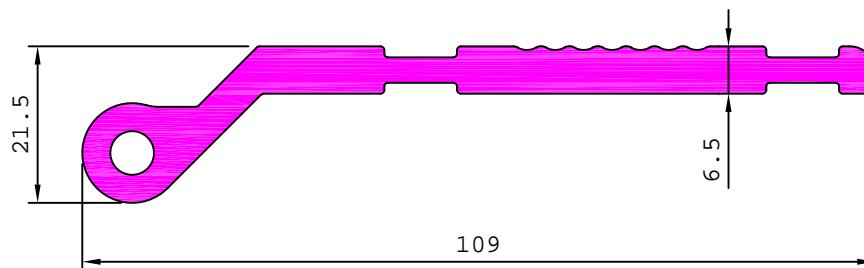

ARCHITECTURAL

HOLLOW HINGES & SPECIAL HINGES,ALDROP

18452 0.407 kg/m

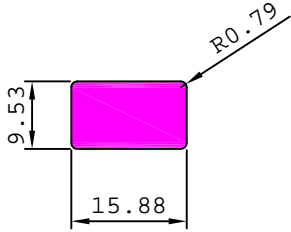

18456 1.060 kg/m

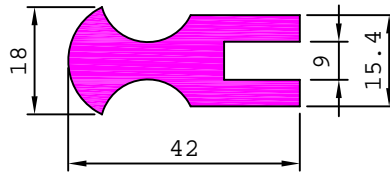

18458 0.390 kg/m

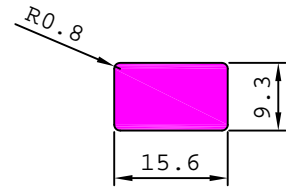

18460 1.220 kg/m

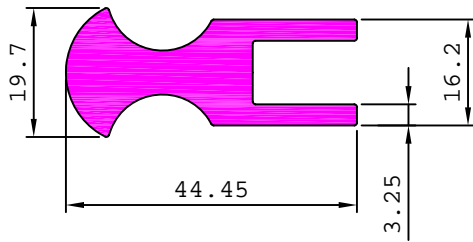

18459 0.828 kg/m

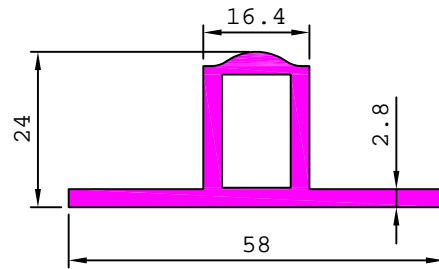

28072 2.102 kg/m

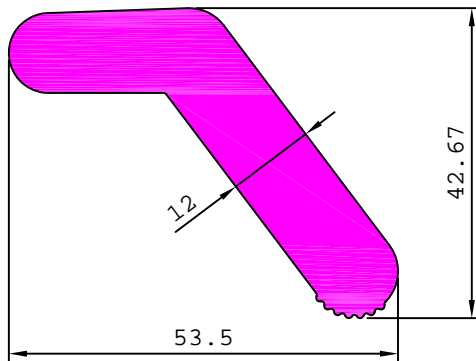

28073 1.120 kg/m

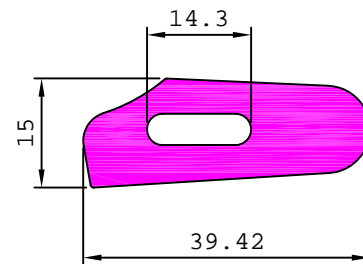

ARCHITECTURAL

HANDLE SECTIONS

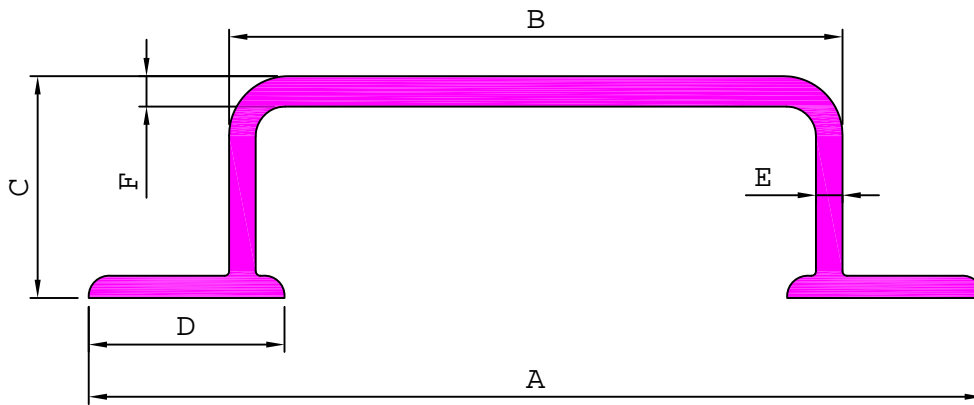

SL. No.	Section No.	A	B	C	D	E	F	Weight kg/m
1	18586	148.80	106.50	33.00	27.30	3.90	4.20	2.105
2	18640	149.50	107.00	31.00	30.50	3.85	3.85	2.066
3	18619	150.00	110.00	34.00	30.00	3.45	3.60	1.995
4	18572	150.00	110.00	34.00	30.00	3.66	3.66	2.127
5	18620	150.00	110.00	34.00	30.00	4.00	4.10	2.248
6	18571	150.00	110.00	34.00	30.00	4.32	4.32	2.374

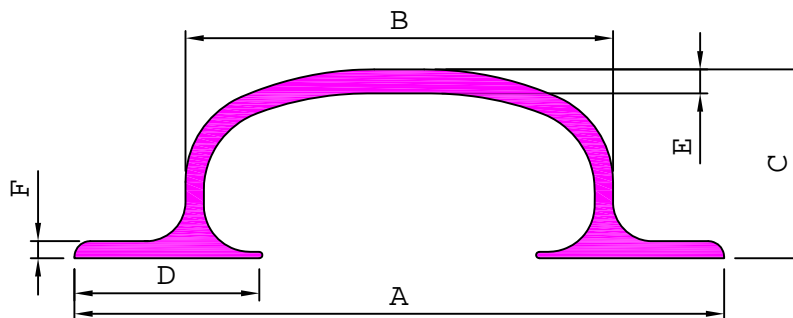

SL. No.	Section No.	A	B	C	D	E	F	Weight kg/m
1	18611	123.00	82.50	34.50	30.00	2.45	2.20	1.258
2	18587	127.00	84.00	37.00	36.50	3.35	2.85	1.742
3	18621	127.00	84.00	37.00	36.50	3.90	3.10	1.996
4	18630	128.00	84.00	37.00	30.00	3.30	3.00	1.647
5	18613	128.00	84.00	37.00	30.00	3.50	3.10	1.724
6	18622	142.00	98.00	37.00	38.50	4.15	3.20	2.270
7	18631	143.00	99.00	36.00	32.00	3.70	2.70	1.921

ARCHITECTURAL

HANDLE SECTIONS

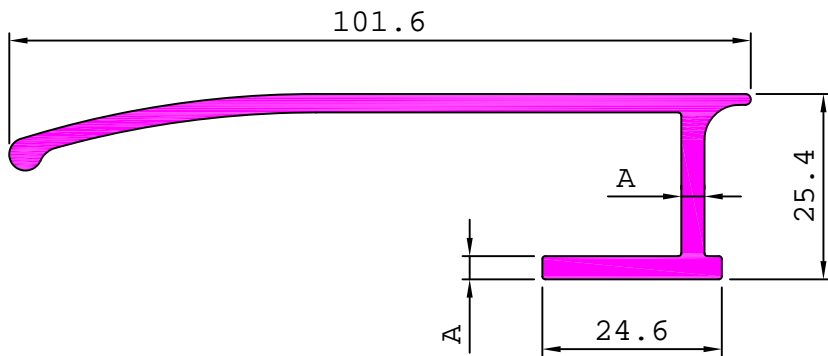

SL. No.	Section No.	A	Weight kg/m
1	18553	3.18	1.093
2	18604	2.10	0.852

18563

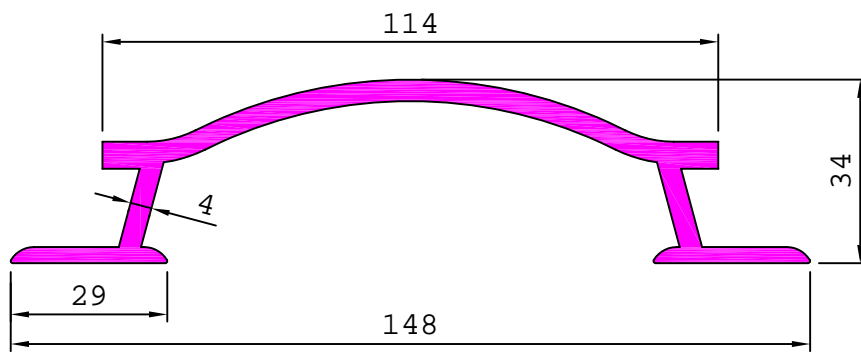

2.091 kg/m

18576

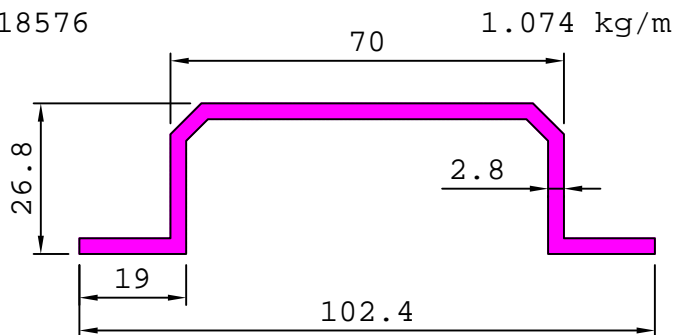

18558

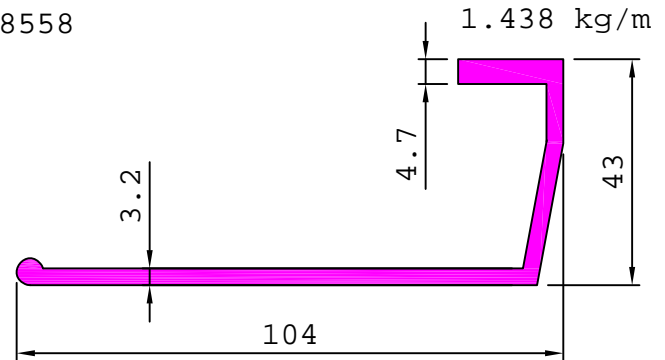

18560

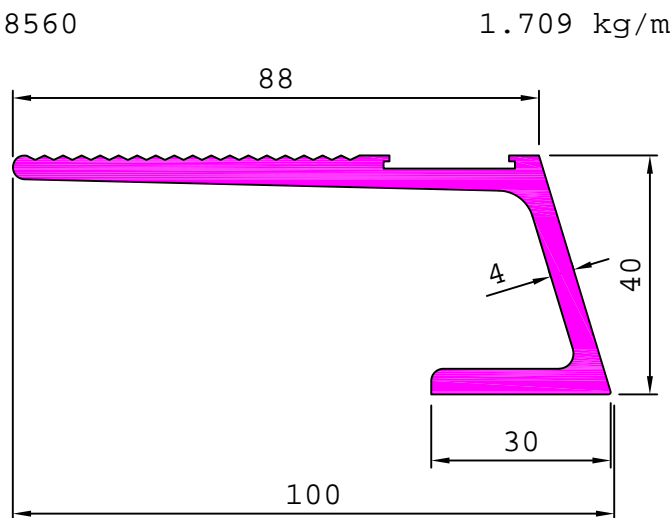

18570

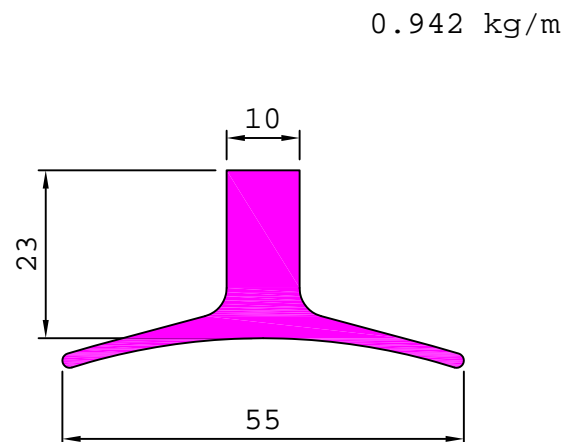

ARCHITECTURAL

HANDLE SECTIONS

18565

0.491 kg/m

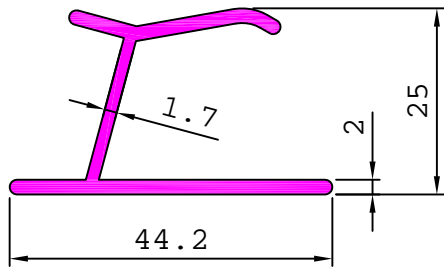

18641

0.707 kg/m

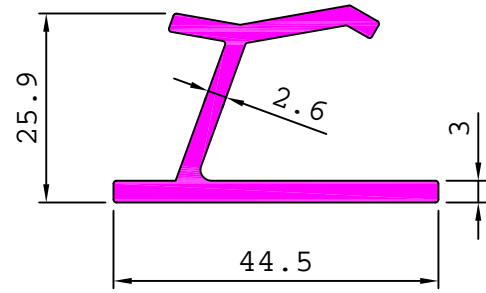

18643

7.668 kg/m

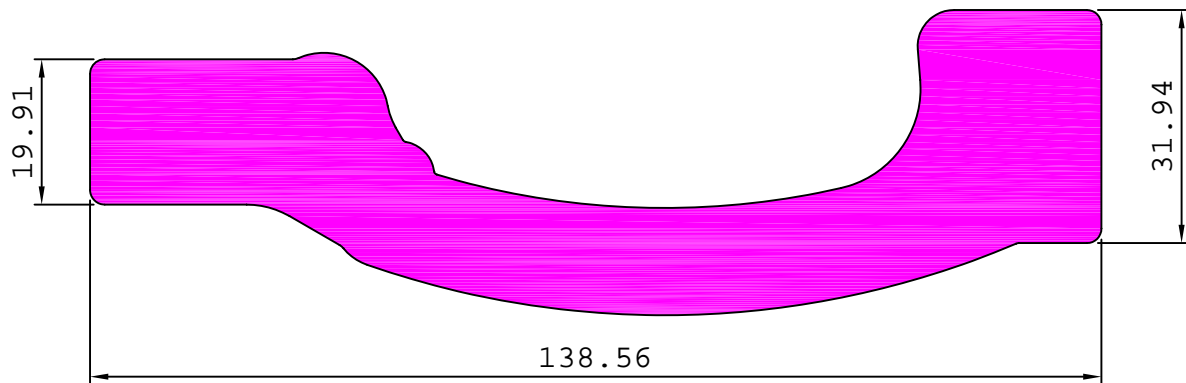

18644

9.441 kg/m

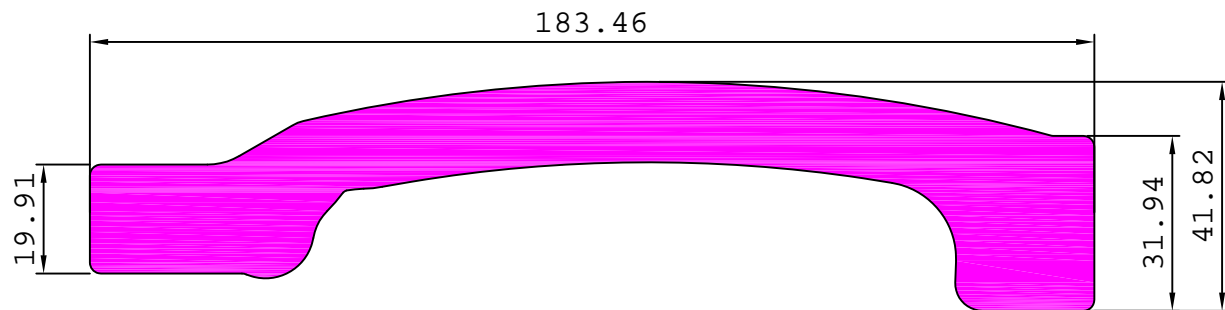

29426

13.076 kg/m

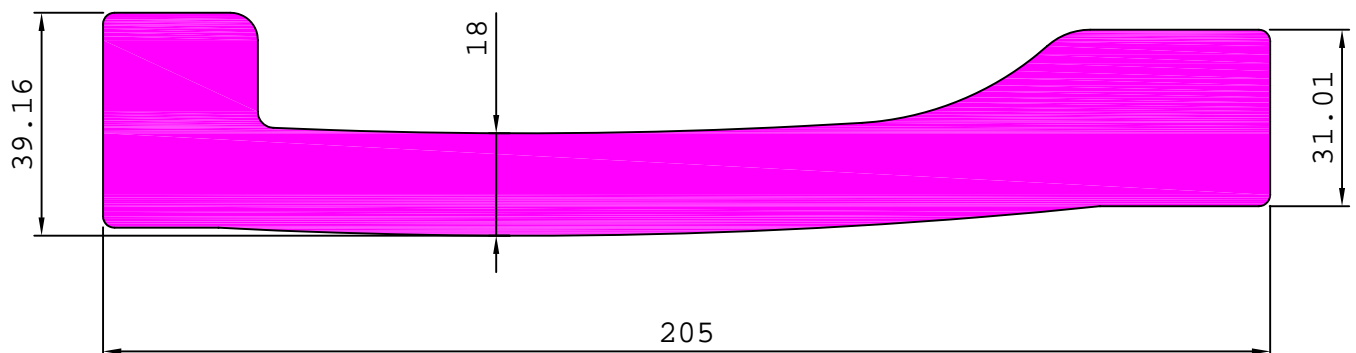

ARCHITECTURAL

HANDLE SECTIONS

S4889

4.700 kg/m

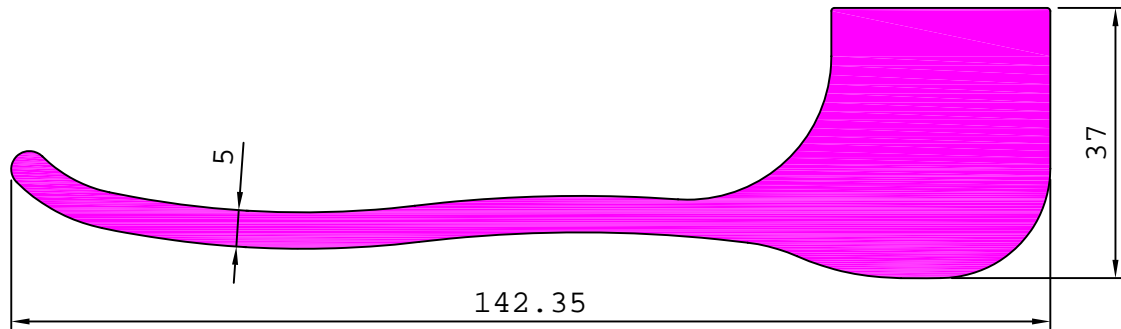

ARCHITECTURAL

HASP & STAPLE

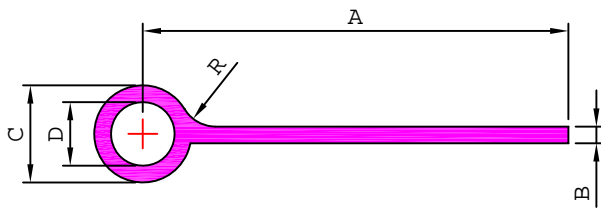

SL. No.	Section No.	A	B	C	D	R	Weight kg/m
1	18851	91.80	3.00	20.00	13.00	16.00	1.189
2	18852	115.50	3.80	24.80	16.50	18.00	1.822
3	18858	115.50	3.40	24.20	15.50	14.00	1.708
4	18859	115.50	3.70	24.50	16.00	15.00	1.789
5	18860	117.00	3.90	25.15	16.00	15.00	1.930

CURTAIN RAILS & CURTAIN RAILS SPECIAL

CURTAIN RAILS

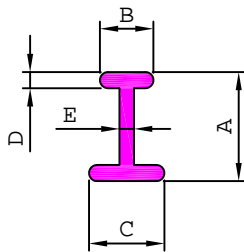

SL. No.	Section No.	A	B	C	D	E	Weight kg/m
1	18963	14.50	5.20	5.20	0.70	0.70	0.044
2	18958	15.00	5.50	5.50	0.80	0.80	0.052
3	18955	15.00	6.00	6.00	0.58	0.58	0.041
4	18964	15.00	6.00	6.00	1.02	1.02	0.068
5	18951	15.86	6.35	9.52	1.22	1.22	0.094
6	18965	32.00	16.00	16.00	1.50	1.50	0.247

19052

0.071 kg/m

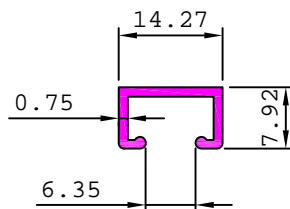

19053

0.145 kg/m

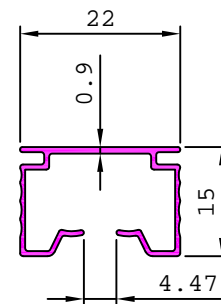

ARCHITECTURAL

STEP EDGINGS

19151

0.231 kg/m

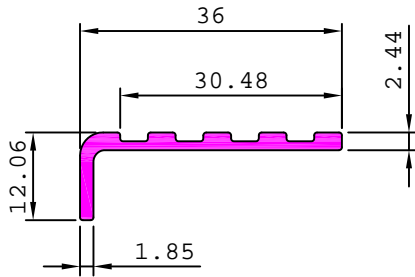

19152

0.332 kg/m

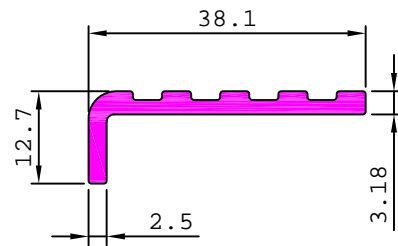

19153

0.396 kg/m

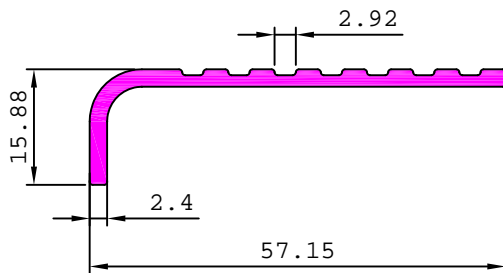

19162

0.359 kg/m

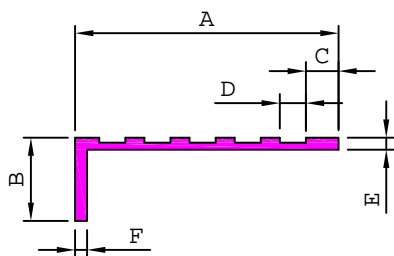
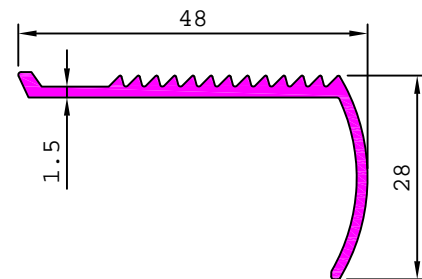

SL. No.	Section No.	A	B	C	D	E	F	Weight kg/m
1	19158	30.00	10.00	3.20	3.50	0.78	0.48	0.064
2	19157	43.00	10.20	2.80	3.50	0.80	0.60	0.094

19163

0.444 kg/m

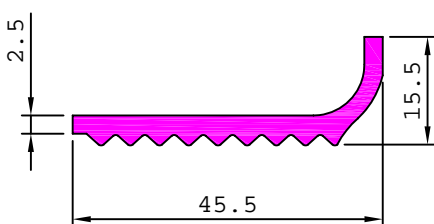

19164

0.126 kg/m

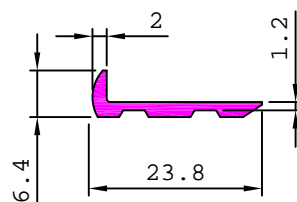

19167

0.063 kg/m

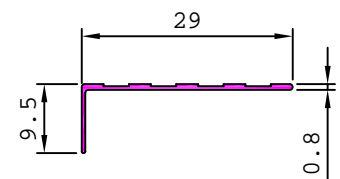

19168

2.587 kg/m

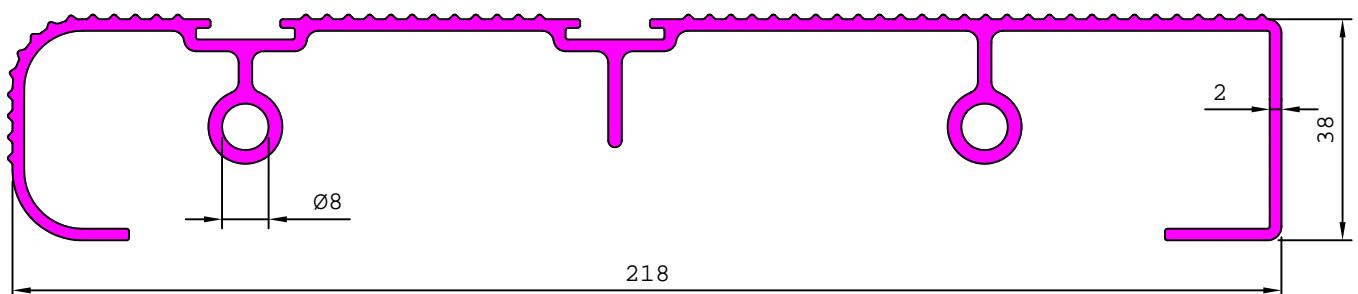

ARCHITECTURAL

HAND RAILS

19204 0.851 kg/m

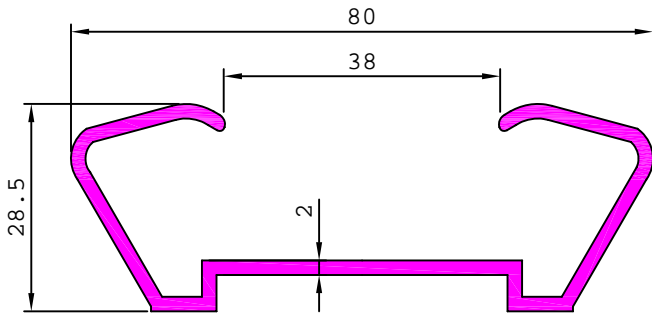

19205 0.221 kg/m

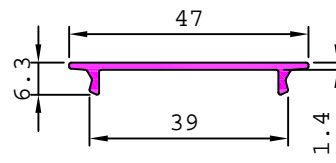

19209 0.364 kg/m

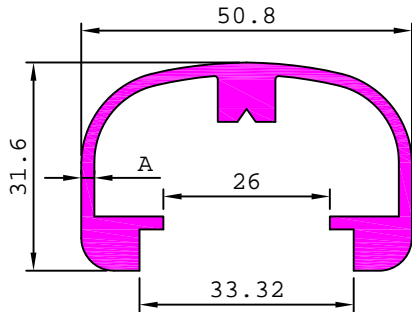
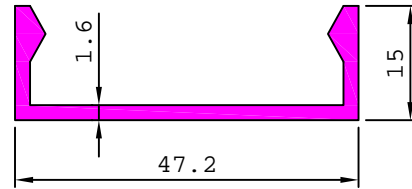

SL. No.	Section No.	A	Weight kg/m
1	19224	1.34	0.855
2	19223	1.92	0.975
3	19206	3.00	1.210

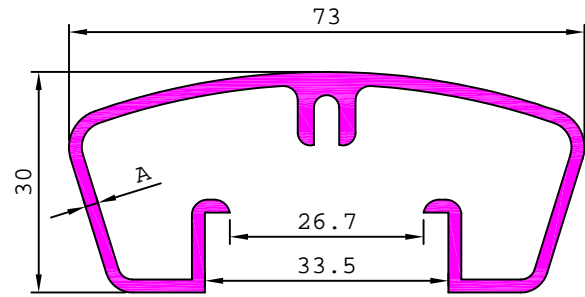

SL. No.	Section No.	A	Weight kg/m
1	19226	1.20	0.684
2	19225	1.65	0.854
3	19207	2.50	1.281

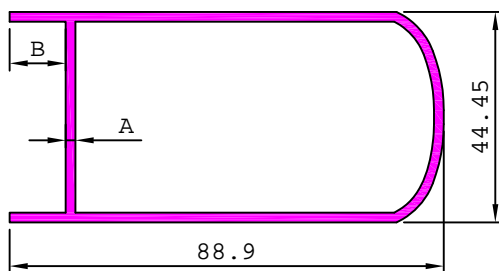

SL. No.	Section No.	A	B	Weight kg/m
1	19218	1.10	12.70	0.738
2	19217	1.15	12.50	0.765
3	19215	1.40	12.50	0.976

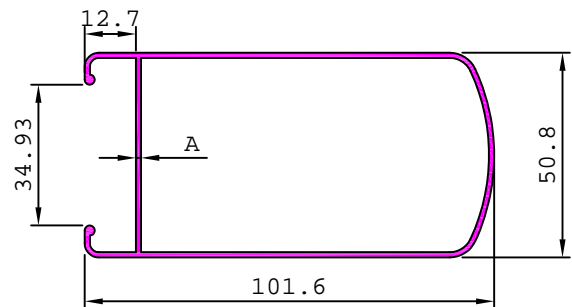

SL. No.	Section No.	A	Weight kg/m
1	19227	0.93	0.763
2	19222	1.19	0.970
3	19220	1.30	1.067

ARCHITECTURAL

HAND RAILS

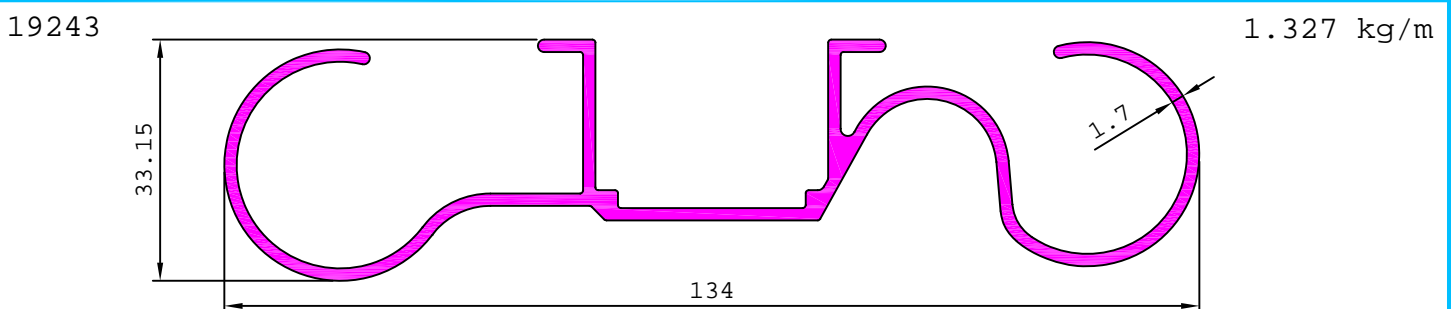
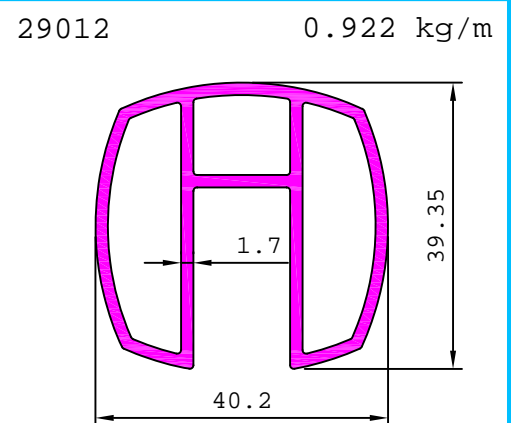
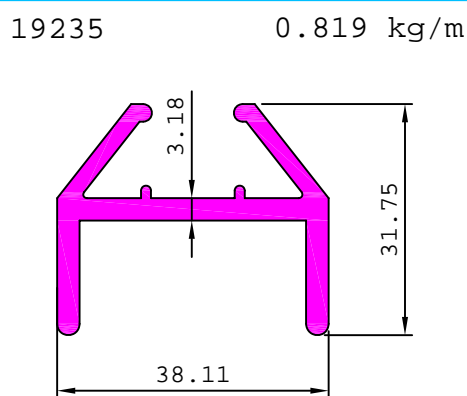
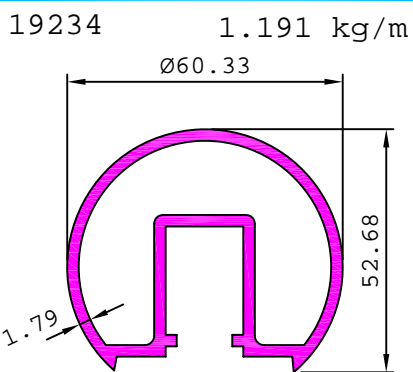
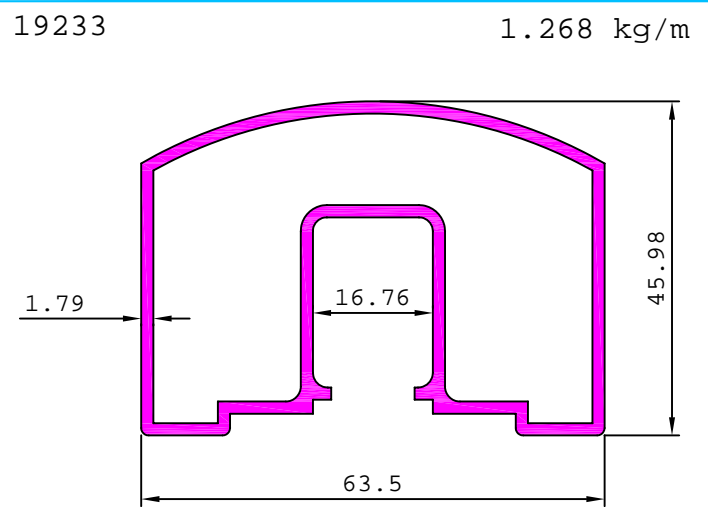
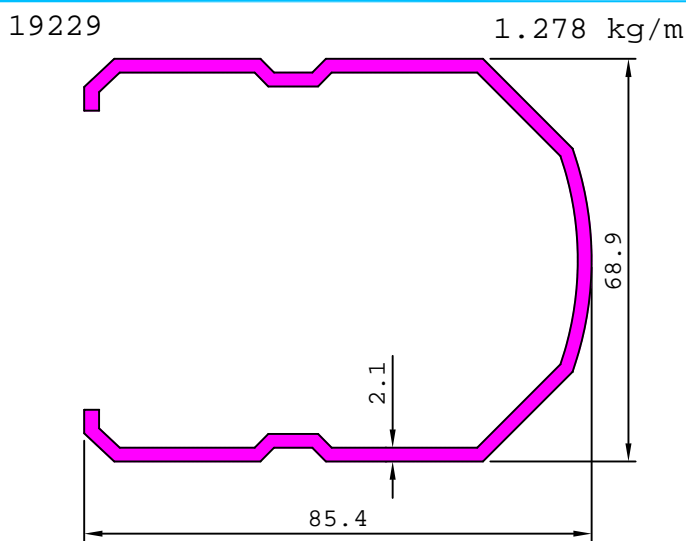
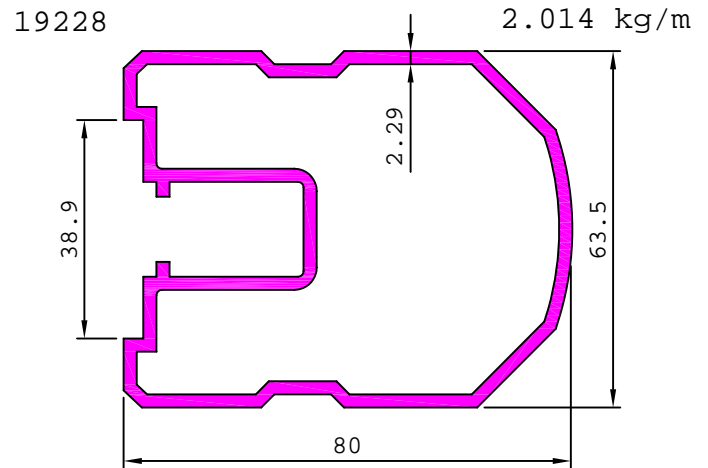
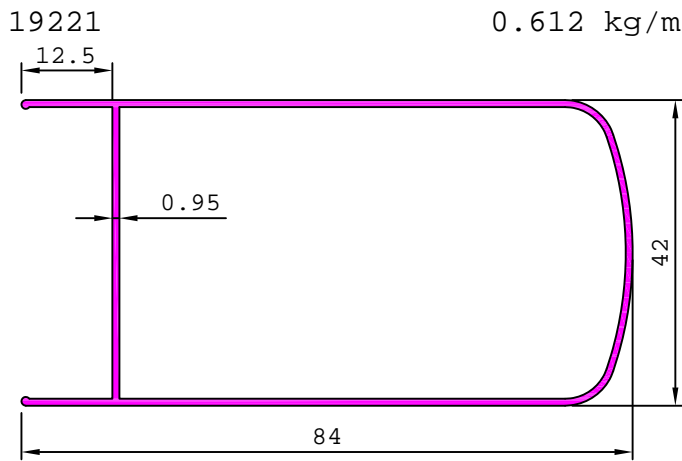

ARCHITECTURAL

HAND RAILS

19236

0.926 kg/m

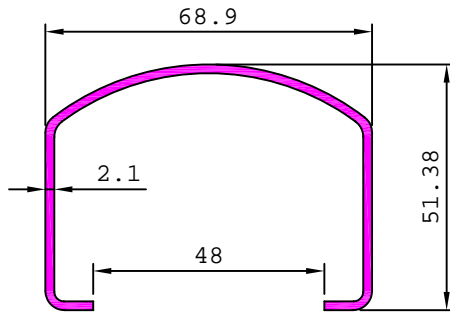

19240

1.847 kg/m

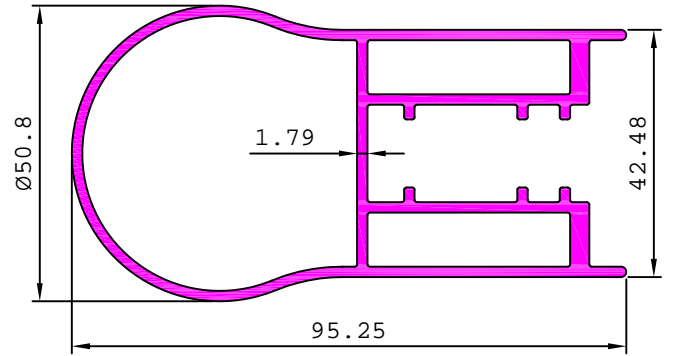

19241

0.711 kg/m

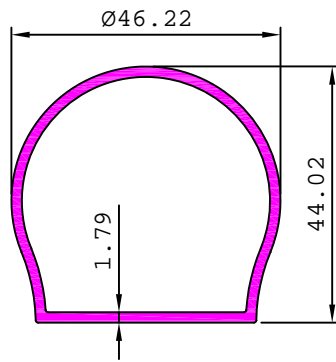

19242

1.179 kg/m

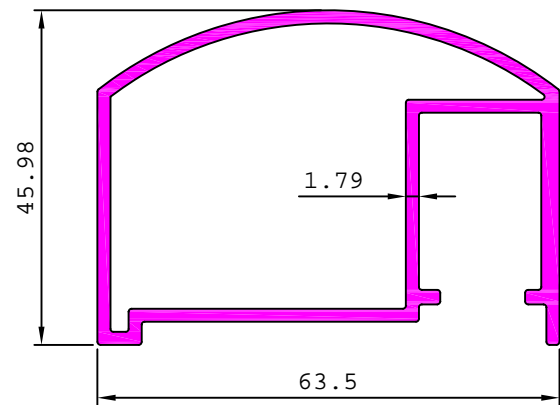

S4856

0.409 kg/m

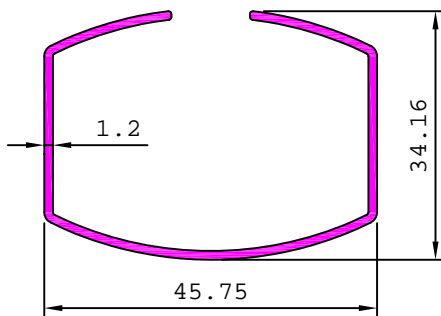

S4857

0.509 kg/m

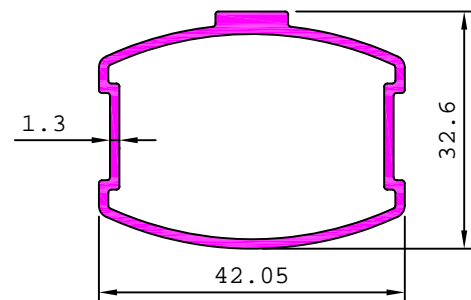

S4810

1.290 kg/m

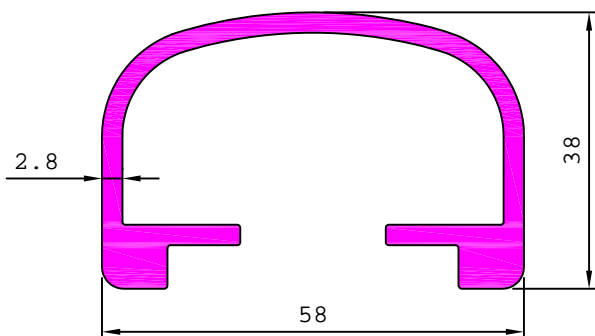

ARCHITECTURAL

WALL FACINGS

19304

0.303 kg/m

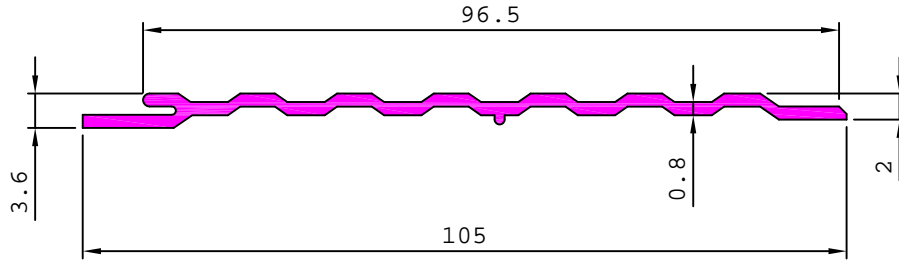

19305

0.607 kg/m

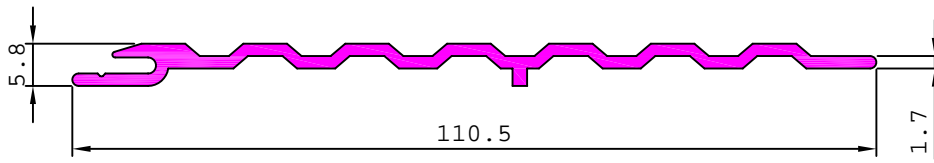

19306

3.748 kg/m

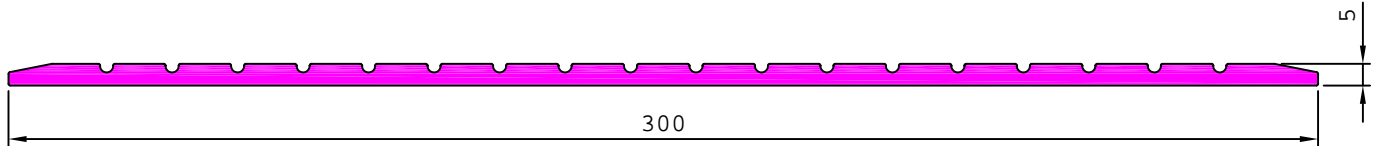

ARCHITECTURAL

GLAZINGS

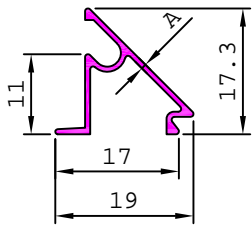

SL. No.	Section No.	A	Weight kg/m
1	19382	0.41	0.061
2	19366	0.49	0.071
3	19361	0.53	0.078
4	19352	0.70	0.096
5	19370	0.80	0.109
6	19360	0.90	0.124
7	19377	1.20	0.154

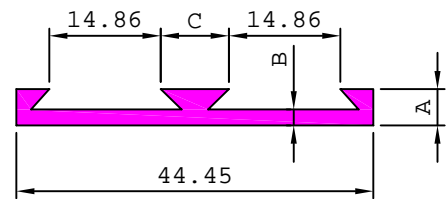

SL. No.	Section No.	A	B	C	Weight kg/m
1	19368	3.07	0.57	7.50	0.137
2	19367	3.27	0.77	7.50	0.161
3	19380	3.75	1.21	8.00	0.216

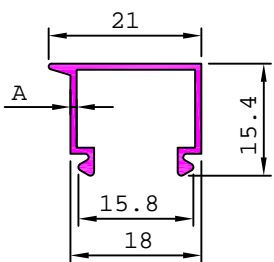

SL. No.	Section No.	A	Weight kg/m
1	19362	0.60	0.108
2	19369	0.85	0.137
3	19376	1.22	0.188

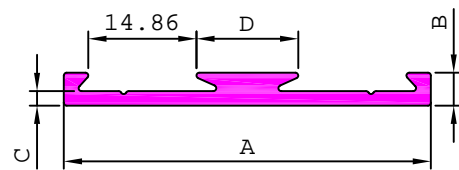

SL. No.	Section No.	A	B	C	D	Weight kg/m
1	19353	44.45	5.76	3.22	8.00	0.453
2	19416	50.45	4.54	2.00	14.00	0.385

19354 0.213 kg/m

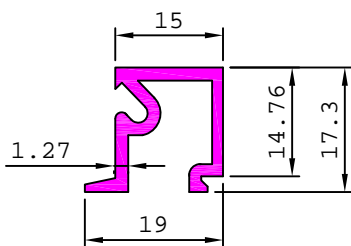

19359 0.301 kg/m

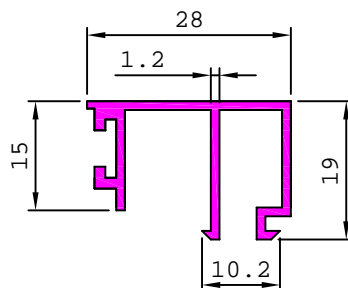

19363 0.229 kg/m

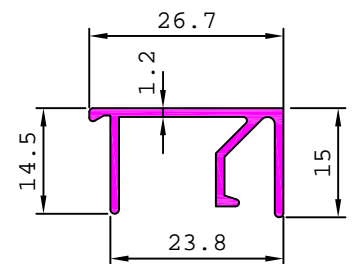

19365 0.182 kg/m

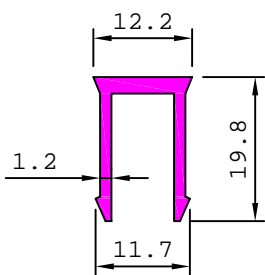

19375 0.175 kg/m

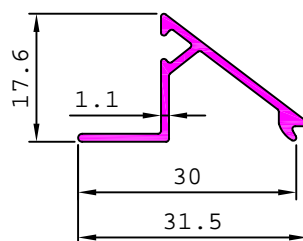

19378 0.156 kg/m

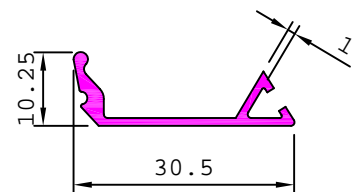

19381 0.373 kg/m

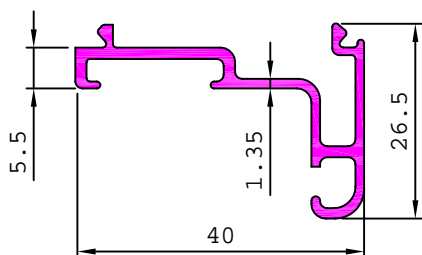

19383 0.248 kg/m

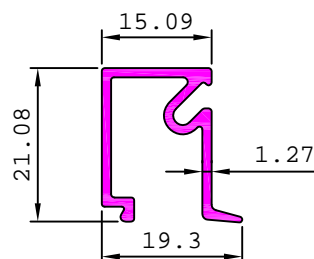

19385 0.216 kg/m

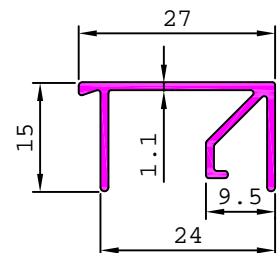

ARCHITECTURAL

GLAZINGS

19384

0.424 kg/m

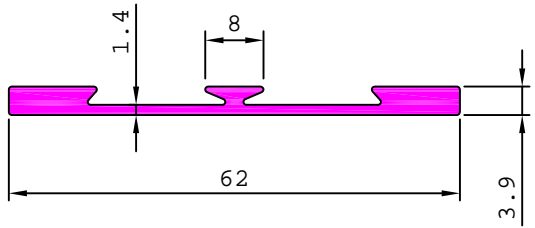

19387

0.349 kg/m

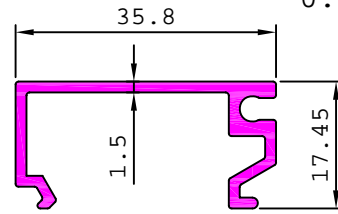

19389

0.157 kg/m

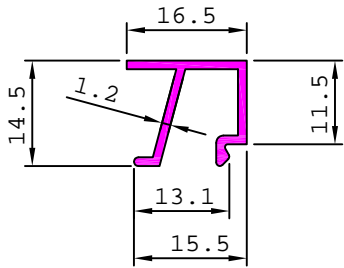

19390

0.266 kg/m

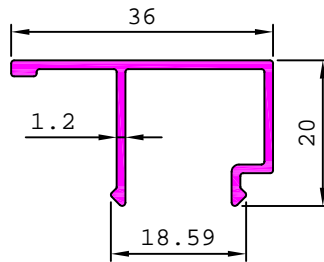

19393

0.164 kg/m

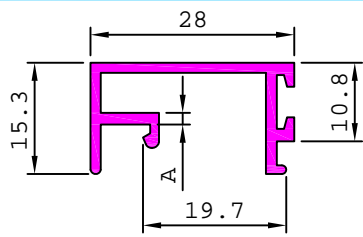
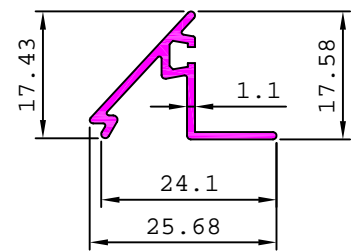

19395

0.405 kg/m

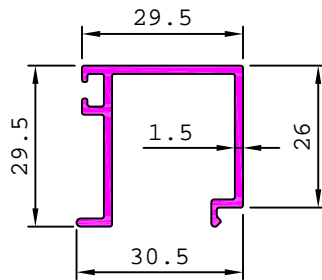

19396

0.268 kg/m

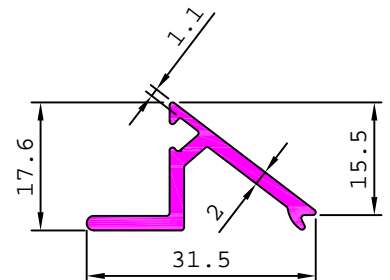

SL. No.	Section No.	A	Weight kg/m
1	19392	1.11	0.224
2	19391	1.60	0.289

19397

0.200 kg/m

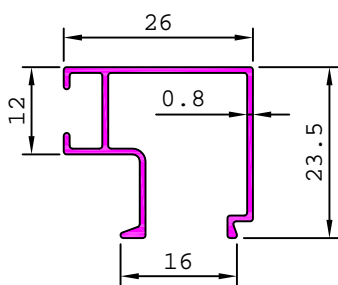

19398

0.174 kg/m

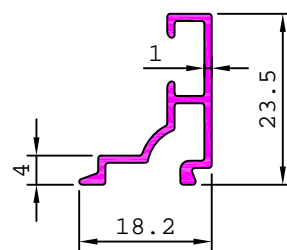

19400

0.200 kg/m

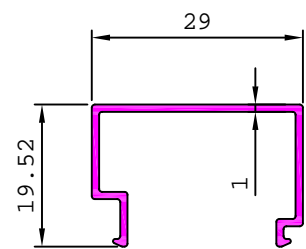

19402

0.313 kg/m

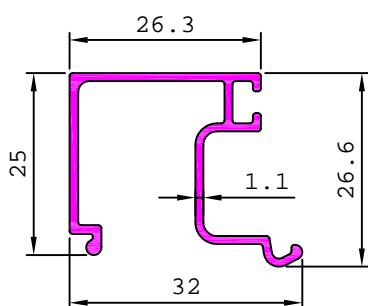

19403

0.288 kg/m

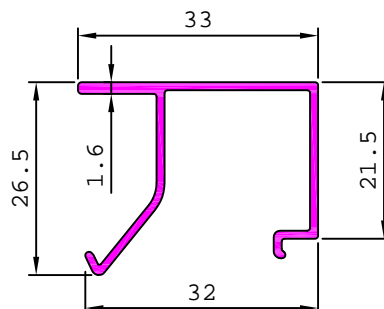

19404

0.226 kg/m

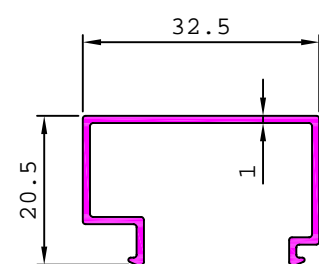

ARCHITECTURAL

GLAZINGS

19405 0.164 kg/m

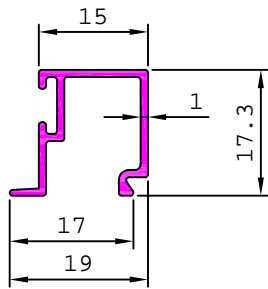

19406 0.219 kg/m

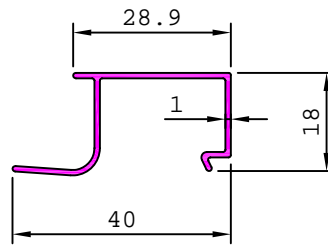

19407 0.260 kg/m

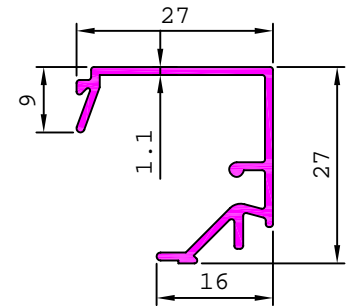

19408 0.267 kg/m

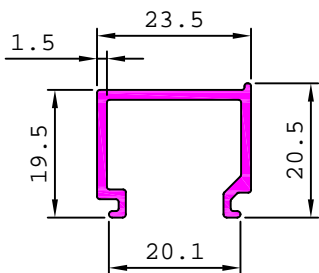

19410 0.302 kg/m

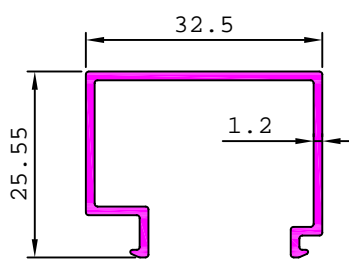

19411 0.437 kg/m

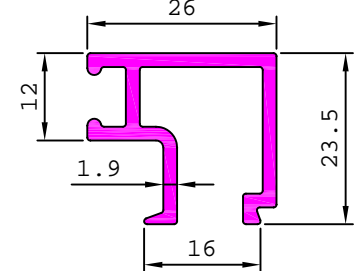

19412 0.248 kg/m

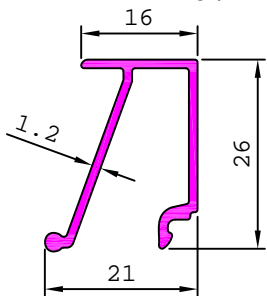

19413 0.270 kg/m

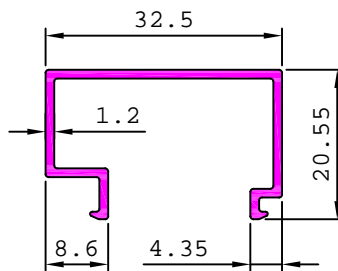

19415 0.271 kg/m

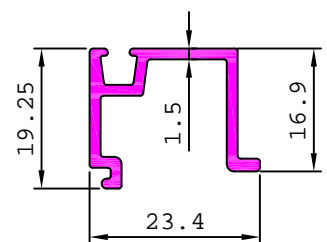

19417 0.202 kg/m

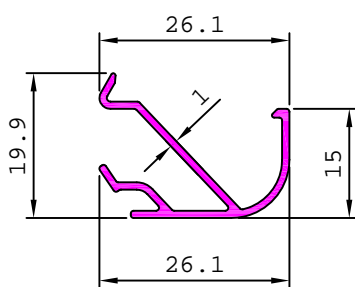

19418 0.180 kg/m

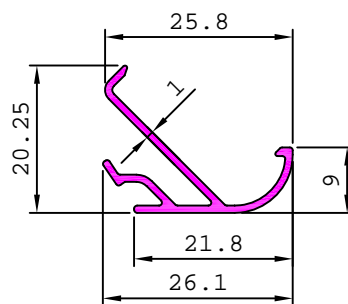

19422 0.193 kg/m

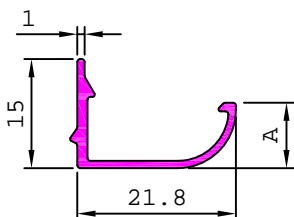
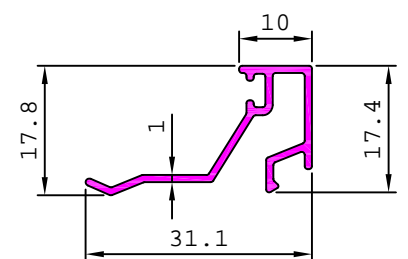

SL. No.	Section No.	A	Weight kg/m
1	19420	9.00	0.132
2	19419	15.00	0.148

19423 0.293 kg/m

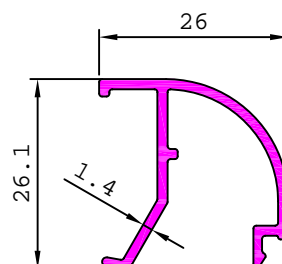

19424 0.283 kg/m

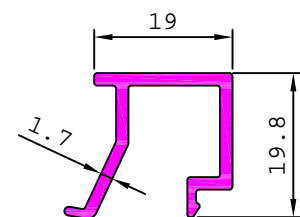

ARCHITECTURAL

GLAZINGS

19425 0.208 kg/m

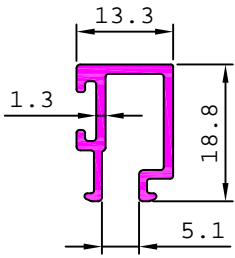

19426 0.116 kg/m

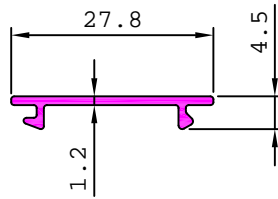

19427 0.138 kg/m

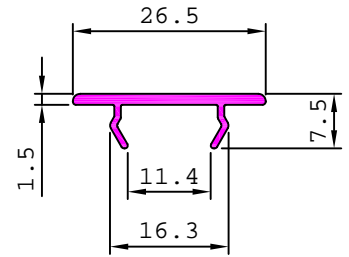

19428 0.206 kg/m

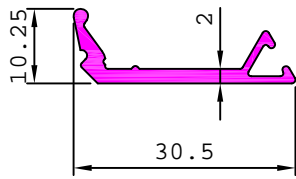

19429 0.237 kg/m

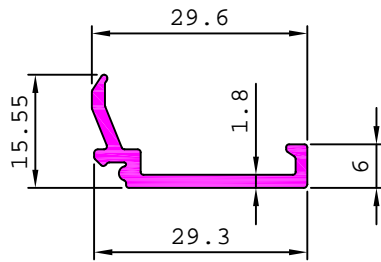

19430 0.259 kg/m

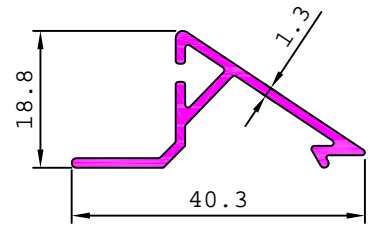

19431 0.206 kg/m

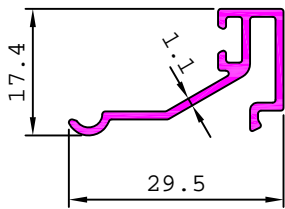

19432 0.219 kg/m

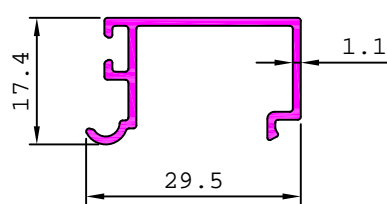

19433 0.250 kg/m

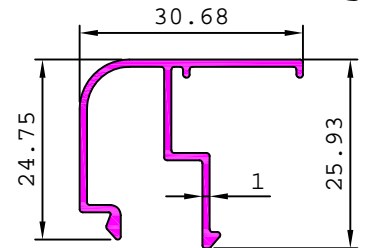

19436 0.260 kg/m

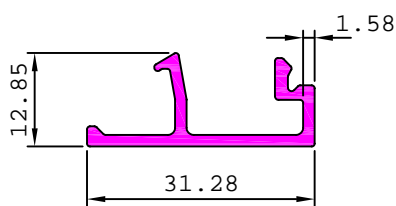

19437 0.213 kg/m

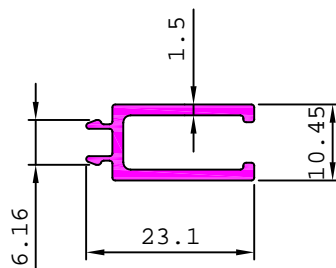

19438 0.379 kg/m

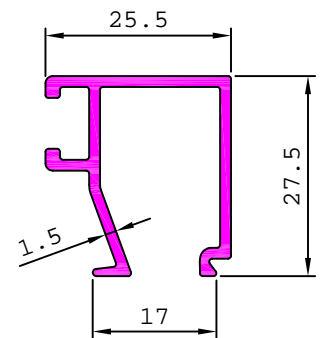

19439 0.146 kg/m

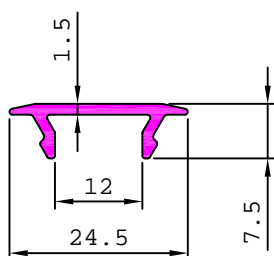

19440 0.239 kg/m

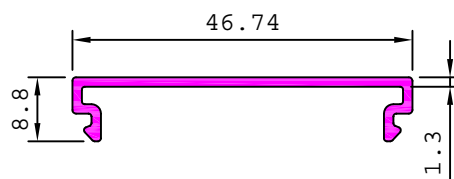

19441 0.200 kg/m

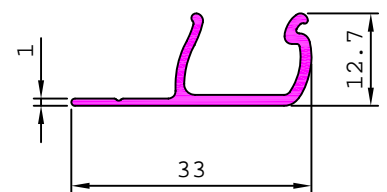

ARCHITECTURAL

GLAZINGS

19443 0.344 kg/m

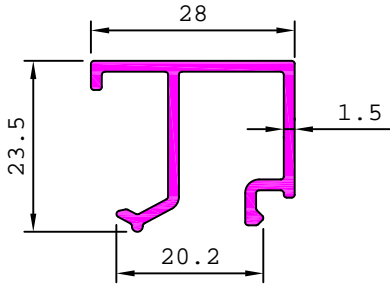

19445 0.241 kg/m

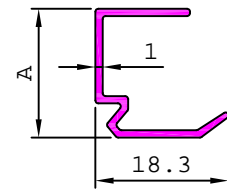
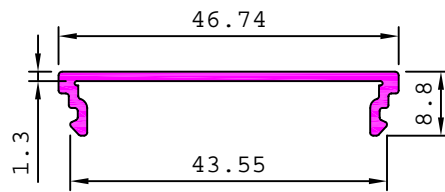

SL. No.	Section No.	A	Weight kg/m
1	19446	17.70	0.133
2	19457	19.70	0.137

19447 0.214 kg/m

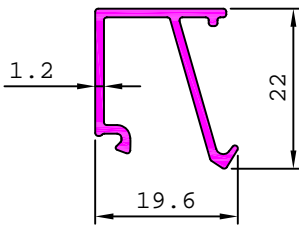

19449 0.208 kg/m

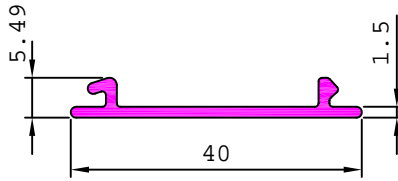

19450 0.035 kg/m

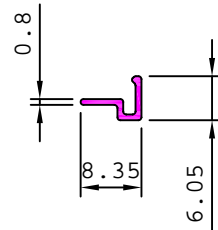

19451 0.131 kg/m

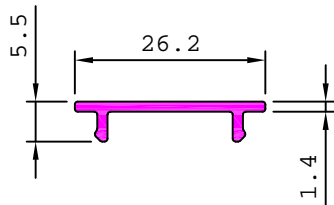

19452 0.114 kg/m

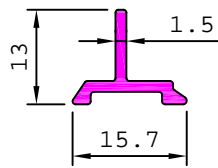

19454 0.126 kg/m

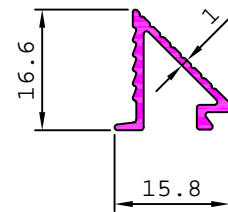

29135 0.248 kg/m

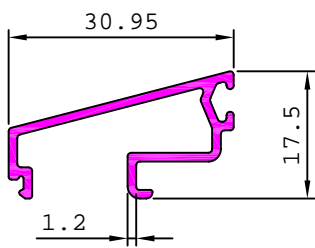

19456 0.303 kg/m

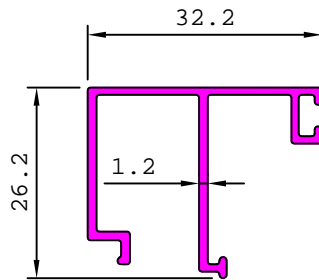

19458 0.212 kg/m

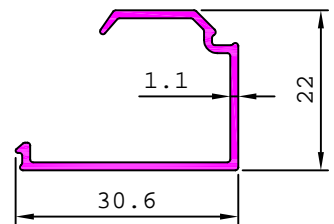

19460 0.245 kg/m

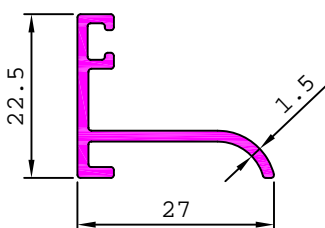

19461 0.149 kg/m

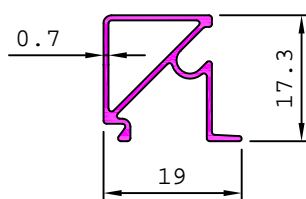

19462 0.239 kg/m

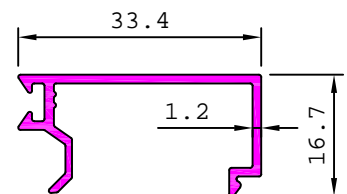

ARCHITECTURAL

GLAZINGS

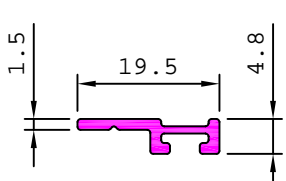
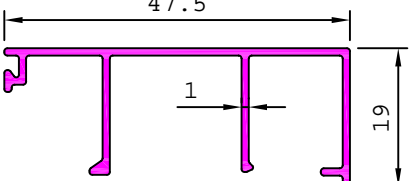
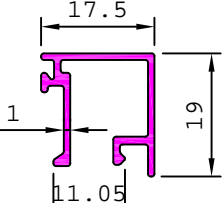
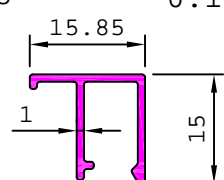
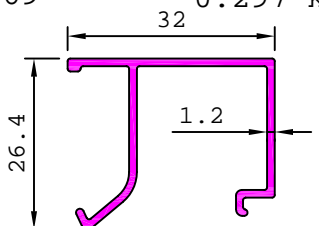
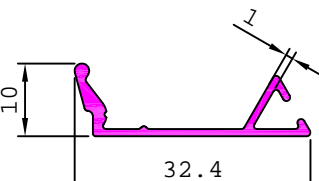
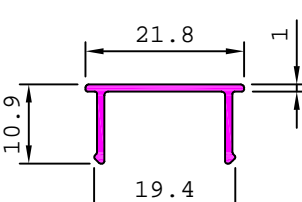
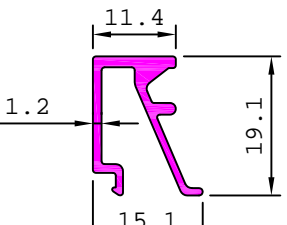
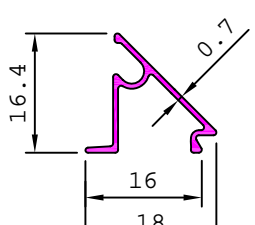
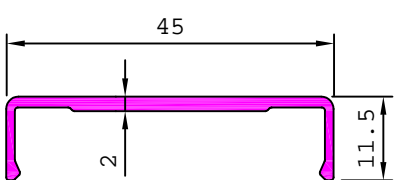
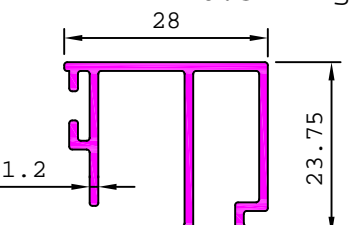
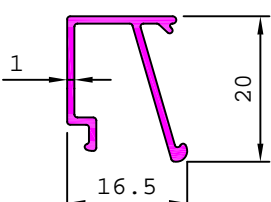
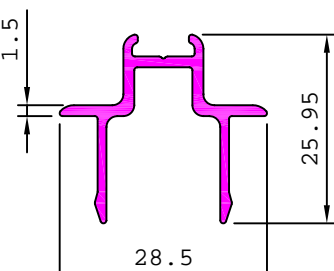
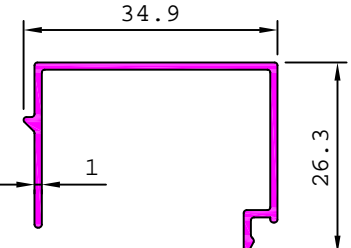
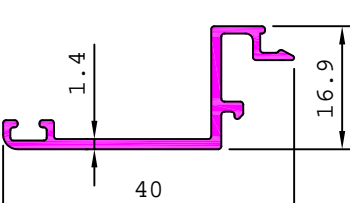
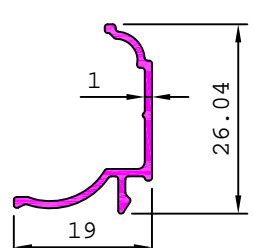
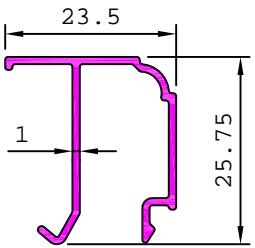
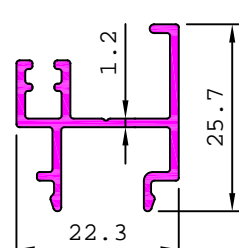
<p>19463 0.105 kg/m</p> 	<p>19464 0.302 kg/m</p> 	<p>19465 0.194 kg/m</p> 
<p>19468 0.126 kg/m</p> 	<p>19469 0.297 kg/m</p> 	<p>19470 0.168 kg/m</p> 
<p>19471 0.113 kg/m</p> 	<p>19472 0.197 kg/m</p> 	<p>19473 0.090 kg/m</p> 
<p>S4596 0.286 kg/m</p> 	<p>19475 0.341 kg/m</p> 	<p>19477 0.161 kg/m</p> 
<p>S4587 0.286 kg/m</p> 	<p>S4595 0.234 kg/m</p> 	<p>S4592 0.240 kg/m</p> 
<p>S4599 0.139 kg/m</p> 	<p>S4600 0.215 kg/m</p> 	<p>S4601 0.277 kg/m</p> 

ARCHITECTURAL

GLAZINGS

S4602 0.207 kg/m

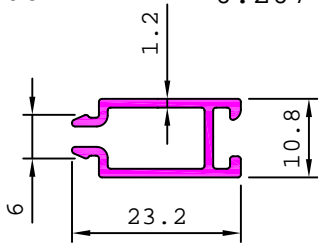

S4612 0.095 kg/m

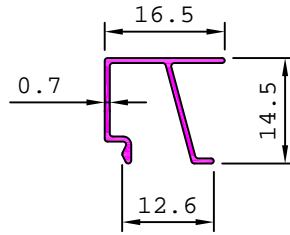

S4727 0.151 kg/m

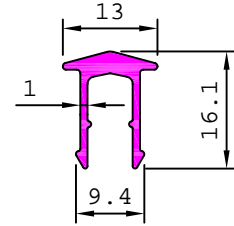

S4737 0.229 kg/m

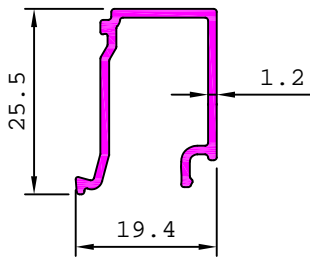

S4757 0.303 kg/m

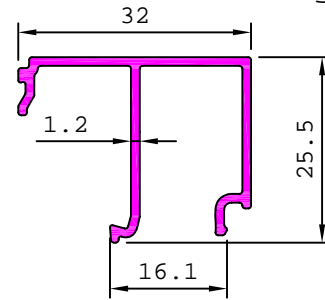

S4315 0.126 kg/m

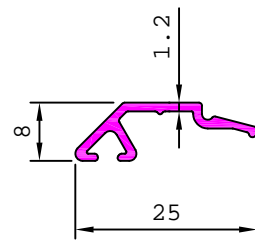

19627 0.300 kg/m

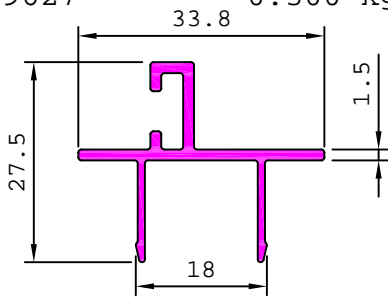

21370 0.912 kg/m

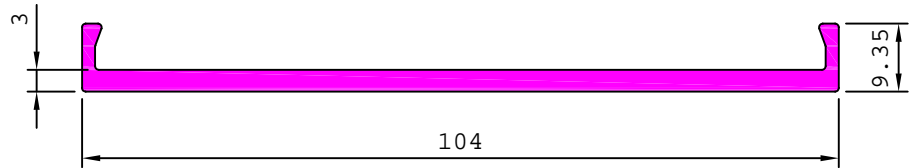

19474 0.126 kg/m

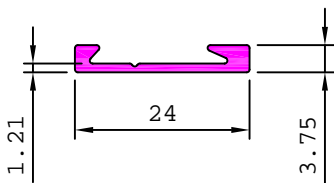

19478 0.243 kg/m

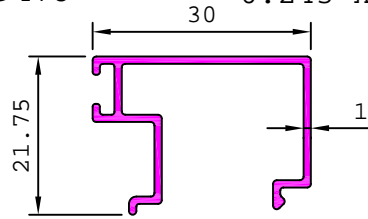

S5146 0.239 kg/m

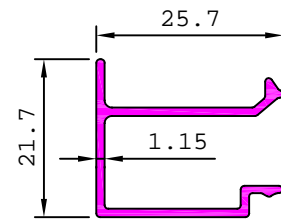

S5177 0.133 kg/m

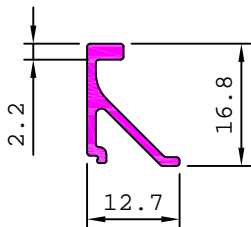

S5179 0.210 kg/m

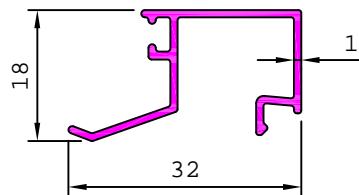

ARCHITECTURAL

GLAZINGS

19394 0.380 kg/m

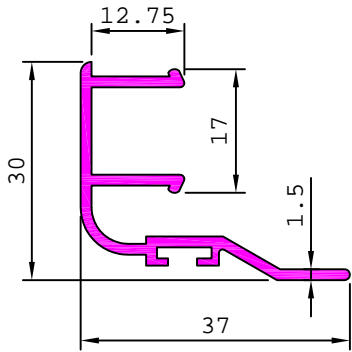

19401 0.457 kg/m

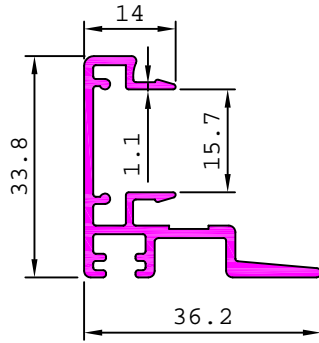

19414 0.332 kg/m

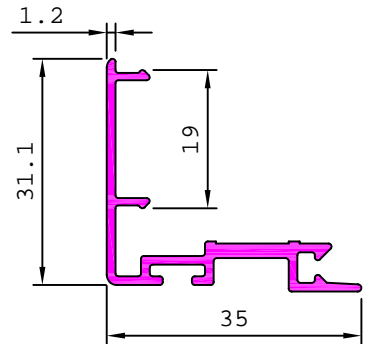

19434 0.491 kg/m

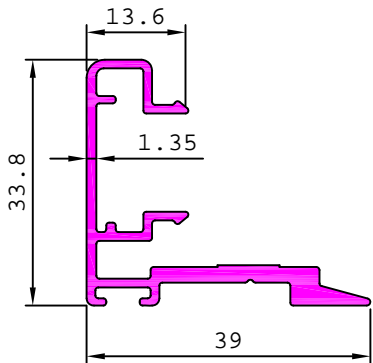

19435 0.310 kg/m

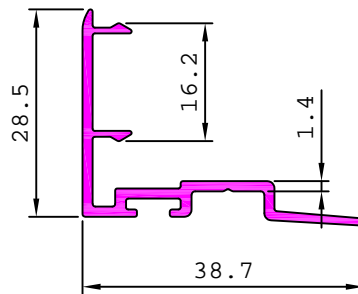

19442 0.328 kg/m

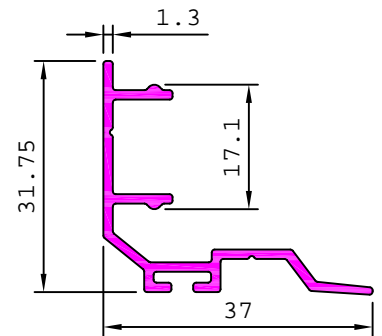

19444 0.468 kg/m

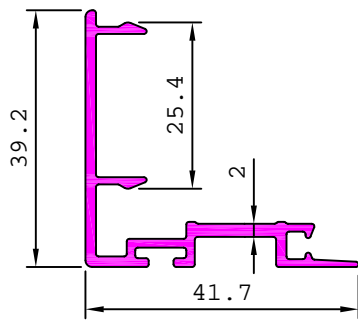

19448 0.396 kg/m

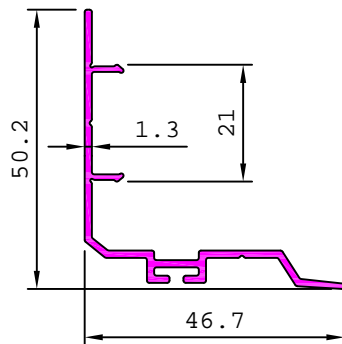

19453 0.303 kg/m

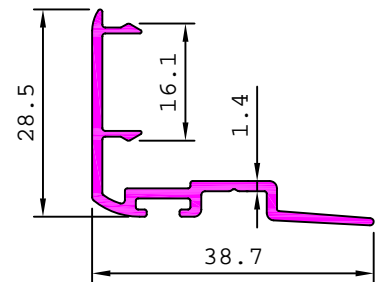

19455 0.433 kg/m

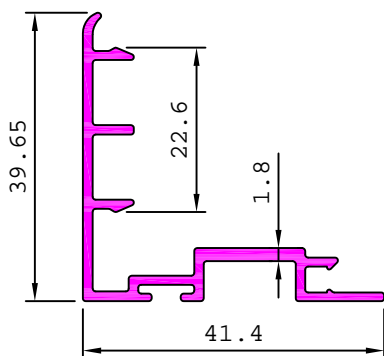

19459 0.312 kg/m

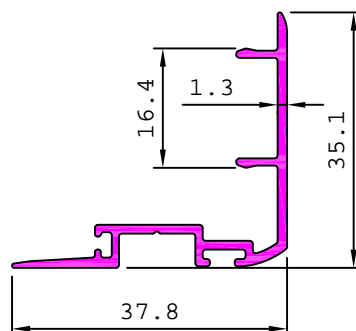

19476 0.359 kg/m

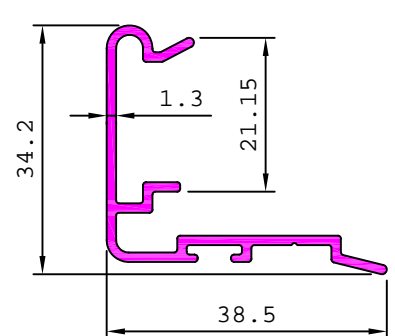

ARCHITECTURAL

GLAZINGS

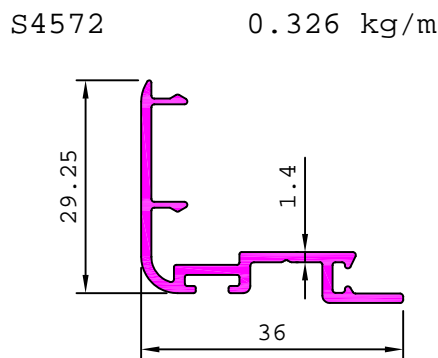
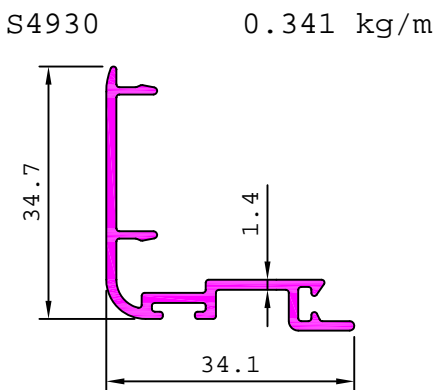
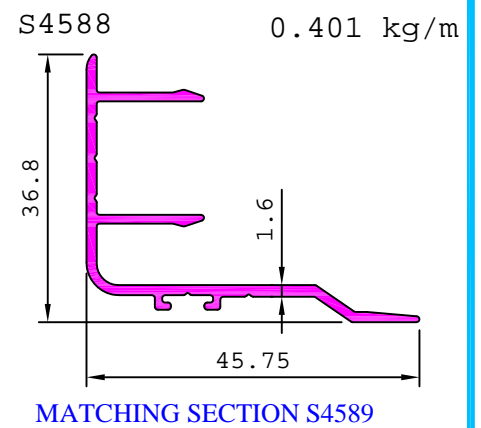
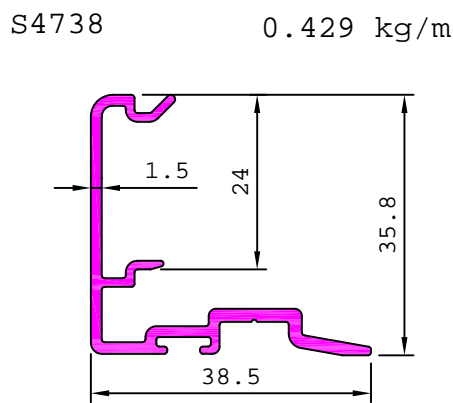
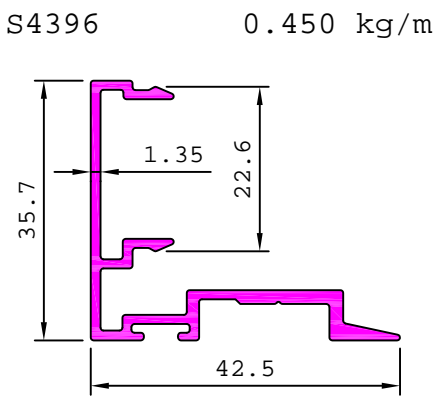
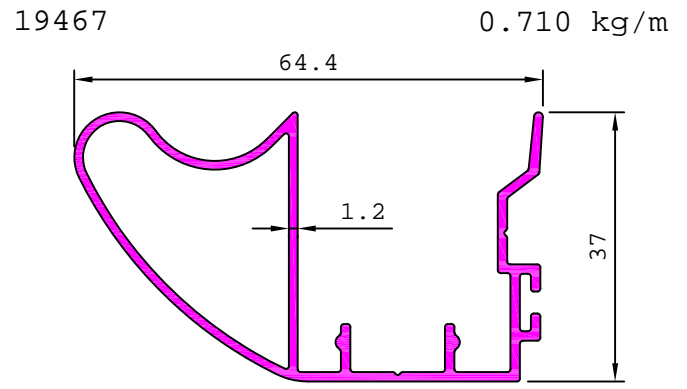
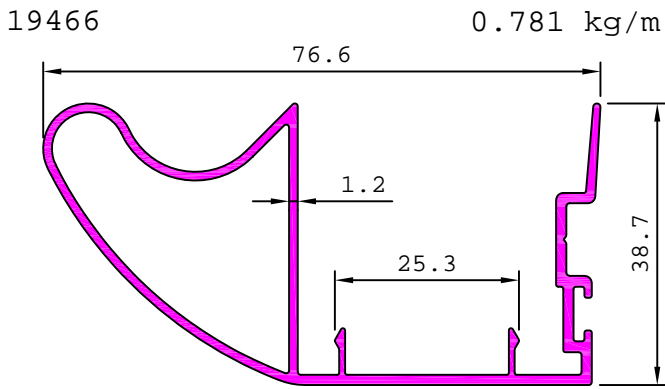

ARCHITECTURAL

DOORS SECTIONS

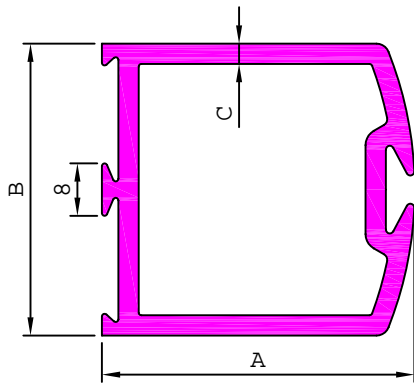

SL. No.	Section No.	A	B	C	Weight kg/m
1	19543	47.62	44.45	0.80	0.493
2	19538	47.62	44.45	1.18	0.667
3	19547	47.62	44.45	1.35	0.759
4	19526	47.62	44.50	1.62	0.881
5	19569	47.62	44.45	2.02	1.052
6	19501	47.62	44.45	3.10	1.509
7	19585	50.00	44.50	1.90	1.030
8	19554	50.00	44.50	2.50	1.292
9	19516	53.70	44.45	2.30	1.238
10	19600	85.00	44.45	1.40	1.037
11	19550	85.00	44.45	1.56	1.139
12	19572	85.00	44.45	1.80	1.301
13	19560	85.00	44.45	2.00	1.417
14	19509	85.00	44.45	3.00	2.050
15	19592	85.00	44.45	3.26	2.200

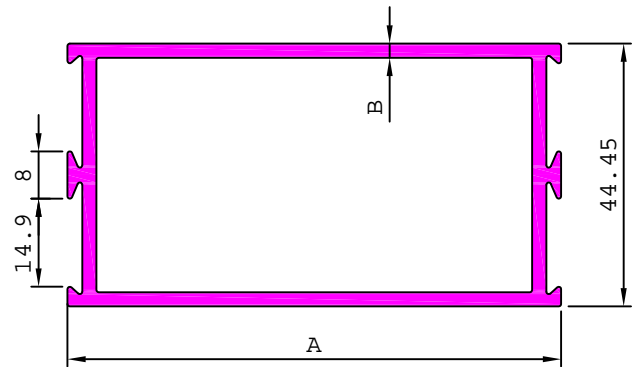

SL. No.	Section No.	A	B	Weight kg/m
1	20006	25.00	2.40	0.918
2	20042	49.91	0.98	0.607
3	20086	49.91	1.30	0.753
4	19575	49.91	1.60	0.882
5	20060	49.91	2.01	1.072
6	20014	49.91	3.00	1.495
7	19625	83.50	1.28	0.976
8	19599	83.50	1.40	1.052
9	19551	83.50	1.54	1.139
10	19535	83.50	1.70	1.243
11	20111	83.50	2.11	1.497
12	19525	83.50	2.40	1.679
13	19583	83.50	3.18	2.145
14	19564	100.00	2.00	1.603
15	19653	100.00	3.00	2.302
16	20002	150.00	2.65	2.779
17	19596	150.00	3.00	3.116
18	19620	200.00	3.00	3.926

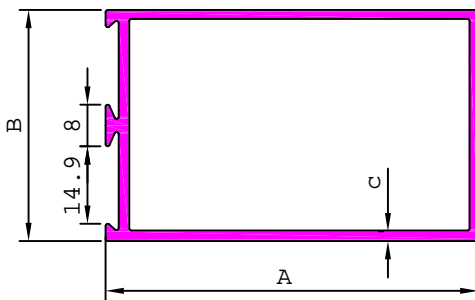

SL. No.	Section No.	A	B	C	Weight kg/m
1	19542	47.62	44.45	1.14	0.607
2	19527	47.62	44.45	1.74	0.881
3	20071	47.62	44.45	1.88	0.943
4	20061	47.62	44.45	2.17	1.072
5	19512	47.62	44.45	3.00	1.426
6	19548	47.62	44.50	1.42	0.738
7	19549	83.50	44.45	1.62	1.139
8	19582	83.50	44.45	1.87	1.300
9	19508	83.50	44.45	3.00	2.107
10	19647	83.50	44.45	4.00	2.609
11	19568	104.00	44.45	1.80	1.600

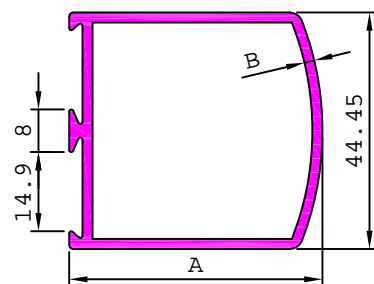

SL. No.	Section No.	A	B	Weight kg/m
1	19570	47.62	1.90	0.911
2	19502	47.62	2.82	1.294
3	19518	53.70	2.30	1.173

ARCHITECTURAL

DOORS SECTIONS

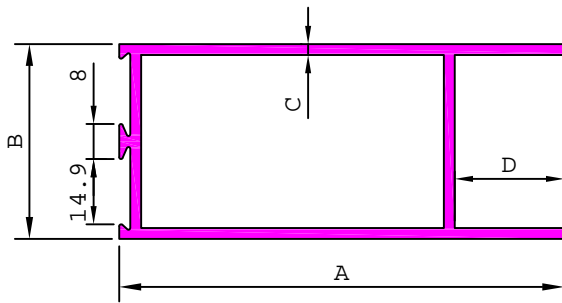

SL. No.	Section No.	A	B	C	D	Weight kg/m
1	19576	47.62	44.45	0.99	10.15	0.537
2	19539	47.62	44.45	1.40	10.20	0.719
3	19637	47.62	44.45	1.67	10.20	0.850
4	19528	47.62	44.45	1.74	10.16	0.881
5	19571	47.62	44.45	1.95	10.16	0.974
6	19503	47.62	44.45	3.18	10.16	1.501
7	19555	50.00	44.50	2.50	9.50	1.247
8	19580	83.50	44.45	1.49	9.50	1.055
9	20140	83.50	44.45	1.26	9.50	0.935
10	19581	83.50	44.45	2.00	9.50	1.384
11	19593	83.50	44.45	3.27	9.50	2.172
12	19648	83.50	44.45	4.00	9.50	2.609
13	19563	85.00	44.45	2.70	10.00	1.843
14	19544	95.25	44.45	0.89	25.40	0.719
15	19540	95.25	44.45	1.16	25.40	0.911
16	19529	95.25	44.45	1.70	25.40	1.301
17	19505	95.25	44.45	2.00	25.40	1.511
18	19556	101.60	44.50	2.50	25.00	1.943
19	19541	114.30	44.45	1.29	25.40	1.139
20	19534	114.30	44.45	1.35	10.15	1.190
21	19530	114.30	44.45	1.49	25.40	1.302
22	19623	114.30	44.45	1.68	10.15	1.459
23	19567	114.30	44.45	1.75	10.15	1.516
24	19559	114.30	44.45	1.95	10.15	1.674
25	19573	114.30	44.45	2.15	10.15	1.836
26	19574	114.30	44.45	2.15	25.40	1.836
27	19591	114.30	44.45	2.42	10.15	2.051
28	19510	114.30	44.45	3.18	10.15	2.646
29	19511	114.30	44.45	3.18	25.40	2.646
30	19517	150.00	44.45	2.20	25.40	2.376
31	19584	150.00	44.45	3.10	25.40	3.181
32	19621	200.00	44.45	3.00	25.40	3.894

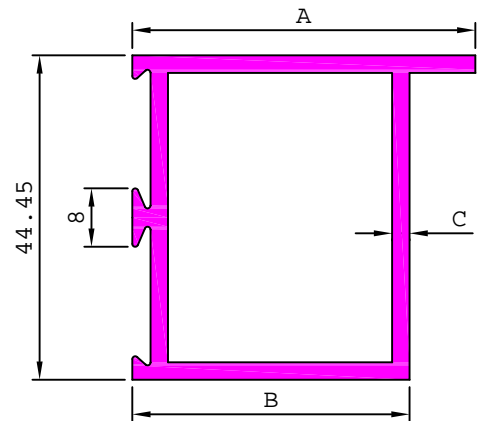

SL. No.	Section No.	A	B	C	Weight kg/m
1	19566	47.00	38.00	2.40	1.102
2	19616	47.00	38.00	4.20	1.797
3	19579	47.50	38.25	1.58	0.769
4	19636	47.62	37.46	3.00	1.344
5	20138	83.50	73.35	1.46	0.998
6	19590	83.50	73.35	1.55	1.053

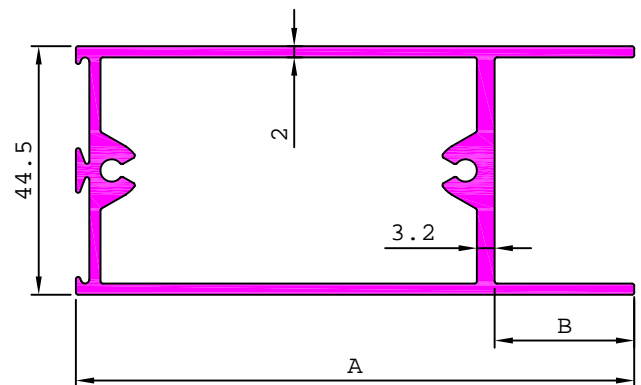

SL. No.	Section No.	A	B	Weight kg/m
1	19520	48.00	9.50	1.342
2	19519	100.00	25.00	1.917

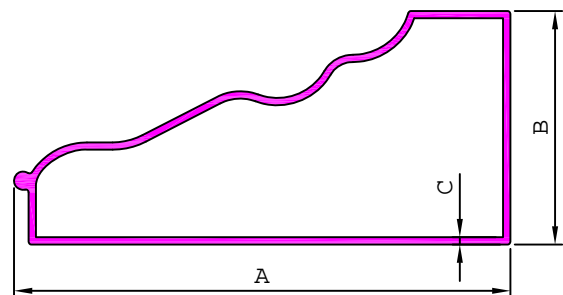

SL. No.	Section No.	A	B	C	Weight kg/m
1	19607	68.00	32.00	0.80	0.397
2	19597	68.00	32.00	1.00	0.492

ARCHITECTURAL

DOORS SECTIONS

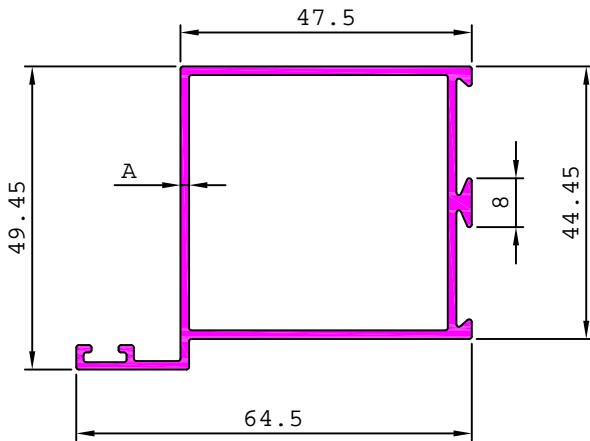

SL. No.	Section No.	A	Weight kg/m
1	19613	1.40	0.830
2	19565	2.40	1.281

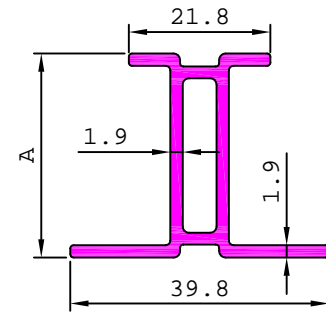

SL. No.	Section No.	A	Weight kg/m
1	29300	31.40	0.588
2	28913	35.40	0.629
3	19640	41.40	0.691

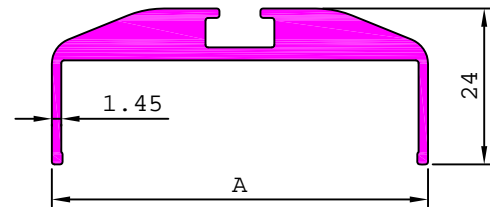

SL. No.	Section No.	A	Weight kg/m
1	19650	48.00	0.774
2	19649	57.90	0.988

19578

1.006 kg/m

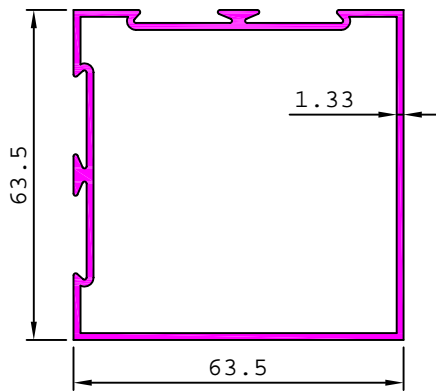

19514

1.415 kg/m

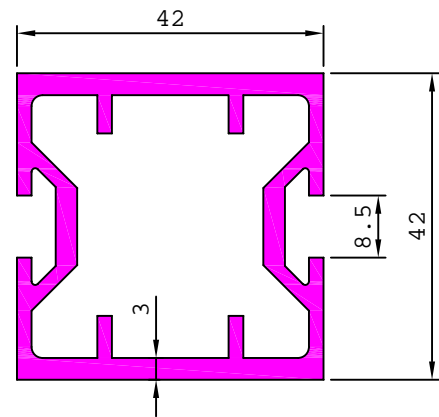

19614

1.243 kg/m

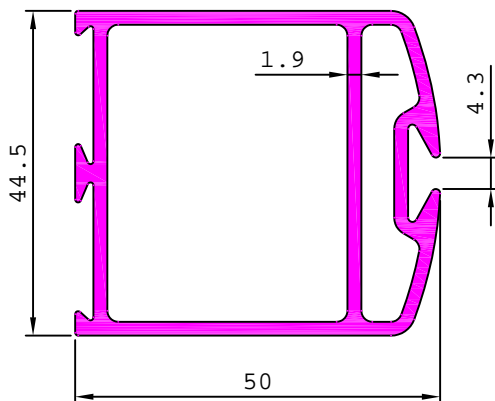

19589

0.777 kg/m

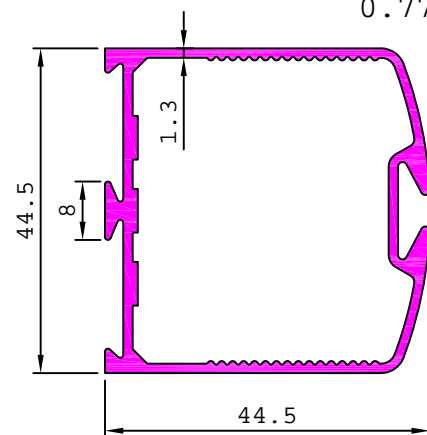

ARCHITECTURAL

DOORS SECTIONS

19601

1.481 kg/m

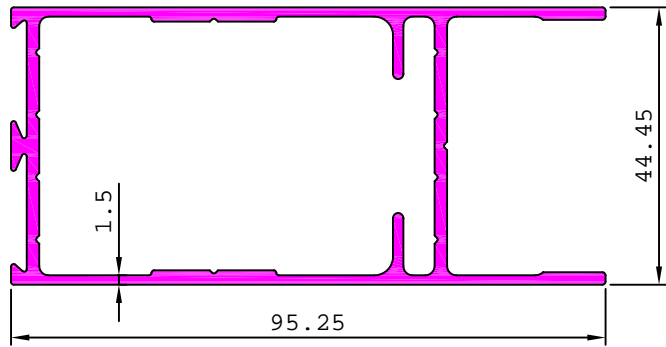

19531

0.924 kg/m

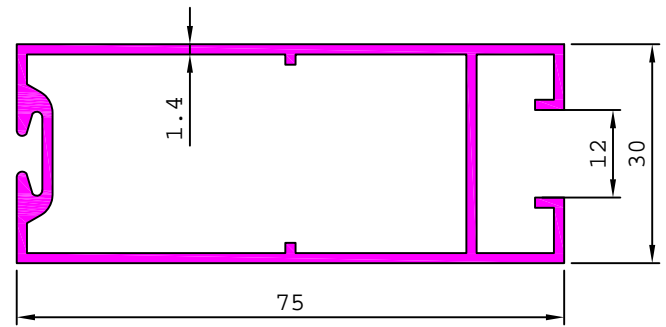

19632

3.546 kg/m

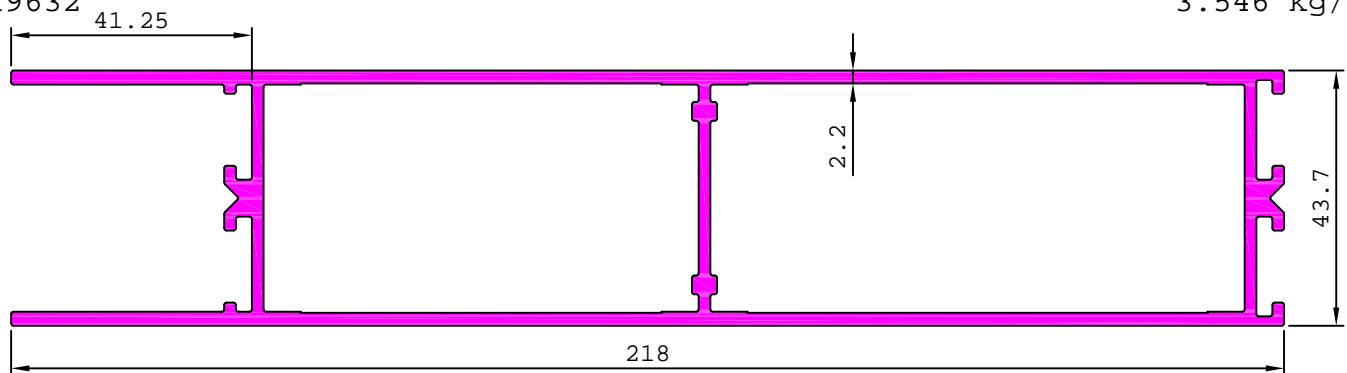

19634

1.840 kg/m

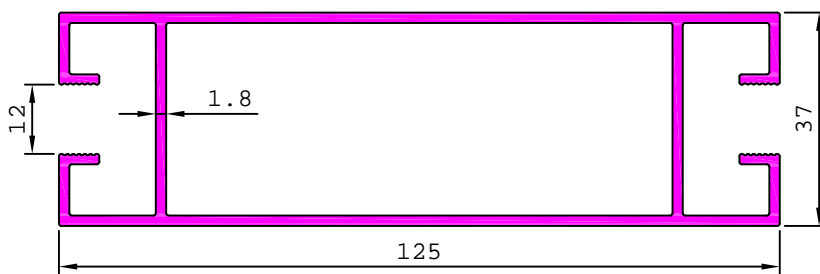

19545

2.959 kg/m

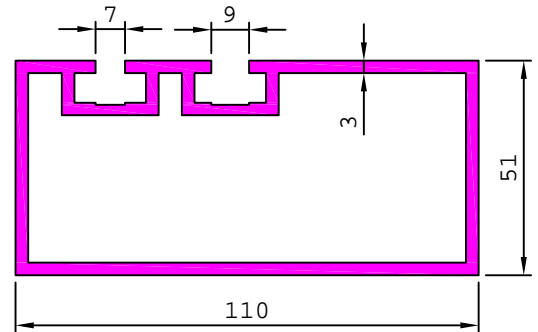

19630

5.093 kg/m

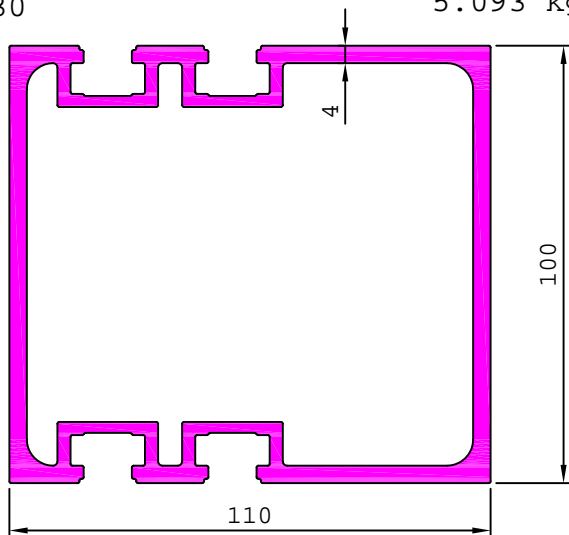

21339

1.318 kg/m

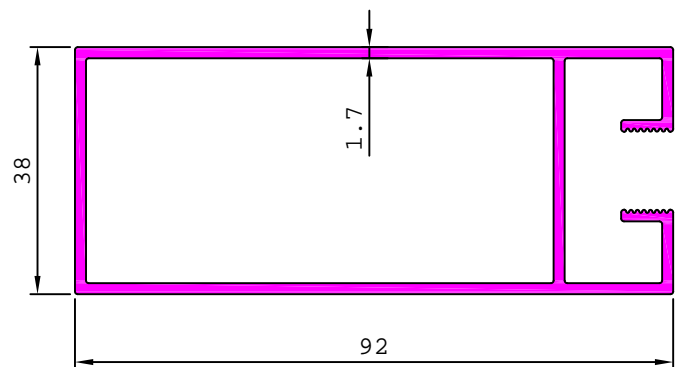

ARCHITECTURAL

DOORS SECTIONS

19515

3.170 kg/m

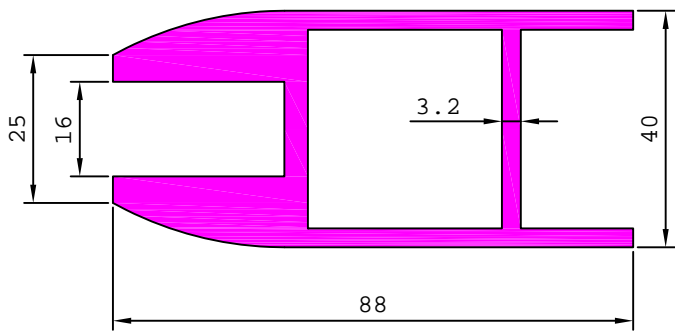

19546

2.725 kg/m

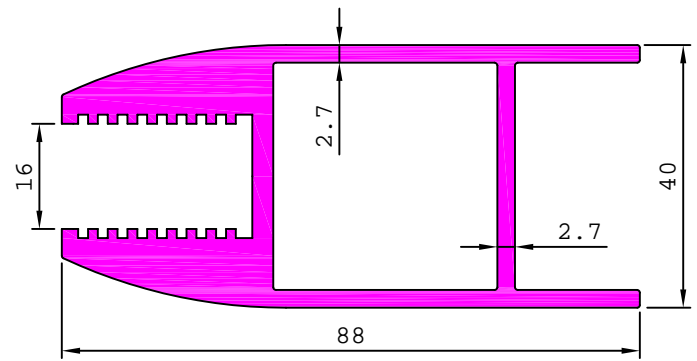

19595

2.325 kg/m

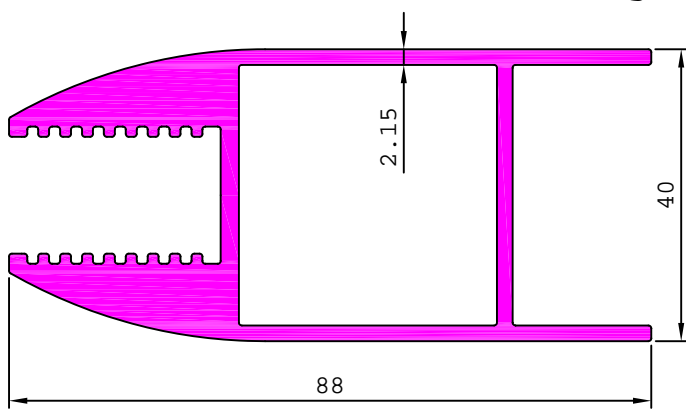

19611

1.527 kg/m

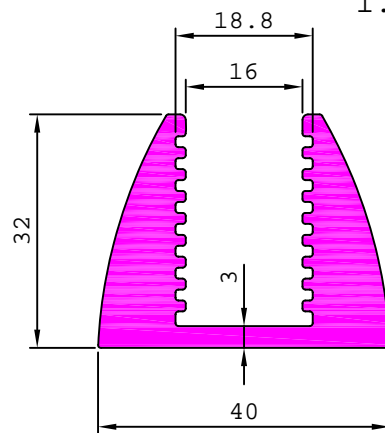

19602

1.581 kg/m

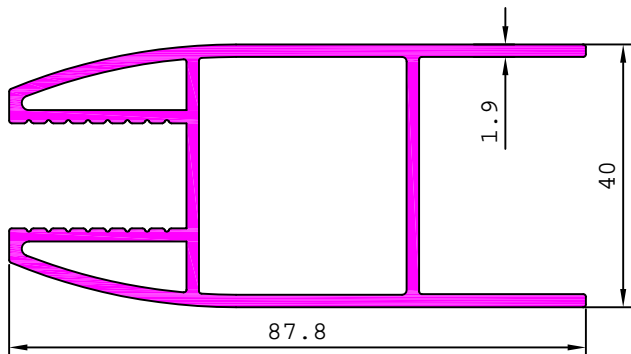

19646

0.914 kg/m

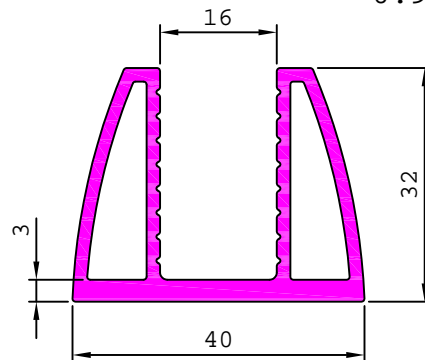

ARCHITECTURAL

DOORS SECTIONS

19504 1.324 kg/m

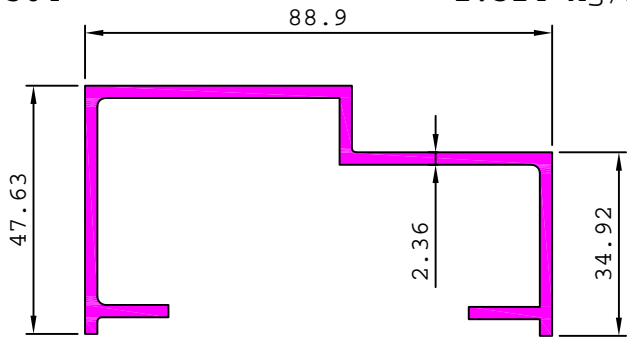

19594 1.285 kg/m

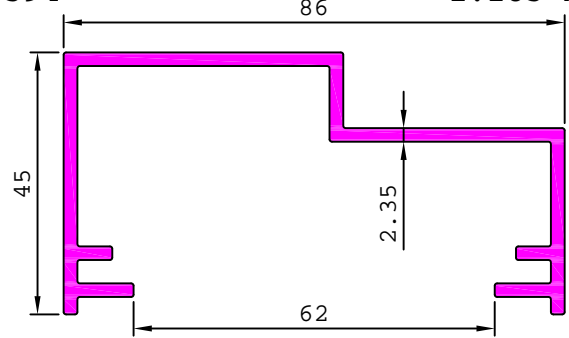

19626 0.745 kg/m

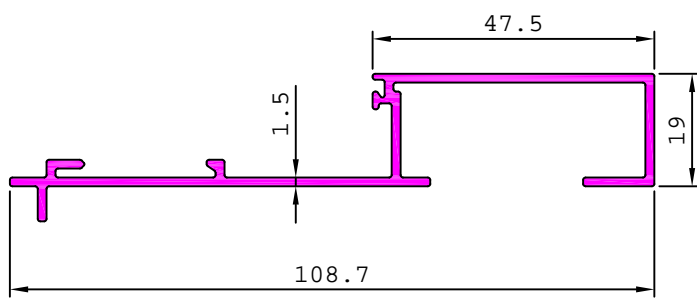

19552 1.116 kg/m

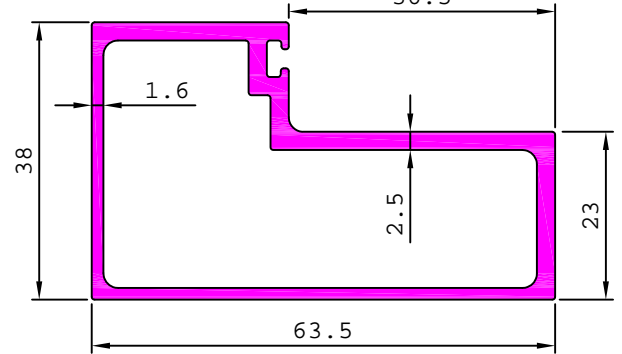

19557 1.248 kg/m

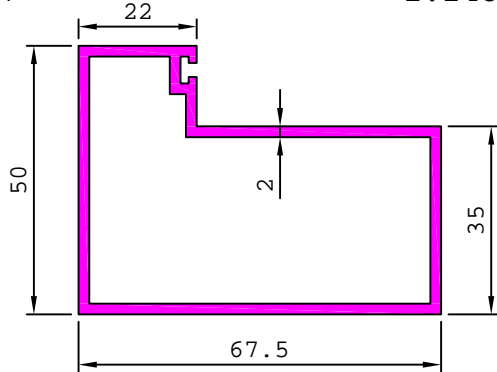

19609 0.974 kg/m

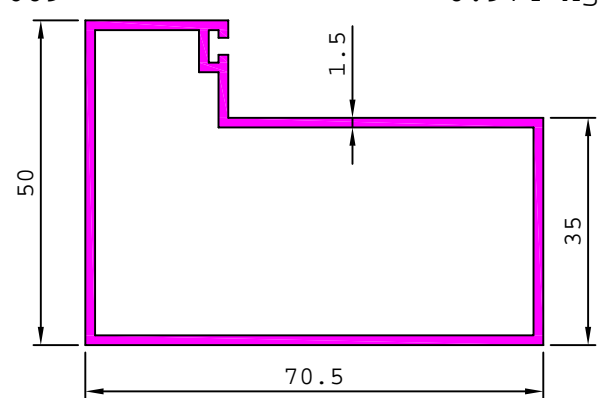

19612 2.043 kg/m

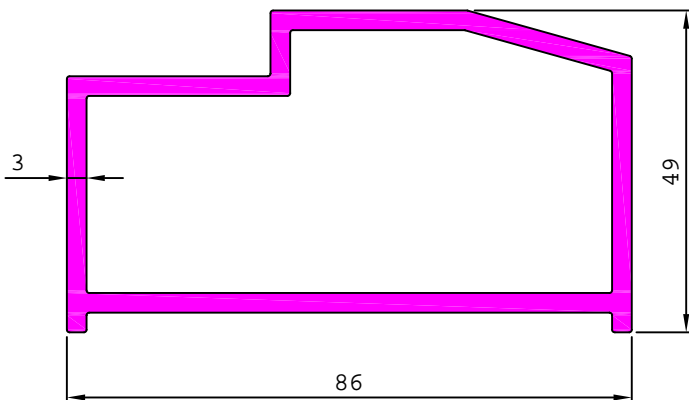

19619 1.124 kg/m

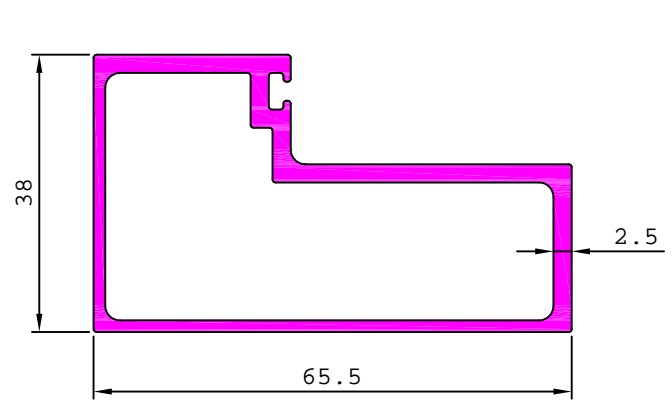

ARCHITECTURAL

DOORS SECTIONS

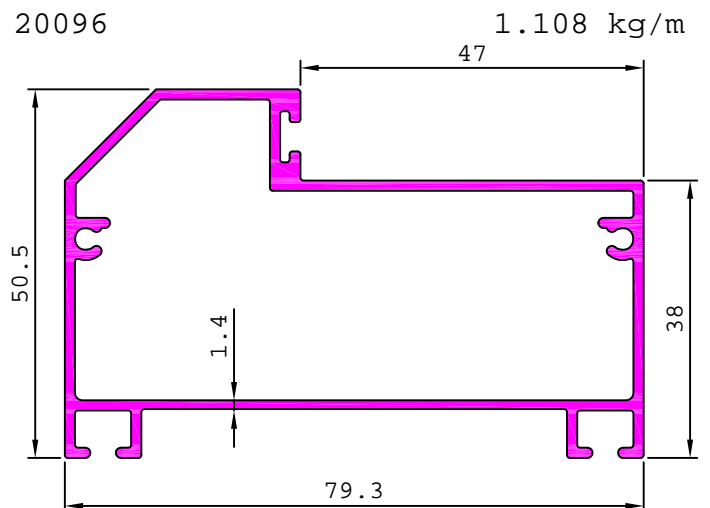
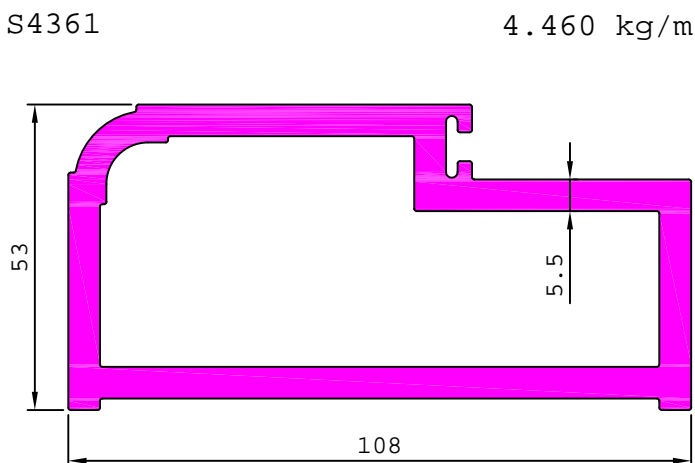
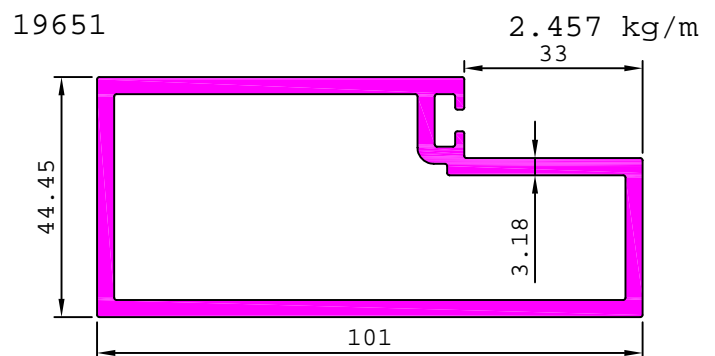
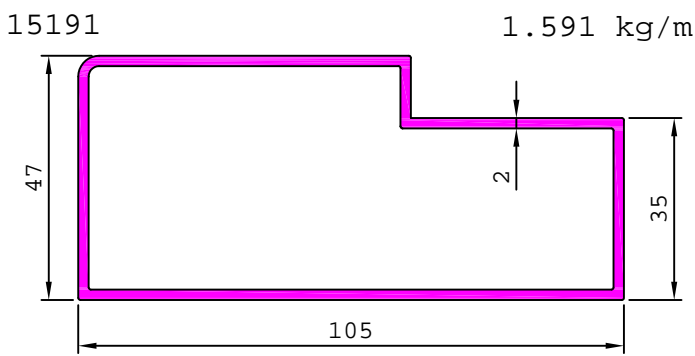
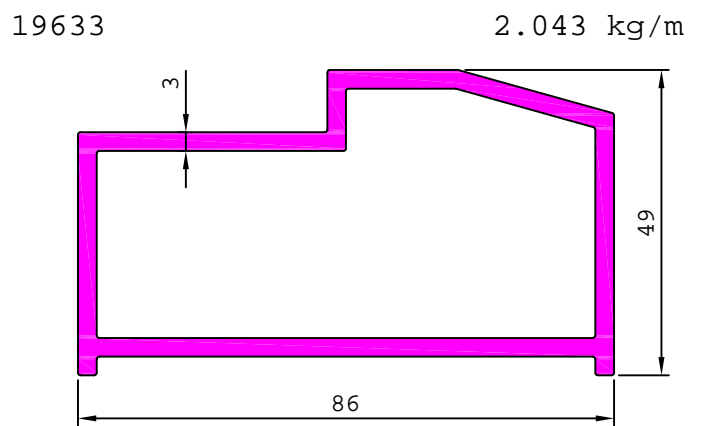
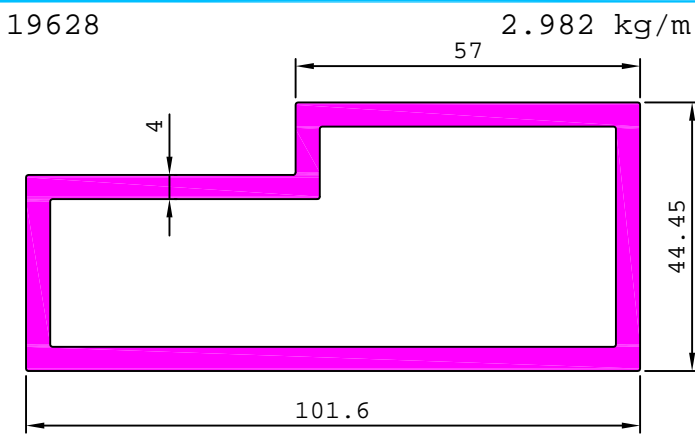
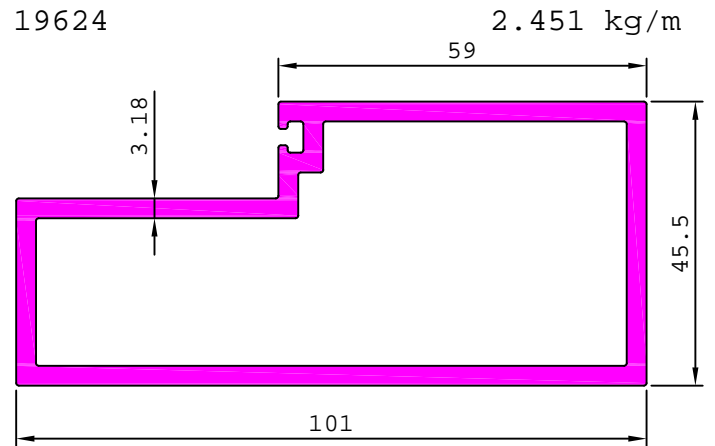
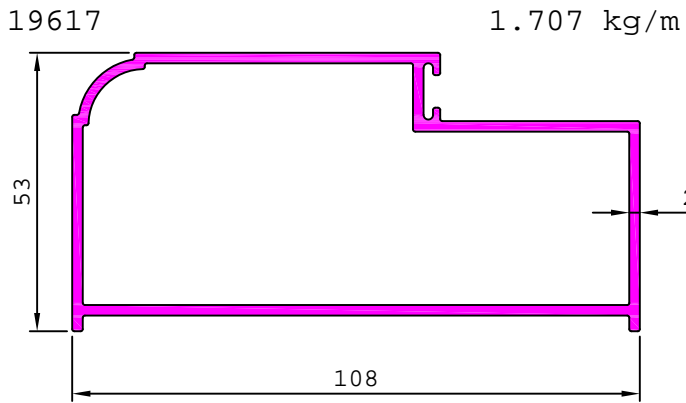

ARCHITECTURAL

DOORS SECTIONS

20110

1.013 kg/m

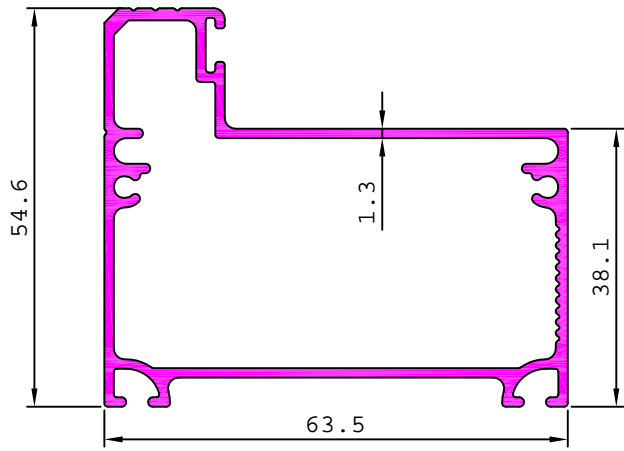

20149

1.999 kg/m

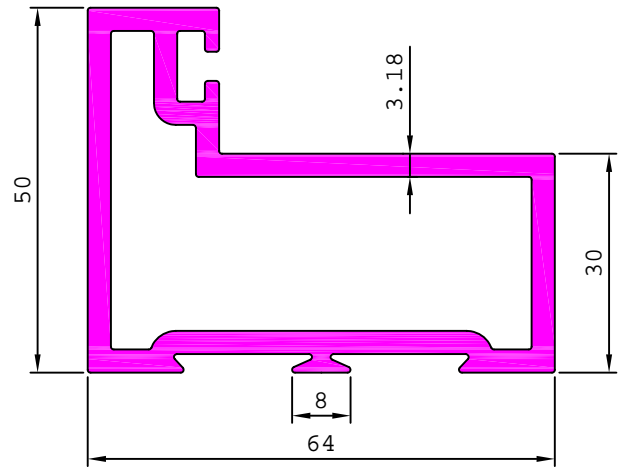

38521

1.259 kg/m

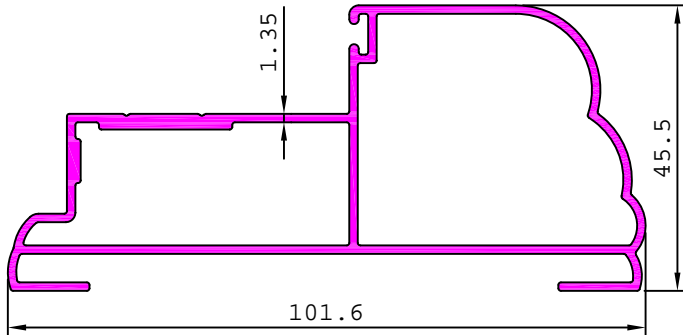

ARCHITECTURAL

DOORS SECTIONS

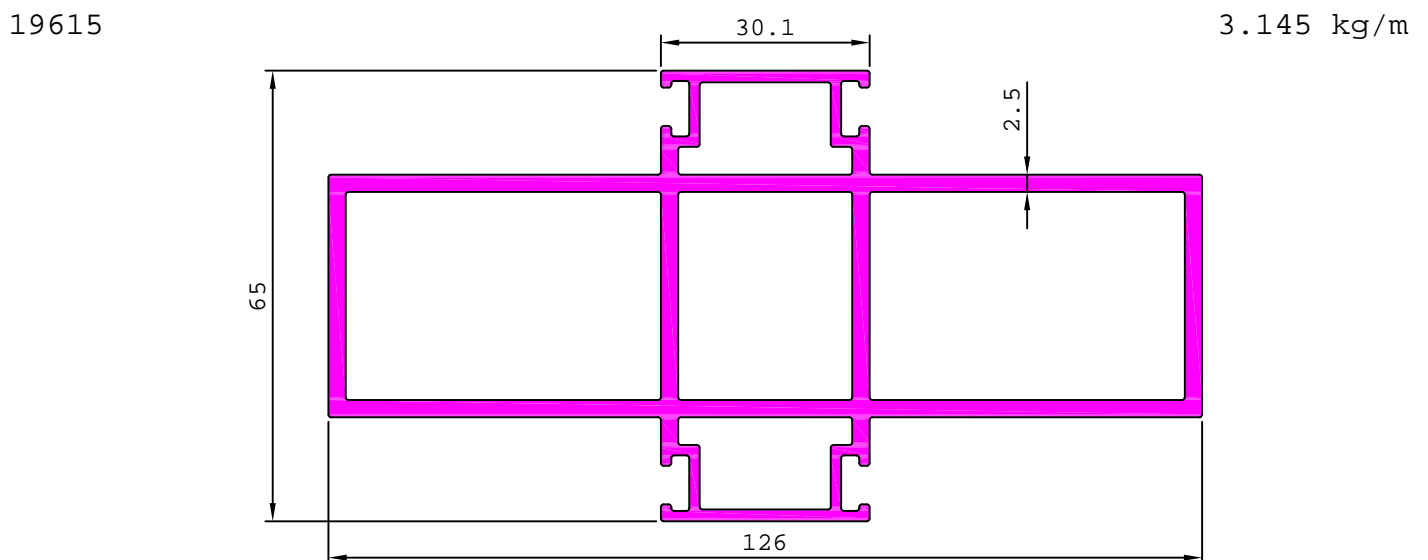
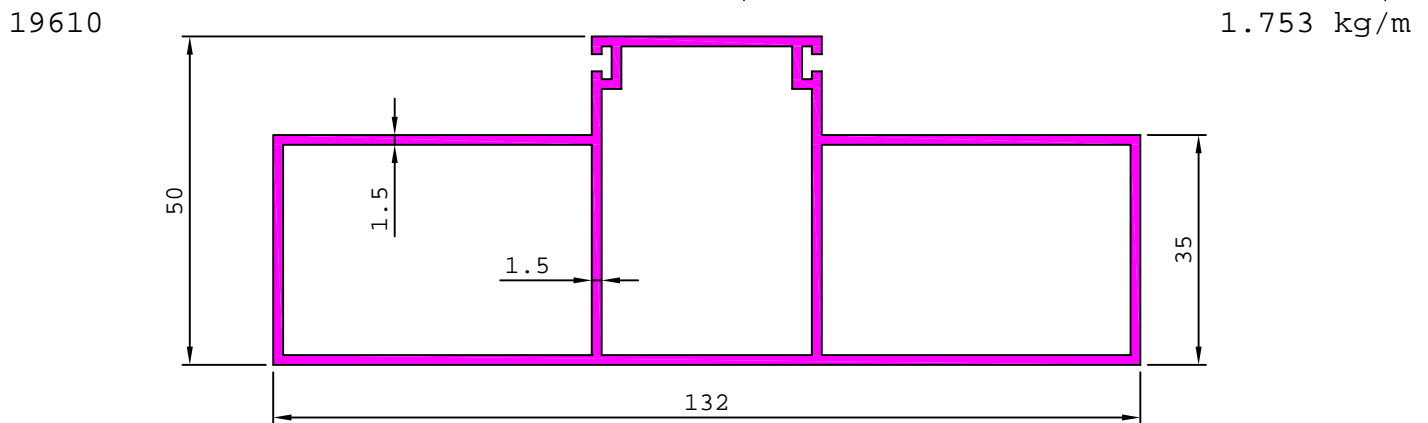
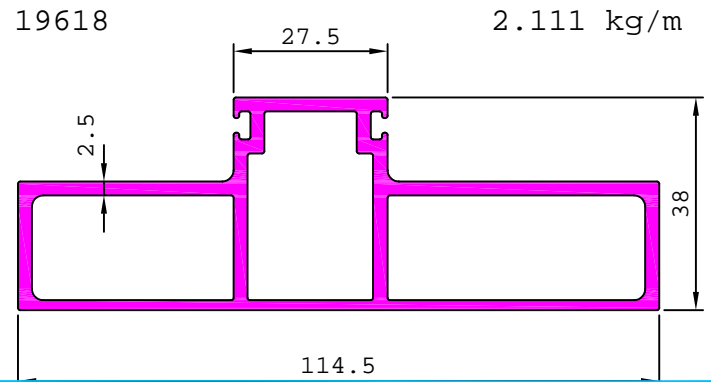
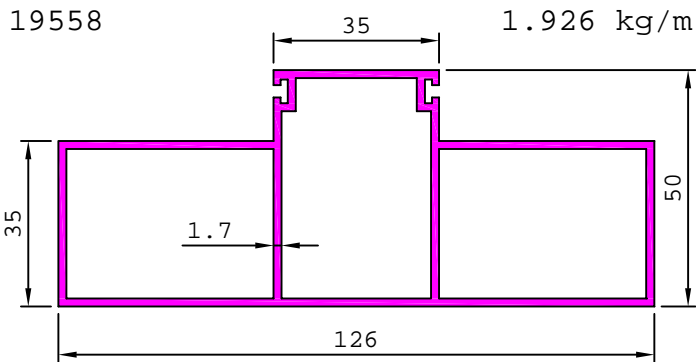
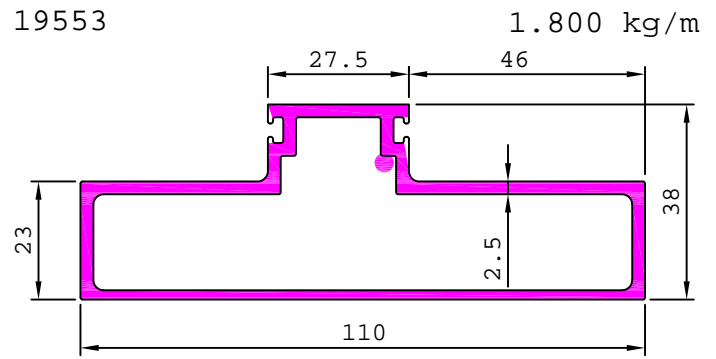
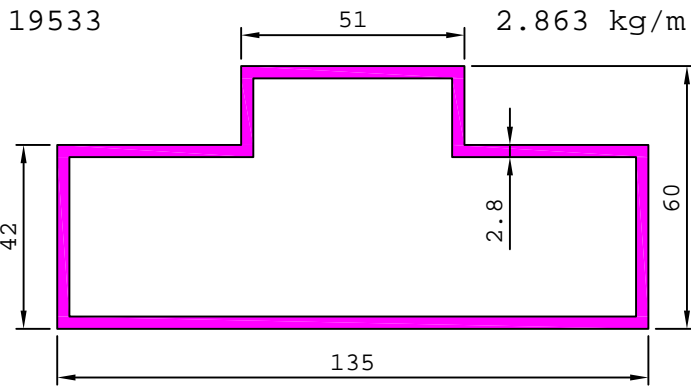

ARCHITECTURAL

DOORS SECTIONS

19635

1.876 kg/m

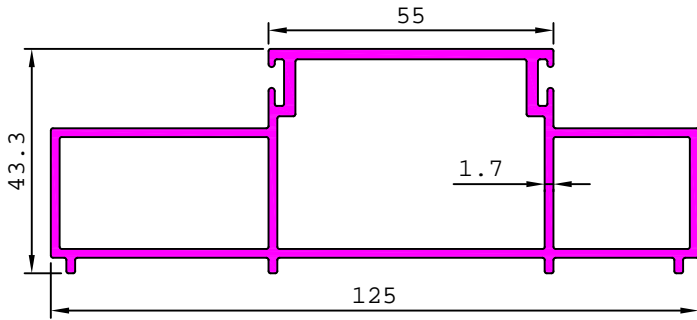

19622

1.986 kg/m

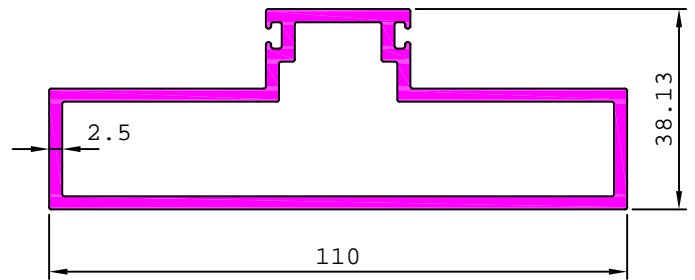

19654

2.393 kg/m

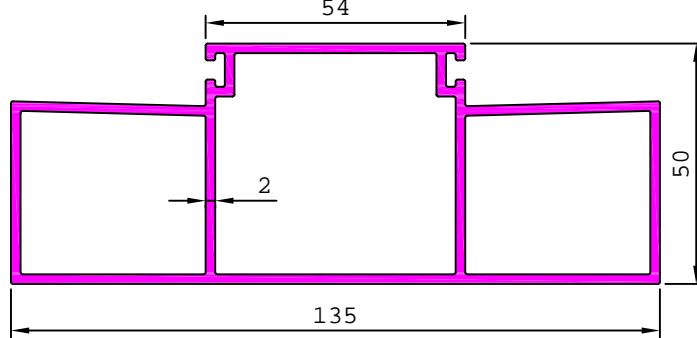

S4564

3.425 kg/m

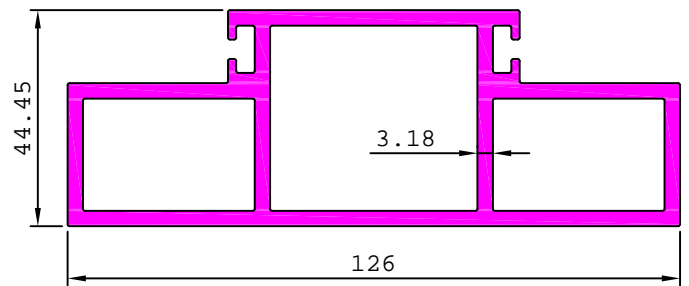

21473

0.988 kg/m

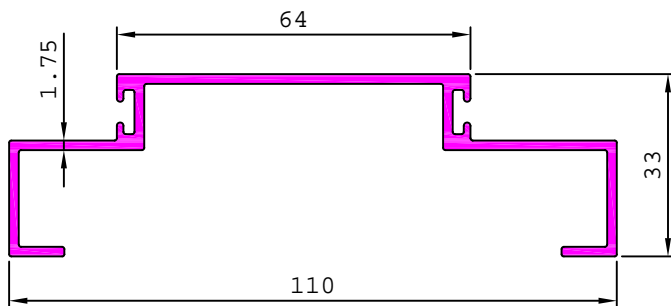

21474

1.881 kg/m

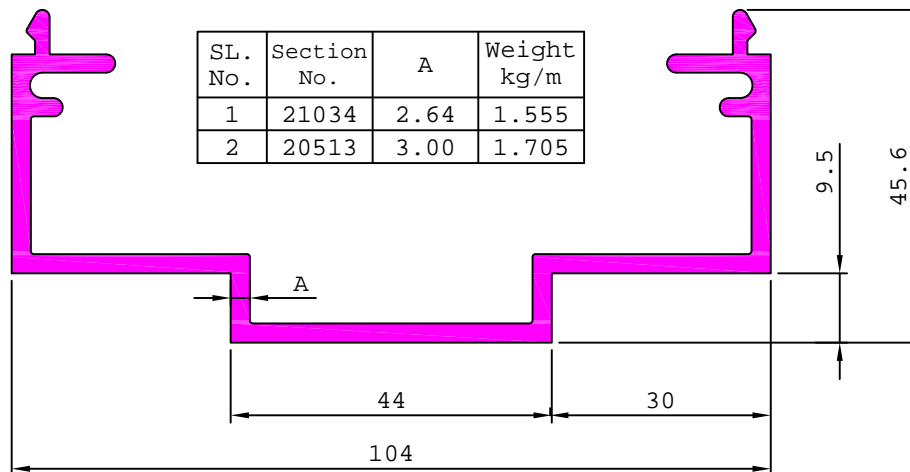
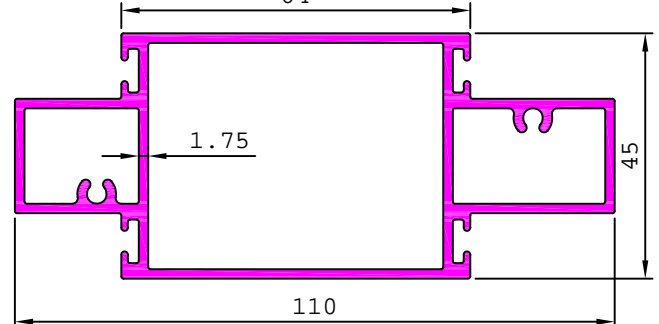

ARCHITECTURAL

DOORS SECTIONS

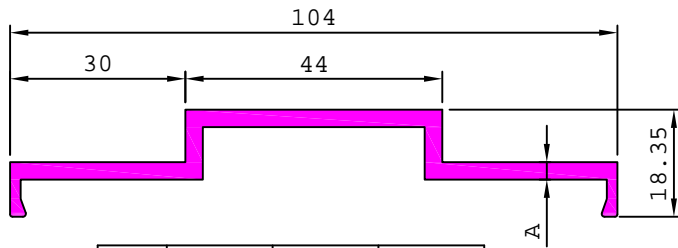

SL. No.	Section No.	A	Weight kg/m
1	21033	2.64	0.945
2	20515	3.00	1.056

ARCHITECTURAL

DOORS SECTIONS

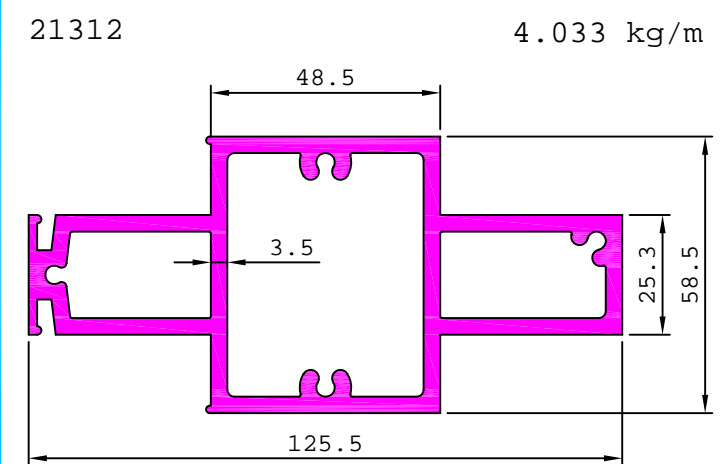
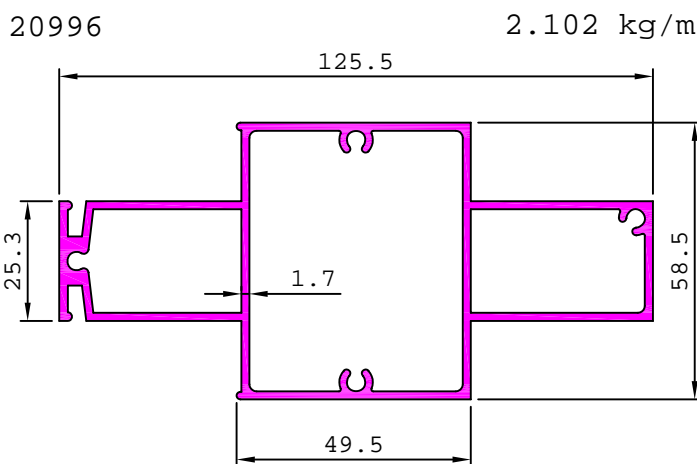
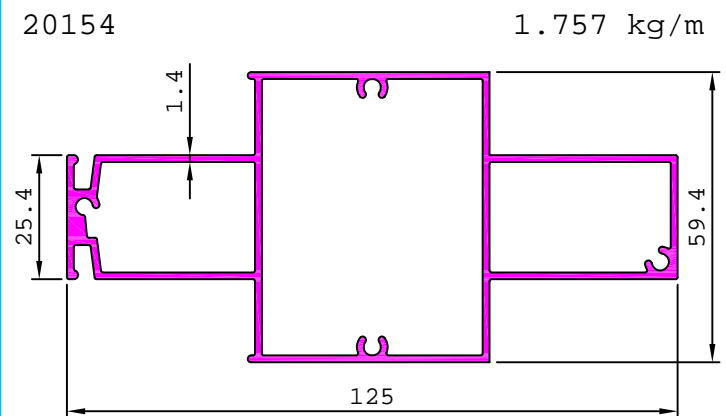
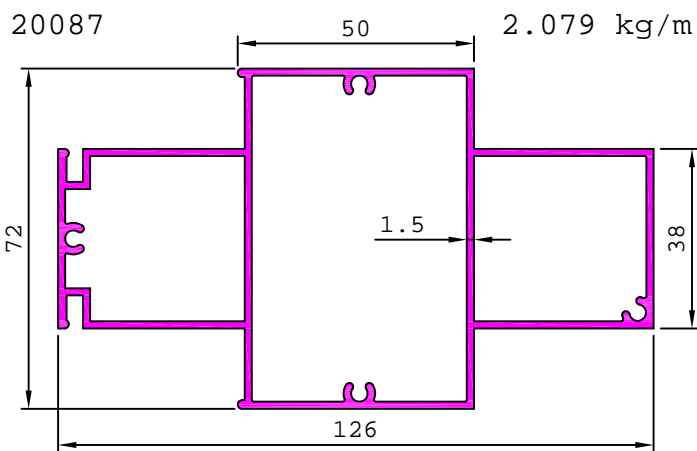
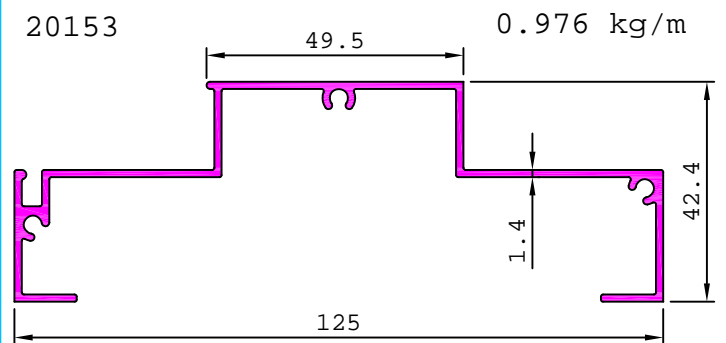
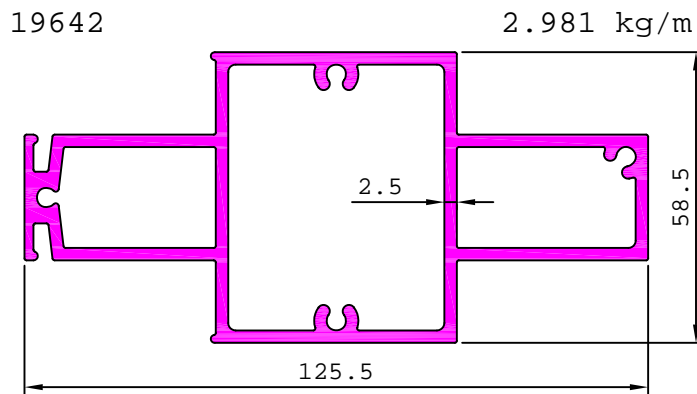
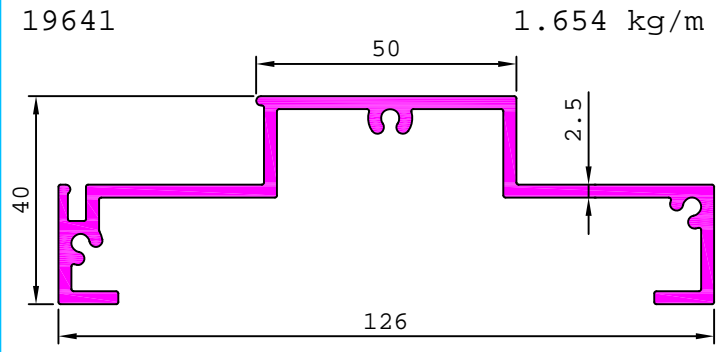
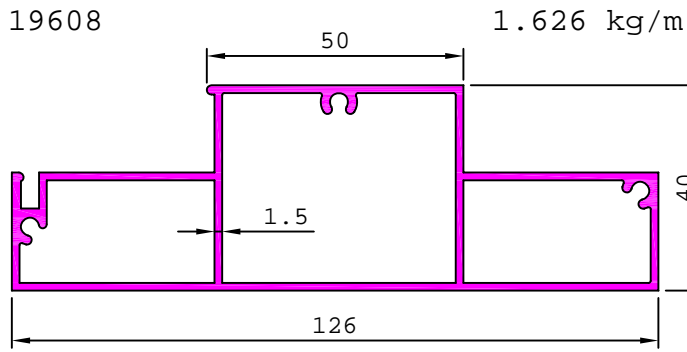

ARCHITECTURAL

DOORS SECTIONS

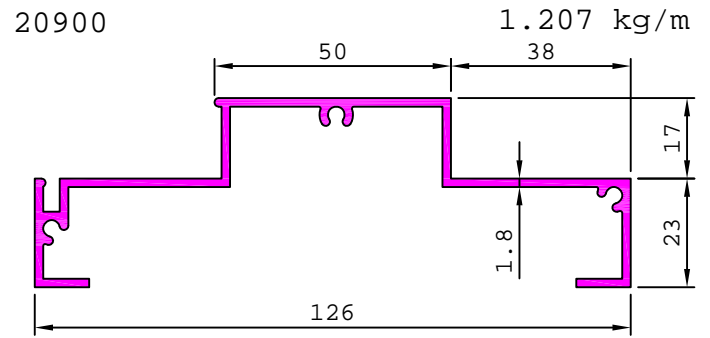
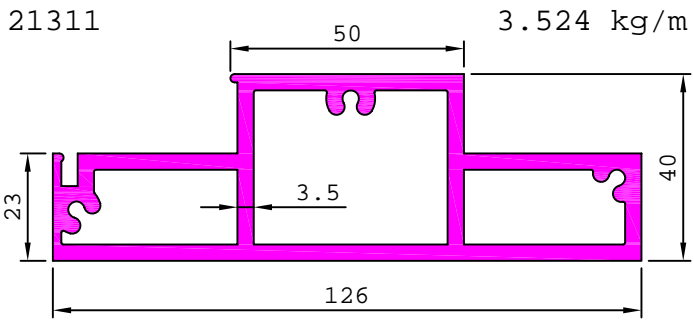

ARCHITECTURAL

DOORS SECTIONS

19598

0.632 kg/m

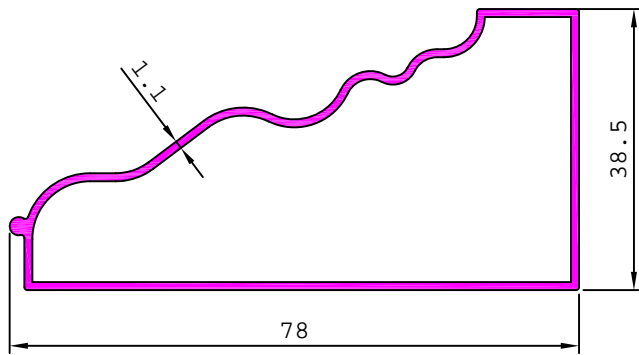

19603

0.529 kg/m

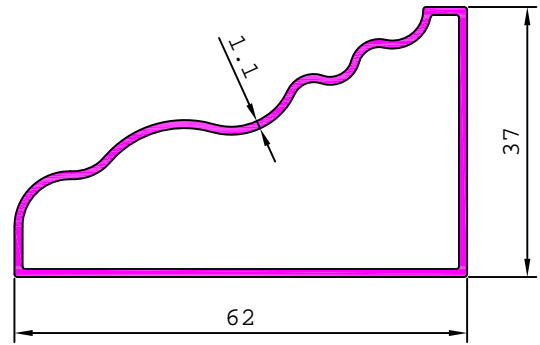

19604

0.655 kg/m

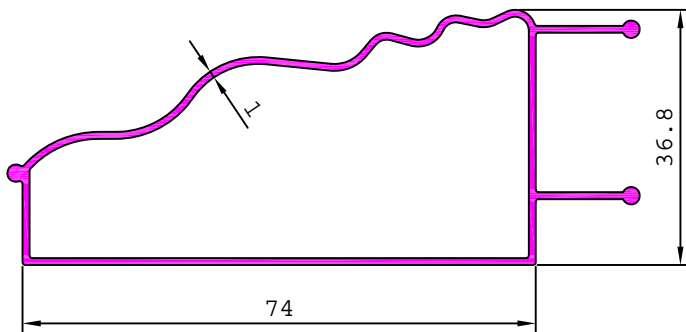

19606

0.434 kg/m

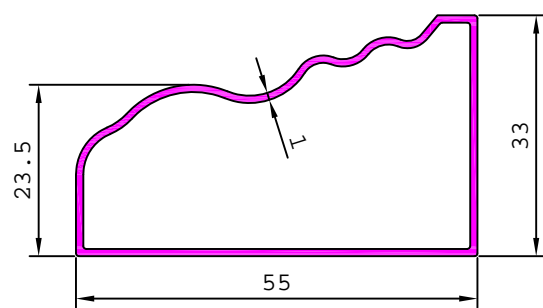

ARCHITECTURAL

DOORS SECTIONS

19631 1.450 kg/m

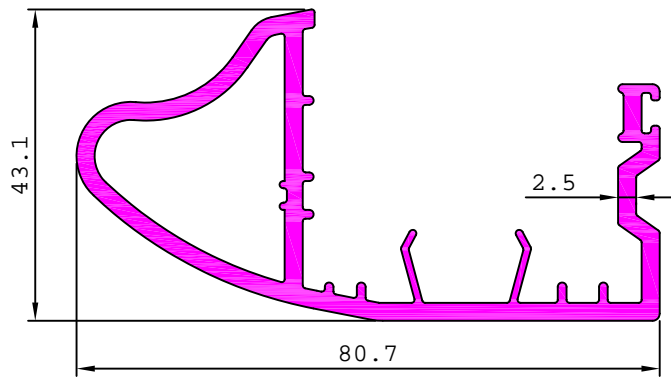

19639 0.785 kg/m

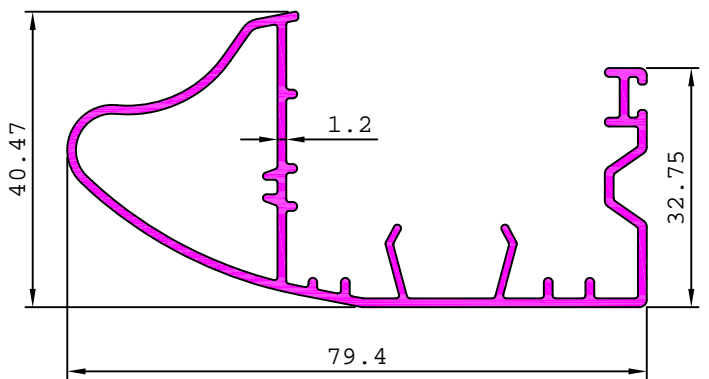

19466 0.781 kg/m

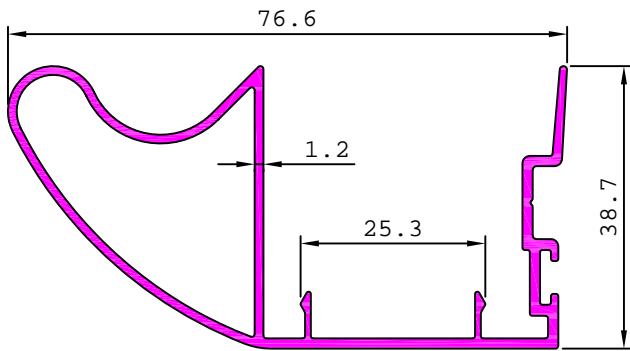

19467 0.710 kg/m

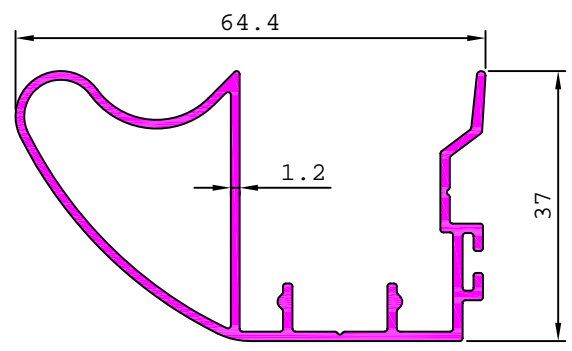

29562 1.655 kg/m

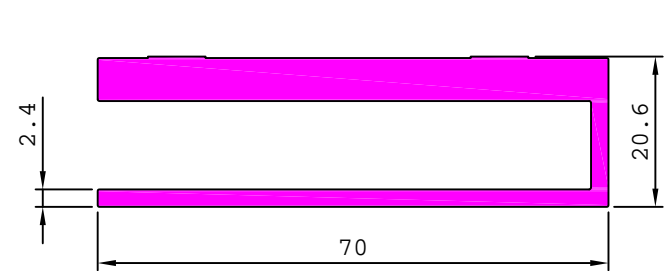

19638 1.687 kg/m

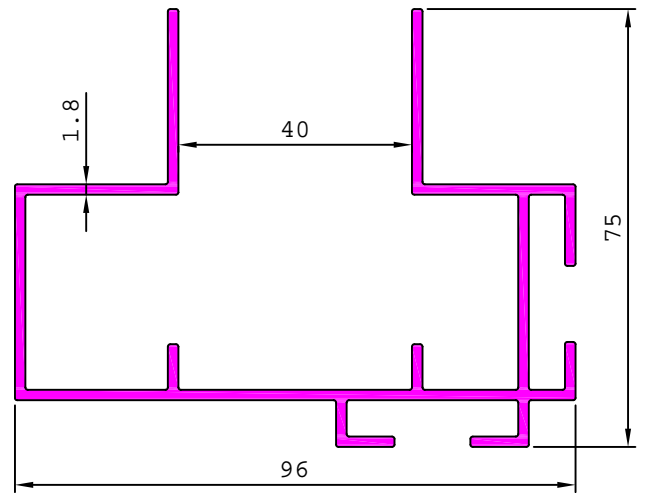

19644 0.808 kg/m

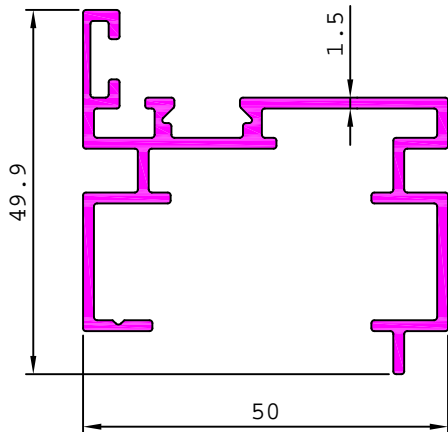

19643 0.952 kg/m

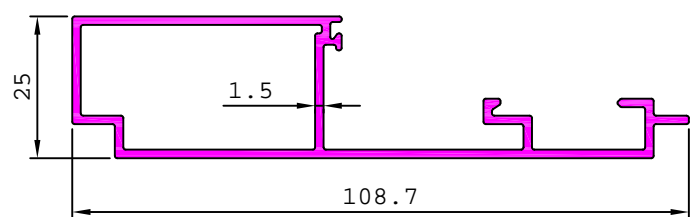

ARCHITECTURAL

DOORS SECTIONS

19645 0.552 kg/m

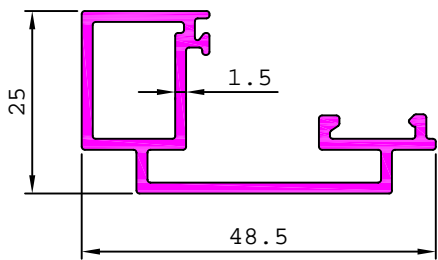

19655 0.913 kg/m

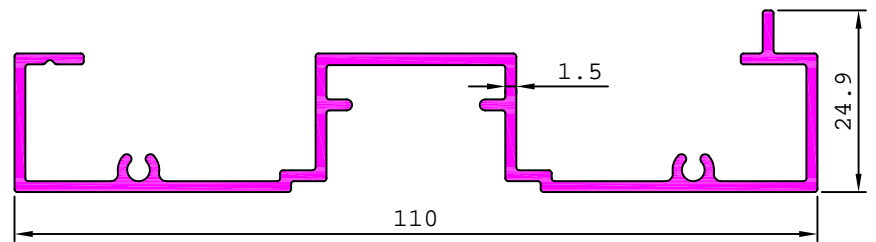

19656 0.859 kg/m

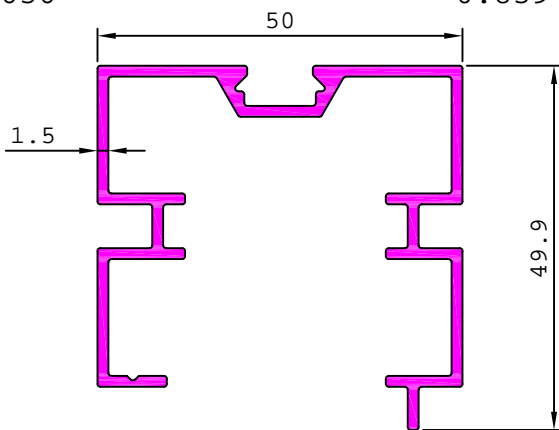

19652 1.172 kg/m

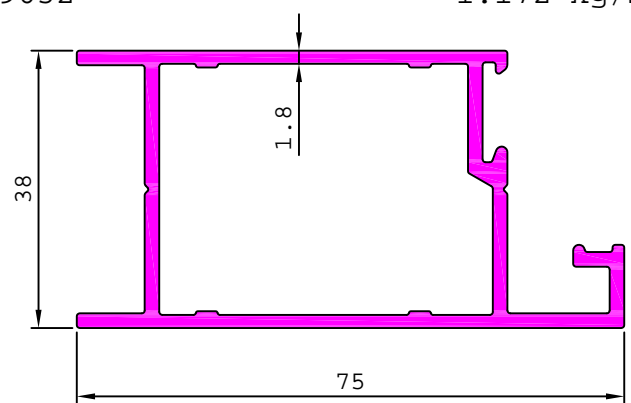

15171 0.580 kg/m

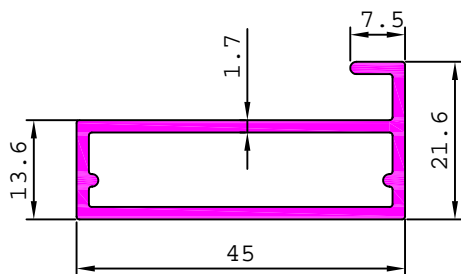

ARCHITECTURAL

PARTITION SECTION

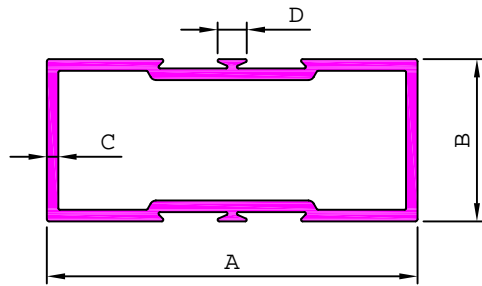

DOUBLE GROOVE

SL. No.	Section No.	A	B	C	D	Weight kg/m
1	20089	47.80	24.00	0.59	7.50	0.316
2	20050	50.80	25.40	0.63	7.50	0.350
3	20044	50.80	25.40	0.79	7.50	0.414
4	20079	50.80	25.40	0.98	7.50	0.496
5	20031	50.80	25.40	1.19	7.50	0.581
6	20017	50.80	25.40	1.34	8.00	0.651
7	20046	63.50	38.10	0.66	7.50	0.455
8	20069	63.50	38.10	0.83	7.50	0.547
9	20034	63.50	38.10	0.92	7.50	0.593
10	20053	63.50	38.10	1.08	7.50	0.686
11	20026	63.50	38.10	1.21	7.50	0.761
12	20062	63.50	38.10	1.28	8.00	0.805
13	20047	63.50	38.10	1.53	8.00	0.942
14	20072	63.50	38.10	1.85	8.00	1.095
15	20064	63.50	38.10	2.50	8.00	1.444
16	20004	63.50	38.10	3.18	8.00	1.790
17	20143	75.00	38.10	1.20	8.00	0.832
18	20144	75.00	45.00	1.25	8.00	0.908
19	20037	82.50	38.00	1.10	8.00	0.833
20	20124	89.00	32.00	1.50	8.00	1.079
21	20035	82.50	38.00	1.60	8.00	1.139
22	S4628	82.50	38.00	3.18	8.00	2.115
23	20021	89.00	32.00	2.75	8.00	1.905
24	20023	89.00	32.00	2.75	23.00	2.150
25	20147	92.00	31.75	1.30	8.00	0.972
26	20152	92.00	31.75	2.00	8.00	1.422
27	20051	101.60	44.45	1.20	8.00	1.060
28	20028	101.60	44.45	1.50	8.00	1.301
29	20076	101.60	44.45	1.93	8.00	1.608
27	20075	101.60	44.45	2.40	8.00	1.954
27	20057	101.60	44.45	2.50	8.00	2.050
28	20066	101.60	44.45	3.00	8.00	2.415
29	20010	101.60	44.45	3.18	8.00	2.683
30	20113	101.60	44.45	3.60	8.00	2.849
31	20145	116.00	44.50	1.50	8.00	1.404
32	20081	123.00	44.45	1.50	8.00	1.456

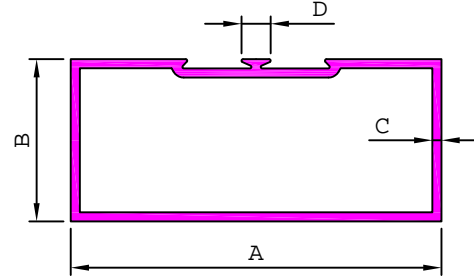

SINGLE GROOVE

SL. No.	Section No.	A	B	C	D	Weight kg/m
1	20088	47.80	24.00	0.60	7.50	0.274
2	20058	50.00	25.00	2.00	8.00	0.849
3	20049	50.80	25.40	0.73	7.50	0.342
4	20043	50.80	25.40	0.91	7.50	0.414
5	20080	50.80	25.40	1.09	7.50	0.489
6	20030	50.80	25.40	1.30	8.00	0.581
7	20016	50.80	25.40	1.50	8.00	0.651
8	20045	63.50	38.10	0.75	7.50	0.455
9	20068	63.50	38.10	0.92	7.50	0.546
10	20033	63.50	38.10	1.01	7.50	0.595
11	20054	63.50	38.10	1.17	7.50	0.681
12	20027	63.50	38.10	1.31	8.00	0.758
13	20063	63.50	38.10	1.41	8.00	0.818
14	20125	63.50	38.10	1.50	8.00	0.861
15	20048	63.50	38.10	1.65	8.00	0.942
16	20073	63.50	38.10	1.95	8.00	1.092
17	20065	63.50	38.10	2.50	8.00	1.369
18	20005	63.50	38.10	3.18	8.00	1.777
19	20038	82.50	38.00	1.20	8.00	0.829
20	20036	82.50	38.00	1.70	8.00	1.139
21	S4566	82.50	38.00	3.18	8.00	2.037
22	20032	89.00	32.00	2.75	8.00	1.787
23	20022	89.00	32.00	2.75	23.00	1.933
24	20126	92.00	29.50	1.15	7.50	0.794
25	20128	92.00	32.00	1.30	8.00	0.910
26	20052	101.60	44.45	1.27	8.00	1.049
27	20029	101.60	44.45	1.60	8.00	1.301
28	20146	101.60	44.45	1.90	8.50	1.534
29	20078	101.60	44.45	2.01	8.00	1.605
30	20077	101.60	44.45	2.47	8.00	1.950
31	20102	101.60	44.45	2.50	8.00	1.977
32	20067	101.60	44.45	3.00	8.00	2.342
33	20011	101.60	44.45	3.18	8.00	2.541
34	20112	101.60	44.45	3.70	8.00	2.846
35	20059	123.00	44.45	1.50	8.00	1.394
36	20136	123.00	44.45	3.00	8.00	2.687
37	S4292	127.00	44.45	3.00	8.00	2.752
38	20139	127.20	25.25	1.22	8.00	1.048

ARCHITECTURAL

PARTITION SECTION

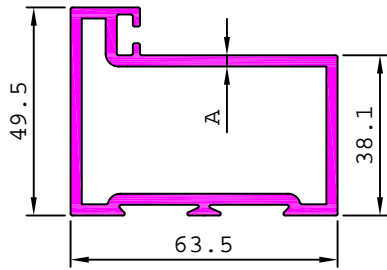

SL. No.	Section No.	A	Weight kg/m
1	20130	1.40	0.947
2	20024	1.70	1.158
3	20001	2.65	1.657
4	20137	3.18	1.954

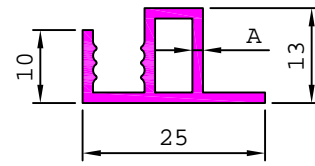

SL. No.	Section No.	A	Weight kg/m
1	20150	0.85	0.155
2	20151	1.10	0.195
3	20121	1.20	0.210
4	20107	1.44	0.246
5	20105	1.50	0.255

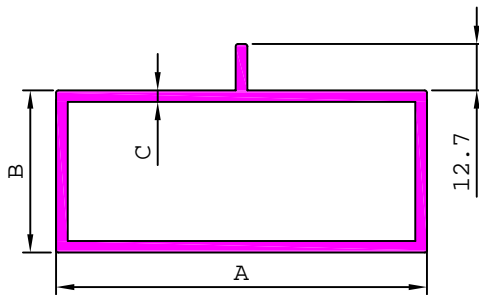

SL. No.	Section No.	A	B	C	Weight kg/m
1	20074	101.60	44.45	2.45	1.951
2	20008	101.60	44.45	3.18	2.508

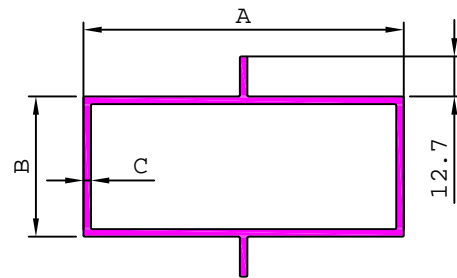

SL. No.	Section No.	A	B	C	Weight kg/m
1	20007	101.60	44.45	2.40	1.995
2	20101	101.60	44.45	3.18	2.617

20141 1.992 kg/m

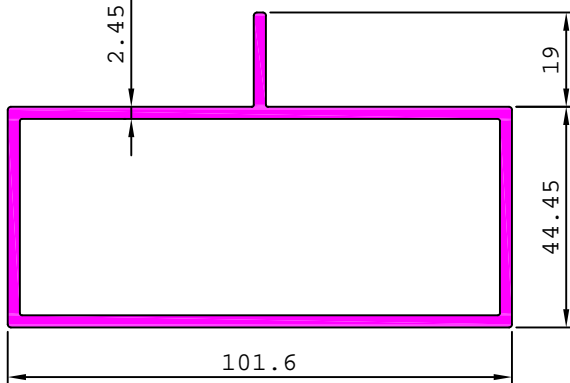

ARCHITECTURAL

PARTITION SECTION

20117 0.970 kg/m

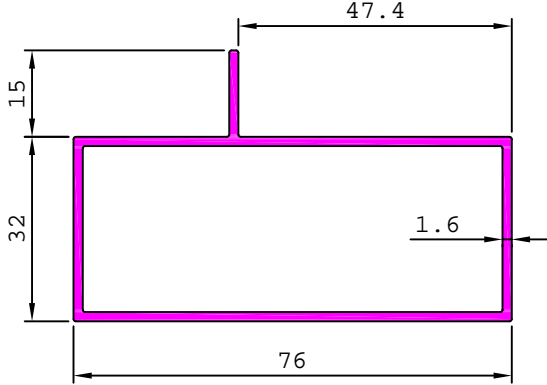

20009 2.062 kg/m

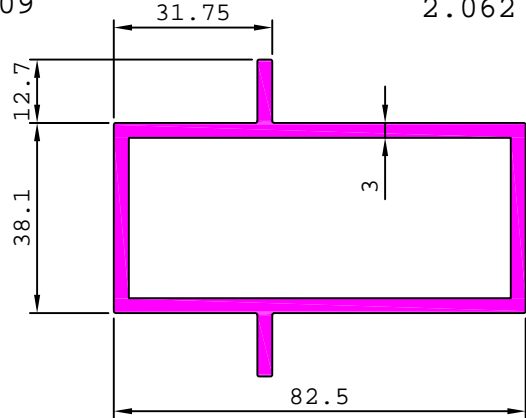

20013 1.959 kg/m

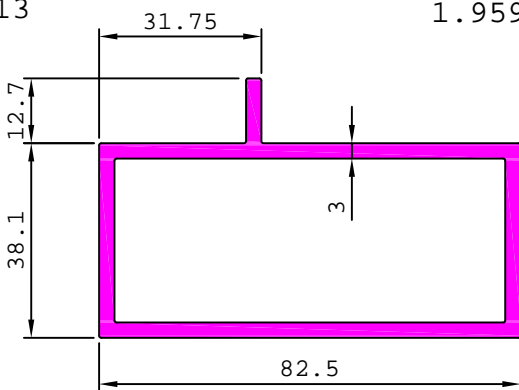

20155 1.474 kg/m

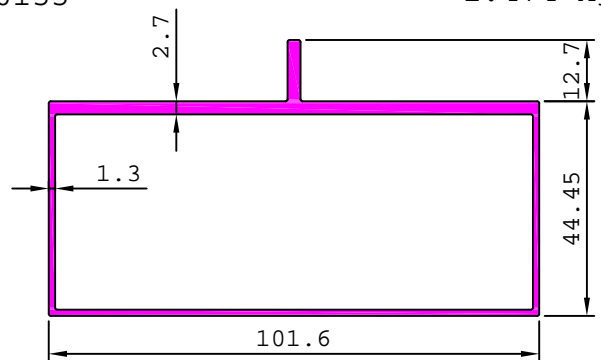

20122 1.774 kg/m

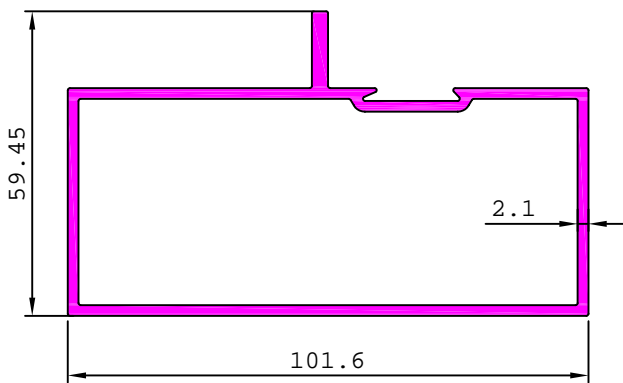

20123 1.943 kg/m

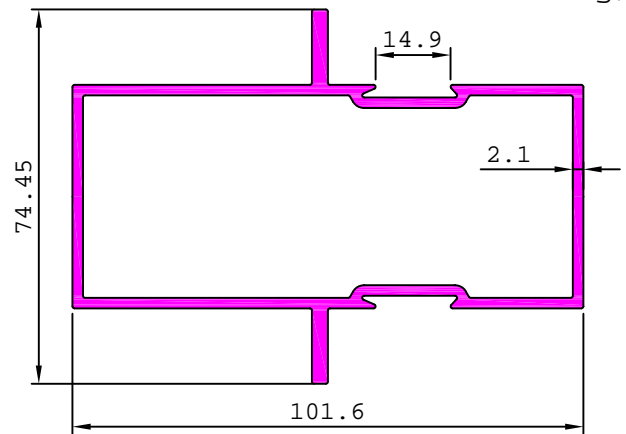

20362 1.153 kg/m

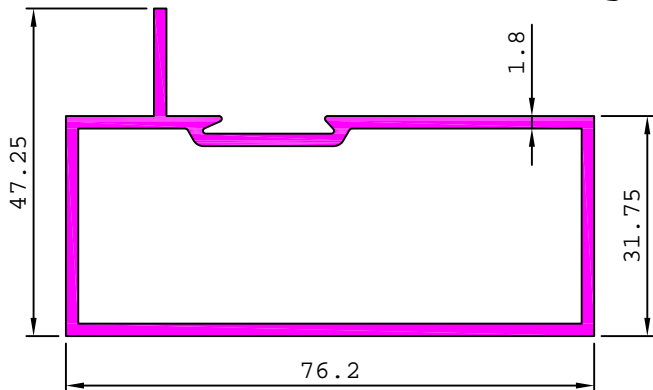

20363 1.297 kg/m

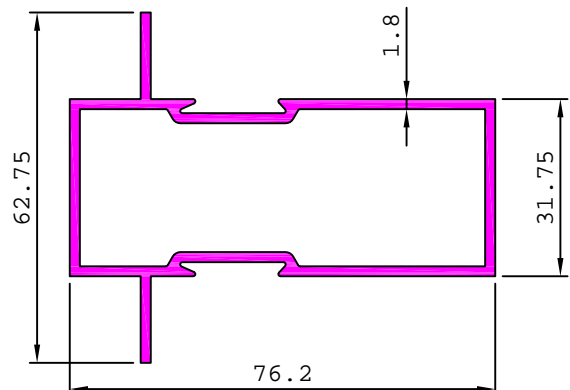

ARCHITECTURAL

PARTITION SECTION

20055 1.032 kg/m

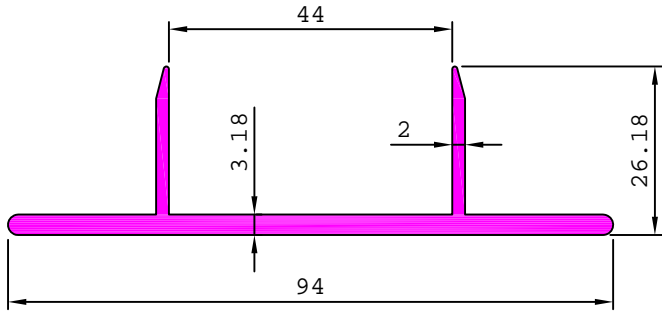

20134 1.036 kg/m

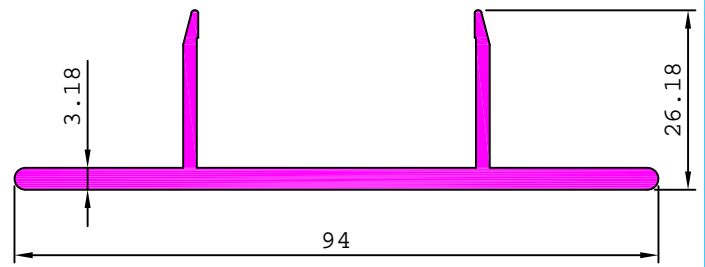

20056 0.969 kg/m

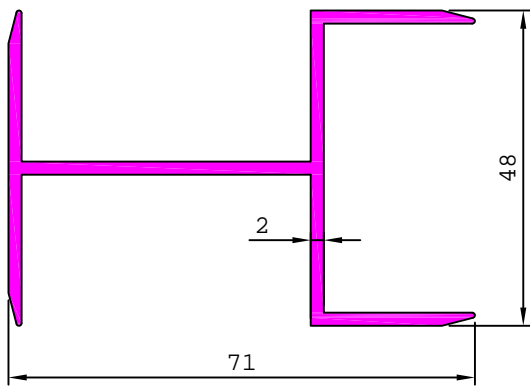

20133 0.925 kg/m

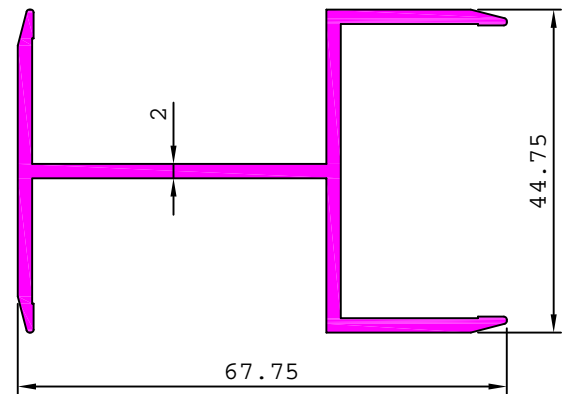

ARCHITECTURAL

PARTITION SECTION

20131

1.504 kg/m

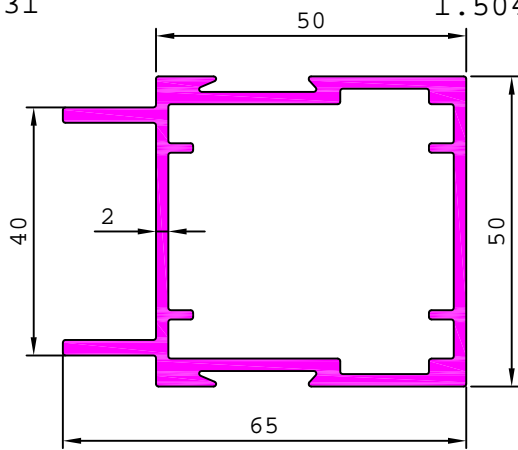

20097

1.658 kg/m

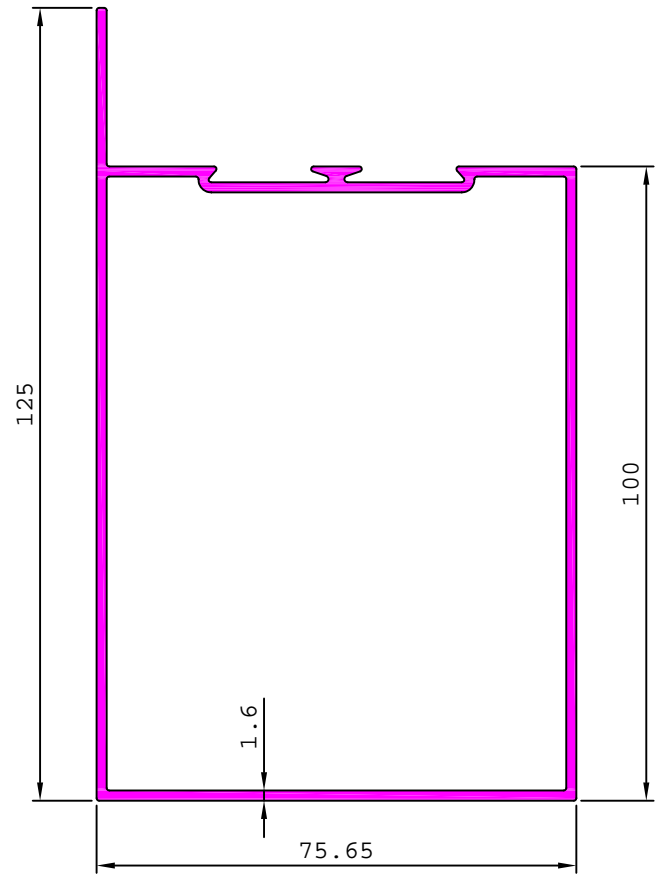

20132

2.044 kg/m

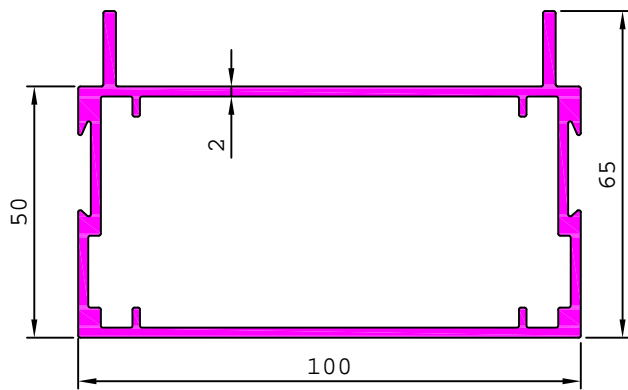

ARCHITECTURAL

PARTITION SECTION

20012

0.886 kg/m

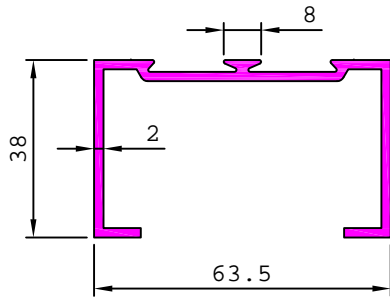

20094

0.499 kg/m

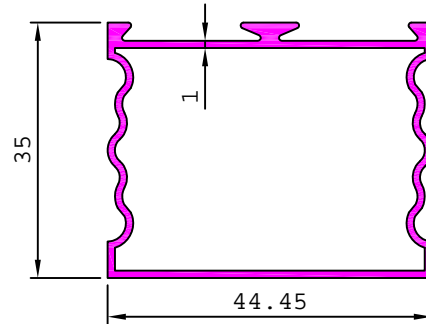

20095

0.556 kg/m

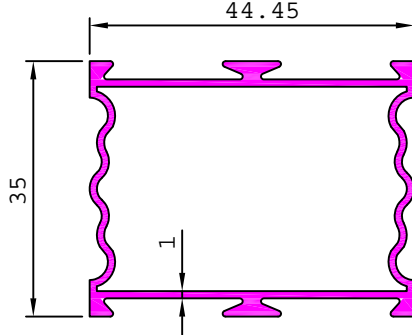

20148

0.661 kg/m

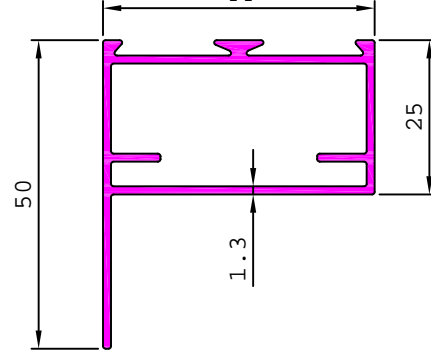

20142

0.901 kg/m

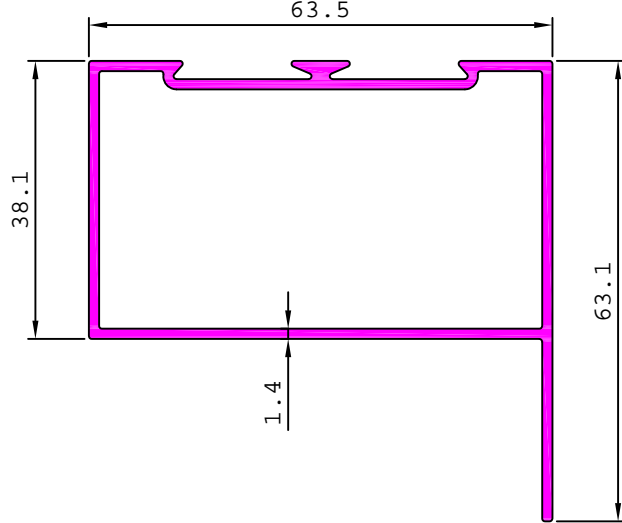

20156

1.062 kg/m

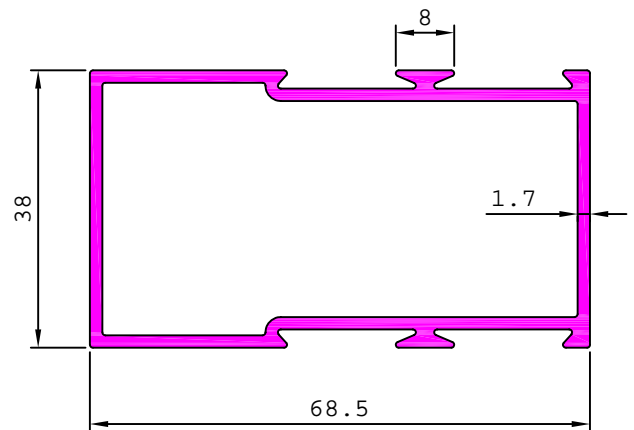

20127

1.887 kg/m

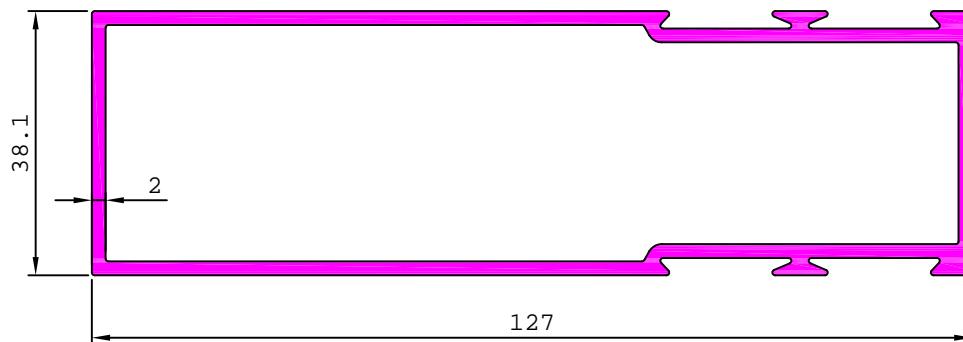

ARCHITECTURAL

PARTITION SECTION

20019 2.655 kg/m

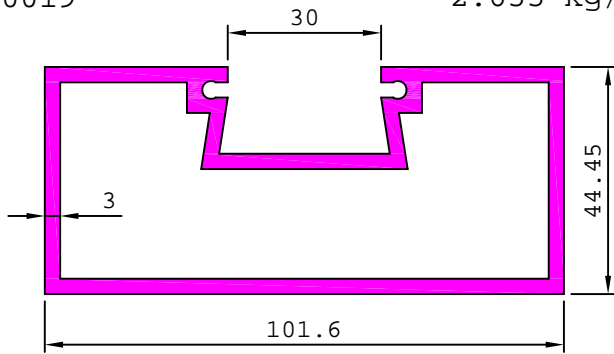

20020 2.818 kg/m

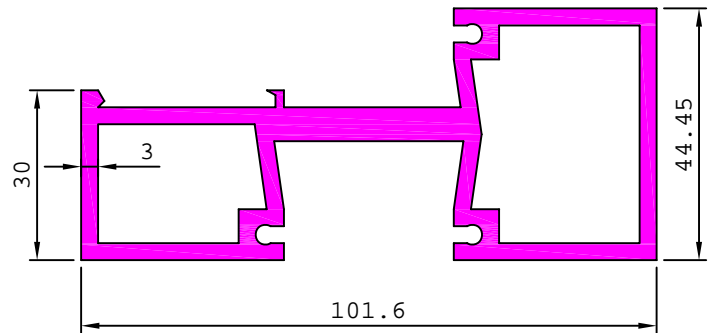

20135 2.673 kg/m

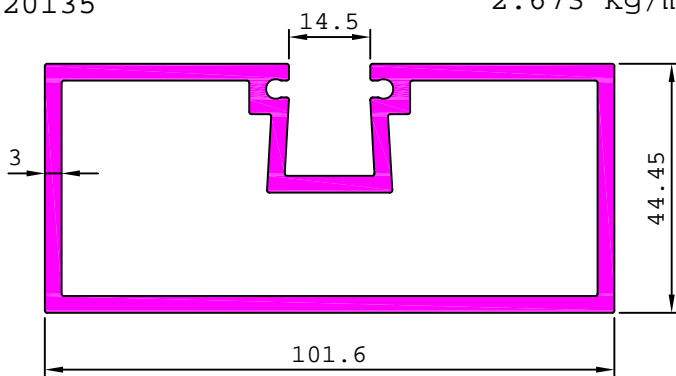

20092 0.717 kg/m

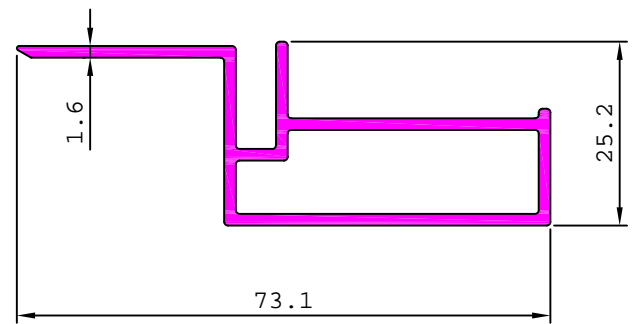

20129 0.346 kg/m

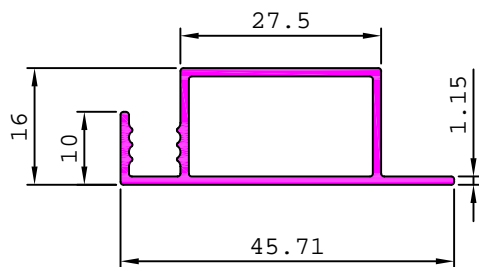

20093 1.197 kg/m

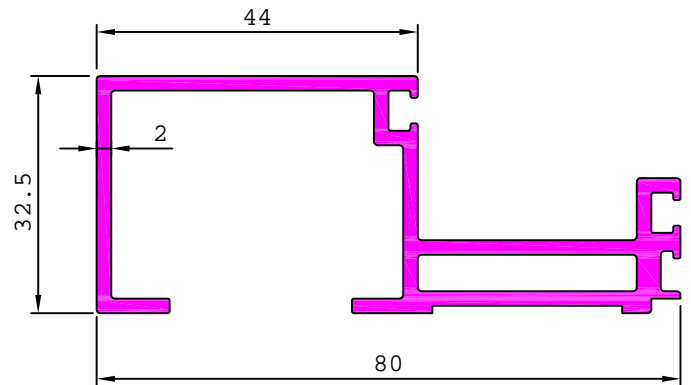

ARCHITECTURAL

SAMOSA SECTION

20103

0.944 kg/m

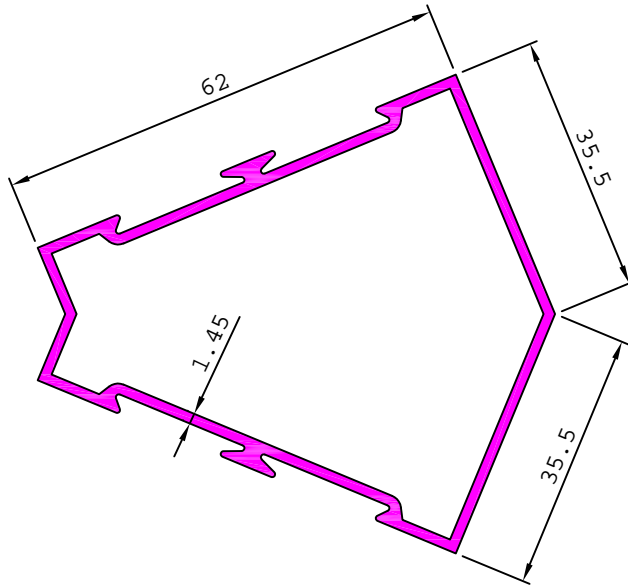

20106

1.875 kg/m

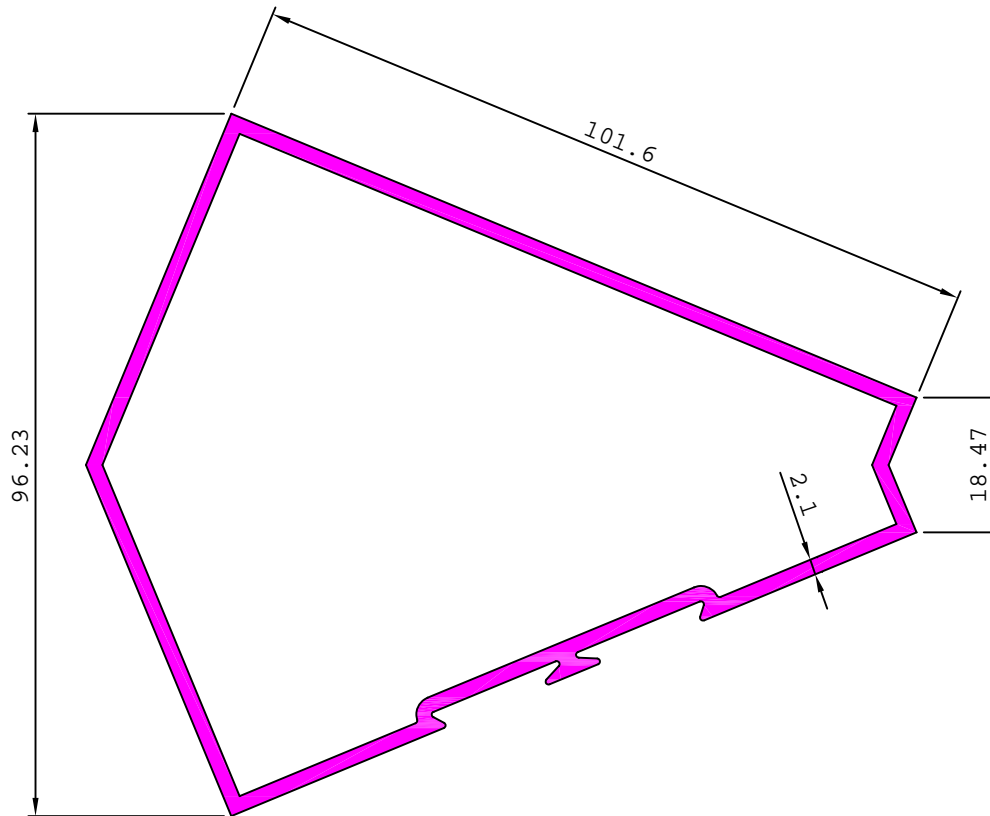

ARCHITECTURAL

DISPLAY SECTION

20359 1.124 kg/m

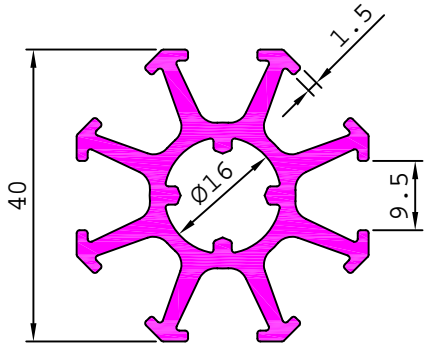

20368 1.058 kg/m

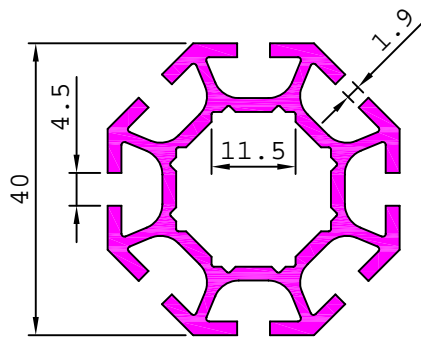

20369 1.191 kg/m

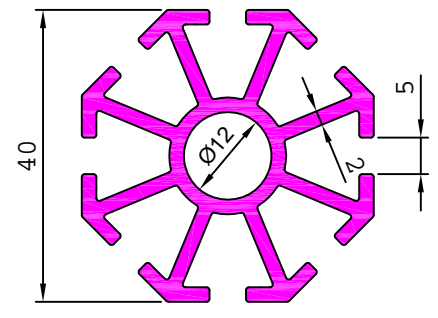

20375 1.234 kg/m

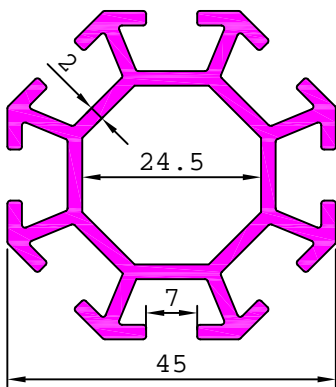

20450 1.212 kg/m

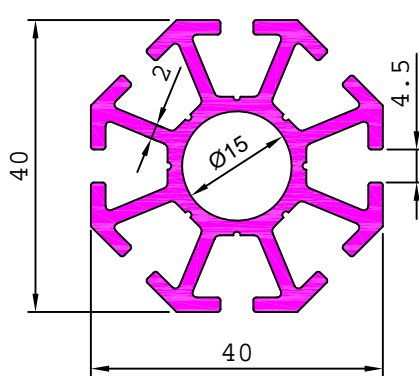

35027 0.695 kg/m

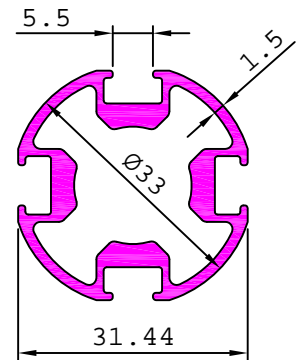

20498 2.132 kg/m

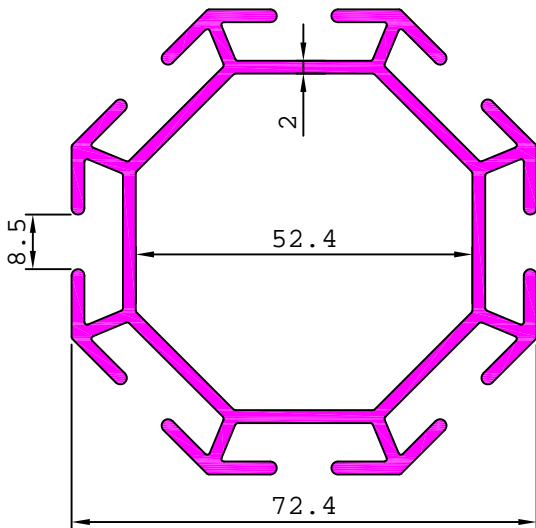

35013 2.491 kg/m

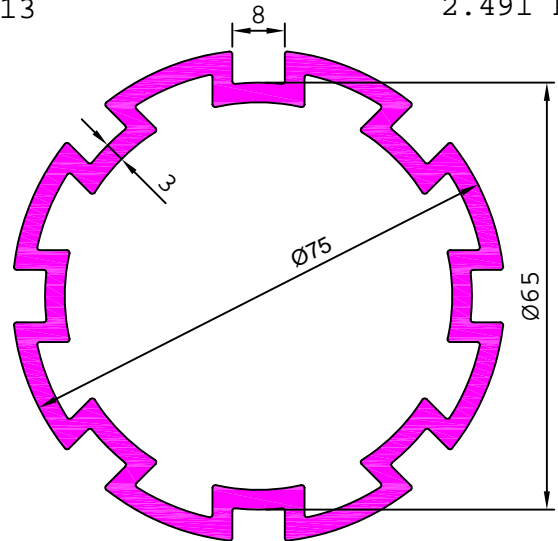

35053 0.912 kg/m

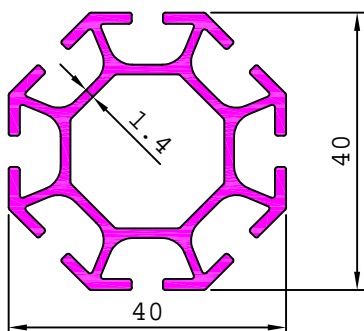

35069 0.922 kg/m

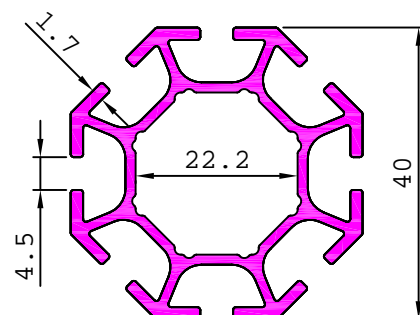

ARCHITECTURAL

DISPLAY SECTION

35042

2.078 kg/m

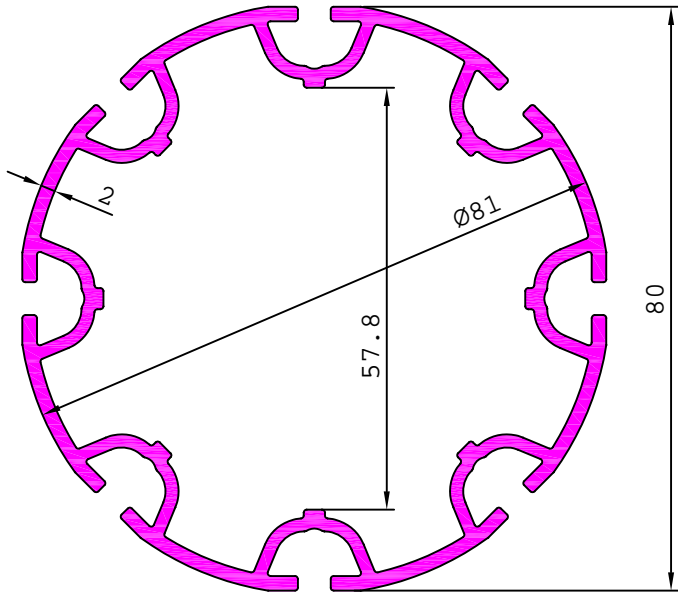

29163

0.636 kg/m

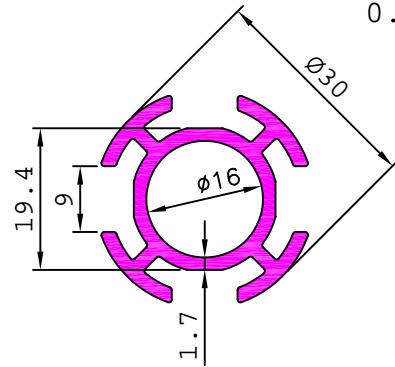

ARCHITECTURAL

DISPLAY SECTION

20449 0.954 kg/m

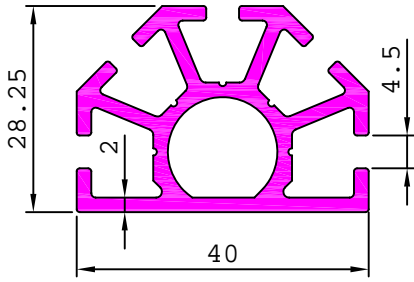

20448 0.735 kg/m

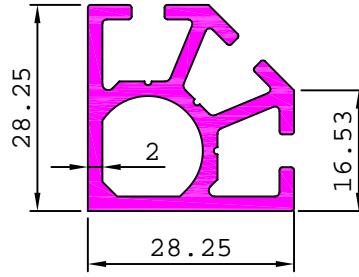

29162 0.666 kg/m

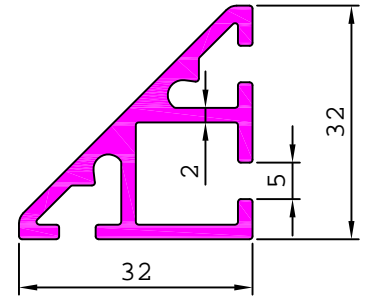

35038 1.803 kg/m

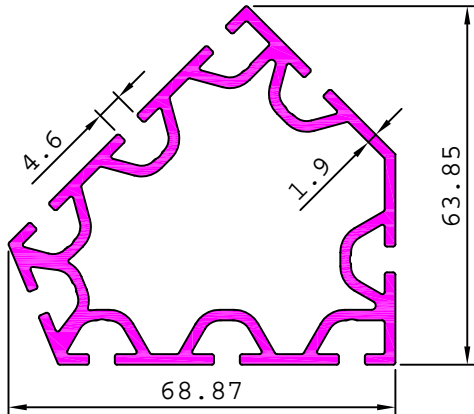

ARCHITECTURAL

DISPLAY SECTION

20356 0.864 kg/m

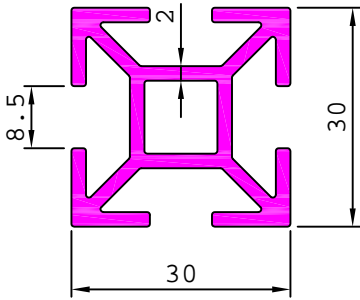

20361 0.711 kg/m

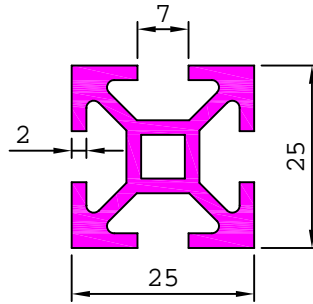

20365 0.957 kg/m

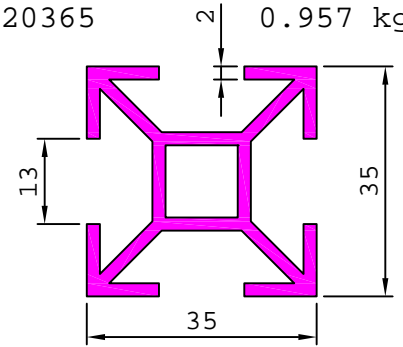

20473 1.554 kg/m

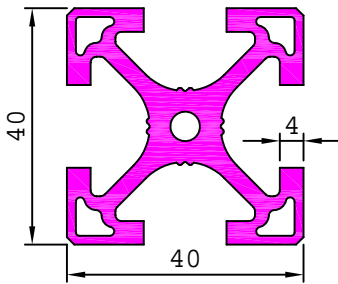

20474 0.747 kg/m

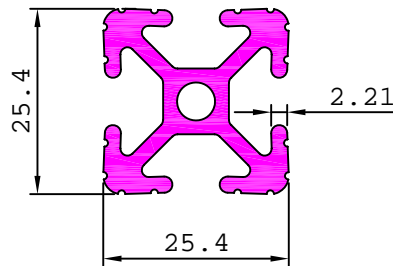

20484 0.823 kg/m

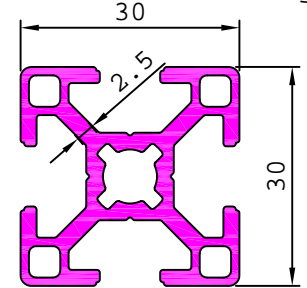

20485 1.534 kg/m

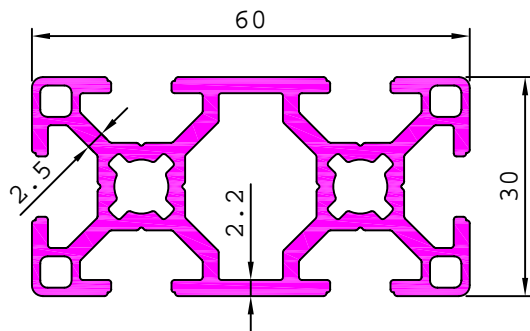

35005 3.794 kg/m

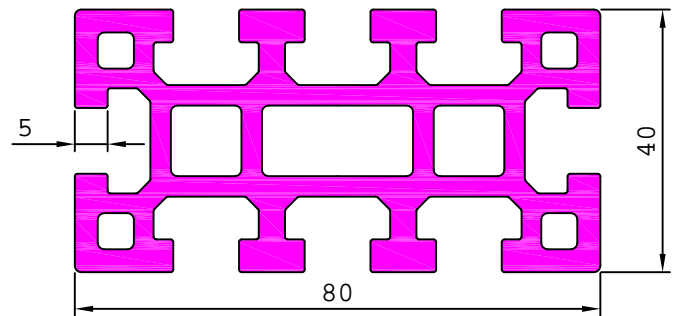

35067 4.307 kg/m

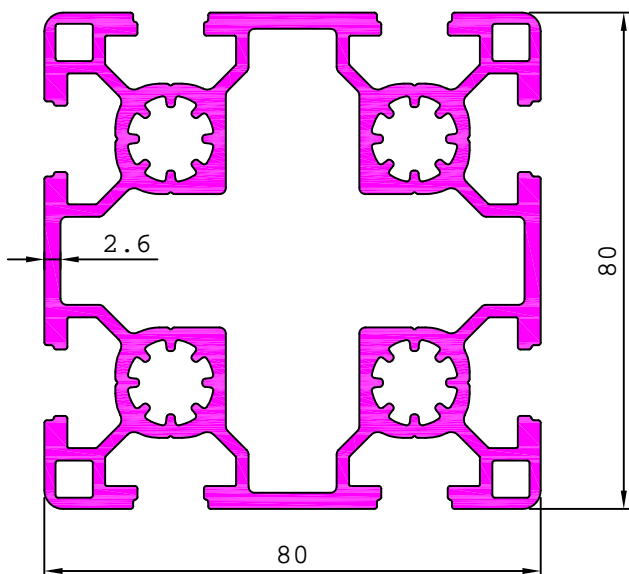

35052 10.315 kg/m

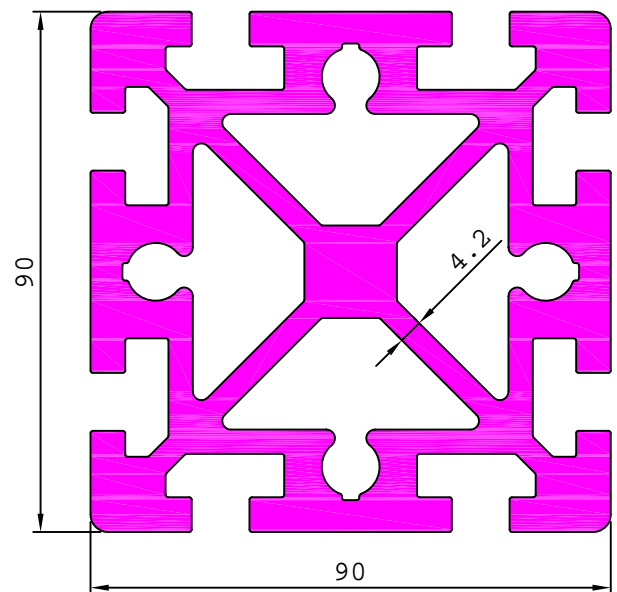

ARCHITECTURAL

DISPLAY SECTION

35060 2.876 kg/m

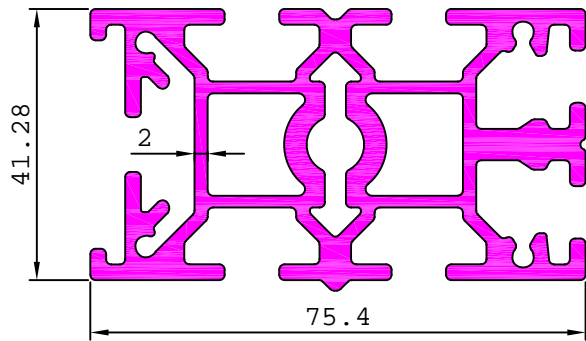

28976 1.573 kg/m

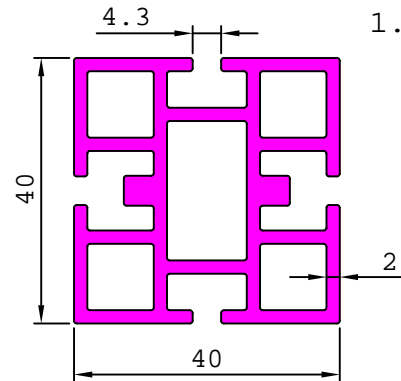

35006 2.059 kg/m

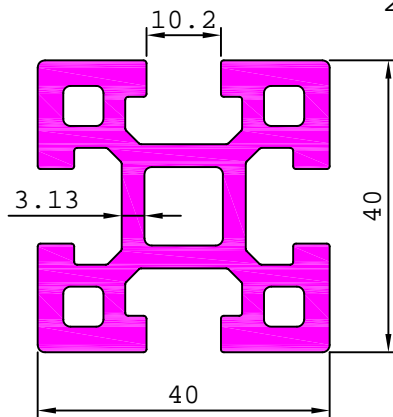

35039 2.161 kg/m

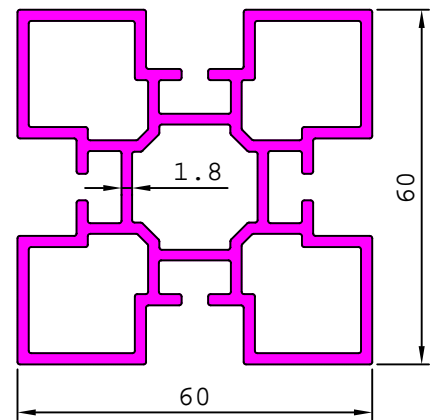

35105 1.483 kg/m

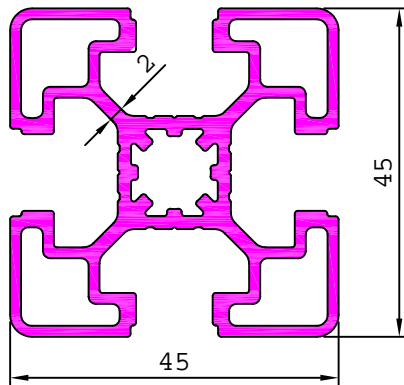

35108 1.577 kg/m

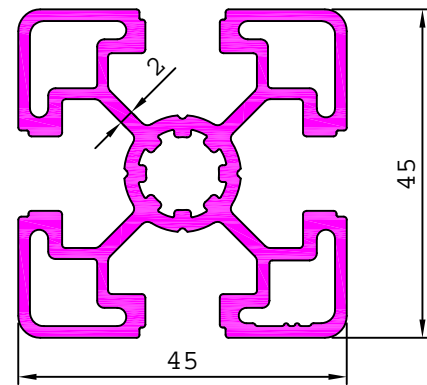

S4967 1.217 kg/m

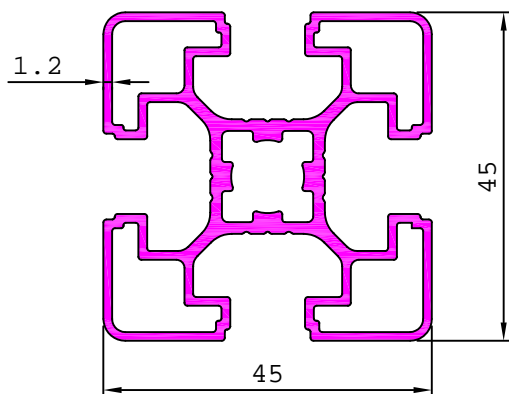

S5223 1.692 kg/m

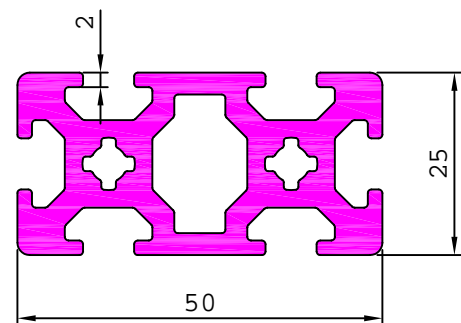

ARCHITECTURAL

DISPLAY SECTION

S5224

0.933 kg/m

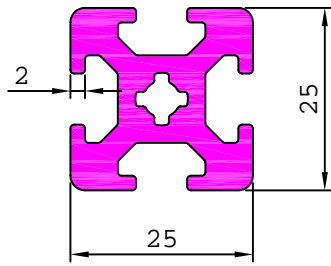

ARCHITECTURAL

DISPLAY SECTION

15106 0.164 kg/m

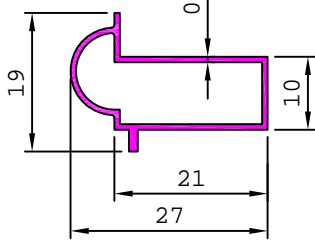

29016 0.121 kg/m

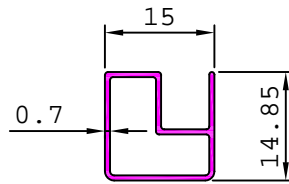

15149 0.139 kg/m

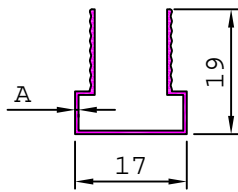
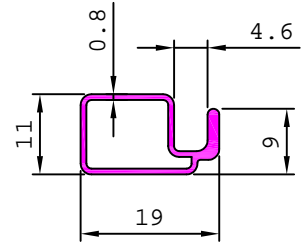

SL. No.	Section No.	A	Weight kg/m
1	35072	0.38	0.069
2	20395	0.53	0.093

35028 0.350 kg/m

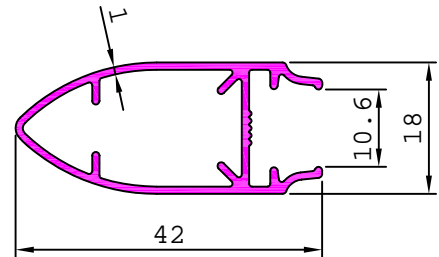

S4442 4.922 kg/m

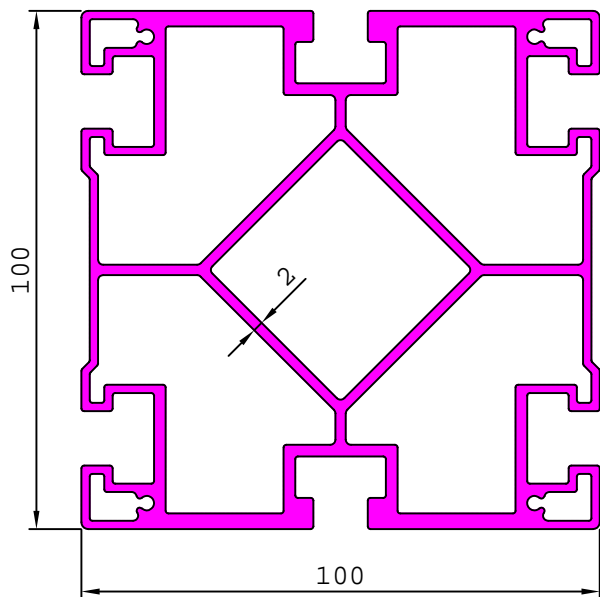

S4448 9.793 kg/m

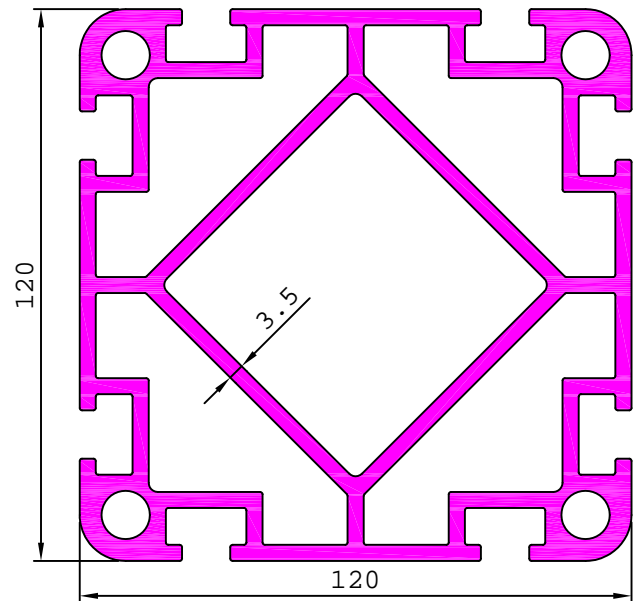

ARCHITECTURAL

DISPLAY SECTION

<p>20352 0.238 kg/m</p>	<p>20379 0.286 kg/m</p>	<p>20476 0.232 kg/m</p>
<p>20477 0.453 kg/m</p>	<p>35073 0.124 kg/m</p>	<p>35074 0.099 kg/m</p>
<p>20354 0.230 kg/m</p>	<p>20486 0.489 kg/m</p>	<p>35017 0.164 kg/m</p>
<p>35019 0.253 kg/m</p>	<p>35068 0.134 kg/m</p>	<p>35071 0.151 kg/m</p>
<p>35075 0.156 kg/m</p>	<p>35076 0.118 kg/m</p>	<p>35085 0.210 kg/m</p>

ARCHITECTURAL

DISPLAY SECTION

35094 0.217 kg/m

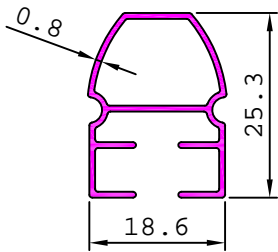

35086 0.166 kg/m

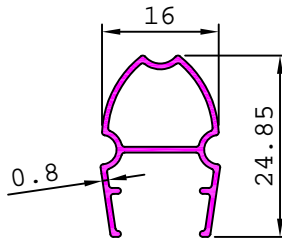

20376 0.199 kg/m

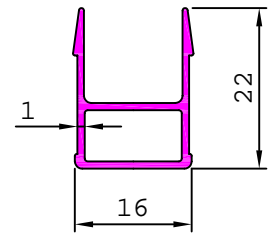

35096 0.113 kg/m

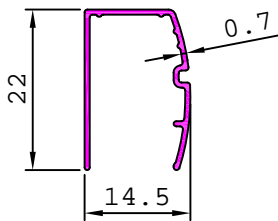

35099 0.172 kg/m

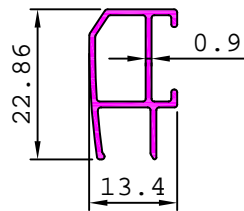

S4755 0.144 kg/m

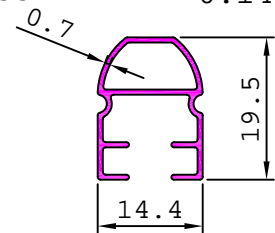

35106 0.137 kg/m

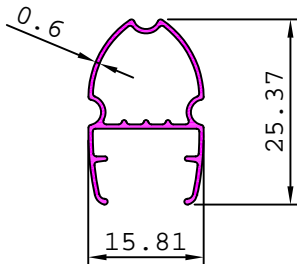

ARCHITECTURAL

DISPLAY SECTION

35014

2.304 kg/m

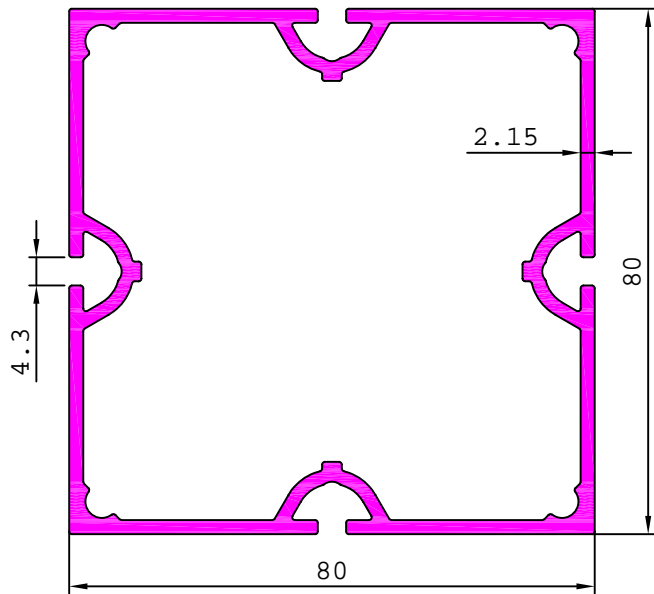

35029

2.938 kg/m

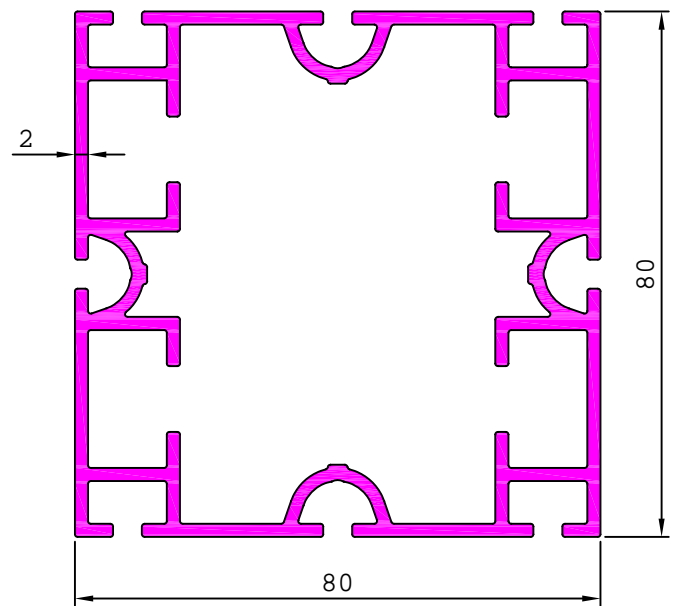

35050

1.304 kg/m

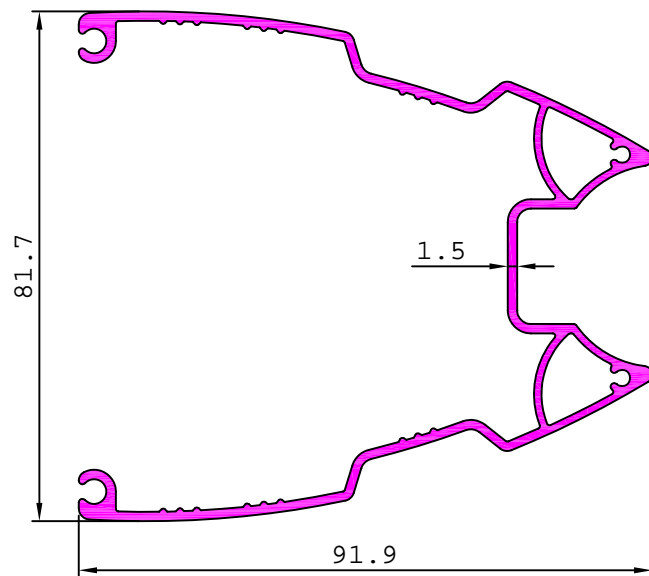

27919

2.724 kg/m

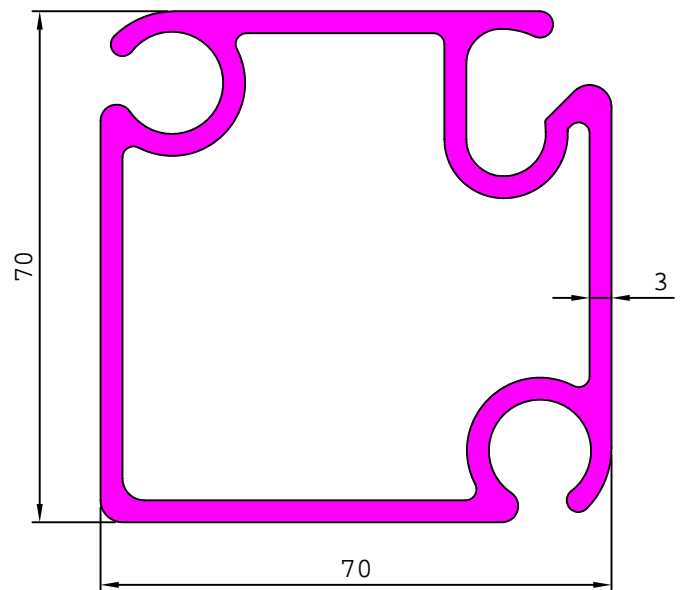

35037

0.637 kg/m

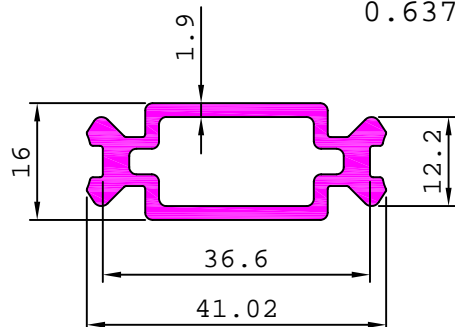

35055

0.992 kg/m

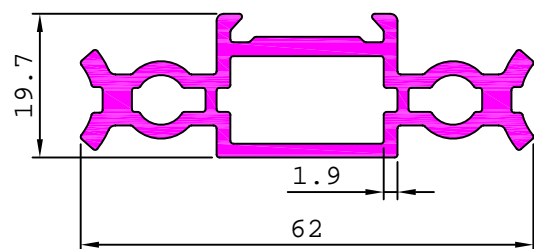

ARCHITECTURAL

DISPLAY SECTION

35036 1.940 kg/m

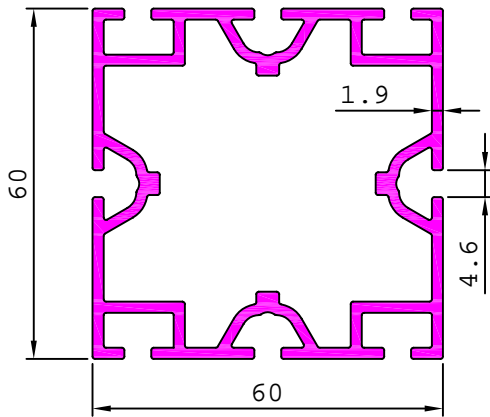

35043 1.608 kg/m

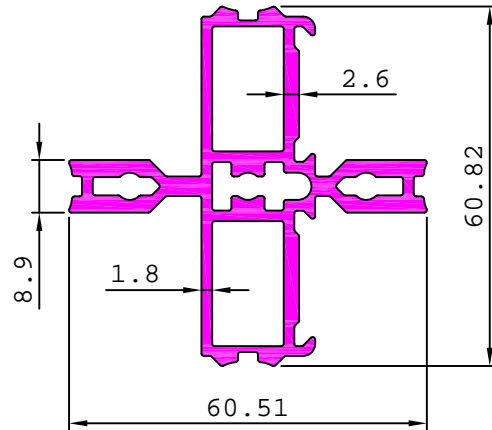

20472 3.797 kg/m

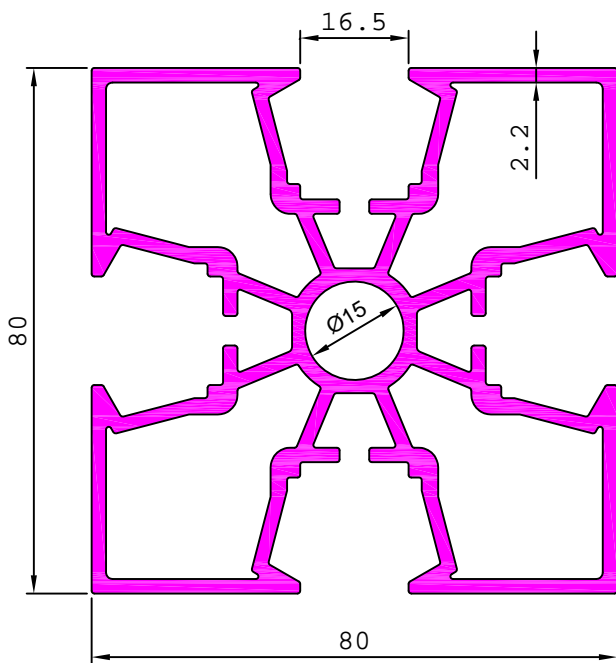

20490 2.894 kg/m

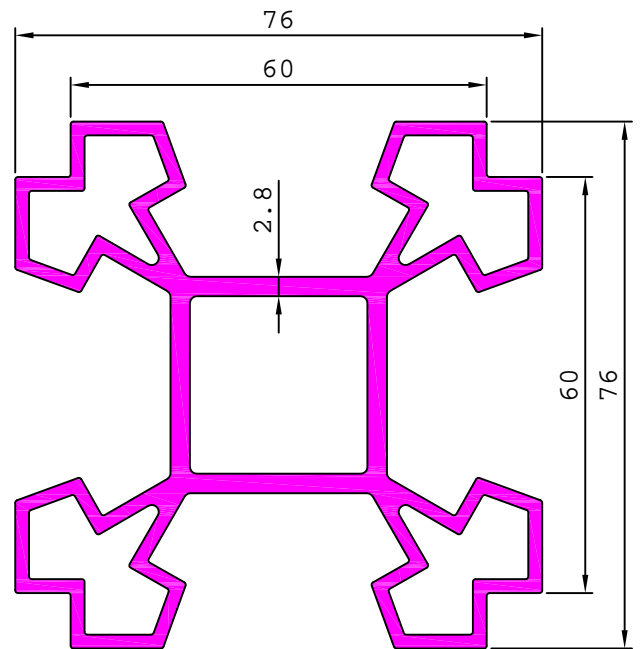

35046 2.565 kg/m

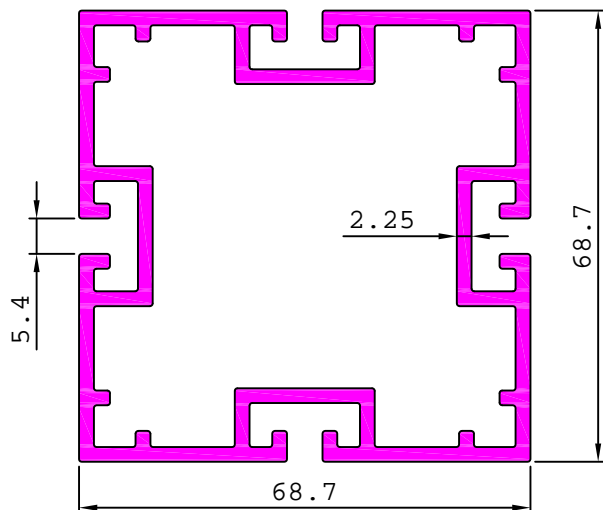

28977 1.074 kg/m

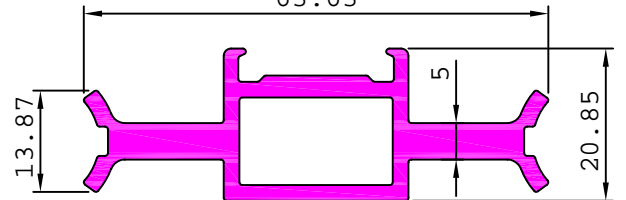

ARCHITECTURAL

DISPLAY SECTION

35095

10.392 kg/m

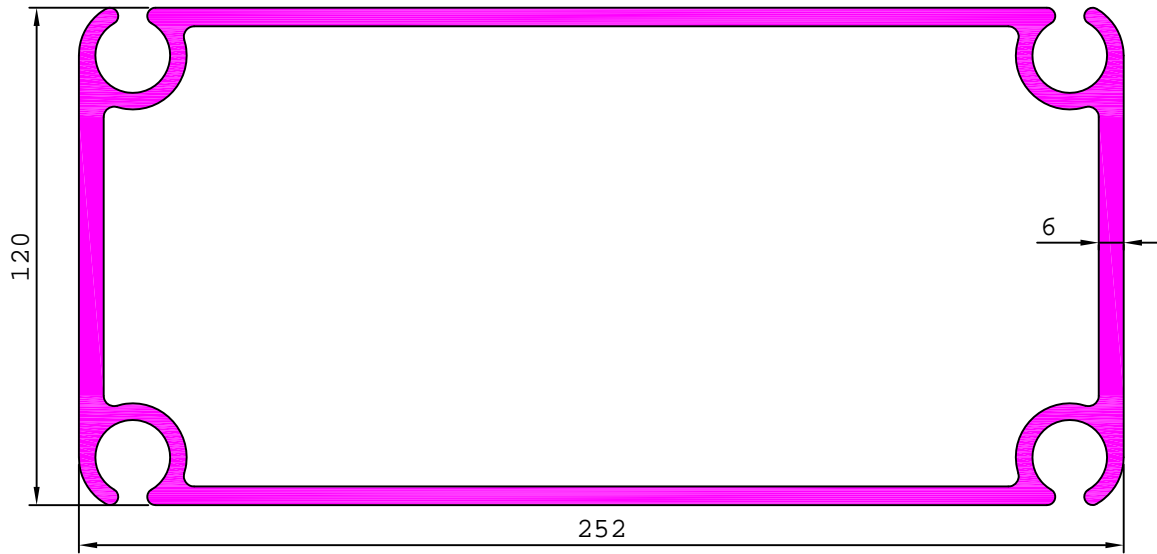

35045

9.268 kg/m

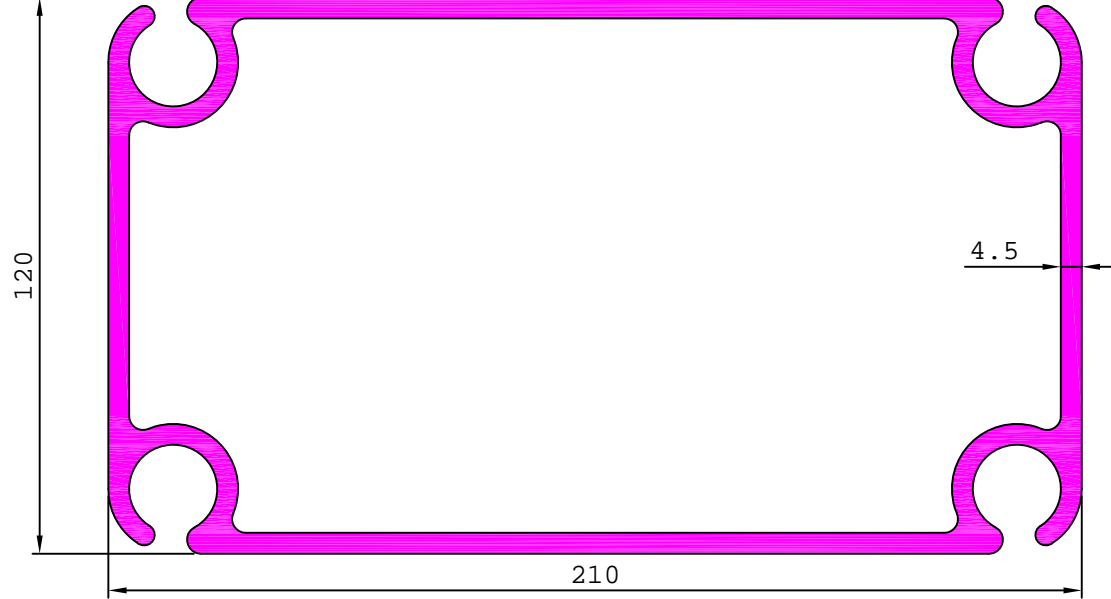

S4880

16.753 kg/m

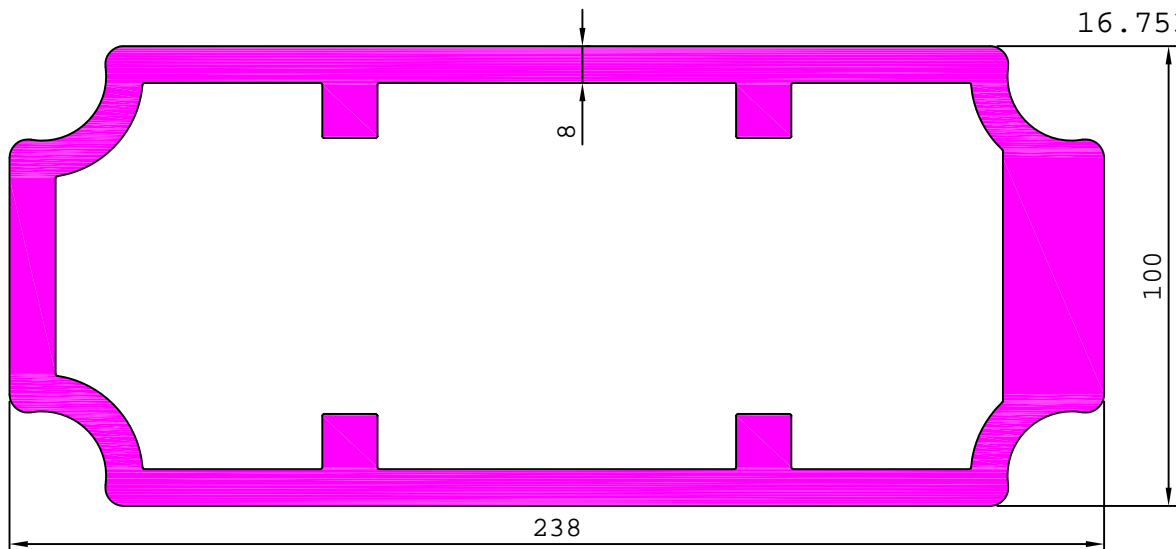

ARCHITECTURAL

DISPLAY SECTION

28141

4.347 kg/m

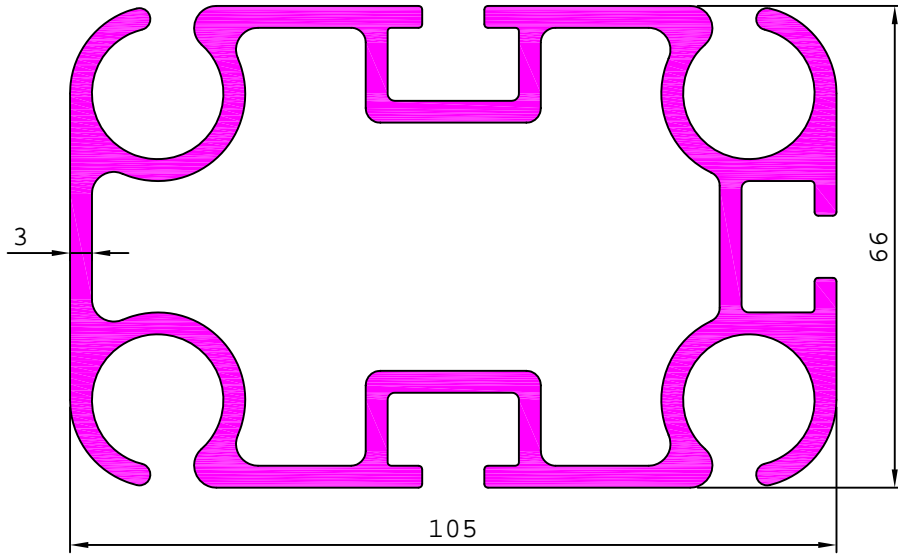

27367

4.079 kg/m

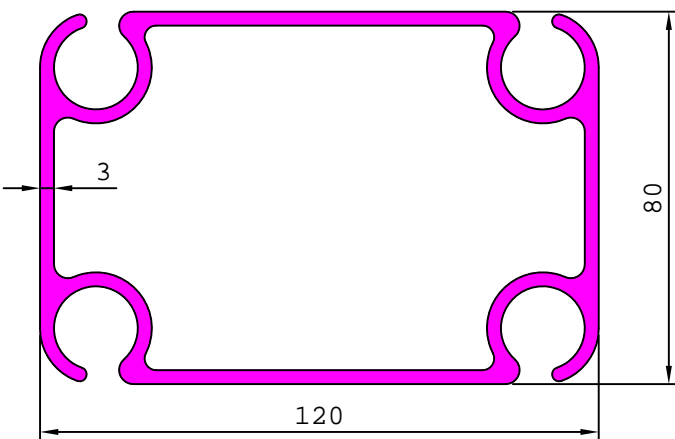

S5182

8.697 kg/m

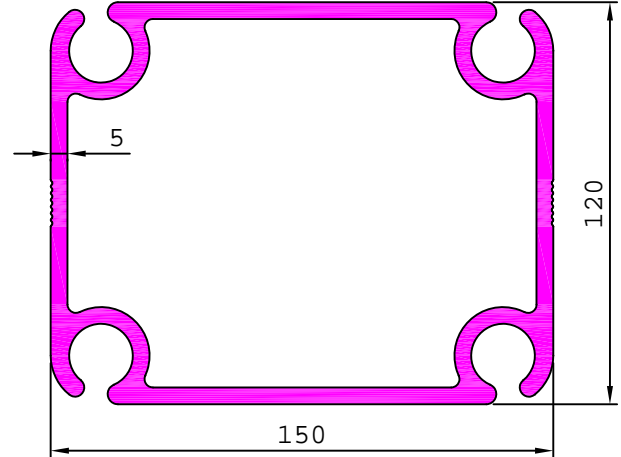

27802

7.635 kg/m

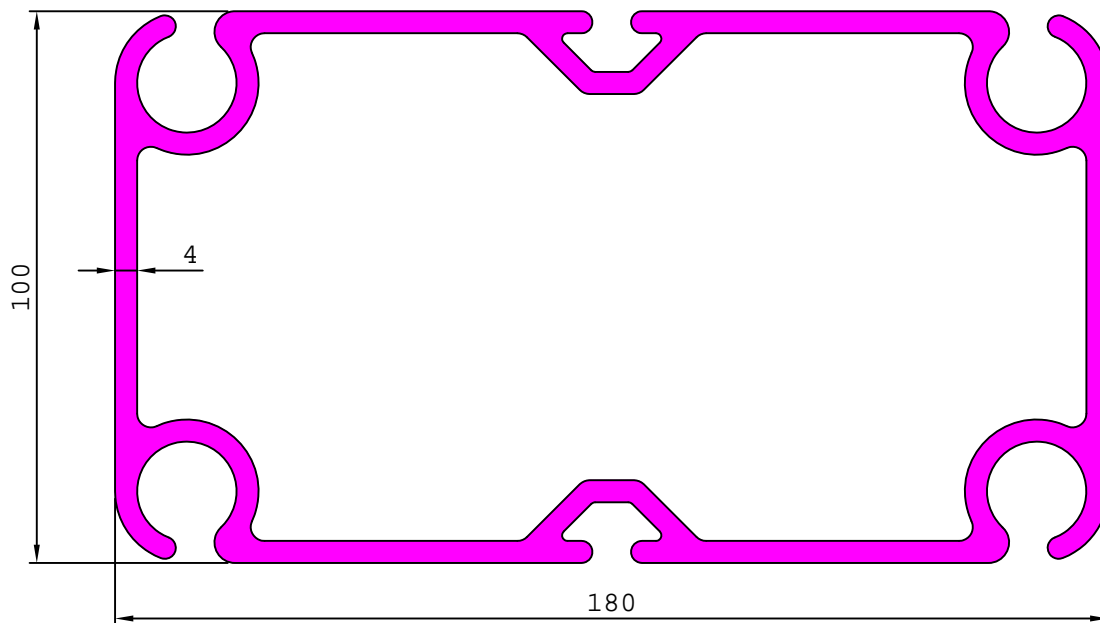

ARCHITECTURAL

DISPLAY SECTION

27850

9.275 kg/m

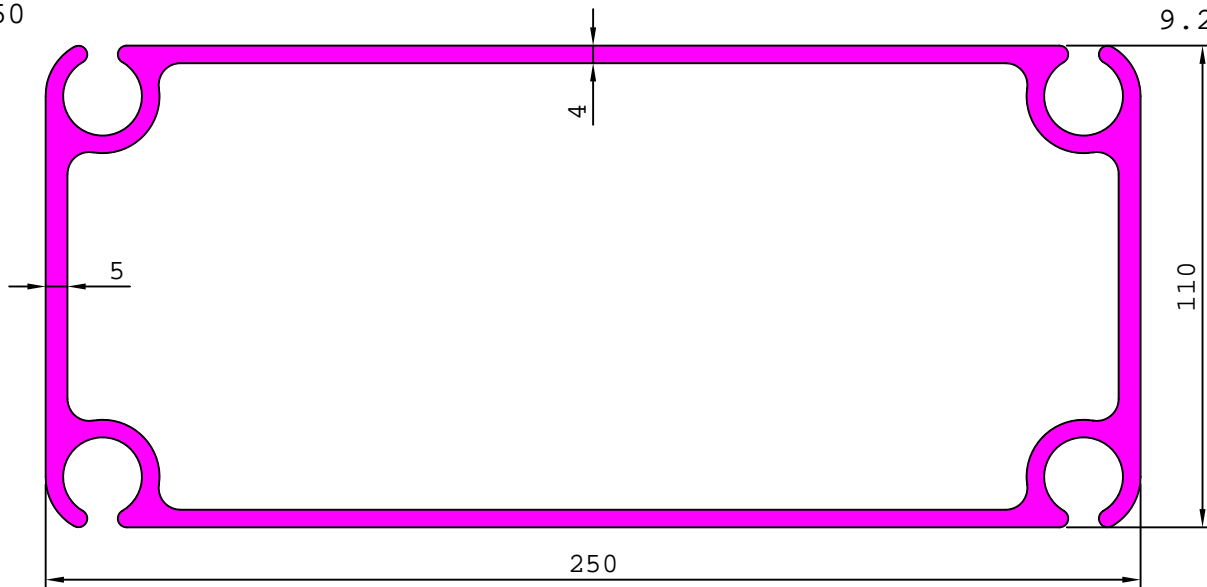

S5178

14.149 kg/m



S5183

5.997 kg/m

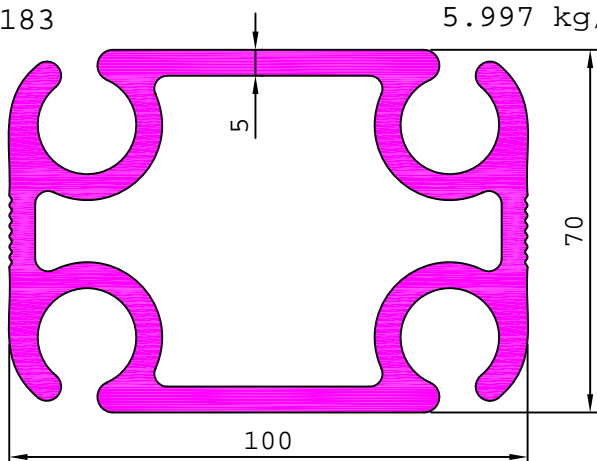

S5184

3.557 kg/m

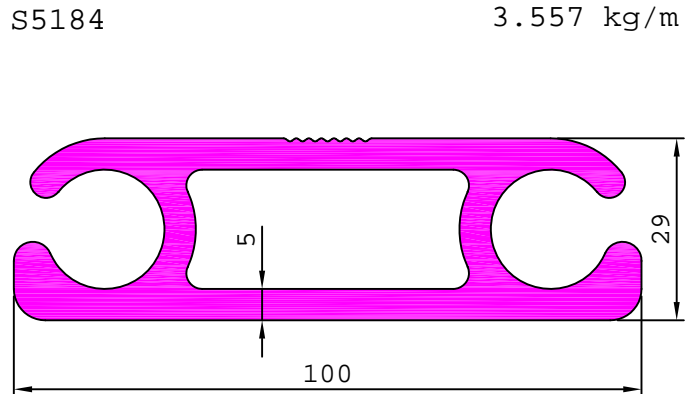

ARCHITECTURAL

DISPLAY SECTION

20358 0.686 kg/m

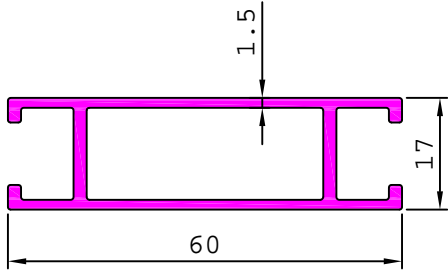

20367 0.582 kg/m

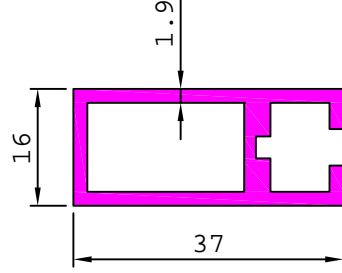

20373 0.817 kg/m

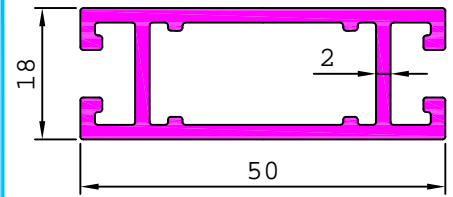

20374 0.676 kg/m

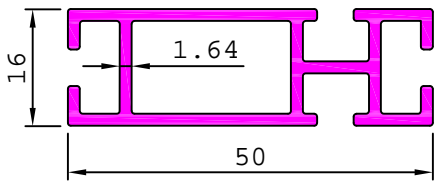

20430 0.733 kg/m

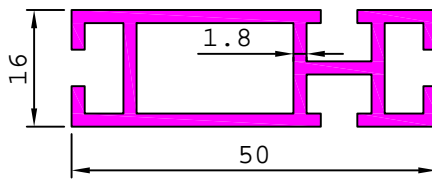

20471 0.805 kg/m

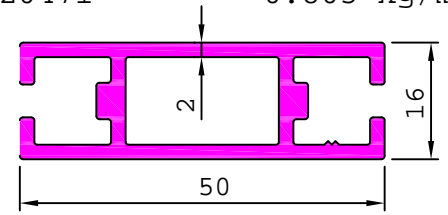

35054 0.548 kg/m

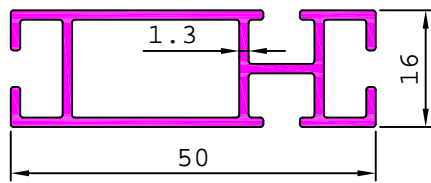

35107 0.526 kg/m

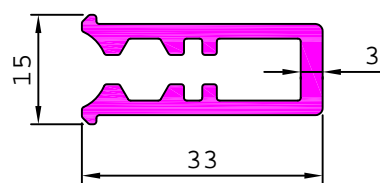

20393

1.738 kg/m

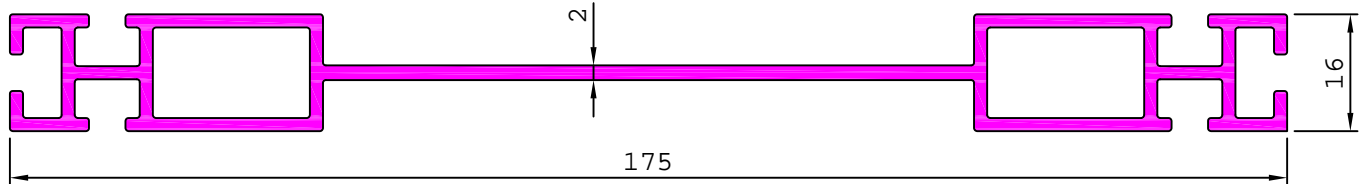

20470

1.931 kg/m

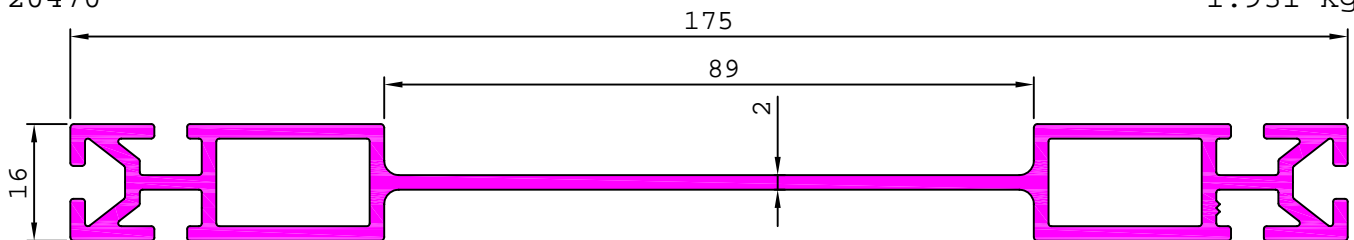

S4716

1.387 kg/m

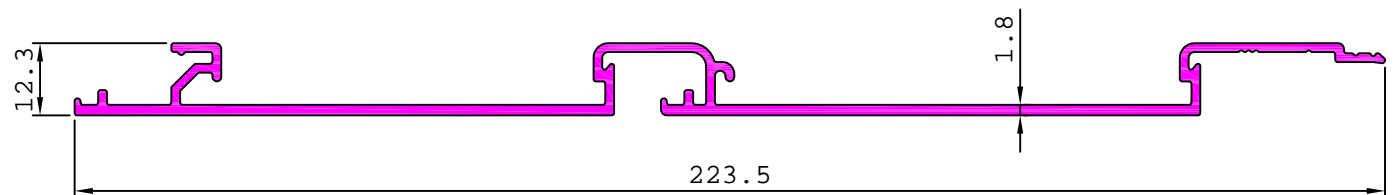

ARCHITECTURAL

DISPLAY SECTION

20497

1.157 kg/m

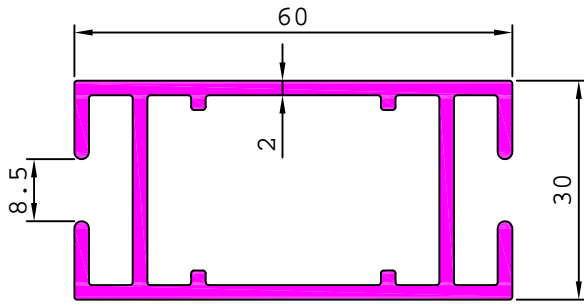

20495

1.263 kg/m

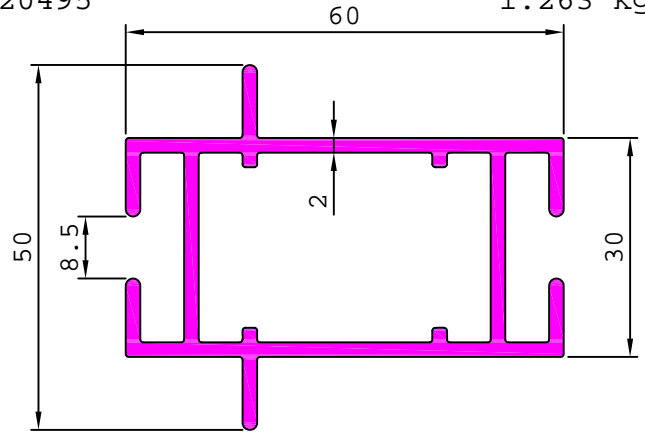

20496

1.210 kg/m

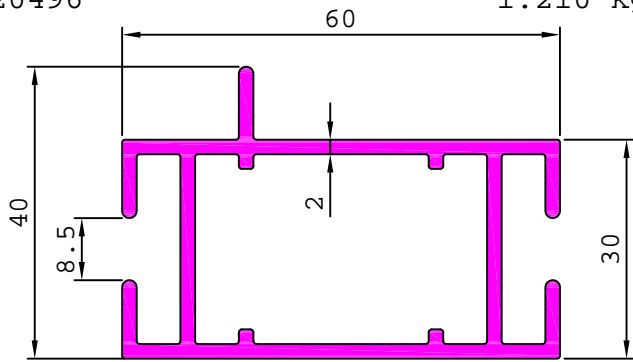

ARCHITECTURAL

DISPLAY SECTION

20353 0.870 kg/m

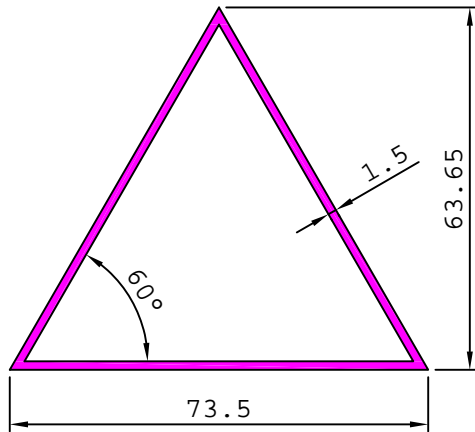

20383 1.188 kg/m

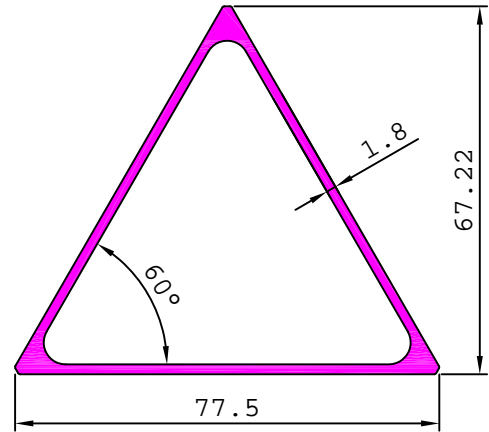

20442 1.425 kg/m

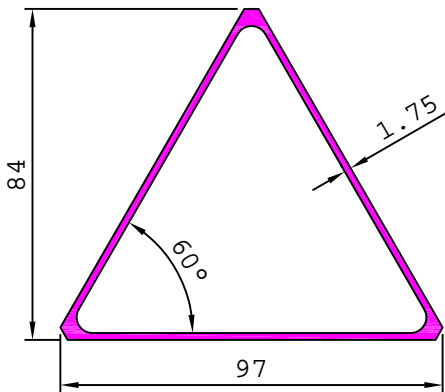

29145 4.032 kg/m

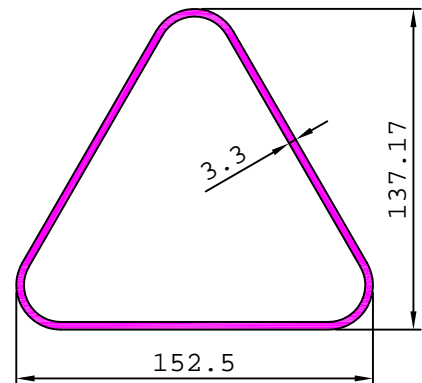

35007 0.872 kg/m

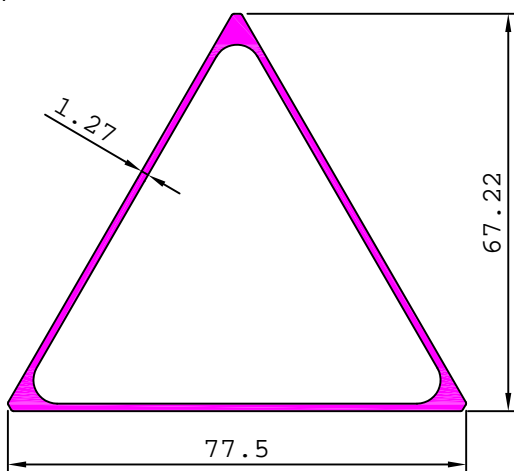

S4490 1.452 kg/m

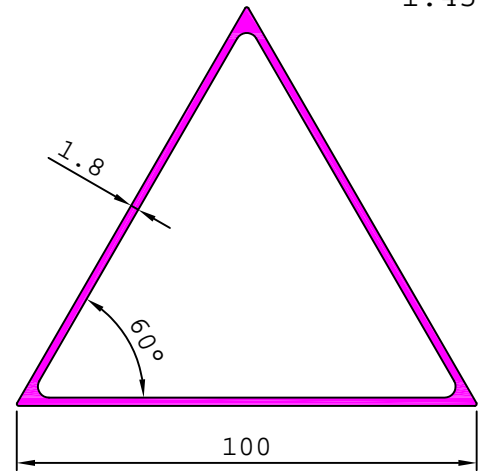

20419 0.054 kg/m

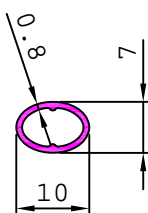

35084 0.682 kg/m

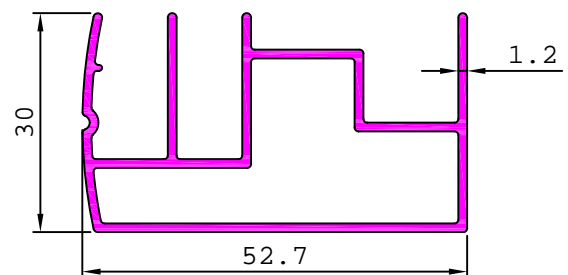

ARCHITECTURAL

DISPLAY SECTION

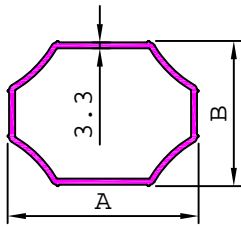

SL. No.	Section No.	A	B	Weight kg/m
1	35020	104.60	79.60	2.640
2	35021	114.60	89.60	2.961
3	35022	124.60	99.60	3.287
4	35023	134.60	109.60	3.622
5	35024	144.60	119.60	3.968
6	35025	154.60	129.60	4.332
7	35026	164.60	139.60	4.720
8	35056	83.00	58.00	2.015
9	35057	93.00	68.00	2.325
10	35058	173.00	148.00	5.149

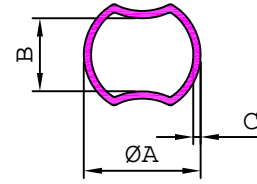

SL. No.	Section No.	ØA	B	C	Weight kg/m
1	35032	16.00	10.00	1.00	0.127
2	35033	20.20	14.20	1.00	0.164
3	35034	24.40	18.40	1.00	0.203
4	35035	28.60	22.60	1.00	0.240

20454

0.687 kg/m

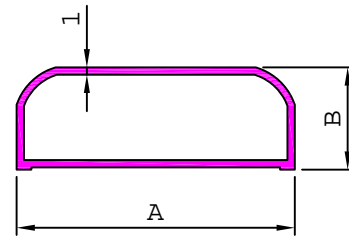
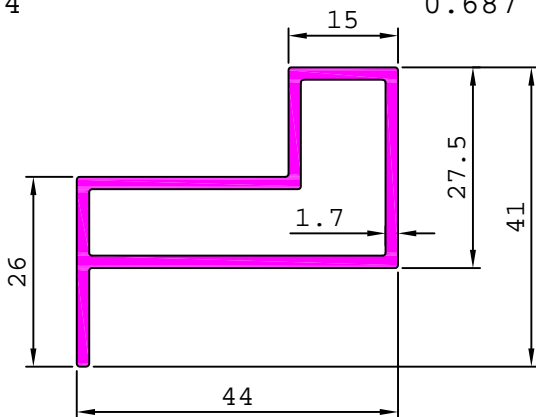

SL. No.	Section No.	A	B	Weight kg/m
1	35009	46.20	22.00	0.341
2	35010	42.20	18.00	0.164
3	35011	38.10	14.00	0.258

ARCHITECTURAL

DISPLAY SECTION

20398 0.093 kg/m

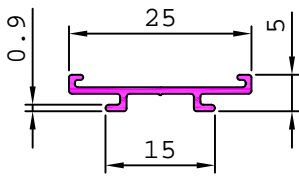

20405 0.209 kg/m

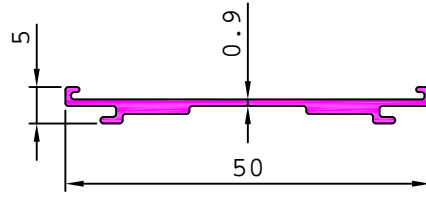

20408 0.267 kg/m

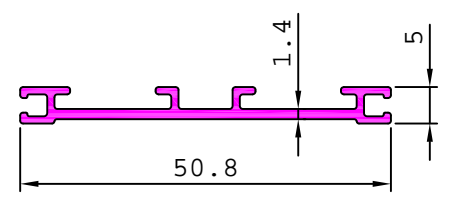

20399 0.391 kg/m

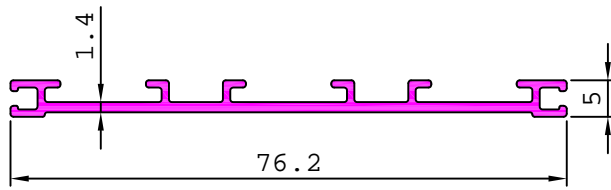

35018 0.239 kg/m

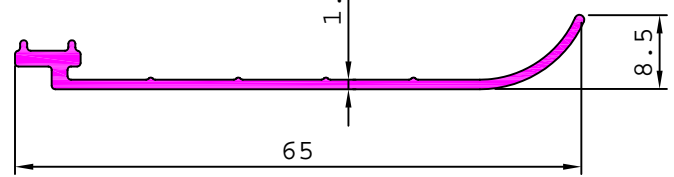

20396 0.204 kg/m

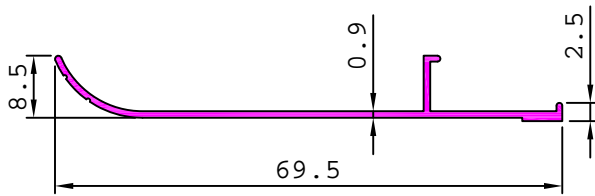

35001 0.238 kg/m

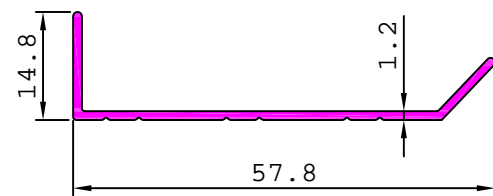

20415 0.774 kg/m

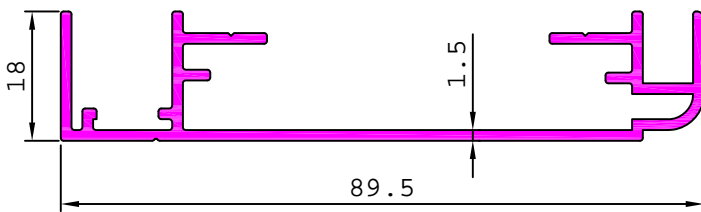

20392 1.023 kg/m

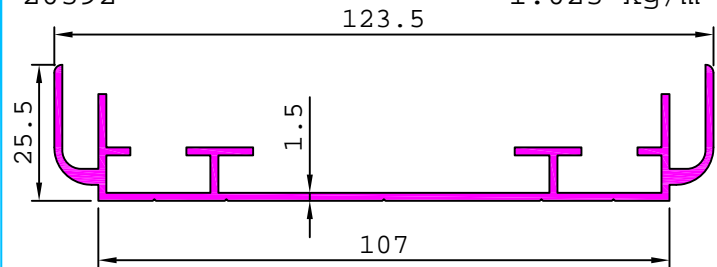

35090 0.194 kg/m

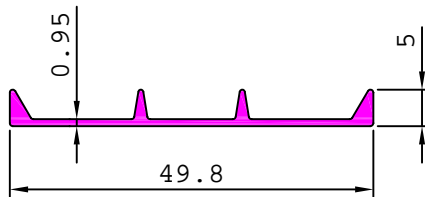

35004 0.574 kg/m

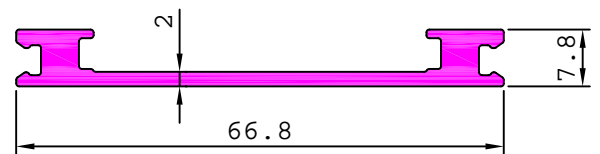

22367 0.499 kg/m

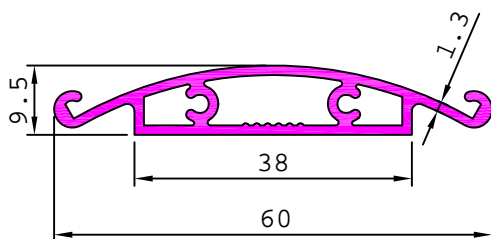

ARCHITECTURAL

DISPLAY SECTION

20456 0.846 kg/m

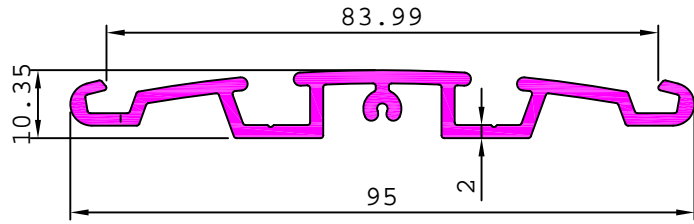

35089 0.844 kg/m

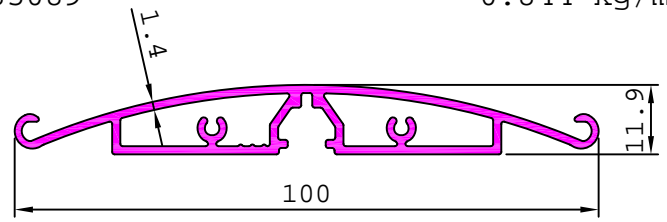

20457 1.503 kg/m

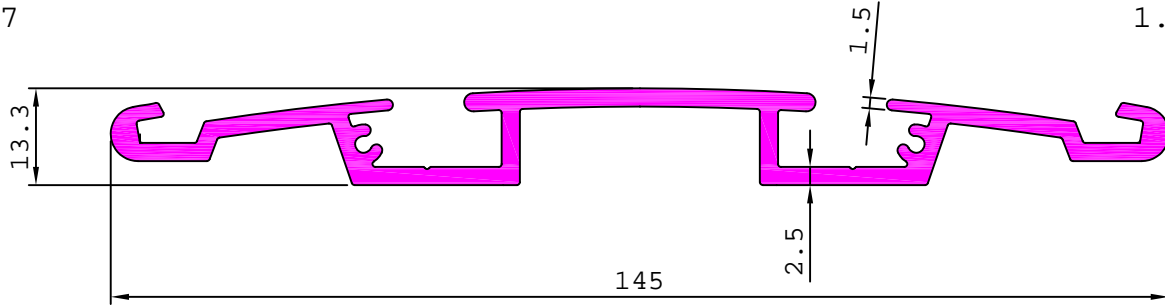

20458 2.154 kg/m

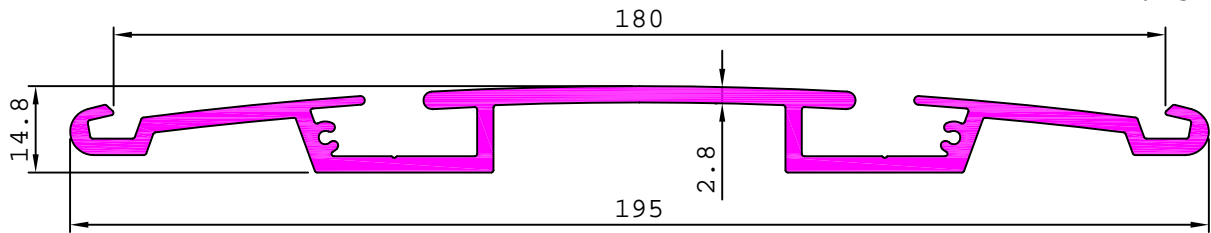

35092 1.423 kg/m

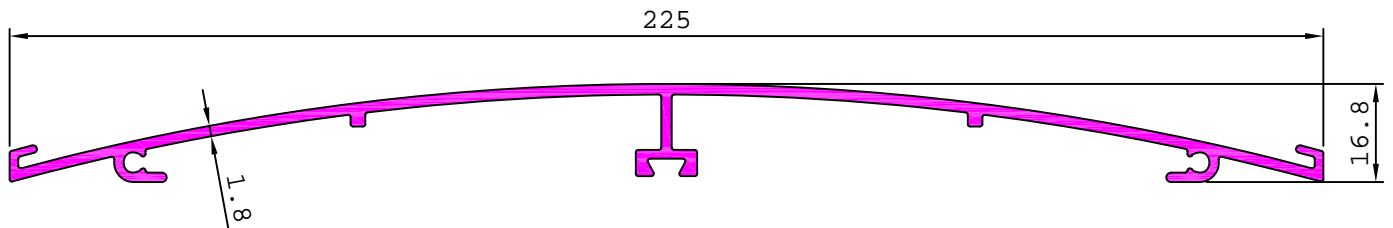

35098 0.297 kg/m

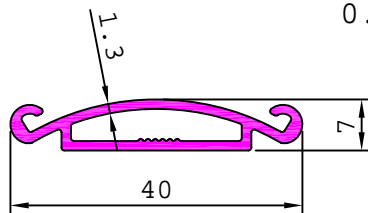

S4840 0.497 kg/m

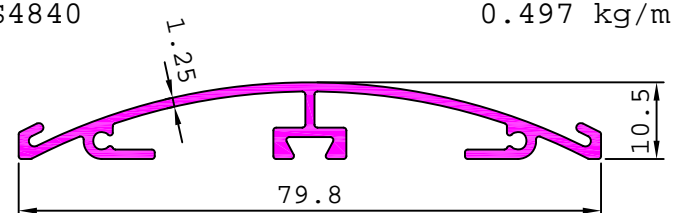

S4841 0.917 kg/m

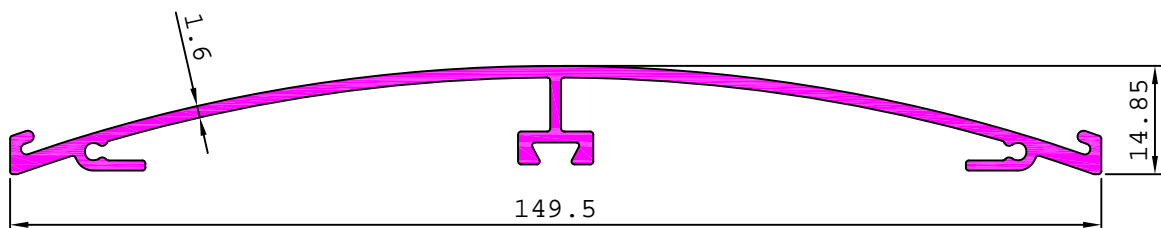

ARCHITECTURAL

DISPLAY SECTION

20447

0.473 kg/m

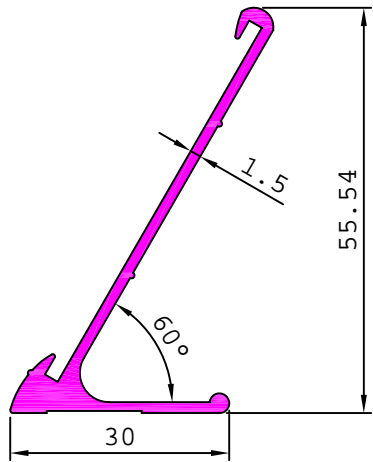

20453

0.658 kg/m

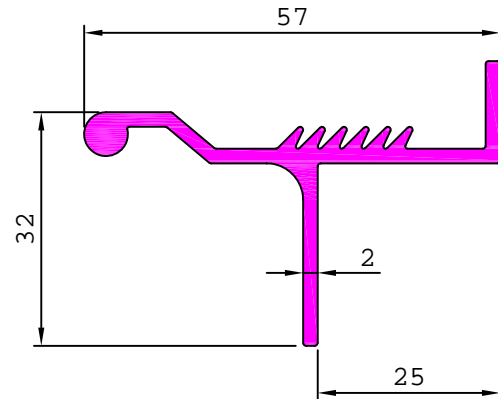

20499

0.299 kg/m

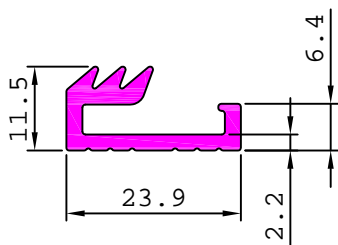

20459

0.345 kg/m

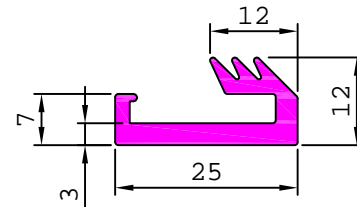

20500

0.433 kg/m

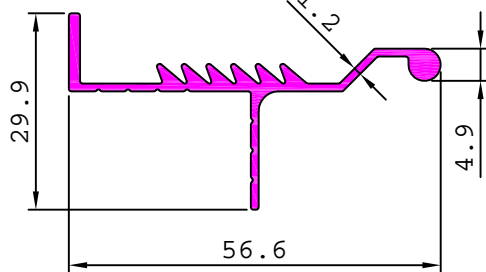

20483

1.585 kg/m

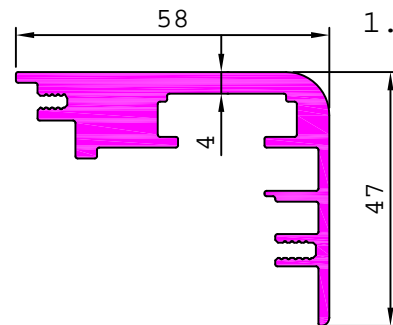

20390

2.104 kg/m

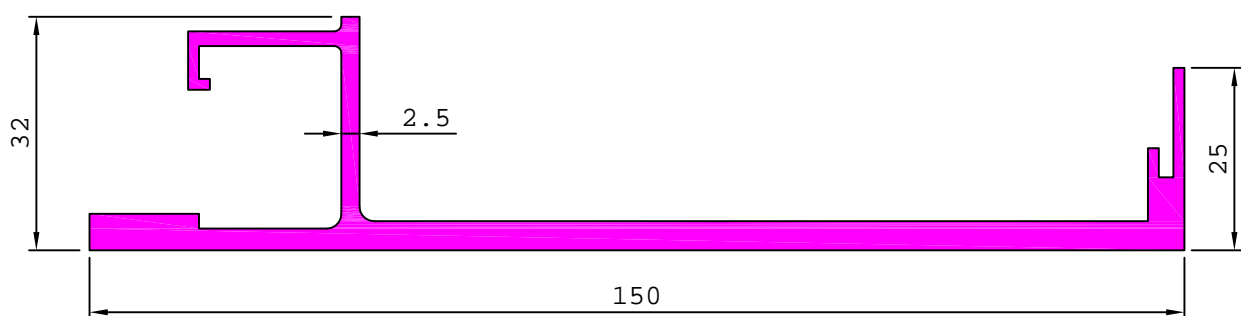

20411

0.145 kg/m

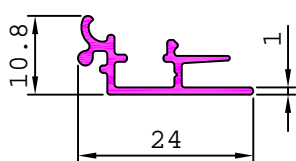

20412

0.113 kg/m

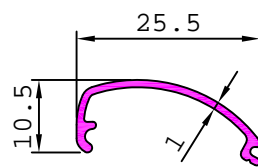

20424

0.212 kg/m

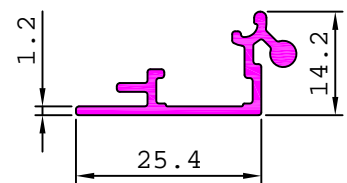

ARCHITECTURAL

DISPLAY SECTION

<p>20425 0.213 kg/m</p>	<p>20436 0.324 kg/m</p>	<p>20441 0.272 kg/m</p>
<p>20487 0.186 kg/m</p>	<p>20488 0.224 kg/m</p>	<p>20489 0.349 kg/m</p>
<p>35097 0.136 kg/m</p>	<p>20381 0.238 kg/m</p>	<p>20382 0.196 kg/m</p>
<p>27918 0.506 kg/m</p>	<p>35091 0.102 kg/m</p>	<p>35041 0.311 kg/m</p>
<p>35047 0.202 kg/m</p>	<p>35059 0.214 kg/m</p>	<p>35077 0.157 kg/m</p>
<p>35048 0.246 kg/m</p>	<p>35062 0.092 kg/m</p>	<p>35064 0.283 kg/m</p>

ARCHITECTURAL

DISPLAY SECTION

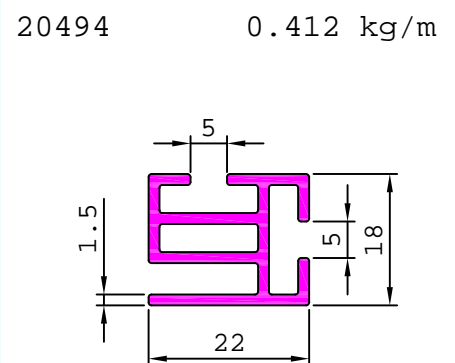
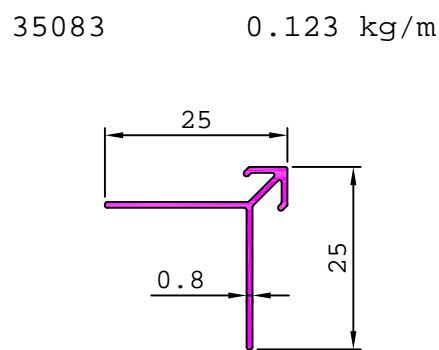
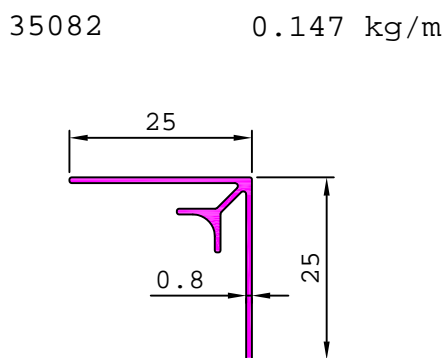
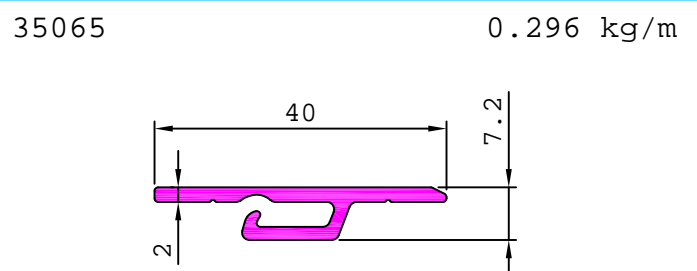
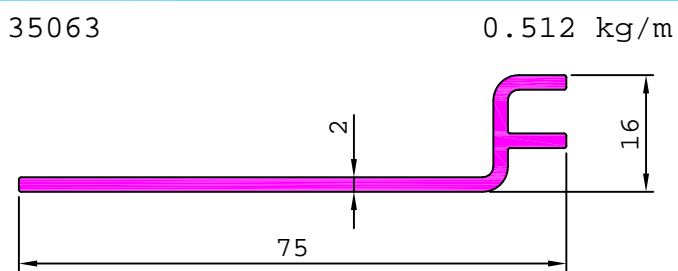
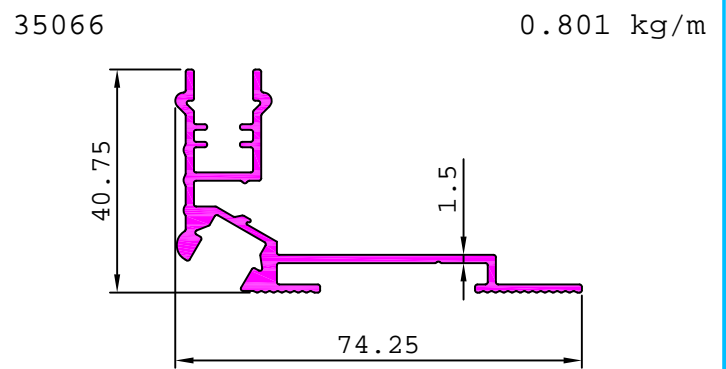
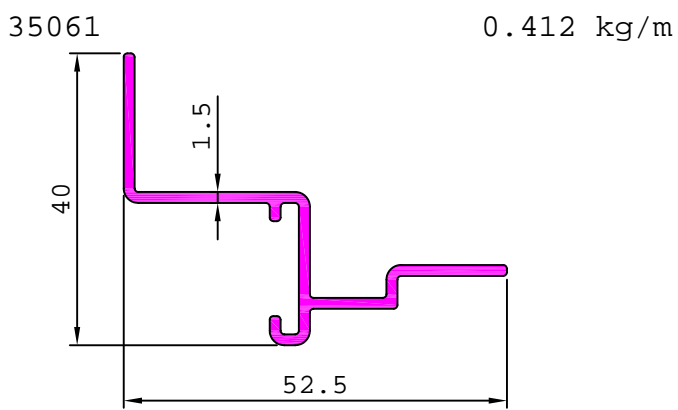
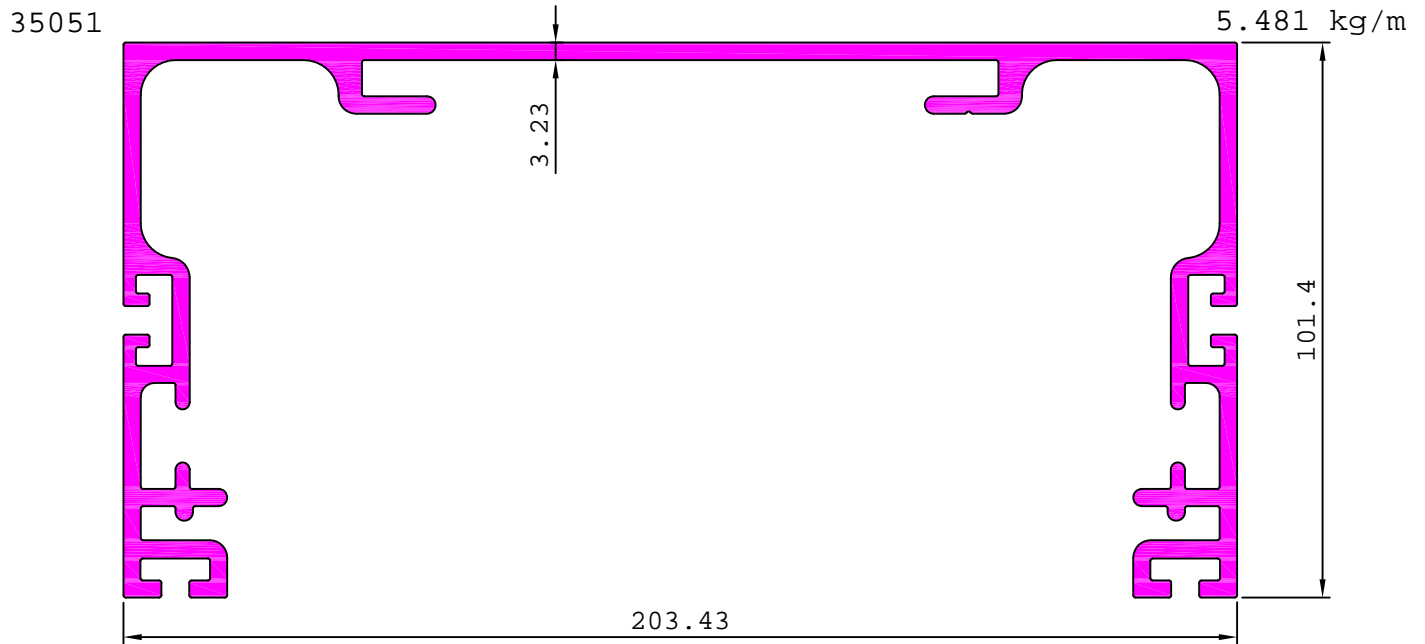

ARCHITECTURAL

DISPLAY SECTION

S4688 0.397 kg/m

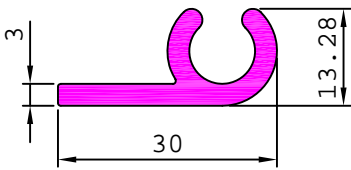

S4689 0.297 kg/m

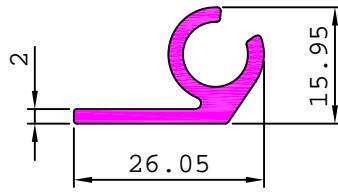

S4690 0.306 kg/m

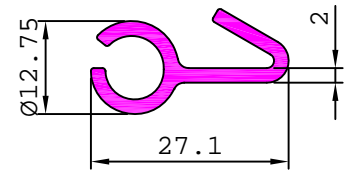

S4693 1.299 kg/m

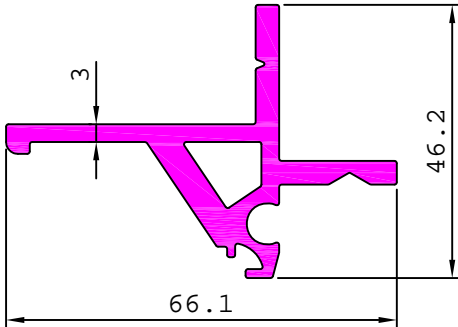

S4694 0.543 kg/m

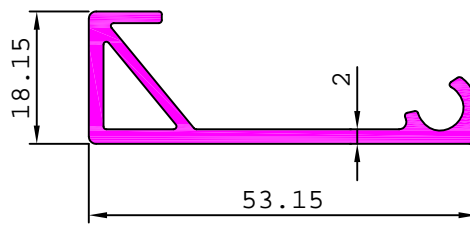

S4691 0.389 kg/m

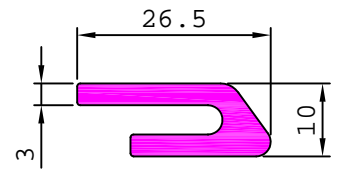

S4867 0.561 kg/m

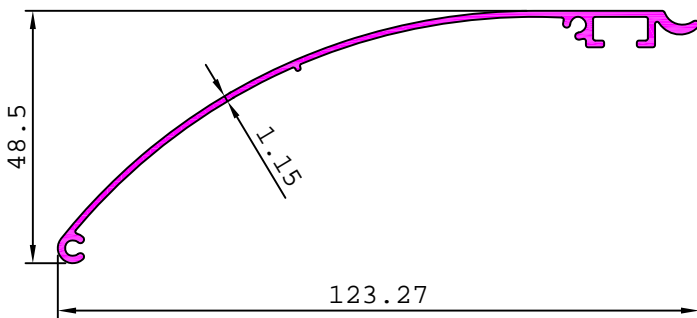

S4868 0.524 kg/m

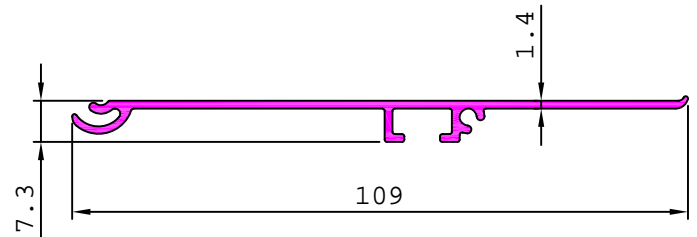

26869 0.850 kg/m

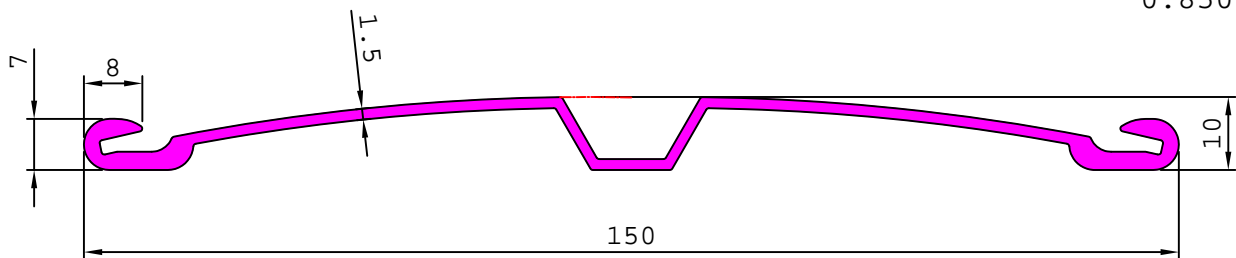

ARCHITECTURAL

DISPLAY SECTION

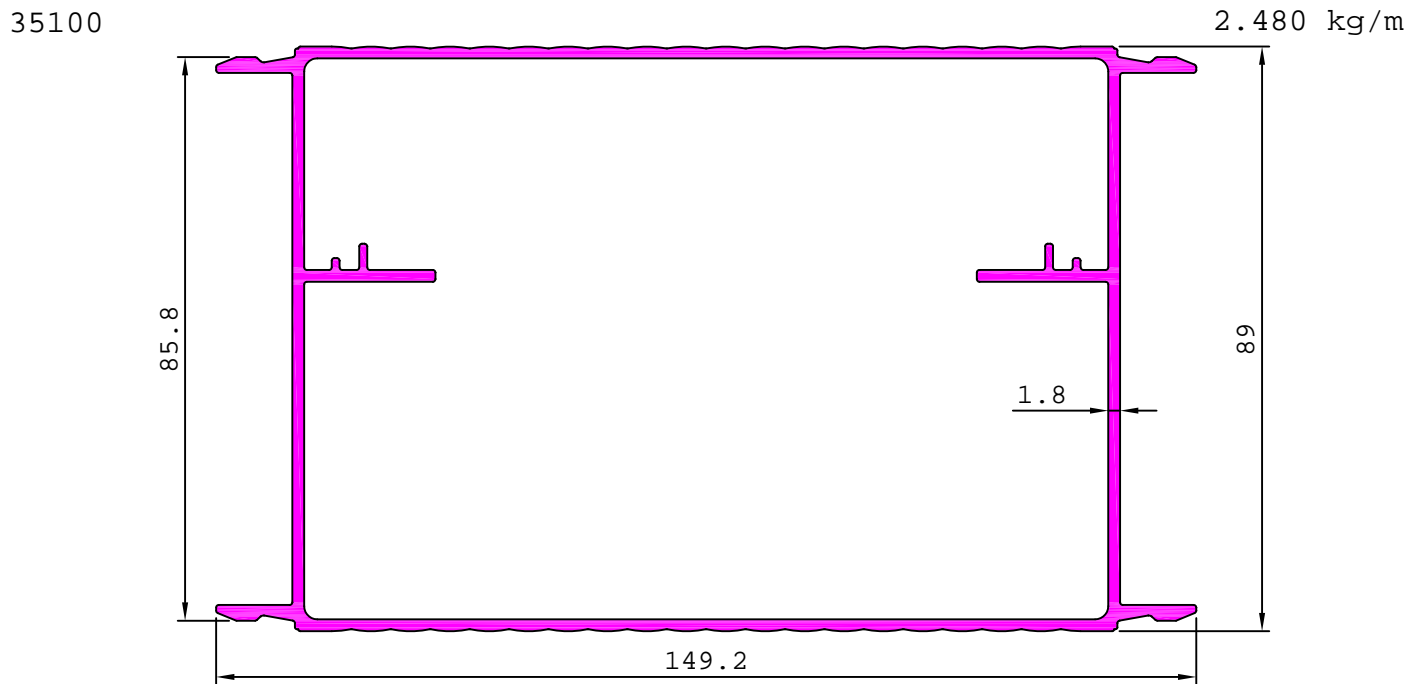

S4695 2.398 kg/m

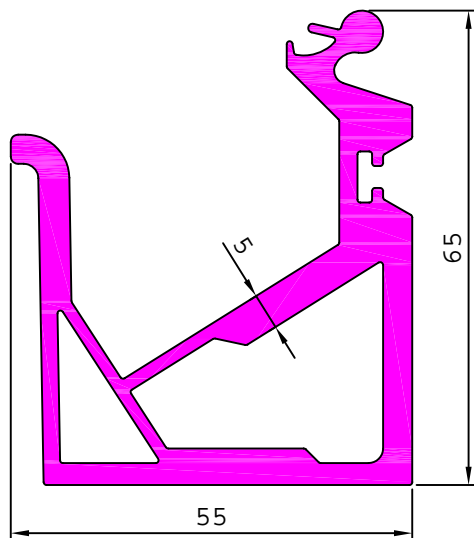

S4684 1.263 kg/m

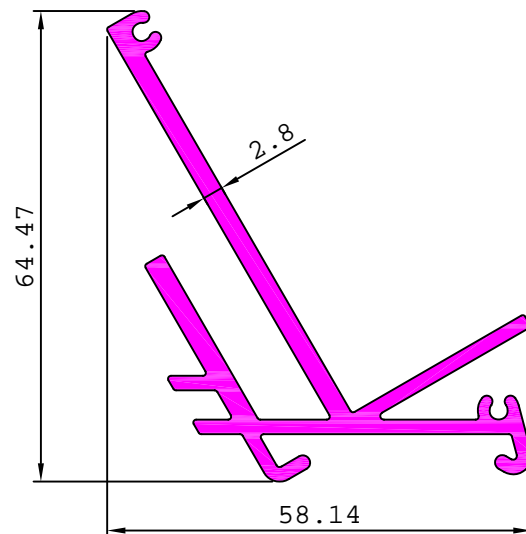

S4692 0.820 kg/m

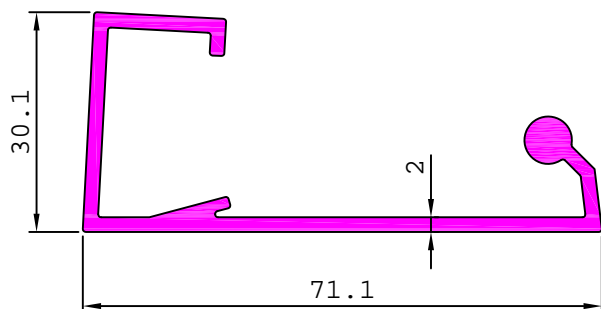

ARCHITECTURAL

DISPLAY SECTION

35087

0.425 kg/m

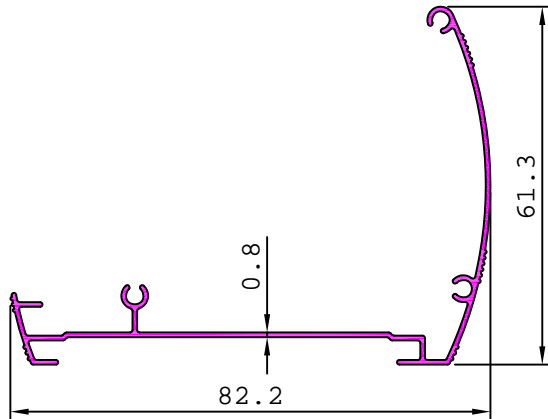

35088

0.390 kg/m

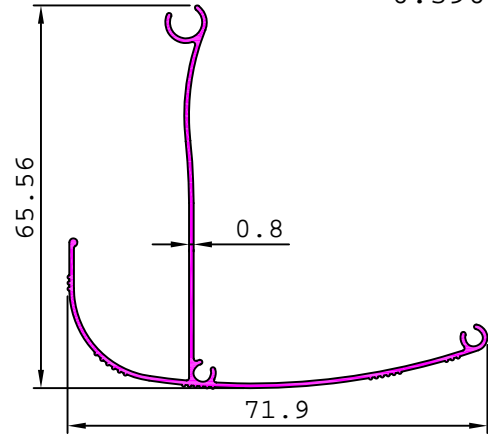

35093

0.748 kg/m

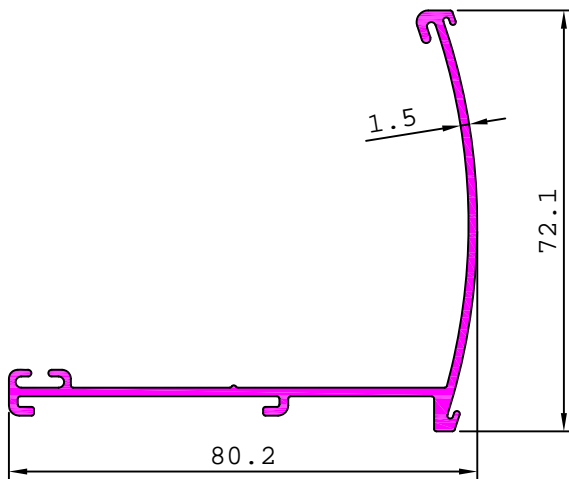

29249

0.847 kg/m

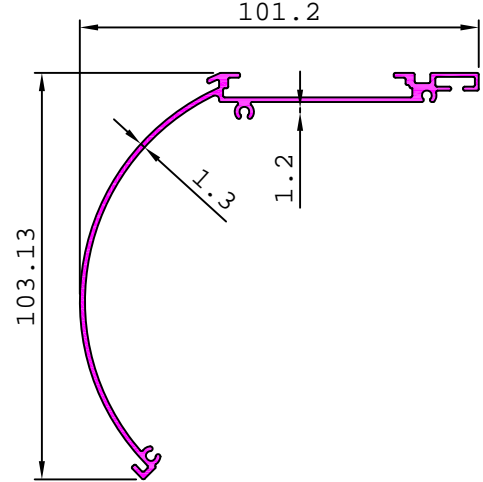

35030

5.964 kg/m

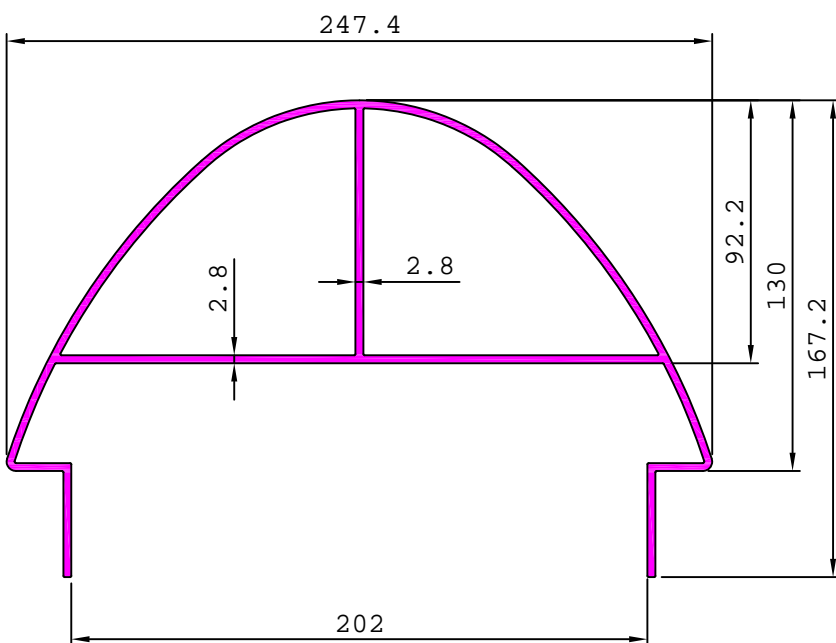

35031

2.681 kg/m

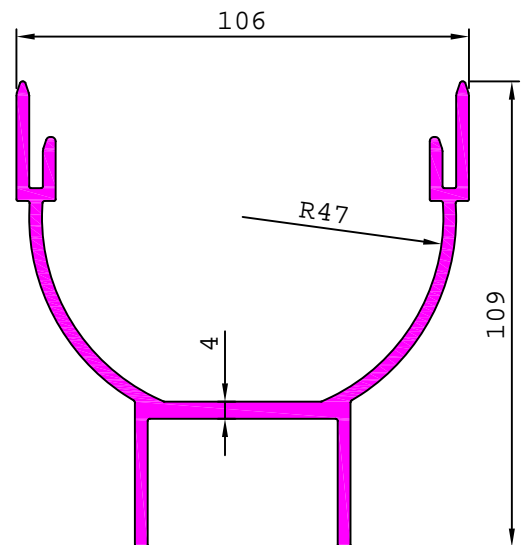

ARCHITECTURAL

DISPLAY SECTION

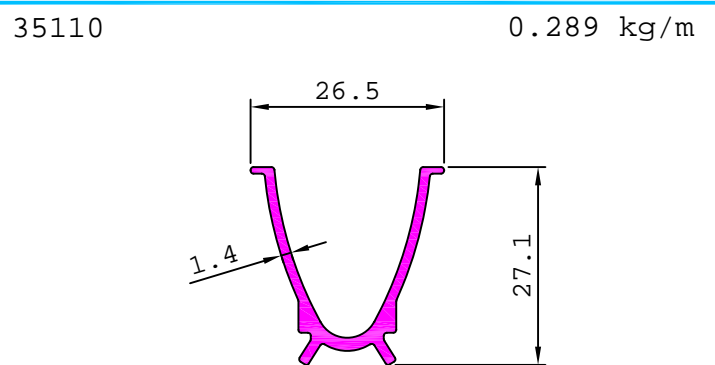
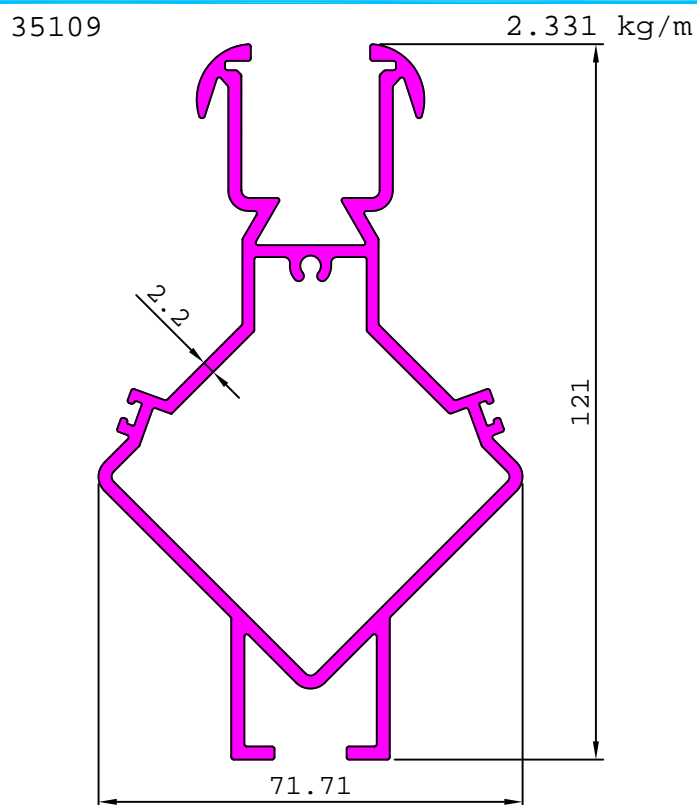
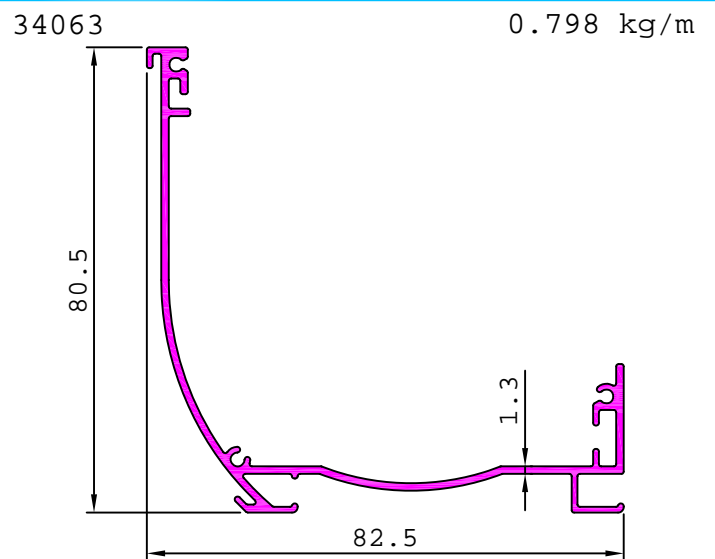
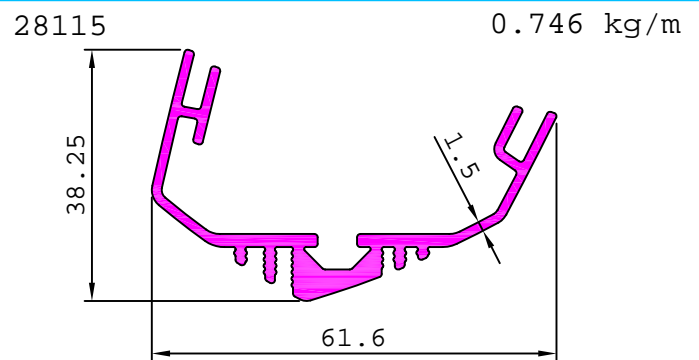
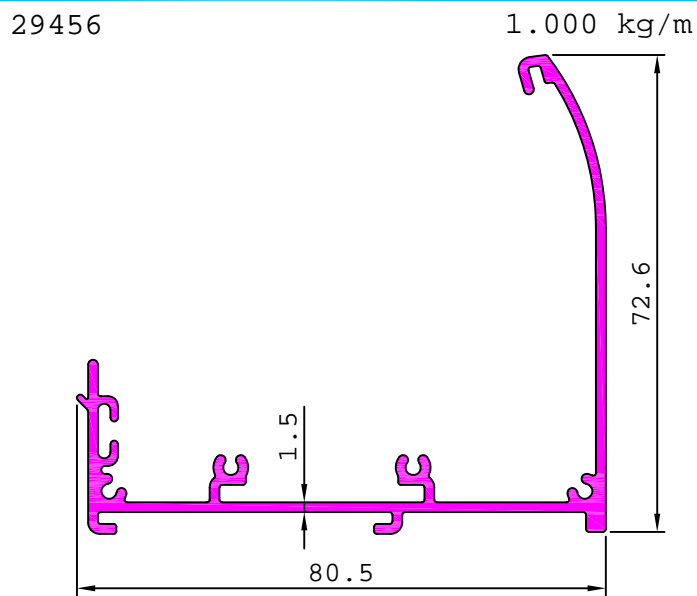
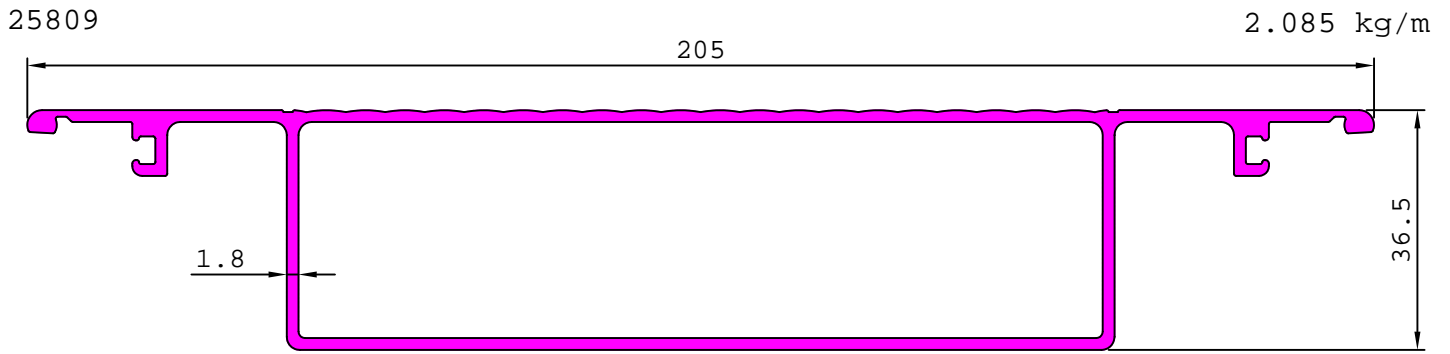

ARCHITECTURAL

DISPLAY SECTION

35111

0.831 kg/m

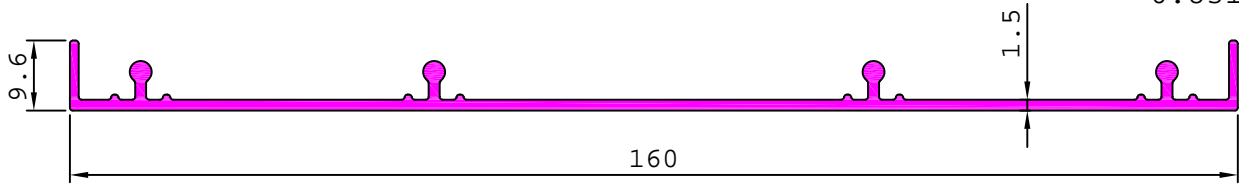

34062

0.897 kg/m

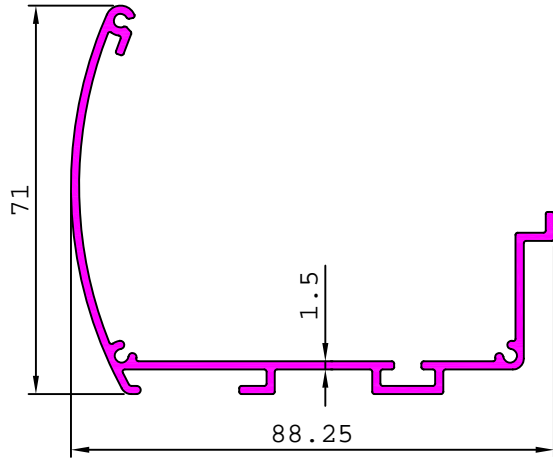

35102

2.655 kg/m

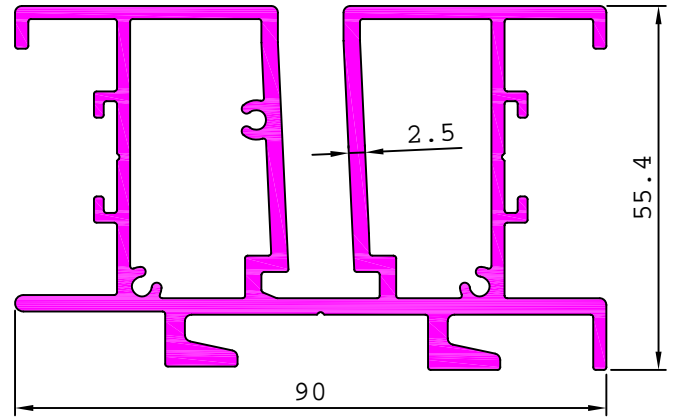

S4301

0.185 kg/m

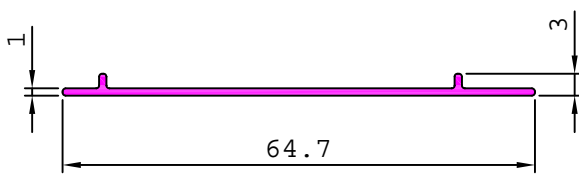

S4302

0.086 kg/m

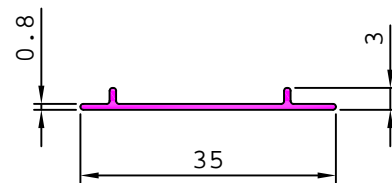

S4386

0.647 kg/m

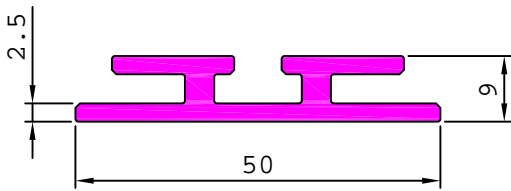

29600

0.184 kg/m

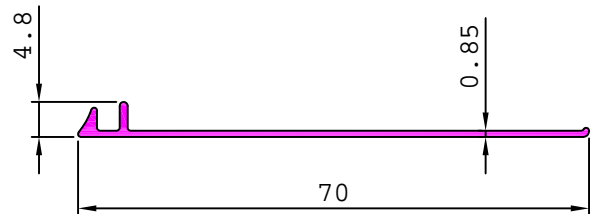

S4441

3.721 kg/m

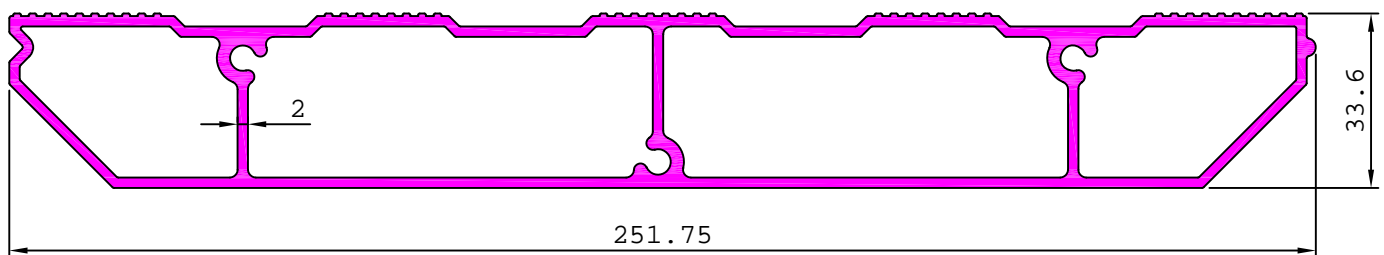

ARCHITECTURAL

DISPLAY SECTION

29601

0.524 kg/m

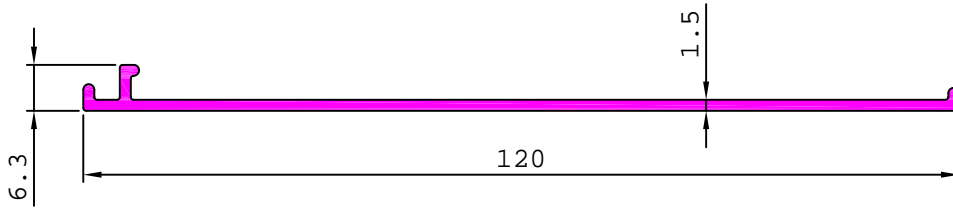

29602

0.774 kg/m

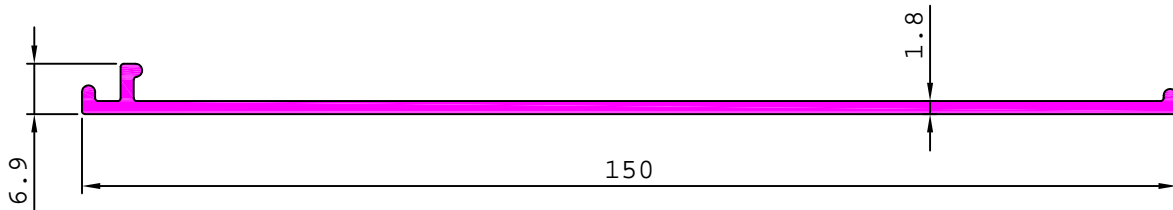

S5193

0.179 kg/m

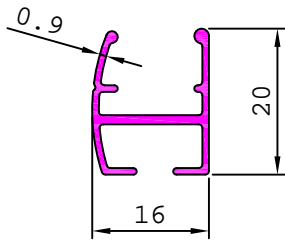

ARCHITECTURAL

DETAILS OF CASEMENT WINDOW SECTIONS

SERIES - A

20628 0.714 kg/m

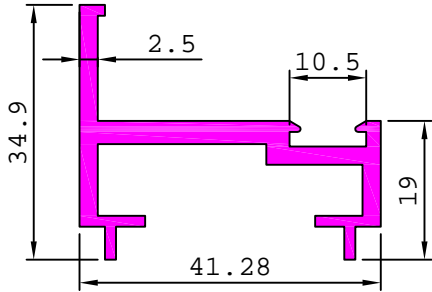

19359 0.301 kg/m

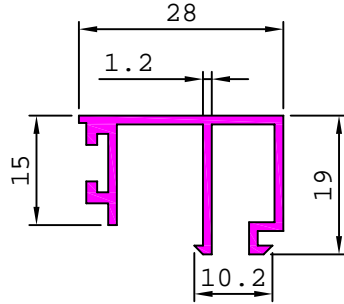

20629 0.711 kg/m

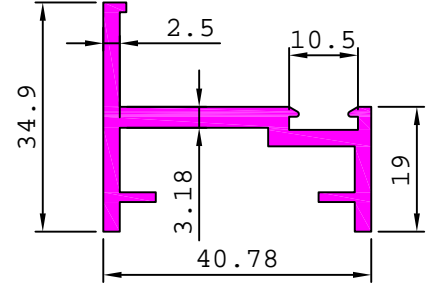

20630 0.889 kg/m

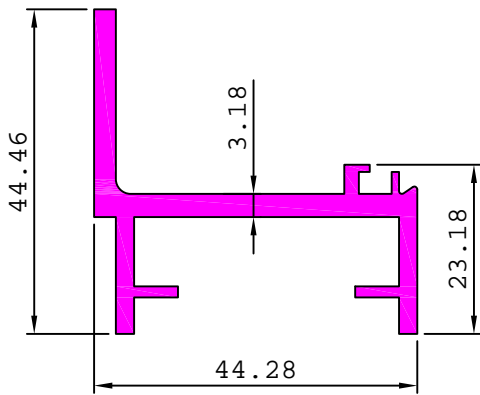

20641 1.072 kg/m

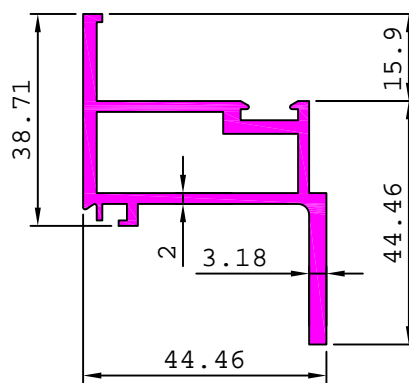

20727 1.053 kg/m

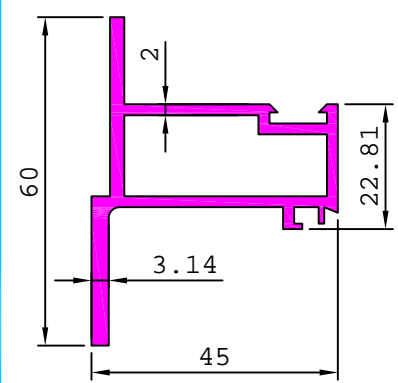

SERIES - B

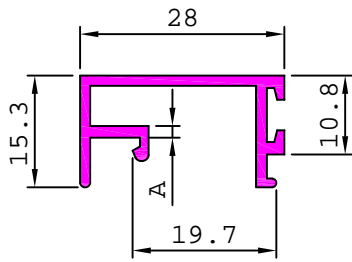

SL. No.	Section No.	A	Weight kg/m
1	19392	1.11	0.224
2	19391	1.60	0.289

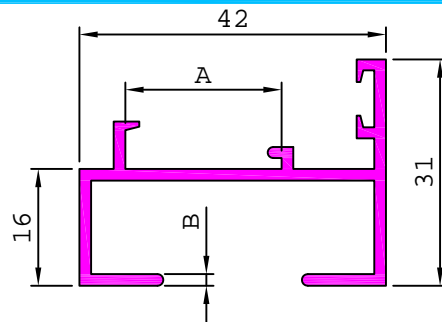

SL. No.	Section No.	A	B	Weight kg/m
1	20942	22.10	1.25	0.434
2	20558	21.40	1.60	0.534

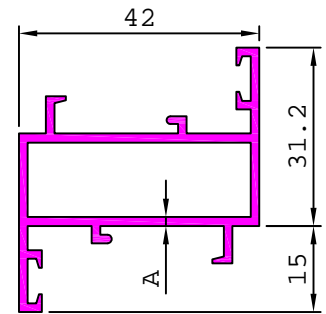

SL. No.	Section No.	A	Weight kg/m
1	20943	1.35	0.651
2	20559	1.50	0.724

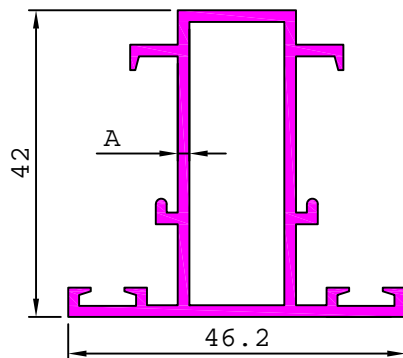

SL. No.	Section No.	A	Weight kg/m
1	20944	1.35	0.651
2	20560	1.60	0.758

ARCHITECTURAL

DETAILS OF CASEMENT WINDOW SECTIONS

SERIES - C

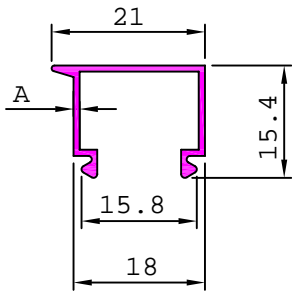

SL. No.	Section No.	A	Weight kg/m
1	19362	0.60	0.108
2	19369	0.85	0.137

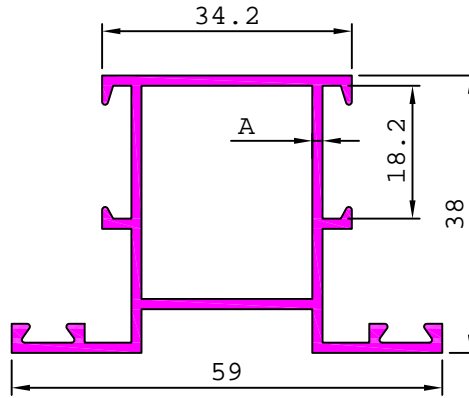

SL. No.	Section No.	A	Weight kg/m
1	20720	1.40	0.729
2	21285	1.60	0.807

20719

0.575 kg/m

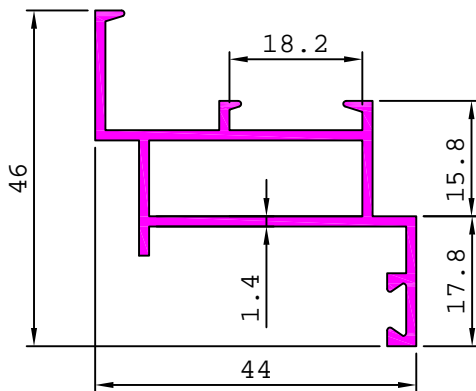

20721

0.622 kg/m

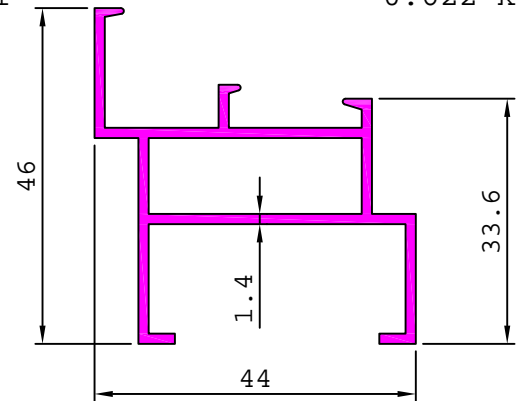

20903

0.522 kg/m

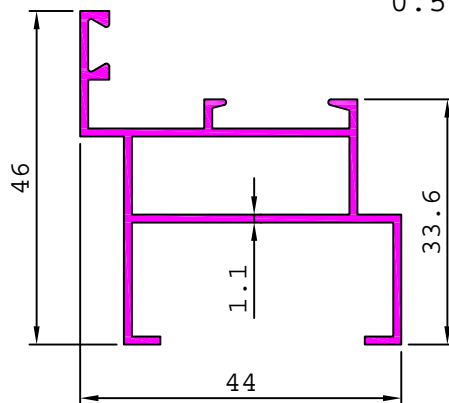

21286

0.649 kg/m

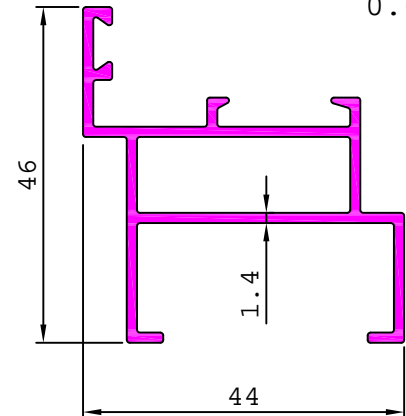

ARCHITECTURAL

DETAILS OF CASEMENT WINDOW SECTIONS

SERIES - D

20824 0.870 kg/m

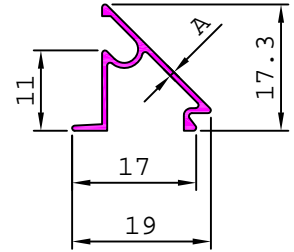
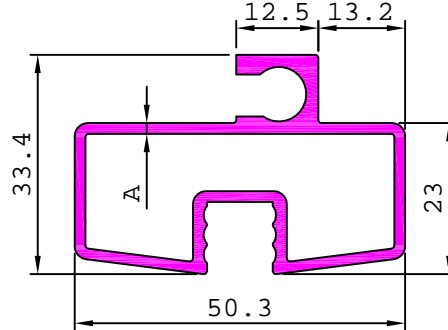
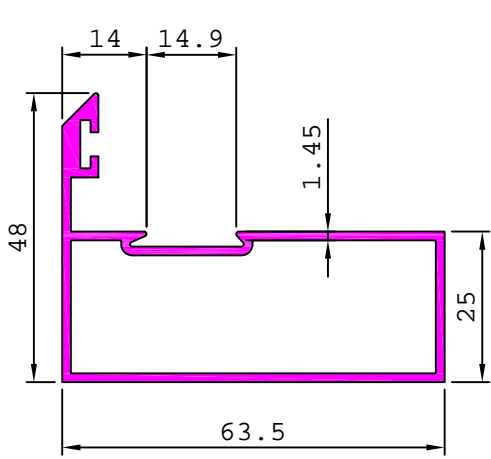

SL. No.	Section No.	A	Weight kg/m
1	20825	1.64	0.854
2	20642	2.00	0.997

SL. No.	Section No.	A	Weight kg/m
1	19352	0.70	0.097
2	19370	0.80	0.109
3	19360	0.90	0.124

21310 1.071 kg/m

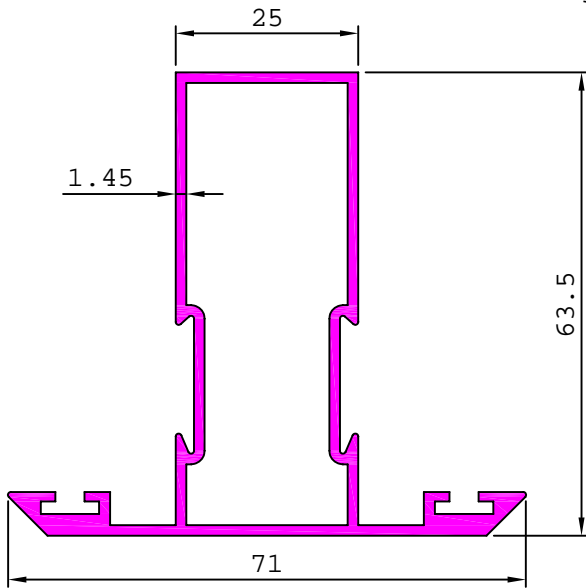

ARCHITECTURAL

DETAILS OF CASEMENT WINDOW SECTIONS

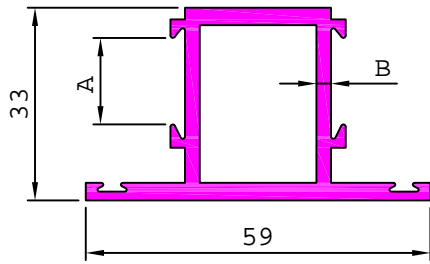

SL. No.	Section No.	A	B	Weight kg/m
1	20941	14.80	2.10	0.851
2	20510	14.82	2.50	1.123

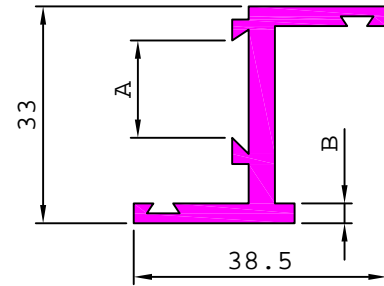

SL. No.	Section No.	A	B	Weight kg/m
1	20940	14.80	1.95	0.408
2	20509	14.82	3.00	0.663

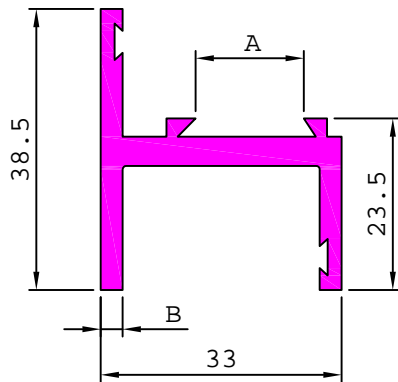

SL. No.	Section No.	A	B	Weight kg/m
1	20949	14.80	2.03	0.497
2	20948	14.80	2.56	0.606
3	20585	14.82	3.00	0.775

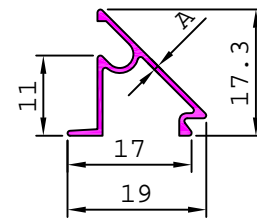

SL. No.	Section No.	A	Weight kg/m
1	19352	0.70	0.097
2	19370	0.80	0.109
3	19360	0.90	0.124

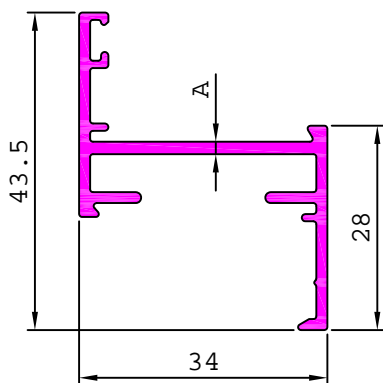

SL. No.	Section No.	A	Weight kg/m
1	20914	1.70	0.473
2	21095	2.00	0.548

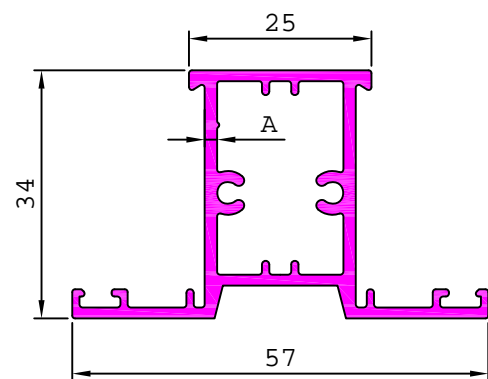

SL. No.	Section No.	A	Weight kg/m
1	21140	1.40	0.701
2	20915	1.70	0.766
3	21097	2.00	0.924

ARCHITECTURAL

DETAILS OF CASEMENT WINDOW SECTIONS

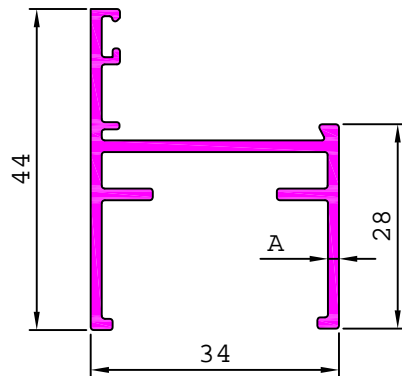

SL. No.	Section No.	A	Weight kg/m
1	21141	1.35	0.473
2	20913	1.50	0.527
3	21096	2.00	0.635

ARCHITECTURAL

DETAILS OF CASEMENT WINDOW SECTIONS

20511 0.155 kg/m

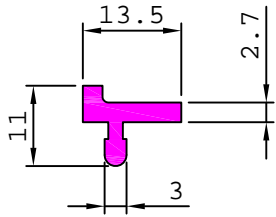

20512 0.914 kg/m

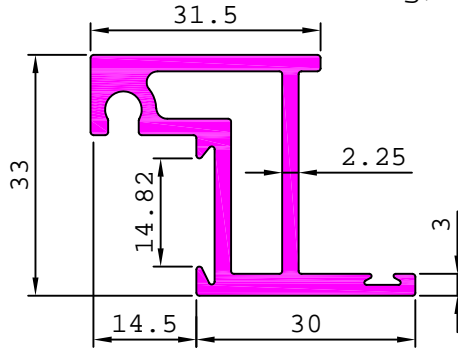

20533 0.549 kg/m

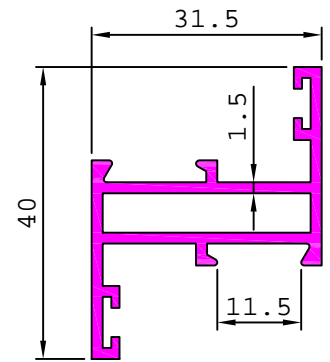

MATCHING SECTION 19389

20534 0.502 kg/m

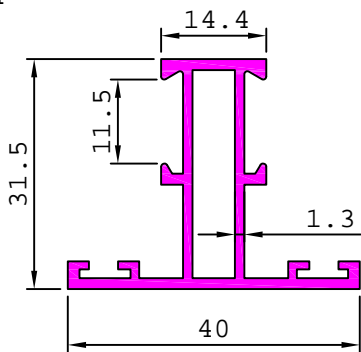

MATCHING SECTION 19389

20535 1.065 kg/m

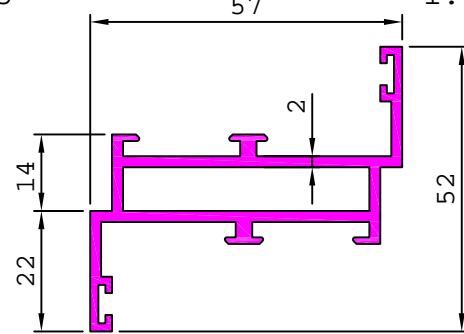

MATCHING SECTION 19390

20536 1.065 kg/m

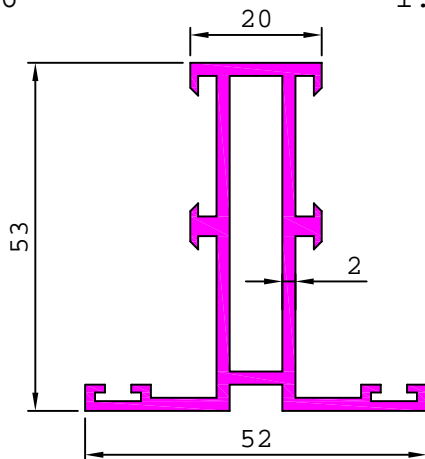

MATCHING SECTION 19390

20640 0.590 kg/m

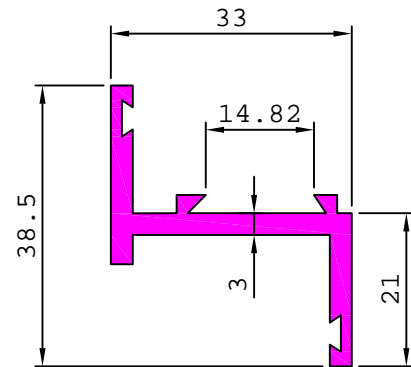

20653 0.354 kg/m

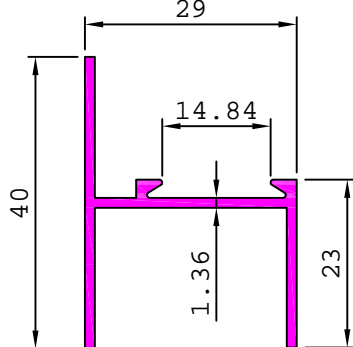

20654 0.364 kg/m

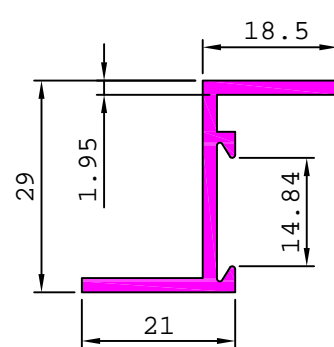

ARCHITECTURAL

DETAILS OF CASEMENT WINDOW SECTIONS

20658

0.367 kg/m

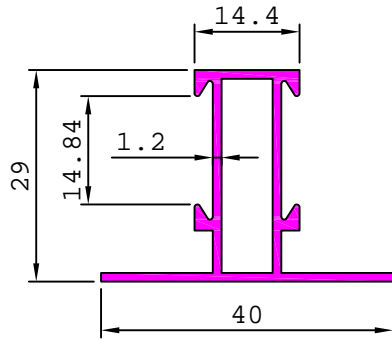

20759

0.483 kg/m

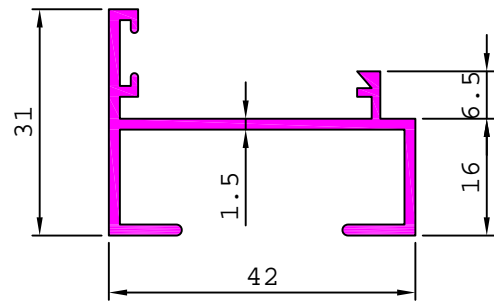

20760

0.610 kg/m

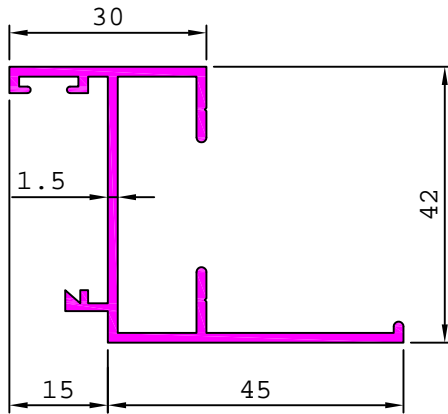

20761

0.591 kg/m

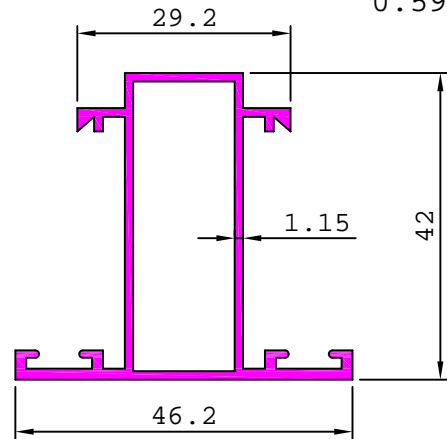

20762

0.848 kg/m

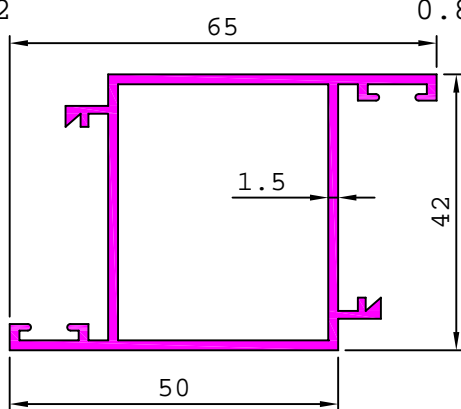

20763

0.591 kg/m

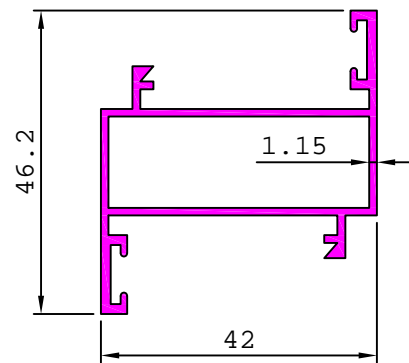

20764

0.805 kg/m

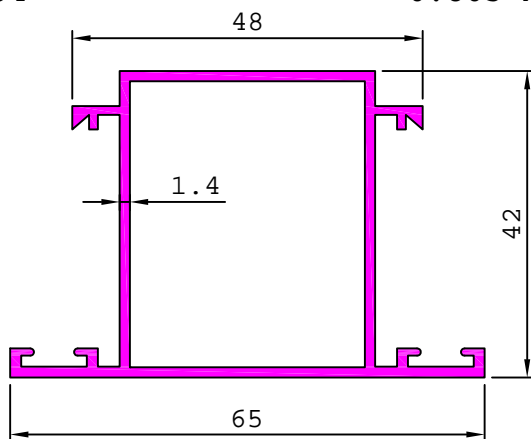

20765

0.710 kg/m

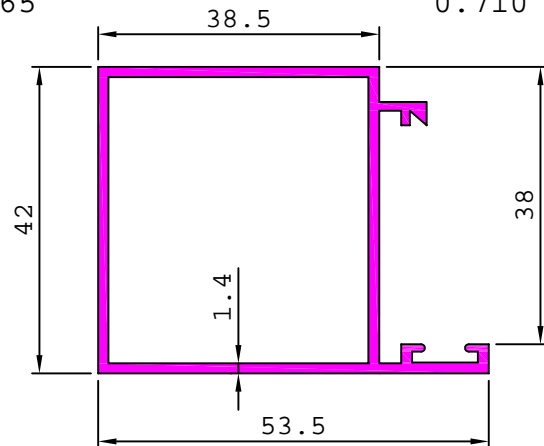

ARCHITECTURAL

DETAILS OF CASEMENT WINDOW SECTIONS

20863

0.497 kg/m

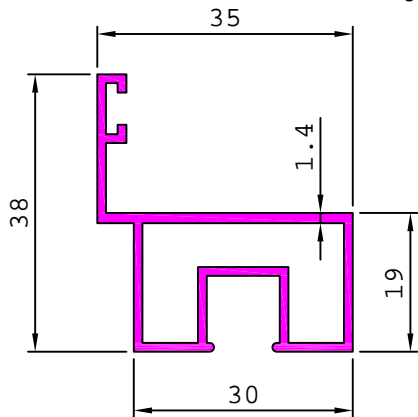

20899

0.715 kg/m

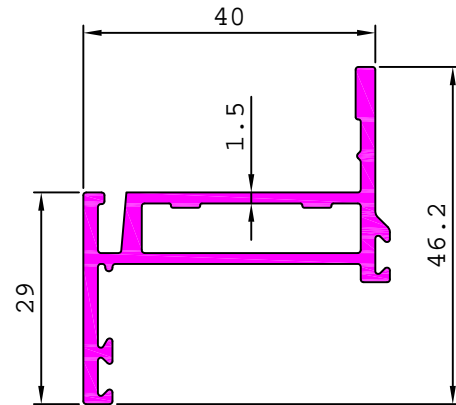

20902

1.386 kg/m

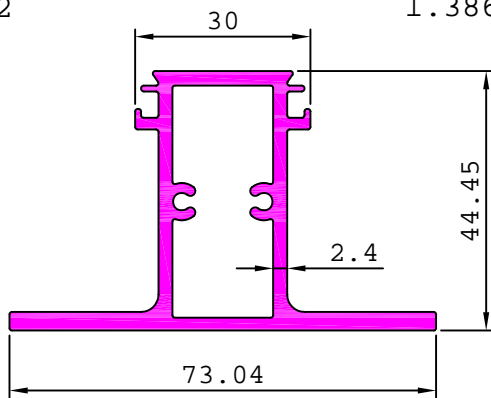

20909

1.123 kg/m

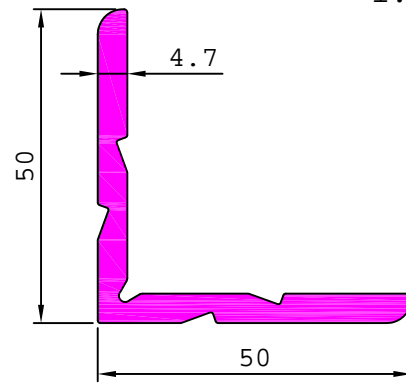

21142

0.425 kg/m

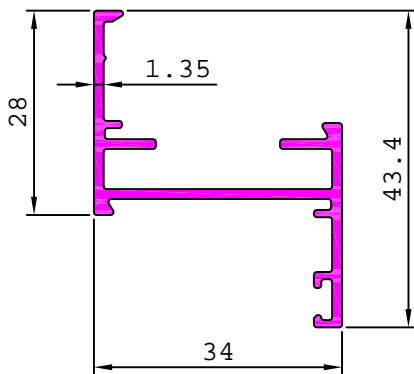

20916

0.877 kg/m

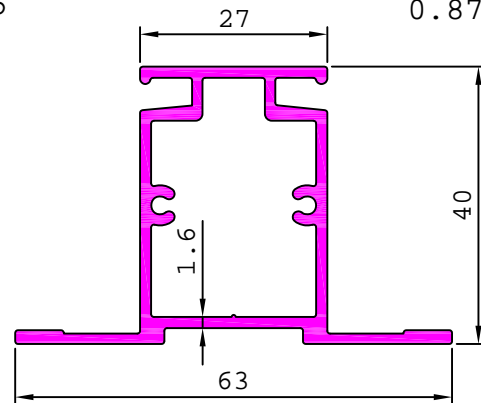

20918

0.606 kg/m

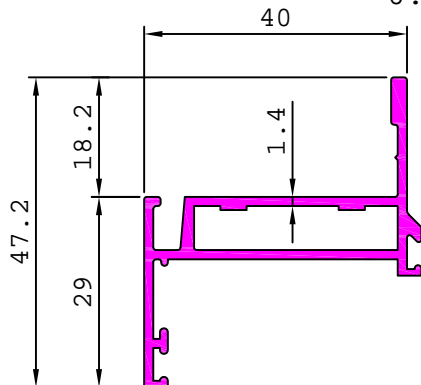

20919

0.607 kg/m

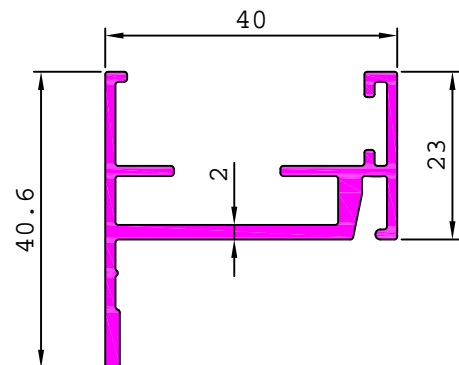

ARCHITECTURAL

DETAILS OF CASEMENT WINDOW SECTIONS

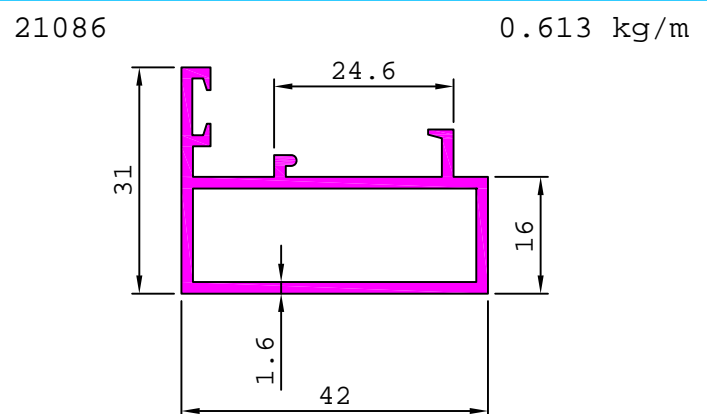
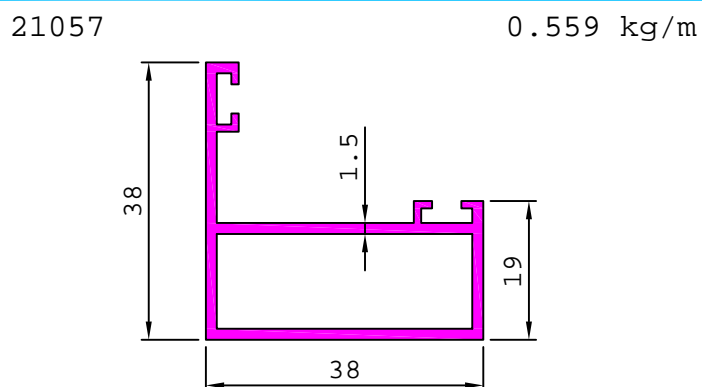
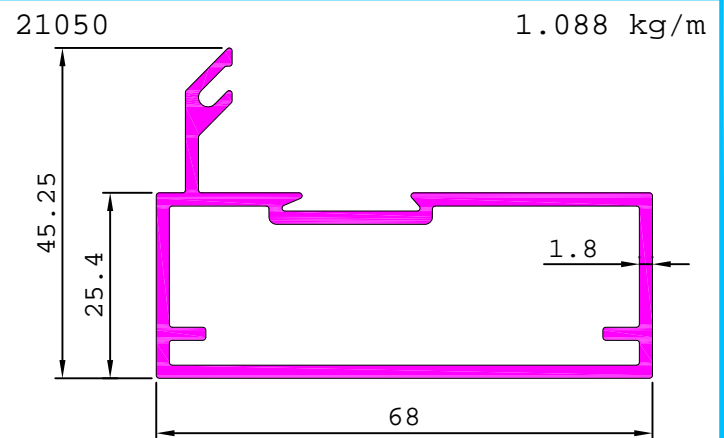
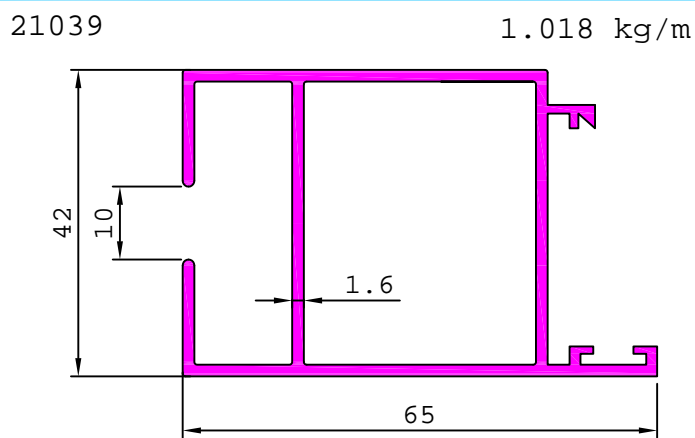
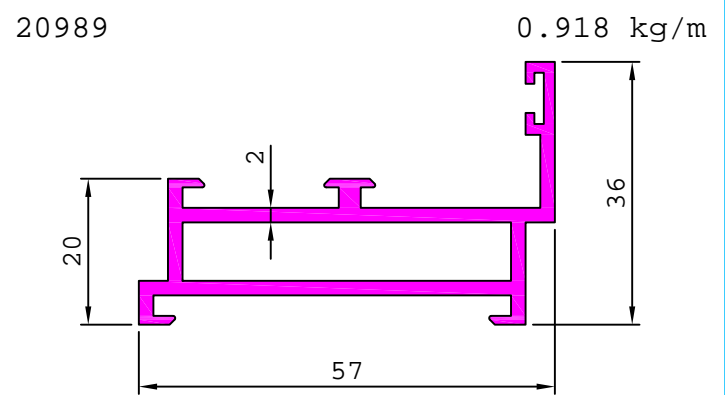
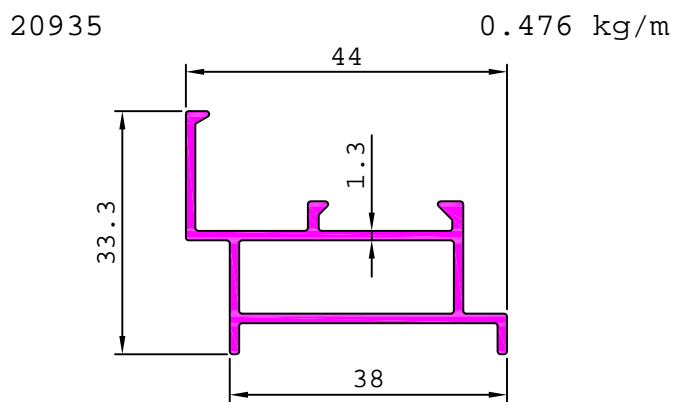
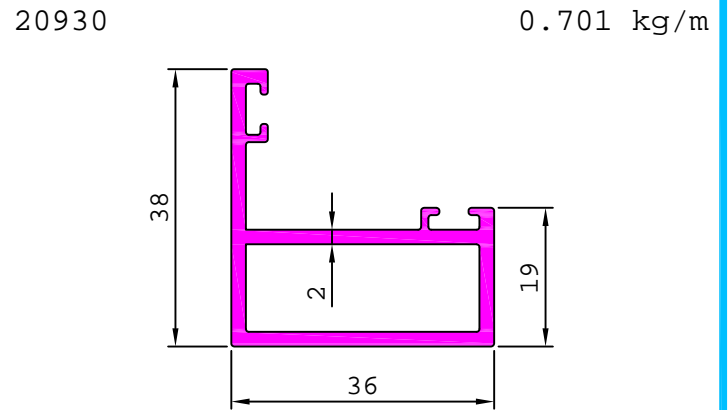
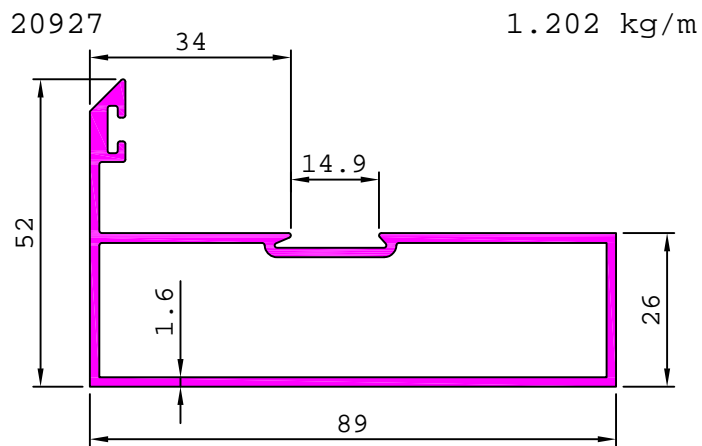

ARCHITECTURAL

DETAILS OF CASEMENT WINDOW SECTIONS

21104

0.748 kg/m

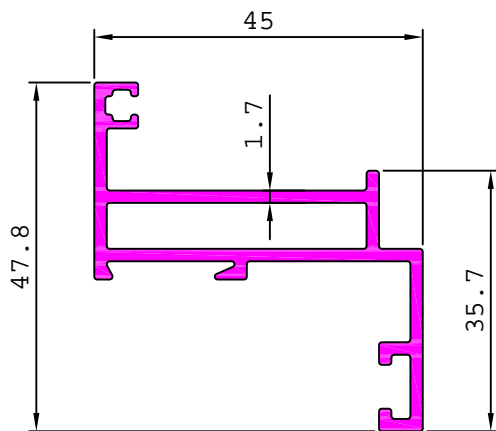

21105

0.940 kg/m

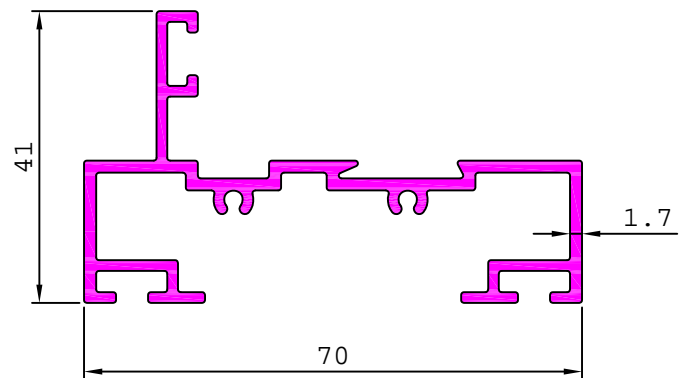

21106

1.265 kg/m

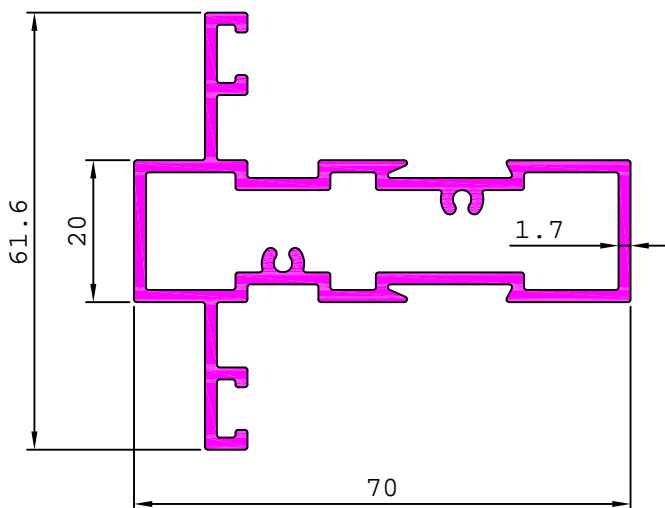

21119

1.426 kg/m

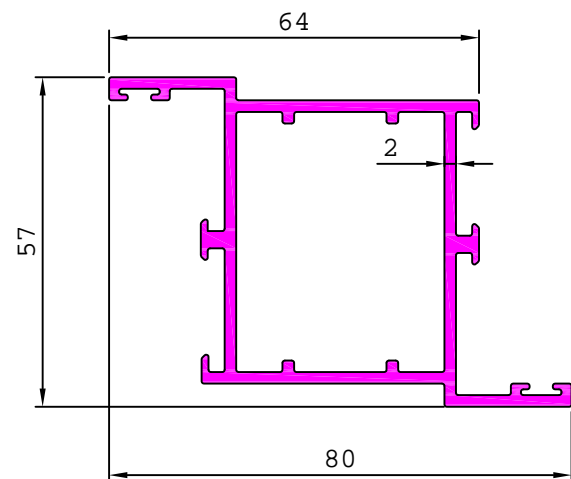

21160

0.833 kg/m

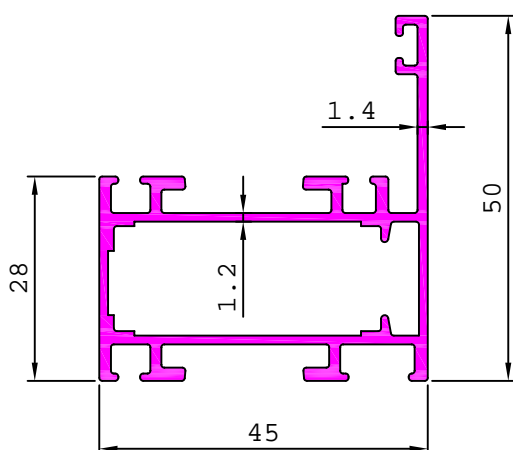

21161

1.083 kg/m

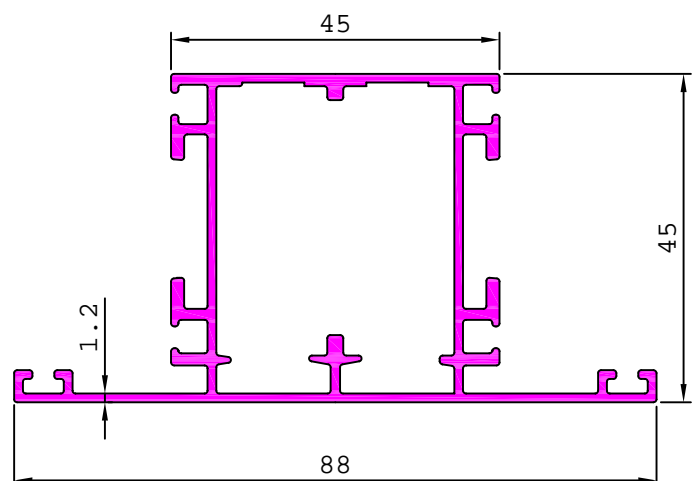

ARCHITECTURAL

DETAILS OF CASEMENT WINDOW SECTIONS

21177

0.579 kg/m

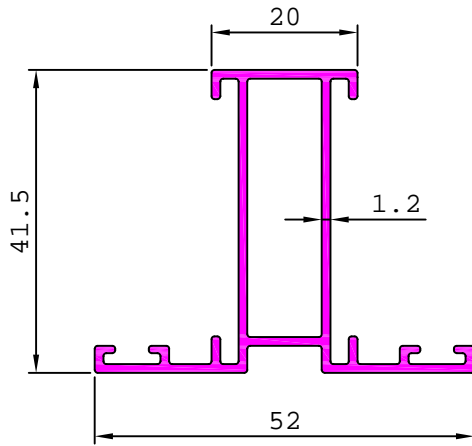

21178

0.637 kg/m

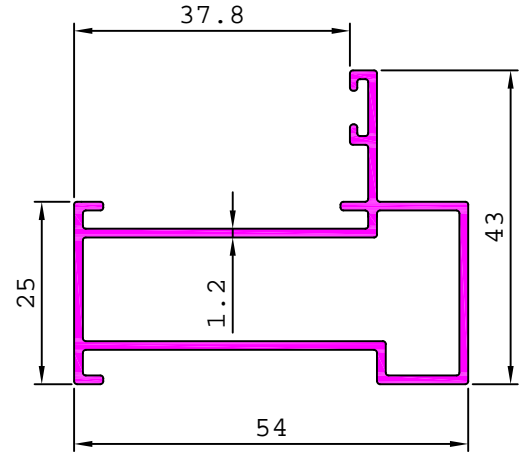

21185

0.945 kg/m

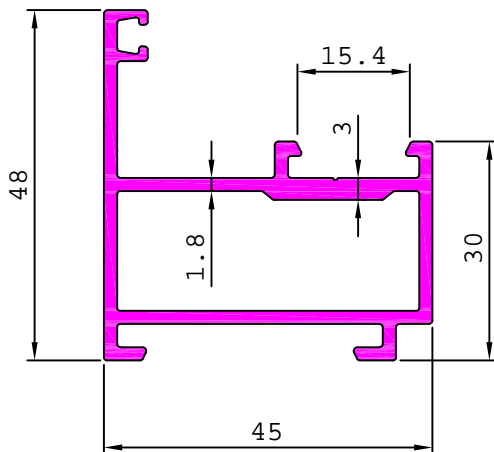

21186

1.223 kg/m

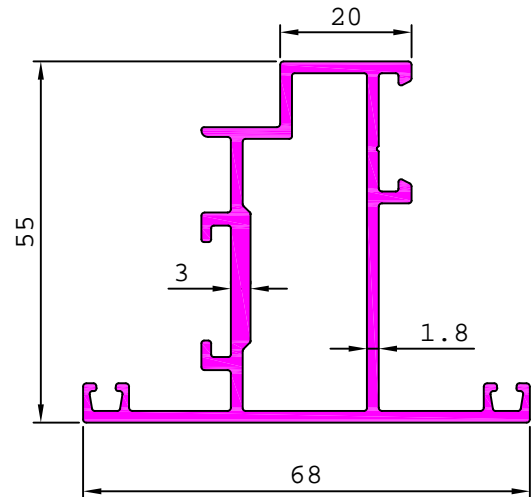

21187

1.208 kg/m

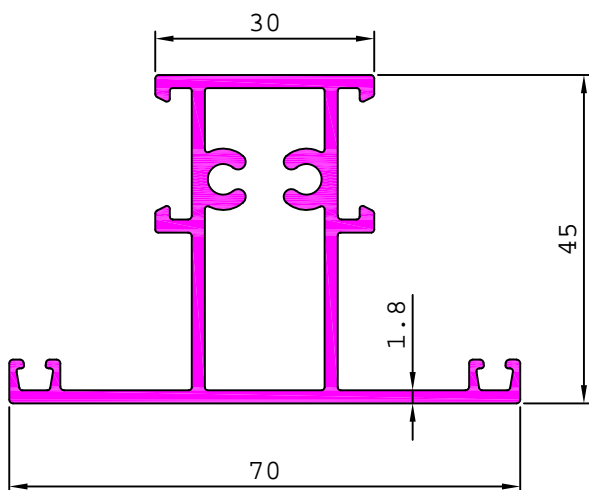

21214

0.930 kg/m

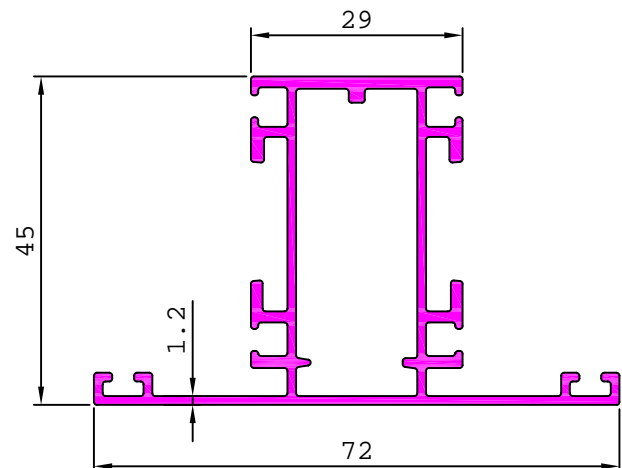

ARCHITECTURAL

DETAILS OF CASEMENT WINDOW SECTIONS

21215 0.959 kg/m

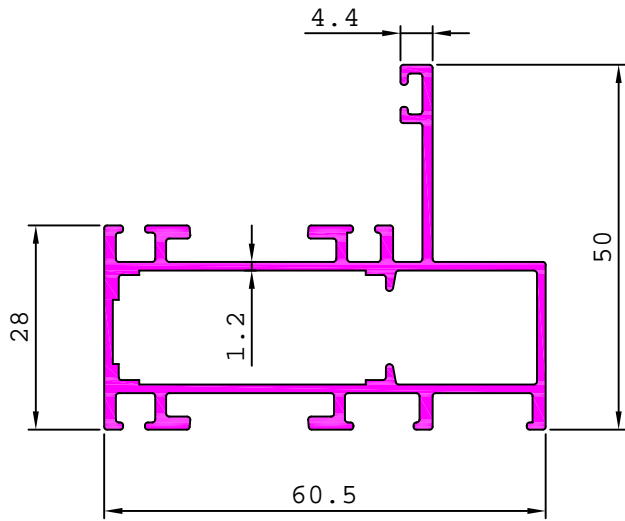

21226 1.418 kg/m

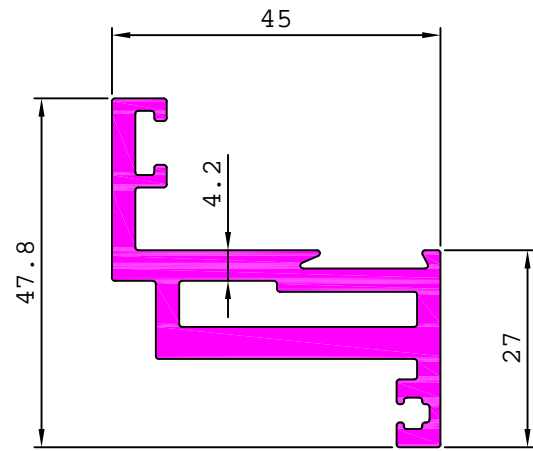

21227 1.843 kg/m

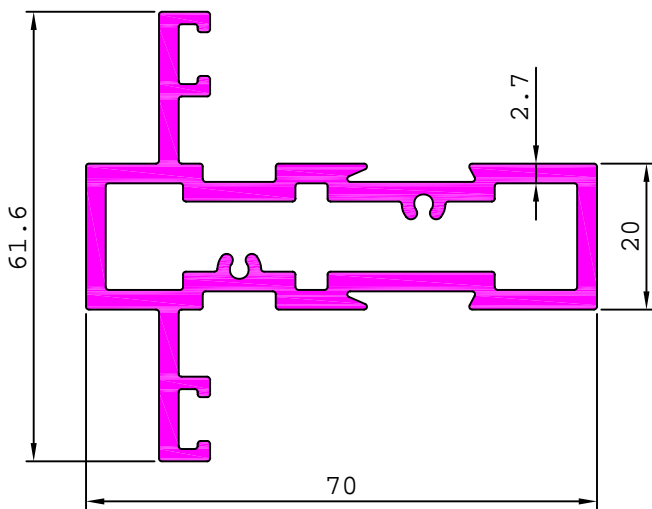

21228 1.445 kg/m

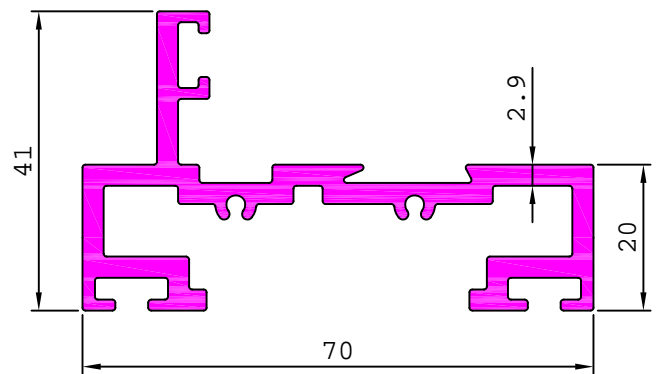

21230 0.820 kg/m

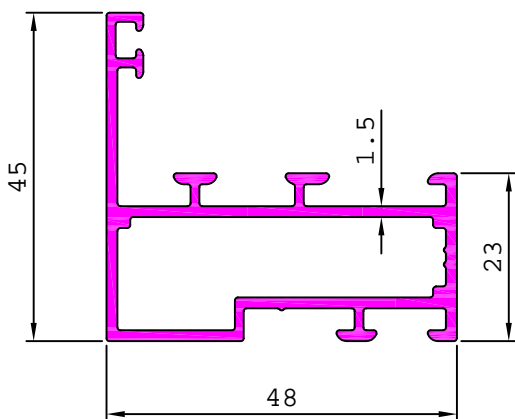

21231 0.382 kg/m

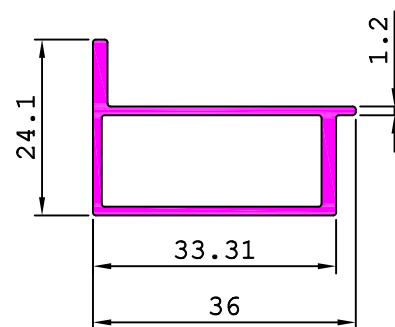

ARCHITECTURAL

DETAILS OF CASEMENT WINDOW SECTIONS

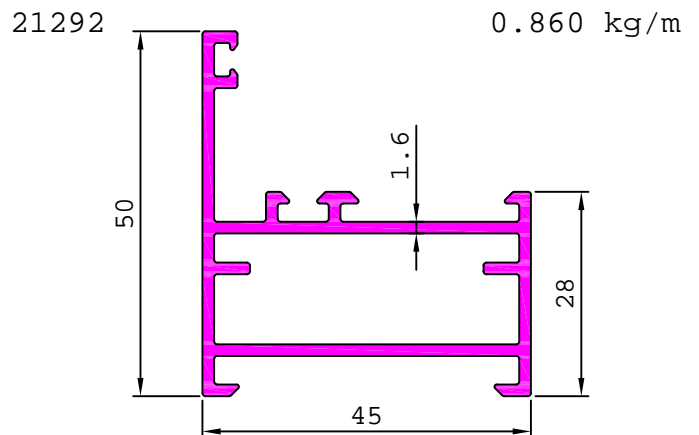
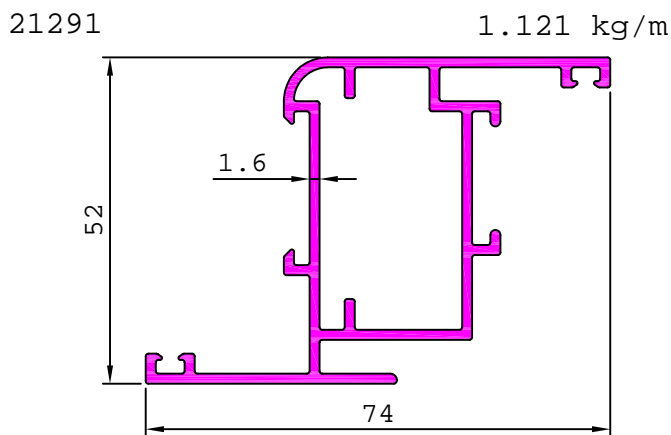
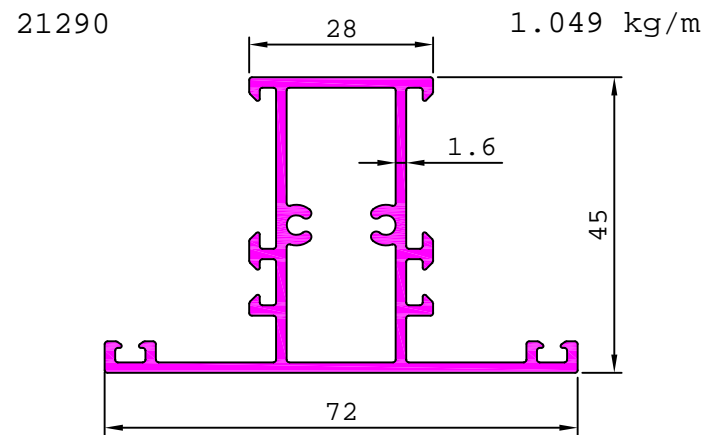
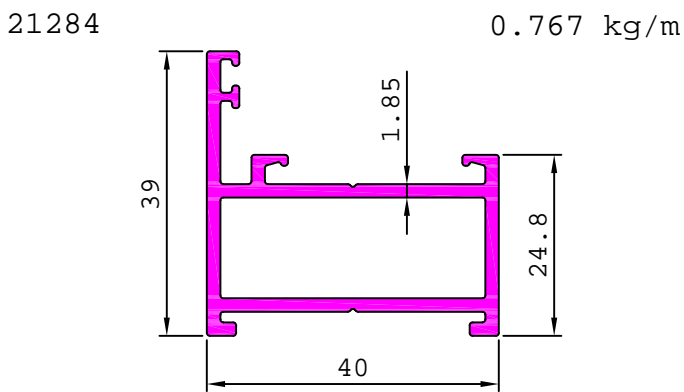
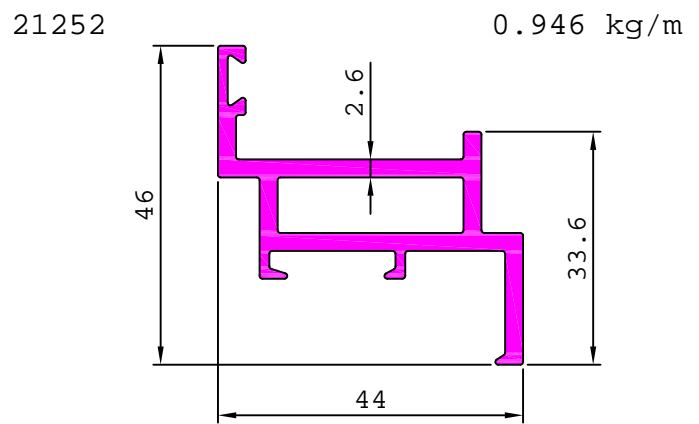
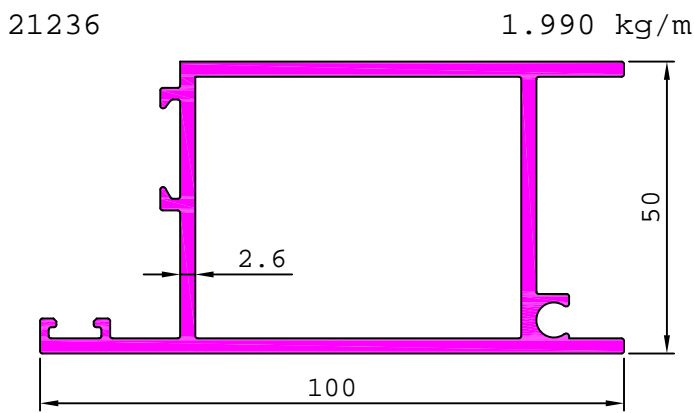
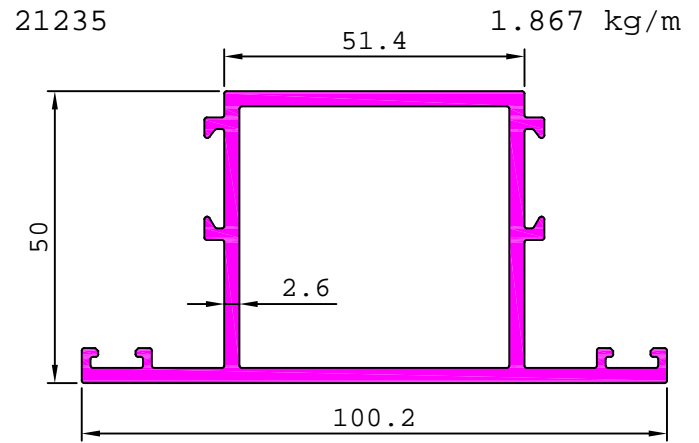
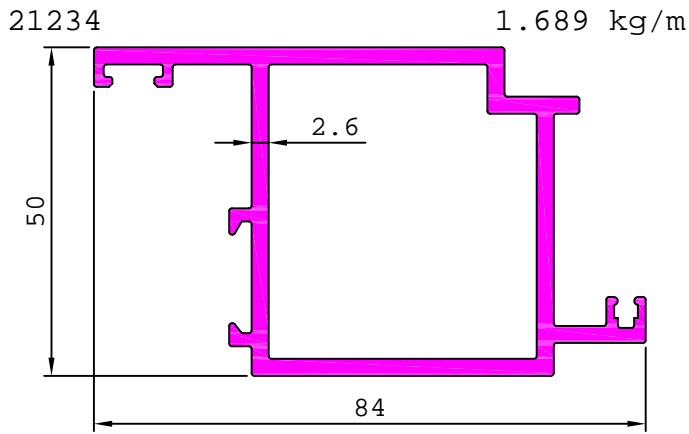

ARCHITECTURAL

DETAILS OF CASEMENT WINDOW SECTIONS

21274

1.873 kg/m

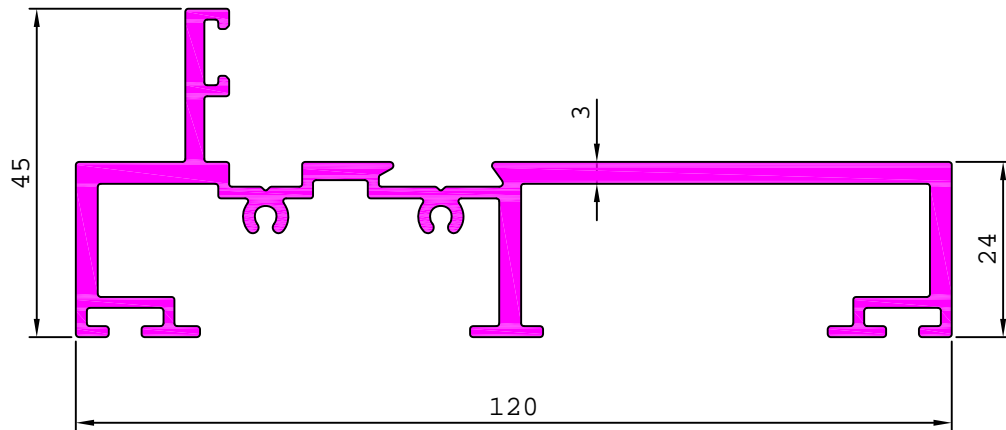

21279

2.182 kg/m

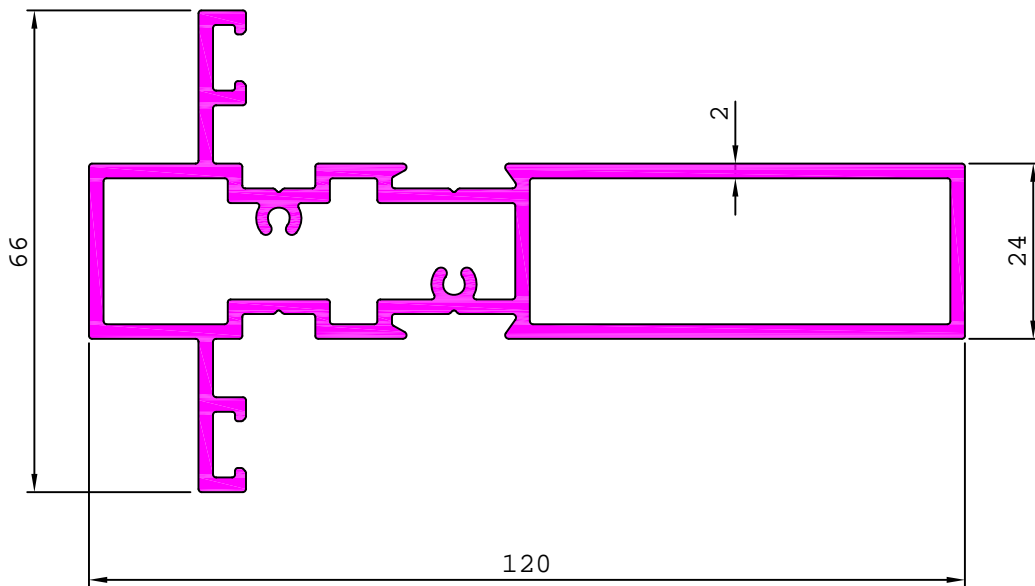

21280

1.630 kg/m

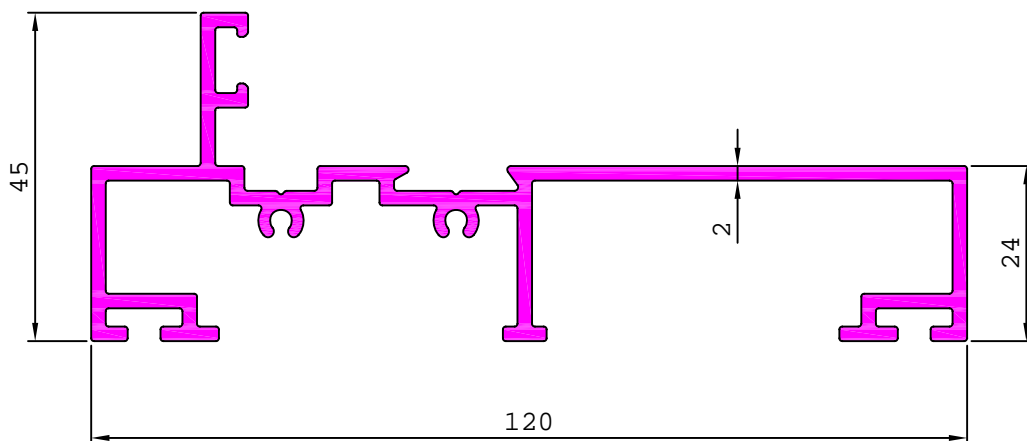

ARCHITECTURAL

DETAILS OF CASEMENT WINDOW SECTIONS

21293 1.251 kg/m

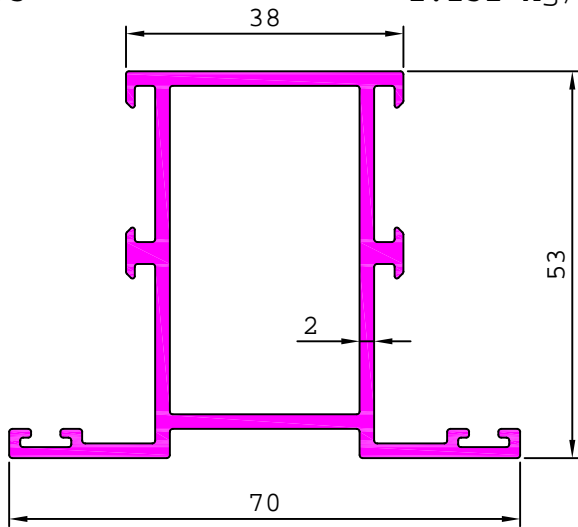

21295 1.121 kg/m

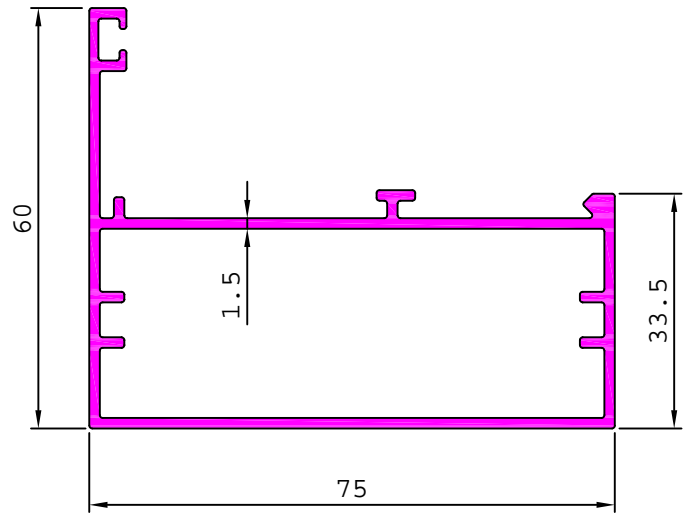

21313 0.978 kg/m

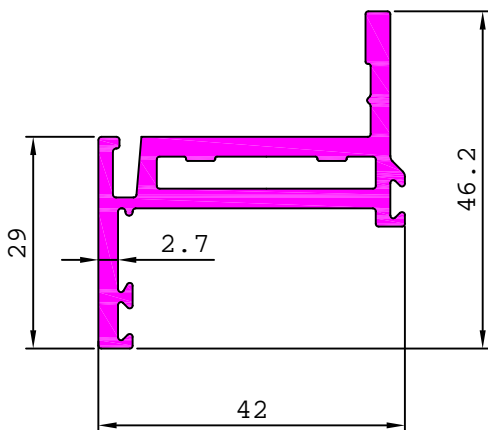

21314 0.834 kg/m

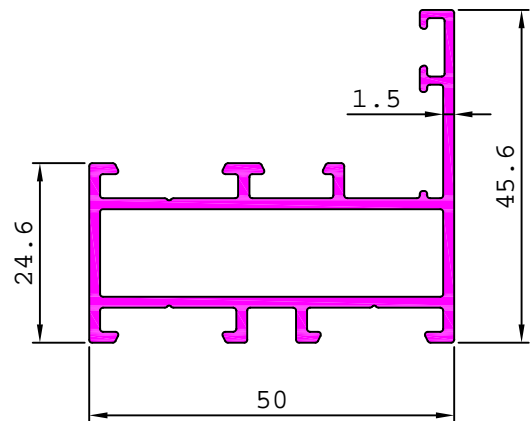

21322 0.860 kg/m

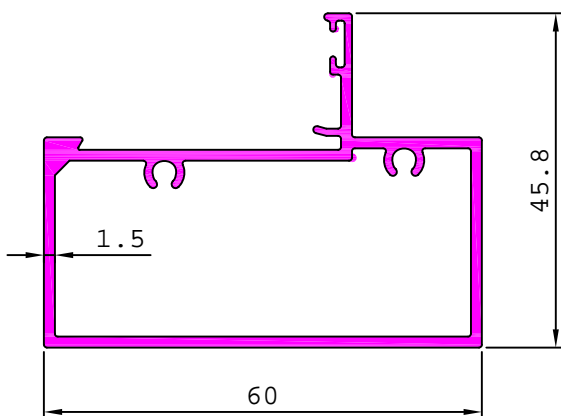

21323 0.976 kg/m

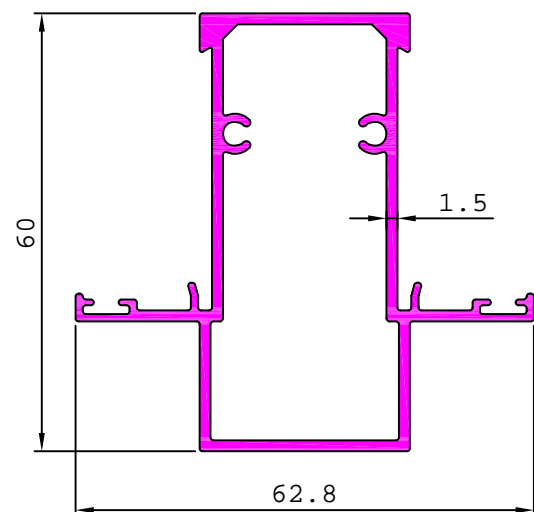

ARCHITECTURAL

DETAILS OF CASEMENT WINDOW SECTIONS

21324

0.573 kg/m

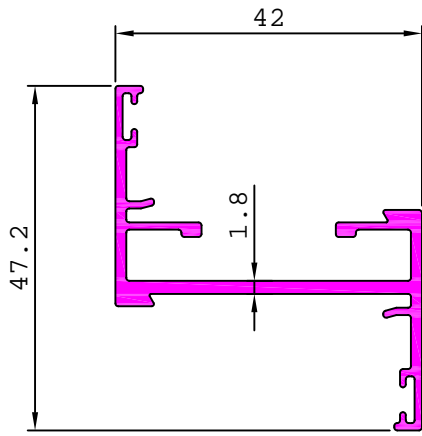

21352

0.946 kg/m

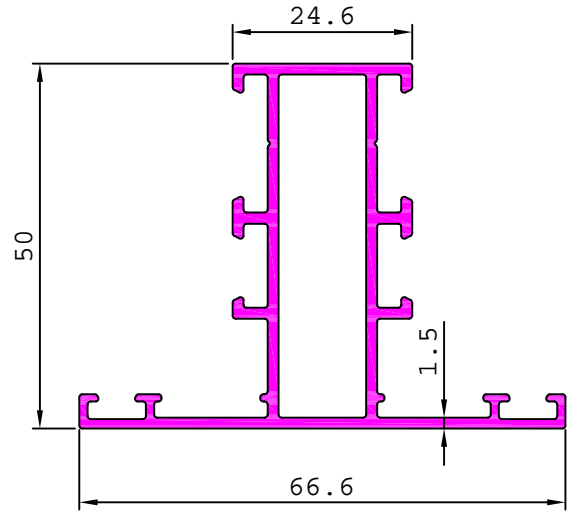

21353

0.940 kg/m

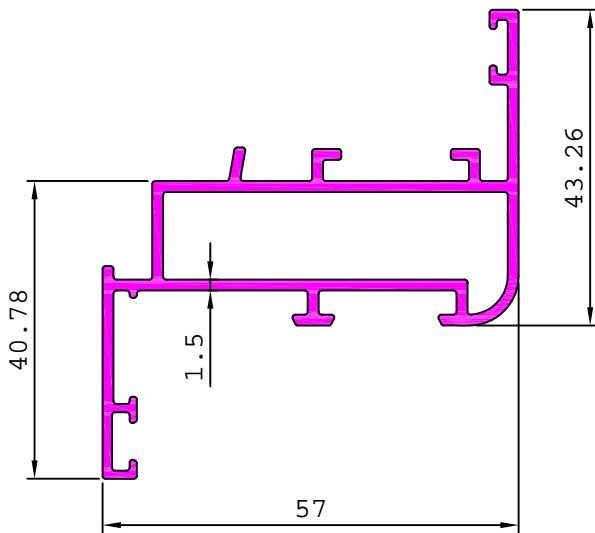

21336

0.841 kg/m

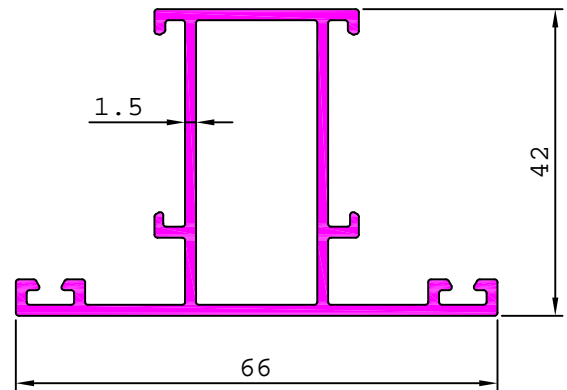

21337

0.712 kg/m

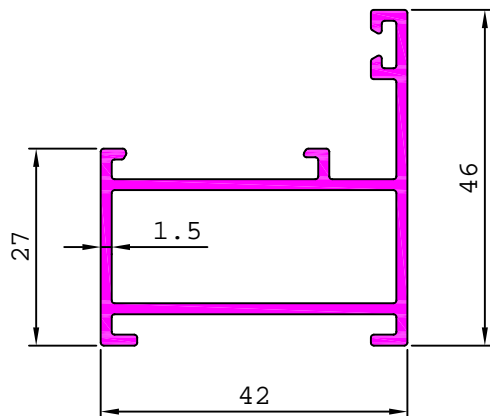

21400

1.023 kg/m

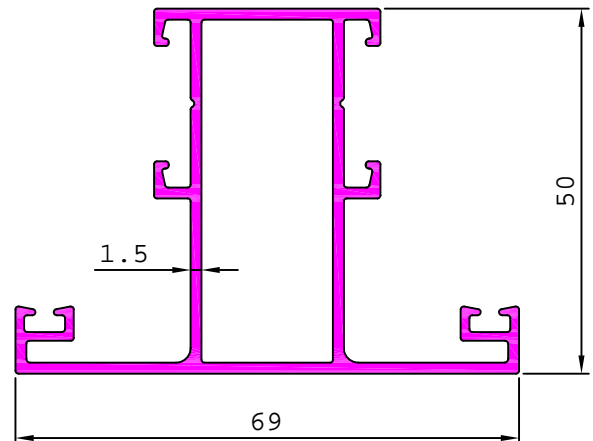

ARCHITECTURAL

DETAILS OF CASEMENT WINDOW SECTIONS

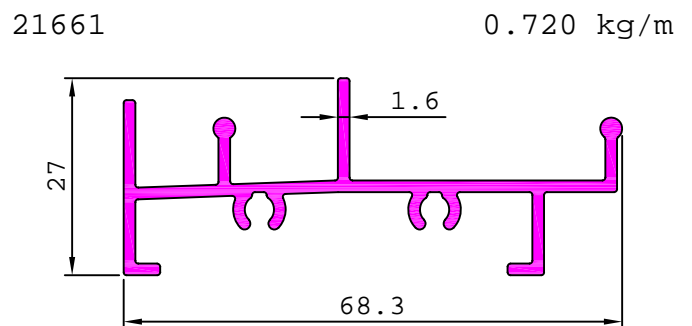
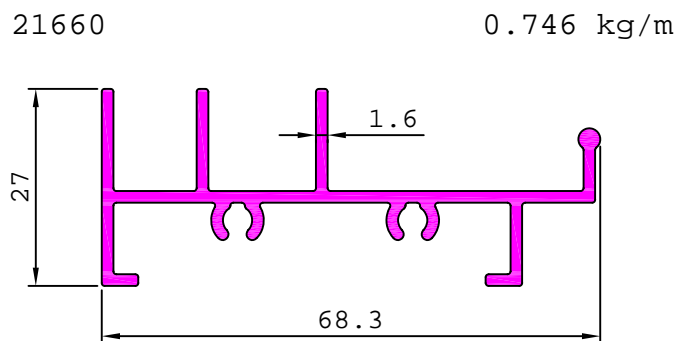
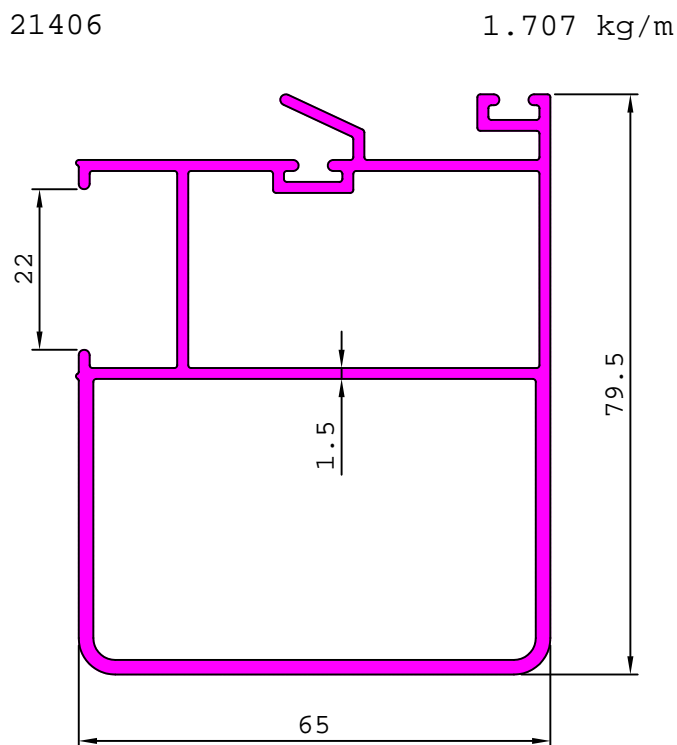
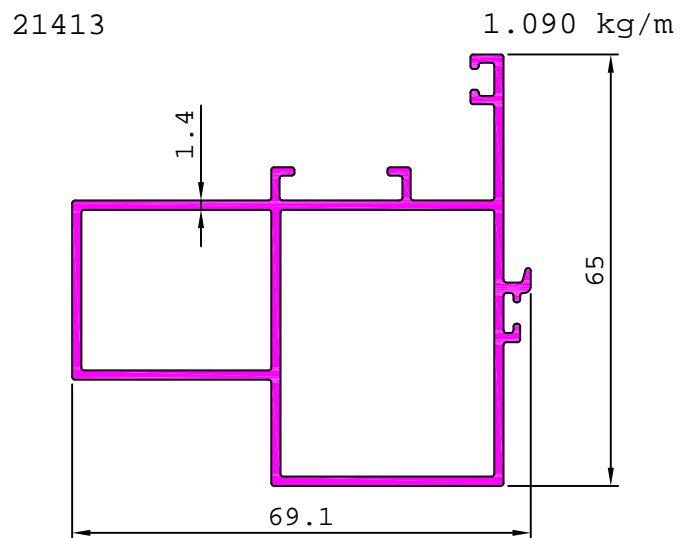
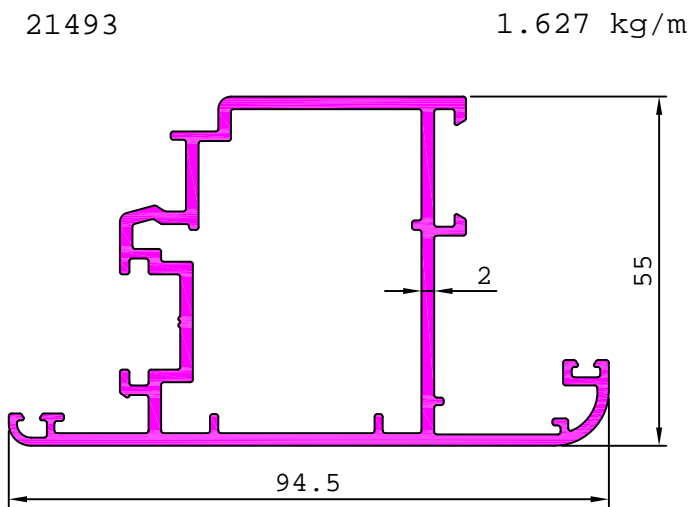
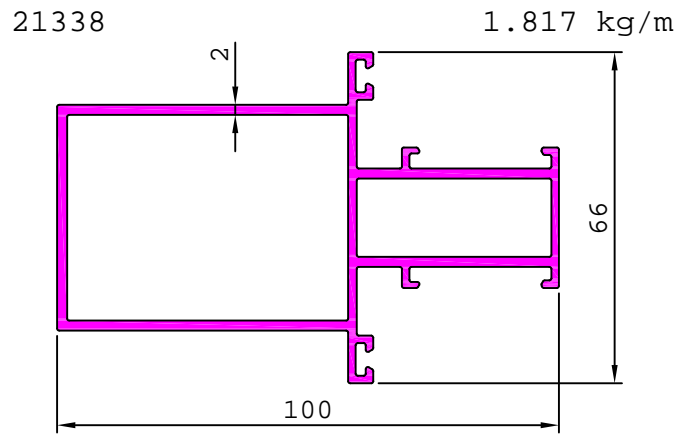
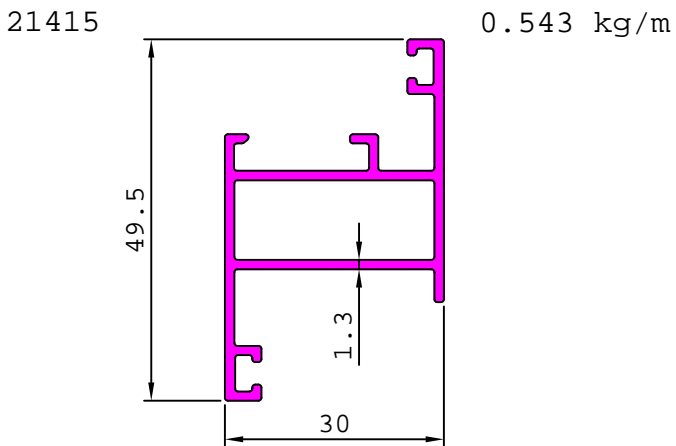

ARCHITECTURAL

DETAILS OF CASEMENT WINDOW SECTIONS

21656 0.452 kg/m

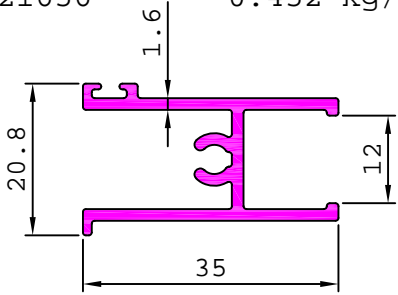

21657 0.185 kg/m

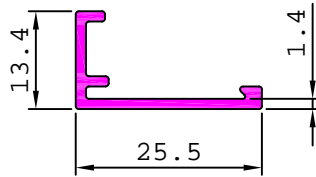

21663 0.543 kg/m

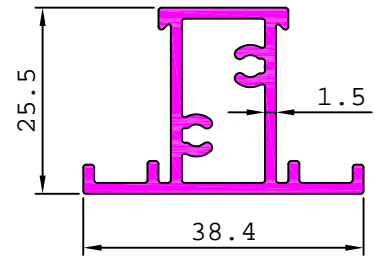

21662 0.991 kg/m

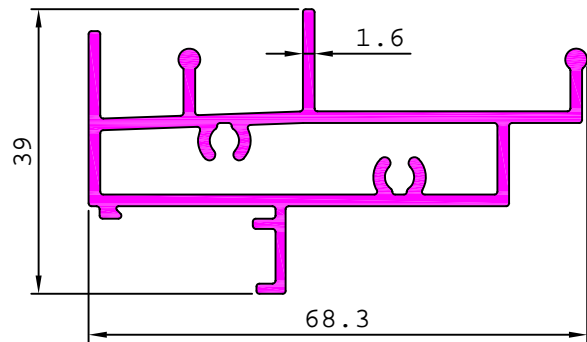

21659 0.470 kg/m

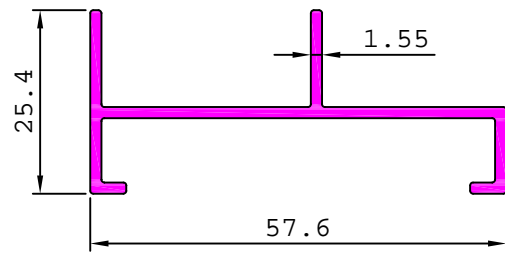

21665 0.758 kg/m

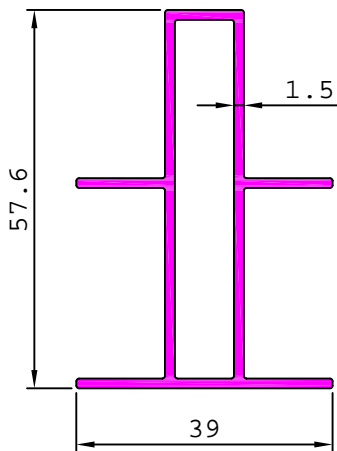

21666 0.653 kg/m

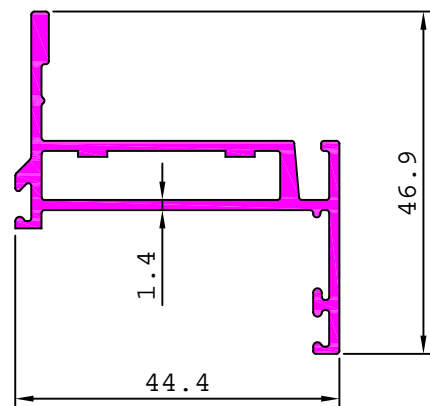

21667 0.569 kg/m

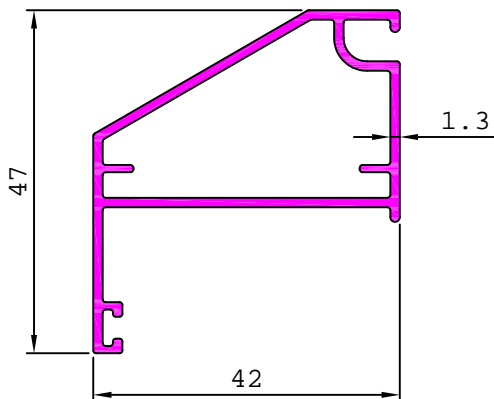

21577 0.776 kg/m

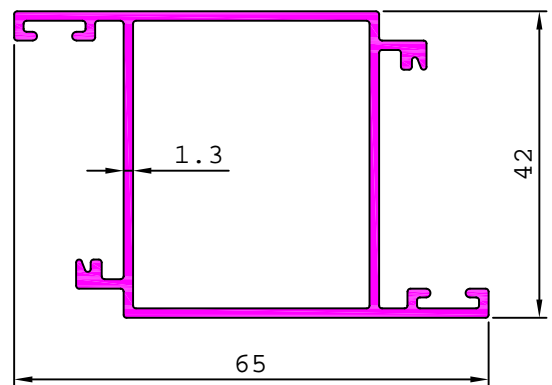

ARCHITECTURAL

DETAILS OF CASEMENT WINDOW SECTIONS

21579

0.709 kg/m

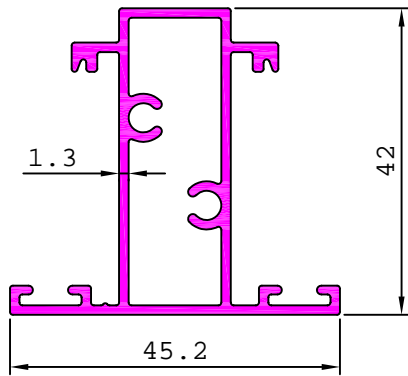

21536

0.453 kg/m

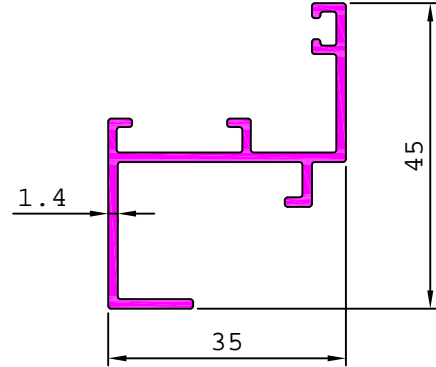

21537

0.725 kg/m

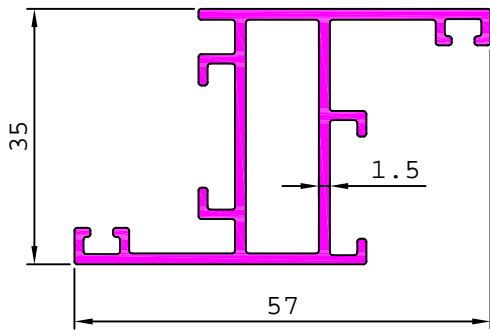

21560

0.921 kg/m

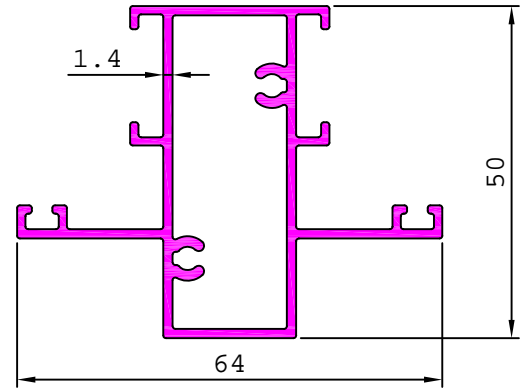

21538

0.945 kg/m

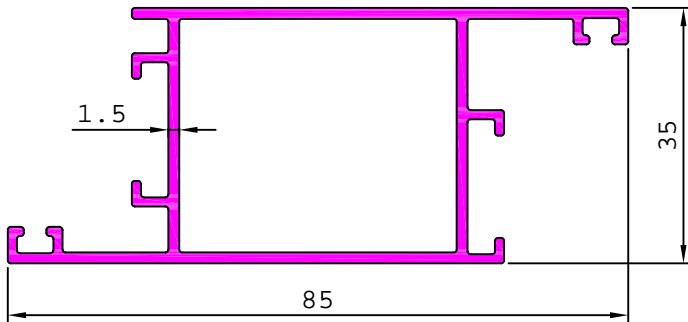

21541

0.768 kg/m

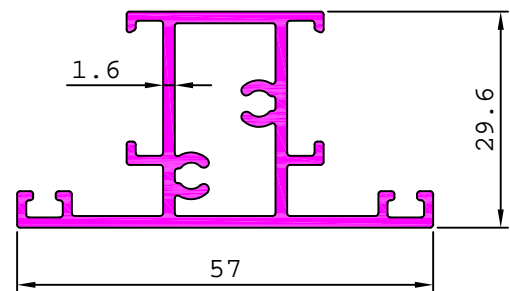

21523

0.656 kg/m

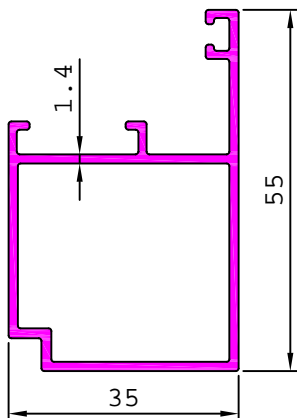

21530

0.606 kg/m

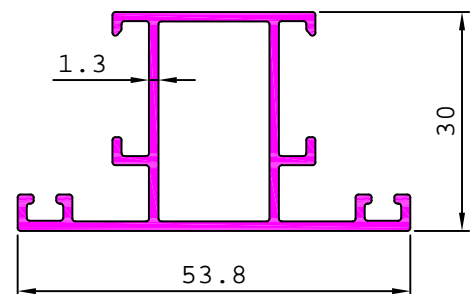

ARCHITECTURAL

DETAILS OF CASEMENT WINDOW SECTIONS

21524

0.923 kg/m

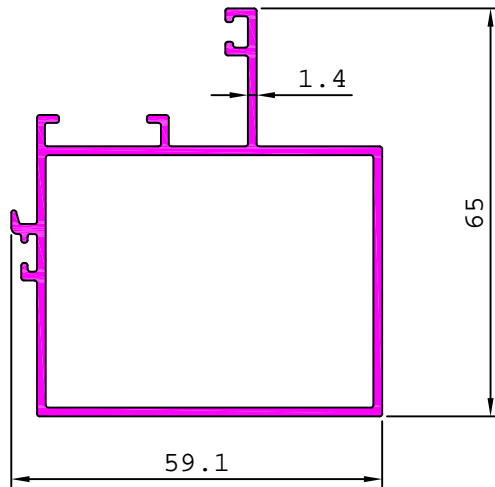

21544

1.090 kg/m

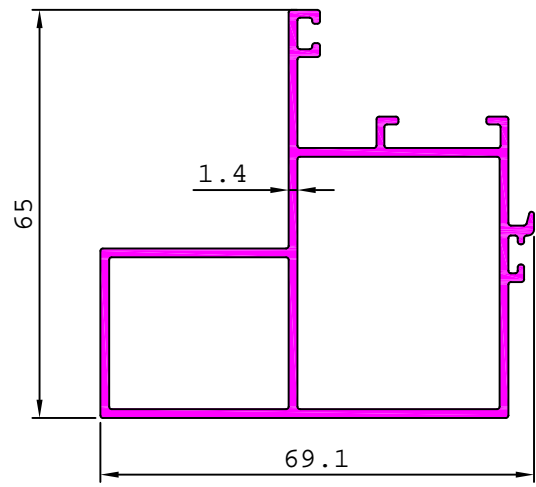

21690

1.015 kg/m

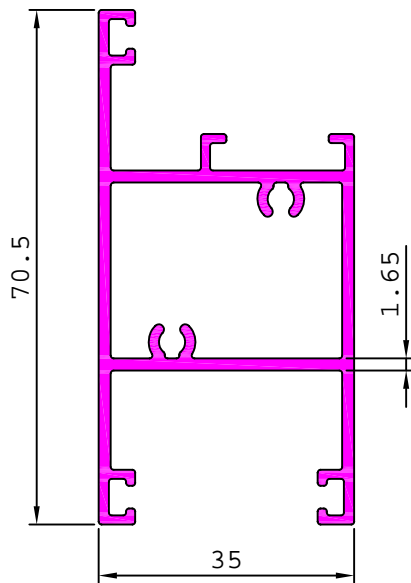

21561

1.111 kg/m

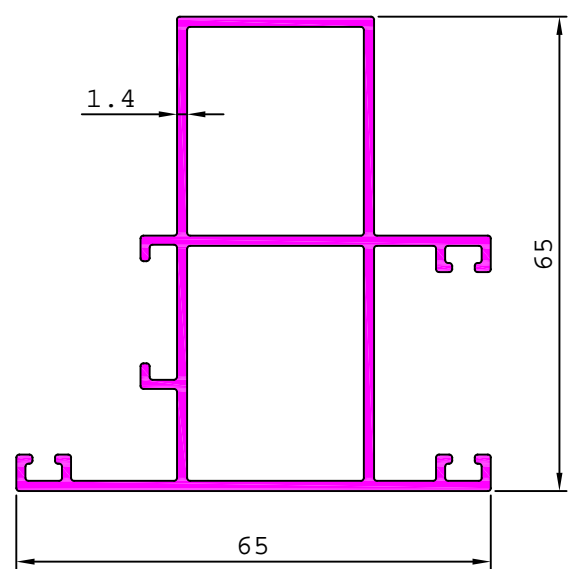

21547

0.839 kg/m

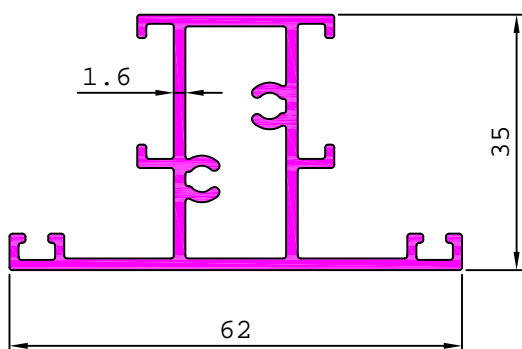

21549

0.620 kg/m

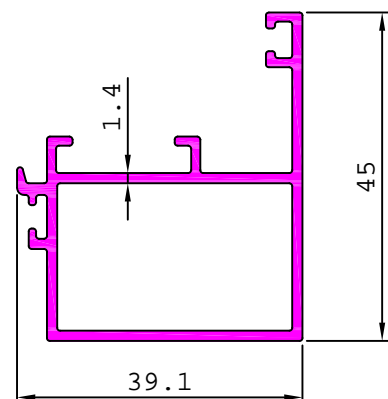

ARCHITECTURAL

DETAILS OF CASEMENT WINDOW SECTIONS

21594 1.171 kg/m

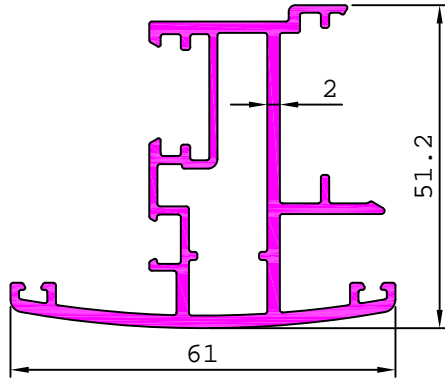

21573 0.936 kg/m

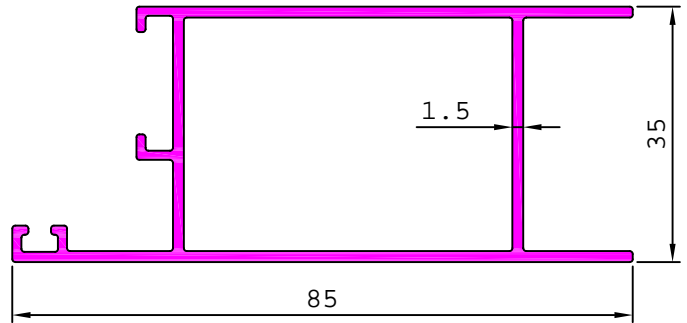

21567 0.768 kg/m

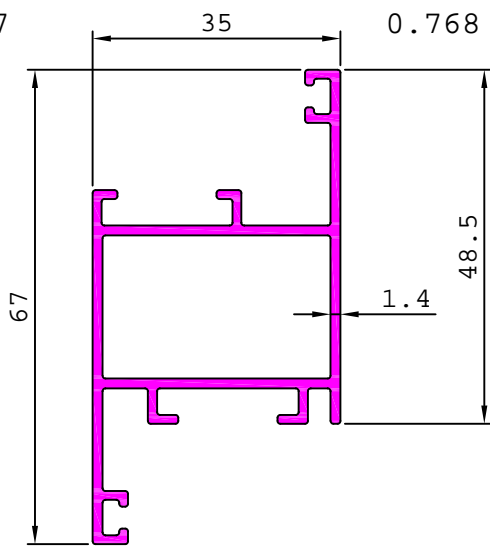

21551 1.101 kg/m

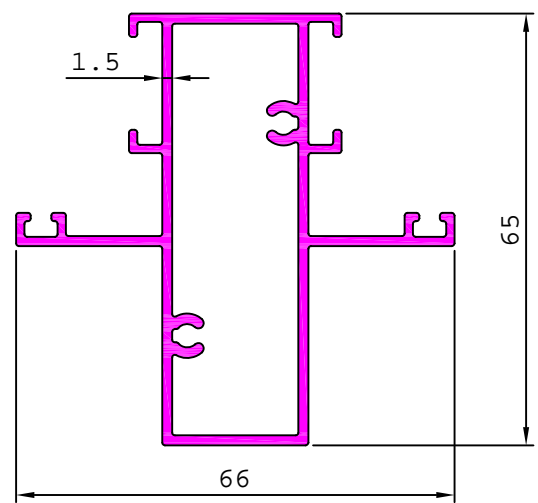

21600 0.329 kg/m

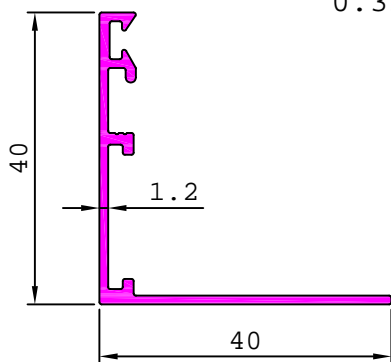

21601 0.637 kg/m

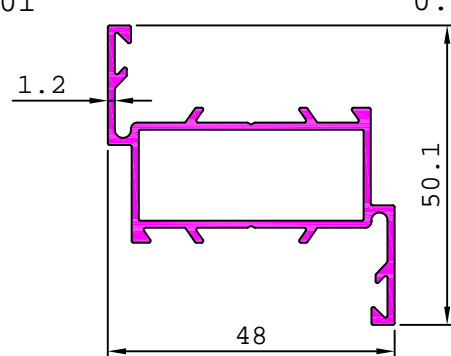

21602 0.751 kg/m

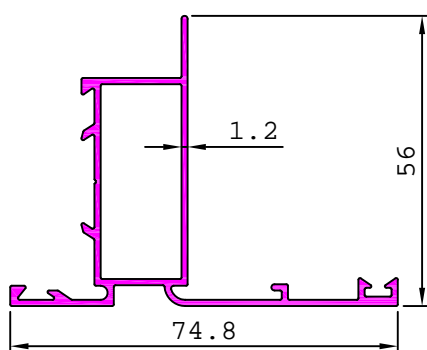

21593 0.751 kg/m

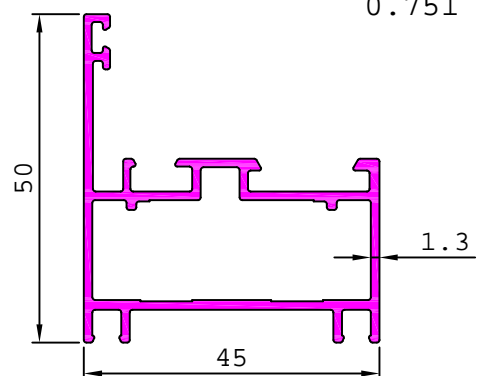

ARCHITECTURAL

DETAILS OF CASEMENT WINDOW SECTIONS

21693 0.784 kg/m

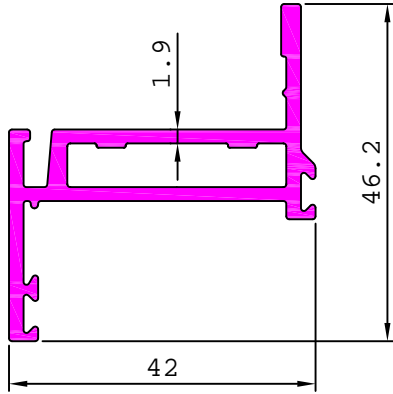

21694 1.026 kg/m

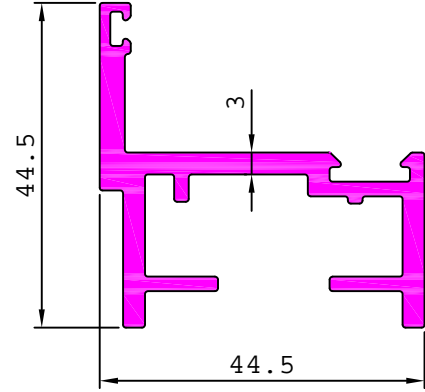

21695 1.297 kg/m

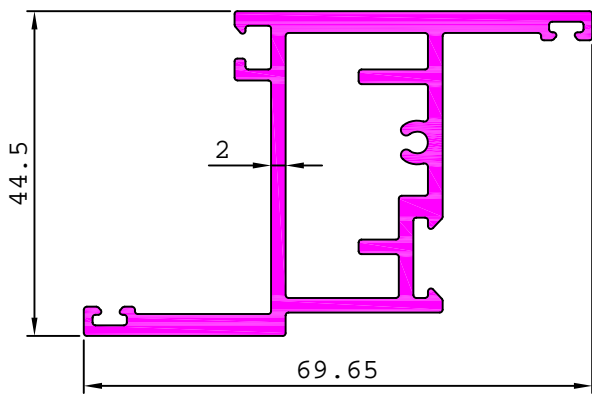

21696 1.448 kg/m

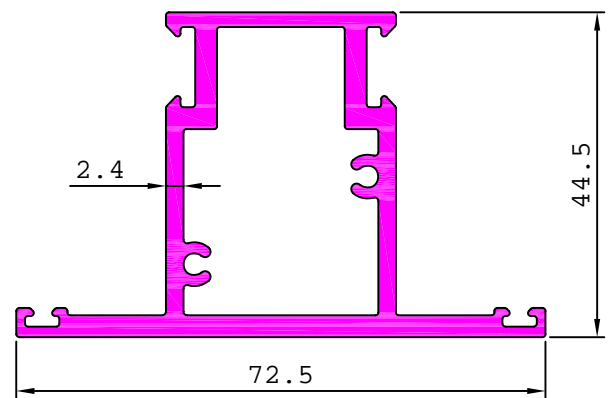

21699 0.697 kg/m

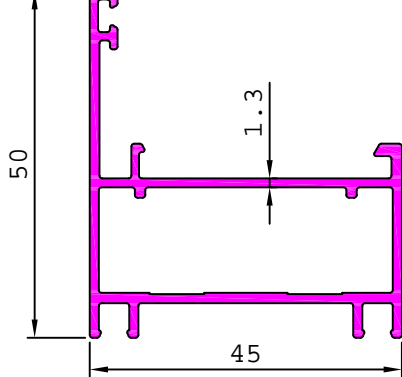

21700 1.276 kg/m

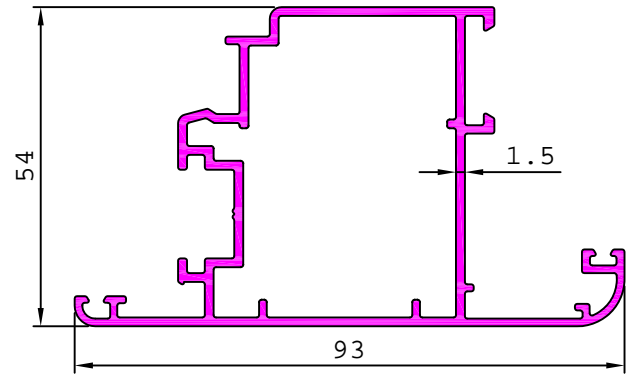

21701 0.913 kg/m

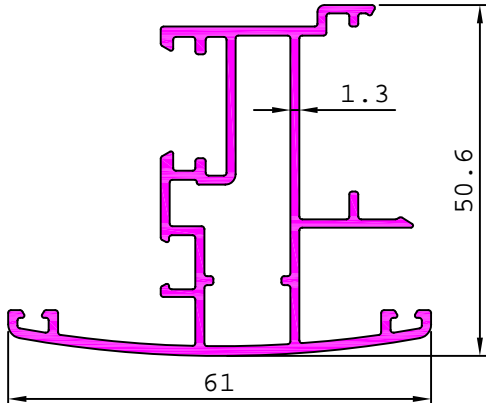

21655 0.526 kg/m

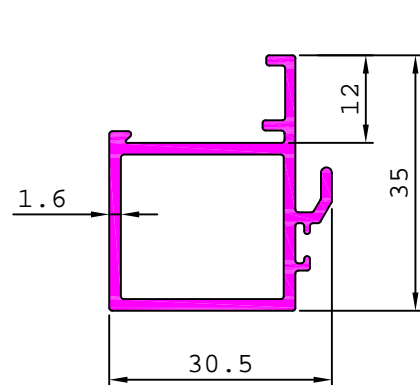

ARCHITECTURAL

DETAILS OF CASEMENT WINDOW SECTIONS

21511

1.131 kg/m

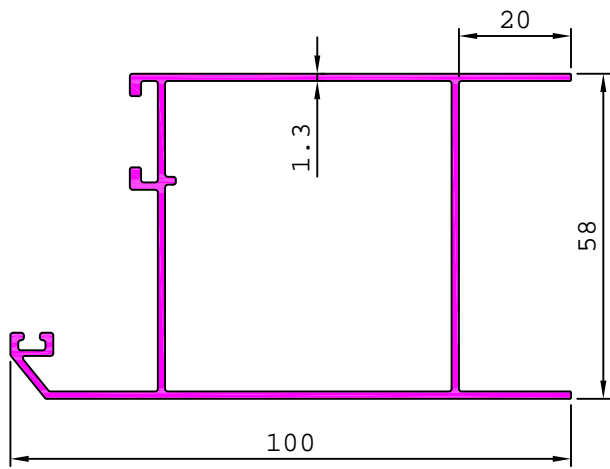

21512

1.039 kg/m

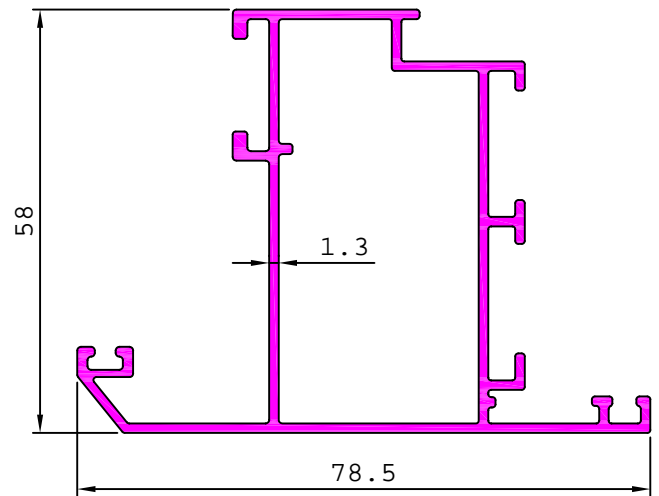

21634

0.956 kg/m

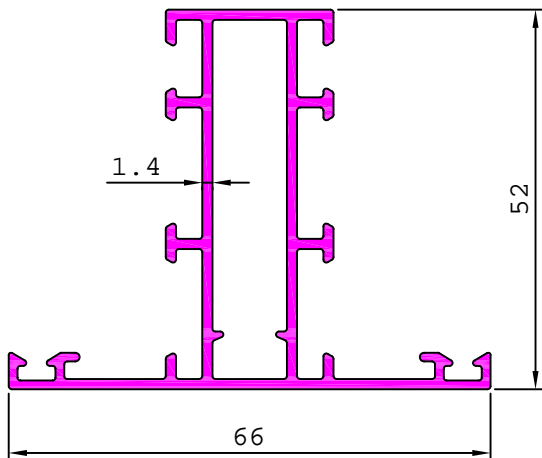

21635

0.842 kg/m

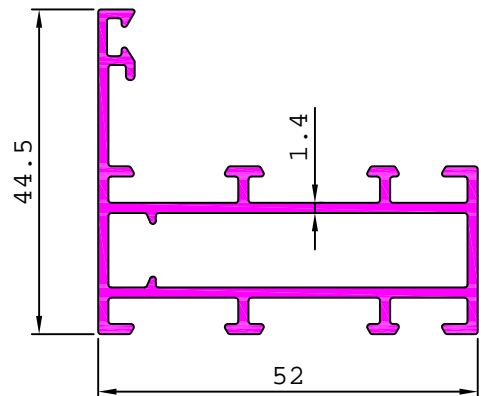

21636

0.956 kg/m

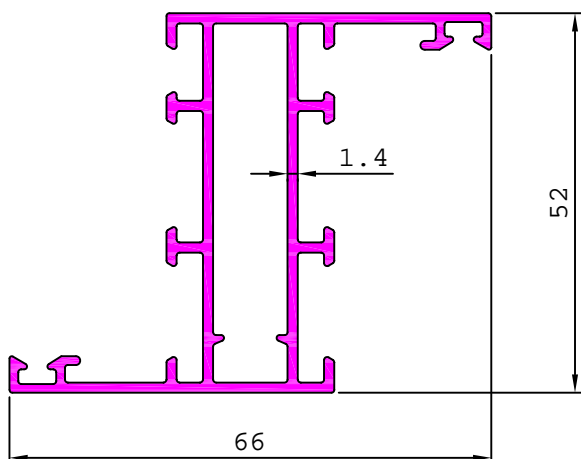

21586

1.104 kg/m

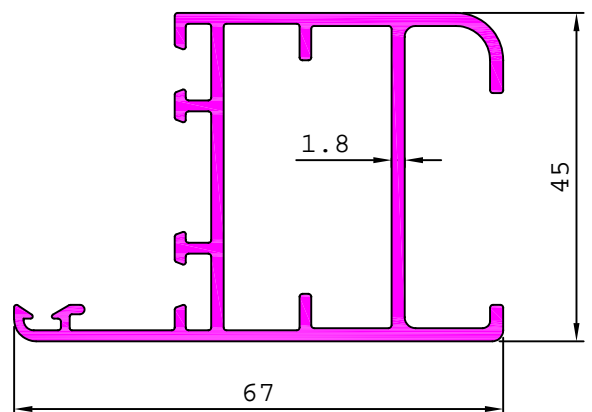

ARCHITECTURAL

DETAILS OF CASEMENT WINDOW SECTIONS

21613 0.920 kg/m

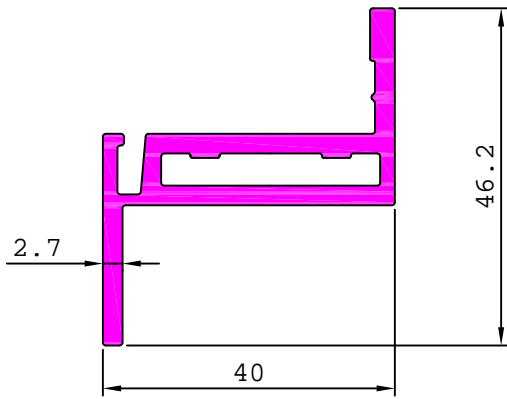

S4231 0.695 kg/m

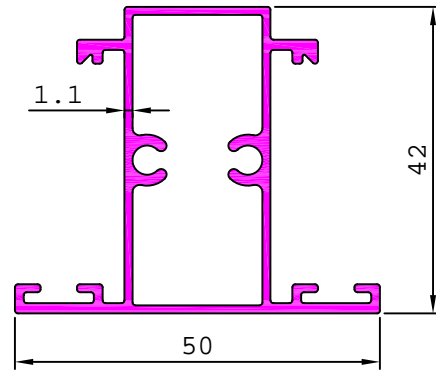

S4611 0.533 kg/m

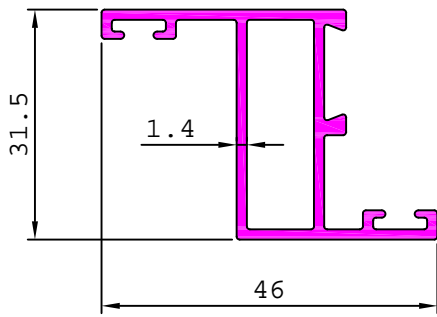

S4653 1.503 kg/m

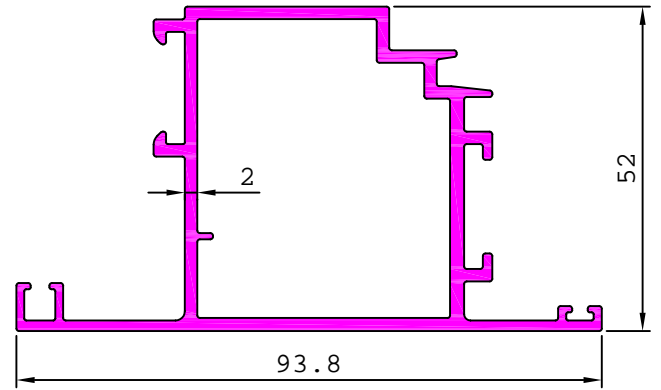

S4656 1.429 kg/m

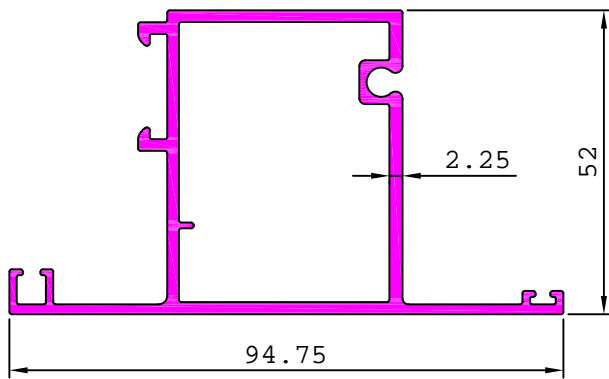

S4687 0.967 kg/m

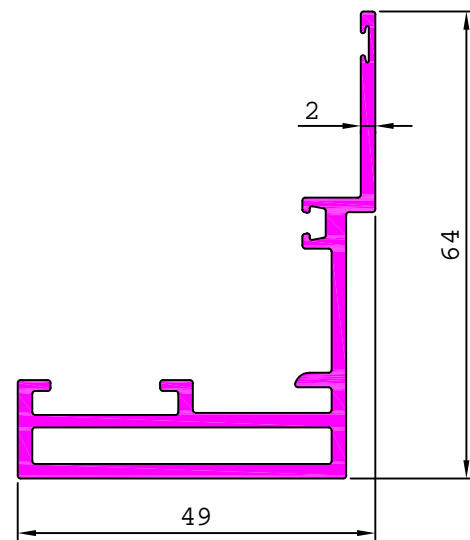

21704 0.524 kg/m

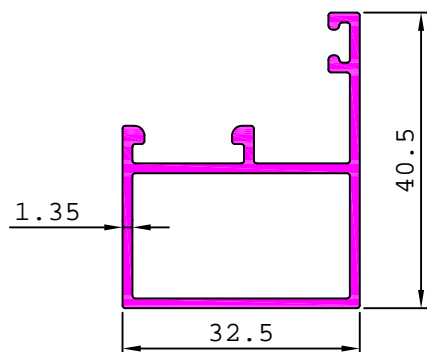

ARCHITECTURAL

DETAILS OF CASEMENT WINDOW SECTIONS

21721 1.532 kg/m

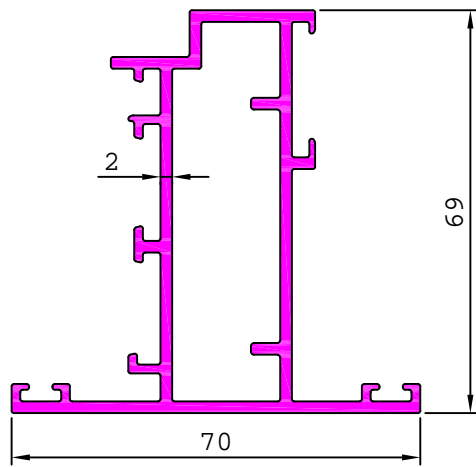

21722 1.501 kg/m

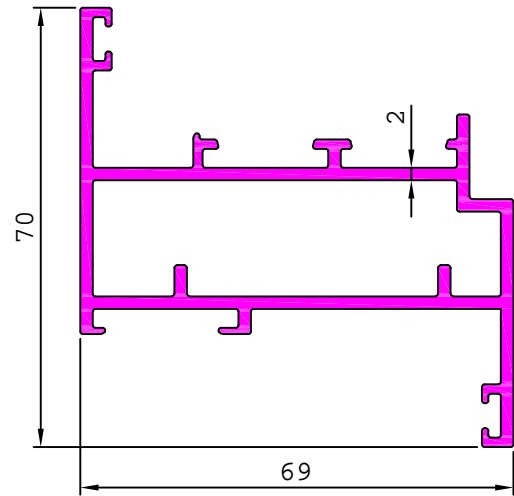

S5095 1.110 kg/m

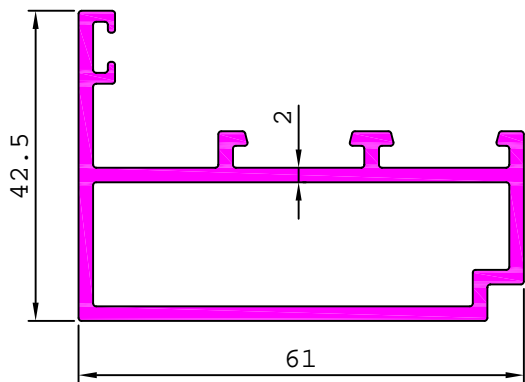

S5141 0.651 kg/m

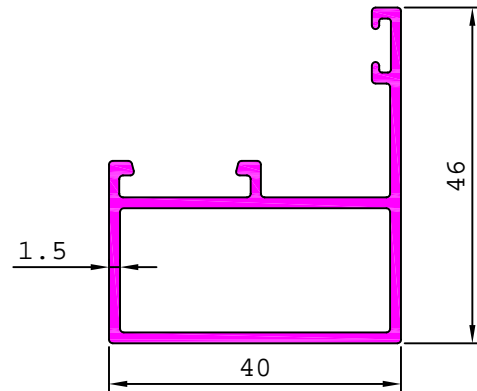

S5145 1.085 kg/m

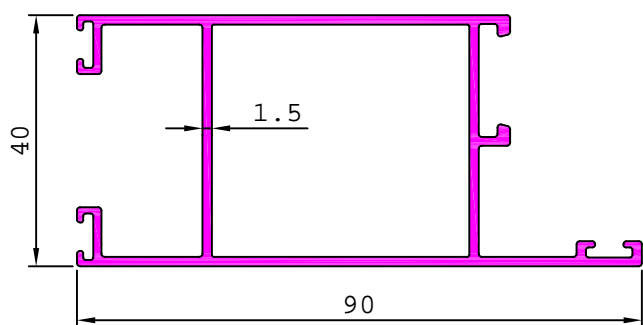

S5142 1.183 kg/m

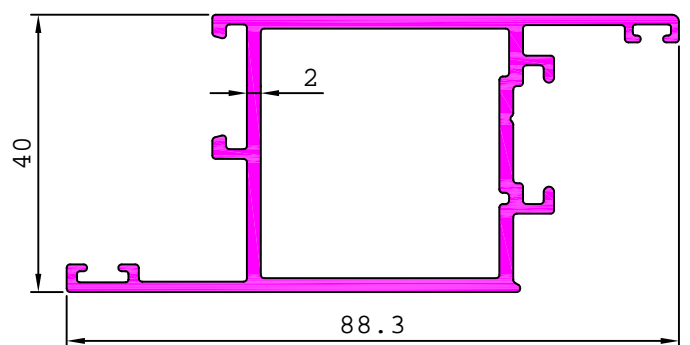

S5144 0.840 kg/m

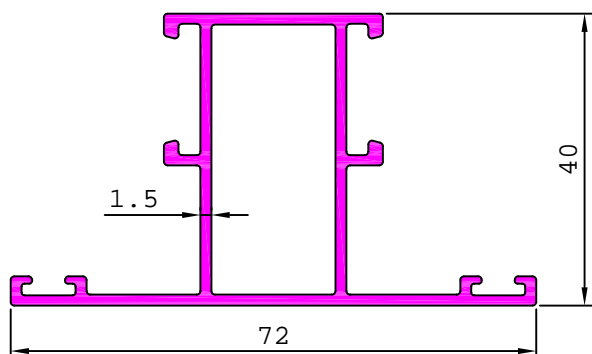

S5180 0.550 kg/m

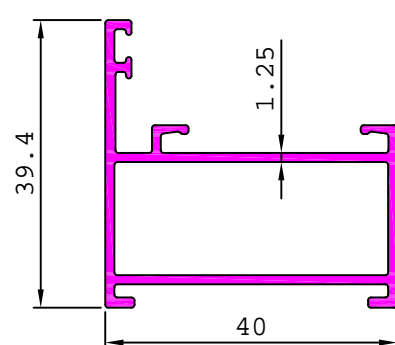

ARCHITECTURAL

DETAILS OF CASEMENT WINDOW SECTIONS

S5181

0.782 kg/m

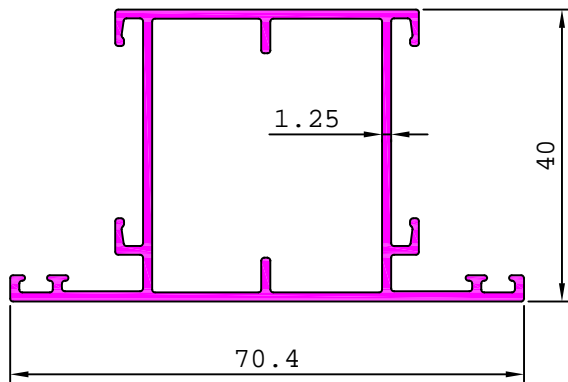

S5192

1.642 kg/m

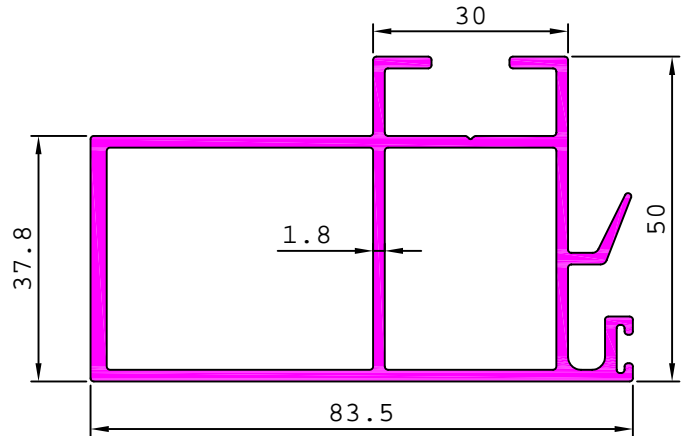

ARCHITECTURAL

DETAILS OF SLIDING WINDOW SECTIONS

SERIES - A 15 mm.

PART I - S/W 1/2"

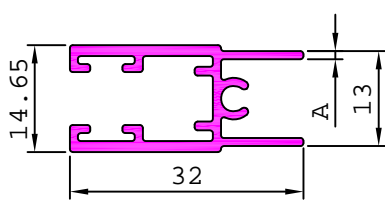

20946 0.238 kg/m

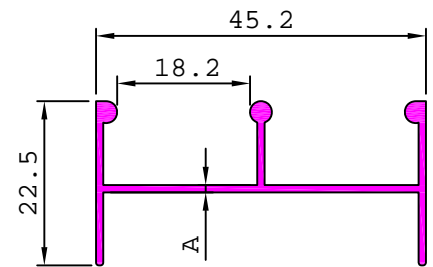
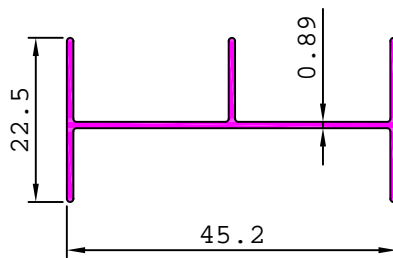

SL. No.	Section No.	A	Weight kg/m
1	20624	1.20	0.353
2	20961	1.00	0.304

SL. No.	Section No.	A	Weight kg/m
1	20969	0.80	0.233
2	20945	0.90	0.263
3	20581	1.10	0.344

20951 0.297 kg/m

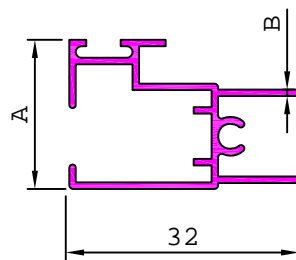
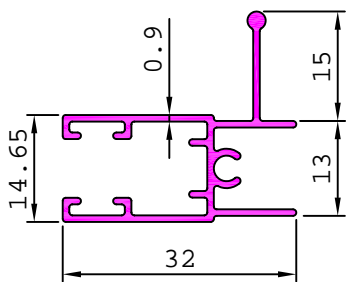

SL. No.	Section No.	A	B	Weight kg/m
1	20868	20.50	0.70	0.220
2	20947	20.75	0.82	0.257
3	20584	20.75	1.10	0.335

20718 0.263 kg/m

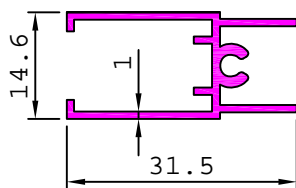

20626 0.567 kg/m

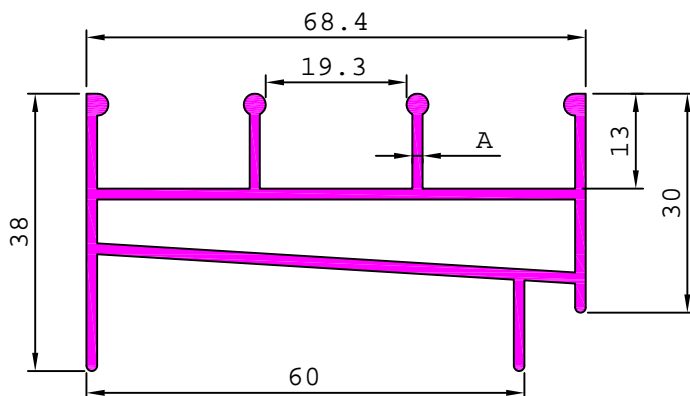
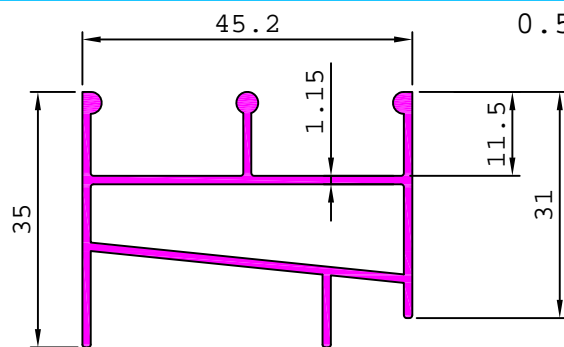

SL. No.	Section No.	A	Weight kg/m
1	20955	1.13	0.759
2	20618	1.50	0.980

ARCHITECTURAL

DETAILS OF SLIDING WINDOW SECTIONS

SERIES - A 15 mm.

PART I - S/W 1/2"

20616 0.546 kg/m

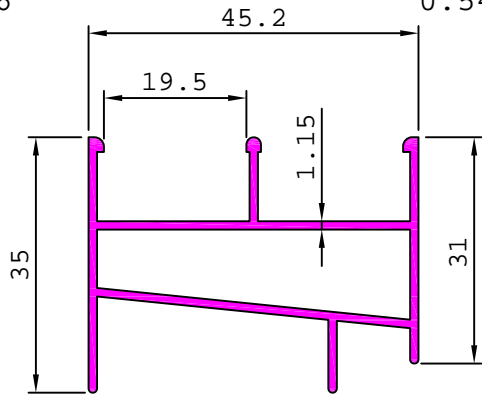

20625 0.488 kg/m

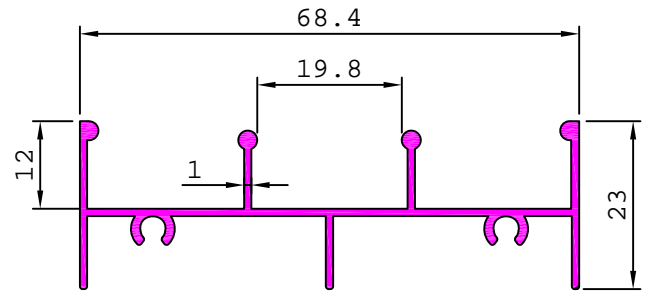

PART II - S/W 5/8"

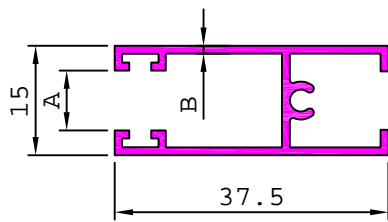

SL. No.	Section No.	A	B	Weight kg/m
1	20809	8.20	1.08	0.329
2	20597	7.80	1.60	0.485

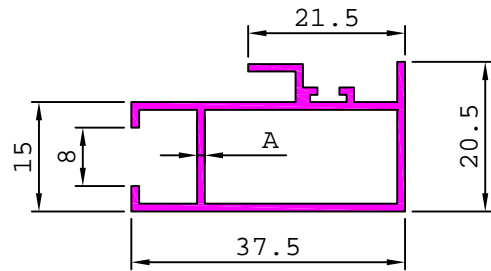

SL. No.	Section No.	A	Weight kg/m
1	20810	1.07	0.369
2	20655	1.50	0.487

20671 0.699 kg/m

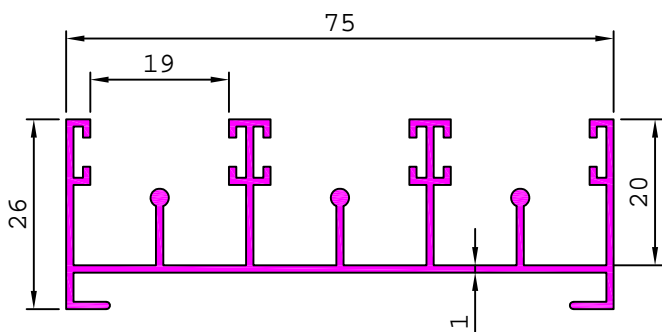

20672 0.594 kg/m

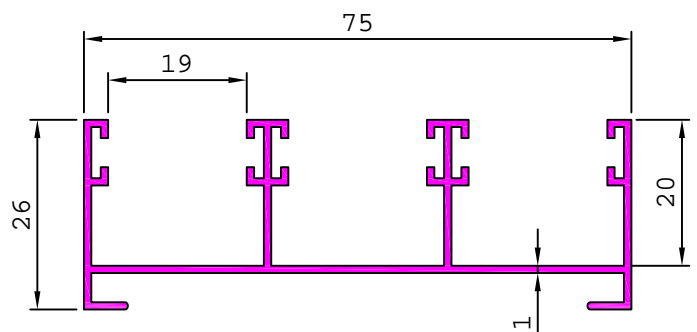

20690 0.366 kg/m

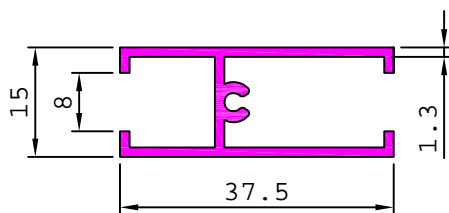

20688 0.371 kg/m

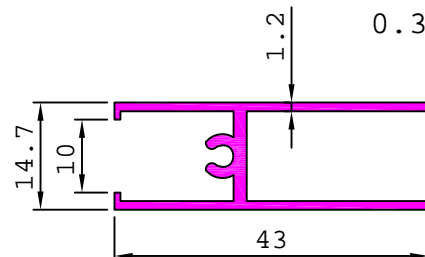

ARCHITECTURAL

DETAILS OF SLIDING WINDOW SECTIONS

SERIES - A 15 mm.

PART II - S/W 5/8"

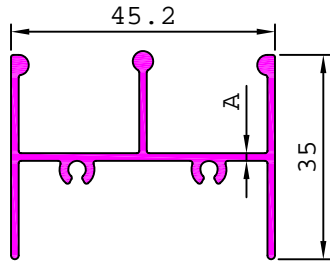

SL. No.	Section No.	A	Weight kg/m
1	20808	0.98	0.414
2	20664	1.30	0.562

20668

0.377 kg/m

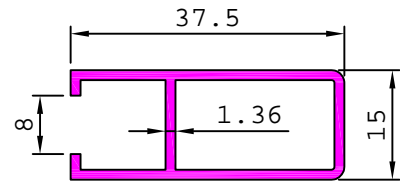

20669 0.548 kg/m

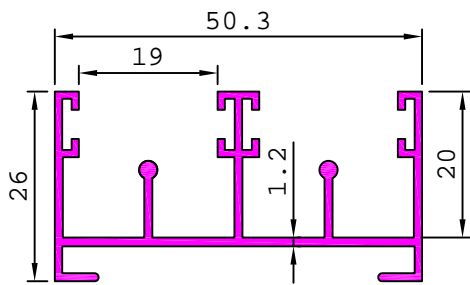

20670 0.432 kg/m

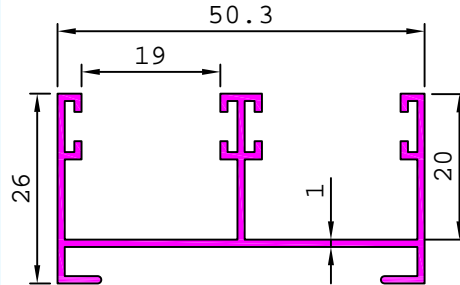

20689 0.481 kg/m

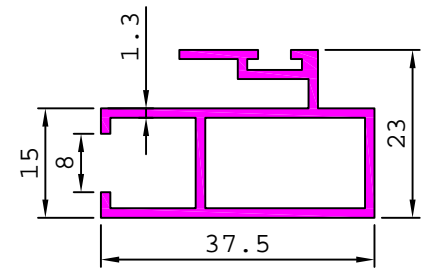

PART III - S/W 1/2"

20735 0.793 kg/m

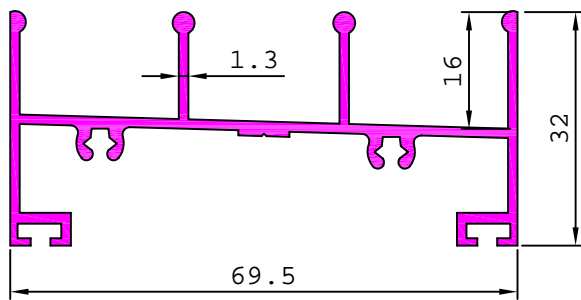

20960 0.333 kg/m

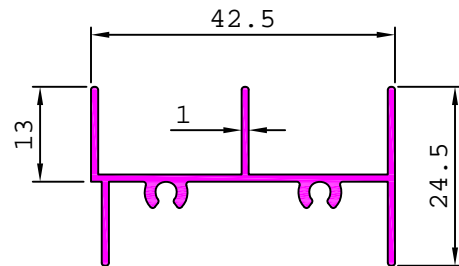

20886 0.411 kg/m

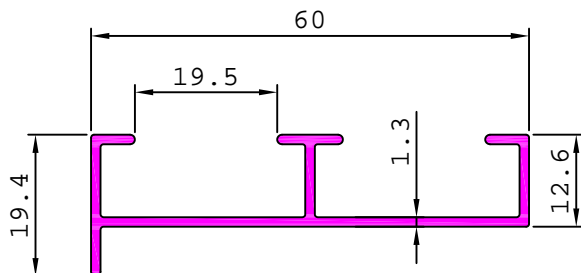

ARCHITECTURAL

DETAILS OF SLIDING WINDOW SECTIONS SERIES - B (SHUTTER SECTION - 18 mm.)

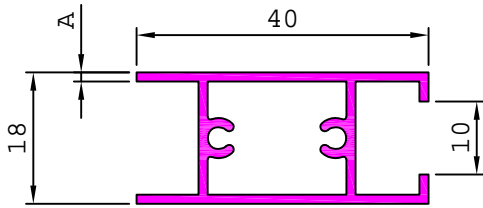

SL. No.	Section No.	A	Weight kg/m
1	20545	0.79	0.288
2	20805	0.91	0.325
3	20604	1.09	0.390
4	21585	1.19	0.418
5	20844	1.29	0.456
6	21448	1.42	0.494
7	20736	1.55	0.547

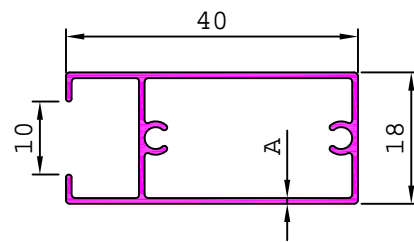

SL. No.	Section No.	A	Weight kg/m
1	20547	0.79	0.289
2	20807	0.91	0.325
3	20606	1.09	0.390
4	21455	1.19	0.418
5	20846	1.29	0.456
6	21449	1.42	0.494
7	20738	1.55	0.547

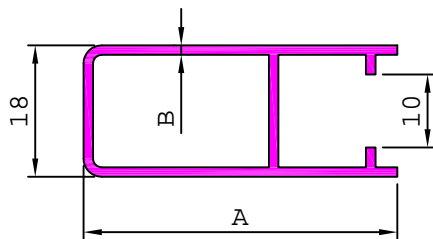

SL. No.	Section No.	A	B	Weight kg/m
1	20687	43.00	1.30	0.424
2	20887	52.00	1.48	0.548

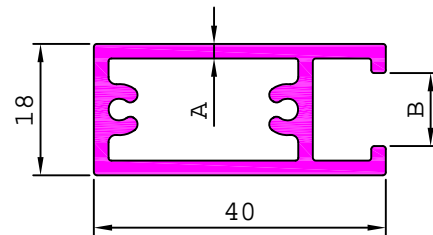

SL. No.	Section No.	A	B	Weight kg/m
1	21545	1.95	10.50	0.677
2	21515	2.00	10.00	0.696

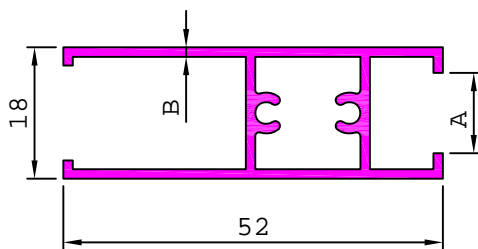

SL. No.	Section No.	A	B	Weight kg/m
1	20811	11.00	0.91	0.390
2	20963	11.00	1.13	0.488
3	20847	10.00	1.29	0.547
4	20652	11.00	1.30	0.547
4	20750	10.00	1.56	0.651

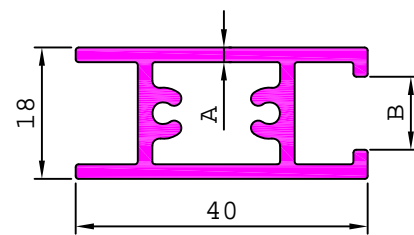

SL. No.	Section No.	A	B	Weight kg/m
1	21575	1.95	10.50	0.677
2	21513	2.00	10.00	0.695

20567

0.601 kg/m

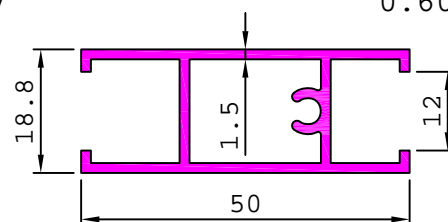

ARCHITECTURAL

DETAILS OF SLIDING WINDOW SECTIONS SERIES - B (SHUTTER SECTION - 18 mm.)

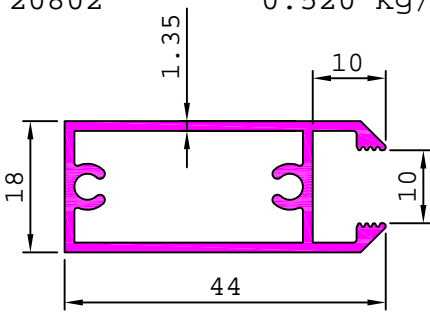
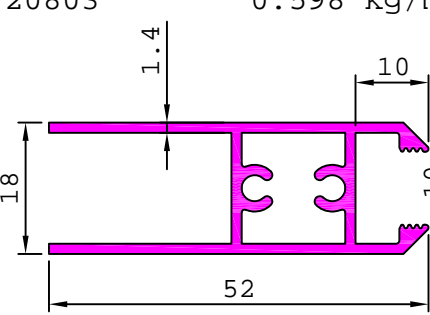
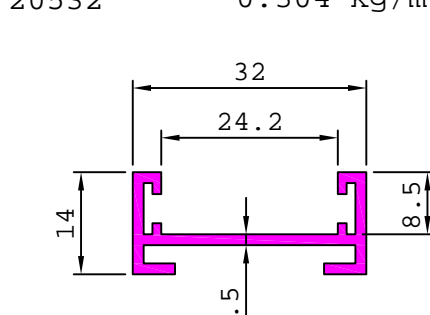
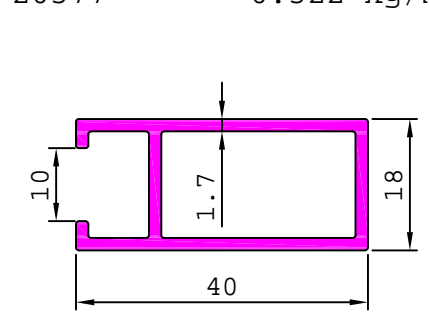
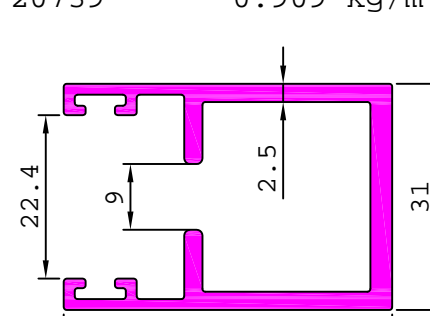
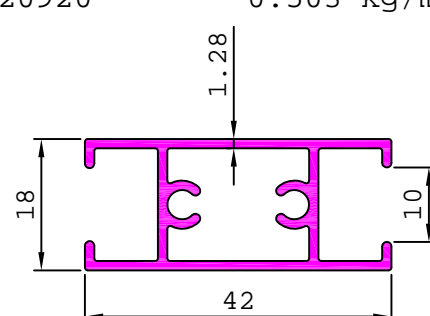
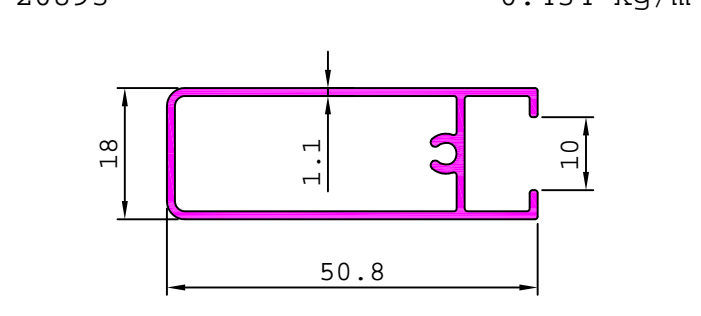
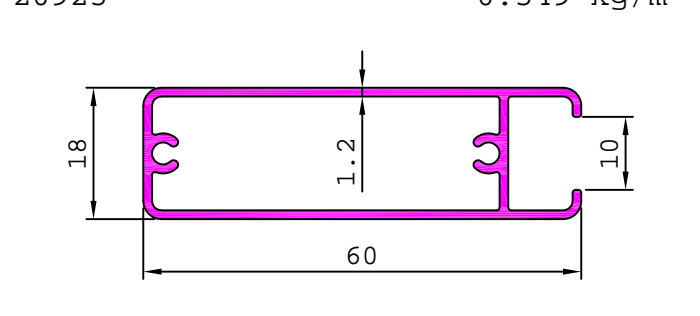
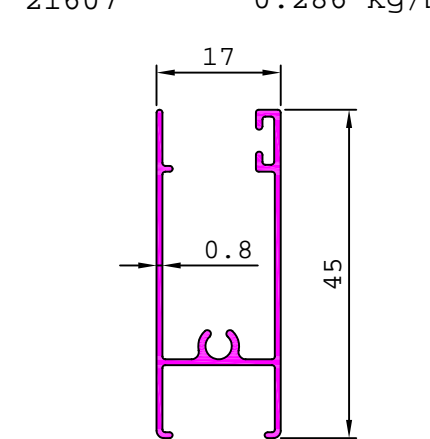
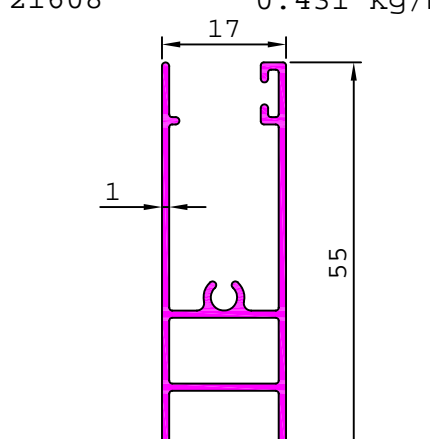
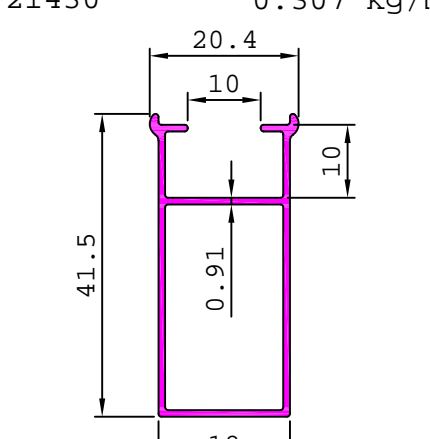
<p>20802 0.520 kg/m</p> 	<p>20803 0.598 kg/m</p> 	<p>20532 0.304 kg/m</p> 
<p>20577 0.522 kg/m</p> 	<p>20739 0.909 kg/m</p> 	<p>20920 0.503 kg/m</p> 
<p>20893 0.434 kg/m</p> 	<p>20925 0.549 kg/m</p> 	
<p>21607 0.286 kg/m</p> 	<p>21608 0.431 kg/m</p> 	<p>21430 0.307 kg/m</p> 

ARCHITECTURAL

DETAILS OF SLIDING WINDOW SECTIONS SERIES - B (SHUTTER SECTION - 18 mm.)

20926

0.641 kg/m

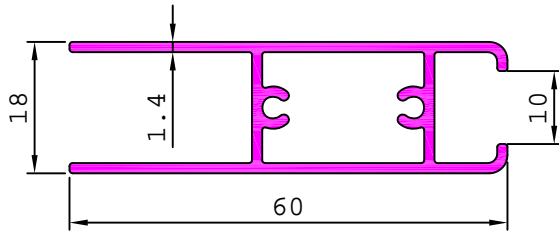

20876

0.471 kg/m

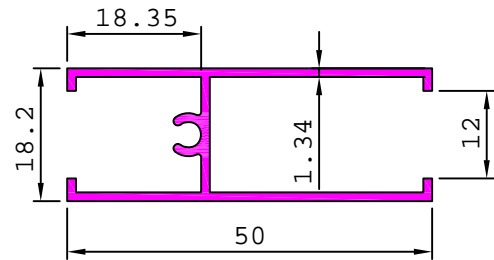

S4535

0.519 kg/m

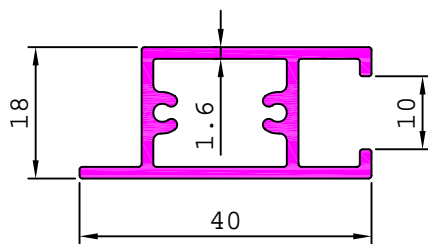

21649

0.828 kg/m

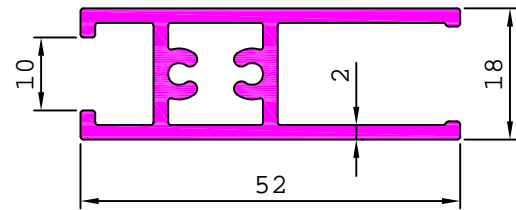

ARCHITECTURAL

DETAILS OF SLIDING WINDOW SECTIONS SERIES - B (SHUTTER SECTION - 18 mm.)

20804 0.626 kg/m

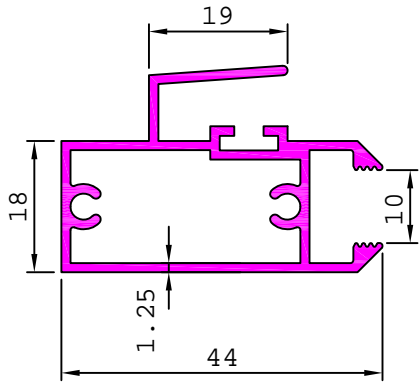

20892 0.527 kg/m

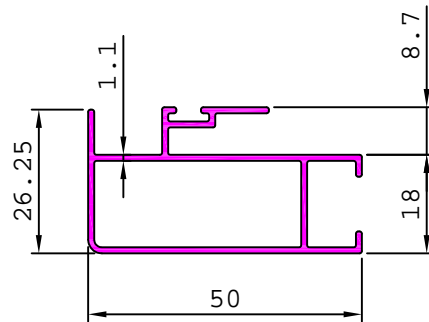

20576 0.663 kg/m

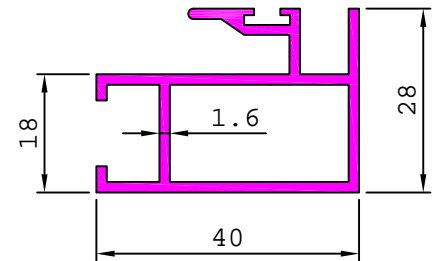

20924 0.683 kg/m

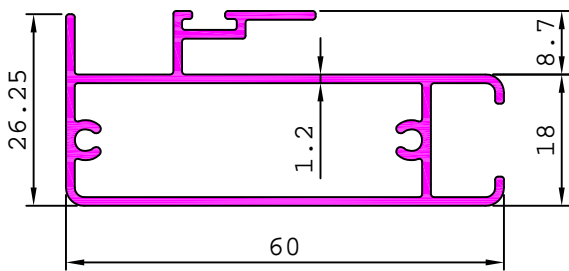

21303 0.586 kg/m

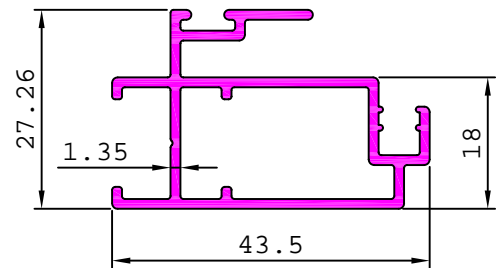

21302 0.457 kg/m

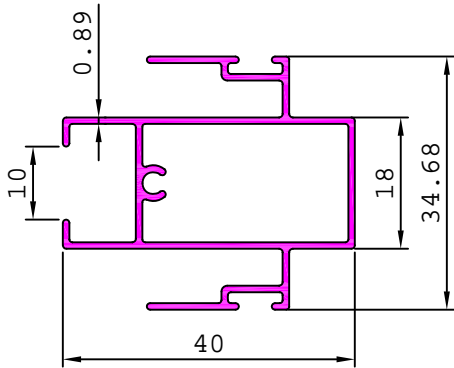

20686 0.558 kg/m

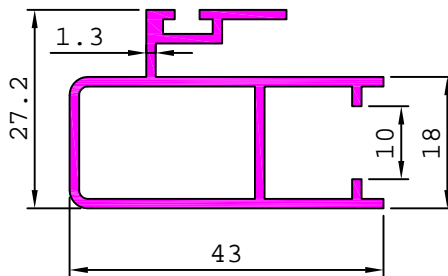

21429 0.378 kg/m

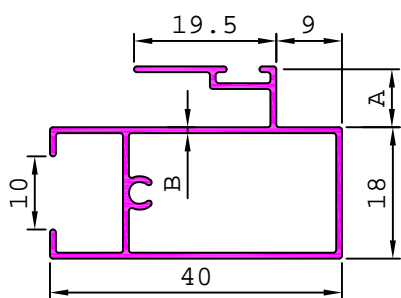
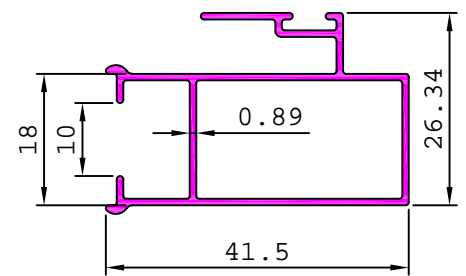

SL. No.	Section No.	A	B	Weight kg/m
1	20546	8.34	0.80	0.346
2	20806	9.00	0.89	0.380
3	20605	8.70	1.00	0.440
4	21454	9.00	1.19	0.507
5	20845	9.00	1.29	0.547
6	20737	9.00	1.45	0.607

21494 0.426 kg/m

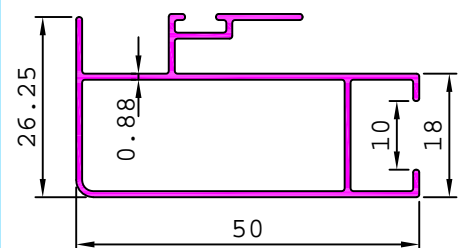

ARCHITECTURAL

DETAILS OF SLIDING WINDOW SECTIONS SERIES - B (SHUTTER SECTION - 18 mm.)

21514

0.817 kg/m

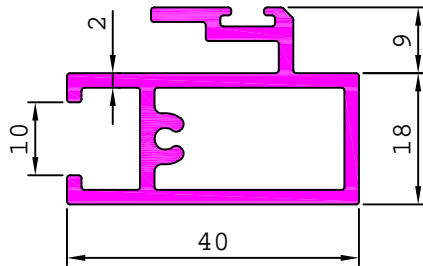

21552

0.798 kg/m

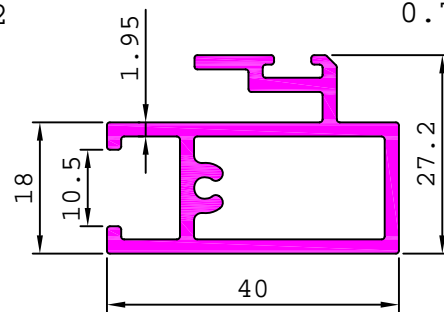

ARCHITECTURAL

DETAILS OF SLIDING WINDOW SECTIONS SERIES - B (SHUTTER SECTION - 18 mm.)

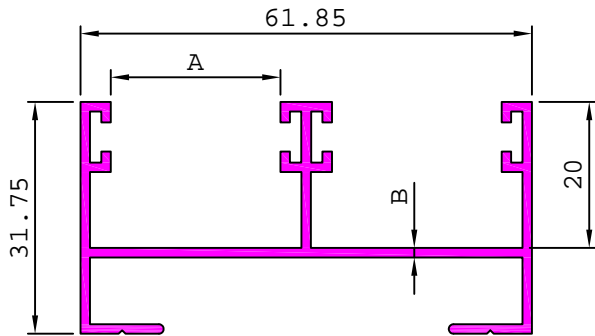

SL. No.	Section No.	A	B	Weight kg/m
1	20812	23.95	0.81	0.441
2	20966	23.85	1.00	0.547
3	20681	23.25	1.30	0.659
4	20829	22.70	1.50	0.784

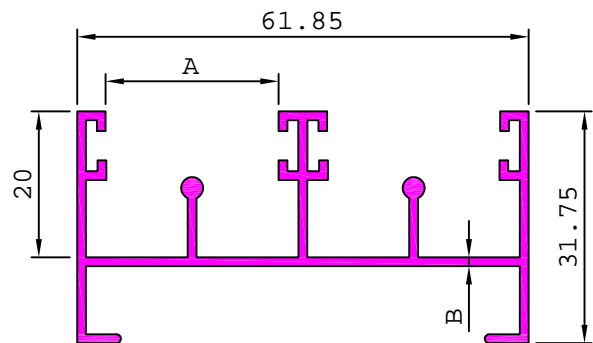

SL. No.	Section No.	A	B	Weight kg/m
1	20813	23.95	0.85	0.547
2	20956	23.85	1.05	0.613
3	20619	23.70	1.20	0.695
4	20830	22.70	1.50	0.909

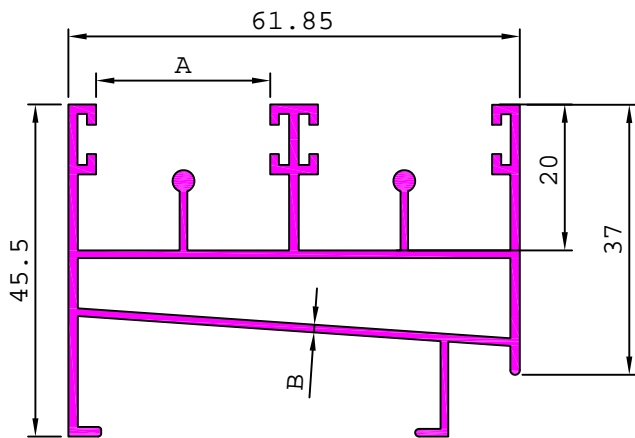

SL. No.	Section No.	A	B	Weight kg/m
1	20965	23.85	1.05	0.882
2	20657	23.45	1.30	1.055

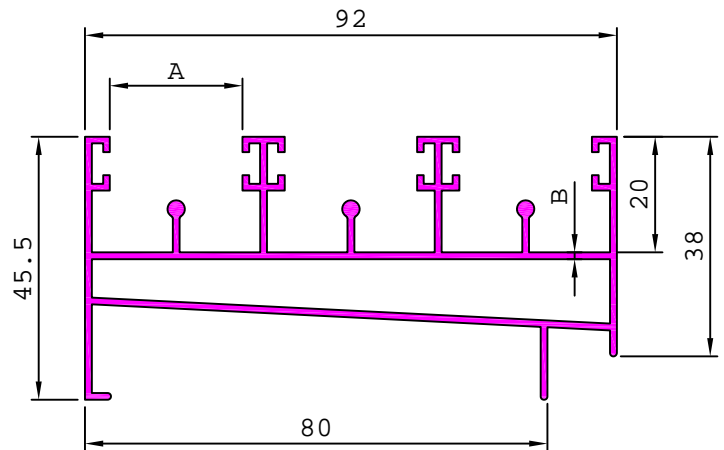

SL. No.	Section No.	A	B	Weight kg/m
1	20814	22.95	1.18	1.302
2	21031	22.95	1.30	1.441
3	20617	22.70	1.50	1.659

ARCHITECTURAL

DETAILS OF SLIDING WINDOW SECTIONS SERIES - B (SHUTTER SECTION - 18 mm.)

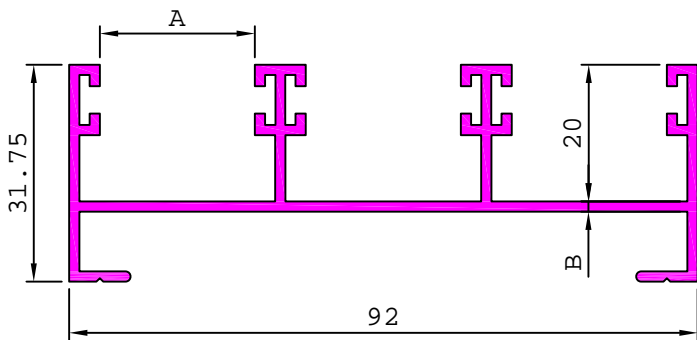

SL. No.	Section No.	A	B	Weight kg/m
1	20816	23.60	0.95	0.683
2	20958	23.60	1.05	0.759
3	21447	23.60	1.20	0.856
4	20621	23.30	1.30	0.929
5	20831	22.70	1.50	1.060

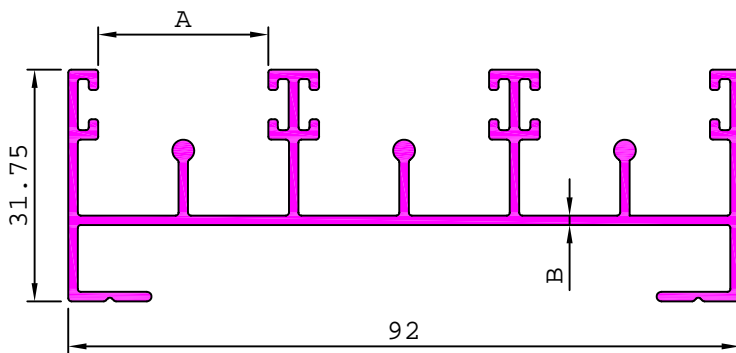

SL. No.	Section No.	A	B	Weight kg/m
1	20815	23.60	0.88	0.739
2	20957	23.60	1.10	0.911
3	21446	23.60	1.20	0.986
4	20620	23.30	1.30	1.065
5	20832	22.70	1.50	1.248

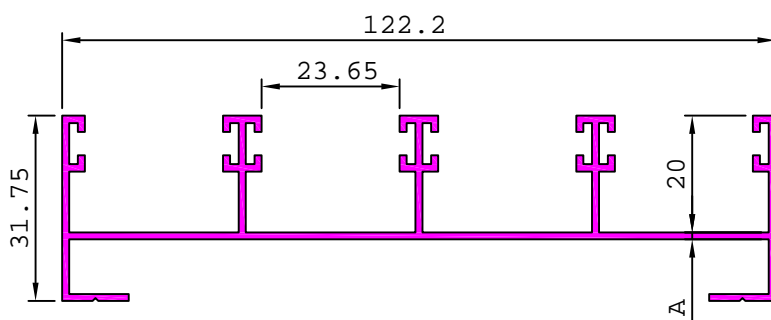

SL. No.	Section No.	A	Weight kg/m
1	20817	1.10	0.976
2	20666	1.20	1.093

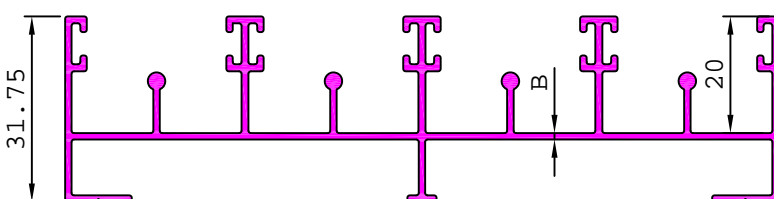

SL. No.	Section No.	A	B	Weight kg/m
1	20818	23.90	1.00	1.093
2	20706	23.90	1.10	1.205
3	20834	22.70	1.50	1.648

ARCHITECTURAL

DETAILS OF SLIDING WINDOW SECTIONS SERIES - B (SHUTTER SECTION - 18 mm.)

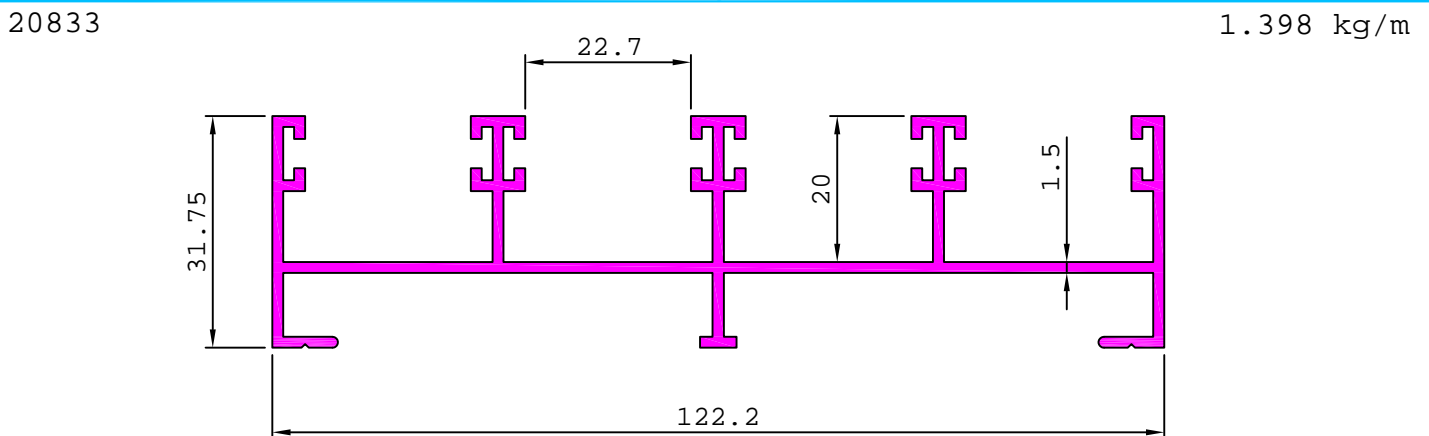
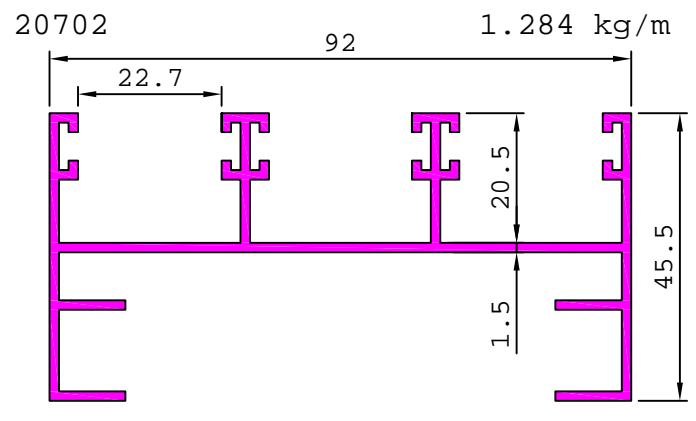
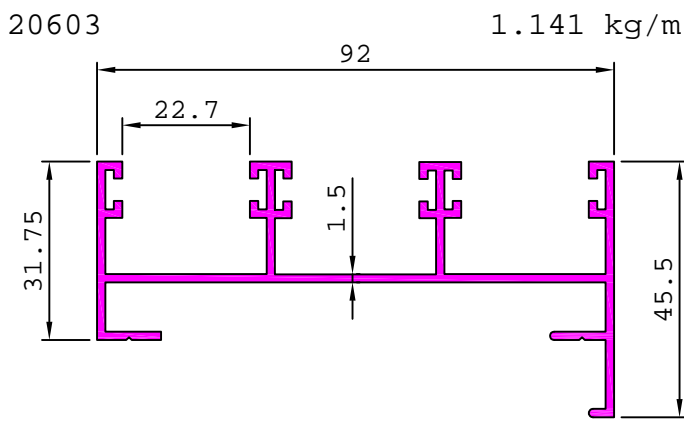
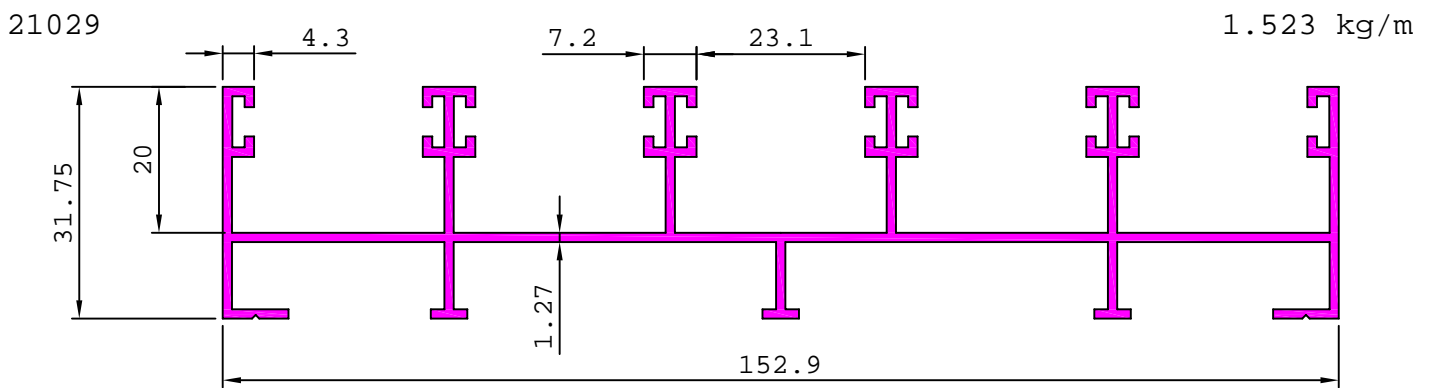
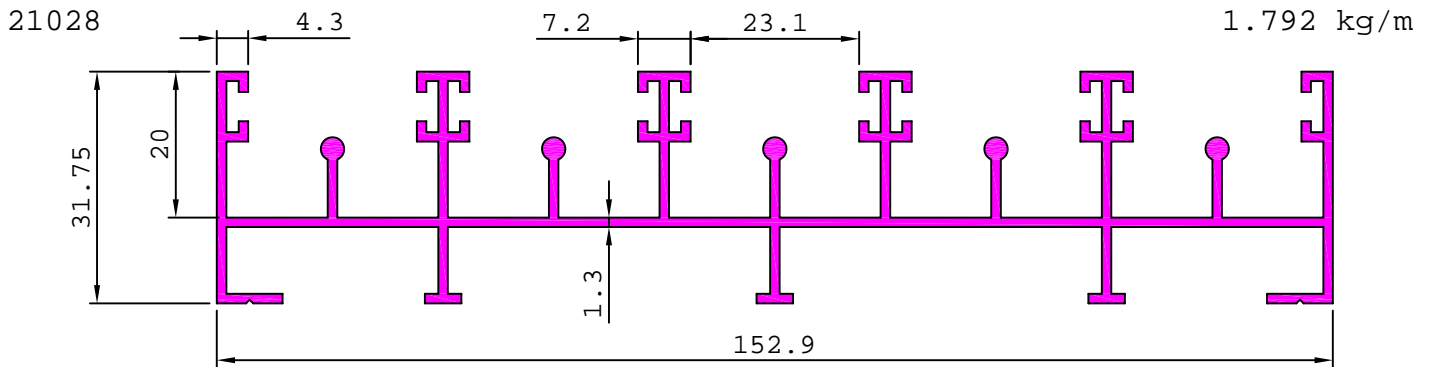

ARCHITECTURAL

DETAILS OF SLIDING WINDOW SECTIONS SERIES - B (SHUTTER SECTION - 18 mm.)

20636

1.388 kg/m

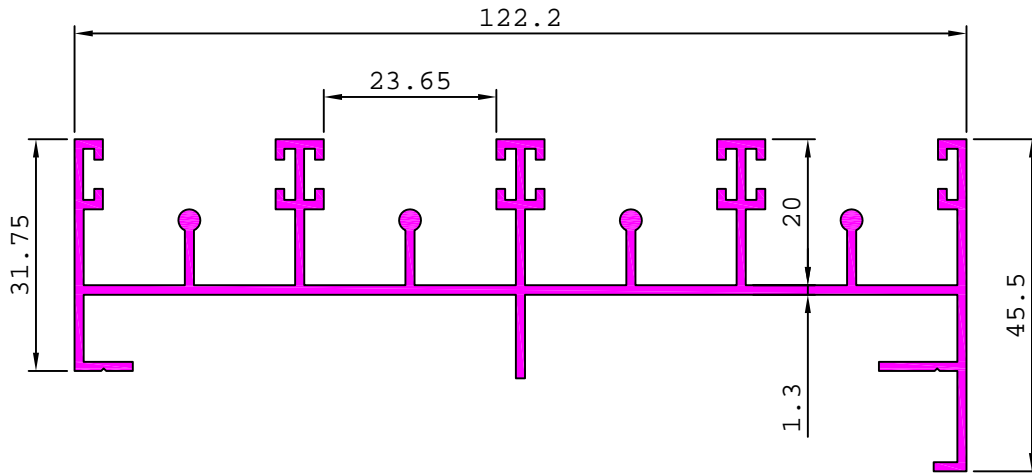

20667

1.148 kg/m

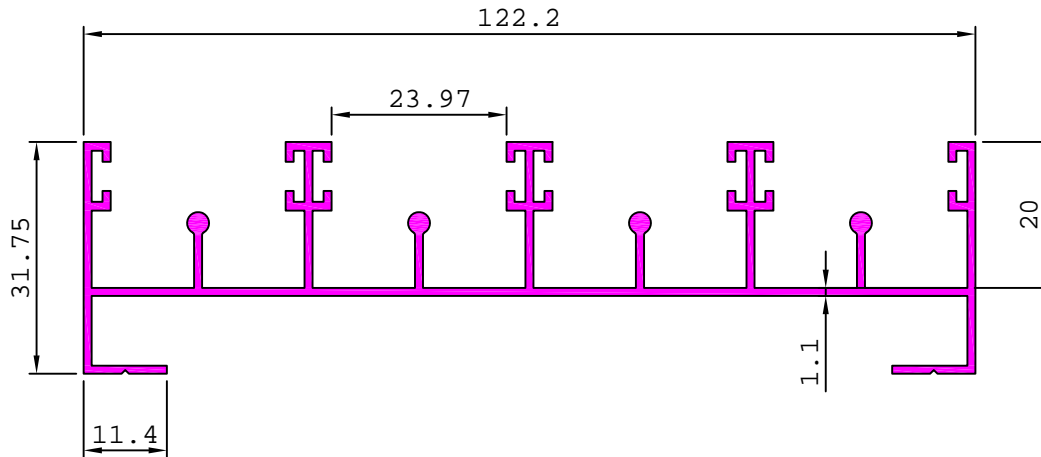

20674

1.829 kg/m

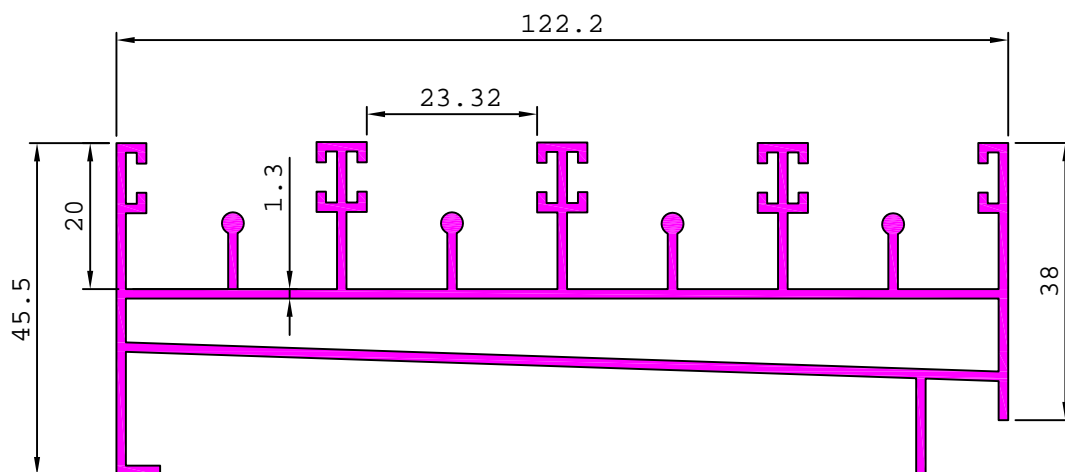

ARCHITECTURAL

DETAILS OF SLIDING WINDOW SECTIONS SERIES - B (SHUTTER SECTION - 18 mm.)

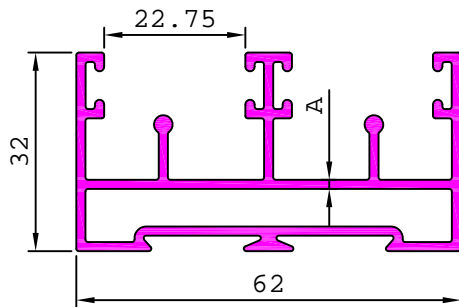
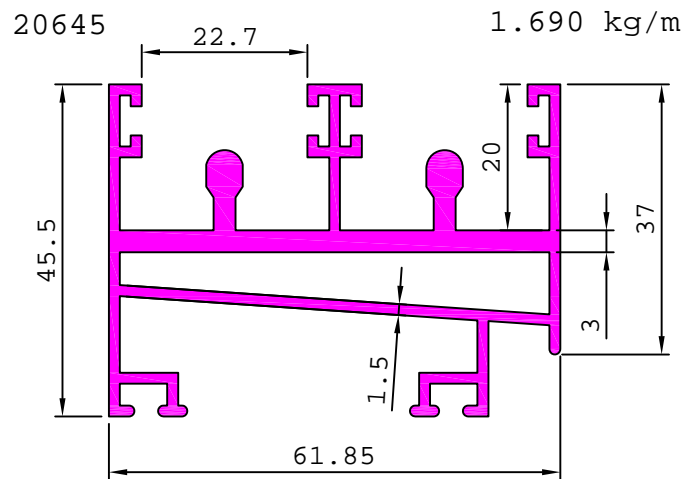
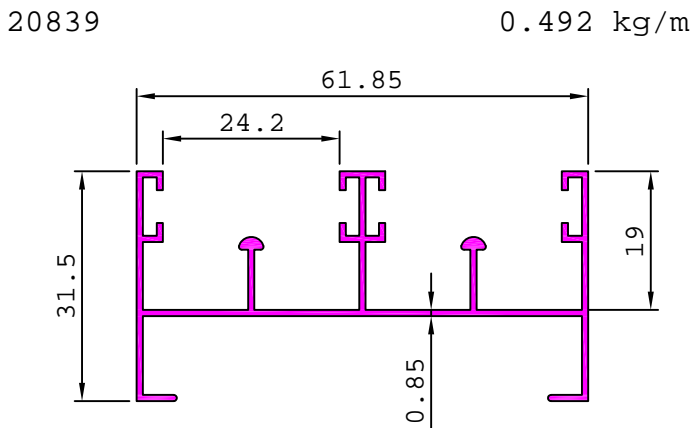
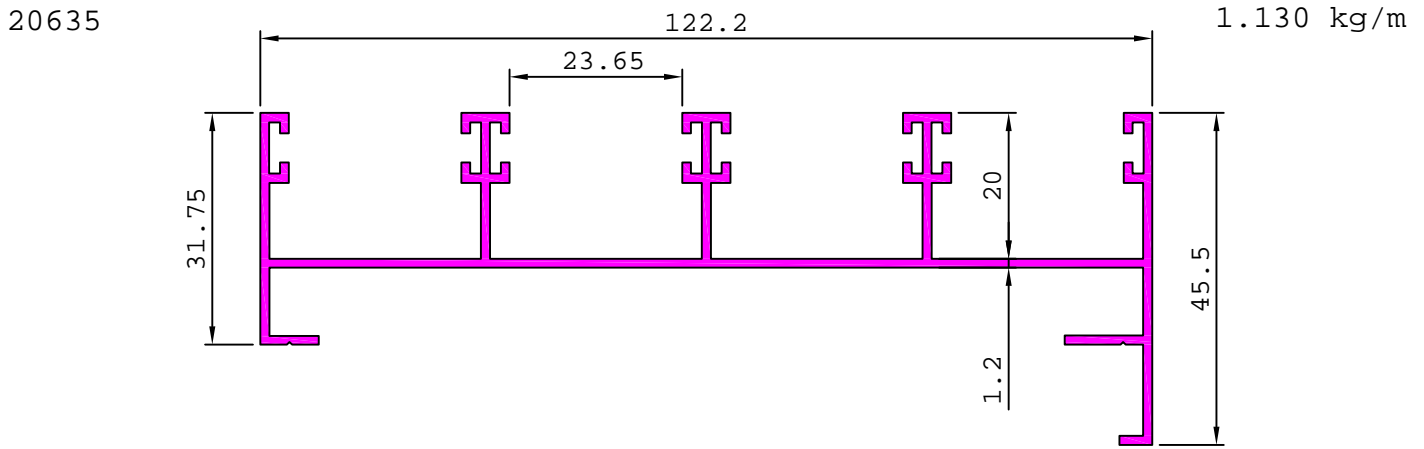

SL. No.	Section No.	A	Weight kg/m
1	21452	1.30	1.017
2	21051	1.47	1.106

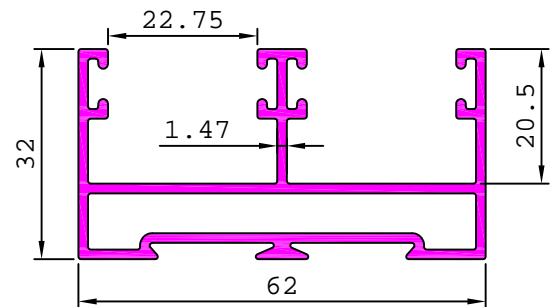

SL. No.	Section No.	A	Weight kg/m
1	21453	1.30	0.923
2	20888	1.47	1.005

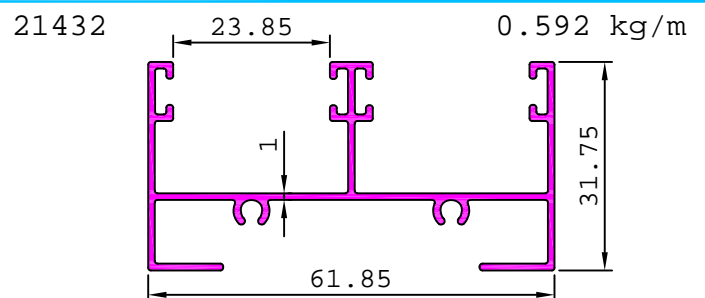
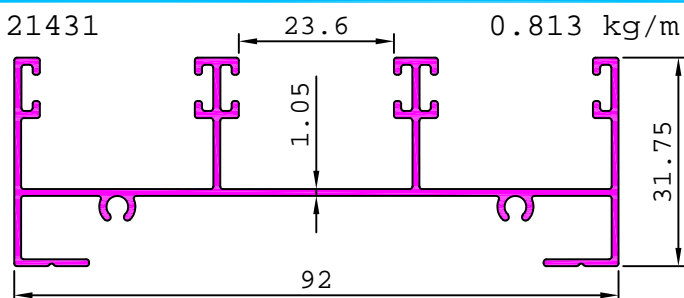

ARCHITECTURAL

DETAILS OF SLIDING WINDOW SECTIONS SERIES - B (SHUTTER SECTION - 18 mm.)

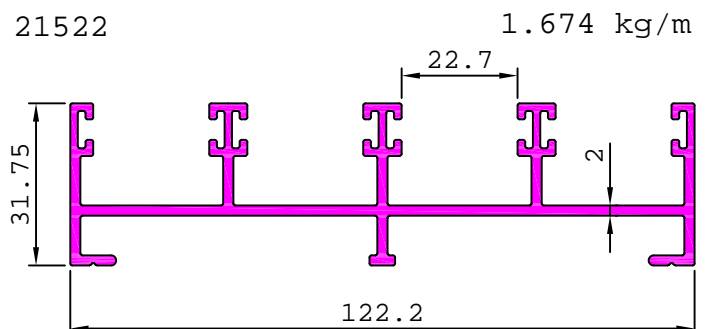
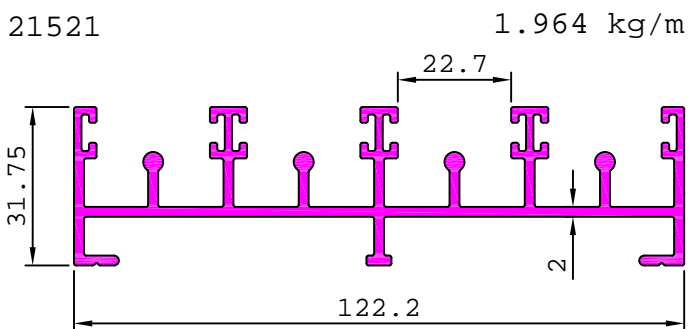
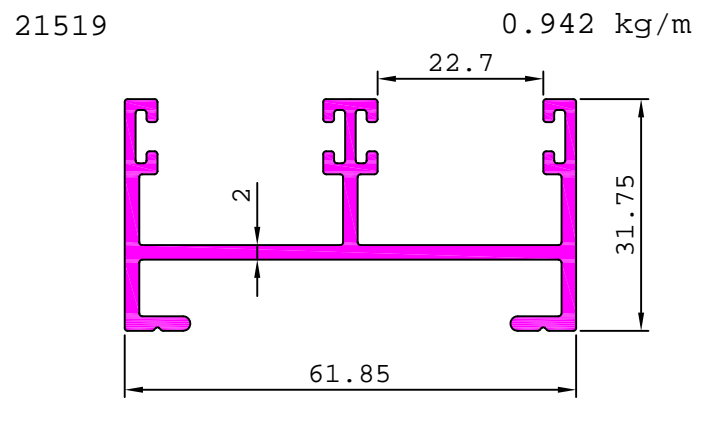
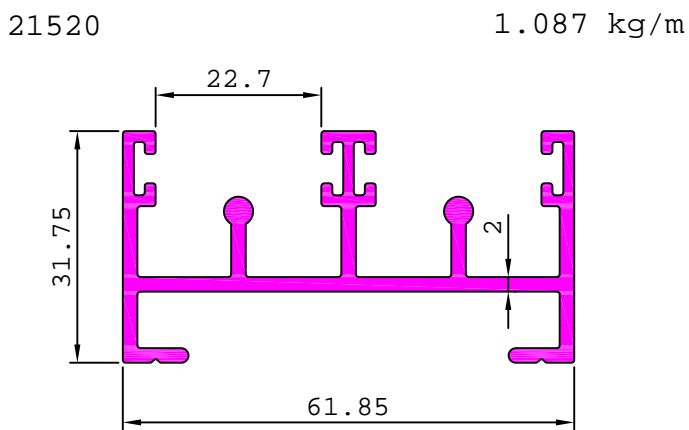
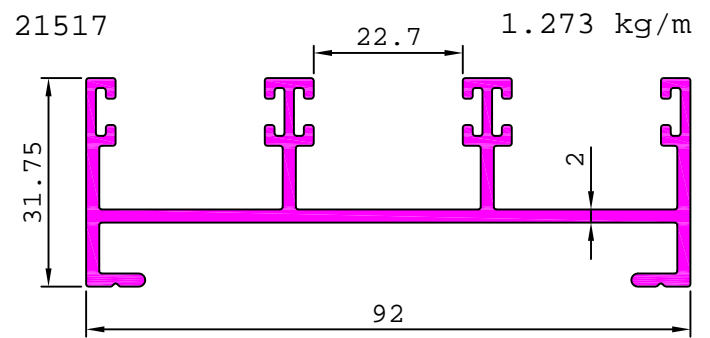
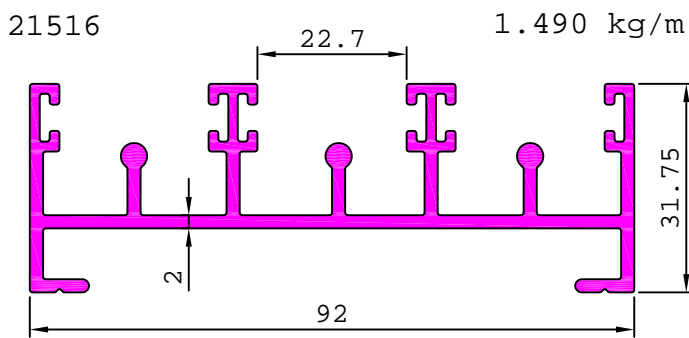
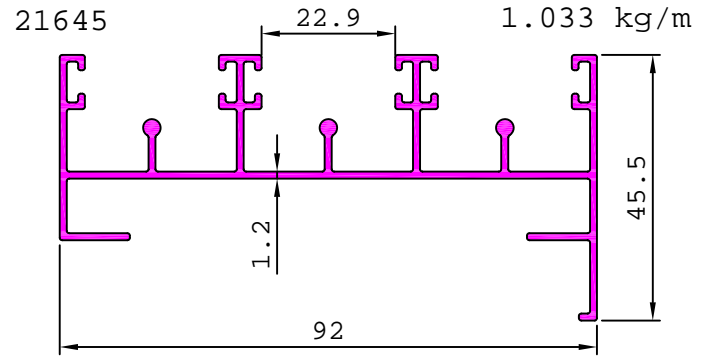
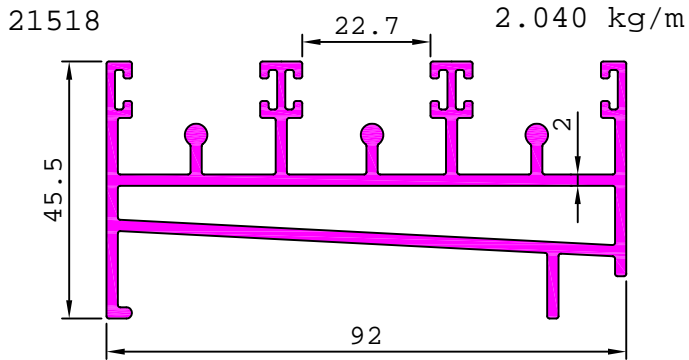

ARCHITECTURAL

DETAILS OF SLIDING WINDOW SECTIONS SERIES - C (SHUTTER SECTION - 20 mm.)

<p>20529 0.642 kg/m</p>	<p>20530 0.571 kg/m</p>	<p>20544 0.495 kg/m</p>																																							
<table border="1" data-bbox="183 974 582 1220"> <thead> <tr> <th>SL. No.</th> <th>Section No.</th> <th>A</th> <th>Weight kg/m</th> </tr> </thead> <tbody> <tr> <td>1</td> <td>20968</td> <td>0.80</td> <td>0.277</td> </tr> <tr> <td>2</td> <td>20931</td> <td>1.00</td> <td>0.342</td> </tr> <tr> <td>3</td> <td>20975</td> <td>1.25</td> <td>0.418</td> </tr> <tr> <td>4</td> <td>20709</td> <td>1.50</td> <td>0.488</td> </tr> <tr> <td>5</td> <td>21093</td> <td>2.00</td> <td>0.634</td> </tr> </tbody> </table>	SL. No.	Section No.	A	Weight kg/m	1	20968	0.80	0.277	2	20931	1.00	0.342	3	20975	1.25	0.418	4	20709	1.50	0.488	5	21093	2.00	0.634	<table border="1" data-bbox="965 996 1364 1176"> <thead> <tr> <th>SL. No.</th> <th>Section No.</th> <th>A</th> <th>Weight kg/m</th> </tr> </thead> <tbody> <tr> <td>1</td> <td>20988</td> <td>0.98</td> <td>0.314</td> </tr> <tr> <td>2</td> <td>20710</td> <td>1.10</td> <td>0.355</td> </tr> <tr> <td>3</td> <td>21092</td> <td>2.00</td> <td>0.606</td> </tr> </tbody> </table>	SL. No.	Section No.	A	Weight kg/m	1	20988	0.98	0.314	2	20710	1.10	0.355	3	21092	2.00	0.606
SL. No.	Section No.	A	Weight kg/m																																						
1	20968	0.80	0.277																																						
2	20931	1.00	0.342																																						
3	20975	1.25	0.418																																						
4	20709	1.50	0.488																																						
5	21093	2.00	0.634																																						
SL. No.	Section No.	A	Weight kg/m																																						
1	20988	0.98	0.314																																						
2	20710	1.10	0.355																																						
3	21092	2.00	0.606																																						
<p>20551 0.484 kg/m</p>	<p>21022 0.539 kg/m</p>																																								
<p>21357 0.571 kg/m</p>	<p>20972 0.451 kg/m</p>																																								

ARCHITECTURAL

DETAILS OF SLIDING WINDOW SECTIONS SERIES - C (SHUTTER SECTION - 20 mm.)

21283

0.512 kg/m

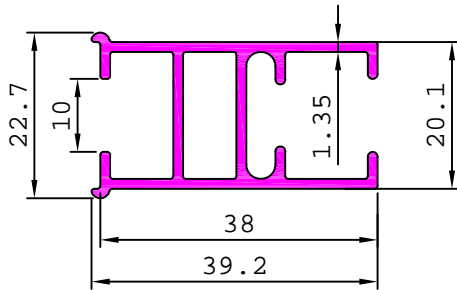

21320

0.477 kg/m

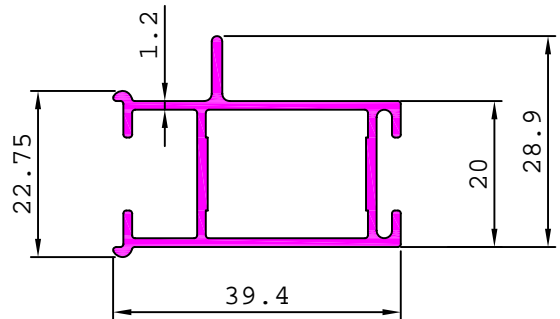

21609

0.379 kg/m

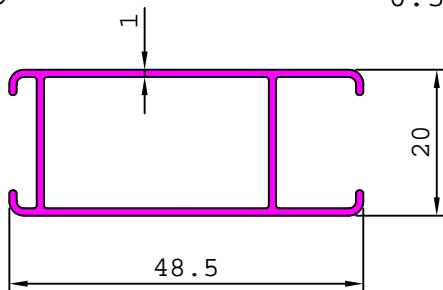

21616

0.242 kg/m

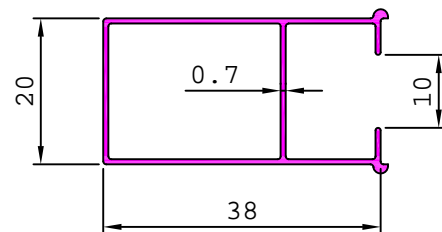

ARCHITECTURAL

DETAILS OF SLIDING WINDOW SECTIONS SERIES - C (SHUTTER SECTION - 20 mm.)

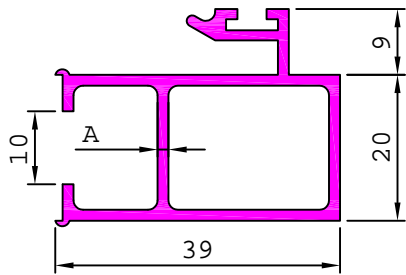

SL. No.	Section No.	A	Weight kg/m
1	21052	1.00	0.409
2	20976	1.15	0.473
3	20708	1.50	0.605
4	21094	2.00	0.734

20973 0.503 kg/m

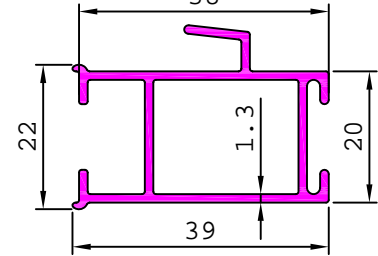

20531 0.697 kg/m

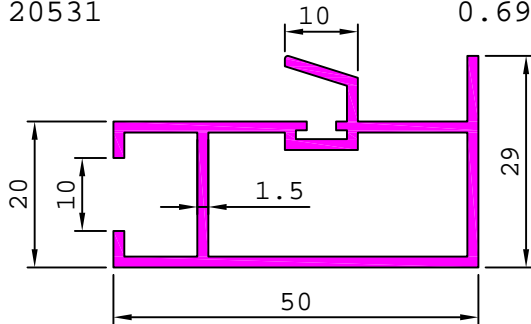

20566 0.693 kg/m

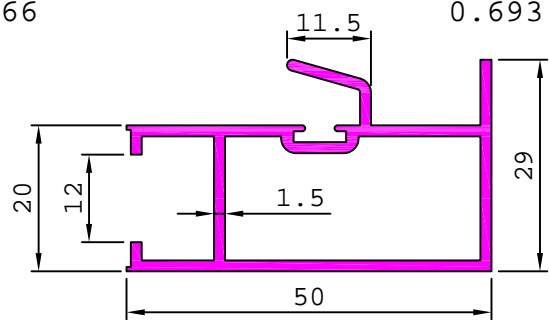

20840 0.594 kg/m

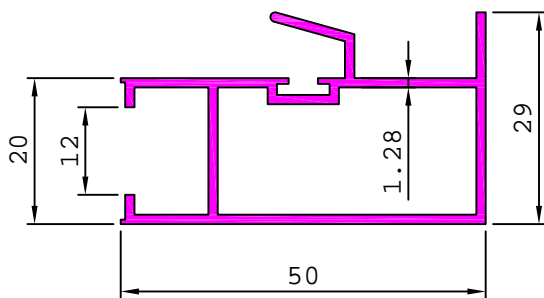

21356 0.678 kg/m

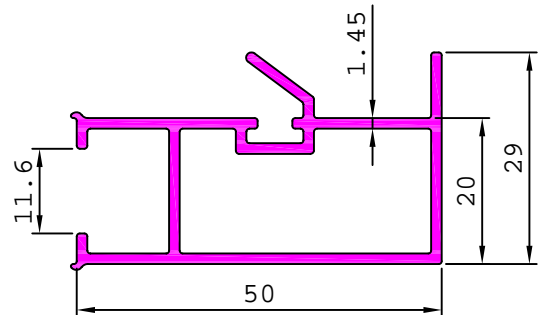

21653 0.612 kg/m

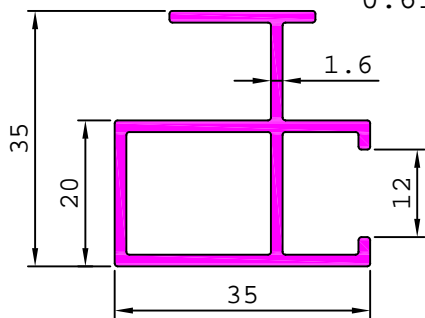

21654 0.657 kg/m

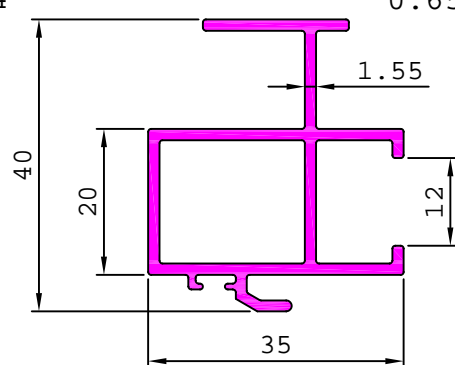

21611 0.435 kg/m

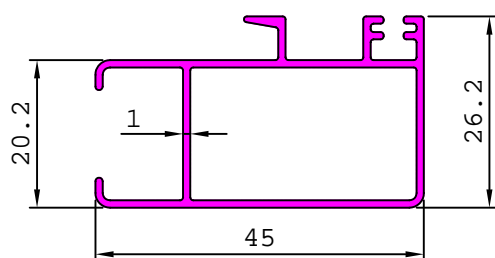

ARCHITECTURAL

DETAILS OF SLIDING WINDOW SECTIONS SERIES - C (SHUTTER SECTION - 20 mm.)

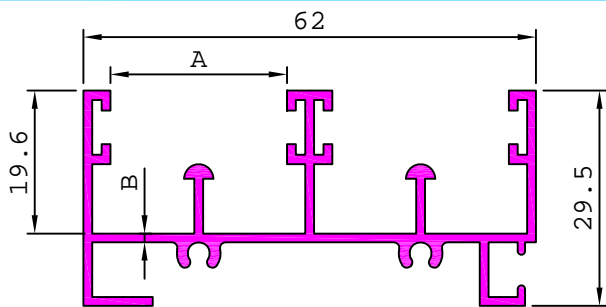

SL. No.	Section No.	A	B	Weight kg/m
1	21053	24.20	1.00	0.630
2	20703	24.20	1.20	0.726
3	21139	23.30	1.50	0.902

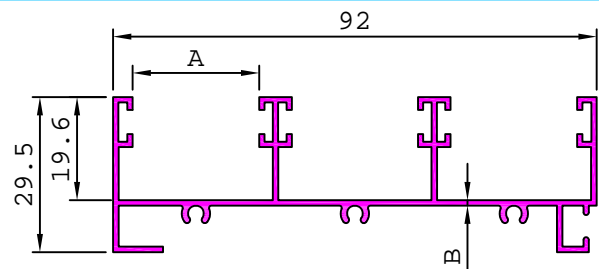

SL. No.	Section No.	A	B	Weight kg/m
1	21054	24.10	1.05	0.777
2	20696	24.10	1.20	0.907
3	20978	23.20	1.40	1.066
4	21137	23.20	1.50	1.102
4	21100	23.05	2.00	1.342

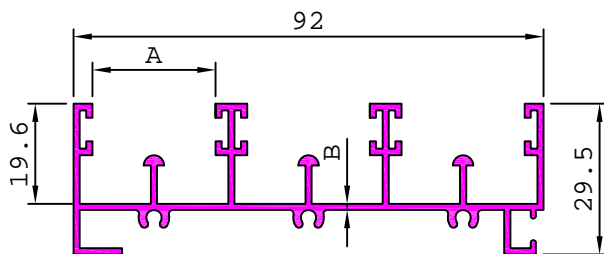

SL. No.	Section No.	A	B	Weight kg/m
1	21055	24.10	1.00	0.866
2	20704	24.10	1.20	1.036
3	20977	23.20	1.45	1.217
4	21099	23.05	2.00	1.516

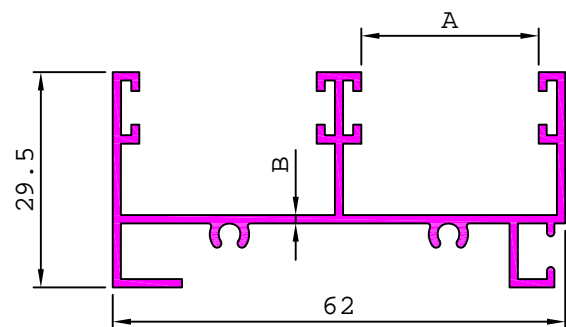

SL. No.	Section No.	A	B	Weight kg/m
1	20987	24.30	1.13	0.615
2	21138	23.30	1.50	0.807

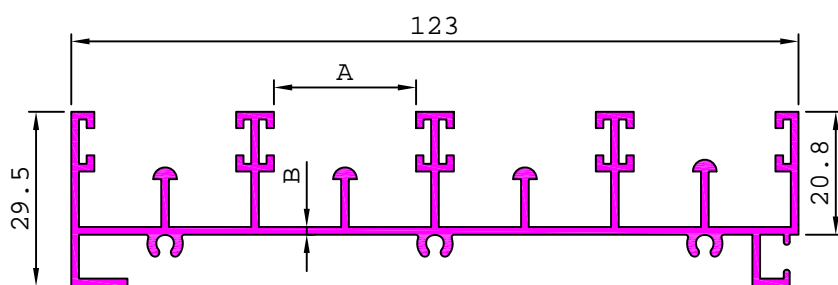

SL. No.	Section No.	A	B	Weight kg/m
1	20910	24.00	1.30	1.394
2	21101	23.30	2.00	1.915

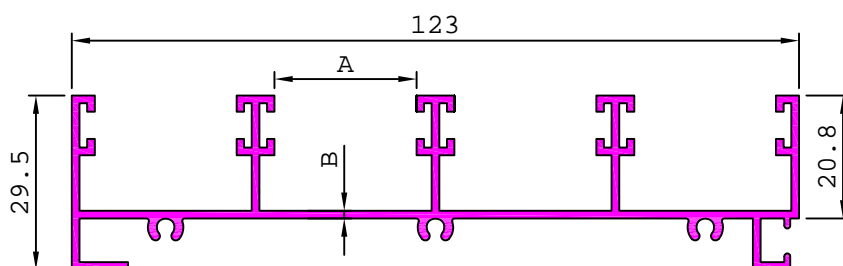

SL. No.	Section No.	A	B	Weight kg/m
1	20911	24.00	1.30	1.207
2	21098	23.30	2.00	1.670

ARCHITECTURAL

DETAILS OF SLIDING WINDOW SECTIONS SERIES - C (SHUTTER SECTION - 20 mm.)

20694 0.695 kg/m

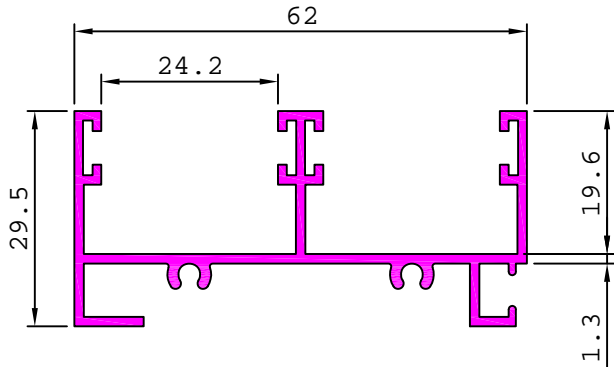

20695 1.088 kg/m

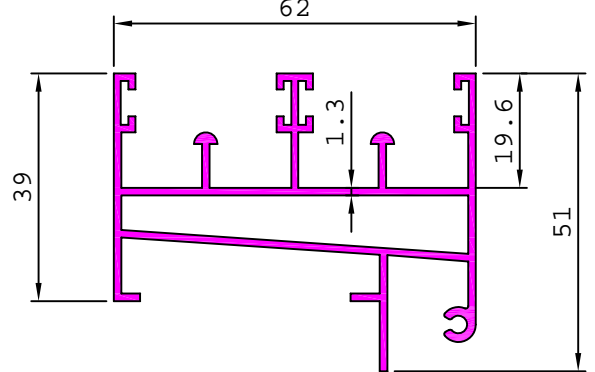

20697 1.374 kg/m

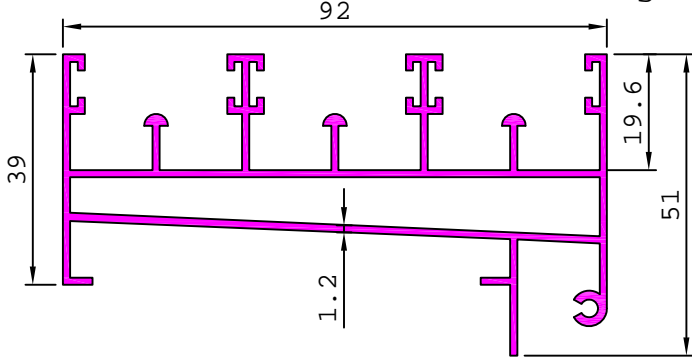

21680 1.258 kg/m

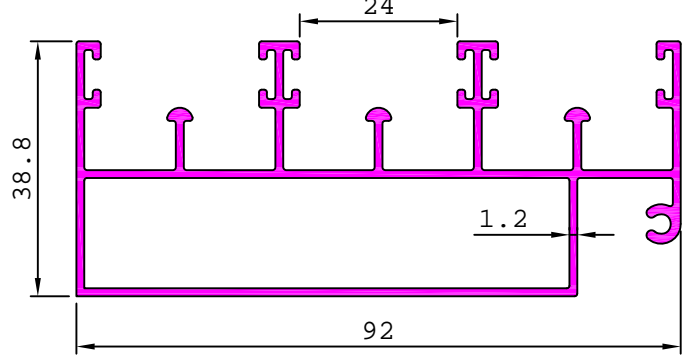

21496 1.173 kg/m

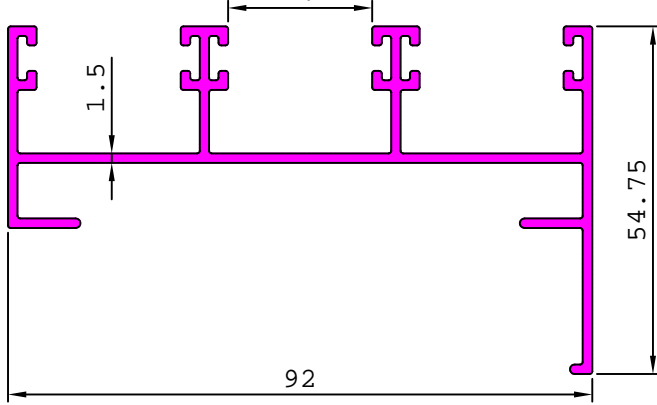

21588 1.313 kg/m

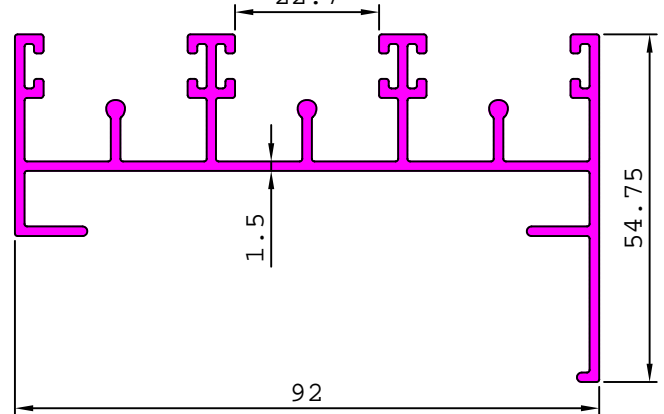

21603 0.832 kg/m

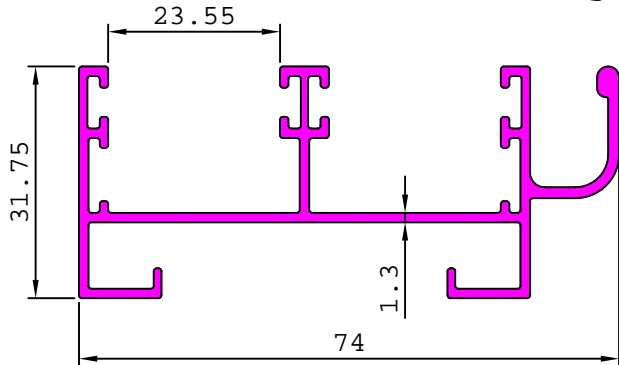

21604 1.232 kg/m

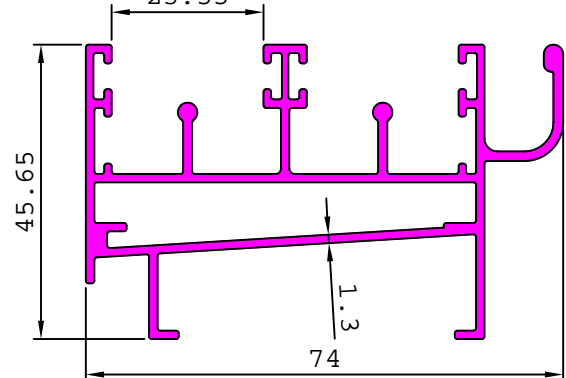

ARCHITECTURAL

DETAILS OF SLIDING WINDOW SECTIONS SERIES - C (SHUTTER SECTION - 20 mm.)

21692 1.369 kg/m

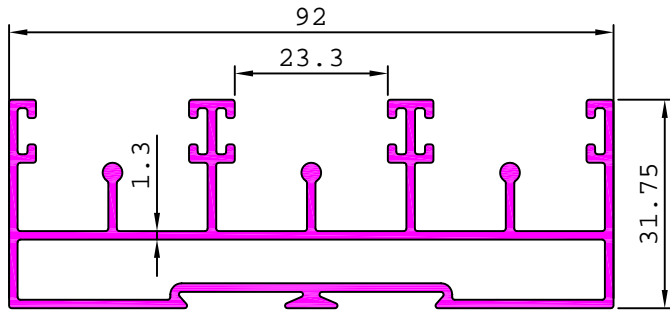

21216 1.233 kg/m

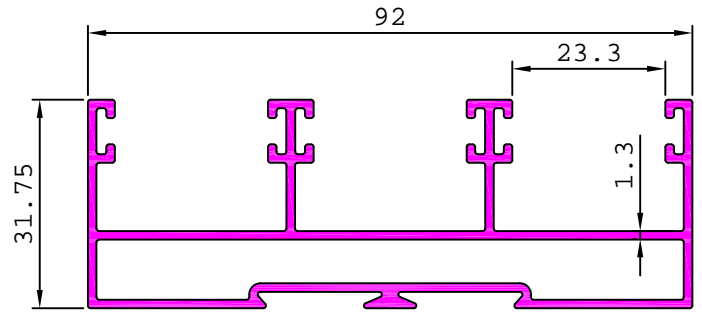

21650 1.685 kg/m

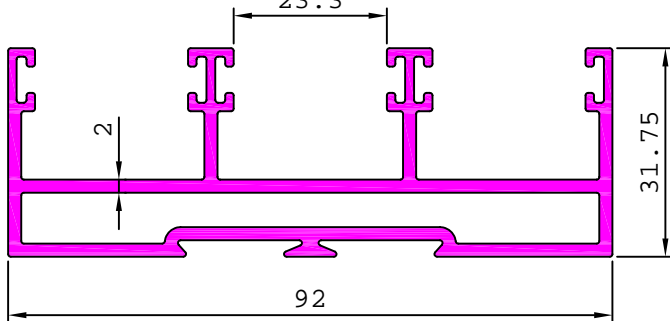

21651 1.864 kg/m

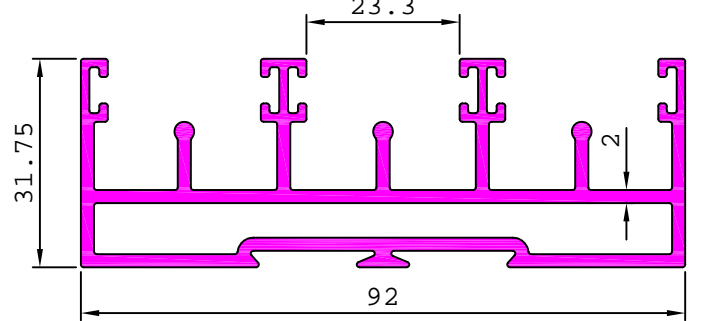

21495 1.174 kg/m

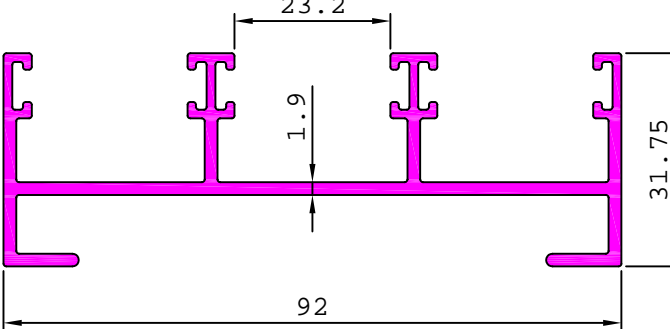

21501 1.336 kg/m

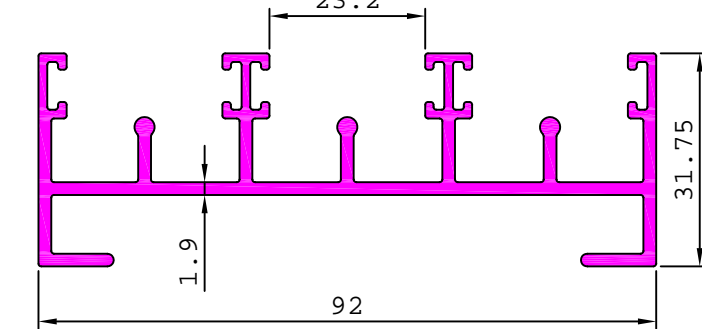

21684 1.356 kg/m

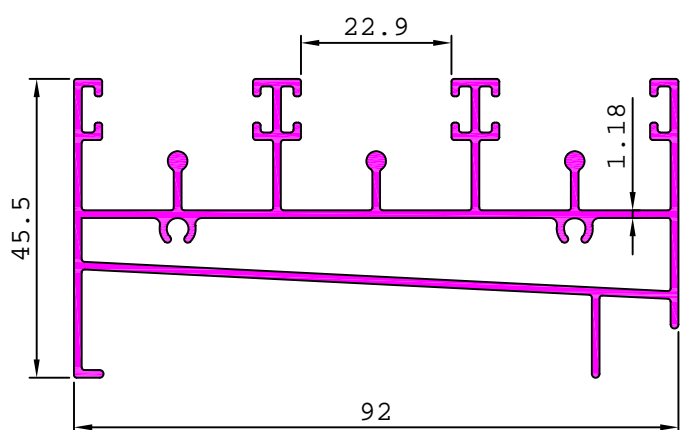

ARCHITECTURAL

DETAILS OF SLIDING WINDOW SECTIONS SERIES - D (SHUTTER SECTION - 25 mm.)

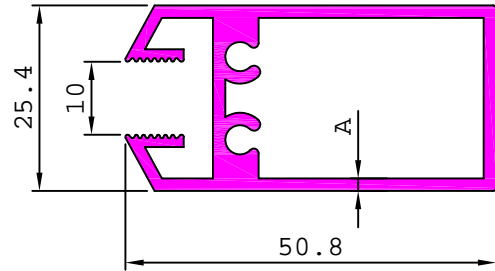
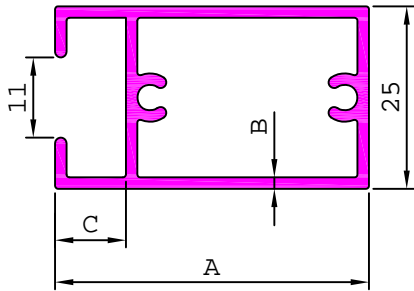

SL. No.	Section No.	A	B	C	Weight kg/m
1	20841	43.00	1.33	9.70	0.569
2	20602	43.00	1.57	9.70	0.665
3	21030	43.00	1.98	9.70	0.828
4	21253	50.00	1.00	12.20	0.483
5	20707	50.00	1.20	12.20	0.593
6	21056	50.00	1.51	12.51	0.717

SL. No.	Section No.	A	Weight kg/m
1	21144	1.50	0.797
2	20715	1.70	0.886
3	21361	1.98	1.003

20506 0.717 kg/m

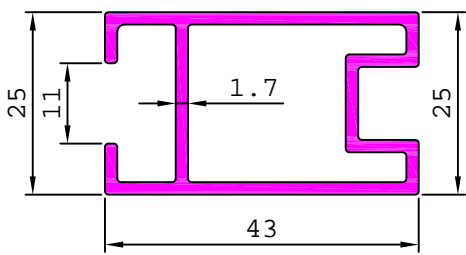

20507 0.642 kg/m

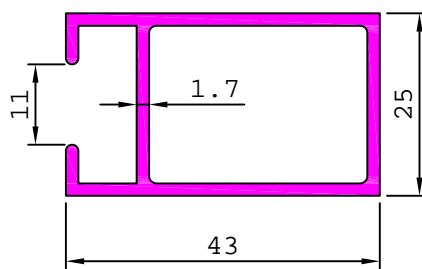

20516 0.560 kg/m

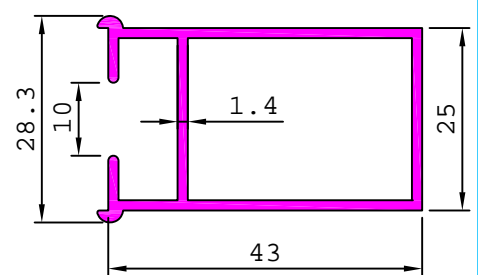

20518 0.675 kg/m

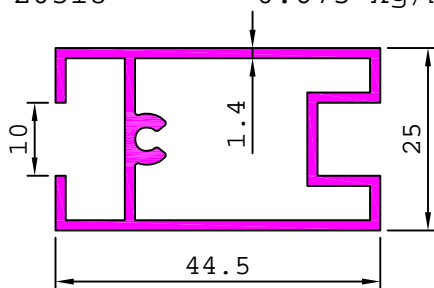

21393 0.508 kg/m

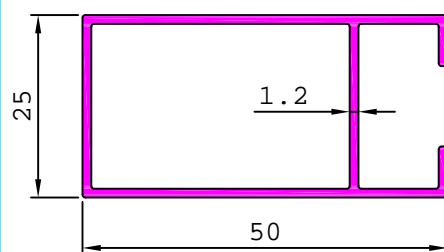

21045 0.475 kg/m

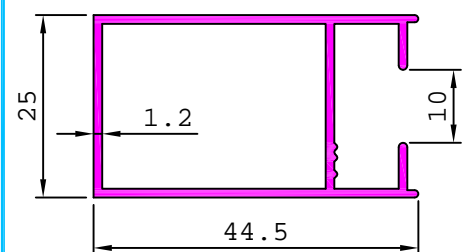

21355 0.598 kg/m

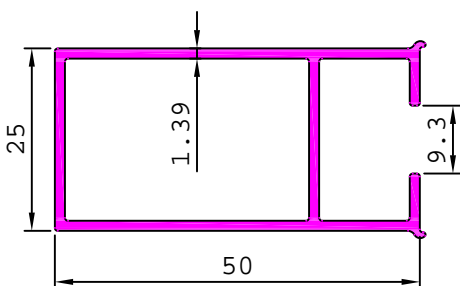

20746 0.529 kg/m

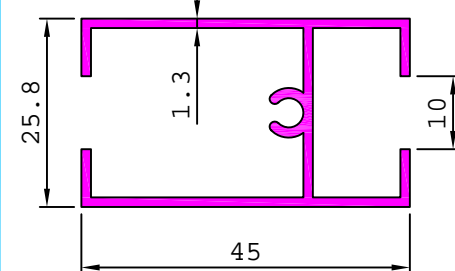

20543 0.669 kg/m

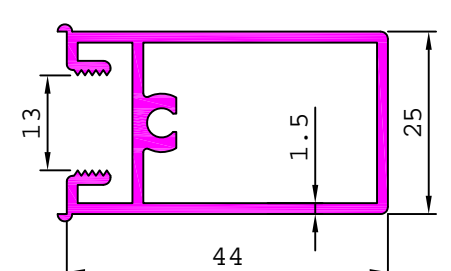

ARCHITECTURAL

DETAILS OF SLIDING WINDOW SECTIONS SERIES - D (SHUTTER SECTION - 25 mm.)

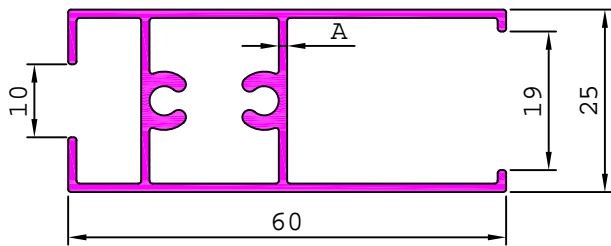

SL. No.	Section No.	A	Weight kg/m
1	20639	1.15	0.678
2	20842	1.45	0.781

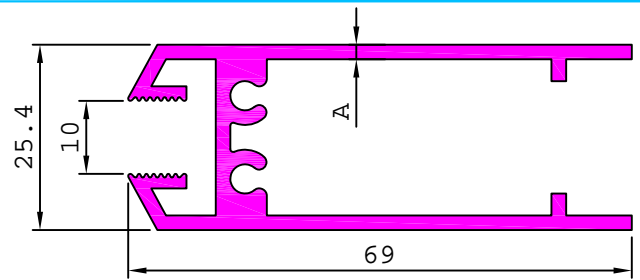

SL. No.	Section No.	A	Weight kg/m
1	21143	1.50	0.882
2	20716	2.00	1.119

20801

1.237 kg/m

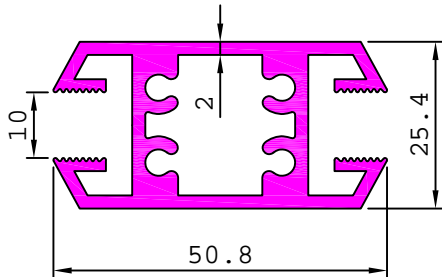

20528

0.786 kg/m

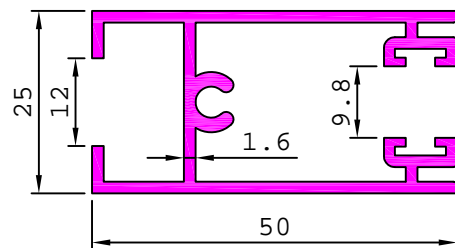

20757

0.602 kg/m

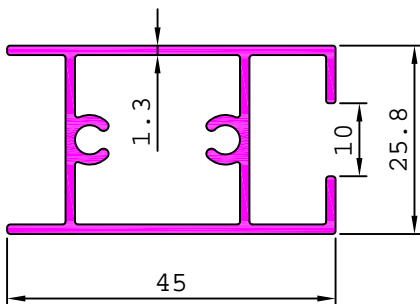

20884

0.685 kg/m

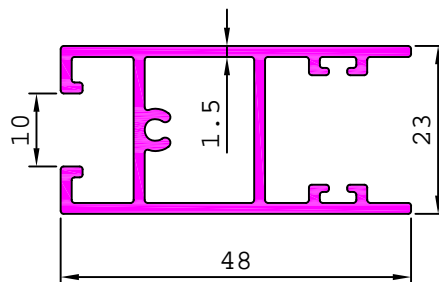

20921

0.584 kg/m

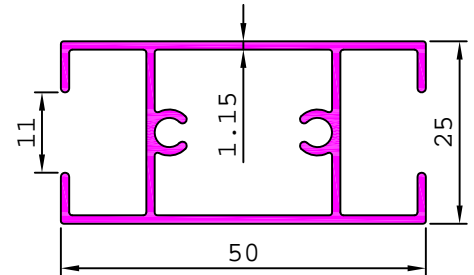

20857

1.051 kg/m

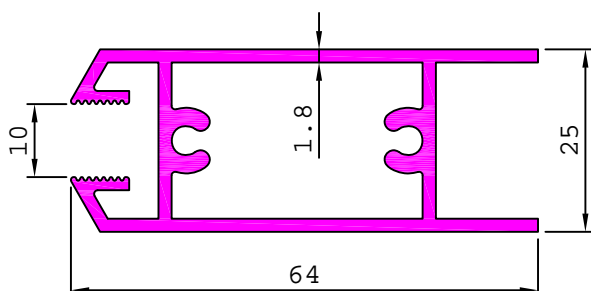

20922

0.925 kg/m

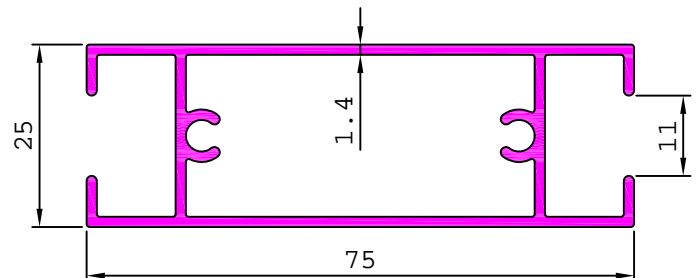

ARCHITECTURAL

DETAILS OF SLIDING WINDOW SECTIONS SERIES - D (SHUTTER SECTION - 25 mm.)

20923 0.895 kg/m

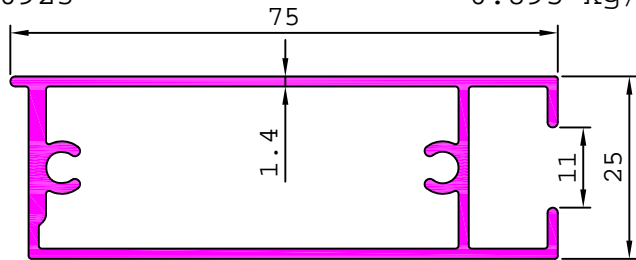

21382 0.779 kg/m

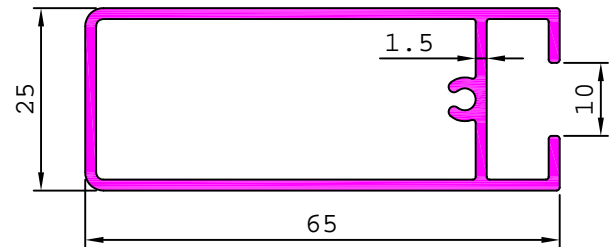

21539 0.638 kg/m

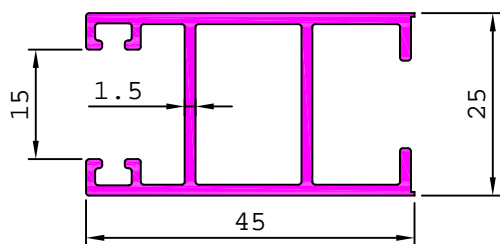

21542 0.711 kg/m

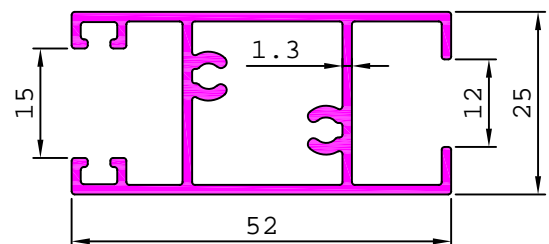

21308 0.657 kg/m

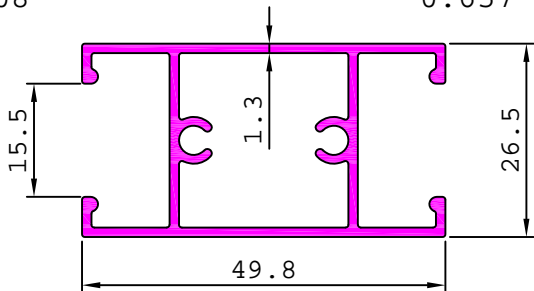

21309 0.767 kg/m

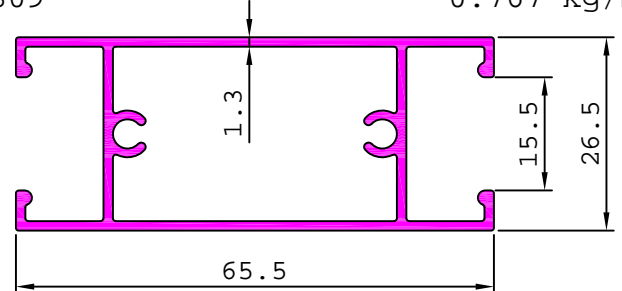

21381 0.851 kg/m

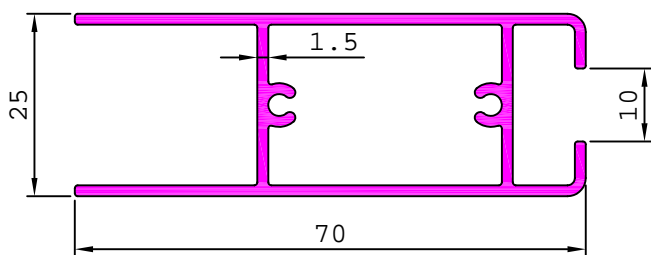

21394 0.618 kg/m

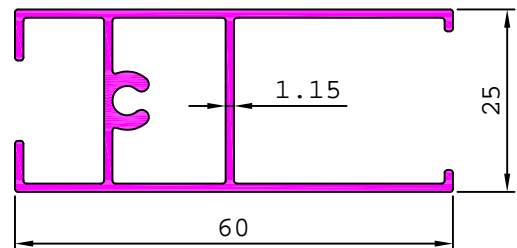

21349 0.887 kg/m

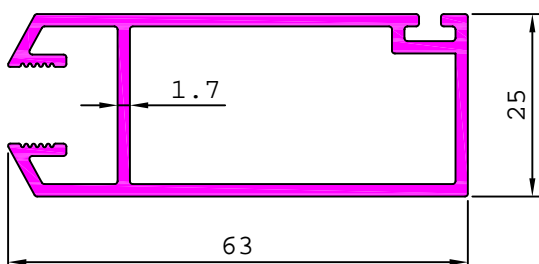

21398 1.622 kg/m

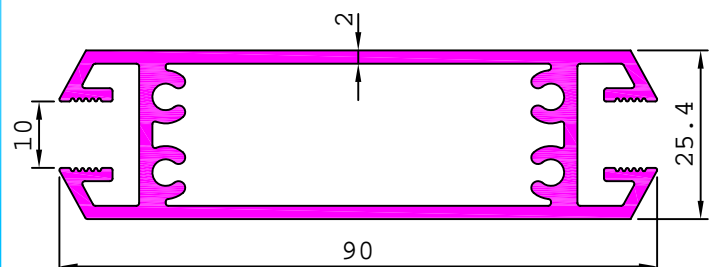

ARCHITECTURAL

DETAILS OF SLIDING WINDOW SECTIONS SERIES - D (SHUTTER SECTION - 25 mm.)

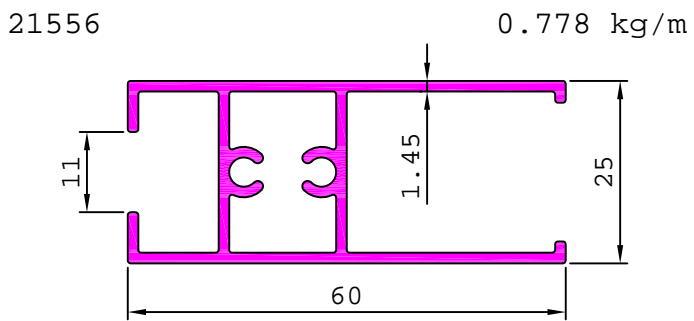
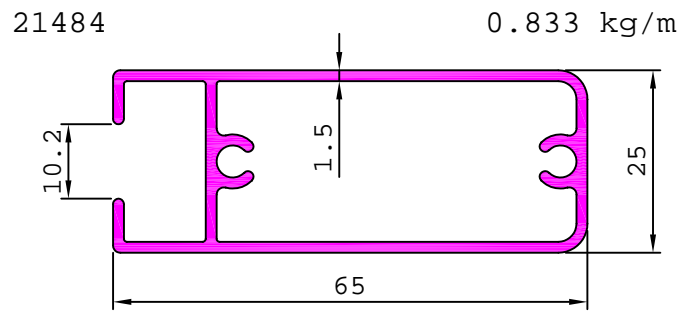
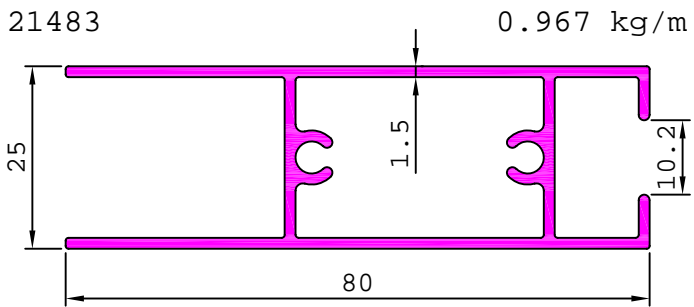

ARCHITECTURAL

DETAILS OF SLIDING WINDOW SECTIONS SERIES - D (SHUTTER SECTION - 25 mm.)

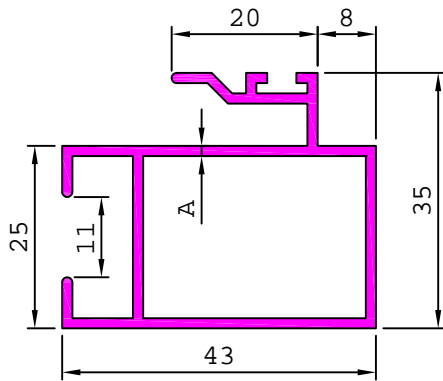

SL. No.	Section No.	A	Weight kg/m
1	20939	1.40	0.678
2	20508	1.70	0.802

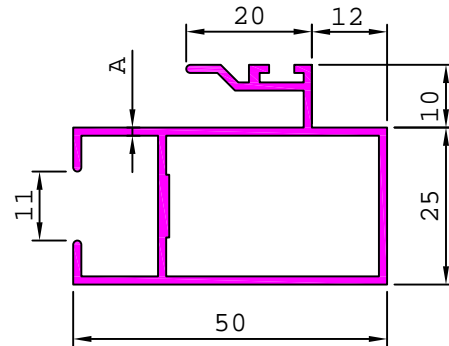

SL. No.	Section No.	A	Weight kg/m
1	20741	1.30	0.683
2	21091	1.48	0.776

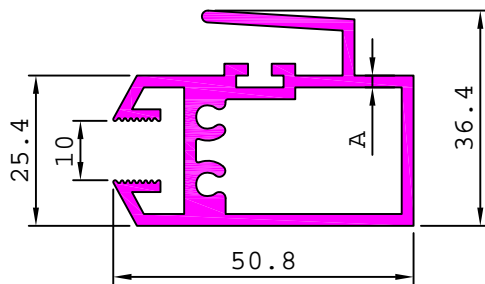

SL. No.	Section No.	A	Weight kg/m
1	21145	1.50	0.985
2	20711	1.68	1.090

20517

0.698 kg/m

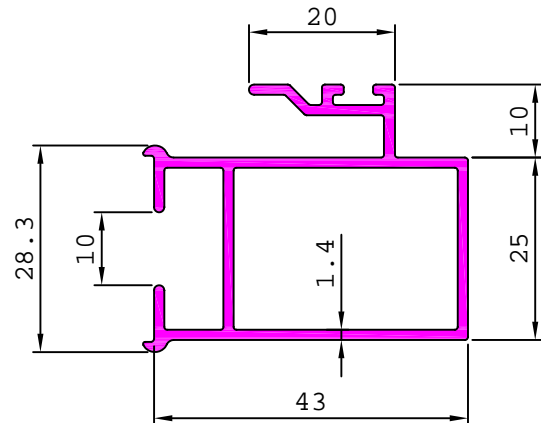

21354

0.685 kg/m

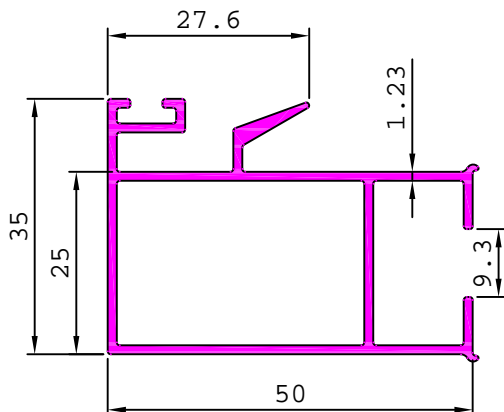

20882

0.748 kg/m

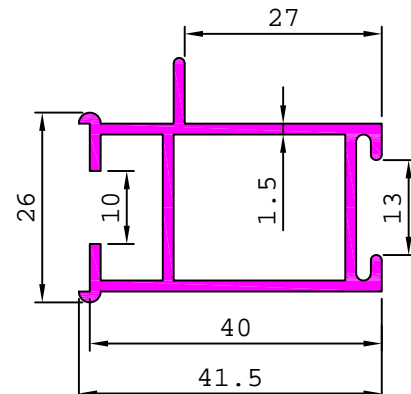

ARCHITECTURAL

DETAILS OF SLIDING WINDOW SECTIONS SERIES - D (SHUTTER SECTION - 25 mm.)

21380

0.901 kg/m

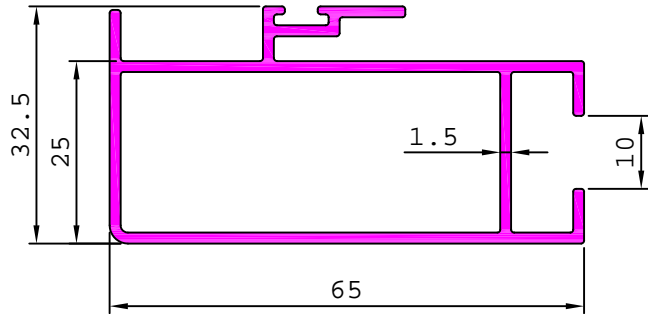

21540

0.639 kg/m

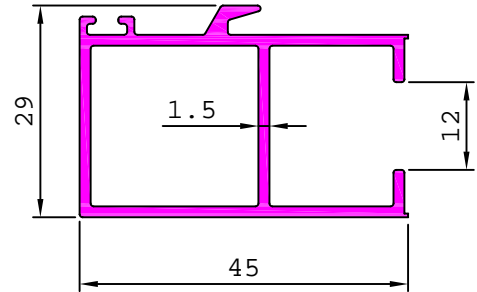

21437

0.637 kg/m

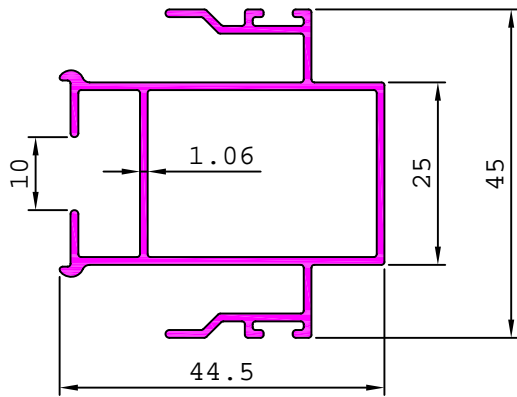

21485

0.893 kg/m

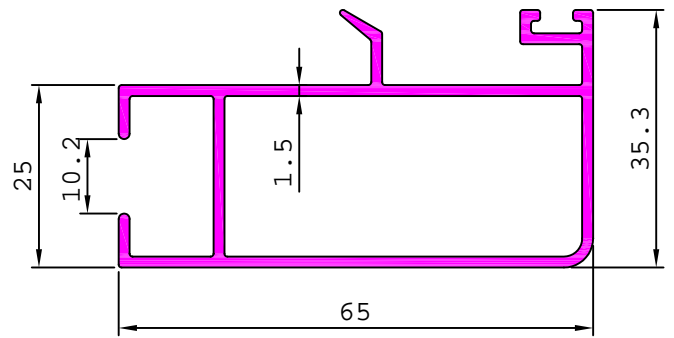

ARCHITECTURAL

DETAILS OF SLIDING WINDOW SECTIONS SERIES - D (SHUTTER SECTION - 25 mm.)

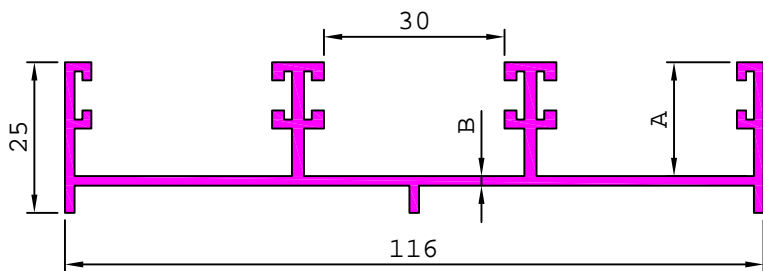

SL. No.	Section No.	A	B	Weight kg/m
1	21032	19.10	1.40	1.005
2	20678	18.90	1.70	1.194

20677 1.674 kg/m

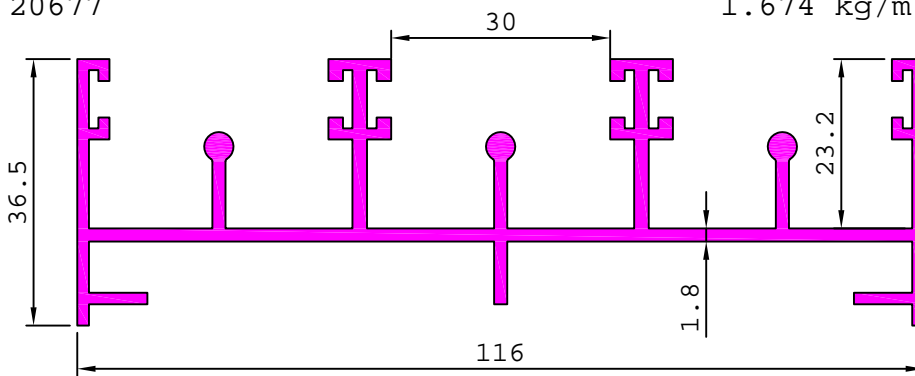

20740 1.006 kg/m

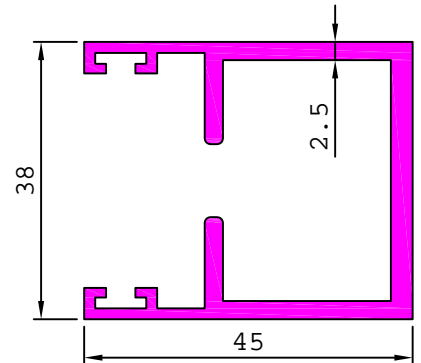

20798 1.160 kg/m

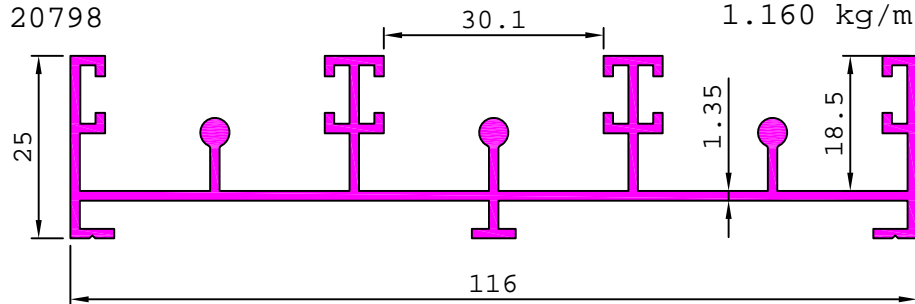

20675 0.274 kg/m

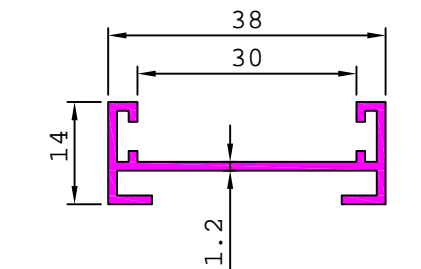

20633 0.676 kg/m

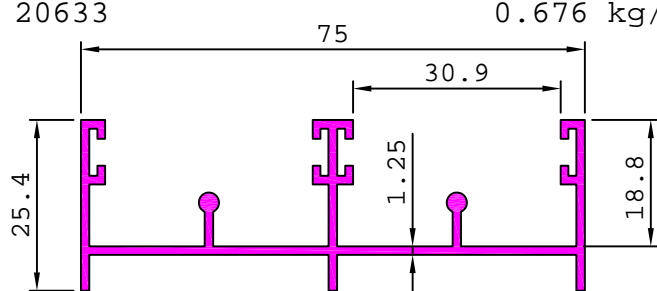

20634 0.619 kg/m

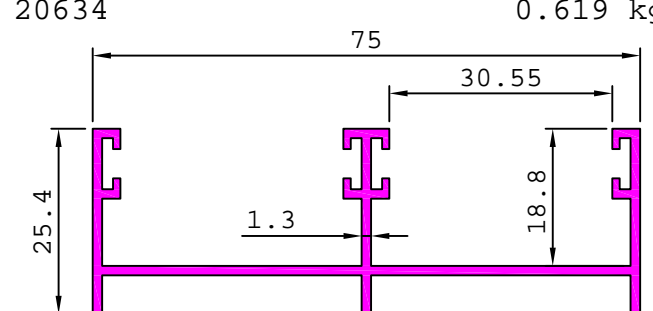

20873 0.846 kg/m

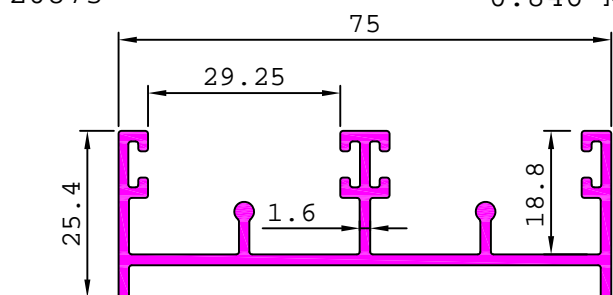

20874 0.800 kg/m

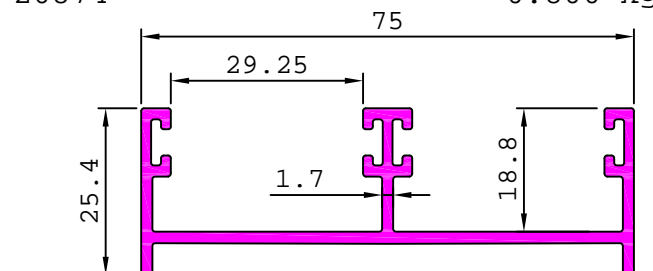

ARCHITECTURAL

DETAILS OF SLIDING WINDOW SECTIONS SERIES - D (SHUTTER SECTION - 25 mm.)

20676 1.075 kg/m

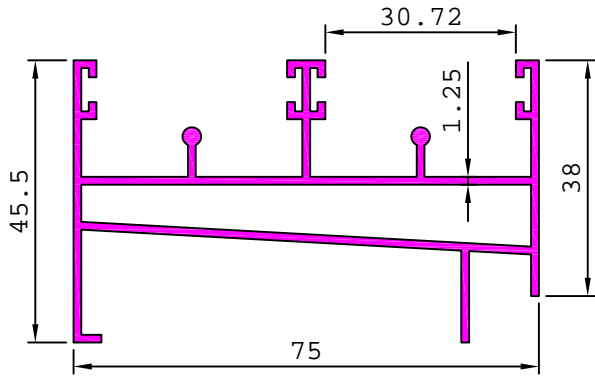

20673 1.619 kg/m

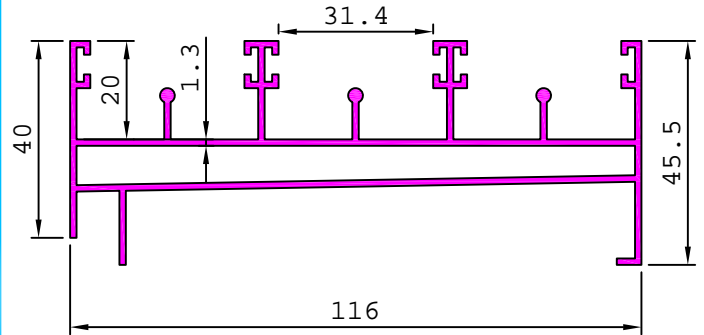

20796 1.434 kg/m

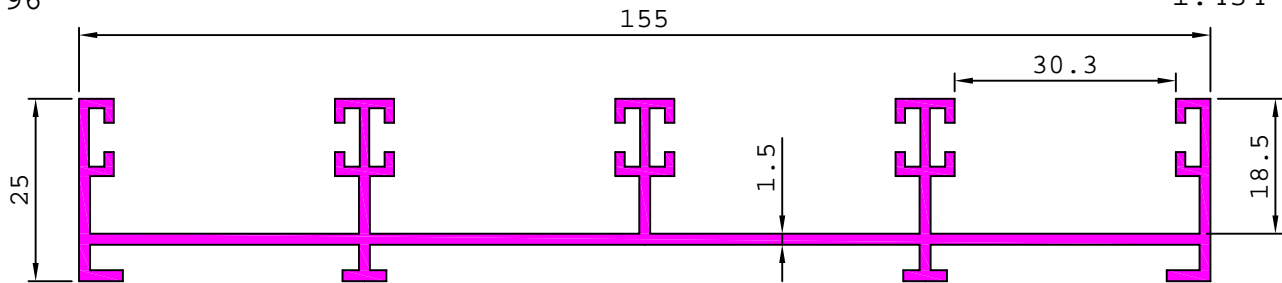

20797 1.667 kg/m

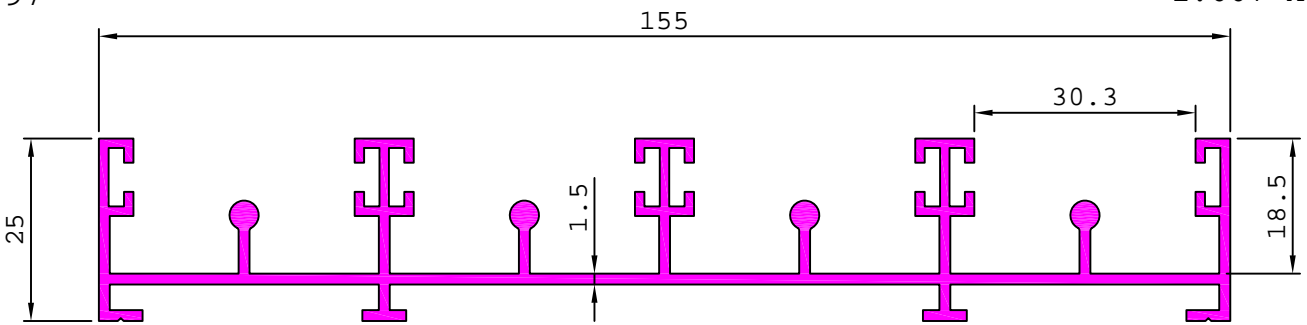

20732 0.669 kg/m

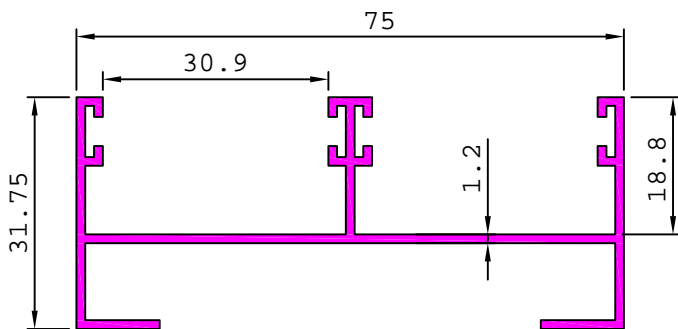

21304 1.082 kg/m

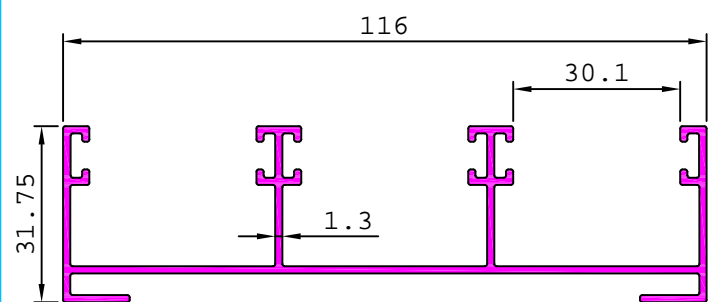

ARCHITECTURAL

DETAILS OF SLIDING WINDOW SECTIONS SERIES - D (SHUTTER SECTION - 25 mm.)

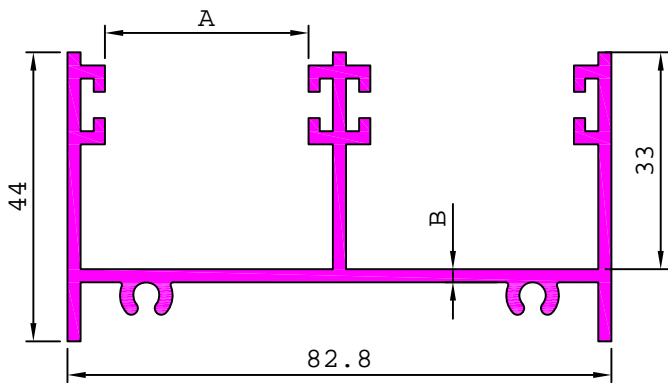

SL. No.	Section No.	A	B	Weight kg/m
1	21147	32.15	1.50	1.073
2	20713	31.00	2.00	1.429

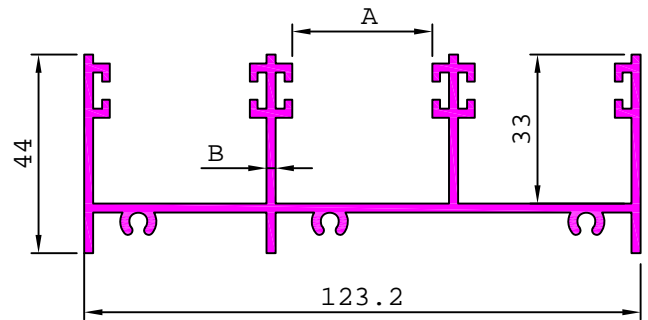

SL. No.	Section No.	A	B	Weight kg/m
1	21149	32.10	1.50	1.539
2	20714	31.00	2.00	2.062

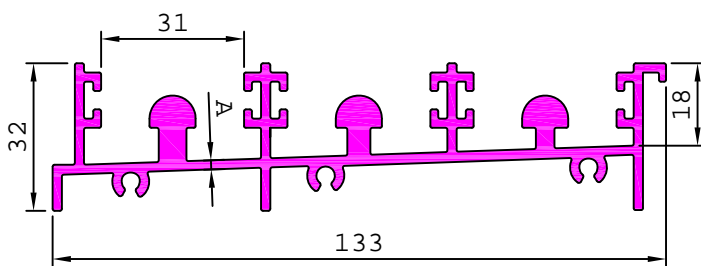

SL. No.	Section No.	A	Weight kg/m
1	21148	1.50	1.842
2	20717	2.00	2.572

21321 2.329 kg/m

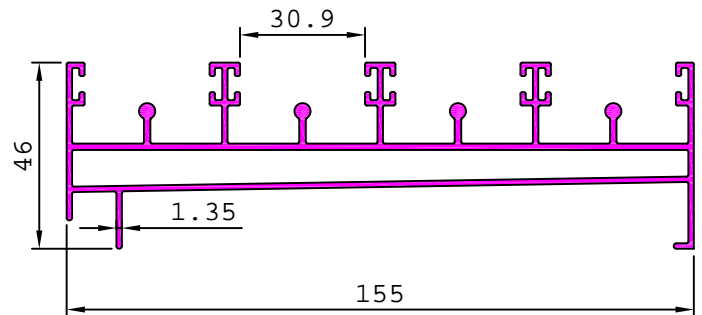

21146 1.308 kg/m

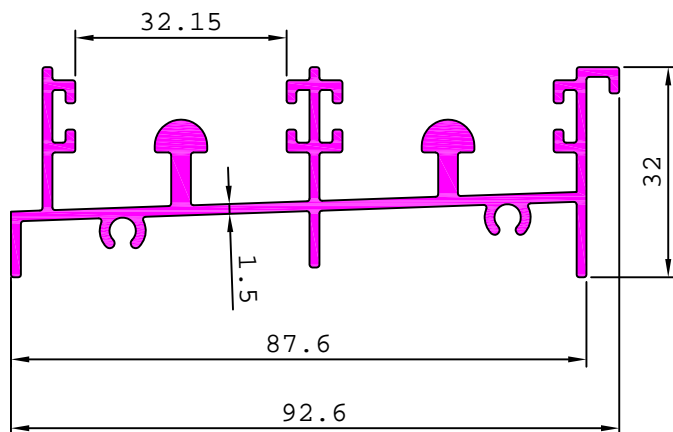

20712 1.805 kg/m

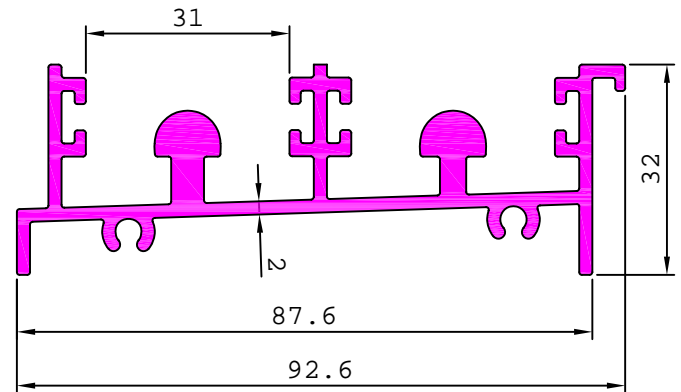

ARCHITECTURAL

DETAILS OF SLIDING WINDOW SECTIONS SERIES - D (SHUTTER SECTION - 25 mm.)

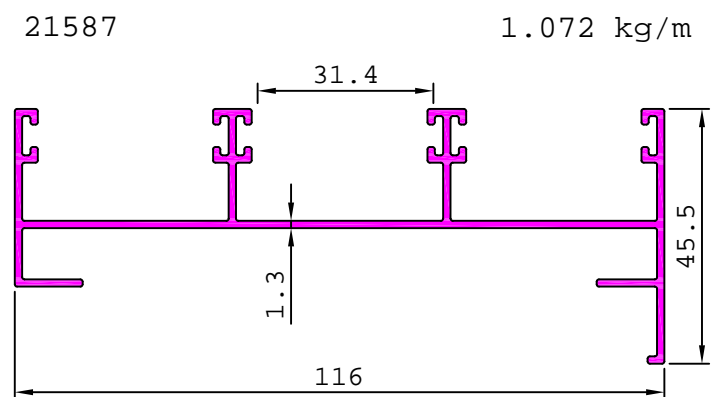
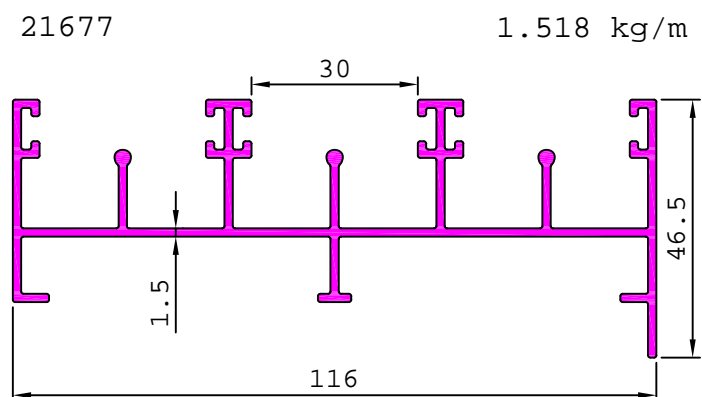
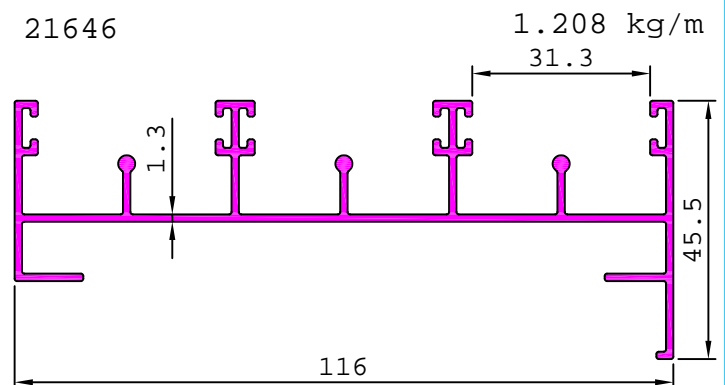
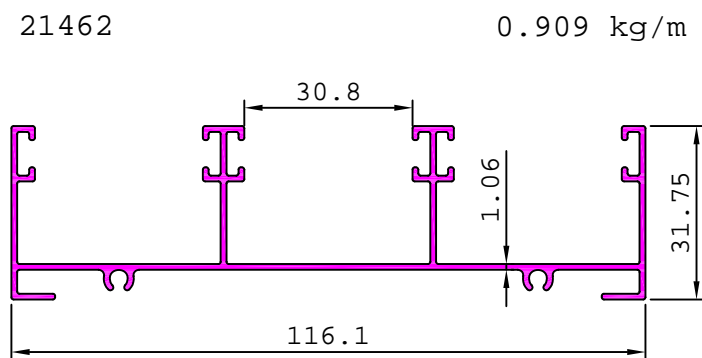
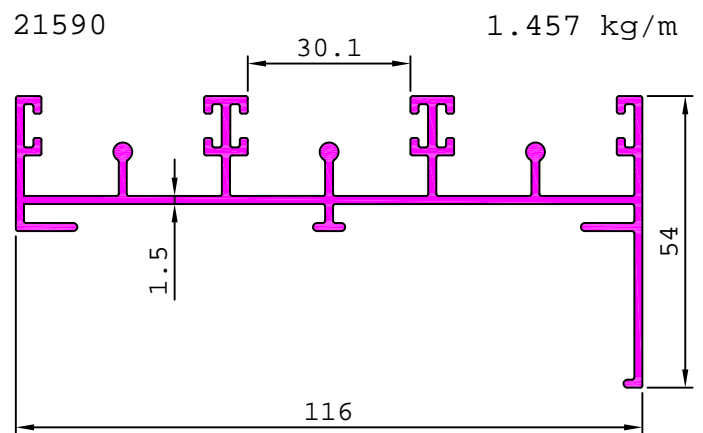
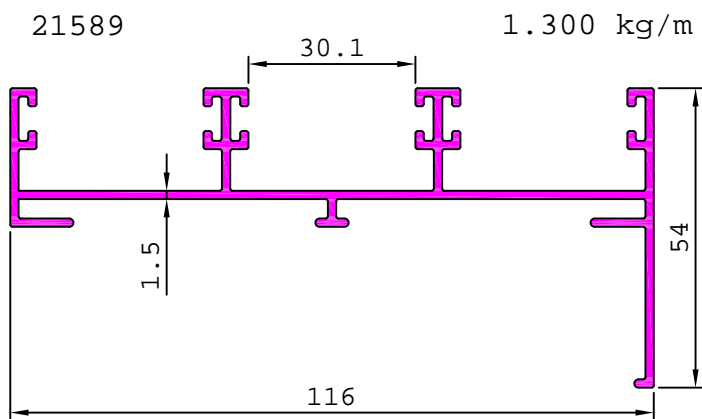
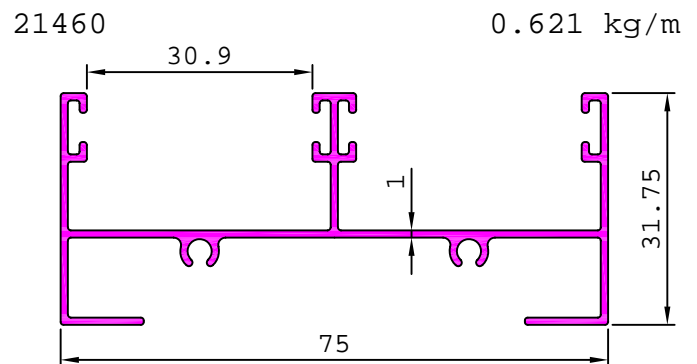
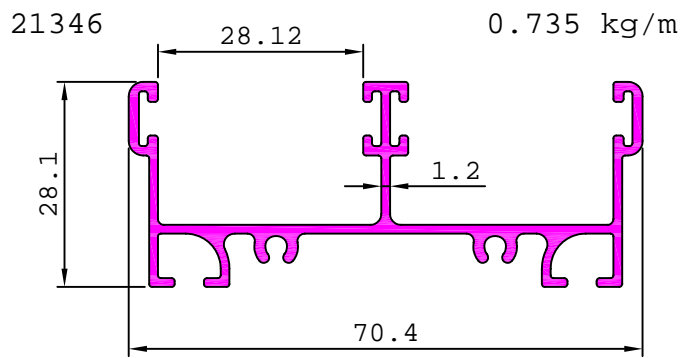

ARCHITECTURAL

DETAILS OF SLIDING WINDOW SECTIONS SERIES - D (SHUTTER SECTION - 25 mm.)

21676

1.323 kg/m

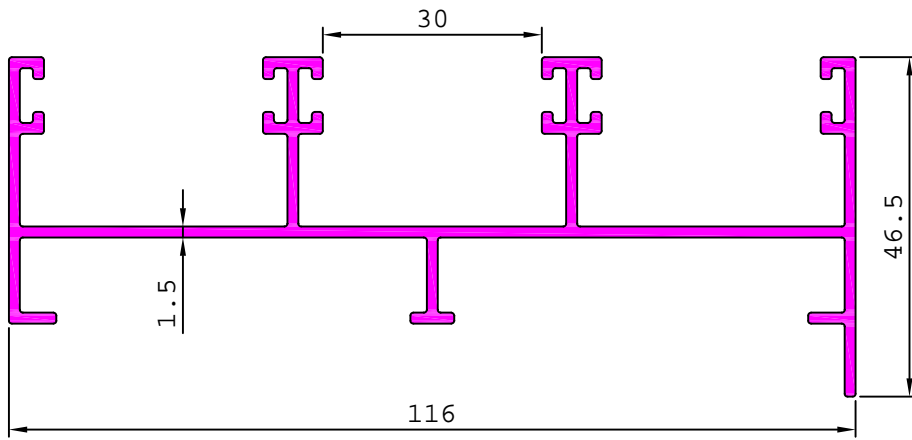

20799

2.339 kg/m

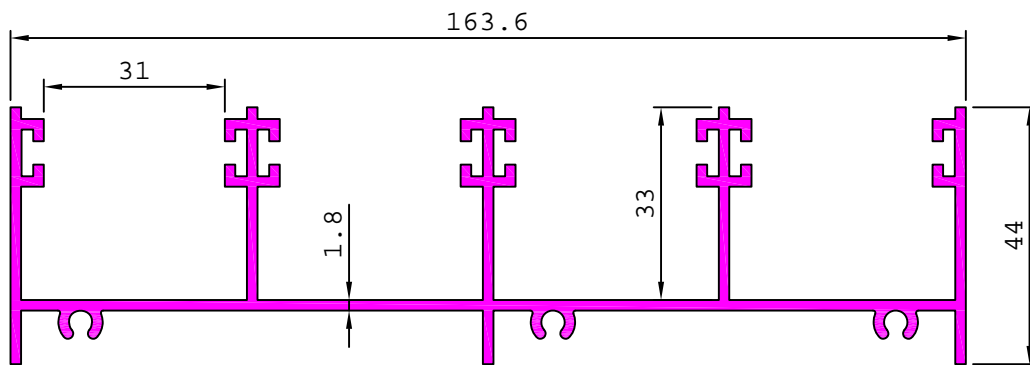

20800

3.160 kg/m

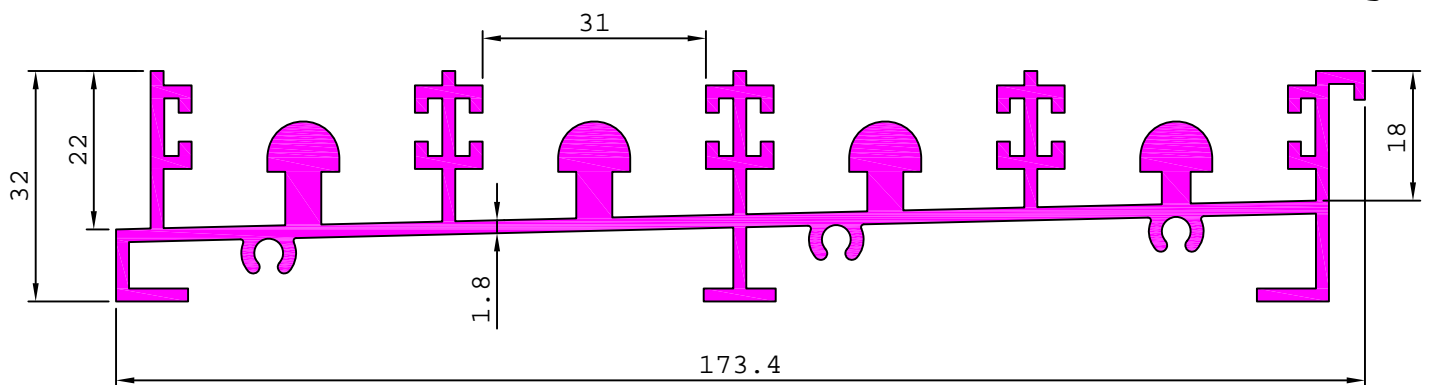

21570

1.733 kg/m

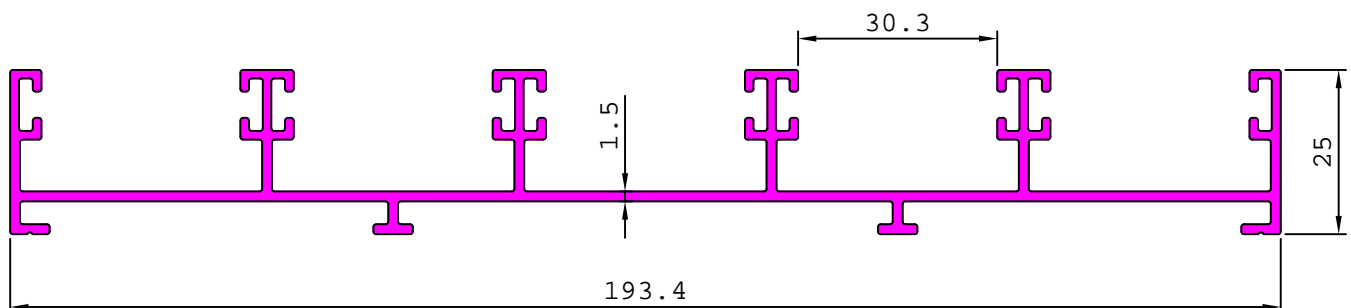

ARCHITECTURAL

DETAILS OF SLIDING WINDOW SECTIONS SERIES - D (SHUTTER SECTION - 25 mm.)

21571

2.026 kg/m

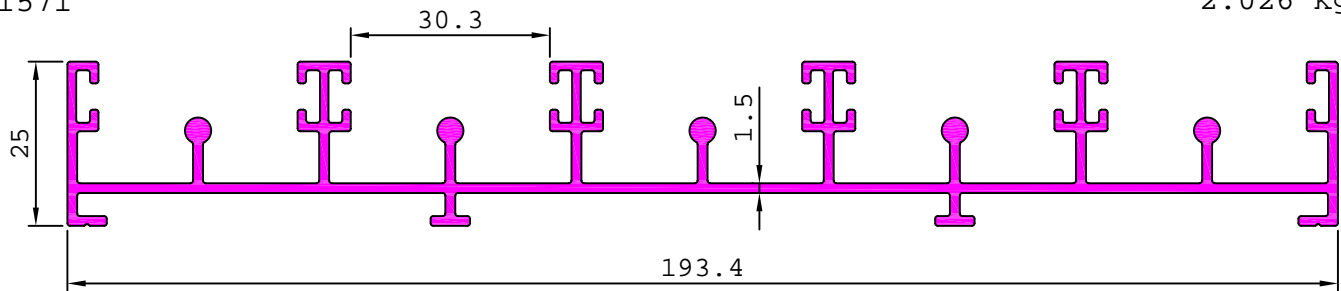

S5150

0.806 kg/m

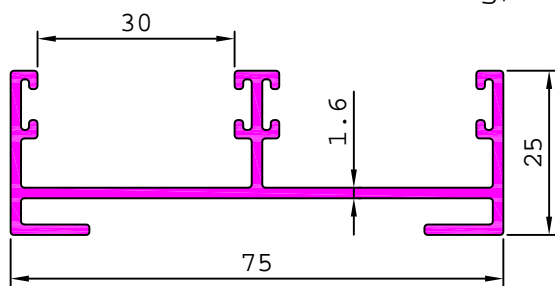

S5151

1.039 kg/m

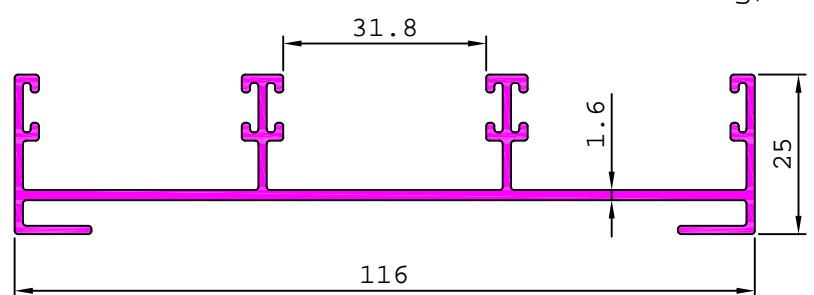

S5155

1.135 kg/m

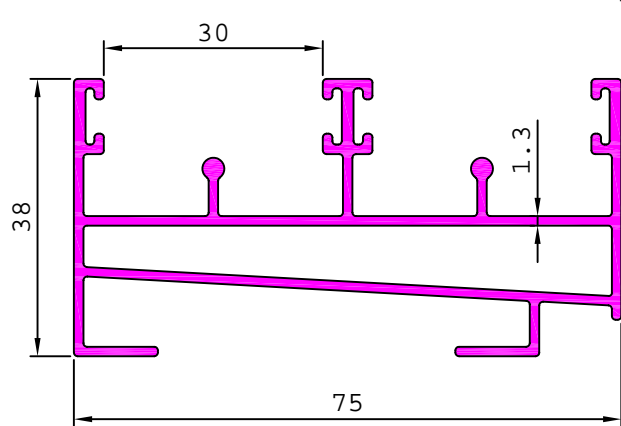

S5156

1.673 kg/m

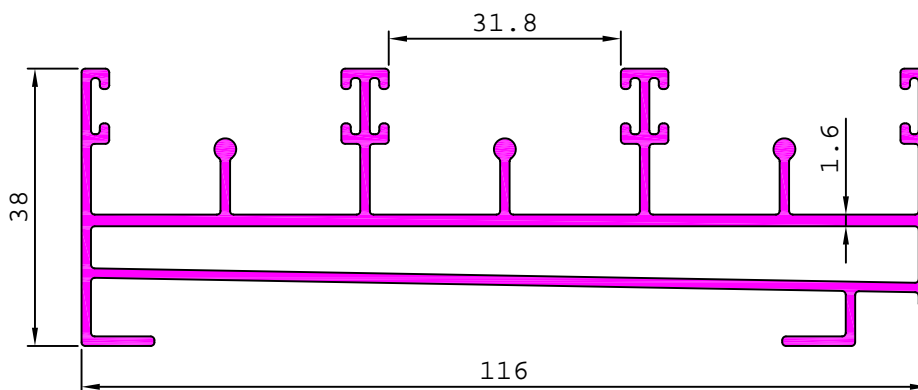

ARCHITECTURAL

DETAILS OF SLIDING WINDOW SECTIONS SERIES - E (SHUTTER SECTION - 30 mm.)

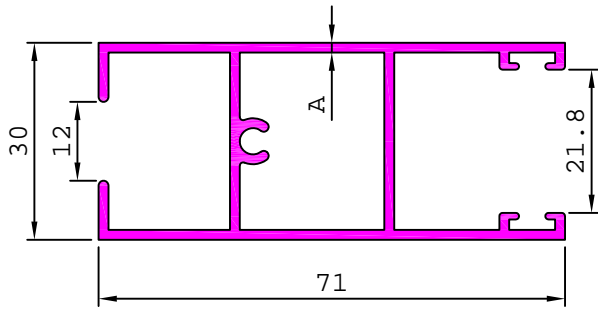

SL. No.	Section No.	A	Weight kg/m
1	20993	1.31	0.839
2	20772	1.50	0.948

20549 0.809 kg/m

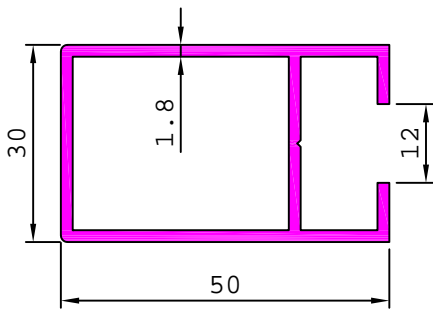

20859 0.775 kg/m

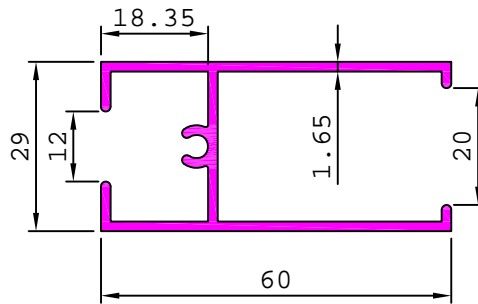

20553 0.731 kg/m

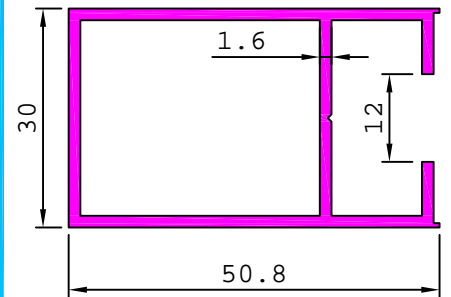

20979 0.950 kg/m

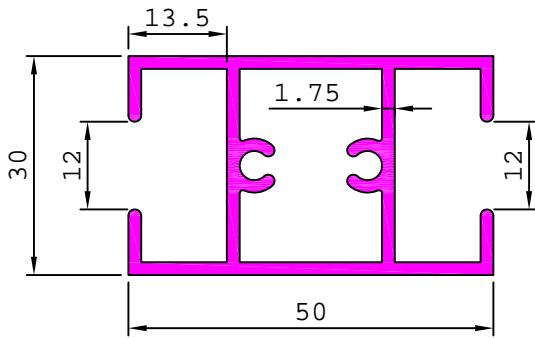

21008 0.762 kg/m

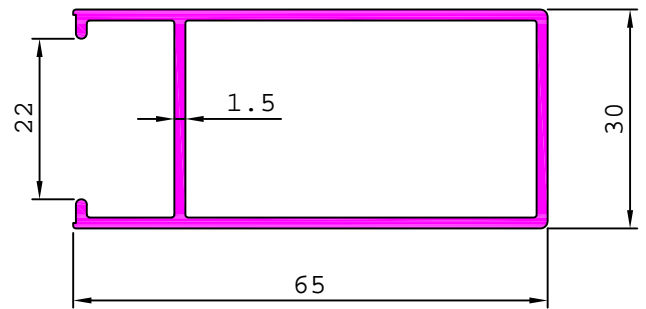

21010 0.995 kg/m

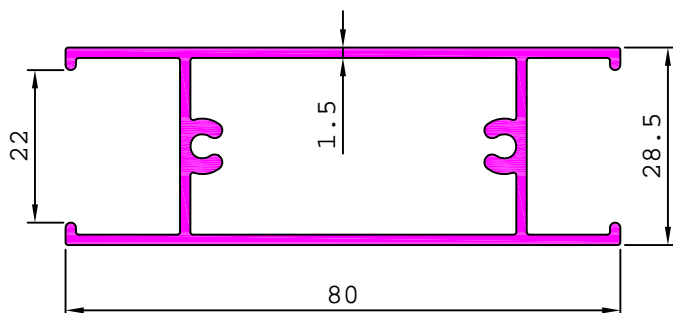

21246 1.305 kg/m

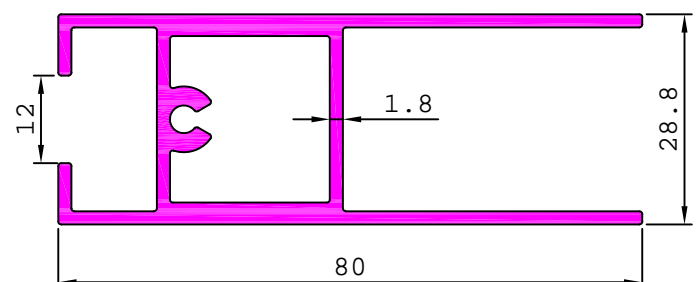

ARCHITECTURAL

DETAILS OF SLIDING WINDOW SECTIONS SERIES - E (SHUTTER SECTION - 30 mm.)

21197 1.071 kg/m

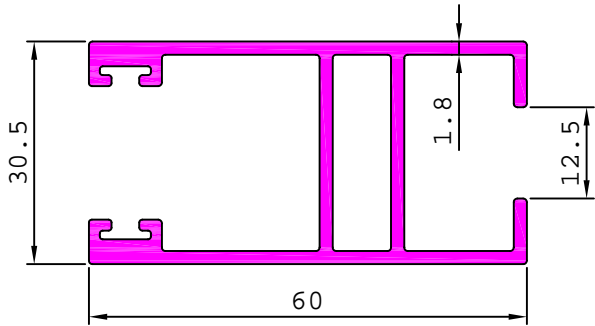

21345 1.010 kg/m

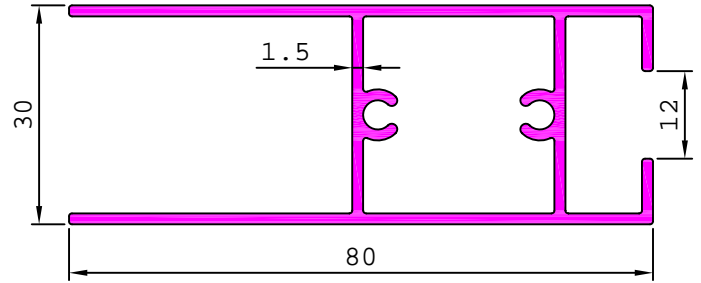

21412 0.592 kg/m

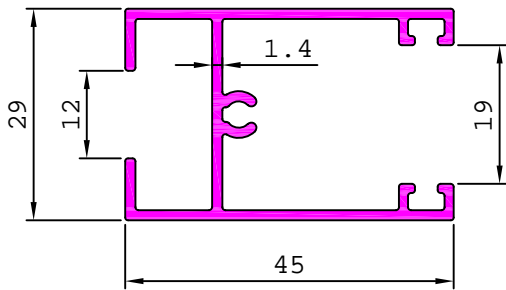

21414 0.705 kg/m

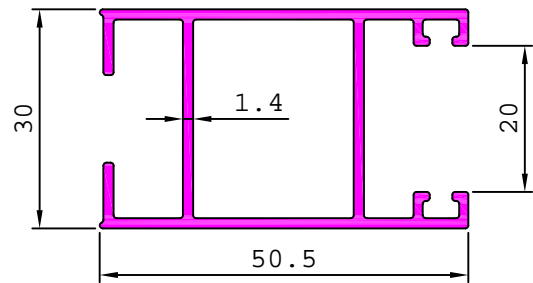

21543 0.699 kg/m

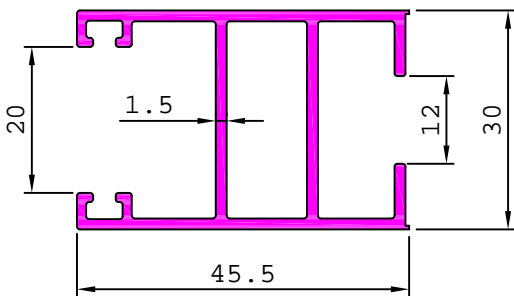

21491 1.434 kg/m

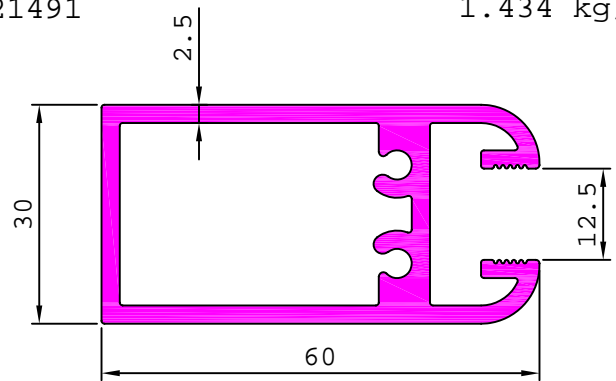

21492 1.720 kg/m

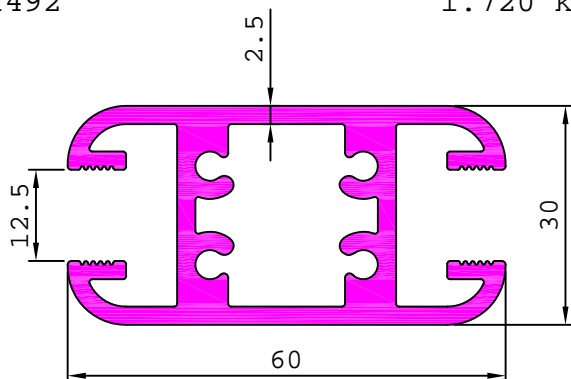

21343 0.793 kg/m

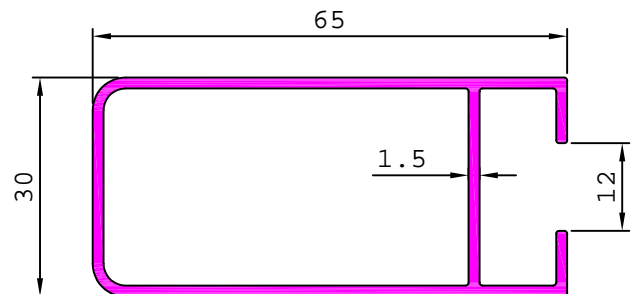

ARCHITECTURAL

DETAILS OF SLIDING WINDOW SECTIONS SERIES - E (SHUTTER SECTION - 30 mm.)

21675

0.766 kg/m

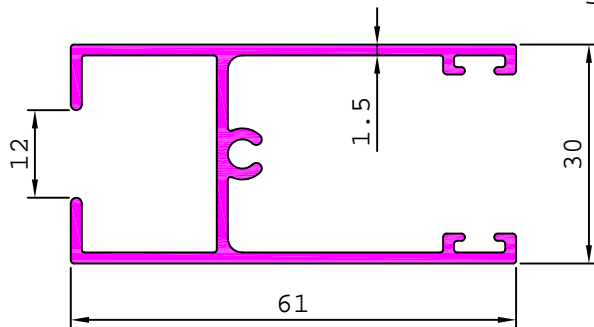

21702

0.999 kg/m

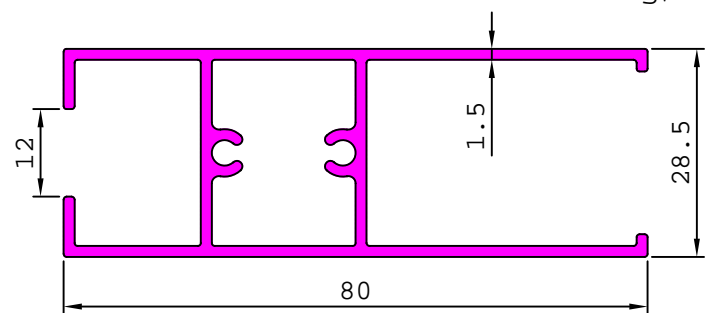

ARCHITECTURAL

DETAILS OF SLIDING WINDOW SECTIONS SERIES - E (SHUTTER SECTION - 30 mm.)

20550 0.994 kg/m

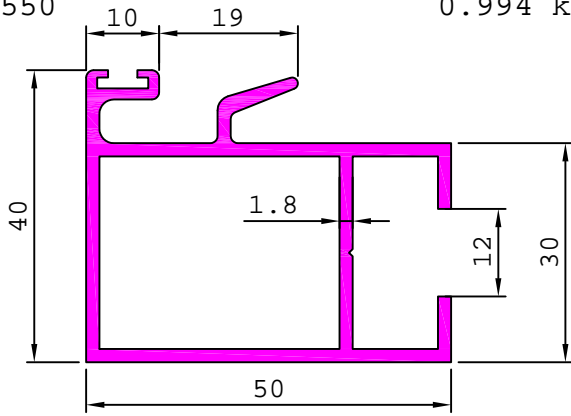

20555 0.869 kg/m

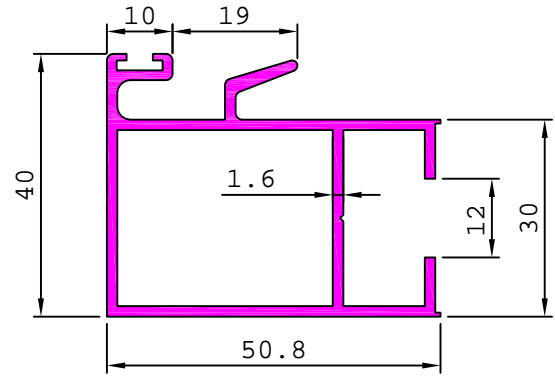

21009 0.964 kg/m

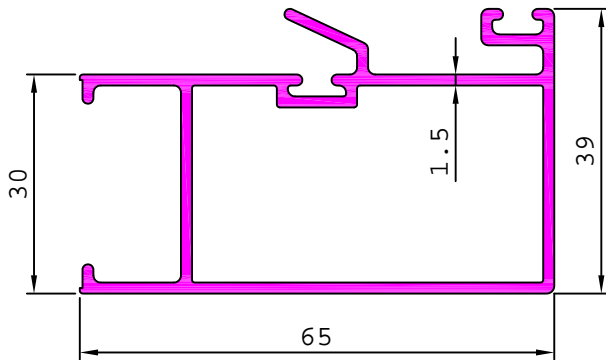

21182 1.208 kg/m

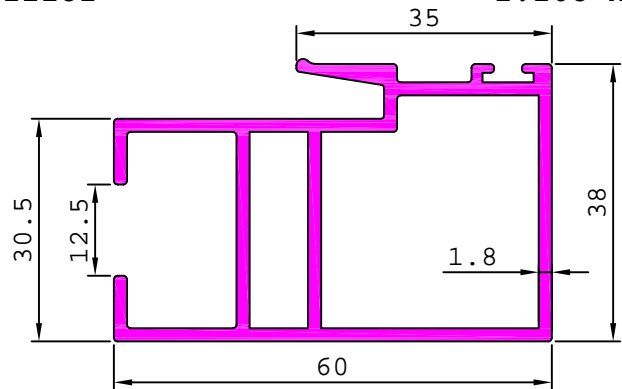

21397 0.646 kg/m

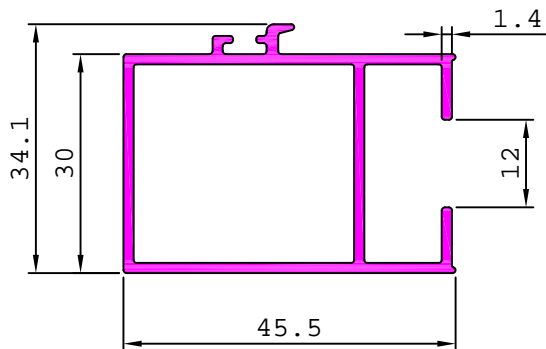

21344 0.938 kg/m

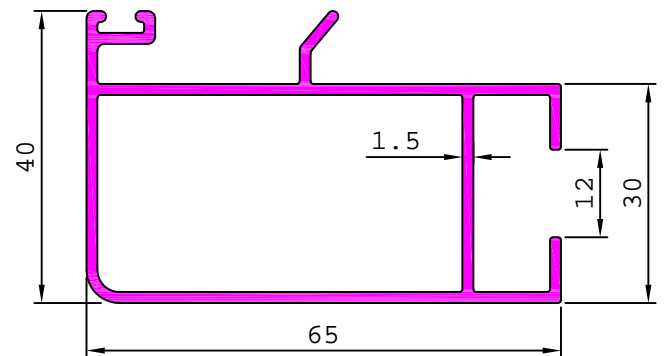

21592 0.925 kg/m

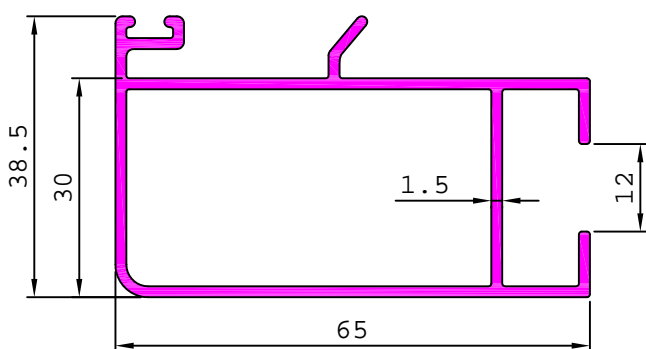

S4782 1.497 kg/m

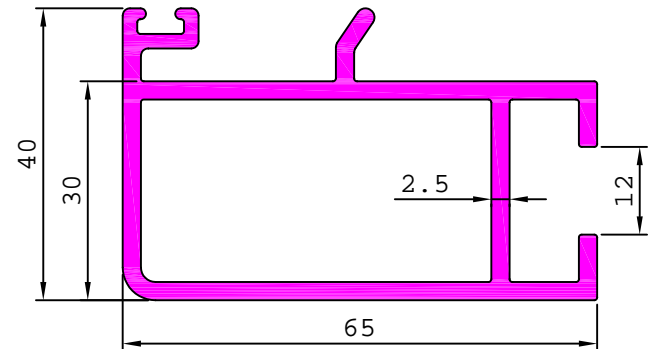

ARCHITECTURAL

DETAILS OF SLIDING WINDOW SECTIONS SERIES - E (SHUTTER SECTION - 30 mm.)

21717

0.955 kg/m

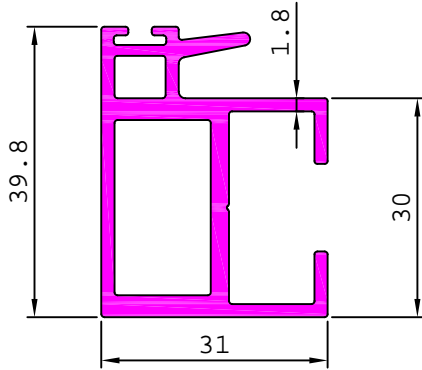

ARCHITECTURAL

DETAILS OF SLIDING WINDOW SECTIONS SERIES - E (SHUTTER SECTION - 30 mm.)

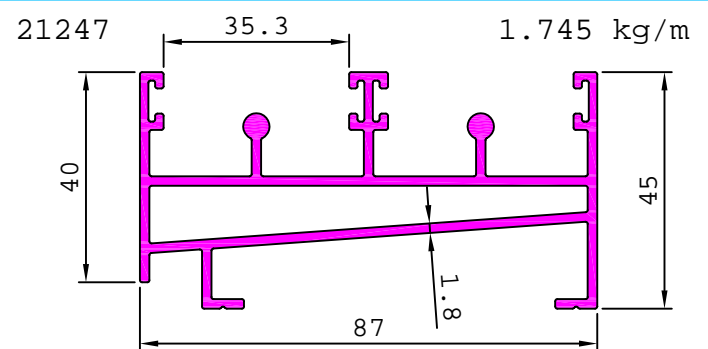
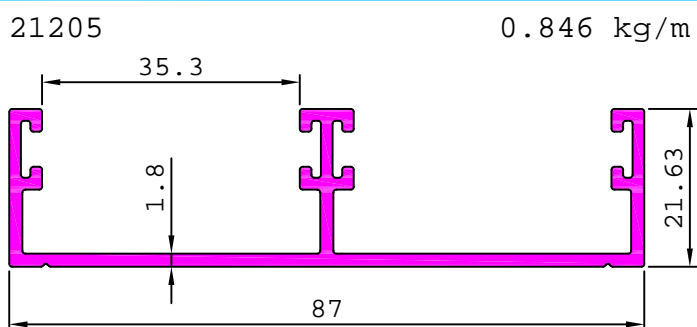
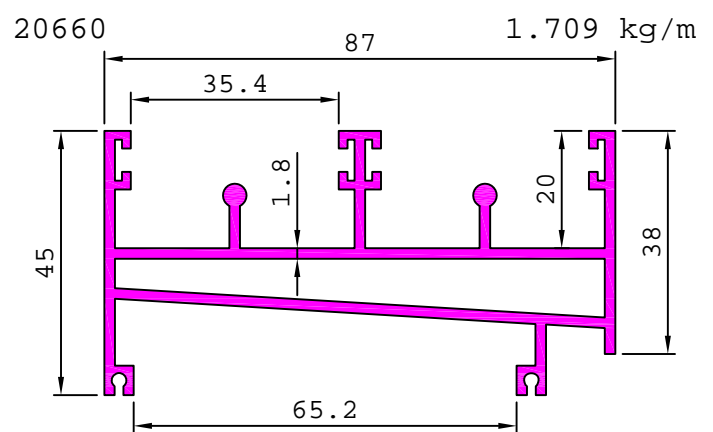
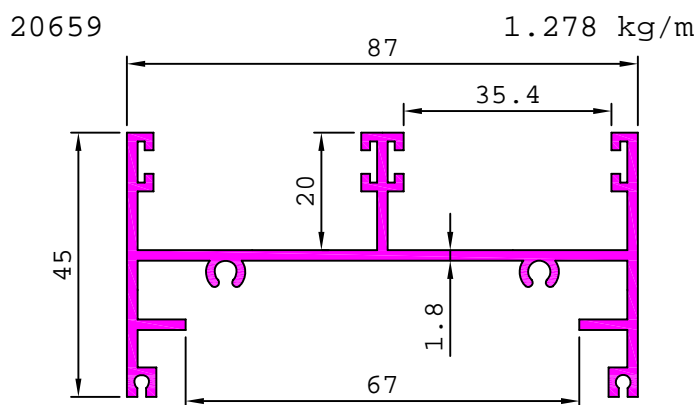
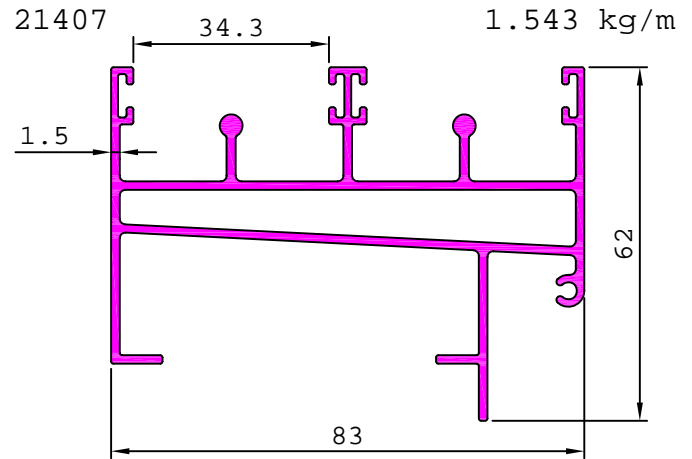
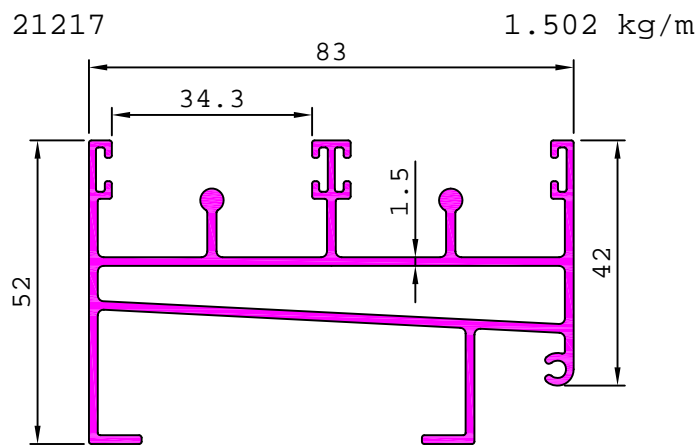
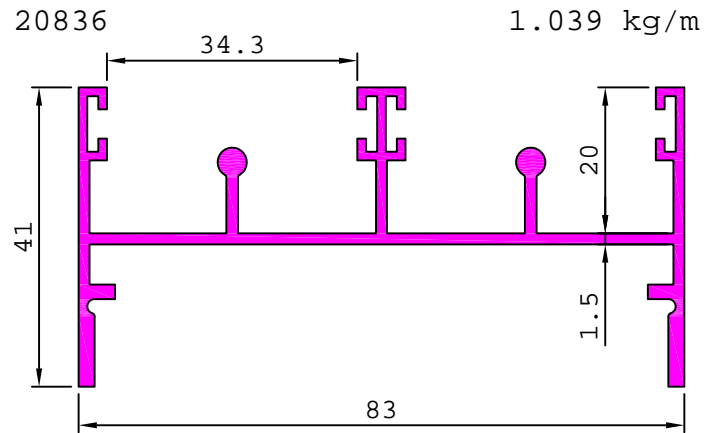
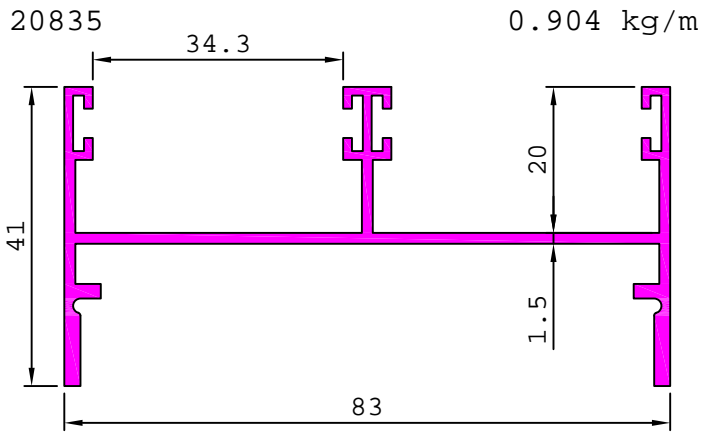

ARCHITECTURAL

DETAILS OF SLIDING WINDOW SECTIONS SERIES - E (SHUTTER SECTION - 30 mm.)

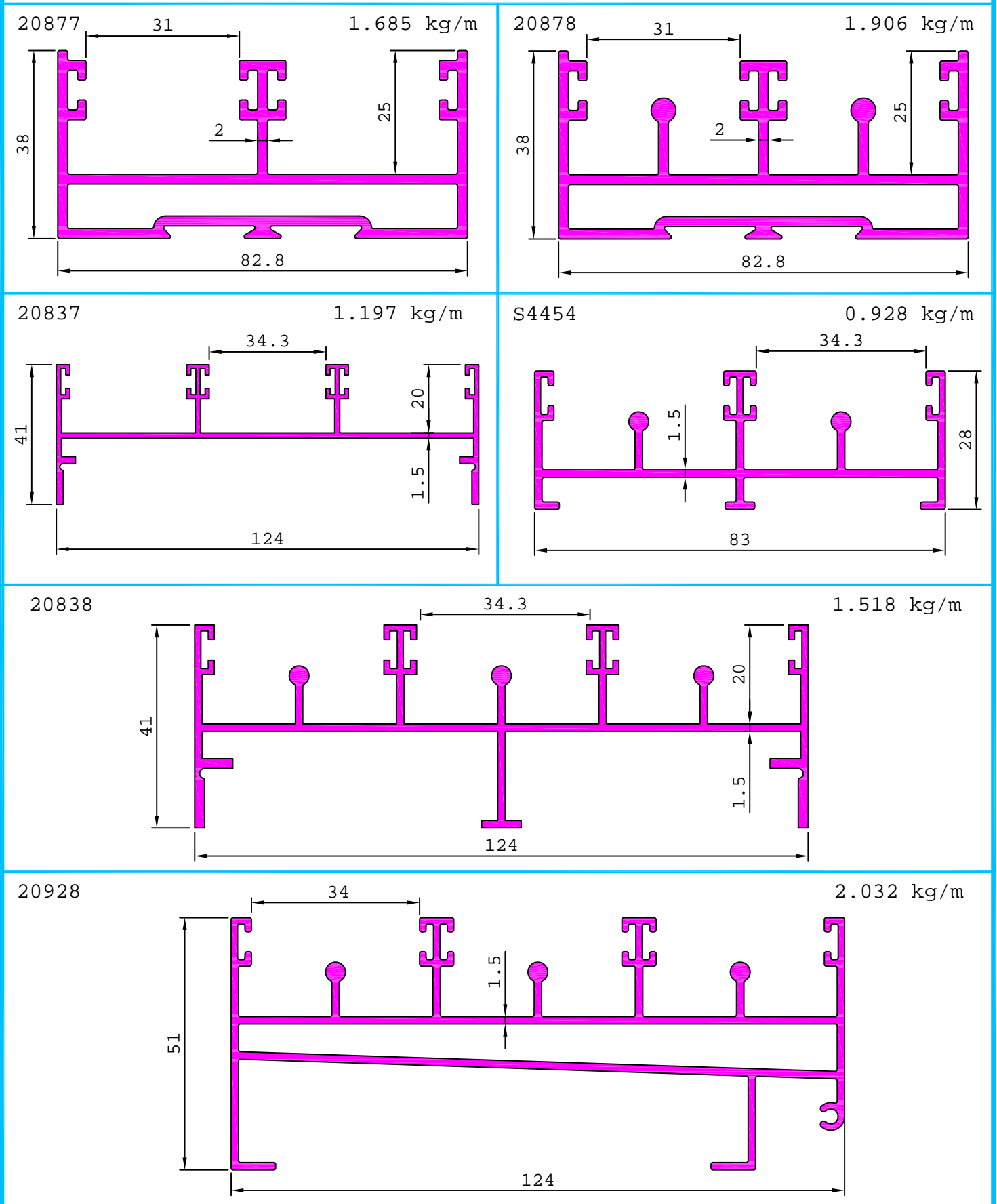

ARCHITECTURAL

DETAILS OF SLIDING WINDOW SECTIONS SERIES - E (SHUTTER SECTION - 30 mm.)

S4455

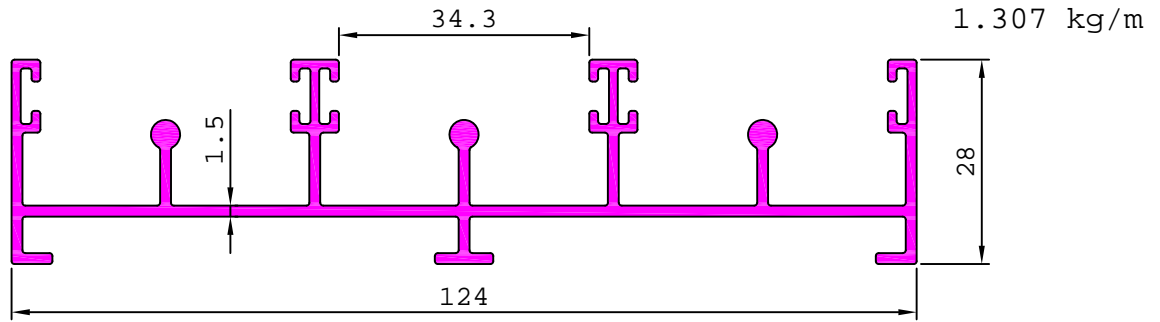

21203

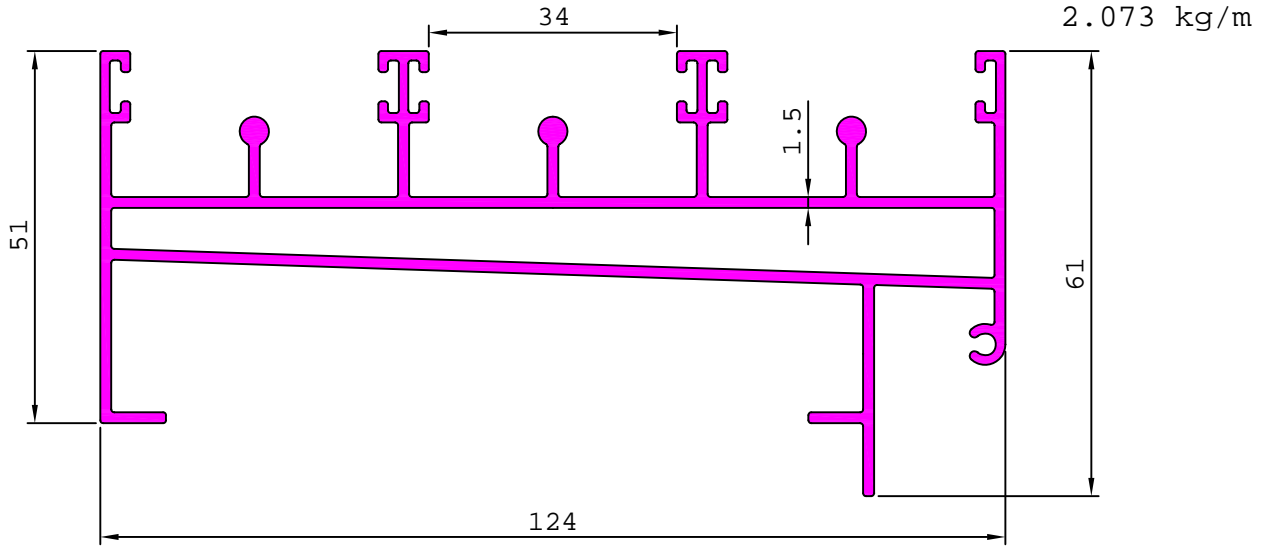

20631

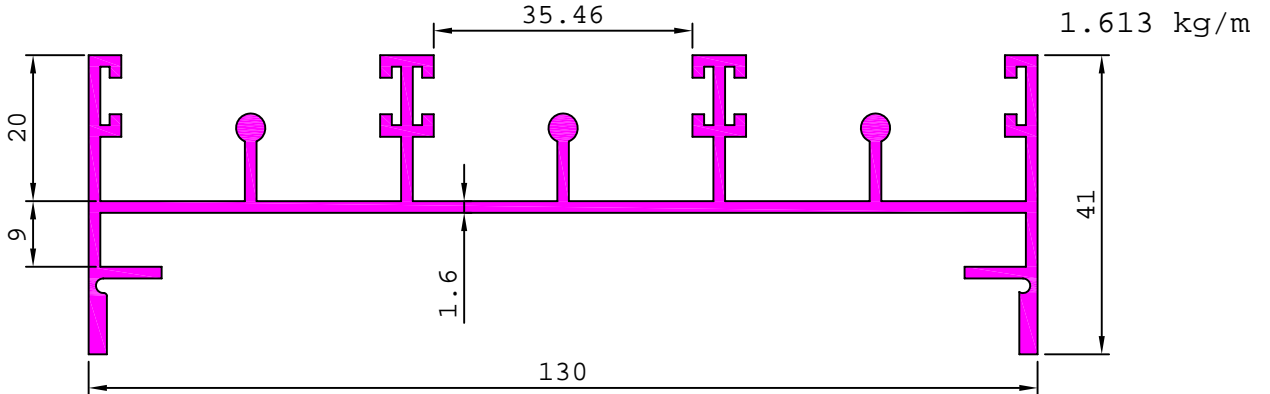

20632

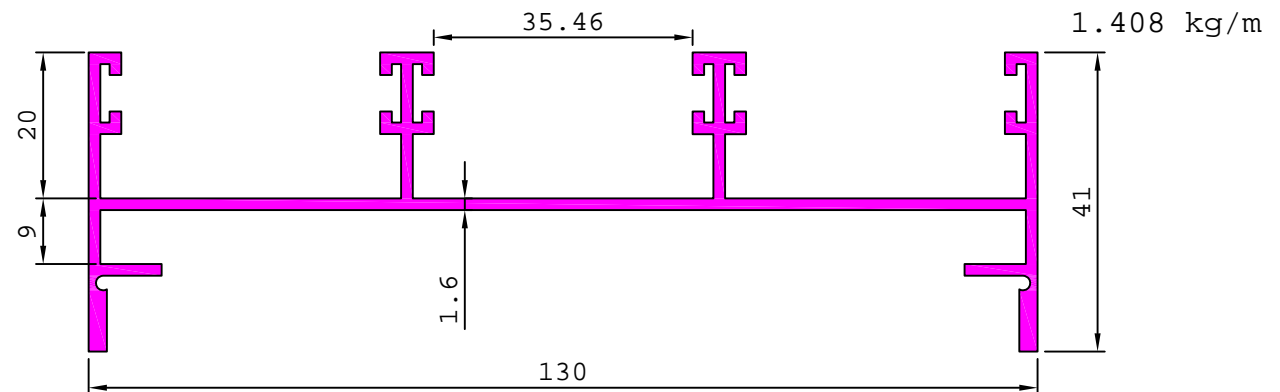

ARCHITECTURAL

DETAILS OF SLIDING WINDOW SECTIONS SERIES - E (SHUTTER SECTION - 30 mm.)

21206

1.223 kg/m

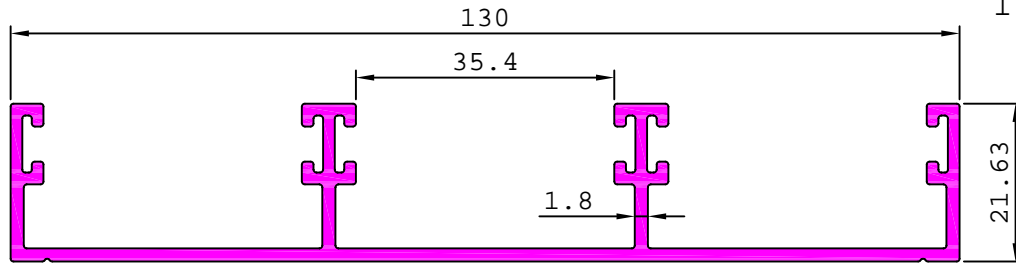

21243

2.586 kg/m

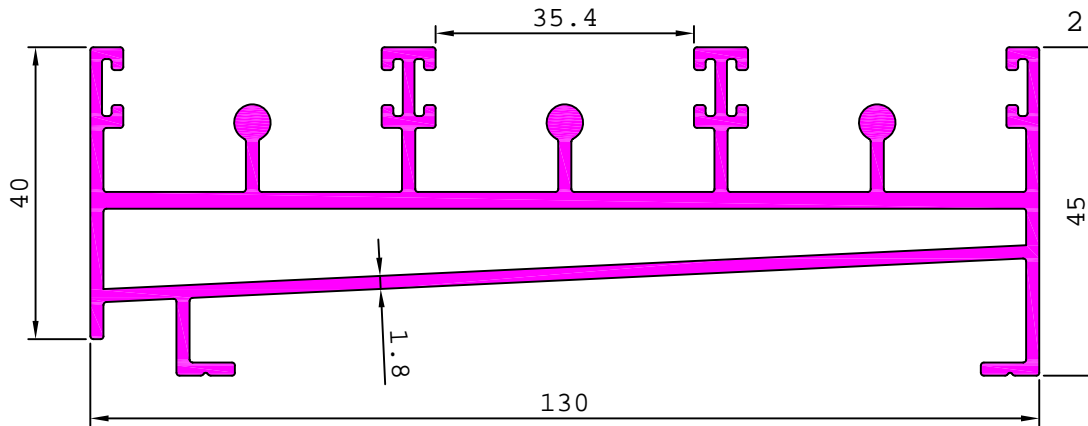

21198

3.197 kg/m

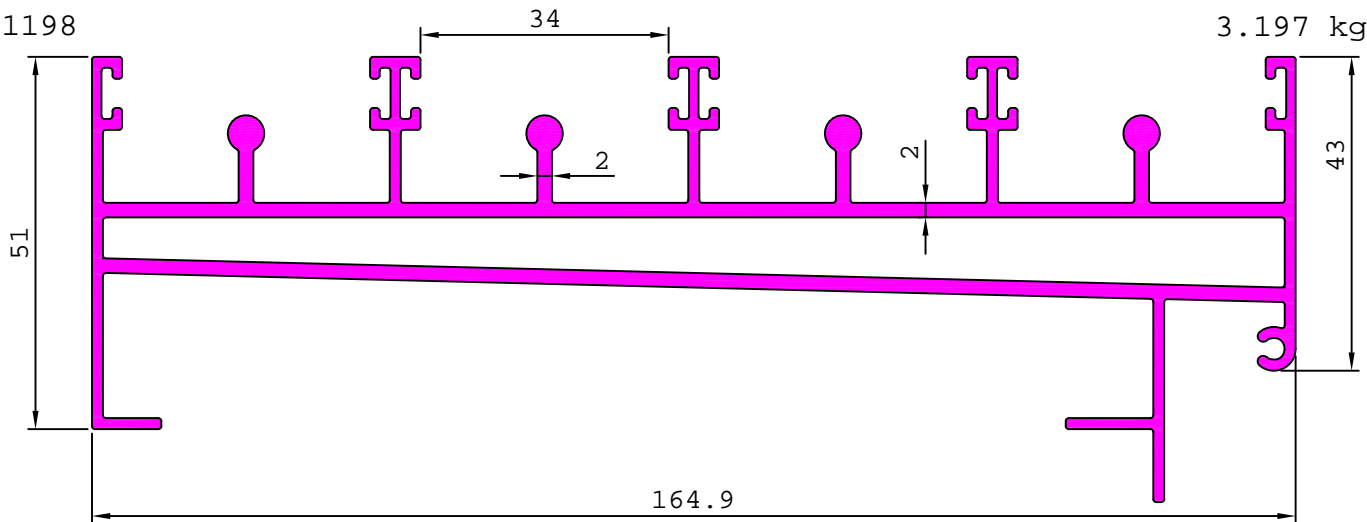

21204

1.694 kg/m

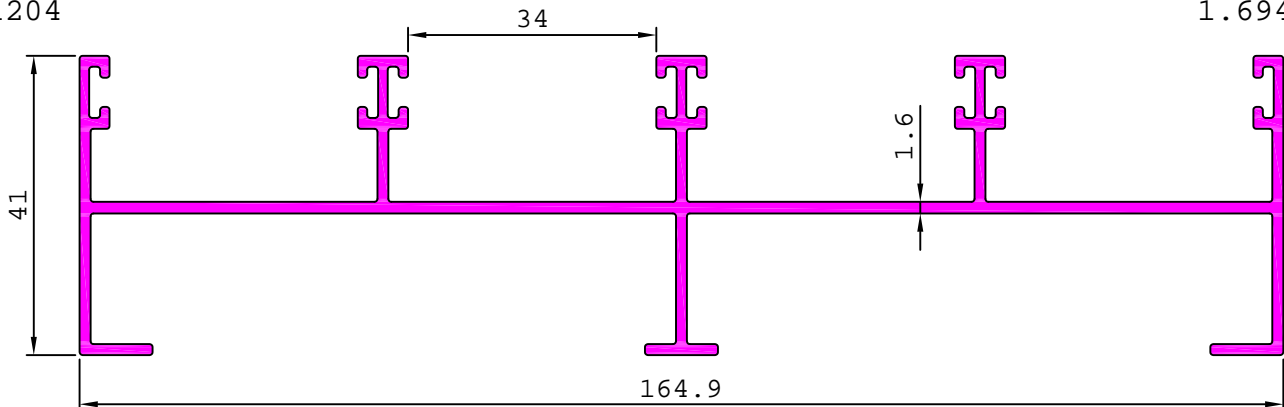

ARCHITECTURAL

DETAILS OF SLIDING WINDOW SECTIONS SERIES - E (SHUTTER SECTION - 30 mm.)

21245

1.597 kg/m

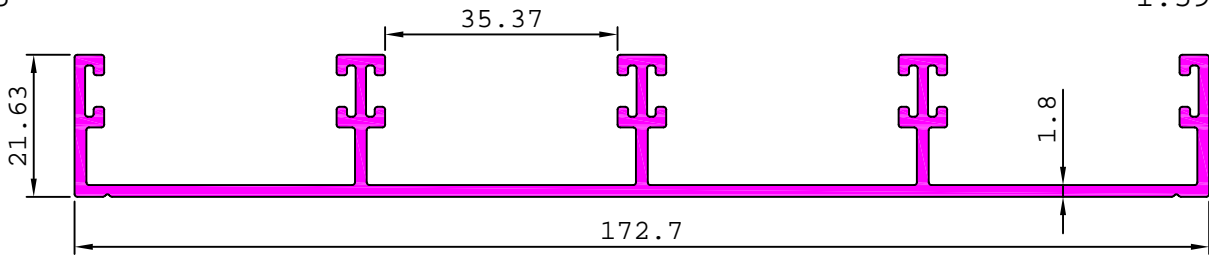

21244

3.415 kg/m

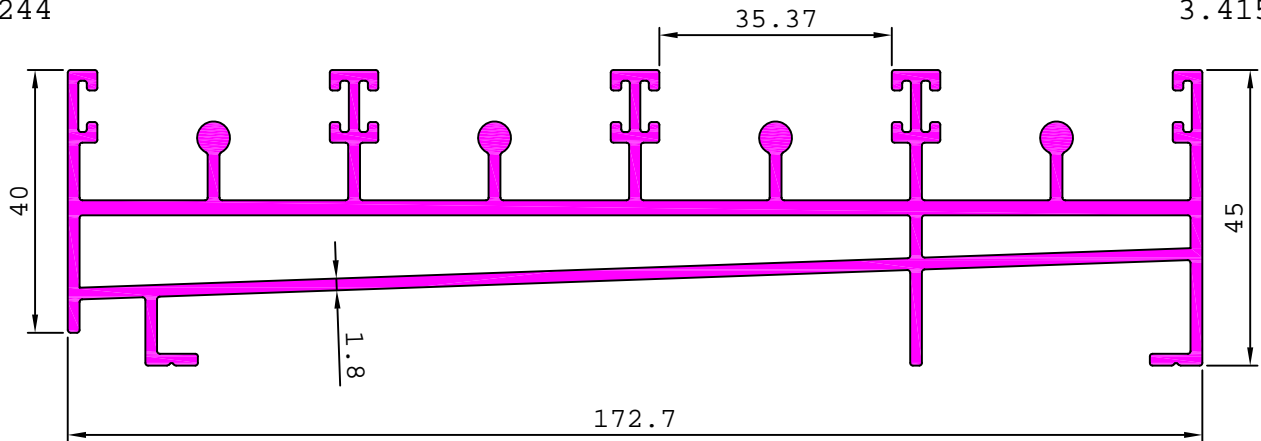

21175

2.298 kg/m

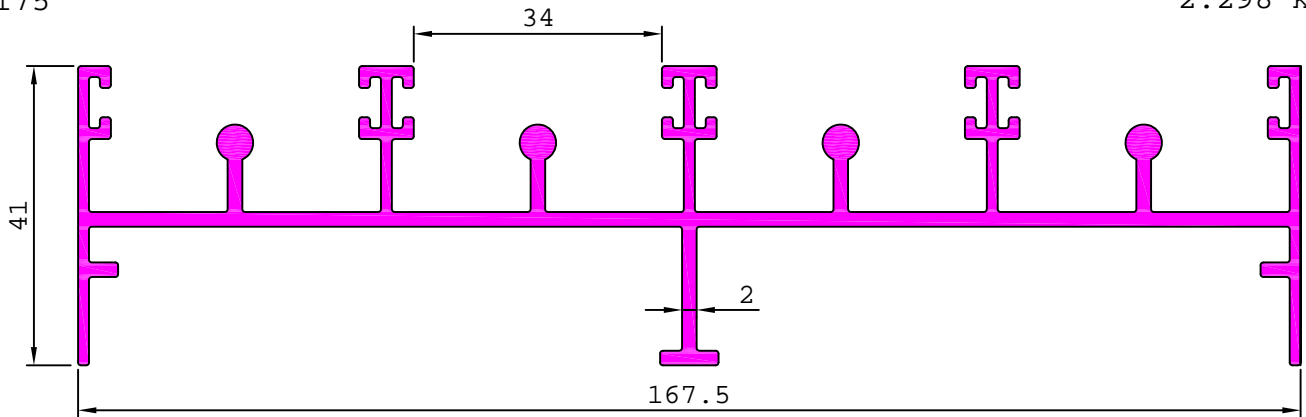

21176

1.745 kg/m

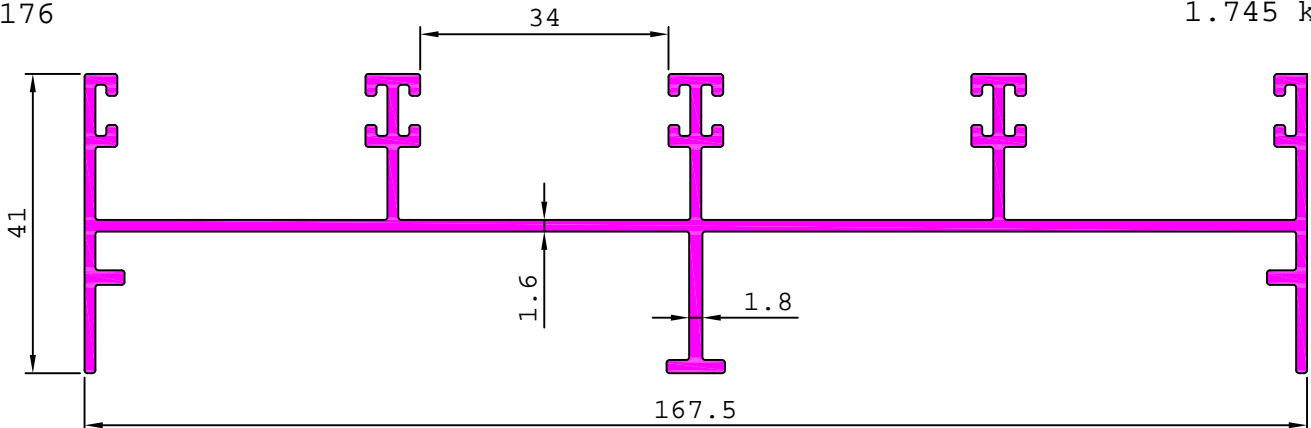

ARCHITECTURAL

DETAILS OF SLIDING WINDOW SECTIONS SERIES - E (SHUTTER SECTION - 30 mm.)

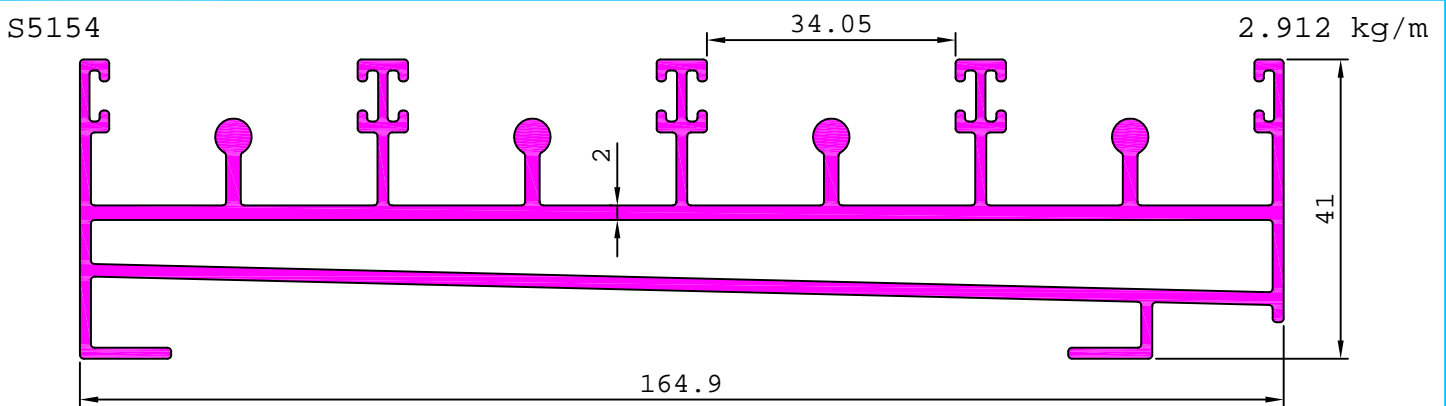
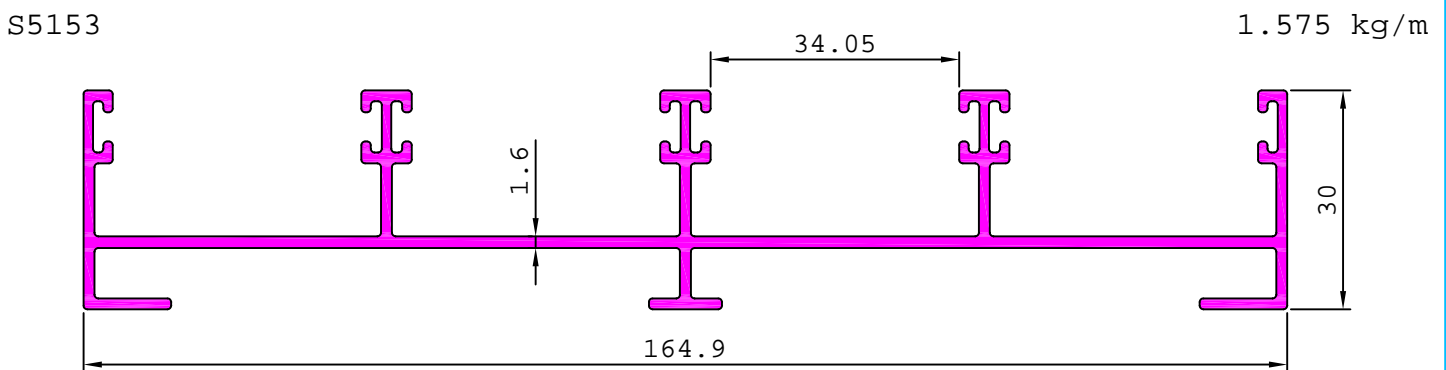
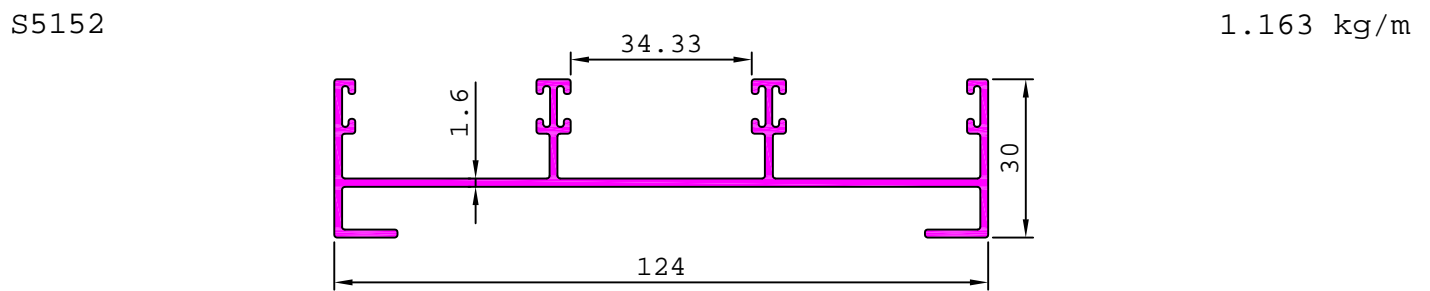
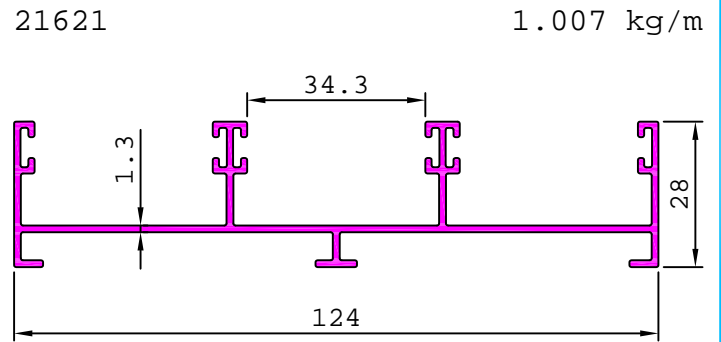
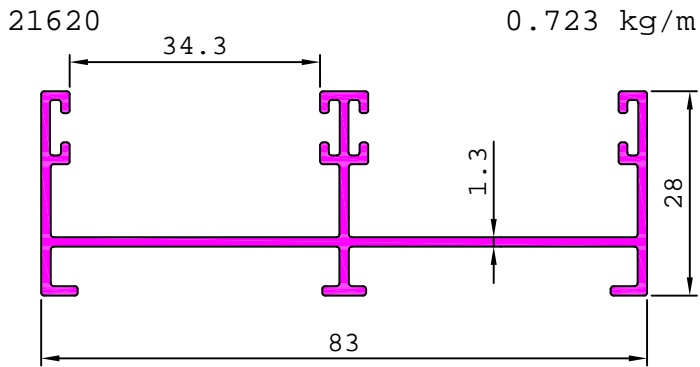

ARCHITECTURAL

DETAILS OF SLIDING WINDOW SECTIONS SERIES - E (SHUTTER SECTION - 30 mm.)

S5157

1.923 kg/m

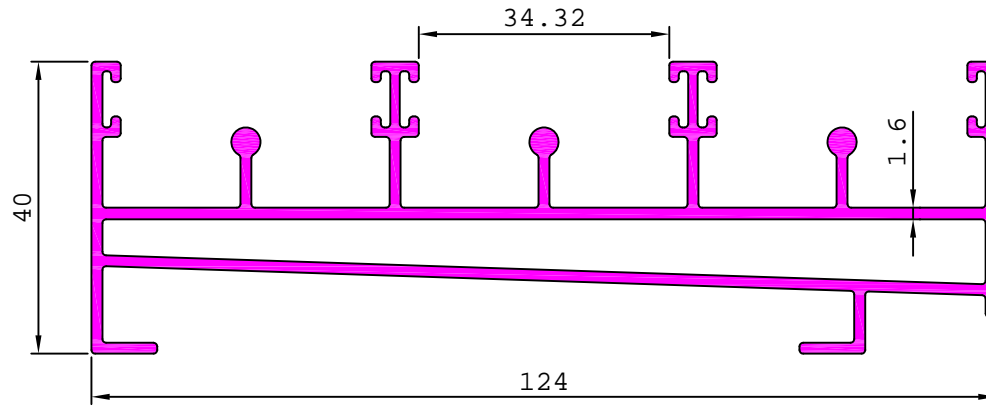

ARCHITECTURAL

DETAILS OF SLIDING WINDOW SECTIONS SERIES - E (SHUTTER SECTION - 35 mm.)

S4615 0.890 kg/m

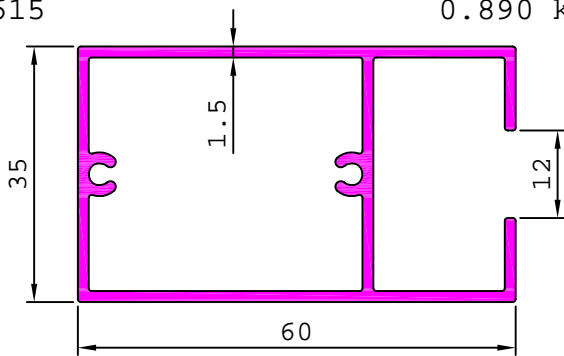

S4617 0.938 kg/m

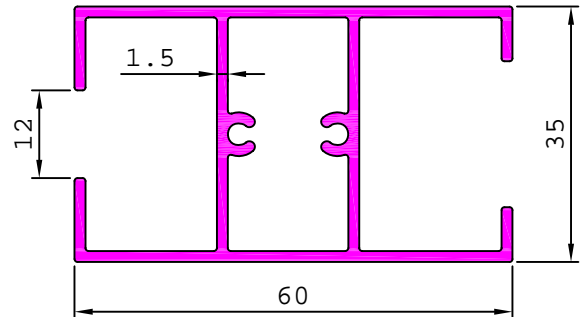

S4616 1.026 kg/m

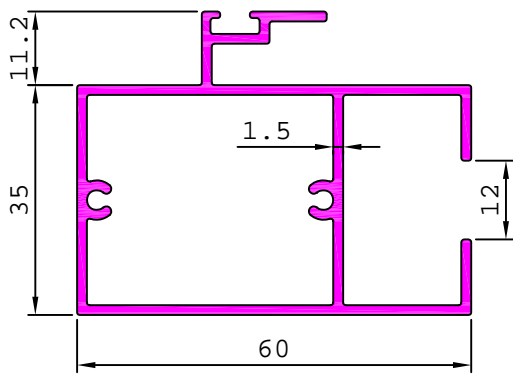

S4619 1.026 kg/m

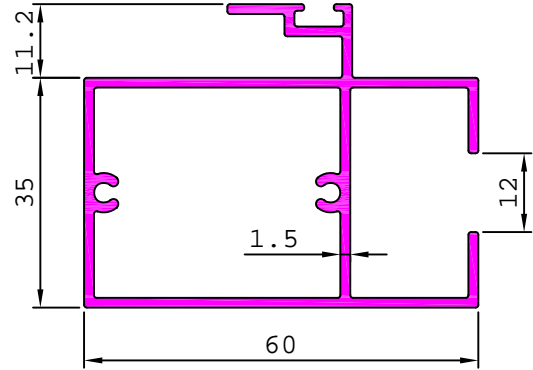

S4618 1.162 kg/m

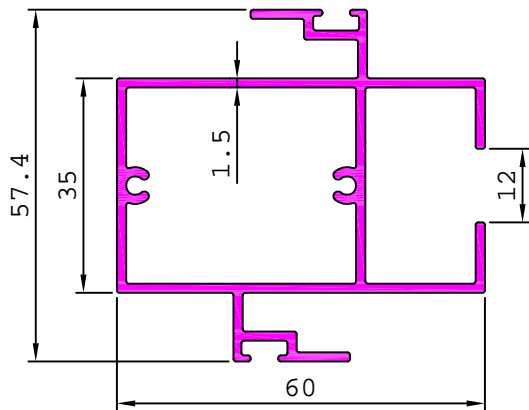

ARCHITECTURAL

DETAILS OF SLIDING WINDOW SECTIONS SERIES - E (SHUTTER SECTION - 35 mm.)

S4613

1.640 kg/m

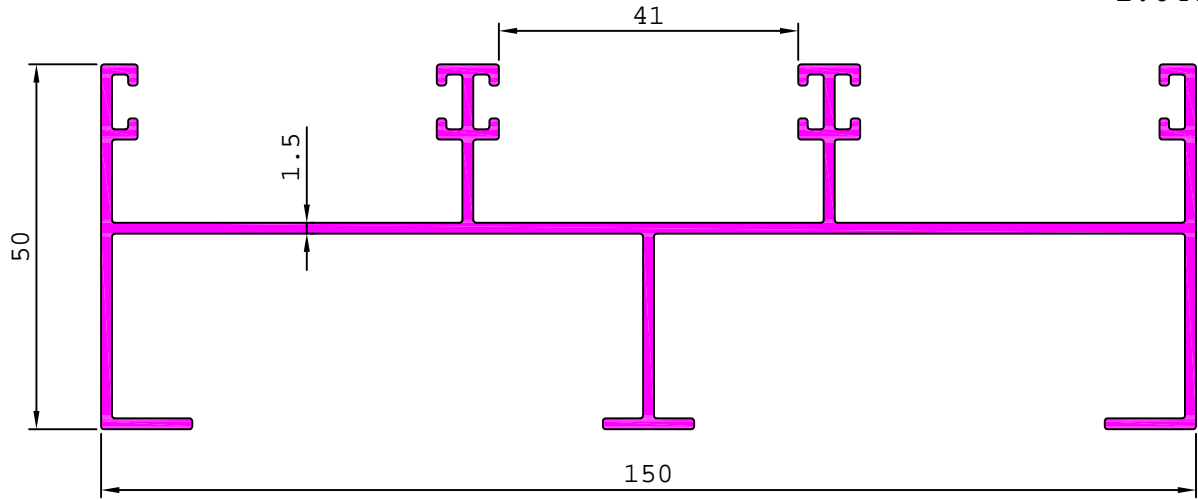

S4614

1.852 kg/m

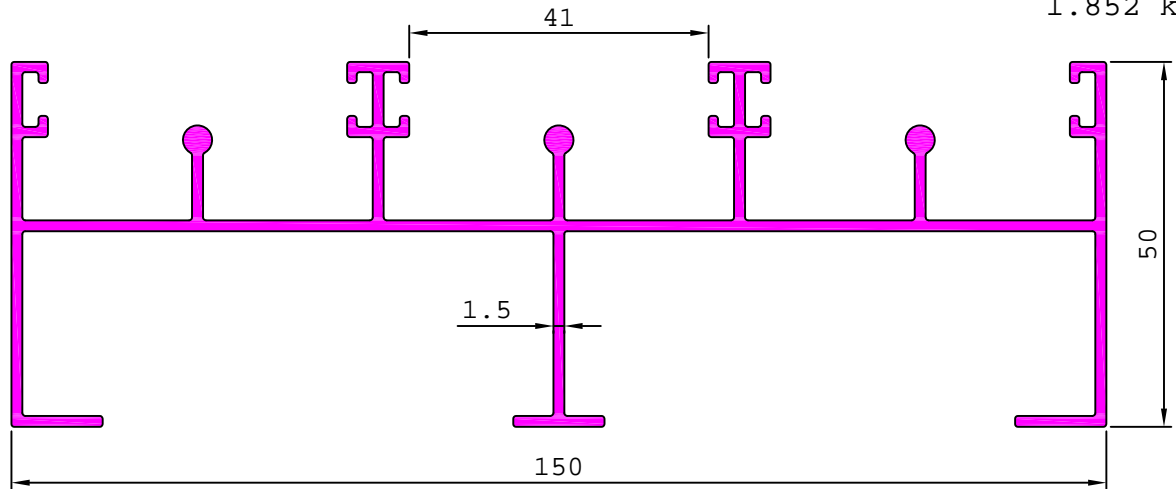

ARCHITECTURAL

DETAILS OF SLIDING WINDOW SECTIONS SERIES - F (SHUTTER SECTION - 40 mm.)

21248

3.950 kg/m

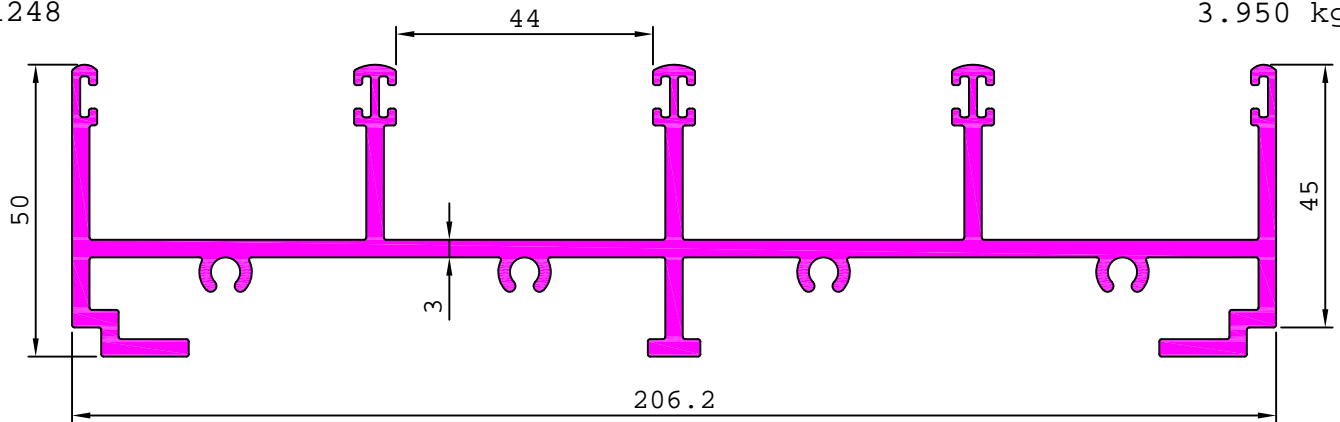

21249

6.961 kg/m

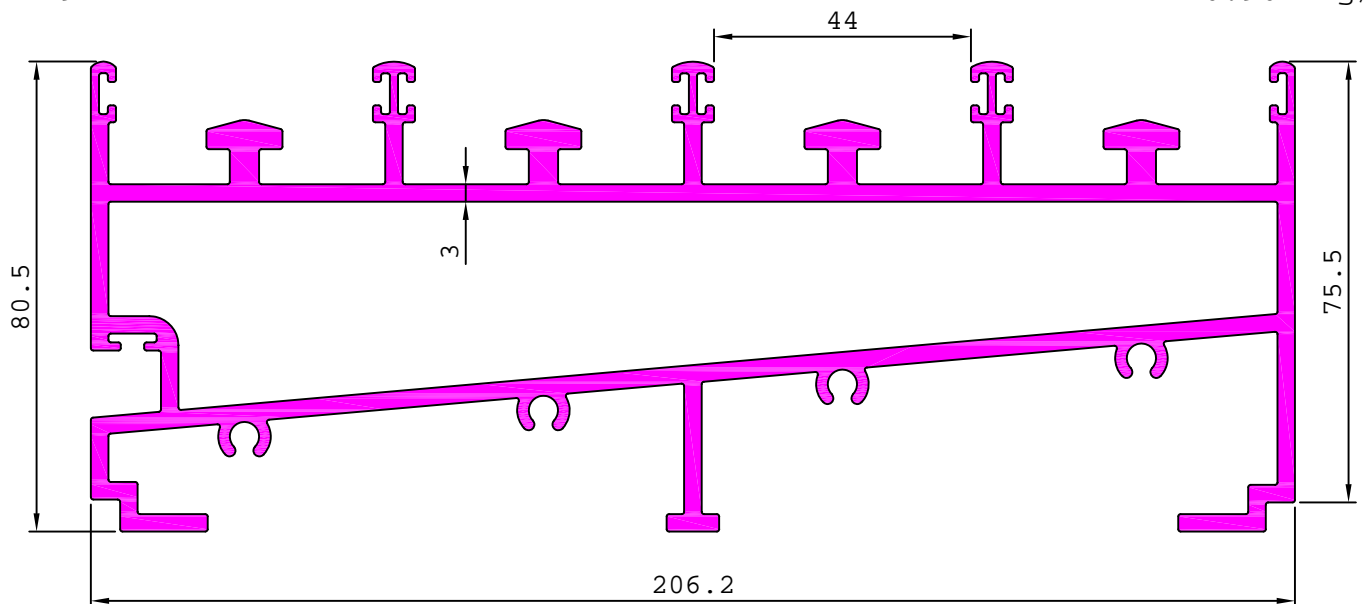

ARCHITECTURAL

DETAILS OF SLIDING WINDOW SECTIONS SERIES - H (SHUTTER SECTION - 55 mm.)

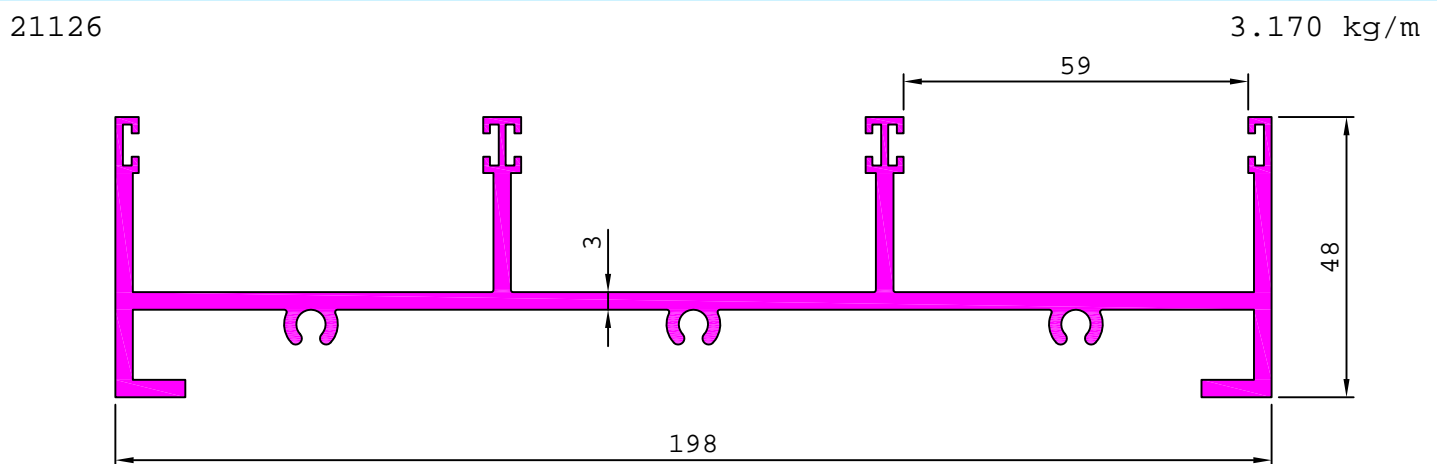
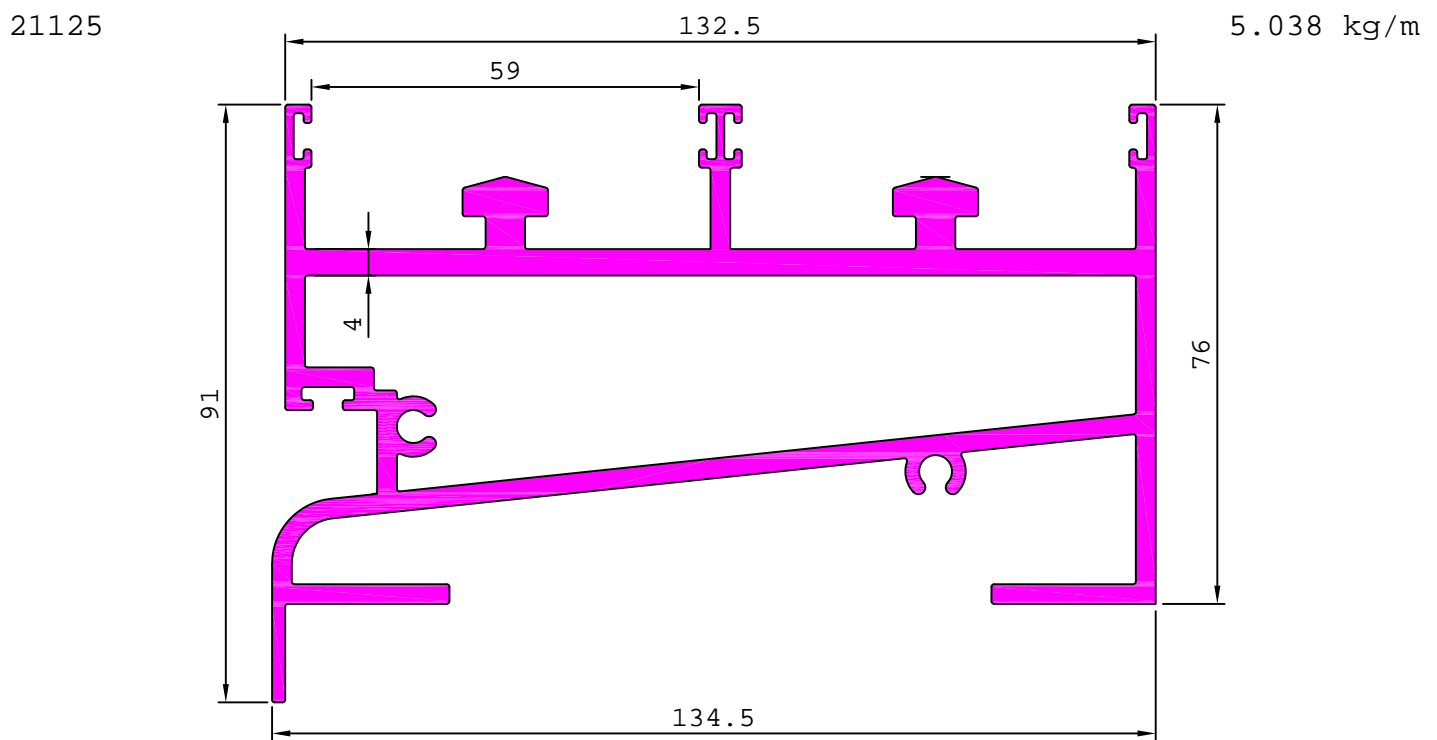
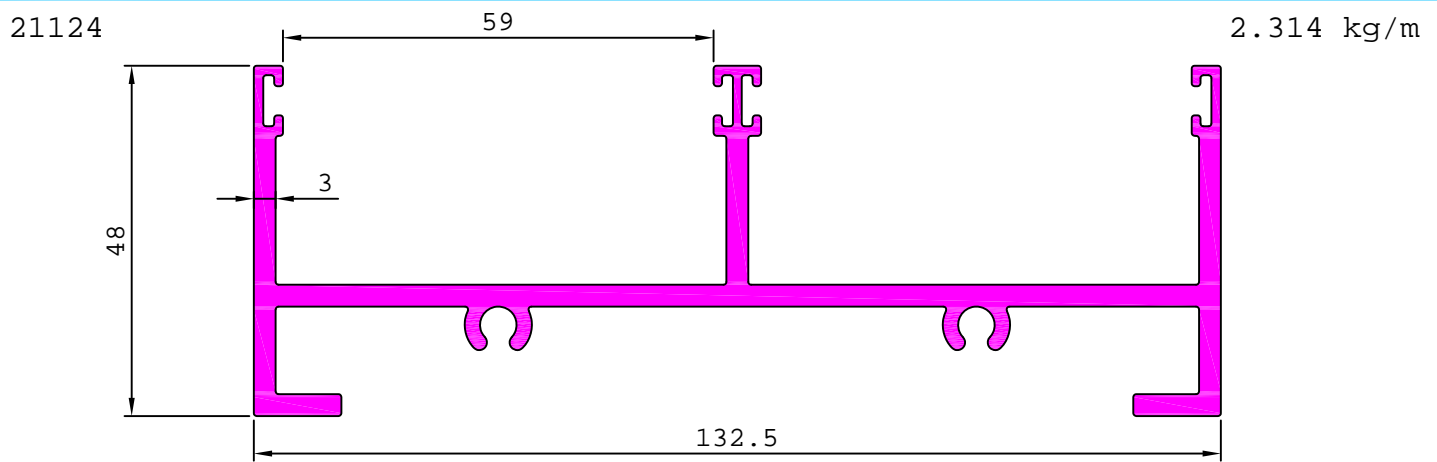

ARCHITECTURAL

DETAILS OF SLIDING WINDOW SECTIONS SERIES - H (SHUTTER SECTION - 55 mm.)

21127

6.800 kg/m

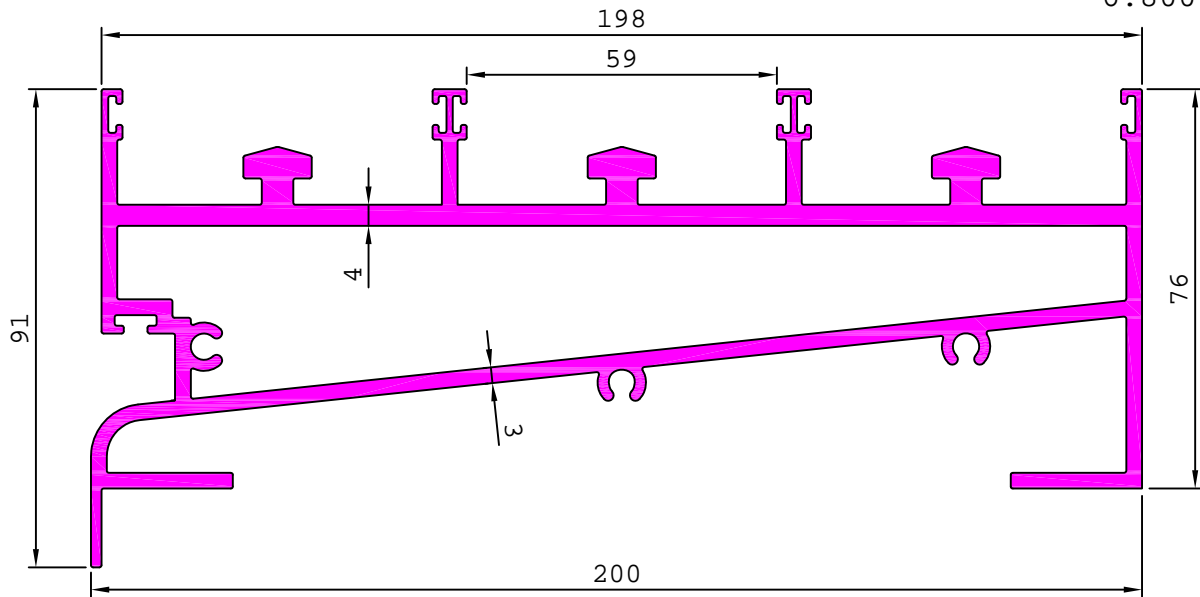

21128

3.402 kg/m

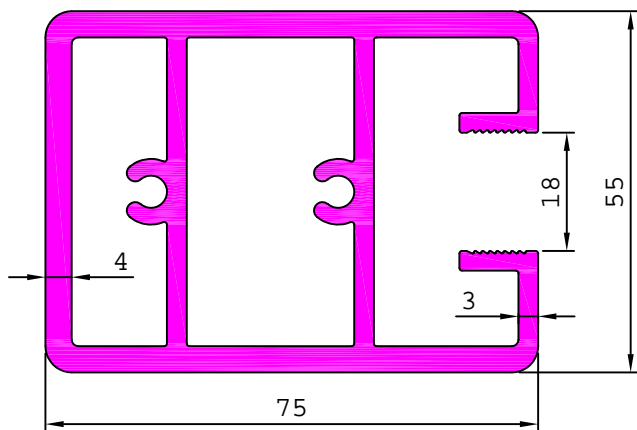

21129

3.141 kg/m

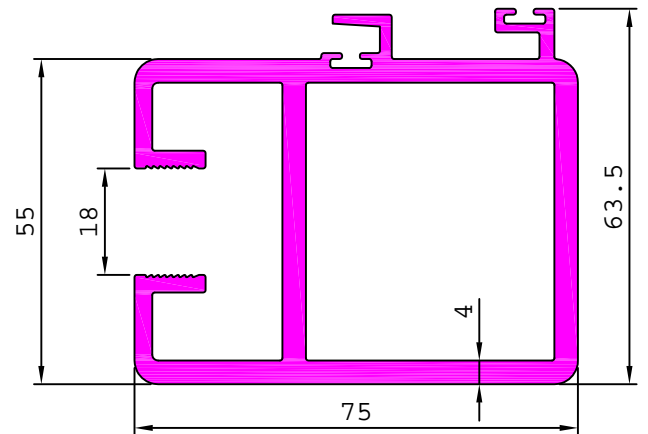

21130

3.458 kg/m

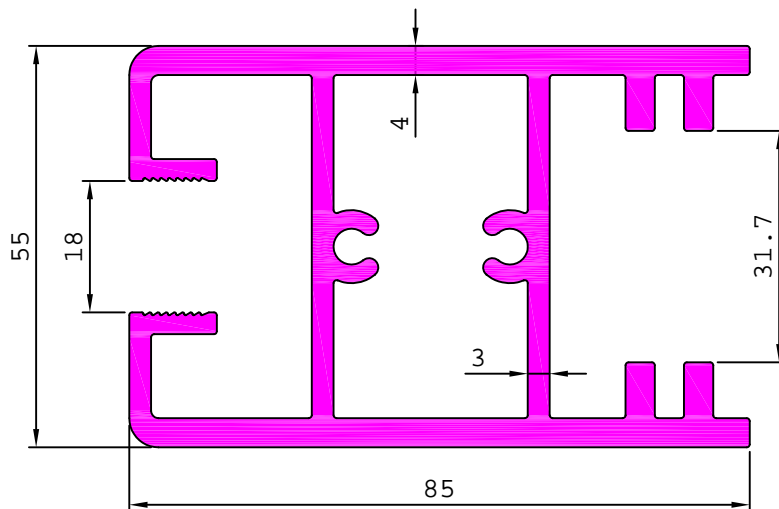

ARCHITECTURAL

DETAILS OF SLIDING WINDOW SECTIONS SERIES - I (SHUTTER SECTION - 60 mm.)

21258

3.185 kg/m

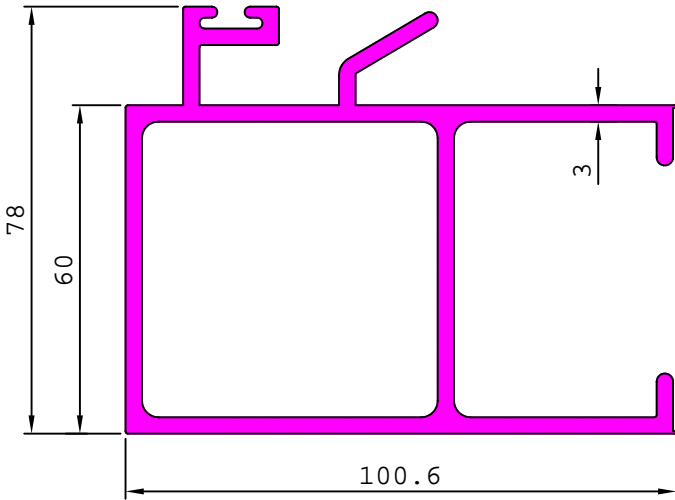

21262

1.780 kg/m

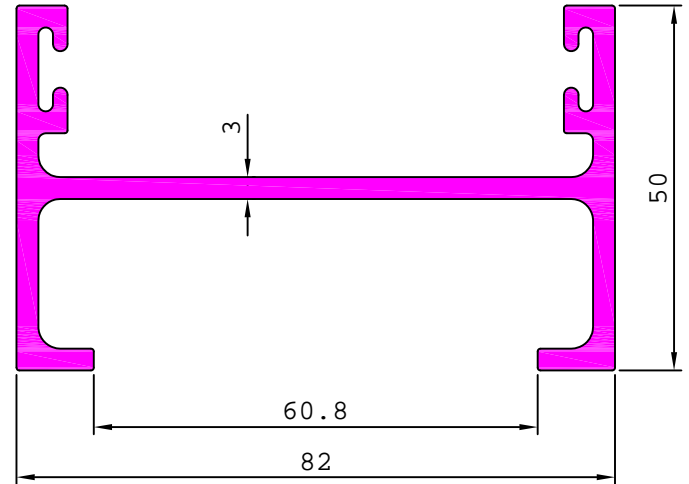

21266

130

3.652 kg/m

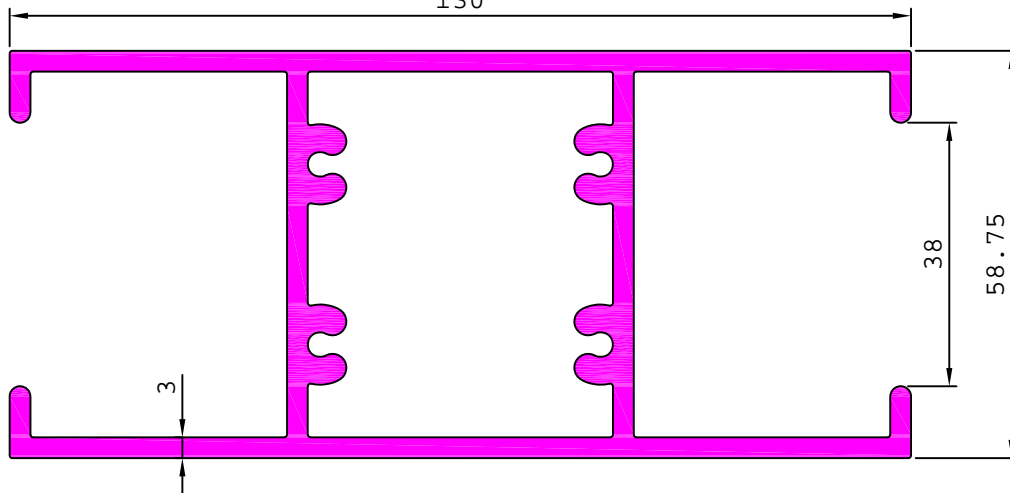

21265

2.815 kg/m

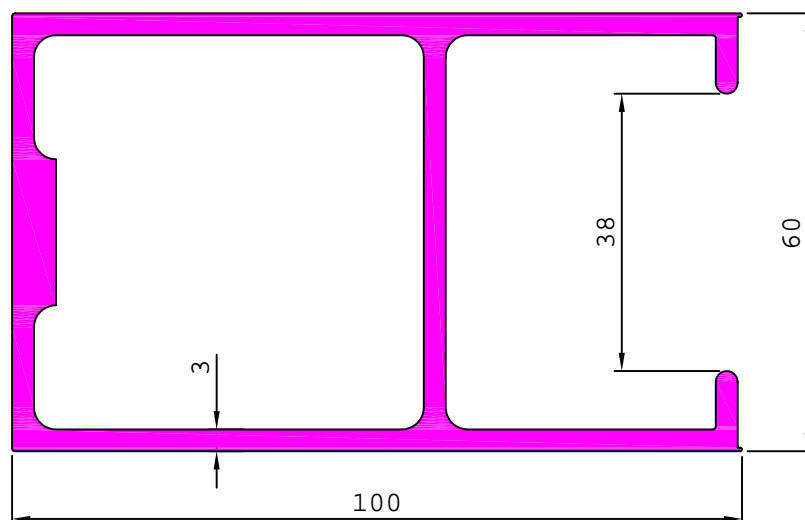

ARCHITECTURAL

DETAILS OF SLIDING WINDOW SECTIONS SERIES - I (SHUTTER SECTION - 60 mm.)

21267

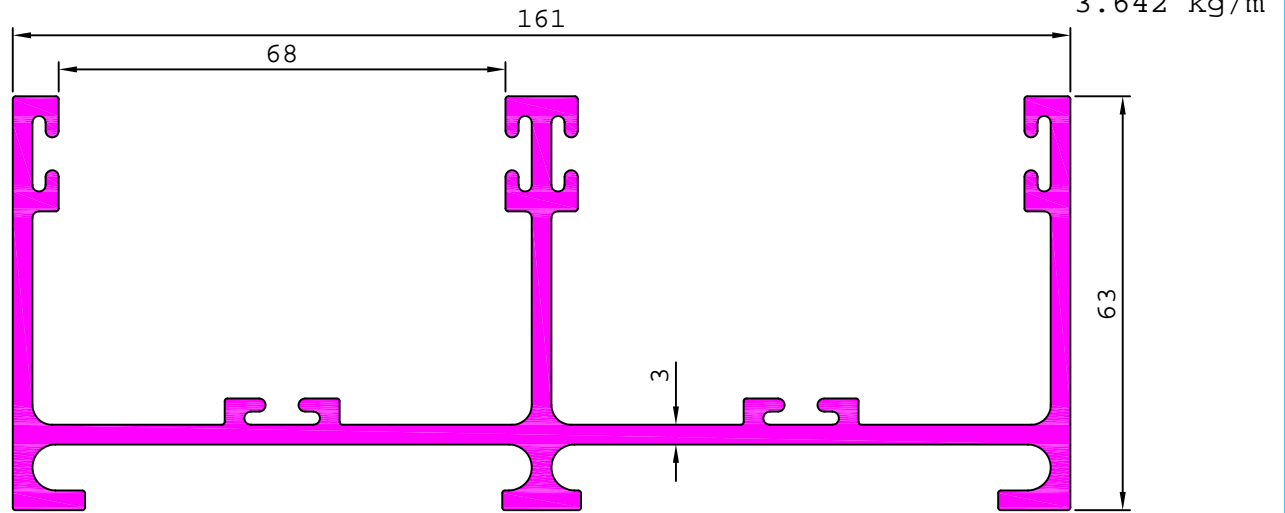

21268

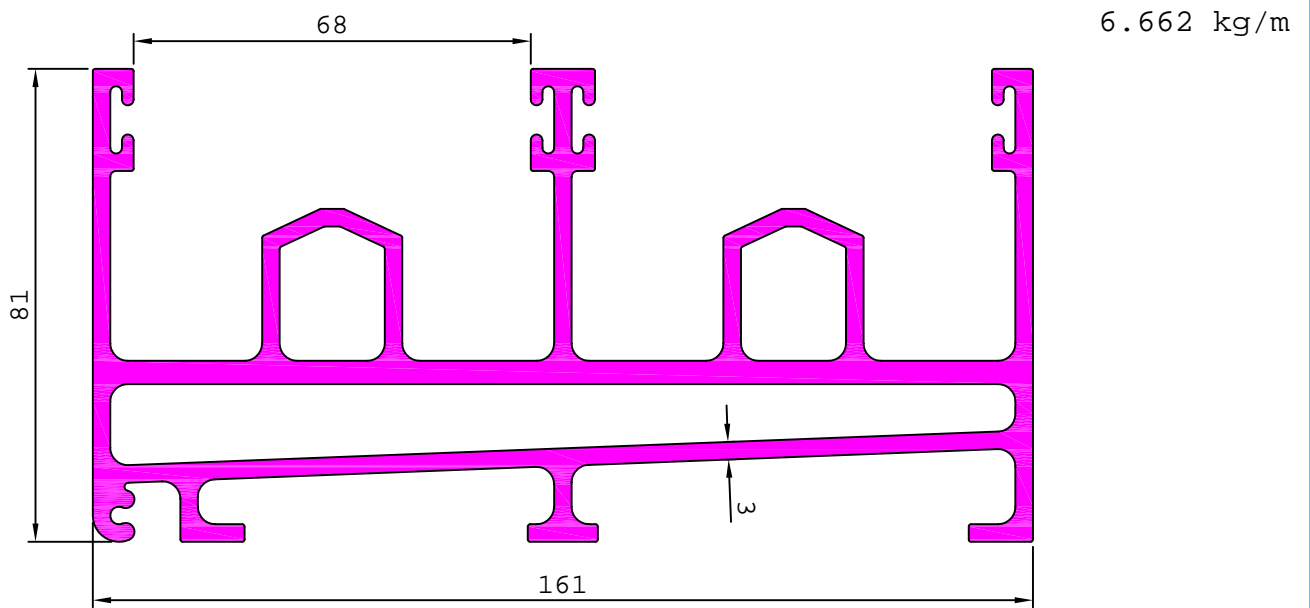

21301

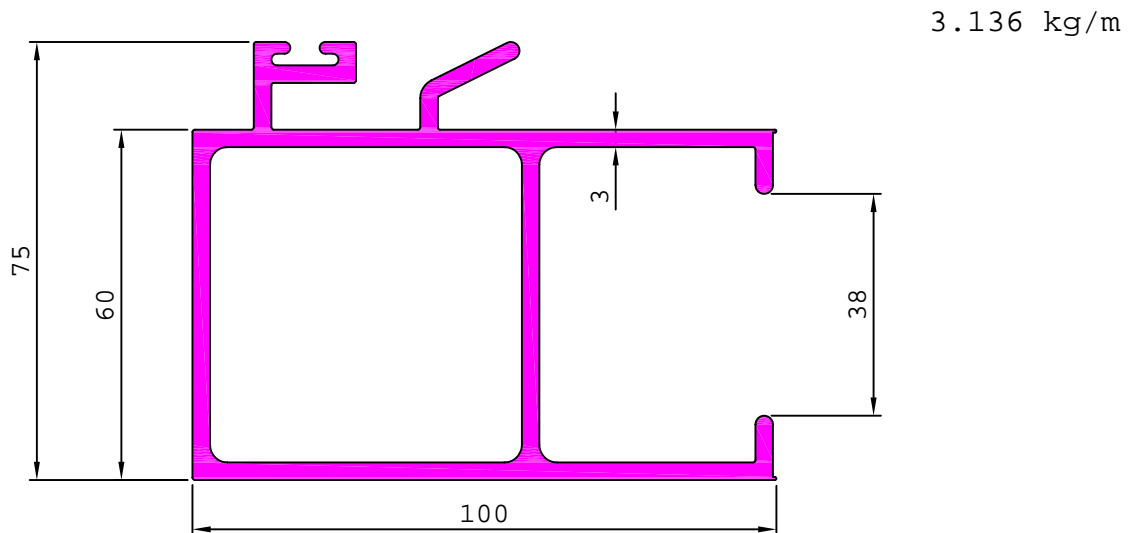

ARCHITECTURAL

DETAILS OF SLIDING WINDOW SECTIONS SERIES - I (SHUTTER SECTION - 60 mm.)

21271

9.521 kg/m

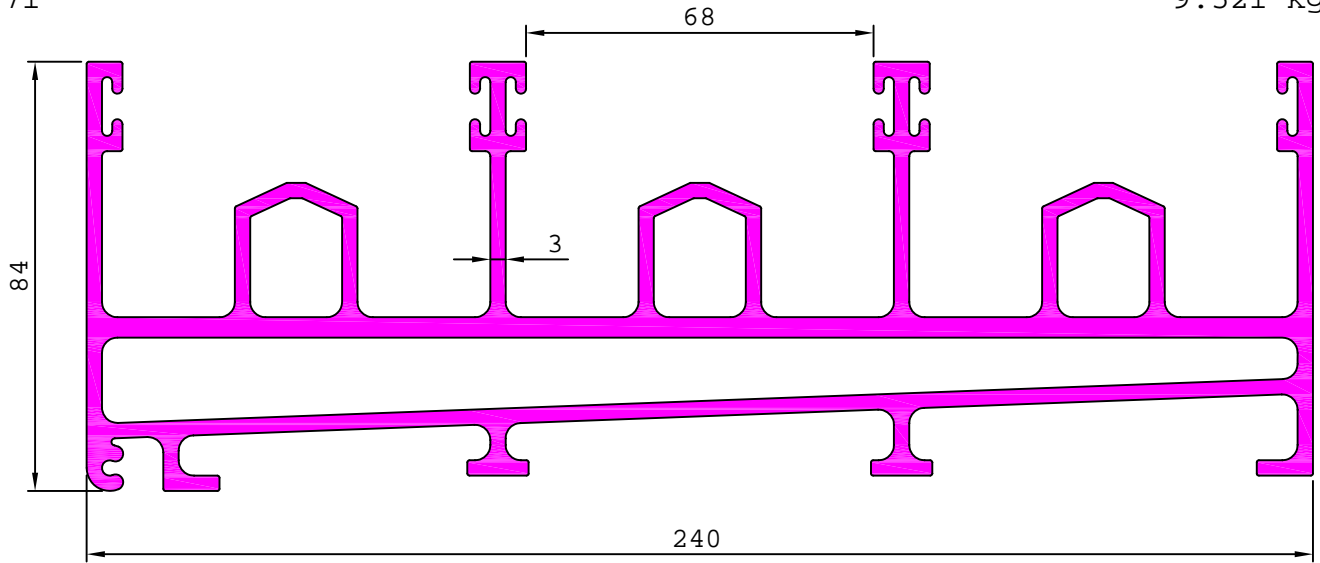

21272

4.998 kg/m

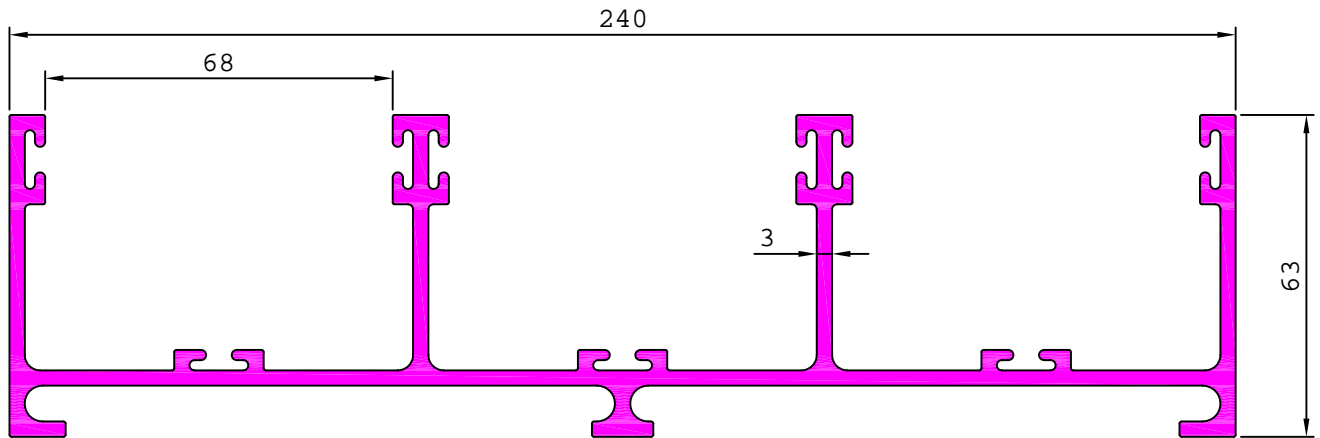

ARCHITECTURAL

WINDOW SECTIONS (DELUXE SERIES)

21048

0.591 kg/m

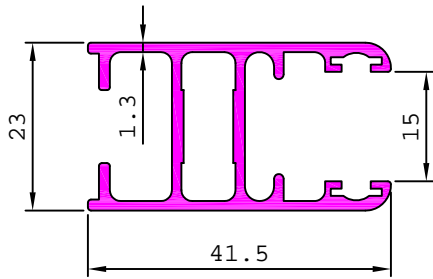

21158

0.675 kg/m

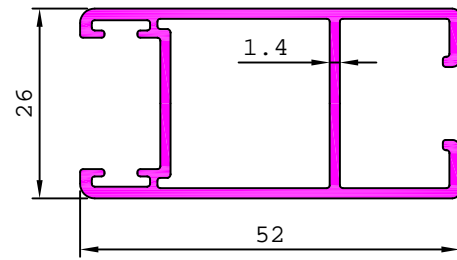

21067

0.824 kg/m

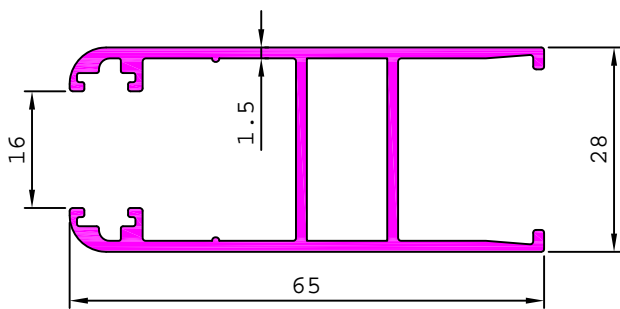

21068

0.912 kg/m

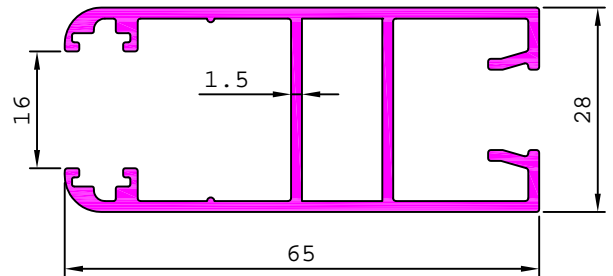

21157

0.680 kg/m

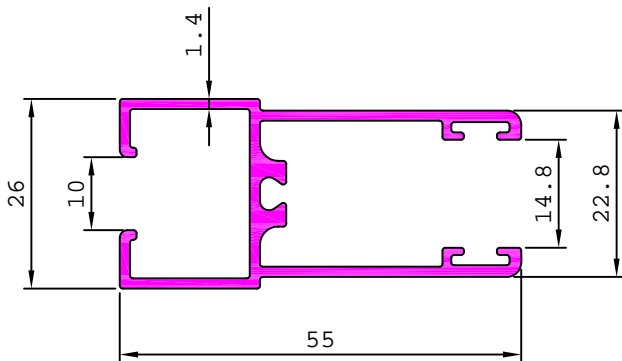

21350

0.914 kg/m

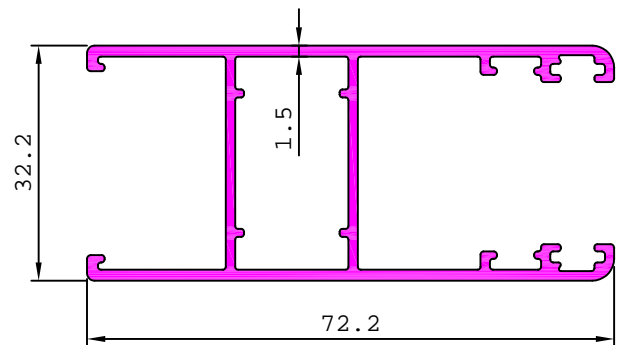

21358

0.839 kg/m

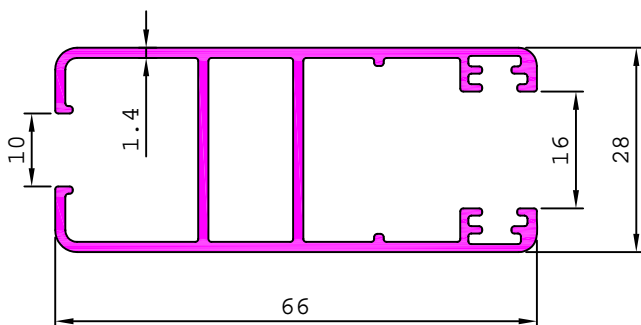

21384

1.385 kg/m

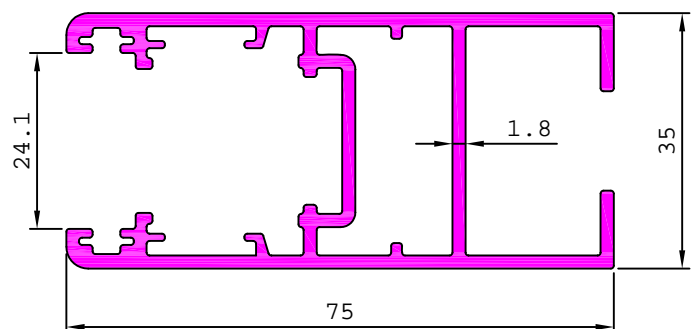

ARCHITECTURAL

WINDOW SECTIONS (DELUXE SERIES)

21372

0.719 kg/m

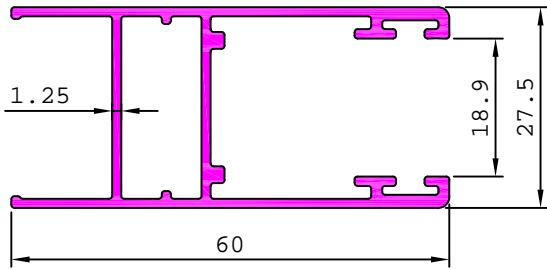

21375

0.926 kg/m

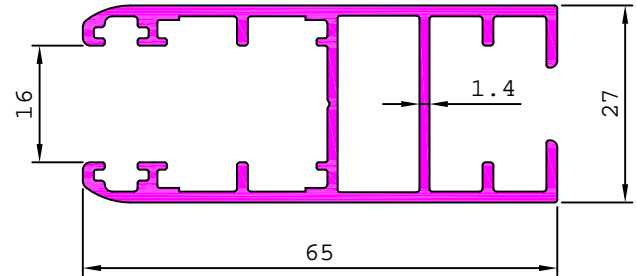

21241

0.778 kg/m

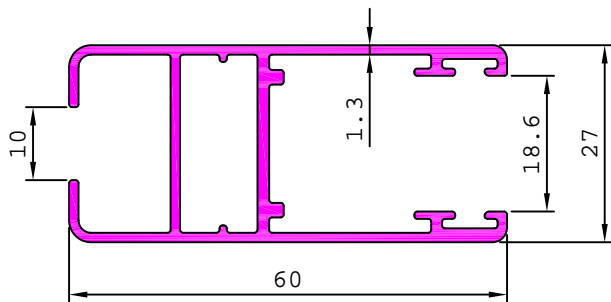

21457

1.625 kg/m

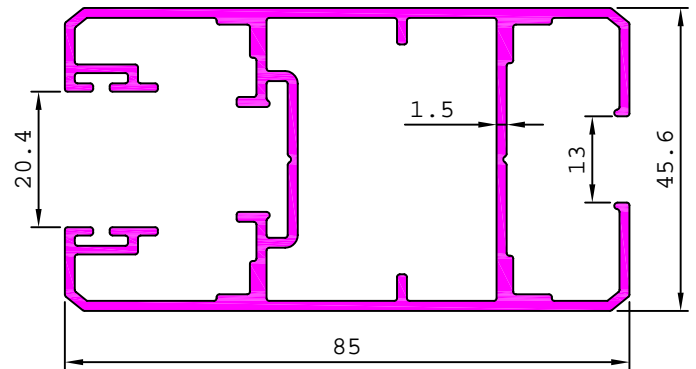

21469

1.634 kg/m

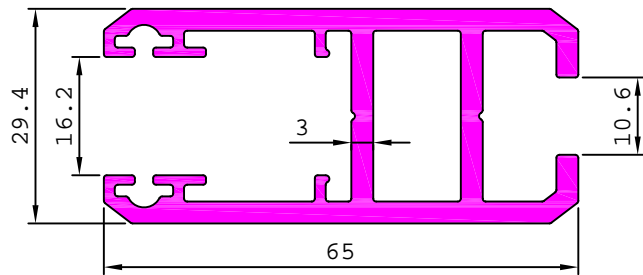

21481

1.020 kg/m

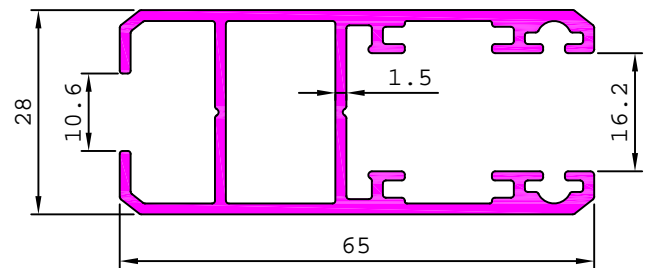

21486

0.774 kg/m

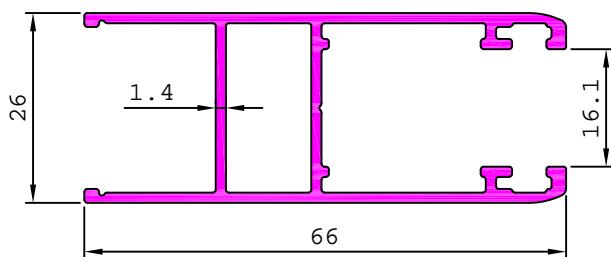

21490

0.851 kg/m

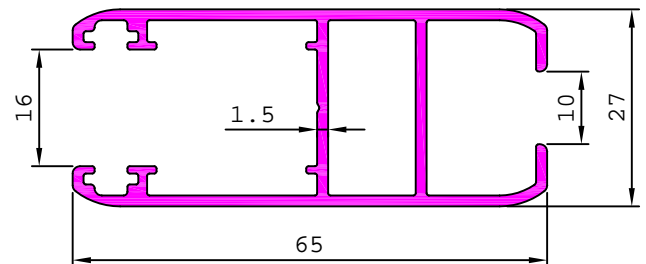

21633

0.888 kg/m

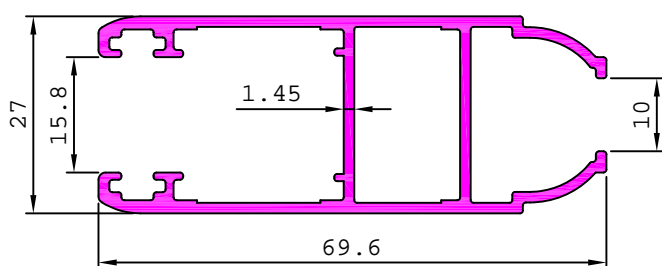

21554

0.905 kg/m

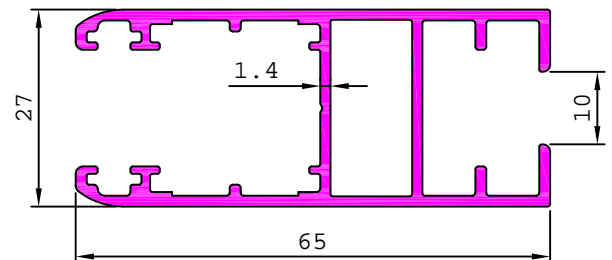

ARCHITECTURAL

WINDOW SECTIONS (DELUXE SERIES)

21557 1.020 kg/m

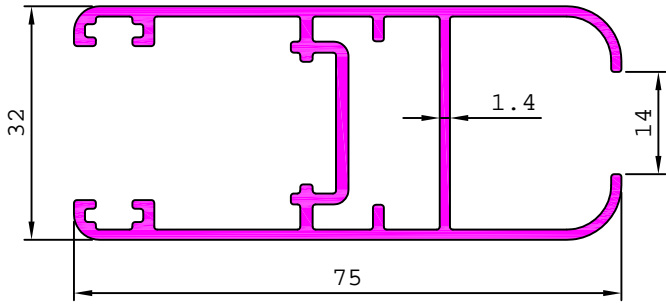

S4395 1.005 kg/m

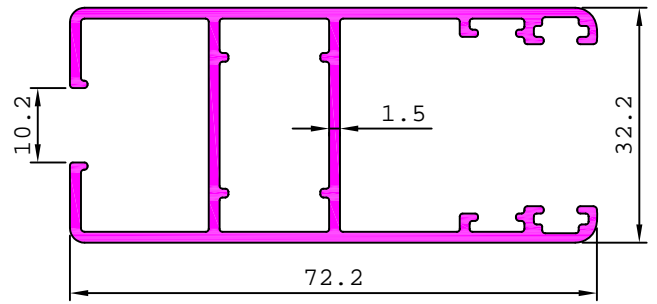

21596 0.747 kg/m

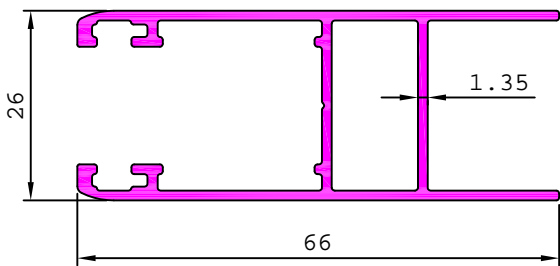

21597 1.221 kg/m

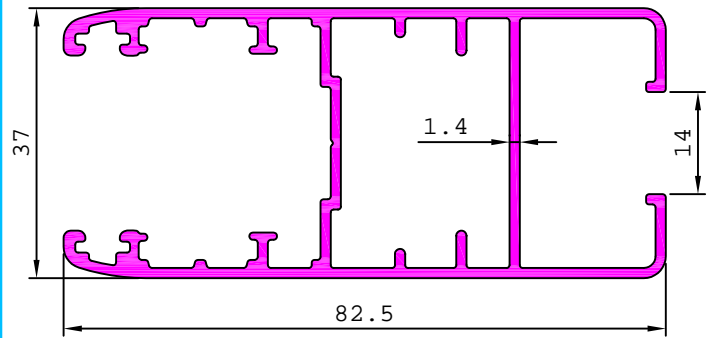

21615 0.767 kg/m

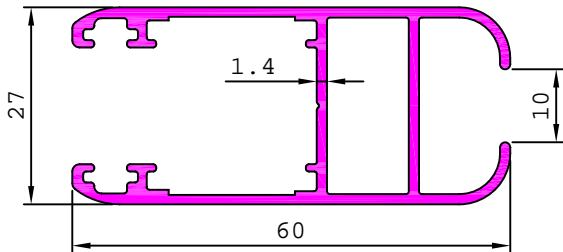

21618 0.874 kg/m

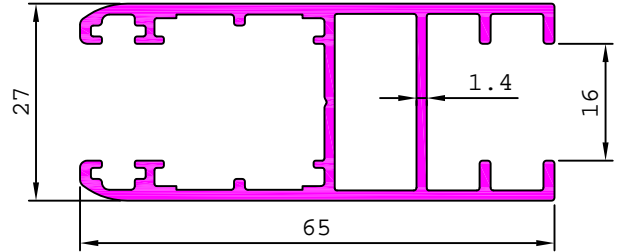

21614 1.359 kg/m

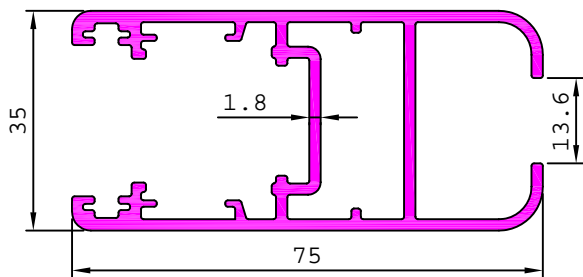

21619 1.319 kg/m

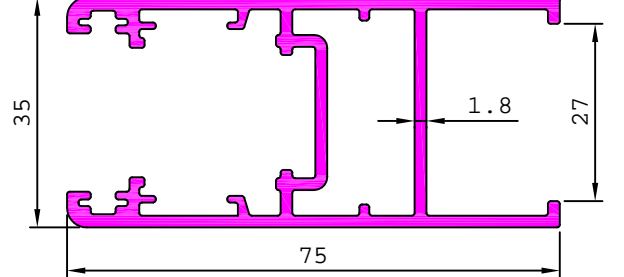

21643 0.845 kg/m

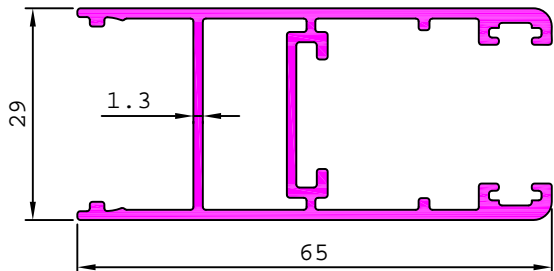

21687 1.137 kg/m

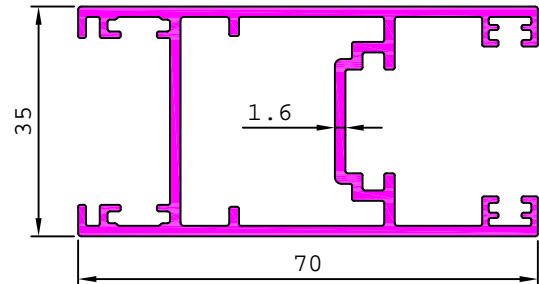

ARCHITECTURAL

WINDOW SECTIONS (DELUXE SERIES)

S4901 0.679 kg/m

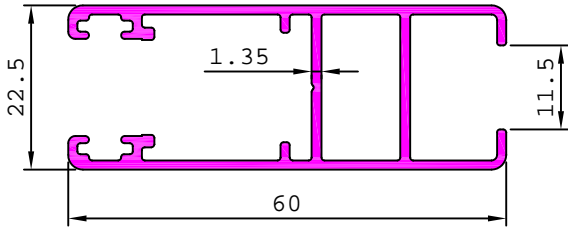

S4734 0.944 kg/m

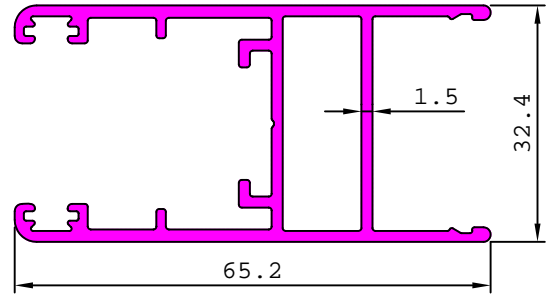

S4929 0.979 kg/m

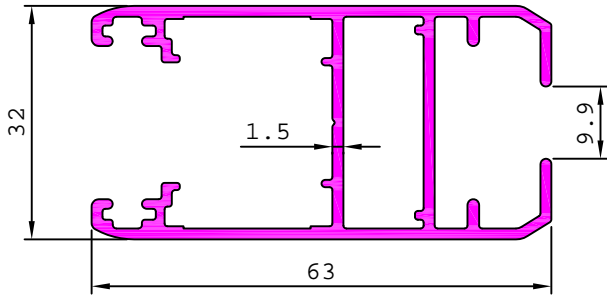

S4909 0.845 kg/m

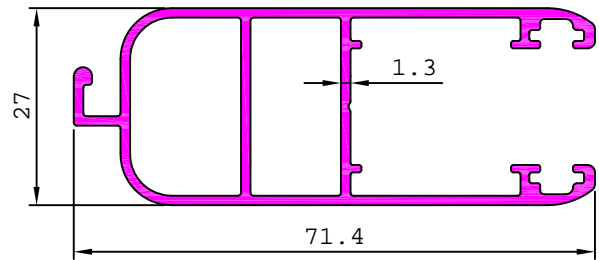

S5064 0.660 kg/m

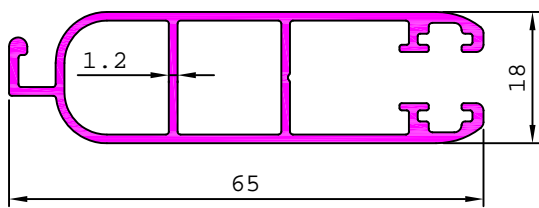

S5065 0.706 kg/m

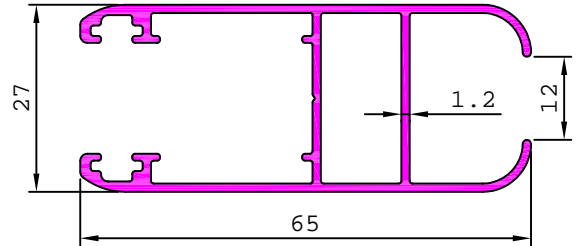

S5066 0.930 kg/m

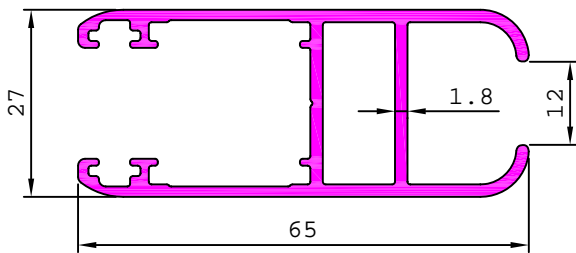

21679 1.906 kg/m

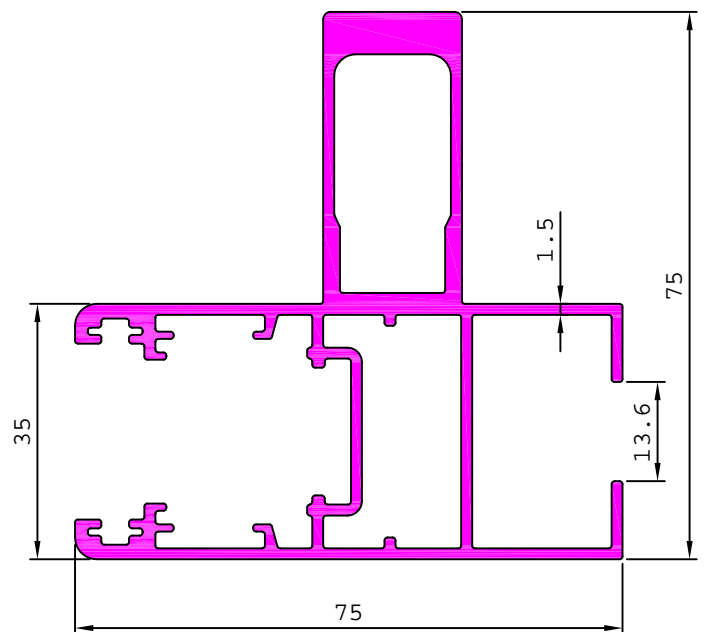

21533 0.999 kg/m

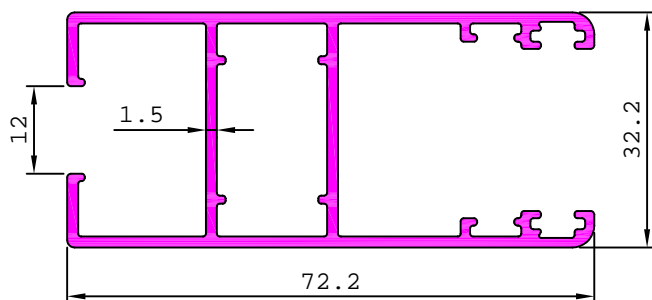

ARCHITECTURAL

WINDOW SECTIONS (DELUXE SERIES)

21559

0.609 kg/m

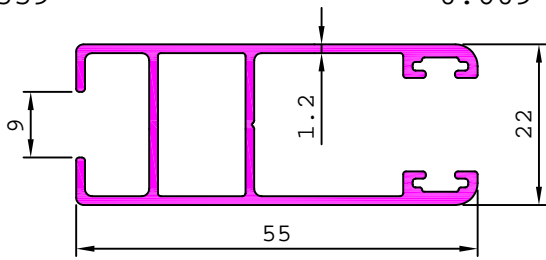

S5176

0.875 kg/m

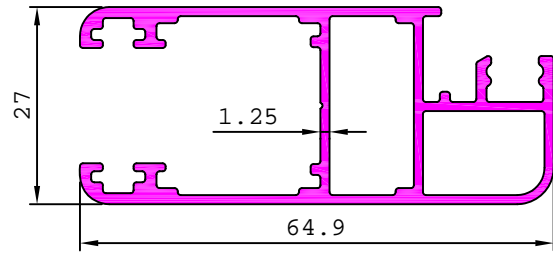

ARCHITECTURAL

WINDOW SECTIONS (DELUXE SERIES)

21419

0.253 kg/m

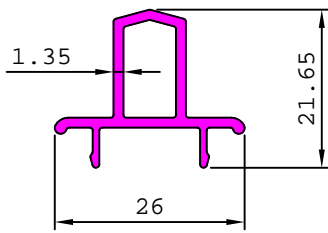

21456

0.342 kg/m

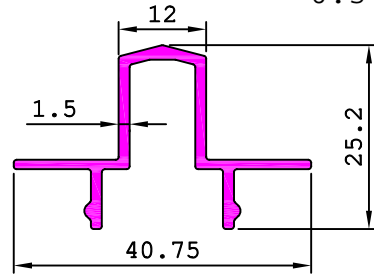

21081

1.047 kg/m

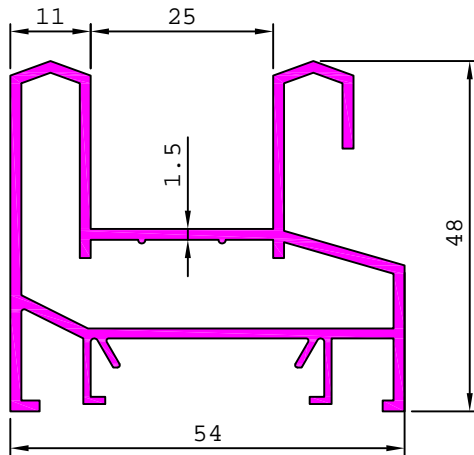

21402

0.993 kg/m

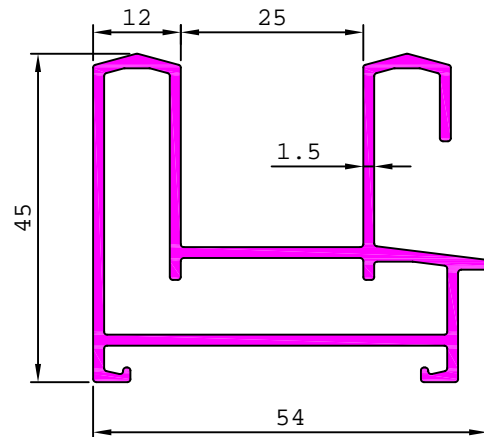

21470

1.754 kg/m

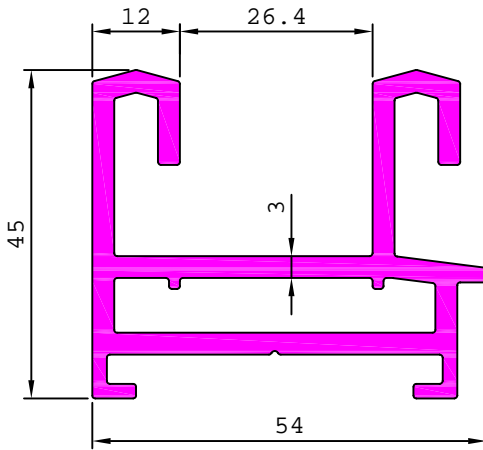

21374

1.004 kg/m

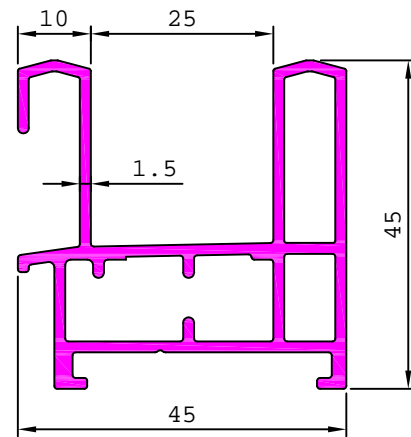

S4931

0.628 kg/m

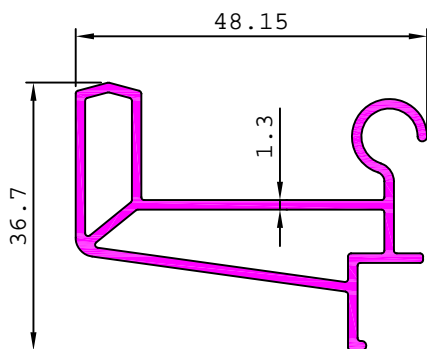

21163

1.016 kg/m

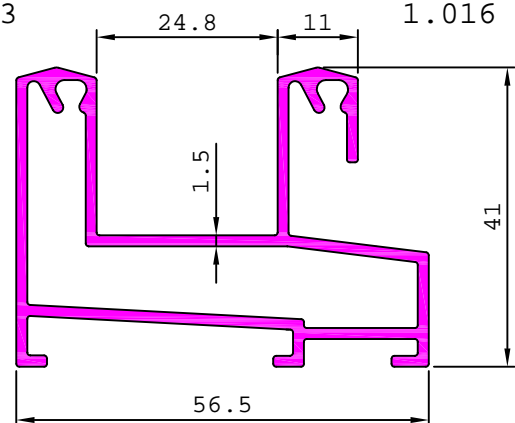

ARCHITECTURAL

WINDOW SECTIONS (DELUXE SERIES)

S4902 1.002 kg/m

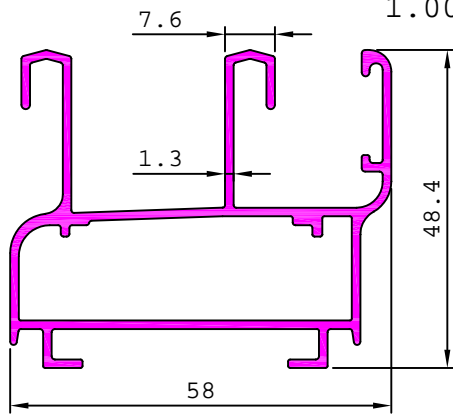

21359 1.535 kg/m

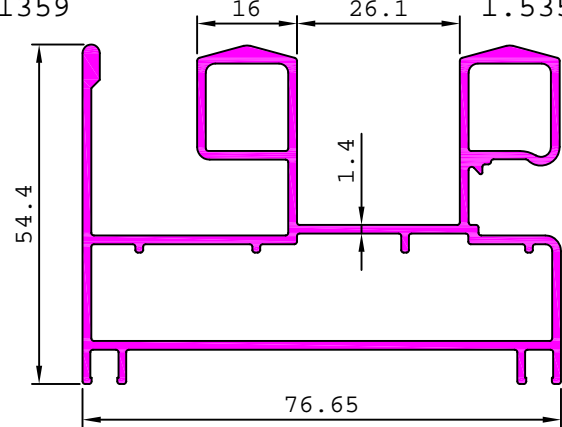

21363 1.328 kg/m

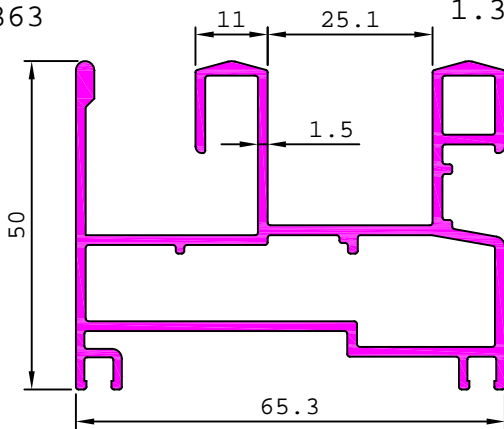

21162 1.020 kg/m

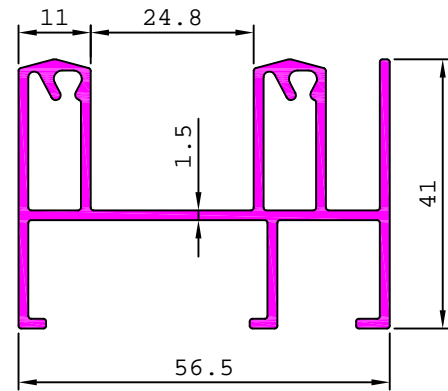

21373 1.015 kg/m

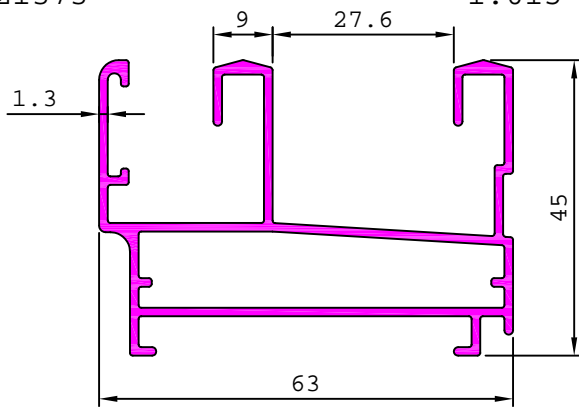

21632 1.049 kg/m

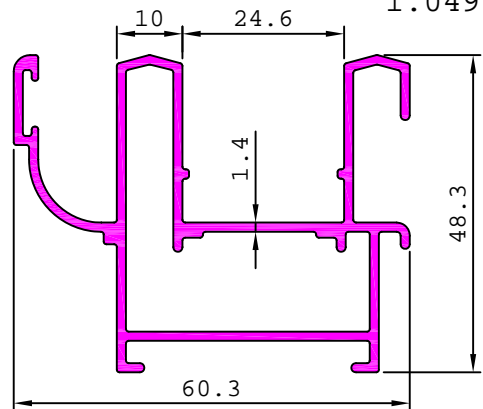

S4554 1.036 kg/m

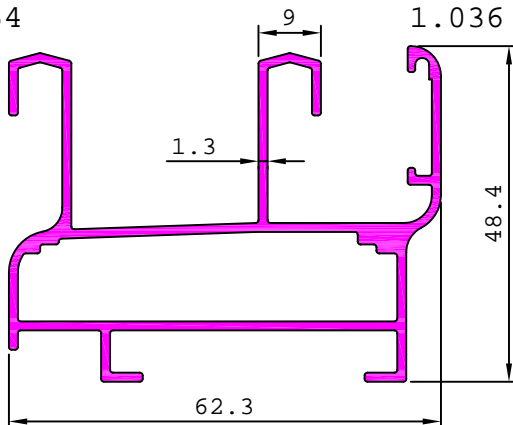

S4927 1.435 kg/m

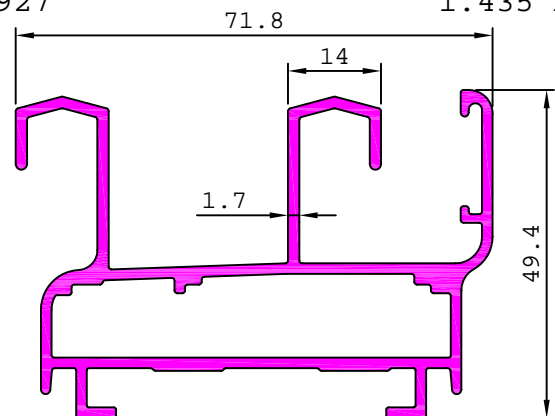

ARCHITECTURAL

WINDOW SECTIONS (DELUXE SERIES)

S4557

0.739 kg/m

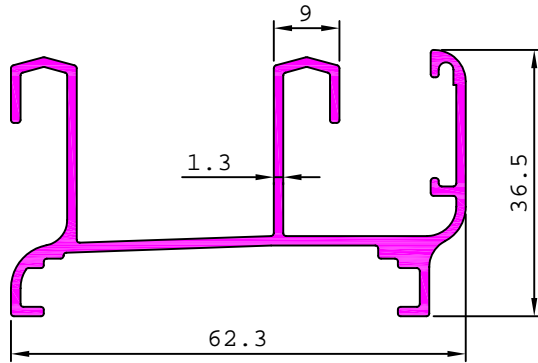

21487

1.329 kg/m

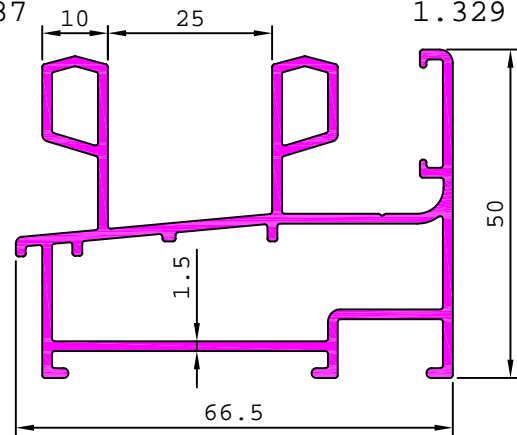

S4733

1.444 kg/m

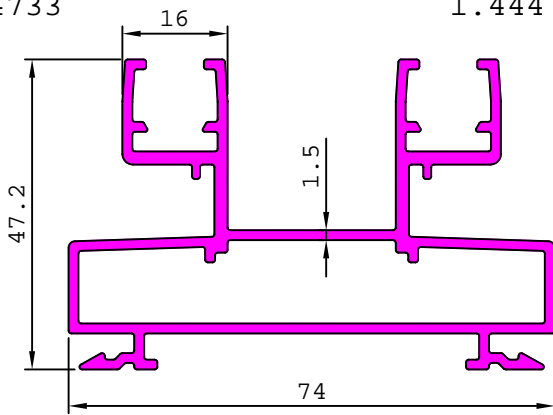

S4907

1.206 kg/m

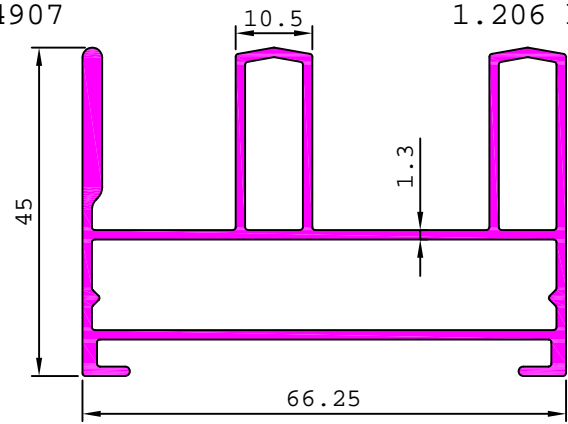

21568

1.522 kg/m

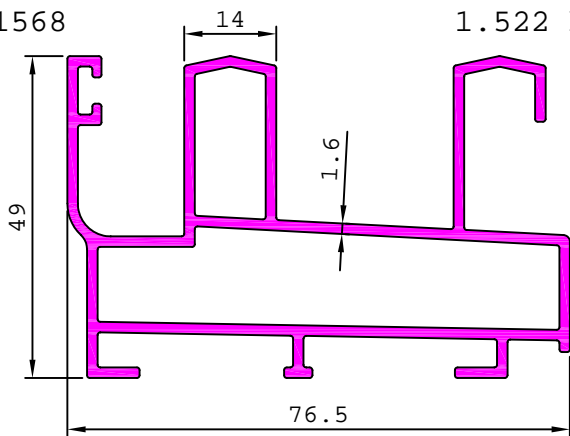

21427

1.379 kg/m

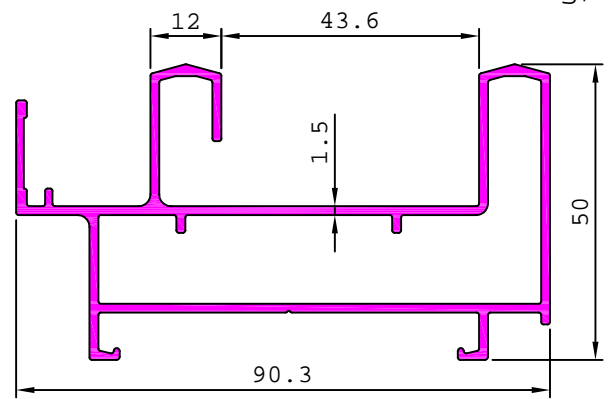

21156

0.836 kg/m

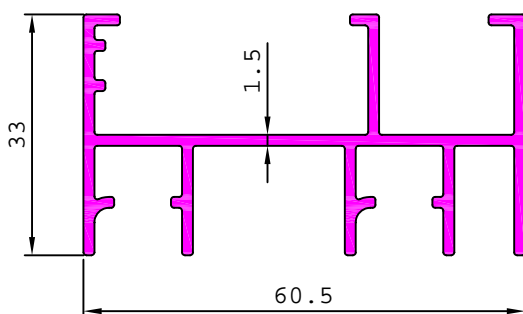

S4627

2.843 kg/m

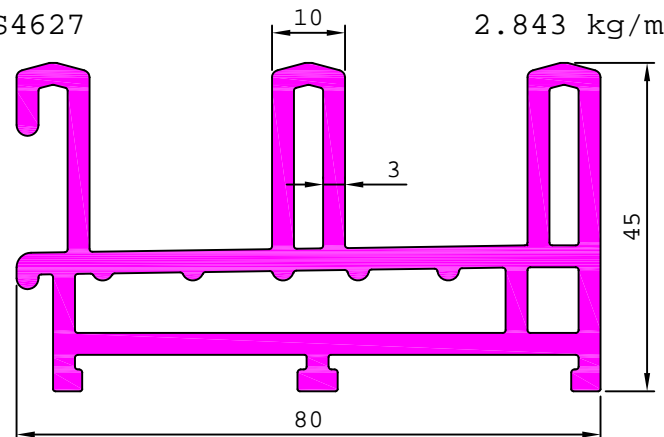

ARCHITECTURAL

WINDOW SECTIONS (DELUXE SERIES)

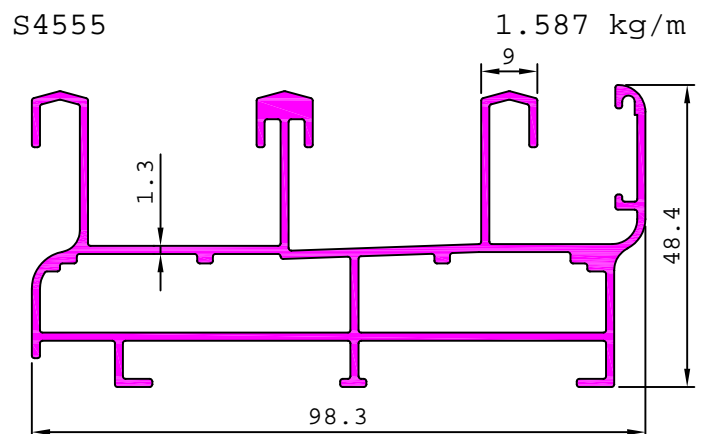
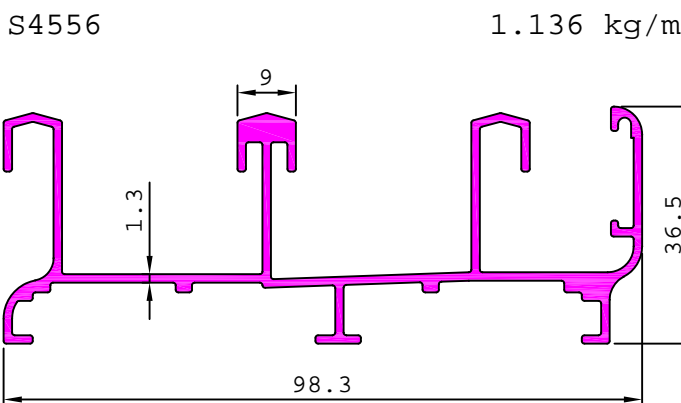
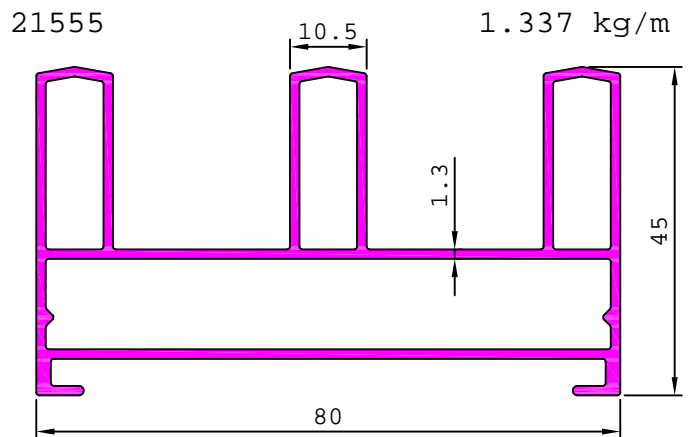
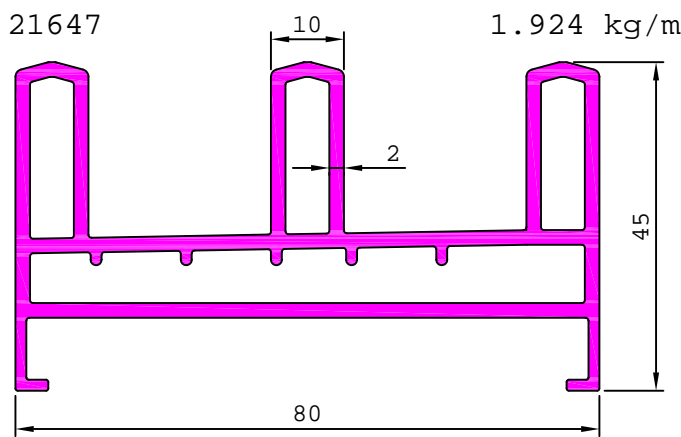
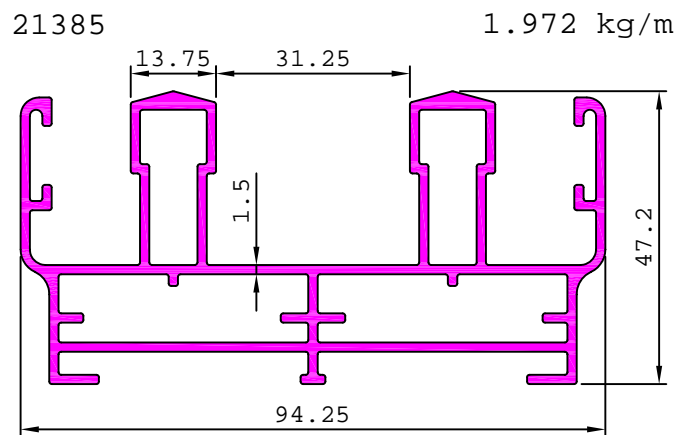
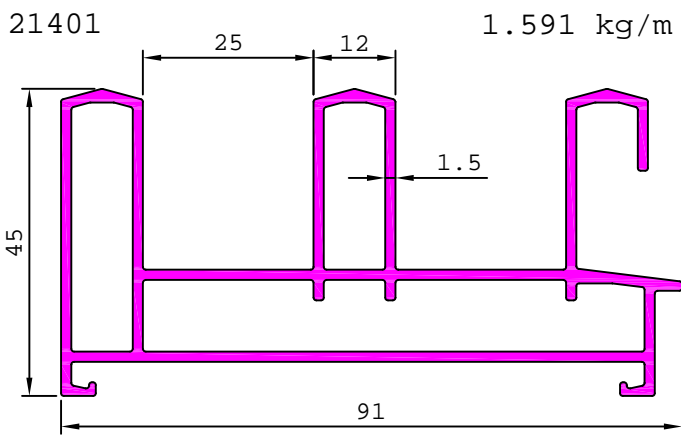
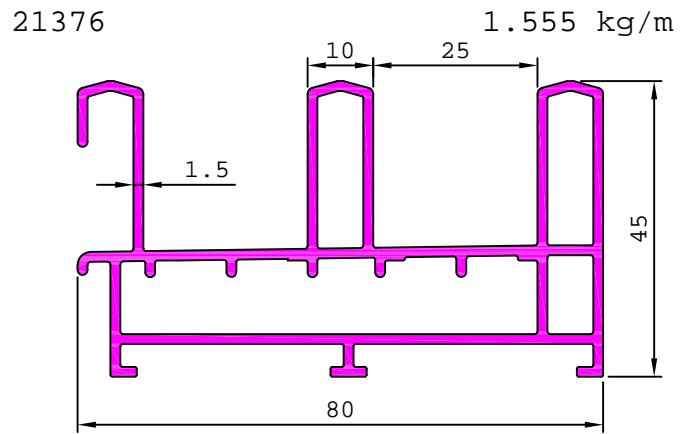
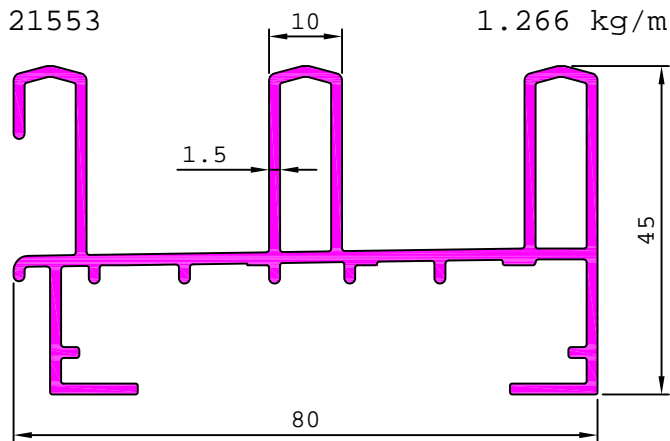

ARCHITECTURAL

WINDOW SECTIONS (DELUXE SERIES)

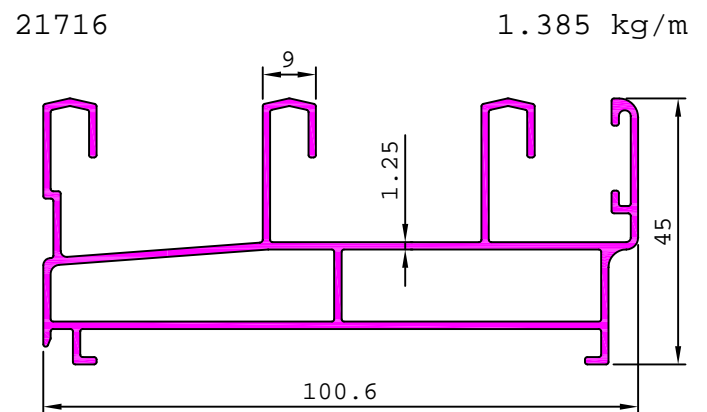
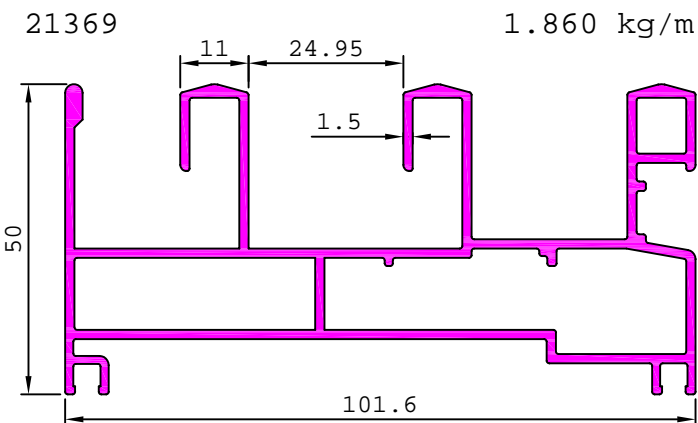
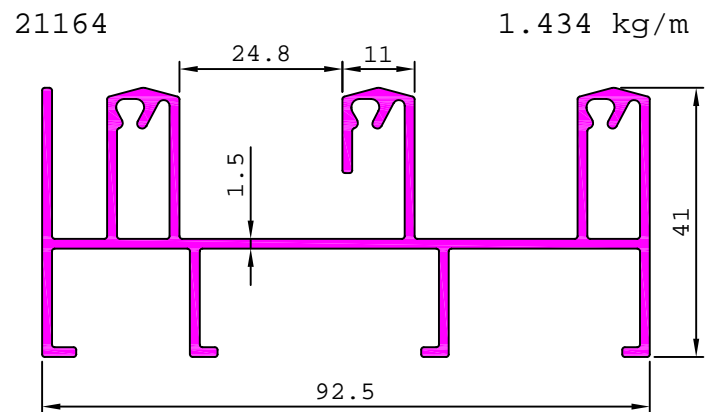
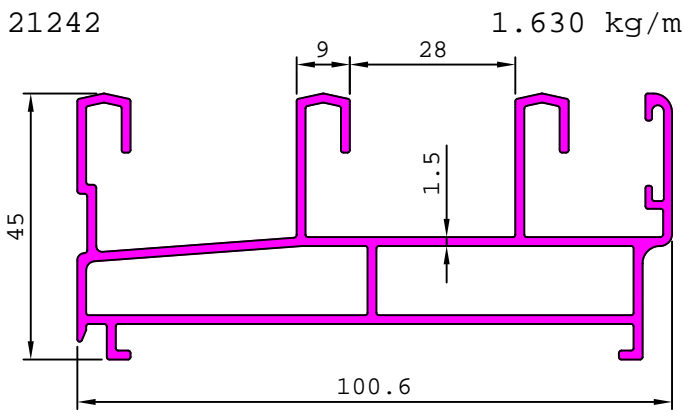
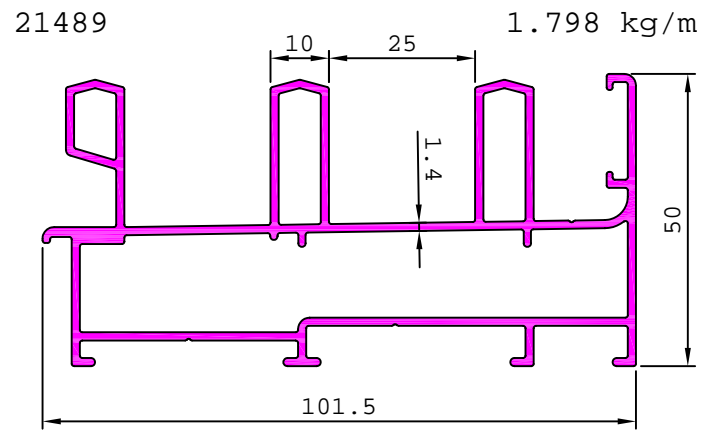
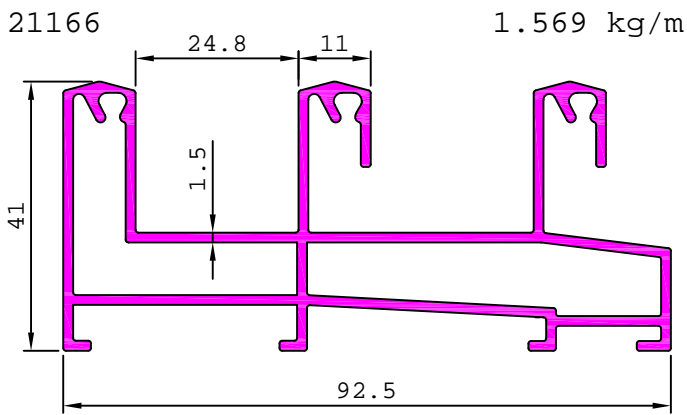
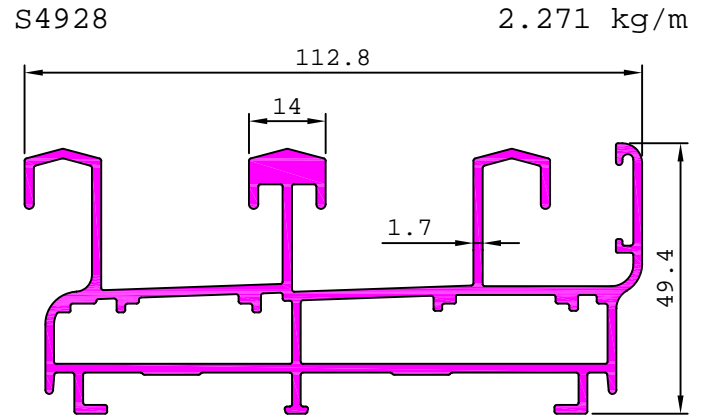
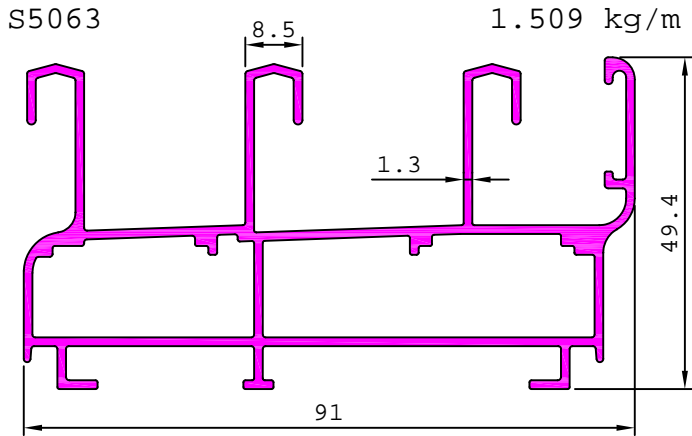

ARCHITECTURAL

WINDOW SECTIONS (DELUXE SERIES)

S4908

1.648 kg/m

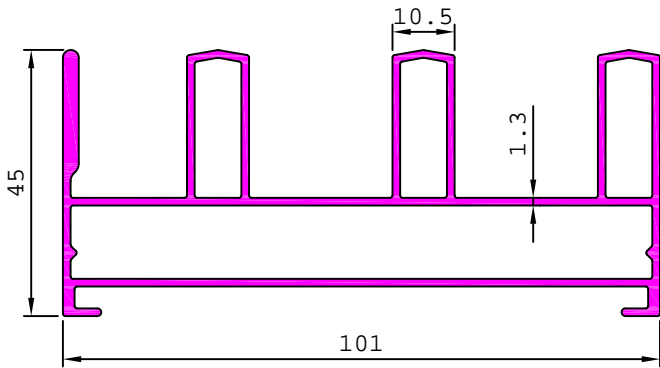

21569

2.193 kg/m

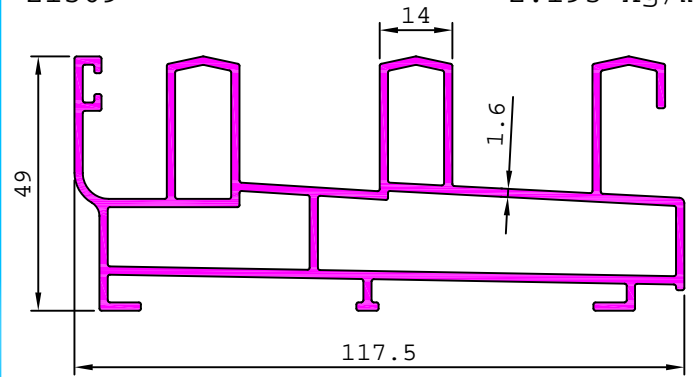

21360

2.254 kg/m

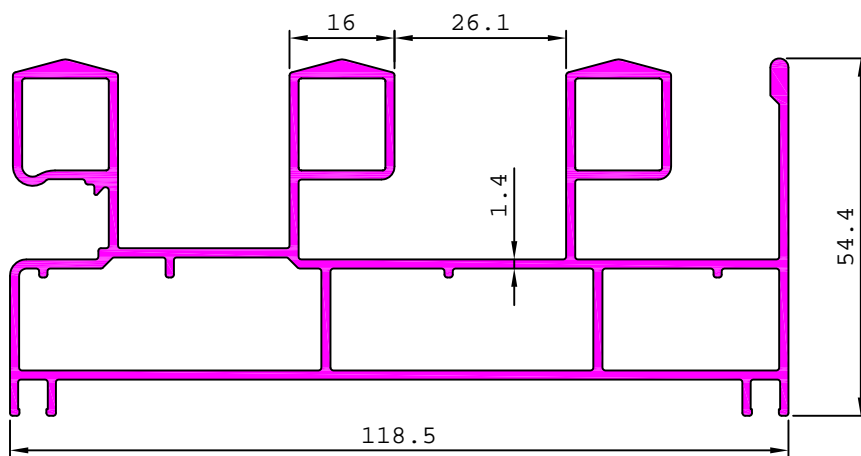

21190

2.429 kg/m

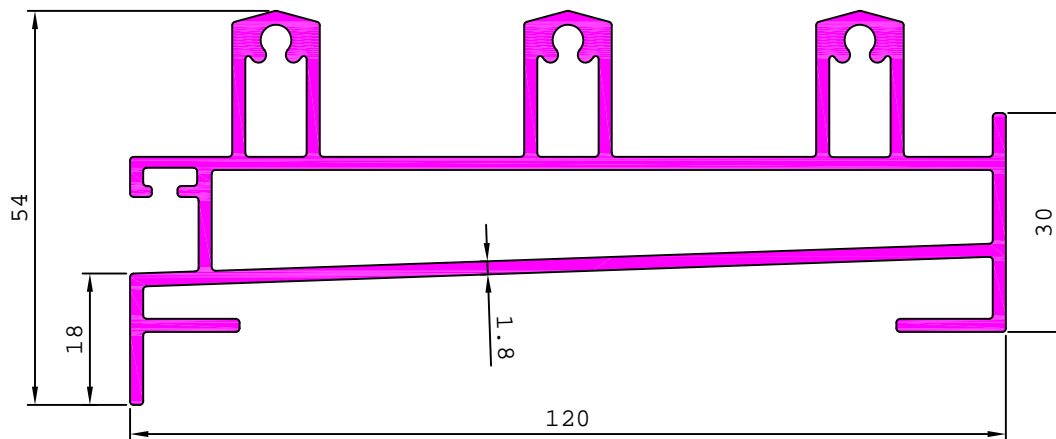

21189

2.168 kg/m

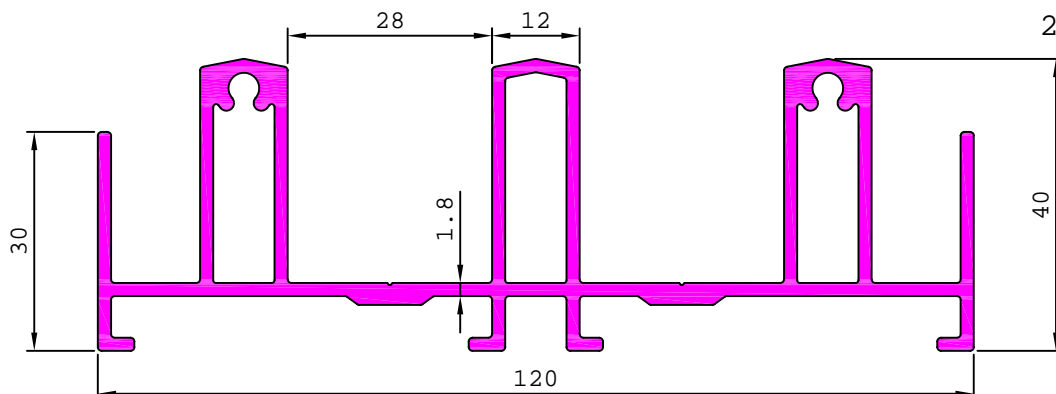

ARCHITECTURAL

WINDOW SECTIONS (DELUXE SERIES)

21480

2.480 kg/m

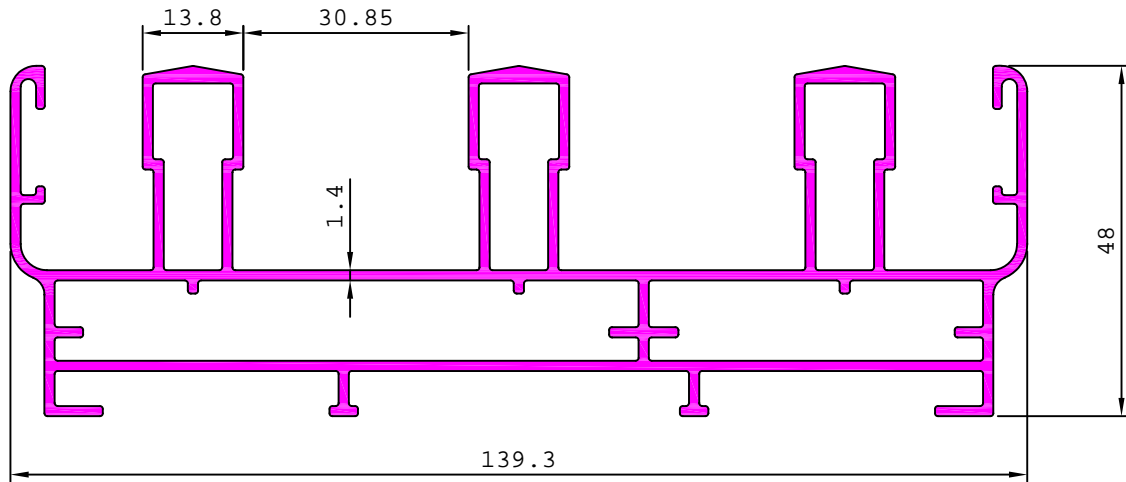

21428

2.183 kg/m

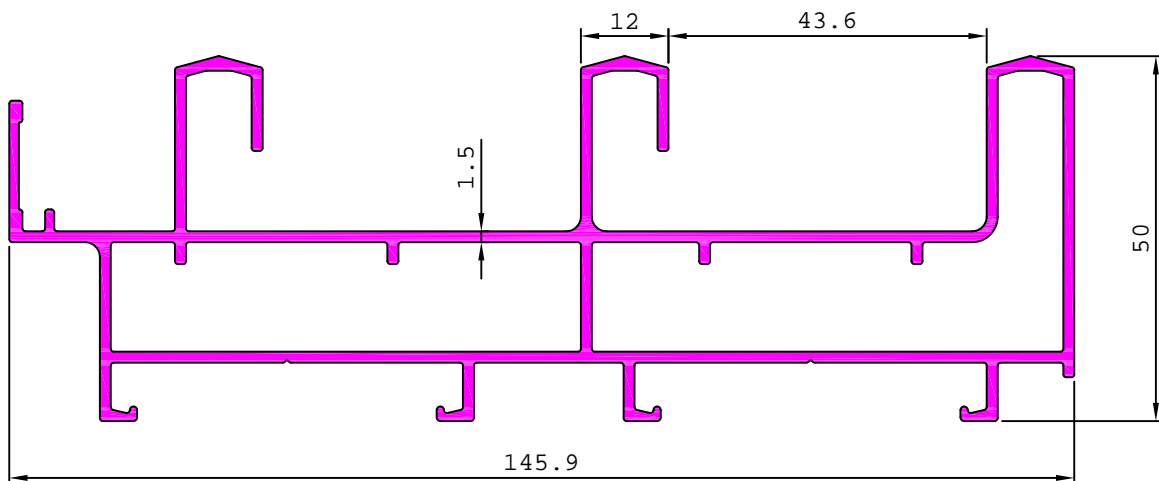

21488

2.466 kg/m

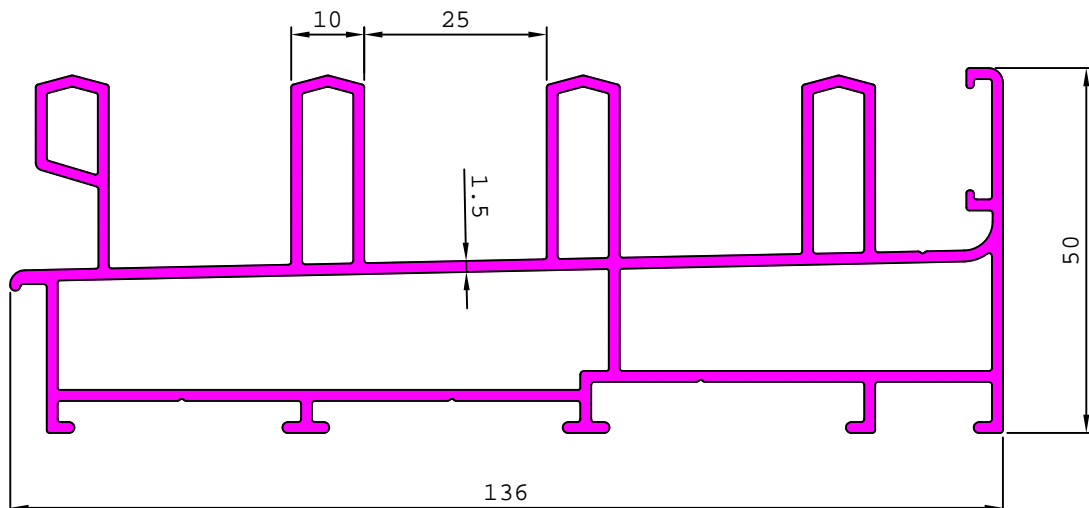

ARCHITECTURAL

WINDOW SECTIONS (DELUXE SERIES)

21644

2.342 kg/m

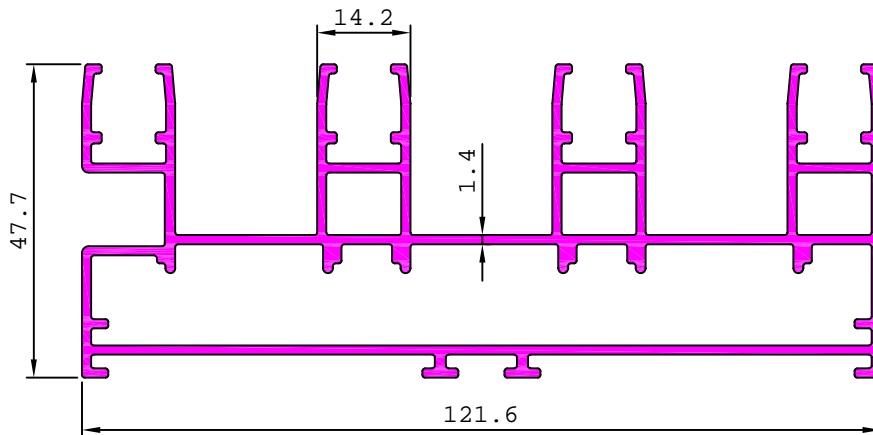

21497

3.109 kg/m

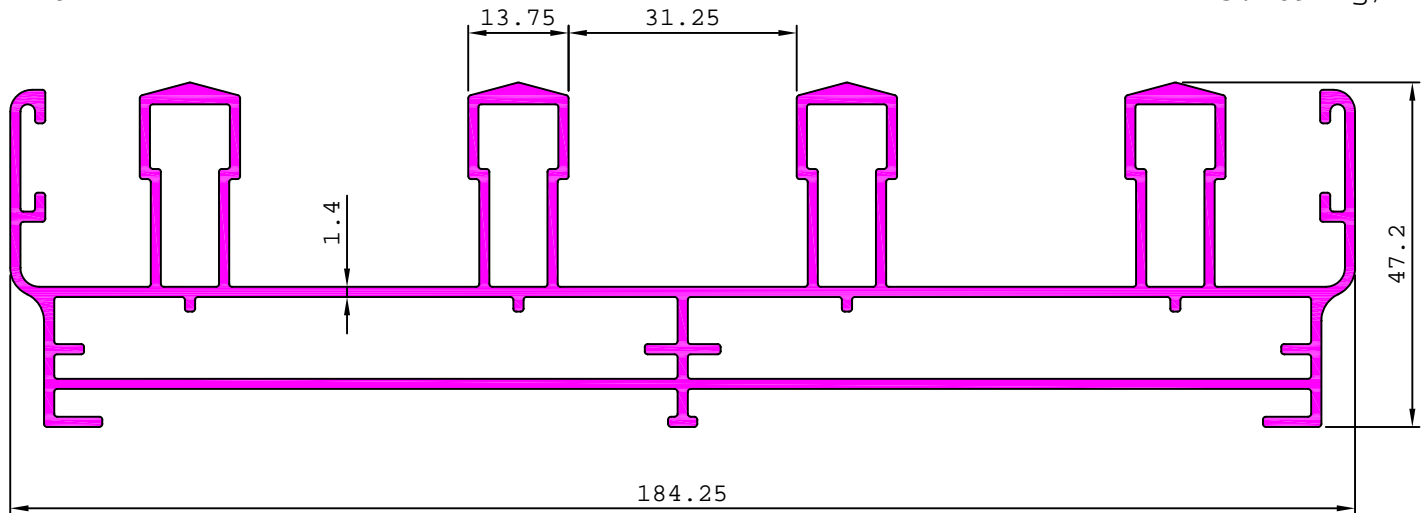

21498

3.582 kg/m

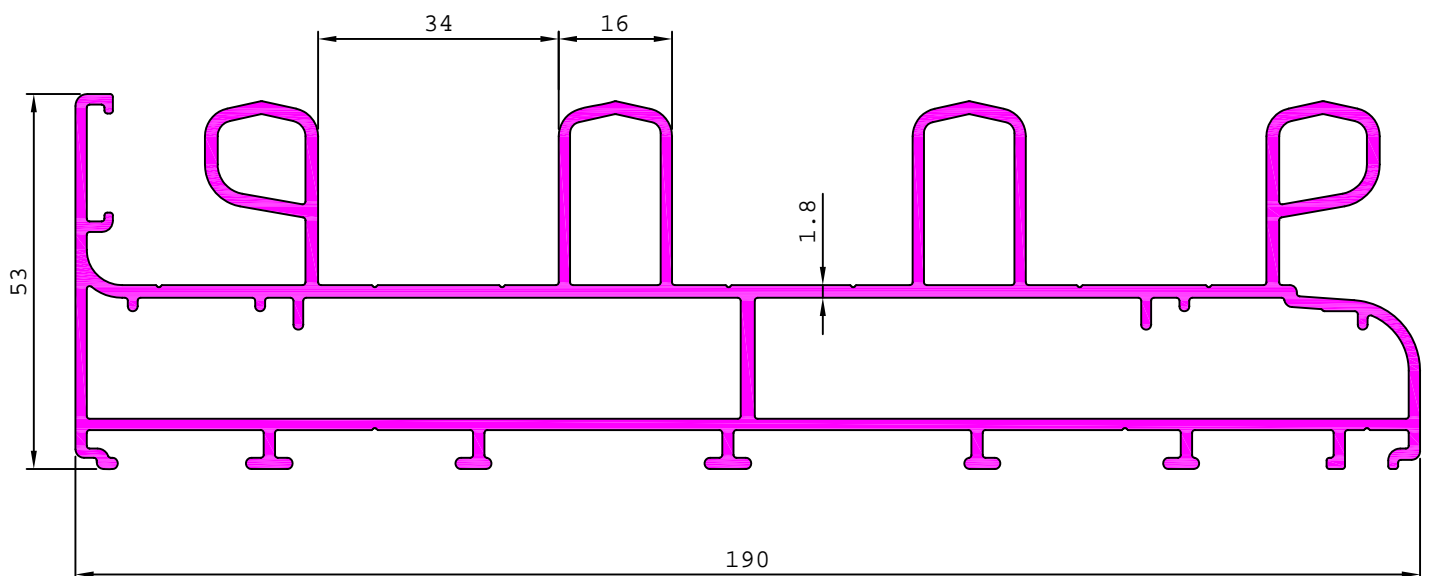

ARCHITECTURAL

WINDOW SECTIONS (DELUXE SERIES)

21558

2.829 kg/m

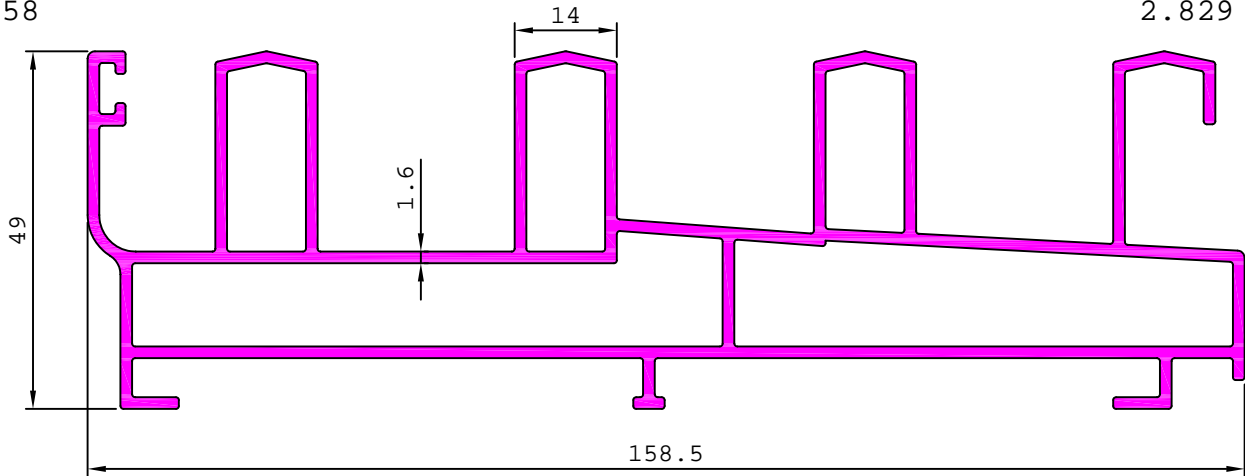

21534

0.972 kg/m

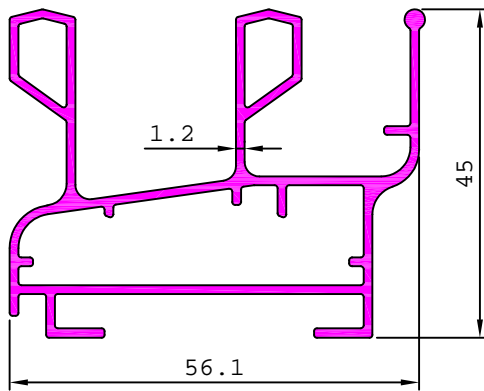

ARCHITECTURAL

WINDOW SECTIONS

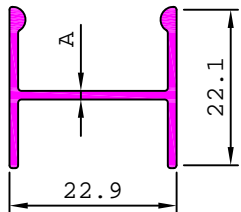

SL. No.	Section No.	A	Weight kg/m
1	20822	0.69	0.137
2	20962	0.88	0.173
3	20784	1.00	0.191
4	20637	1.20	0.222

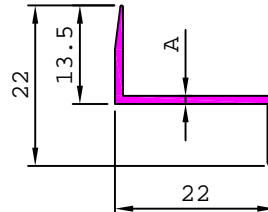

SL. No.	Section No.	A	Weight kg/m
1	21120	0.78	0.088
2	20693	1.10	0.124

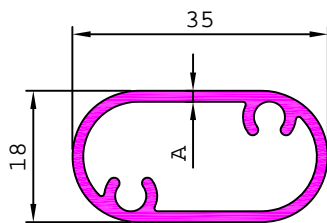

SL. No.	Section No.	A	Weight kg/m
1	20783	1.10	0.337
2	20527	1.50	0.408

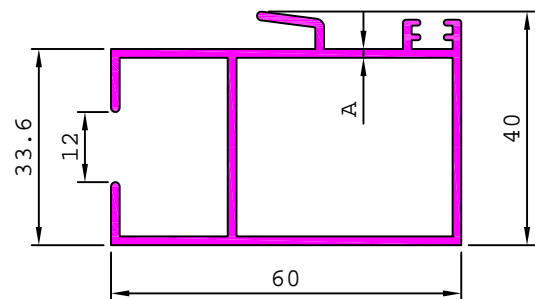

SL. No.	Section No.	A	Weight kg/m
1	20992	1.32	0.813
2	20773	1.50	0.923

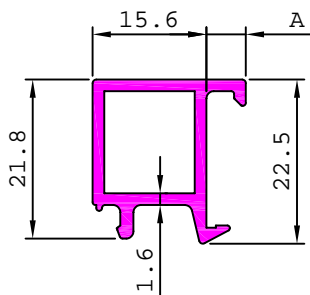

SL. No.	Section No.	A	Weight kg/m
1	21193	5.40	0.345
2	21194	15.40	0.389

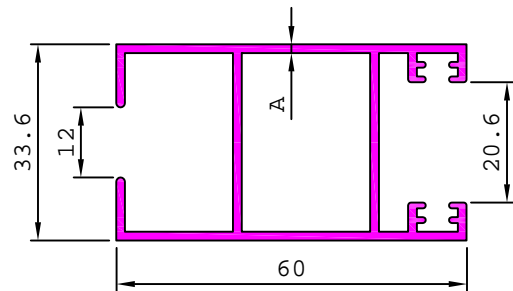

SL. No.	Section No.	A	Weight kg/m
1	20982	1.30	0.798
2	20774	1.50	0.918

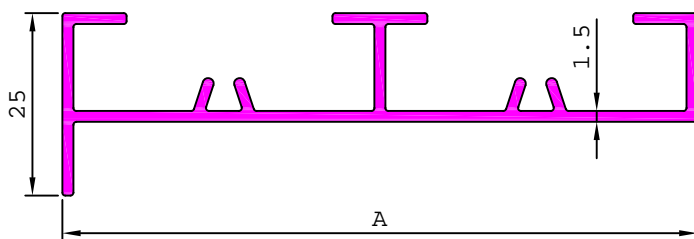

SL. No.	Section No.	A	Weight kg/m
1	21425	87.00	0.736
2	21426	132.00	0.918

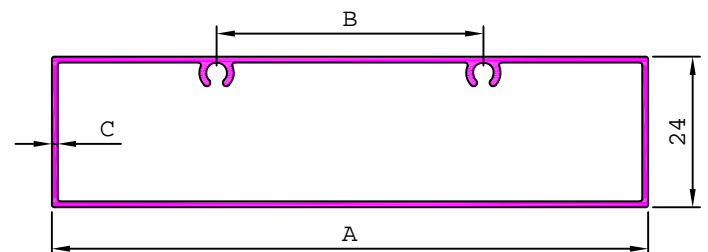

SL. No.	Section No.	A	B	C	Weight kg/m
1	21458	95.00	42.50	0.95	0.650
2	21459	116.00	58.00	1.06	0.839

ARCHITECTURAL

WINDOW SECTIONS

20526 0.425 kg/m

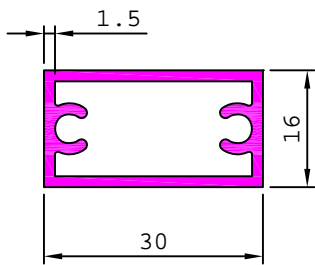

20780 0.557 kg/m

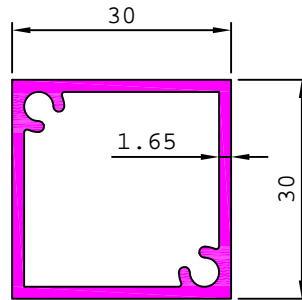

21580 0.671 kg/m

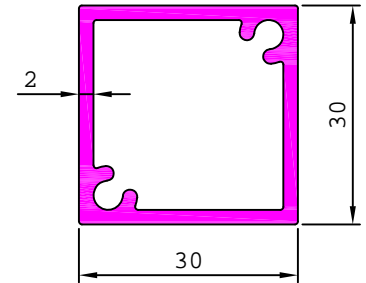

20611 0.452 kg/m

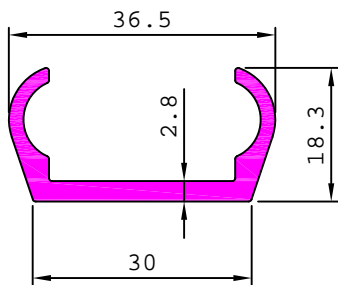

20663 0.472 kg/m

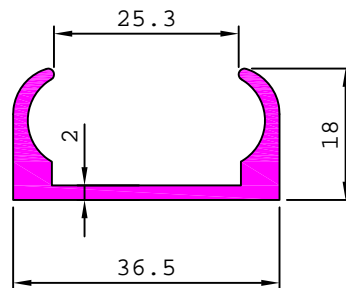

21108 0.417 kg/m

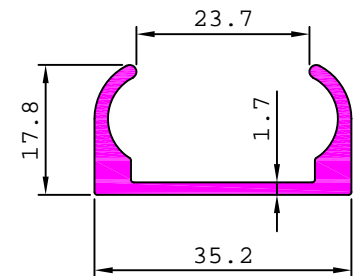

21379 0.357 kg/m

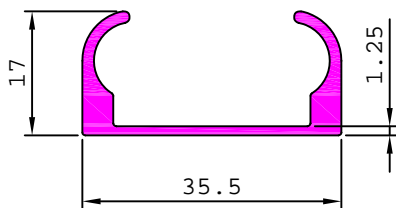

20514 0.715 kg/m

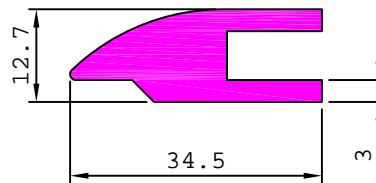

20699 0.156 kg/m

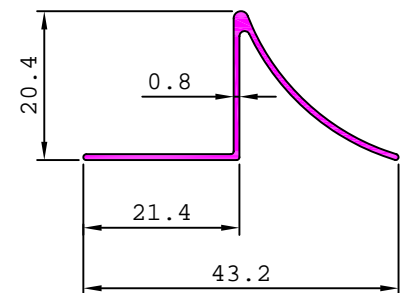

20700 0.165 kg/m

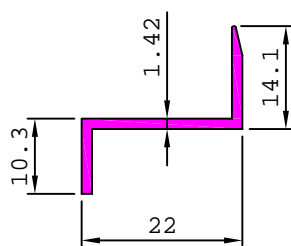

ARCHITECTURAL

WINDOW SECTIONS

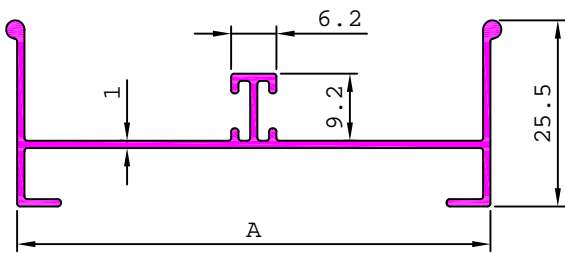

SL. No.	Section No.	A	Weight kg/m
1	21436	64.85	0.407
2	21461	78.00	0.442

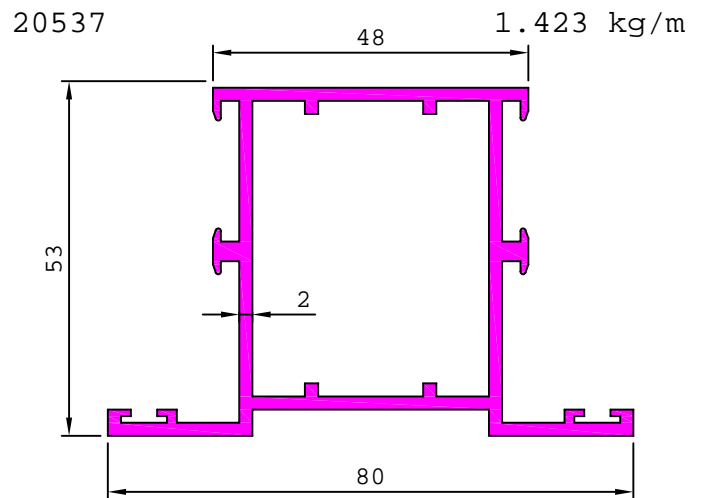

20540 0.521 kg/m

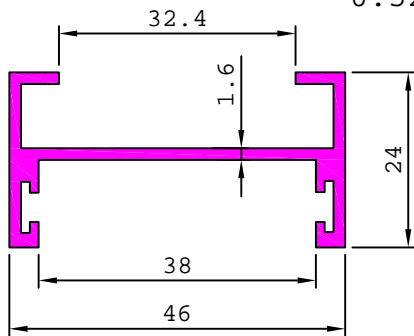

20554 0.969 kg/m

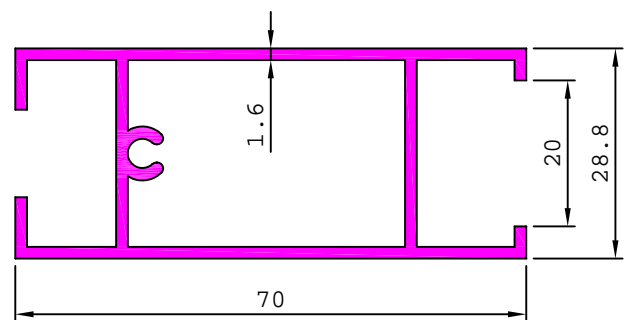

20701 0.785 kg/m

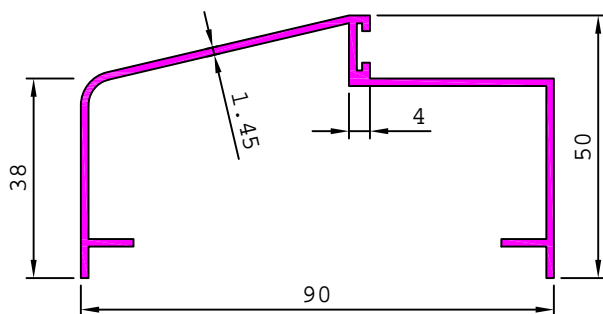

20728 0.930 kg/m

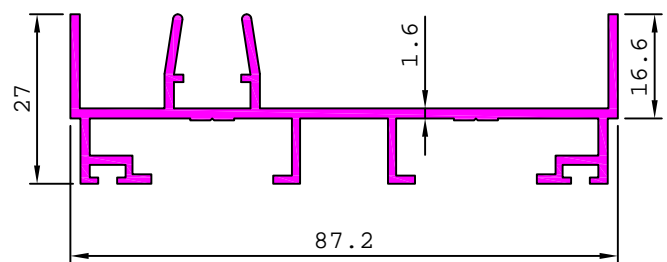

20729 1.305 kg/m

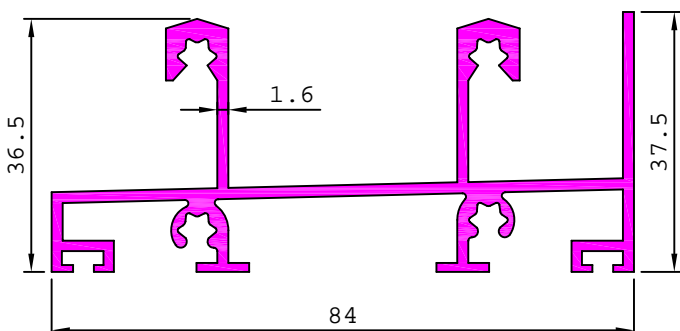

20744 1.476 kg/m

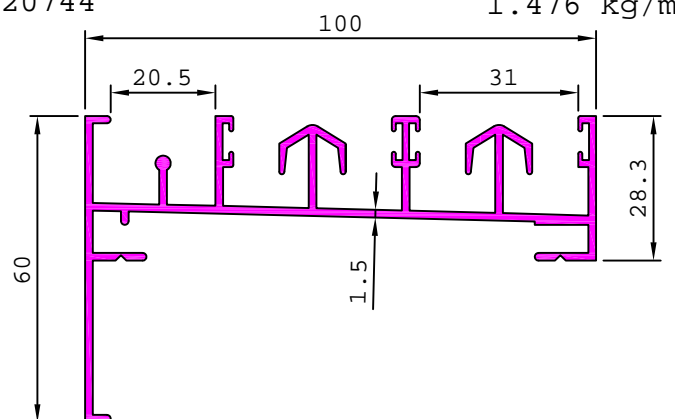

ARCHITECTURAL

WINDOW SECTIONS

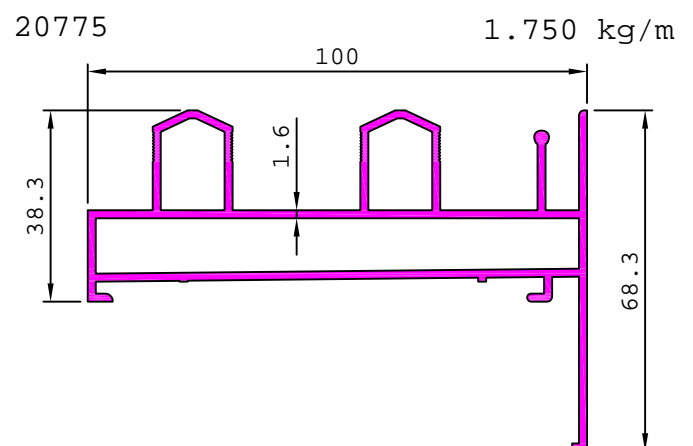
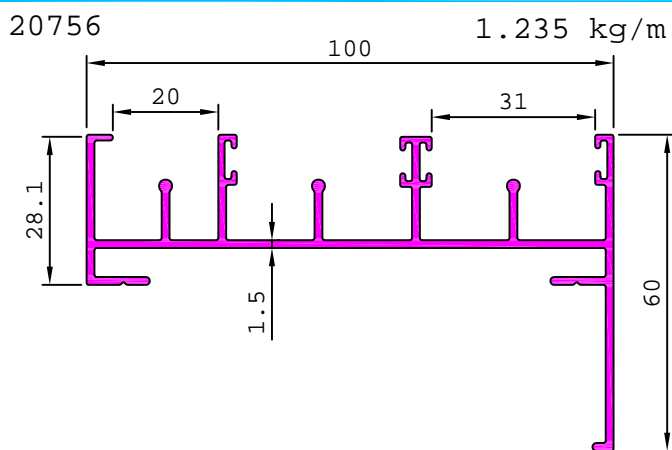
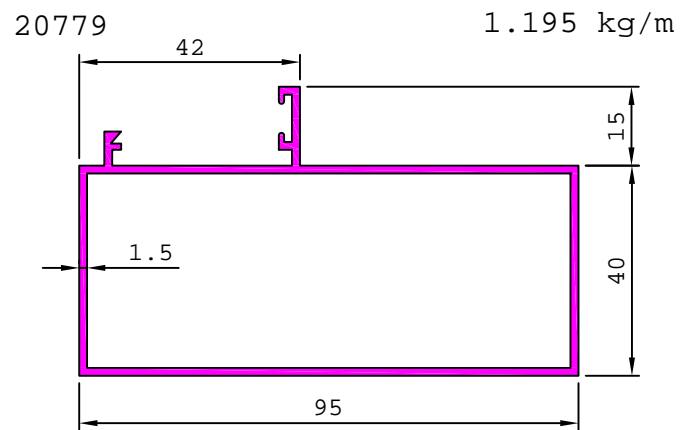
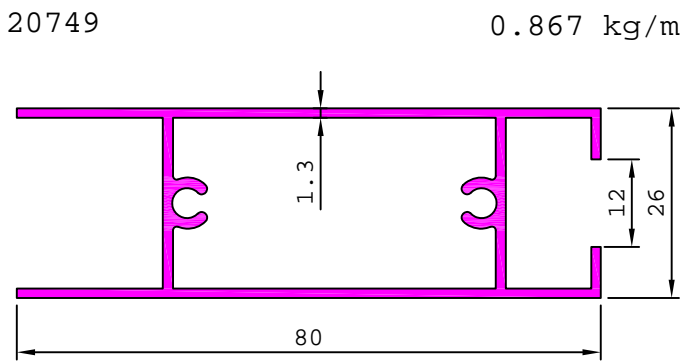
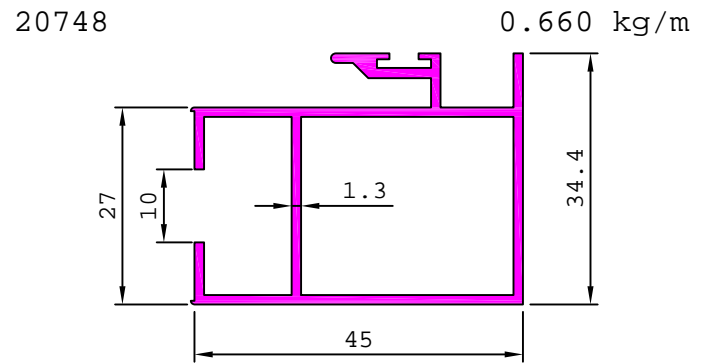
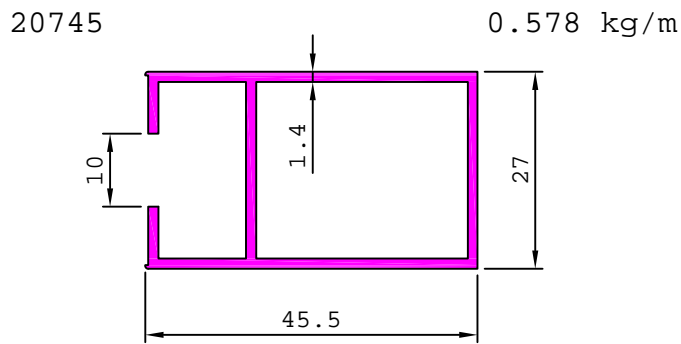
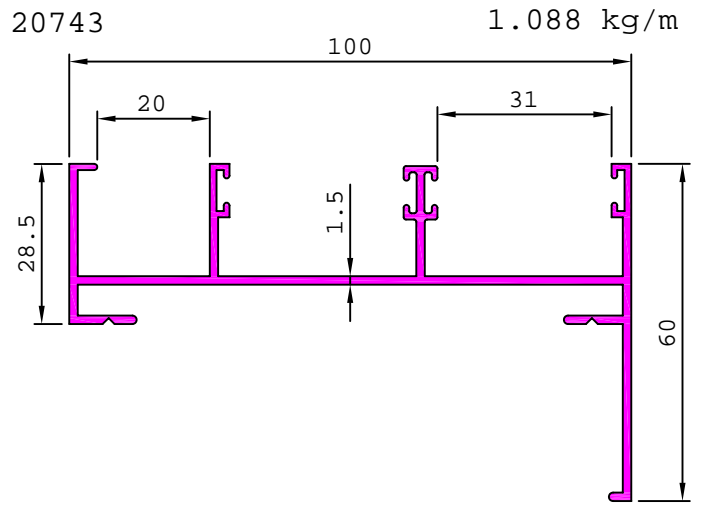
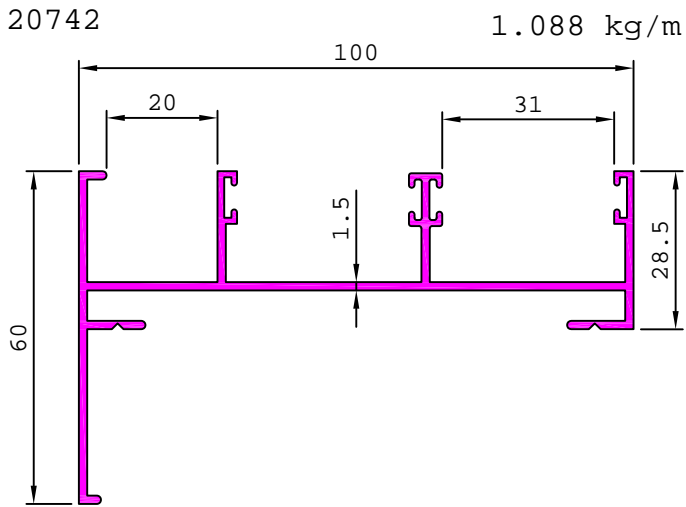

ARCHITECTURAL

WINDOW SECTIONS

20786

0.788 kg/m

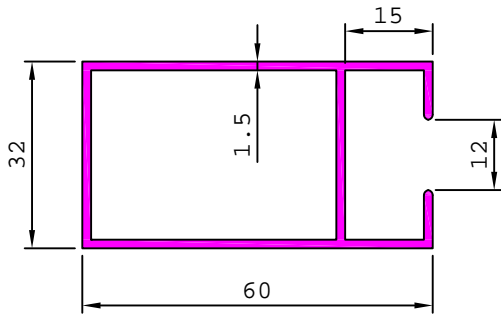

20788

1.005 kg/m

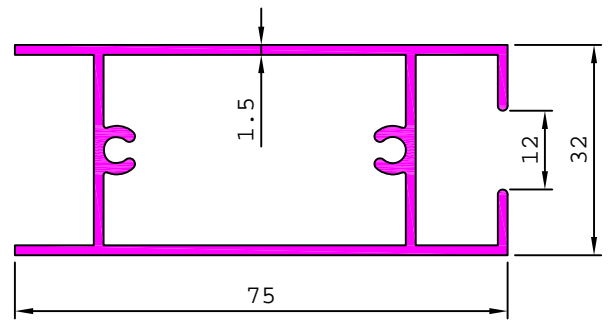

20792

1.488 kg/m

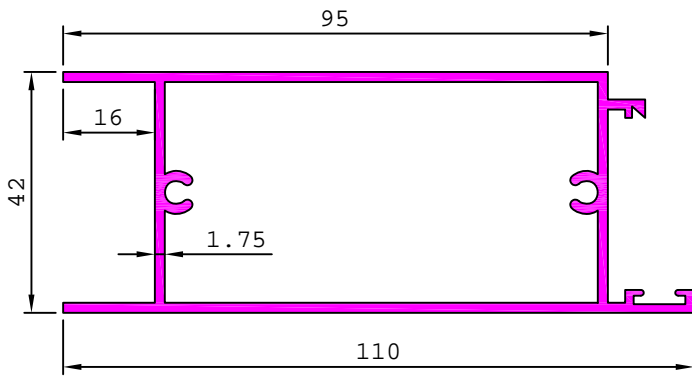

20794

1.394 kg/m

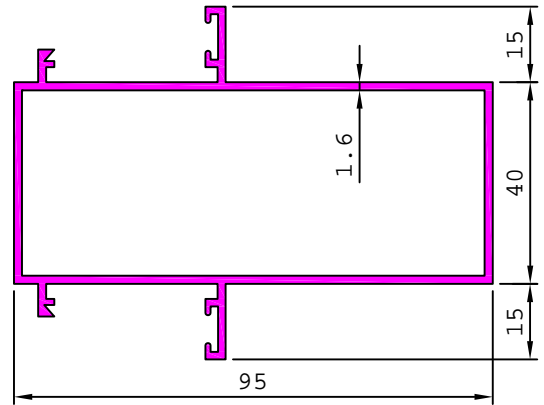

20795

1.233 kg/m

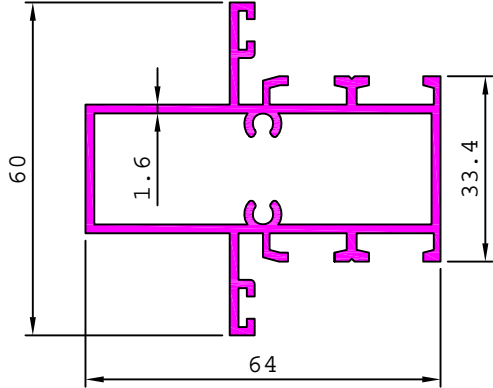

20819

1.383 kg/m

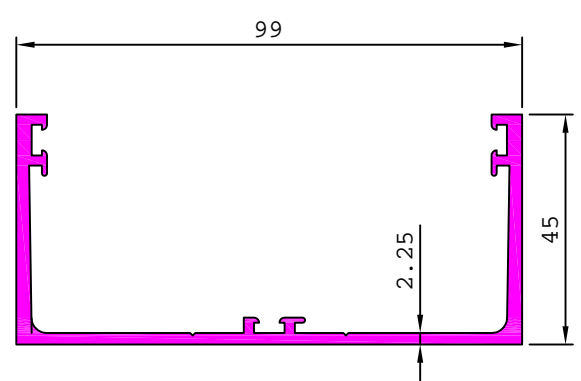

20820

2.397 kg/m

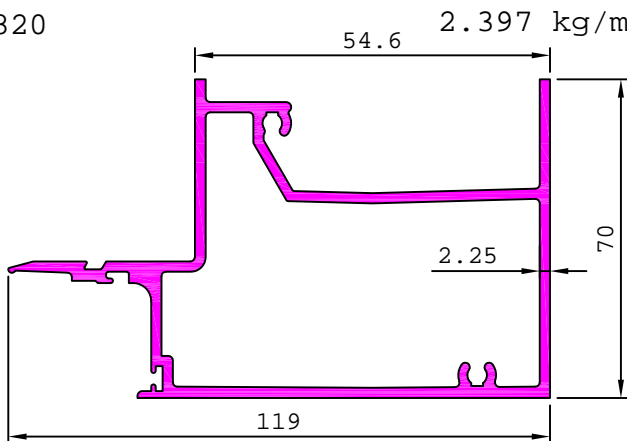

20821

1.747 kg/m

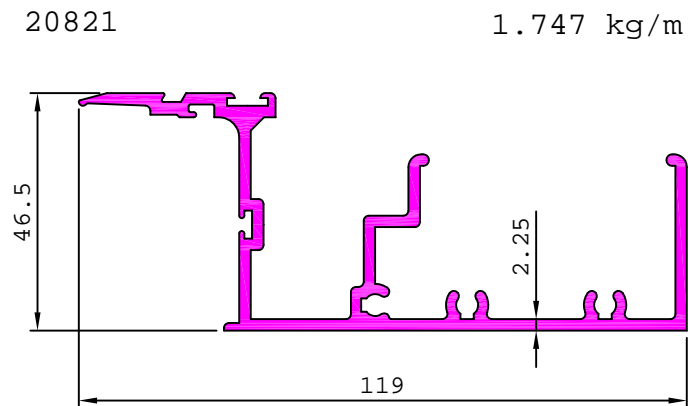

ARCHITECTURAL

WINDOW SECTIONS

20854 0.923 kg/m

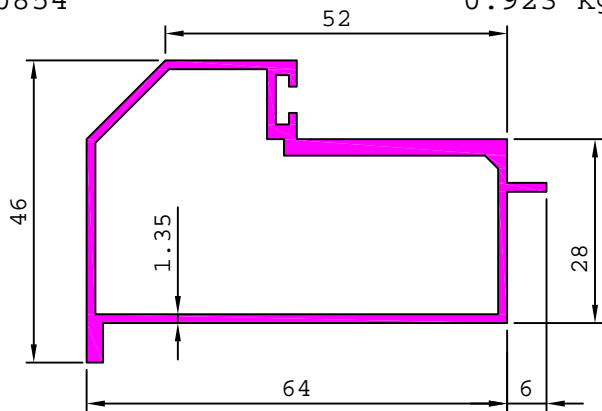

20861 0.858 kg/m

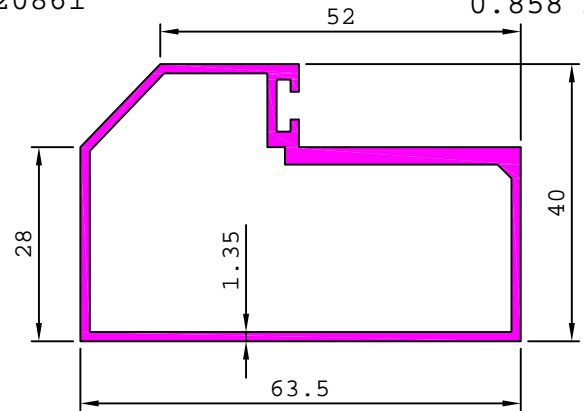

20879 0.904 kg/m

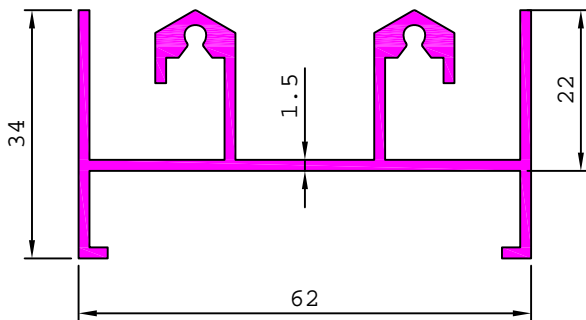

20880 1.218 kg/m

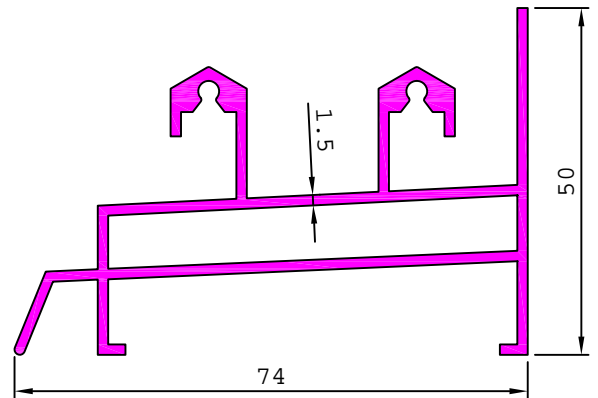

20881 0.748 kg/m

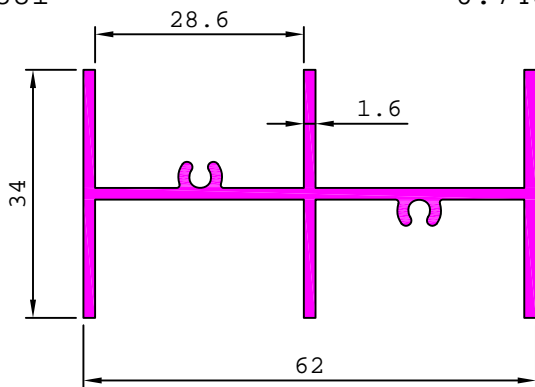

20890 0.657 kg/m

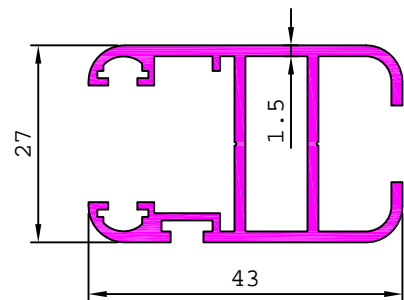

20901 0.827 kg/m

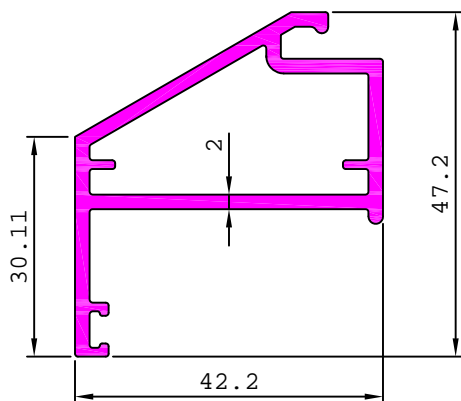

20917 0.656 kg/m

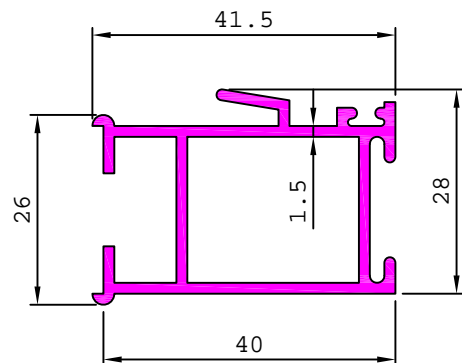

ARCHITECTURAL

WINDOW SECTIONS

20932 0.758 kg/m

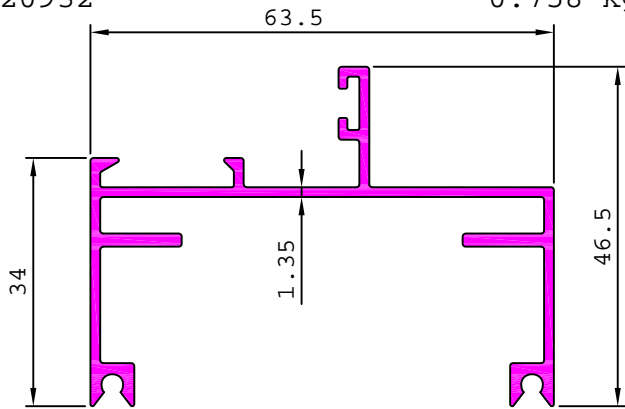

20934 1.093 kg/m

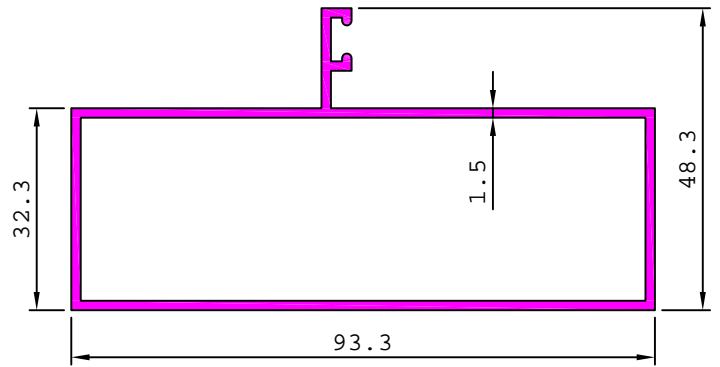

20971 0.885 kg/m

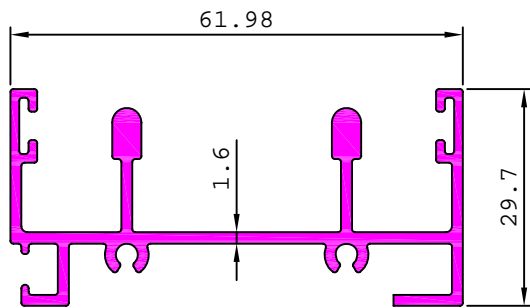

21004 0.848 kg/m

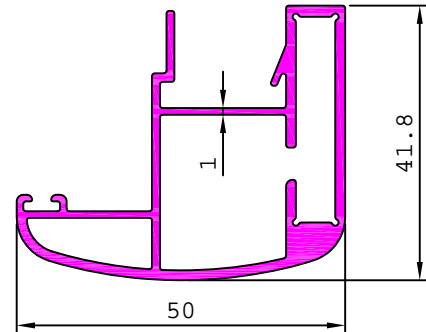

20980 1.649 kg/m

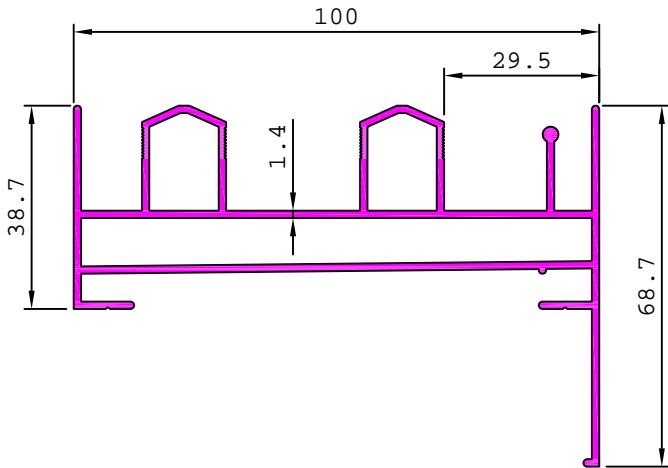

20981 1.167 kg/m

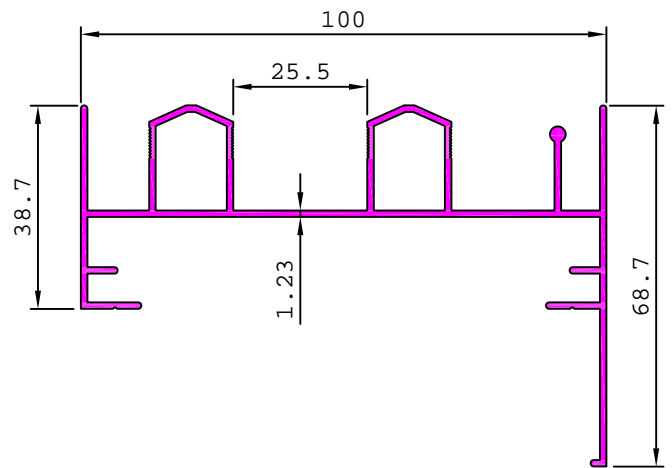

21003 0.875 kg/m

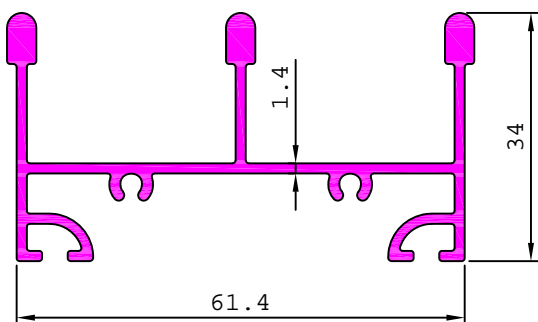

21007 0.994 kg/m

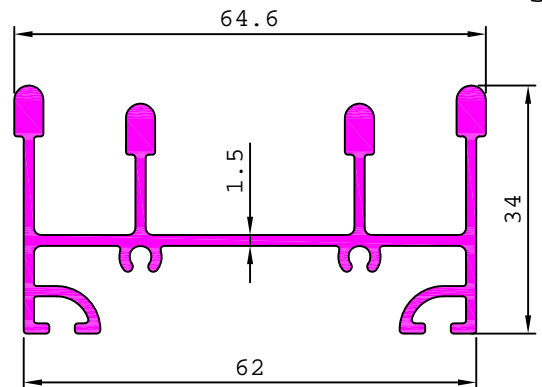

ARCHITECTURAL

WINDOW SECTIONS

21006

1.171 kg/m

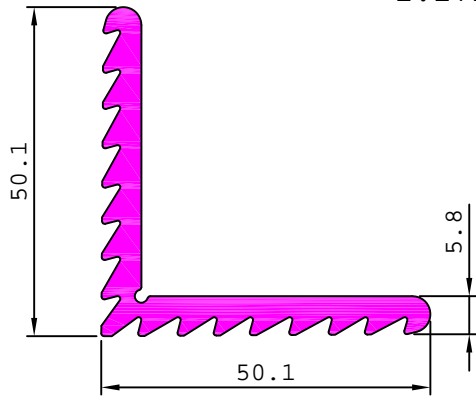

21036

0.588 kg/m

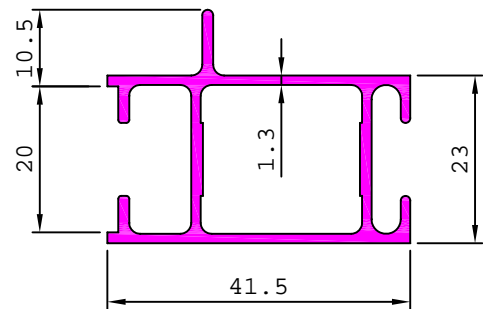

21037

0.594 kg/m

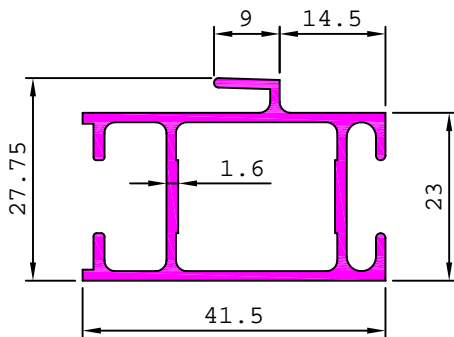

21047

0.940 kg/m

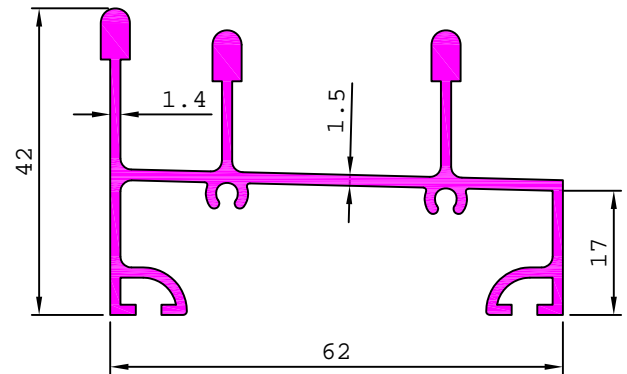

21049

0.977 kg/m

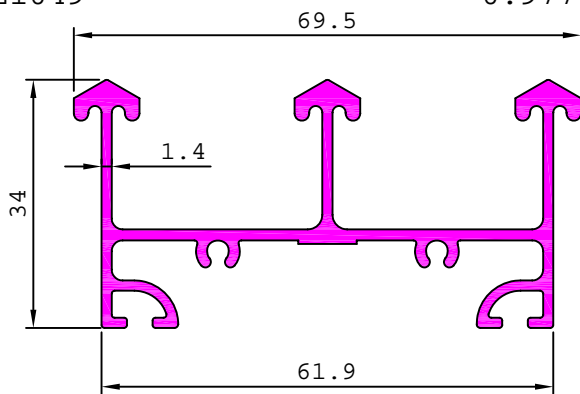

21058

0.786 kg/m

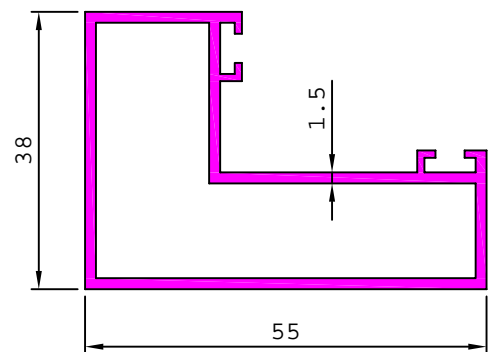

21069

0.916 kg/m

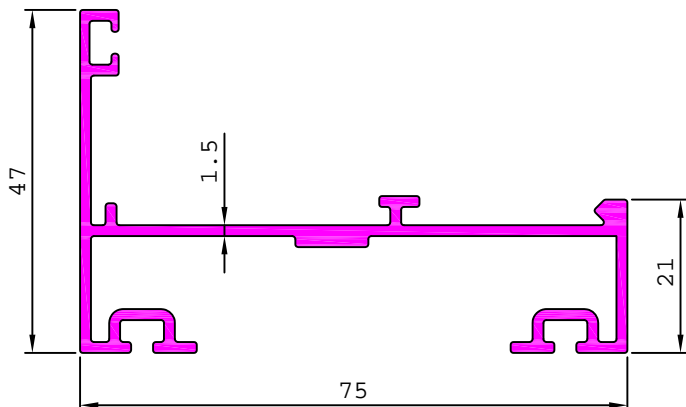

21072

0.994 kg/m

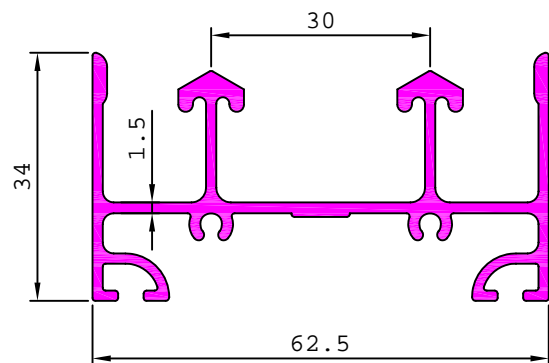

ARCHITECTURAL

WINDOW SECTIONS

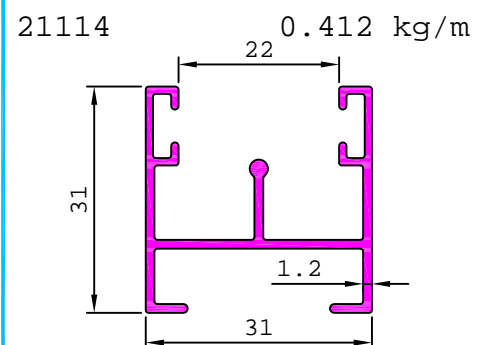
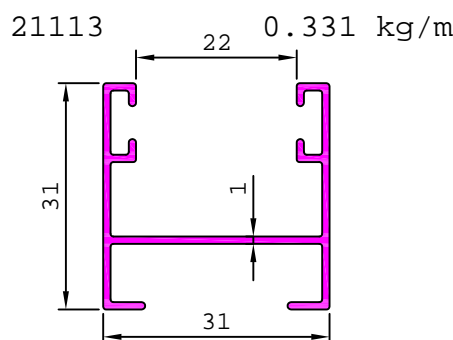
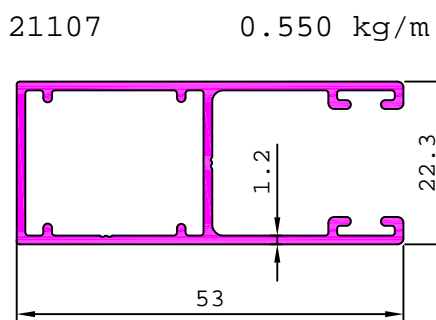
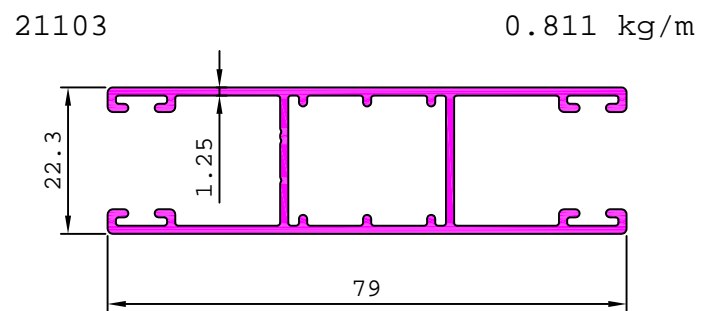
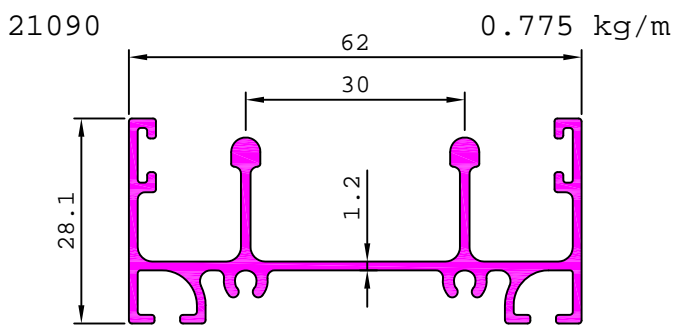
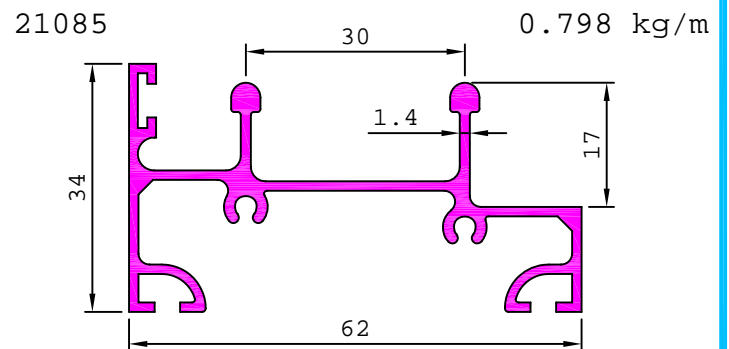
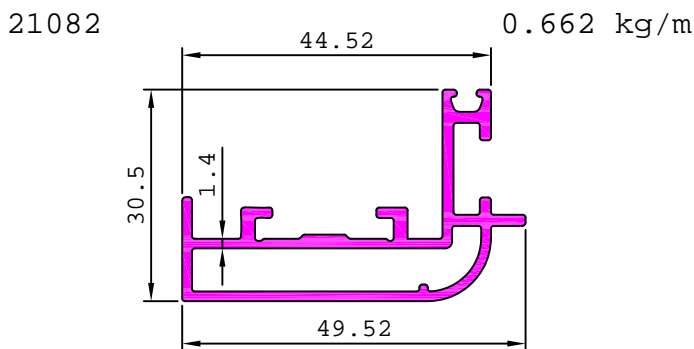
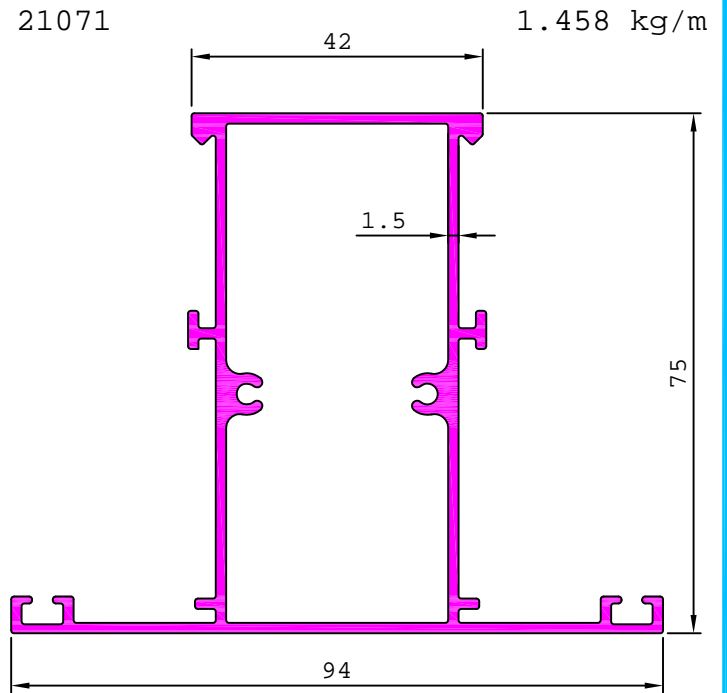
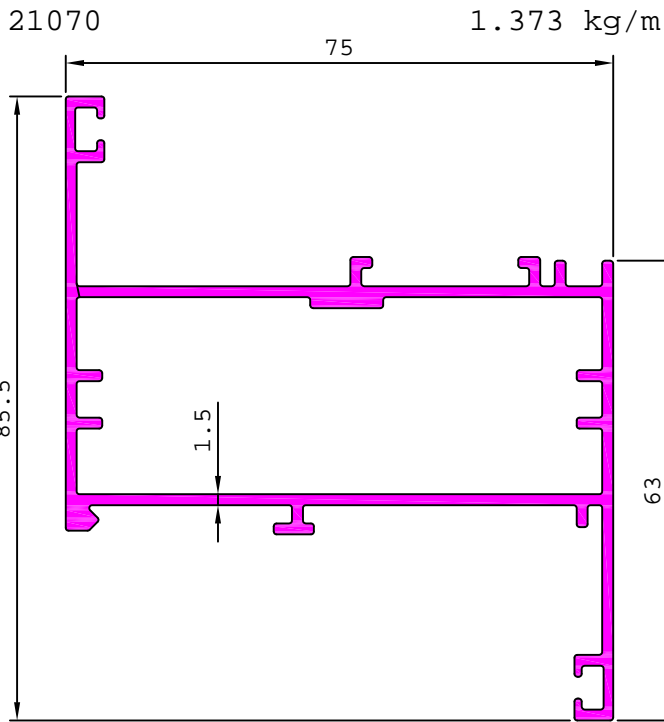

ARCHITECTURAL

WINDOW SECTIONS

21118

1.436 kg/m

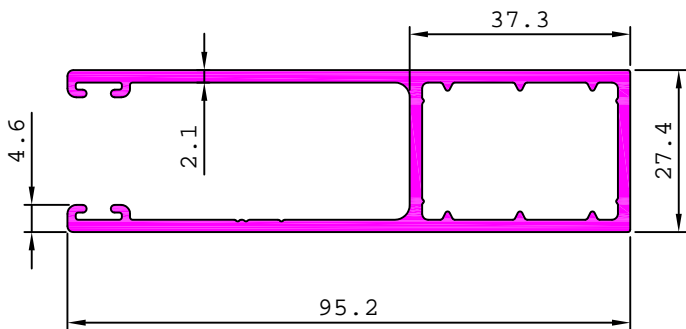

21121

1.331 kg/m

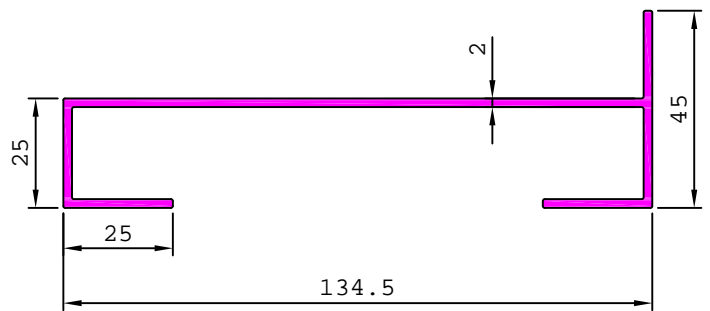

21122

1.895 kg/m

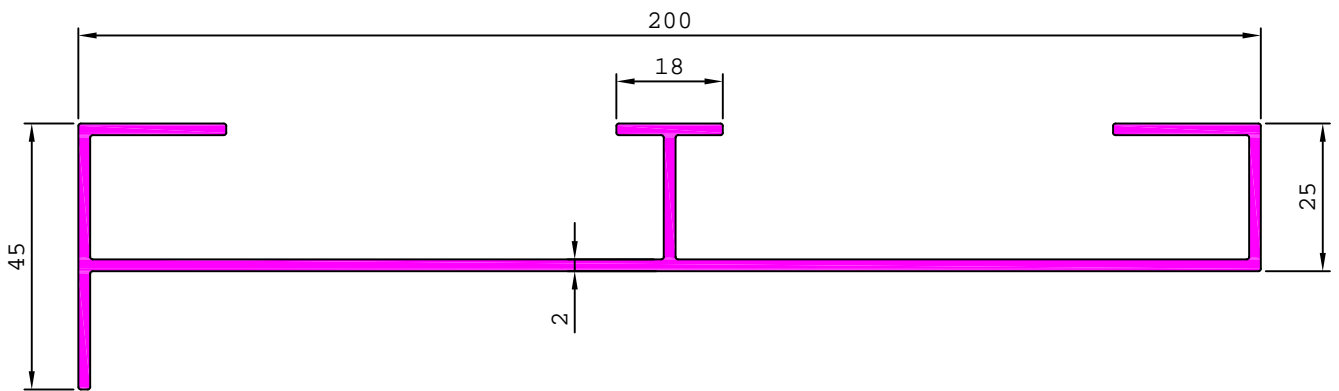

21159

1.969 kg/m

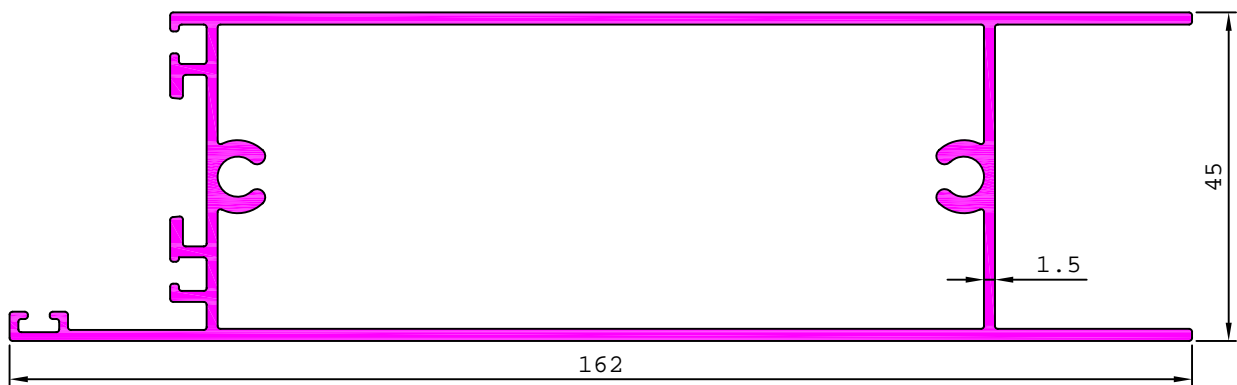

21165

1.047 kg/m

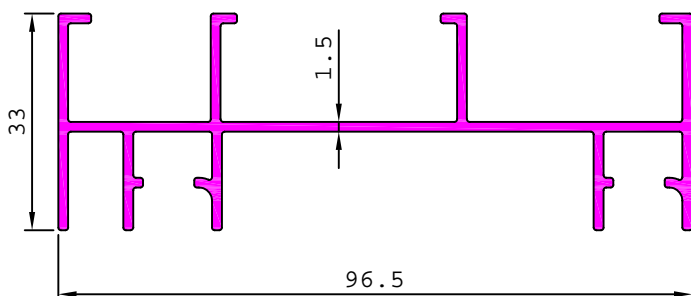

21167

0.406 kg/m

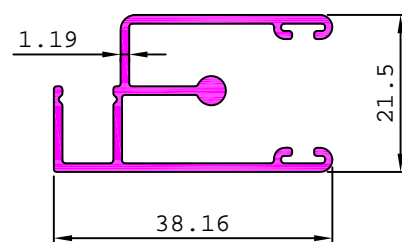

ARCHITECTURAL

WINDOW SECTIONS

21184 0.891 kg/m

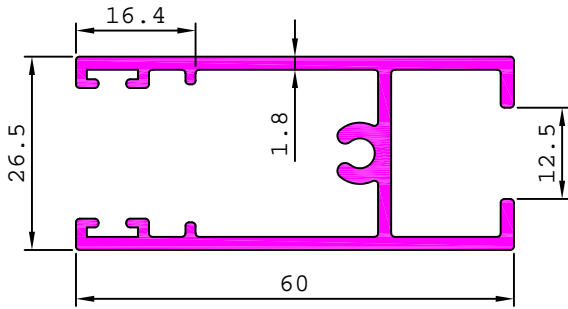

21180 1.478 kg/m

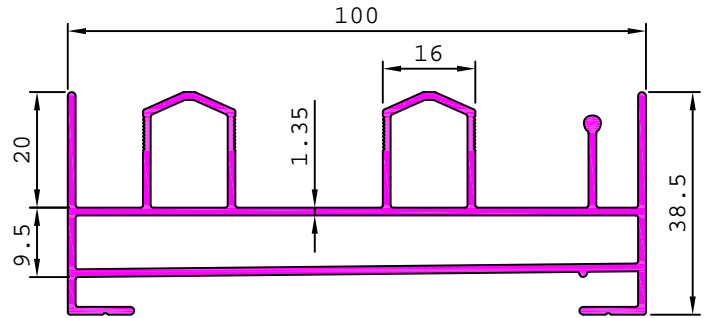

21181 0.171 kg/m

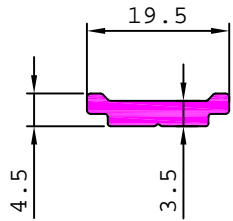

21183 2.129 kg/m

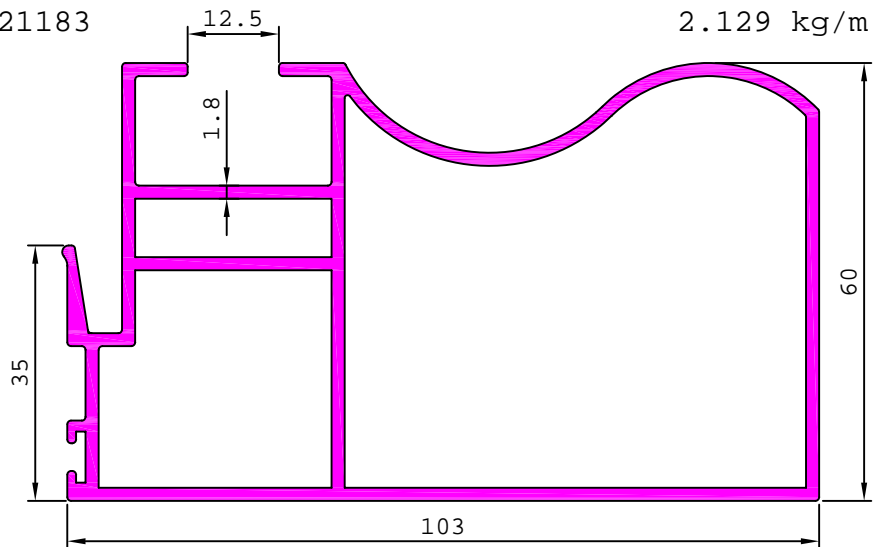

21179 0.174 kg/m

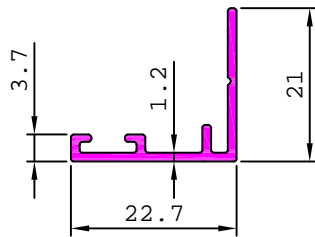

21188 1.548 kg/m

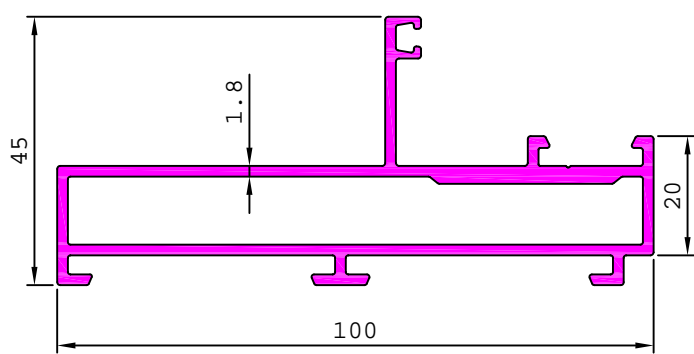

21192 1.691 kg/m

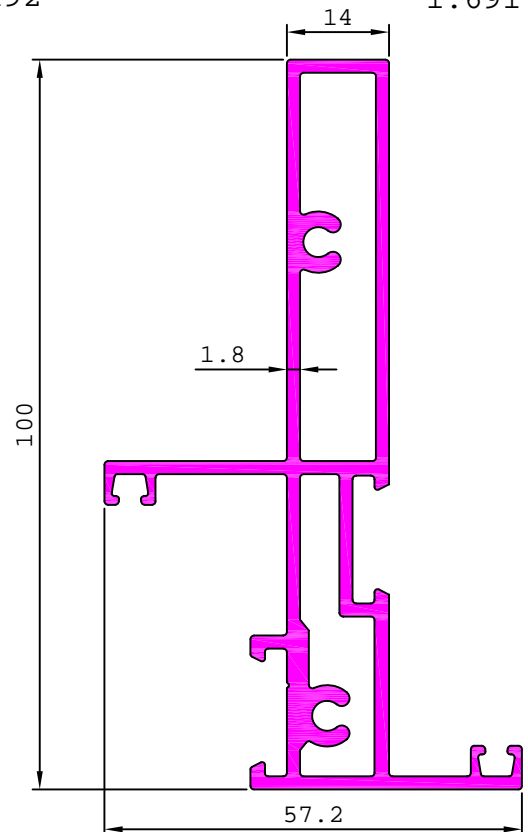

21191 1.279 kg/m

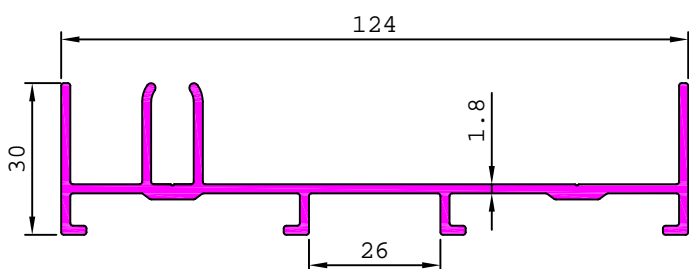

ARCHITECTURAL

WINDOW SECTIONS

21196

0.509 kg/m

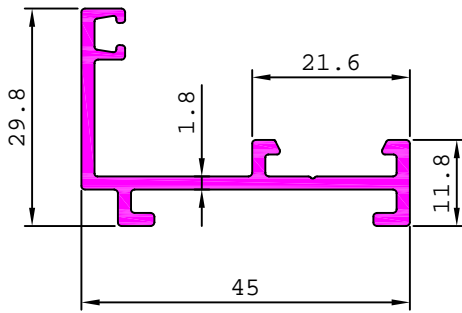

21199

1.709 kg/m

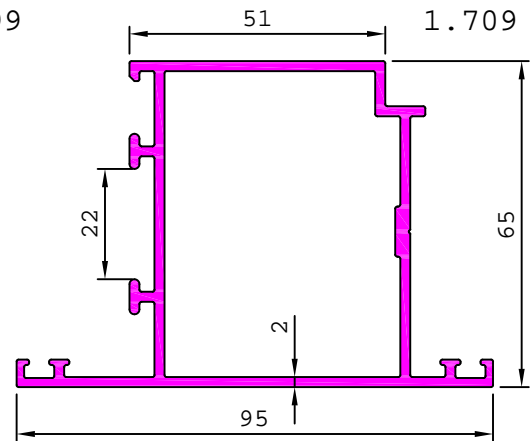

21200

1.636 kg/m

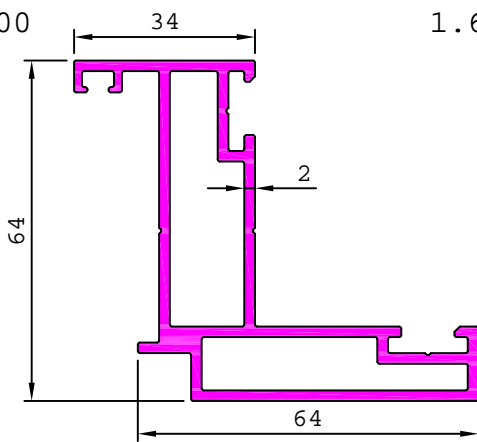

21201

2.477 kg/m

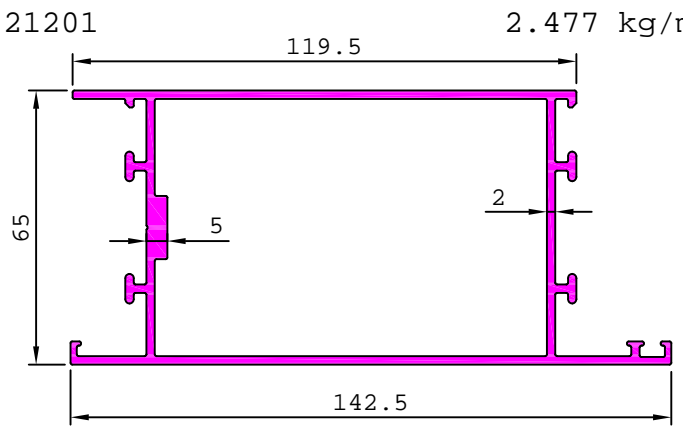

21202

2.485 kg/m

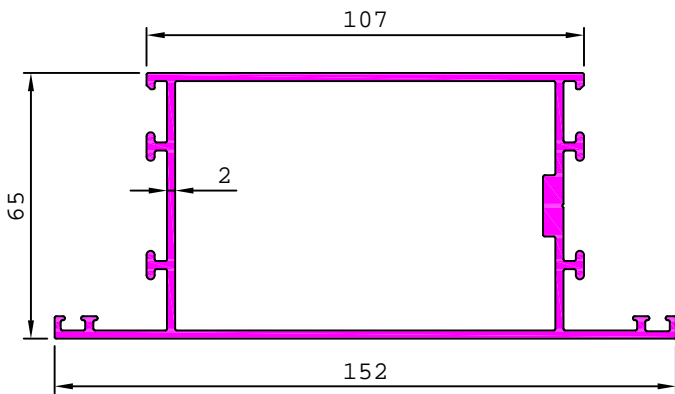

21210

0.988 kg/m

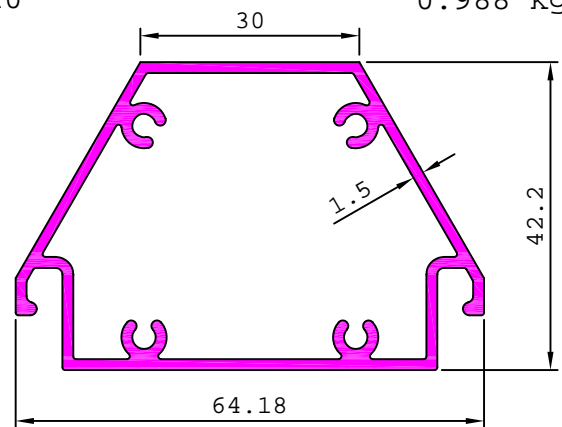

21211

0.689 kg/m

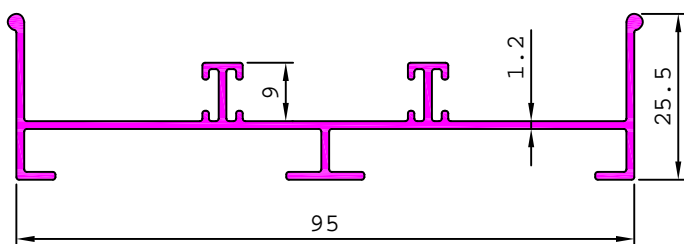

21212

0.866 kg/m

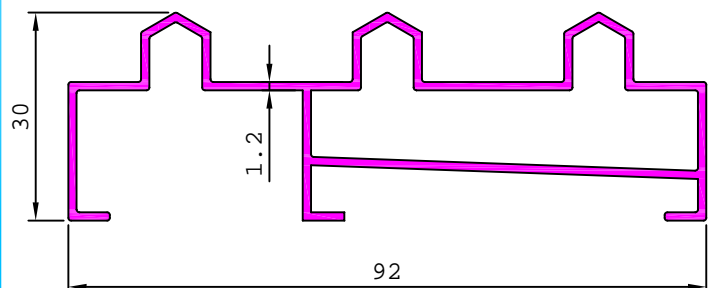

ARCHITECTURAL

WINDOW SECTIONS

21229

0.674 kg/m

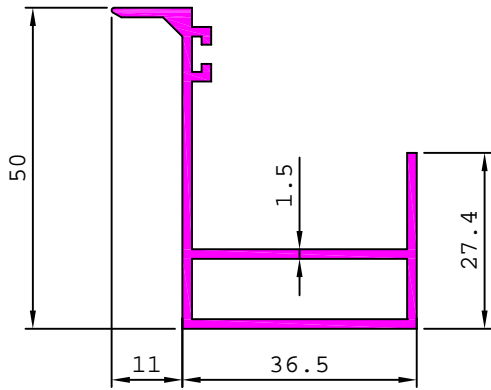

21237

0.714 kg/m

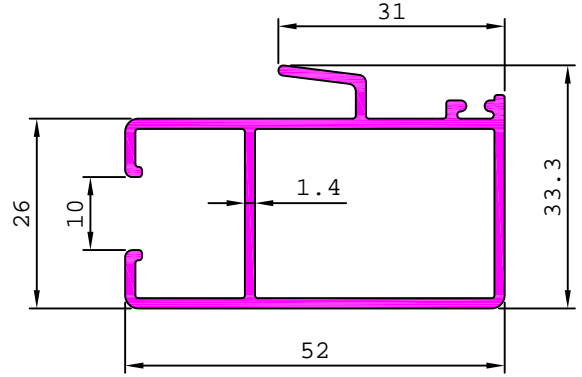

21233

0.290 kg/m

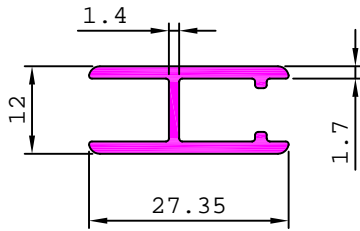

21251

0.431 kg/m

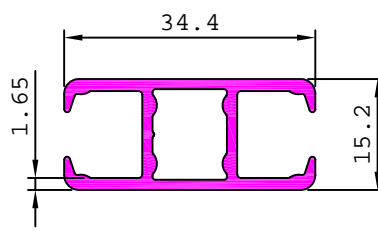

21255

0.154 kg/m

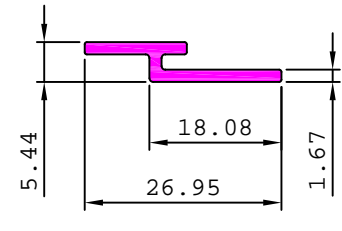

21250

0.909 kg/m

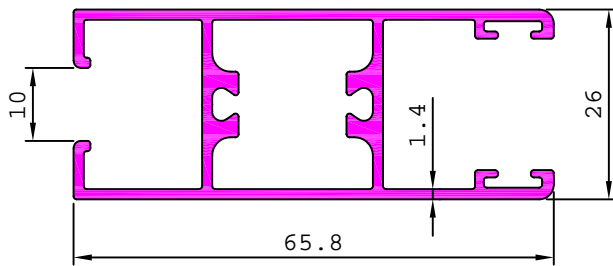

21256

0.810 kg/m

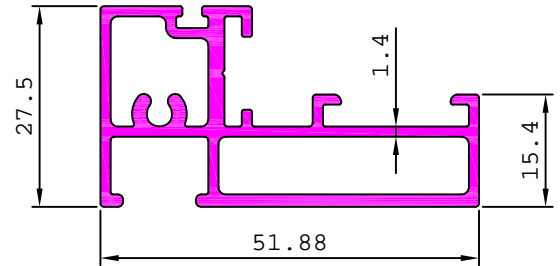

21257

0.935 kg/m

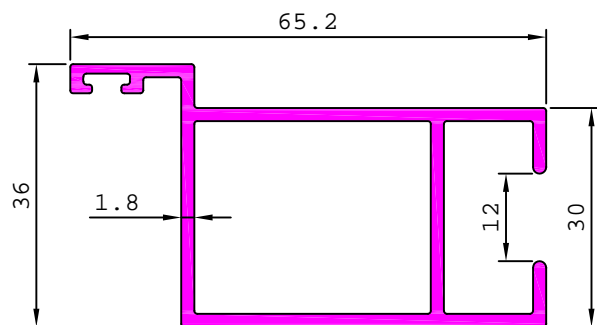

21273

1.462 kg/m

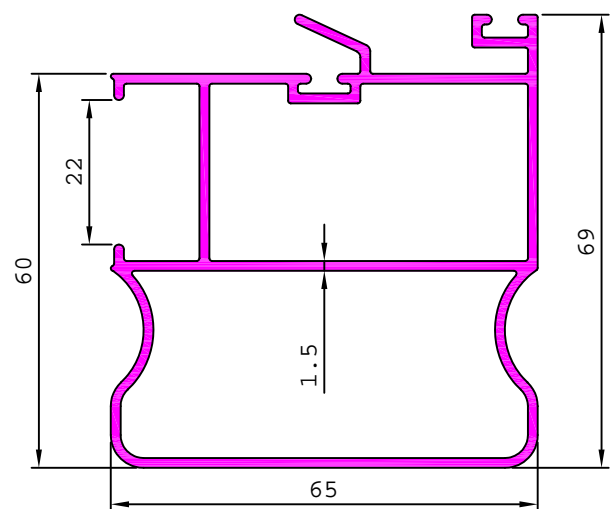

ARCHITECTURAL

WINDOW SECTIONS

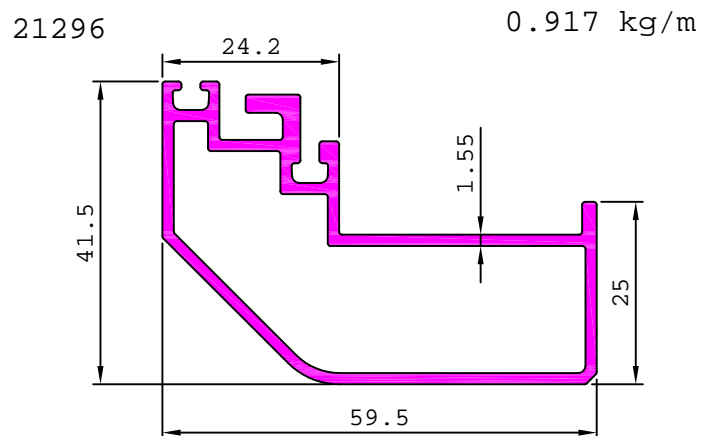
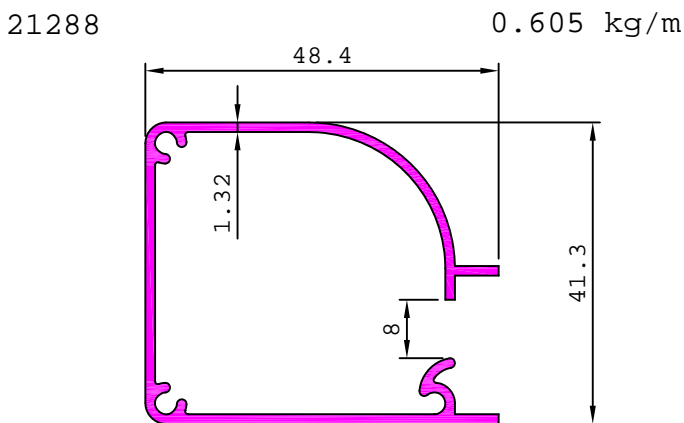
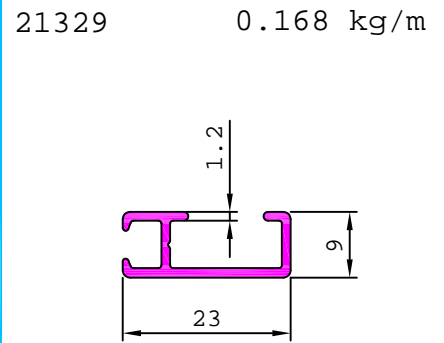
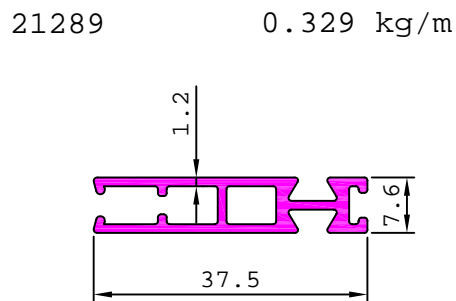
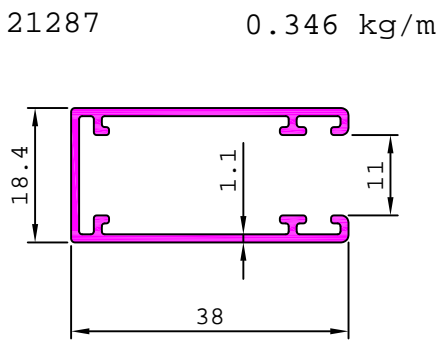
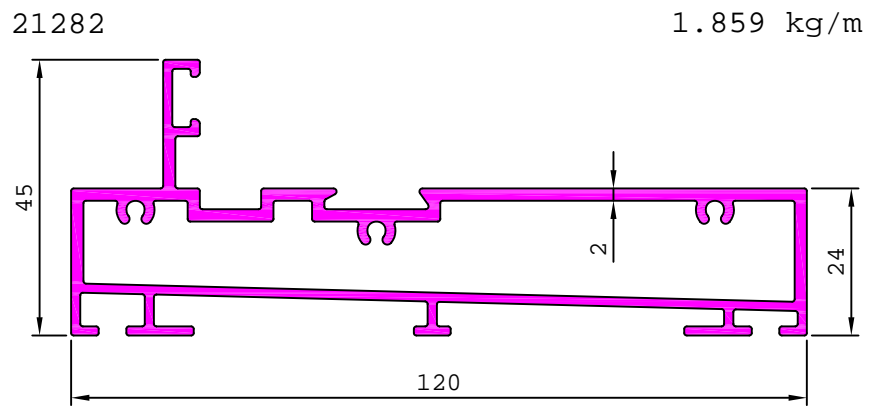
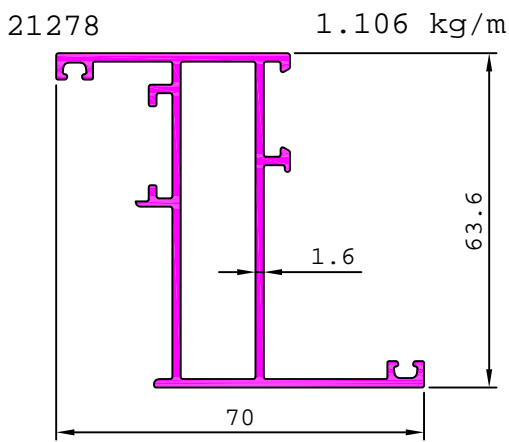
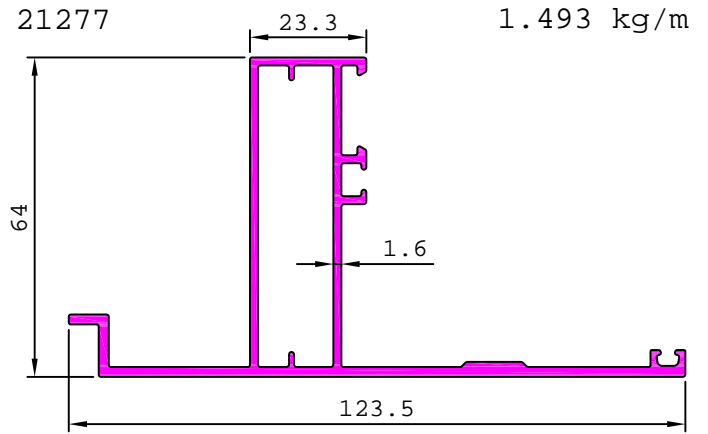
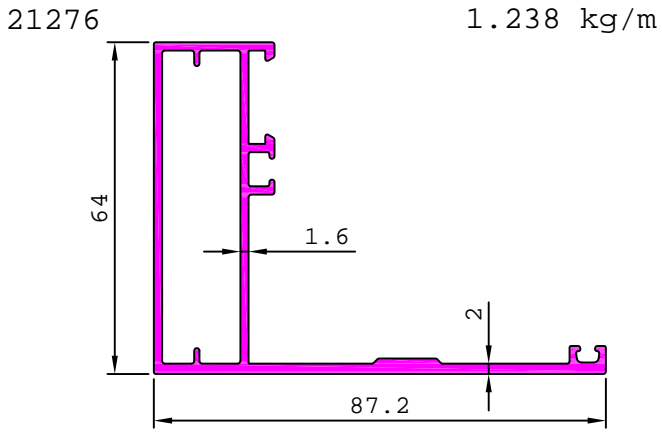

ARCHITECTURAL

WINDOW SECTIONS

21307 0.952 kg/m

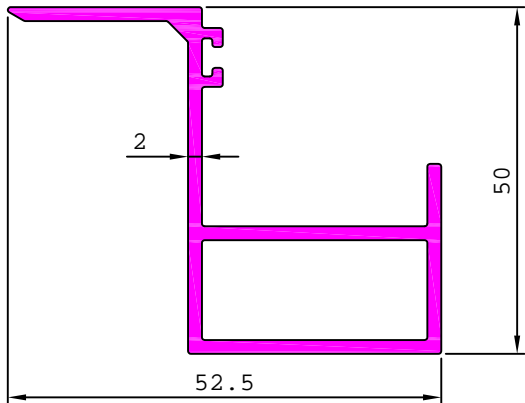

21315 1.755 kg/m

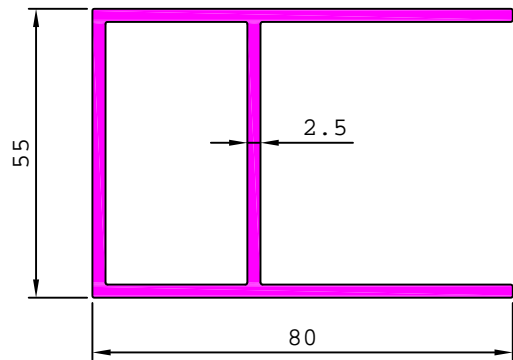

21319 0.612 kg/m

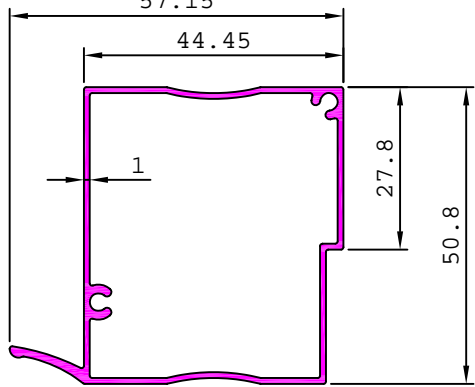

21328 0.899 kg/m

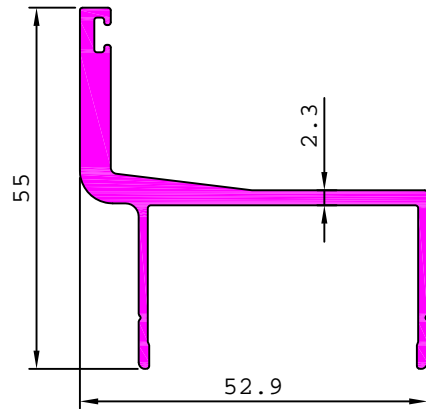

21327

2.663 kg/m

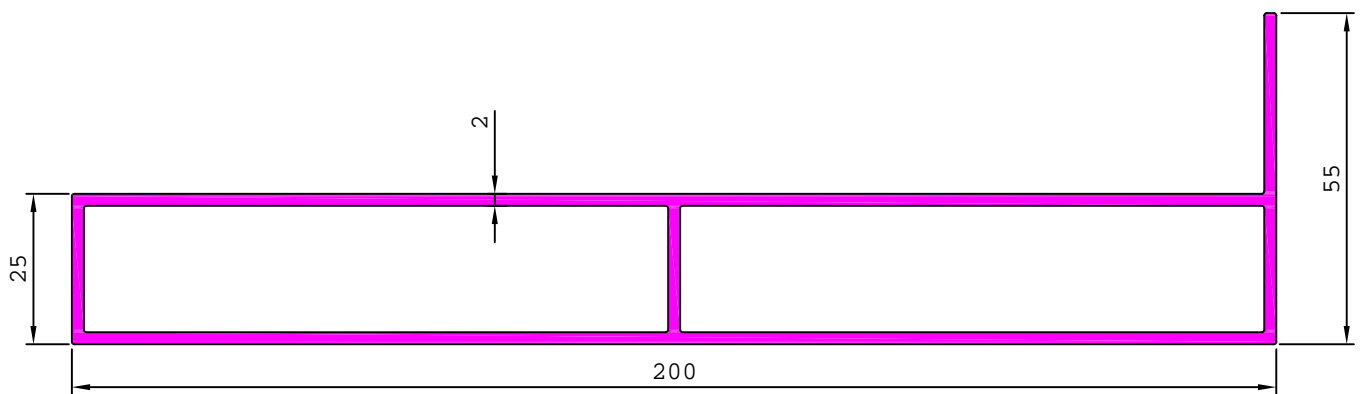

21330 0.716 kg/m

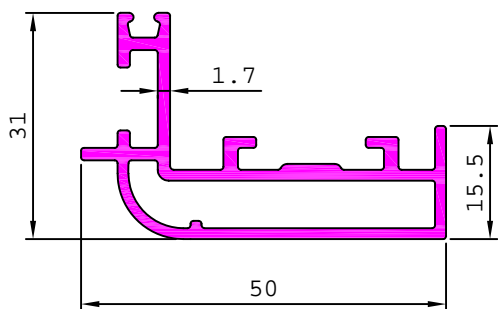

21298 0.969 kg/m

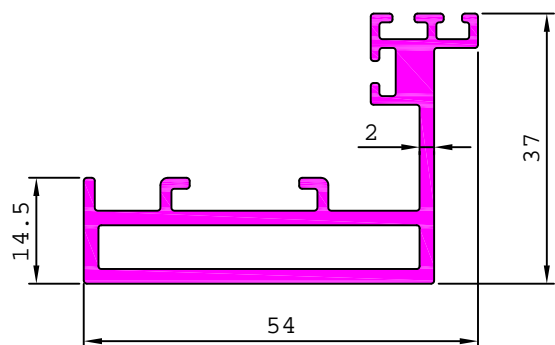

ARCHITECTURAL

WINDOW SECTIONS

21331 0.957 kg/m

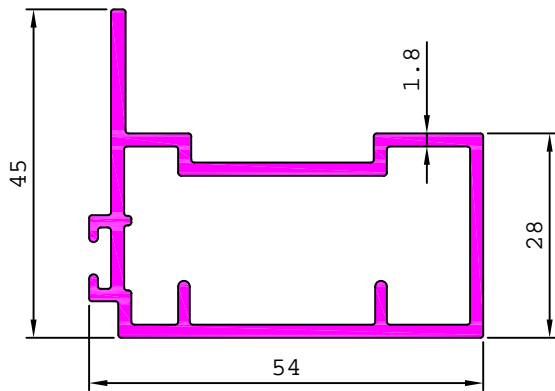

21332 0.578 kg/m

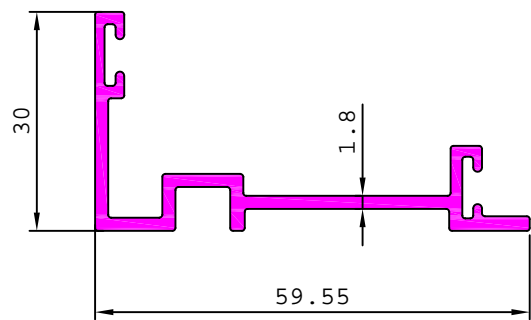

21362 2.259 kg/m

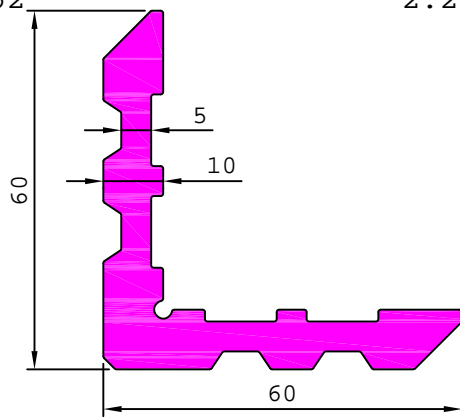

21365 0.773 kg/m

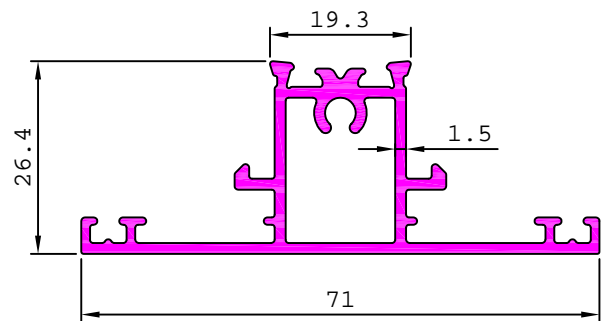

21364 0.628 kg/m

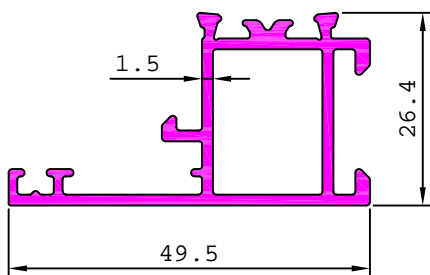

21366 0.631 kg/m

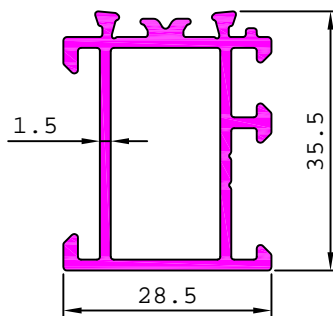

21367 0.705 kg/m

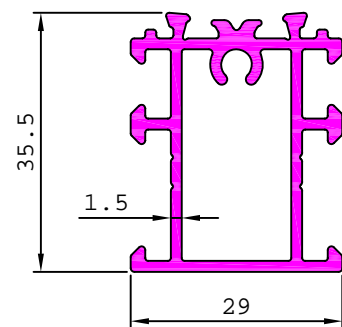

21371 0.979 kg/m

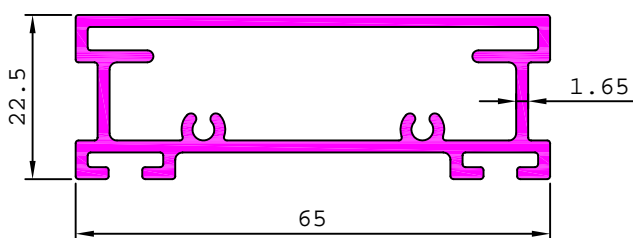

21383 1.007 kg/m

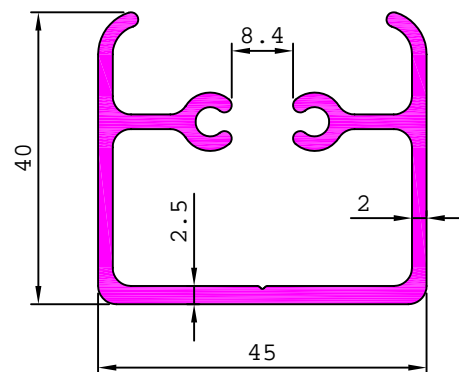

ARCHITECTURAL

WINDOW SECTIONS

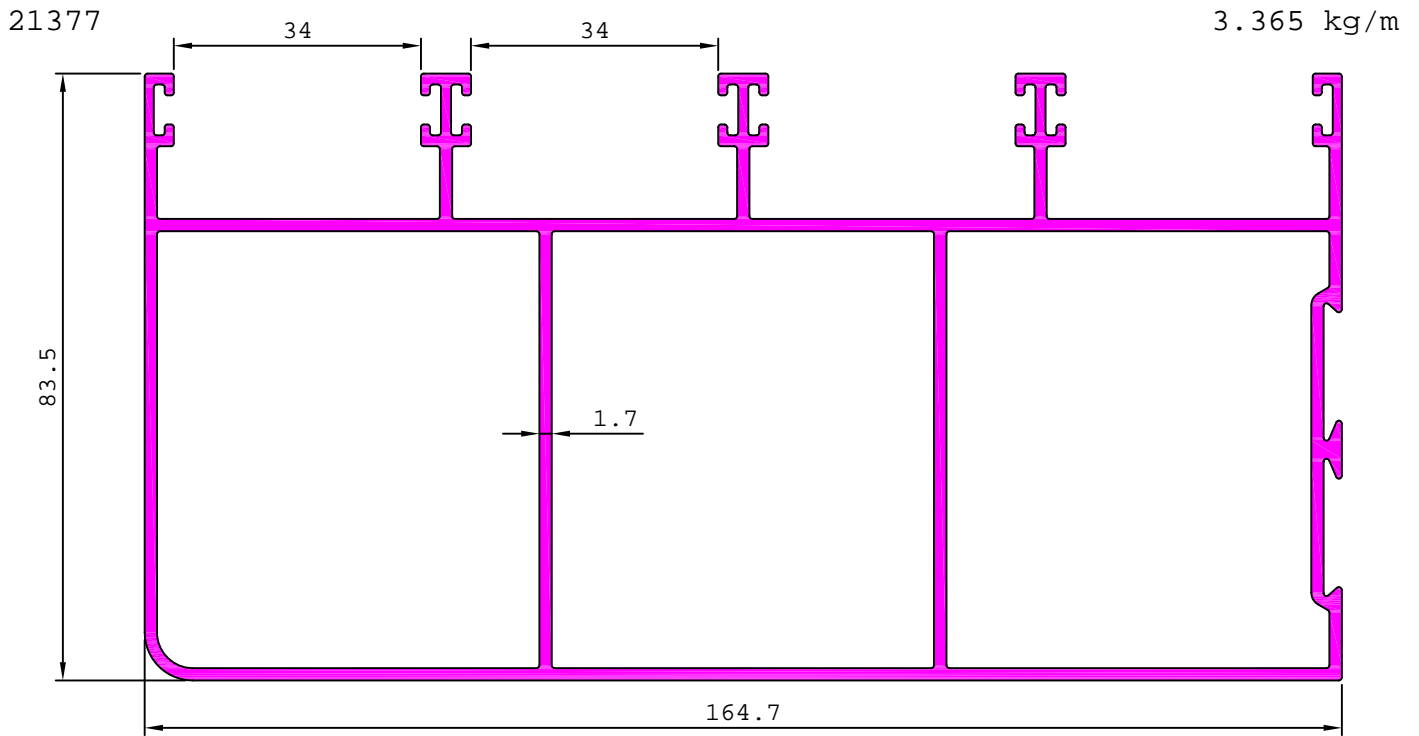

21378 0.351 kg/m

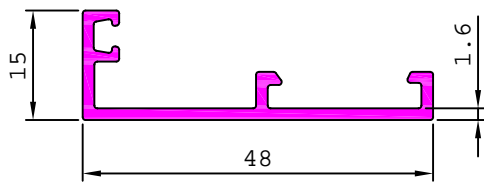

21387 0.525 kg/m

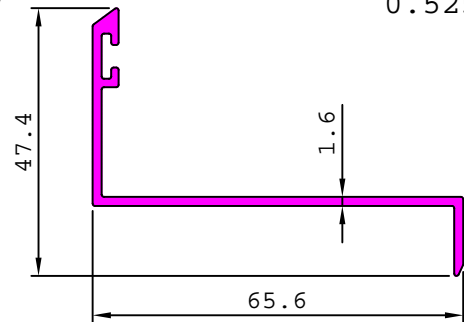

21388 0.740 kg/m

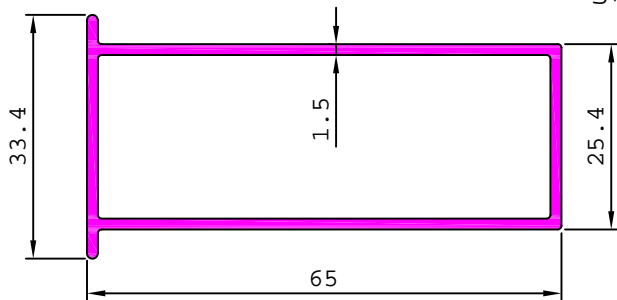

21399 1.105 kg/m

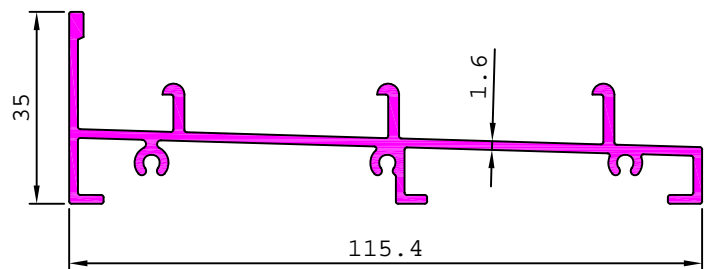

21403 0.219 kg/m

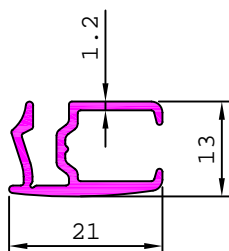

21404 0.340 kg/m

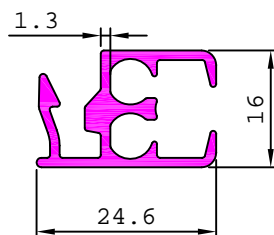

21422 0.332 kg/m

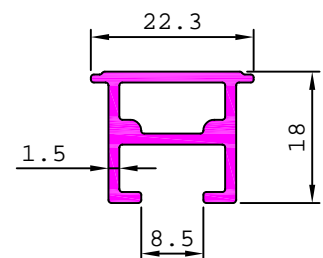

ARCHITECTURAL

WINDOW SECTIONS

<p>21390 1.513 kg/m</p>	<p>21405 1.366 kg/m</p>
<p>21410 0.404 kg/m</p>	<p>21411 0.793 kg/m</p>
<p>21416 1.573 kg/m</p>	<p>21418 0.645 kg/m</p>
<p>21423 0.449 kg/m</p>	<p>21424 0.526 kg/m</p>

ARCHITECTURAL

WINDOW SECTIONS

21433

0.918 kg/m

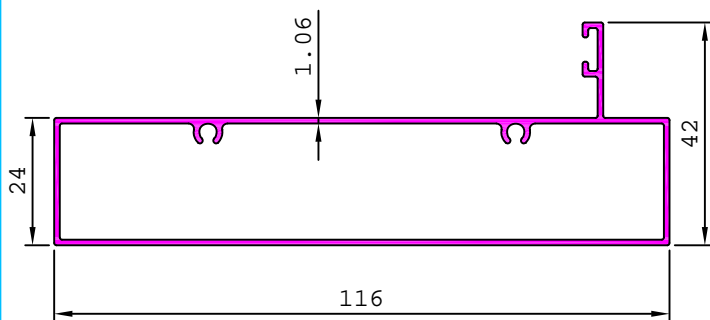

21434

1.017 kg/m

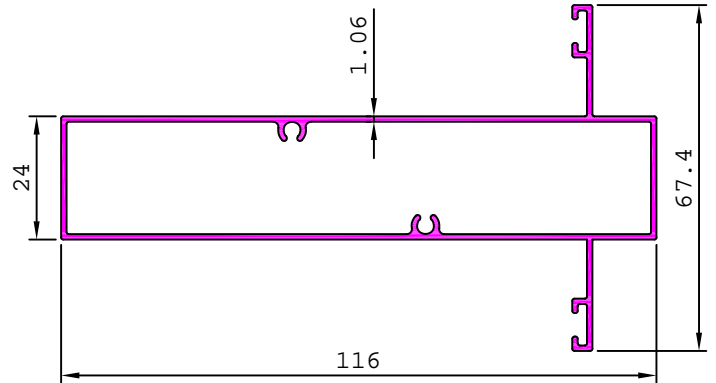

21435

0.263 kg/m

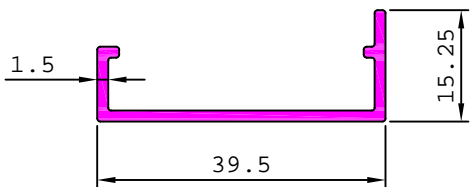

21438

0.706 kg/m

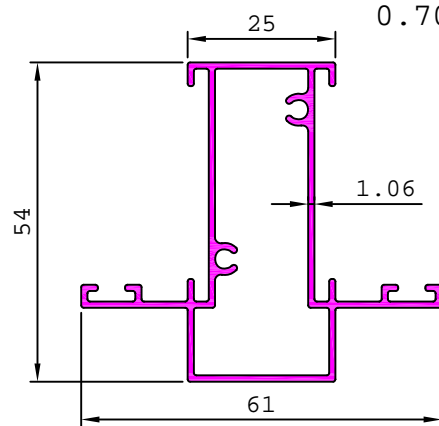

21439

0.620 kg/m

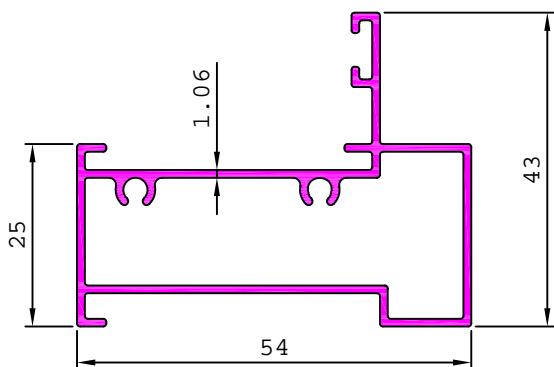

21441

0.602 kg/m

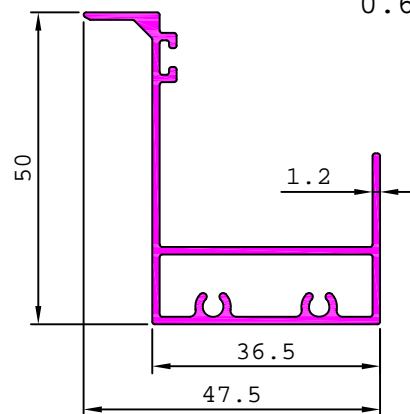

21440

0.661 kg/m

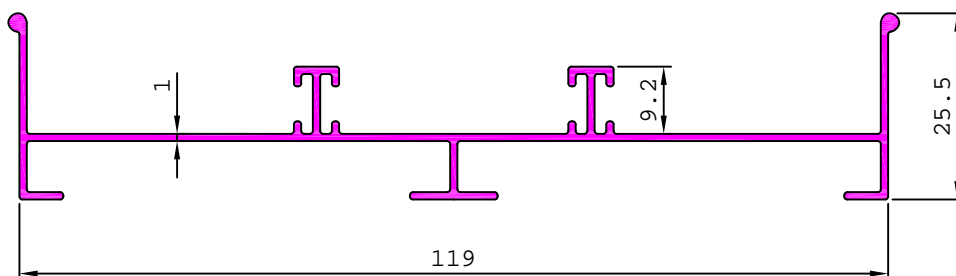

ARCHITECTURAL

WINDOW SECTIONS

21442 0.606 kg/m

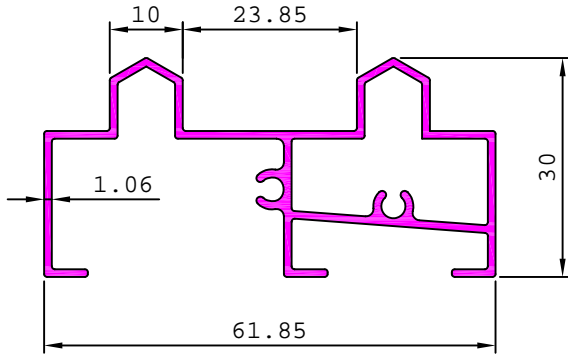

21463 0.798 kg/m

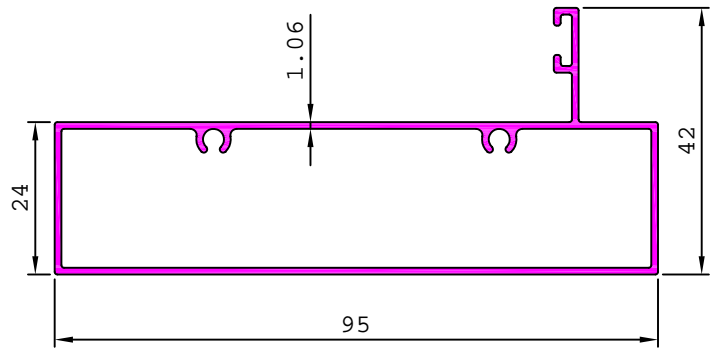

21464 0.876 kg/m

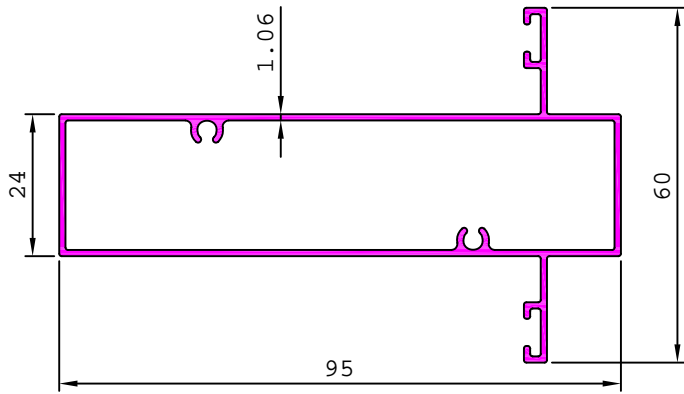

21467 0.979 kg/m

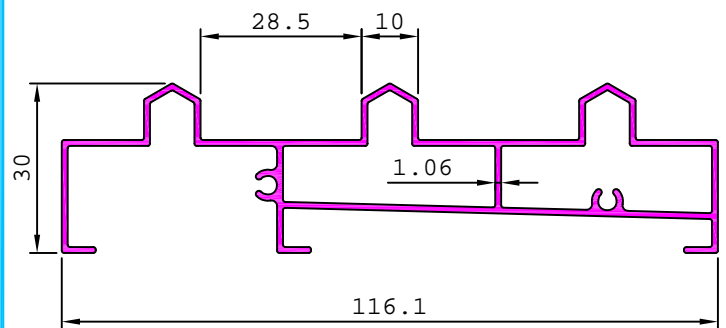

21475 0.580 kg/m

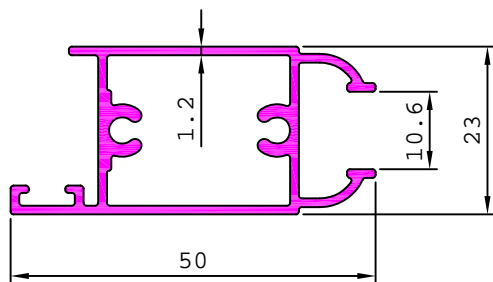

21476 0.700 kg/m

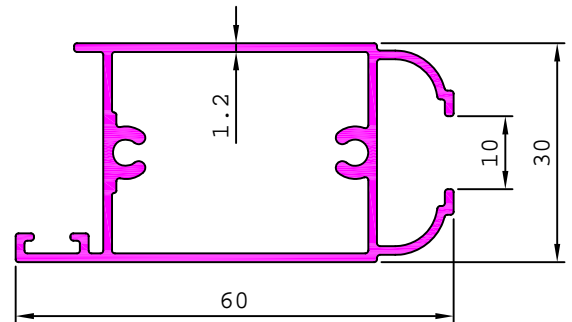

21477 1.247 kg/m

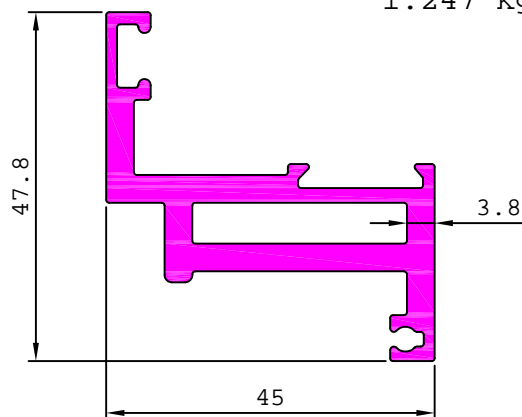

21482 0.855 kg/m

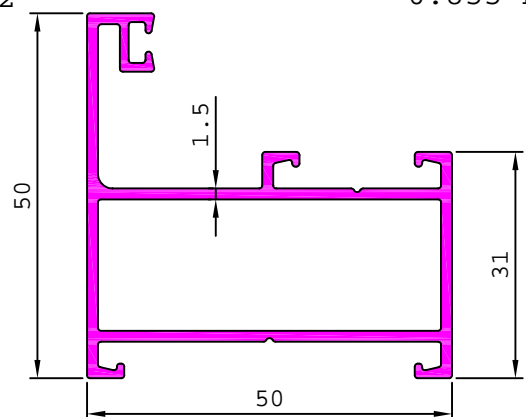

ARCHITECTURAL

WINDOW SECTIONS

21478

2.819 kg/m

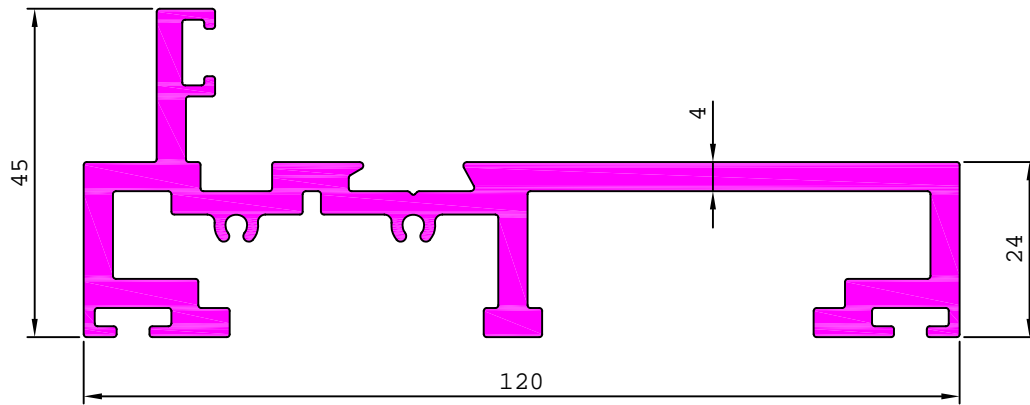

21479

3.820 kg/m

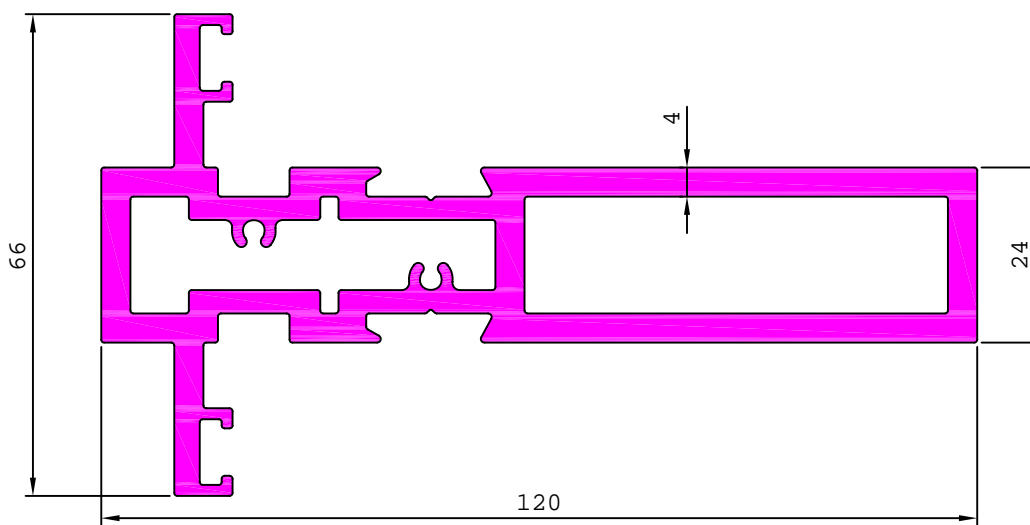

21499

1.190 kg/m

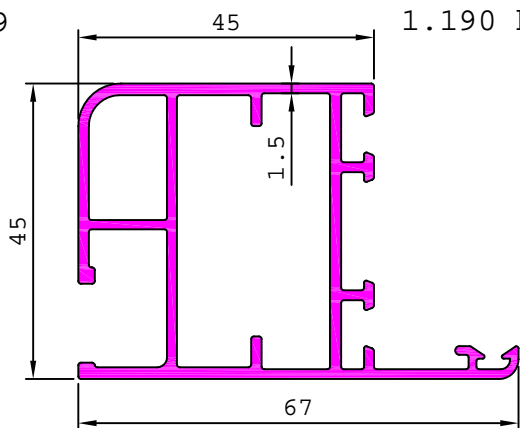

21503

0.968 kg/m

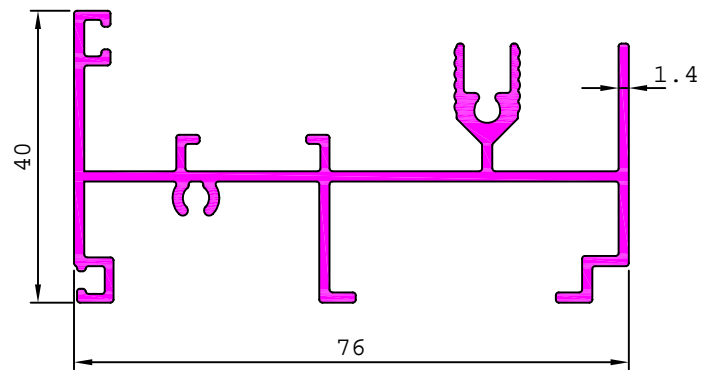

21500

1.064 kg/m

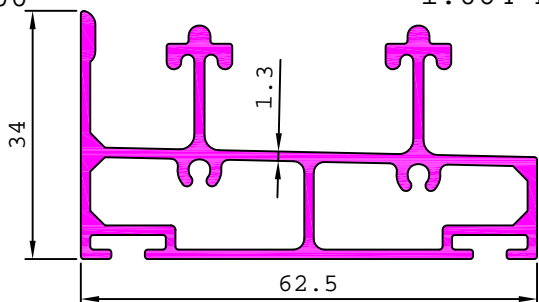

21502

0.992 kg/m

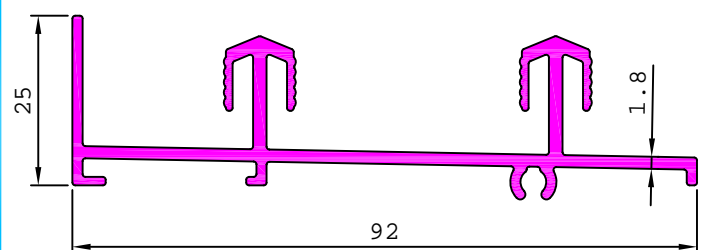

ARCHITECTURAL

WINDOW SECTIONS

21504

1.499 kg/m

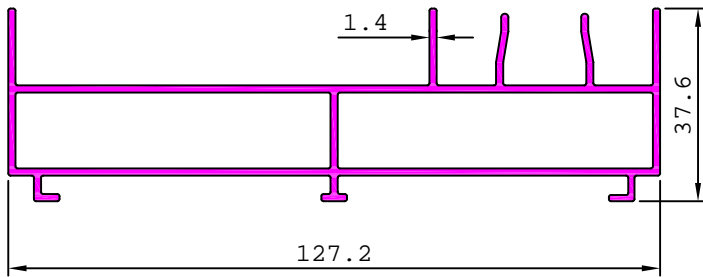

21505

1.443 kg/m

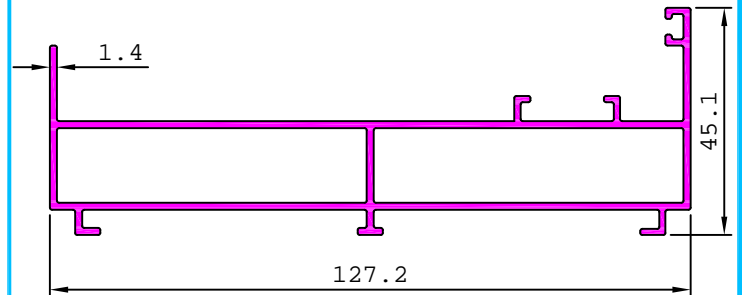

21506

1.235 kg/m

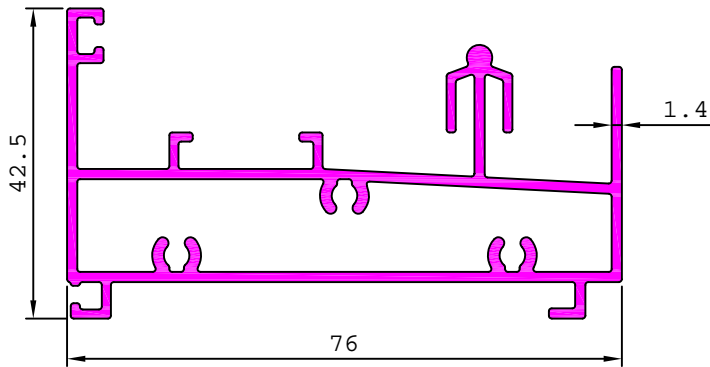

21507

0.940 kg/m

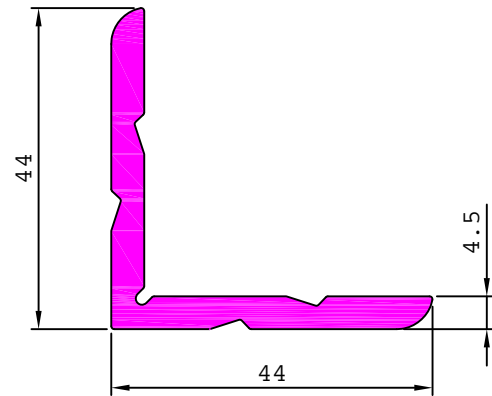

21508

1.363 kg/m

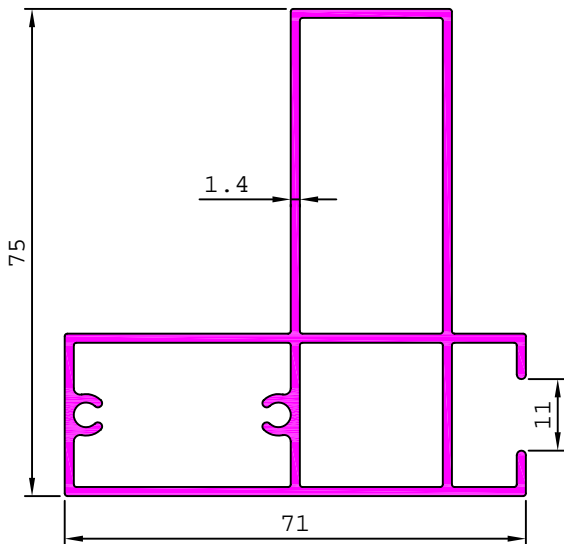

21509

1.283 kg/m

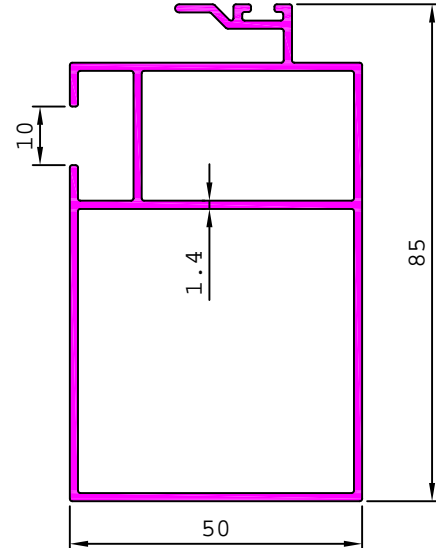

21535

1.470 kg/m

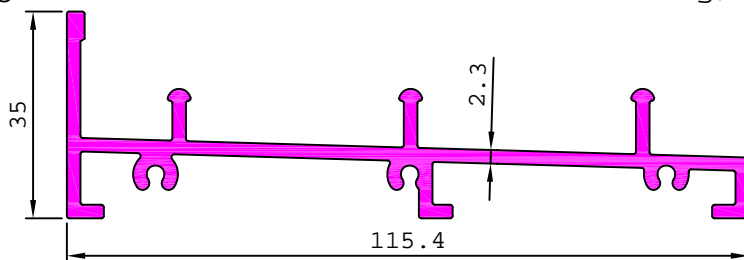

21563

0.280 kg/m

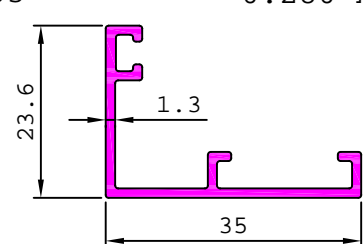

ARCHITECTURAL

WINDOW SECTIONS

21510

0.863 kg/m

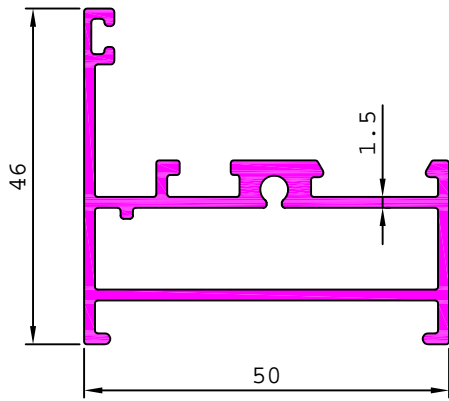

21525

0.848 kg/m

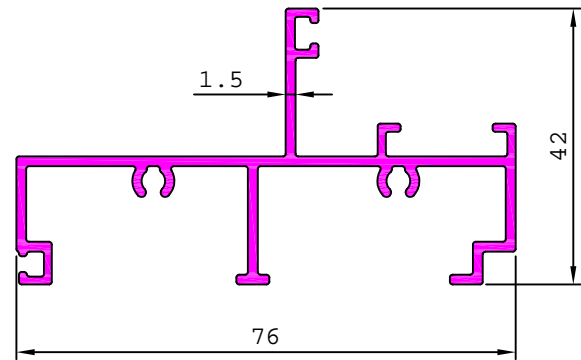

21526

0.701 kg/m

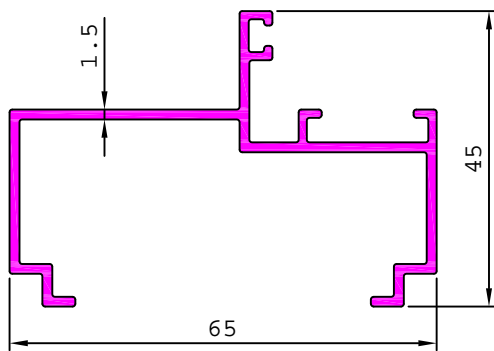

21527

0.874 kg/m

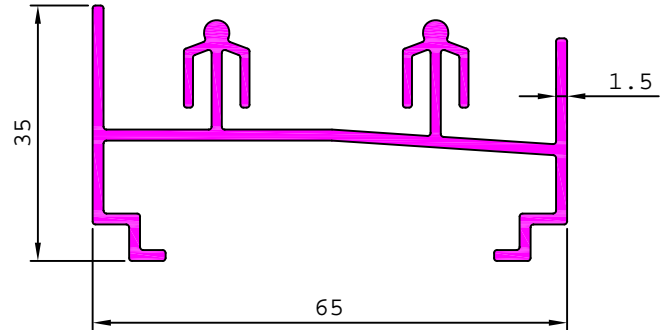

21528

1.266 kg/m

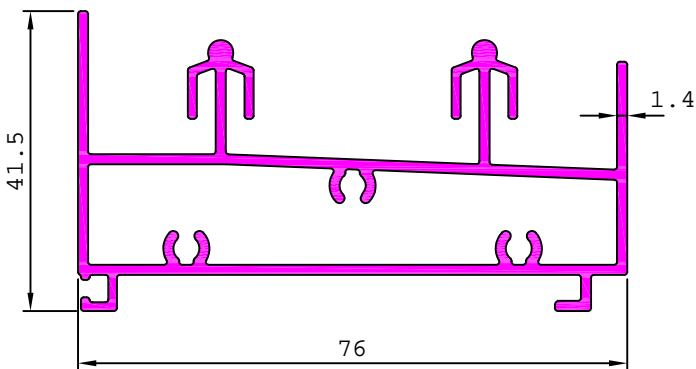

21529

1.027 kg/m

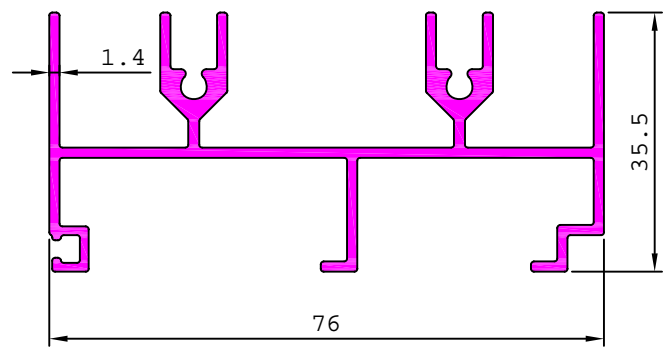

21531

1.241 kg/m

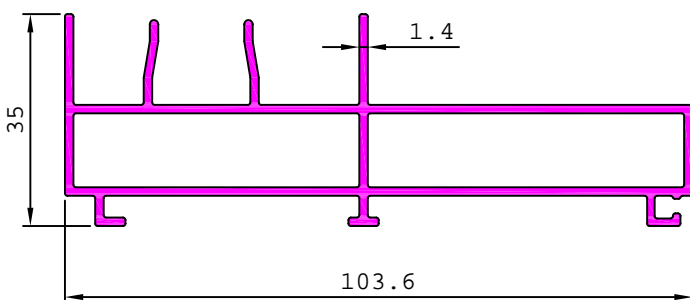

21532

0.759 kg/m

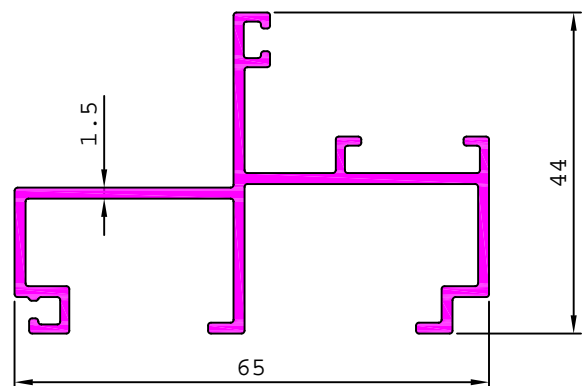

ARCHITECTURAL

WINDOW SECTIONS

21546 1.329 kg/m

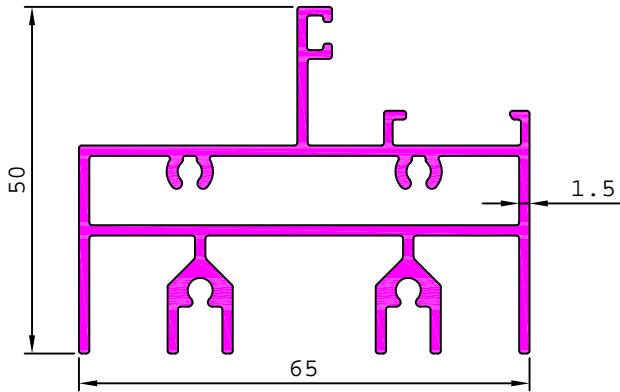

21548 0.604 kg/m

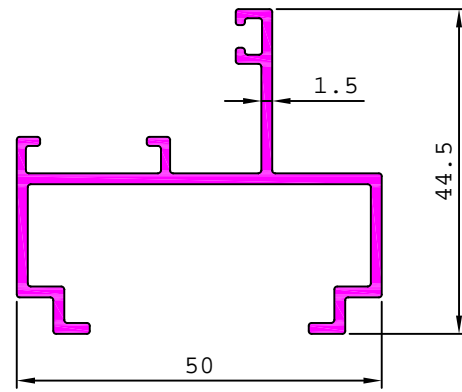

21550 1.629 kg/m

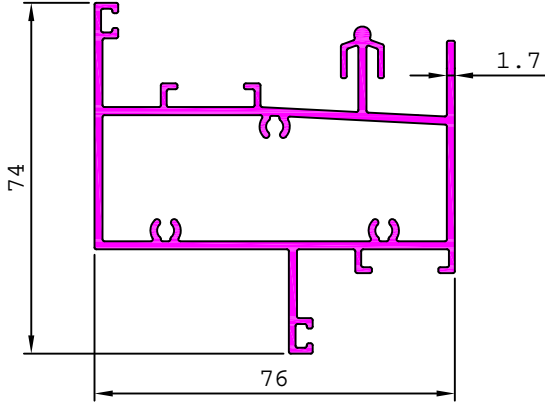

21562 0.659 kg/m

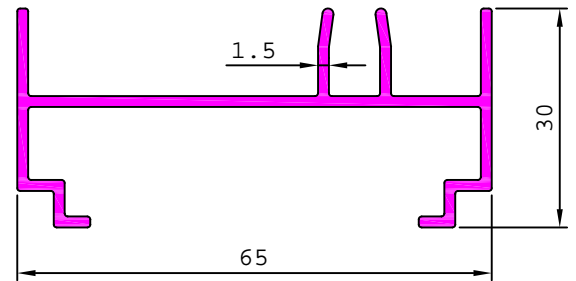

21564 1.453 kg/m

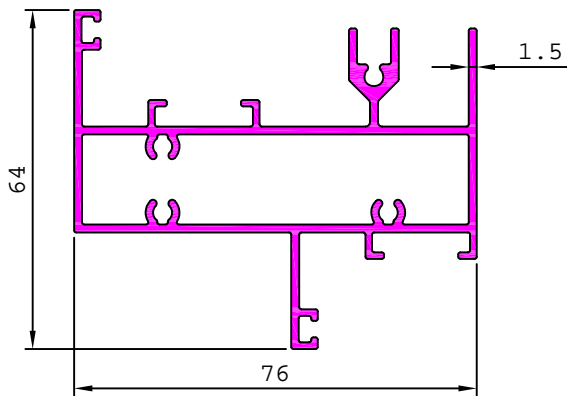

21565 1.240 kg/m

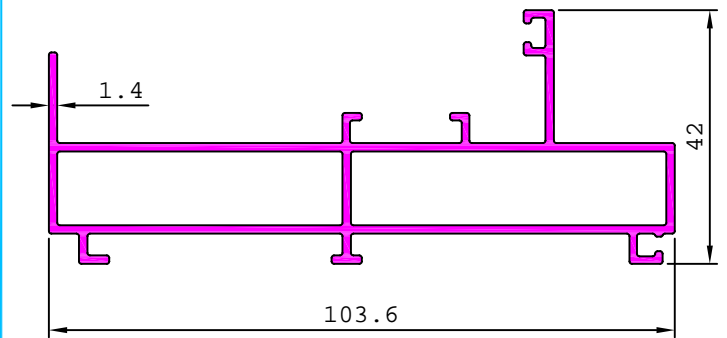

21566 1.193 kg/m

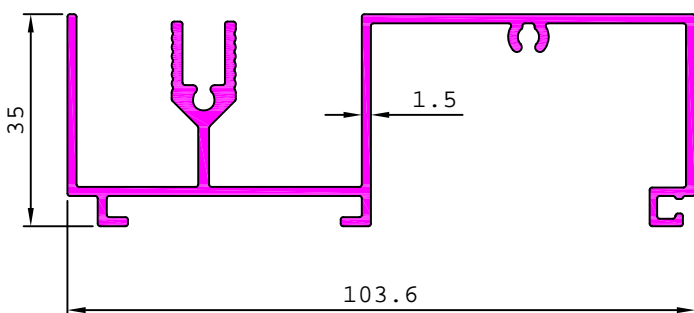

21572 0.273 kg/m

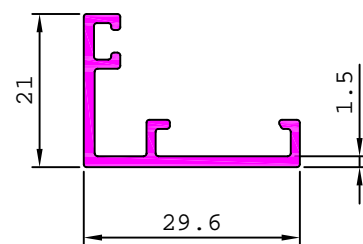

ARCHITECTURAL

WINDOW SECTIONS

21574

0.587 kg/m

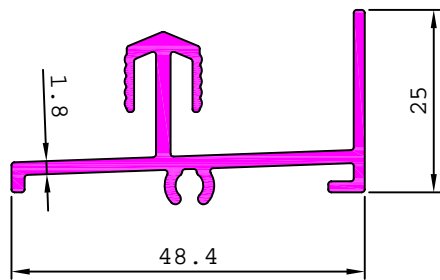

21576

1.149 kg/m

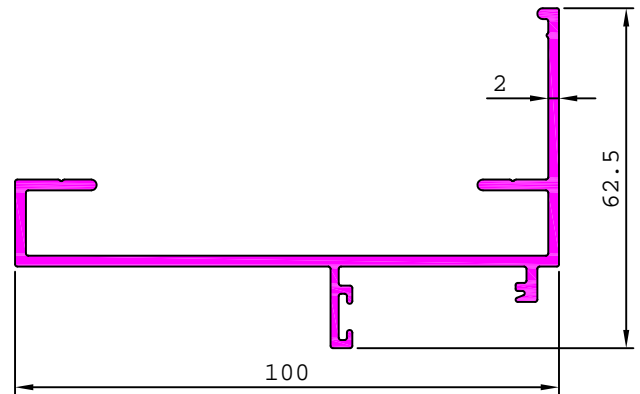

21581

0.184 kg/m

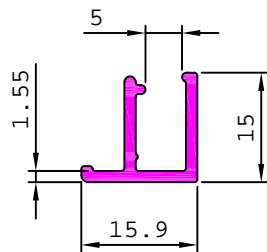

21582

1.020 kg/m

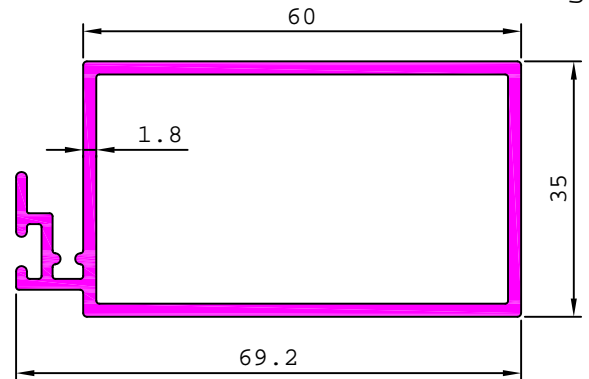

21583

1.066 kg/m

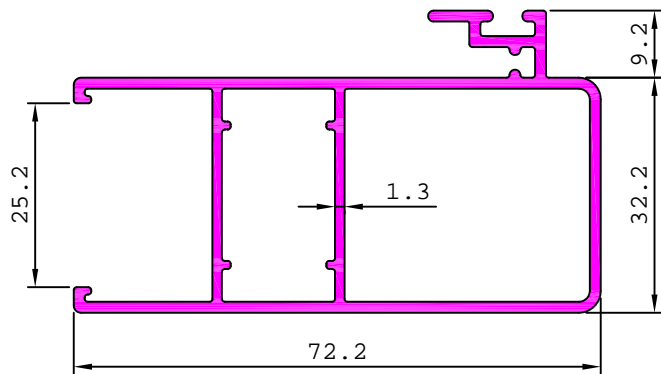

21584

1.612 kg/m

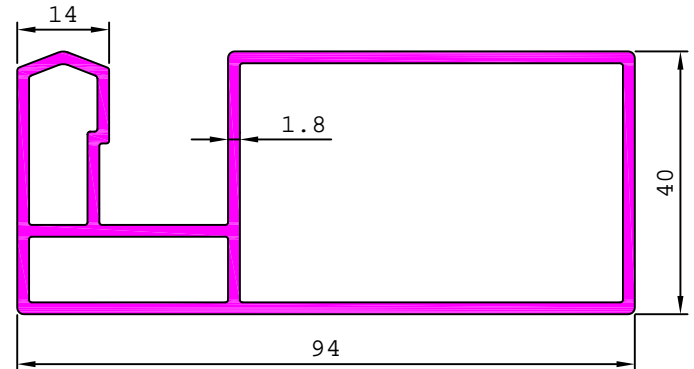

21605

0.798 kg/m

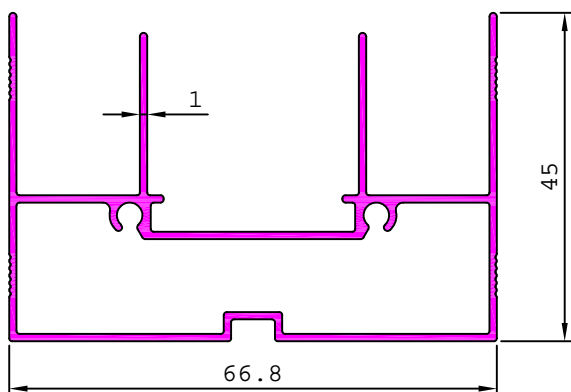

21606

0.401 kg/m

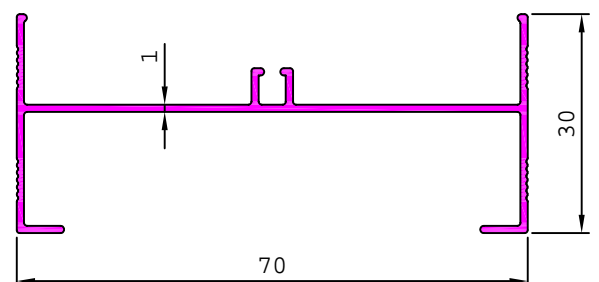

ARCHITECTURAL

WINDOW SECTIONS

21610 0.695 kg/m

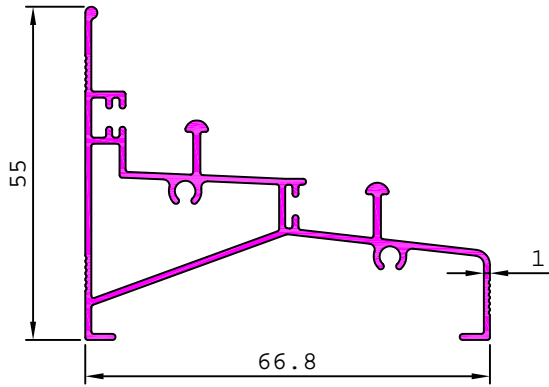

21617 1.412 kg/m

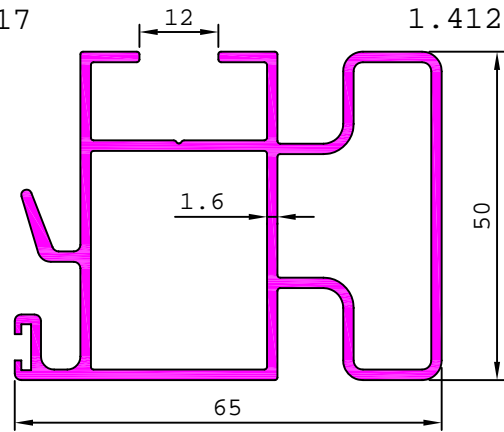

21622 1.719 kg/m

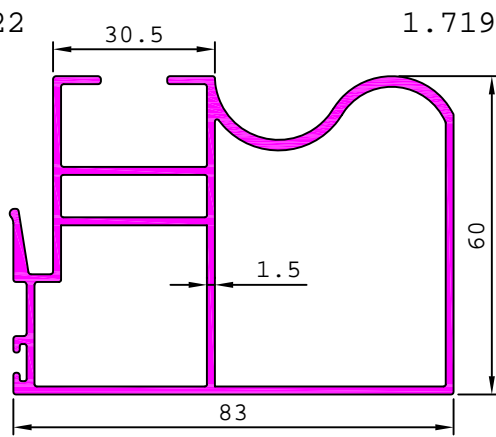

21623 0.985 kg/m

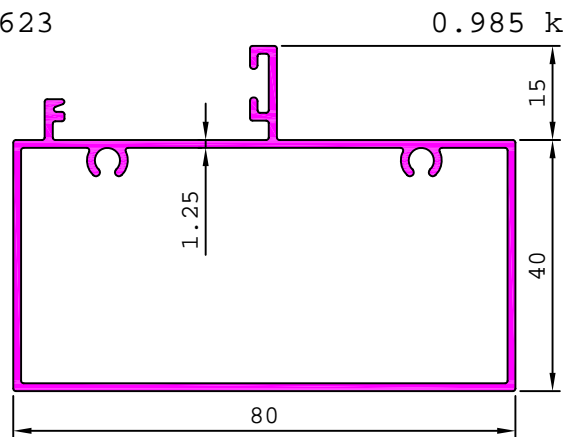

21624 0.774 kg/m

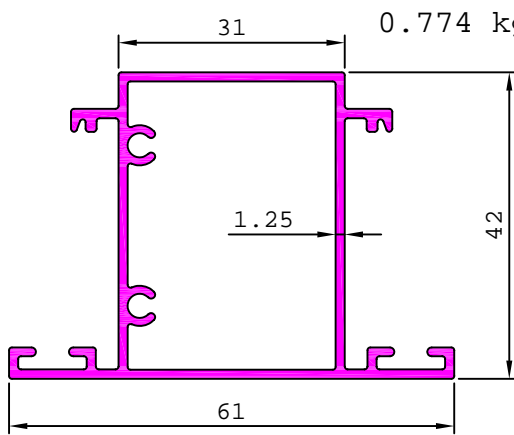

21625 0.902 kg/m

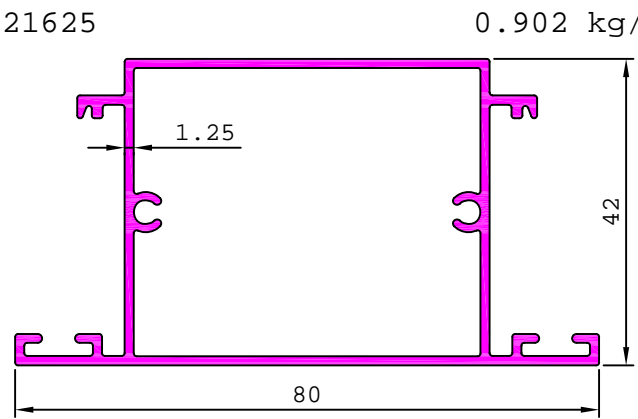

21626 0.487 kg/m

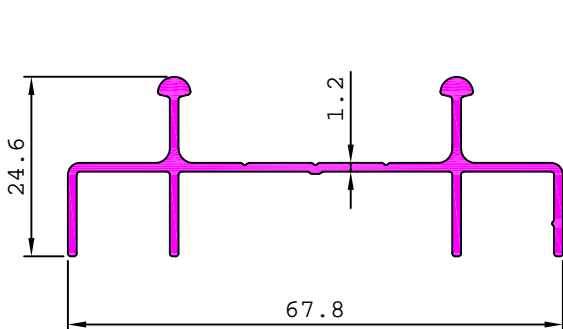

21627 0.321 kg/m

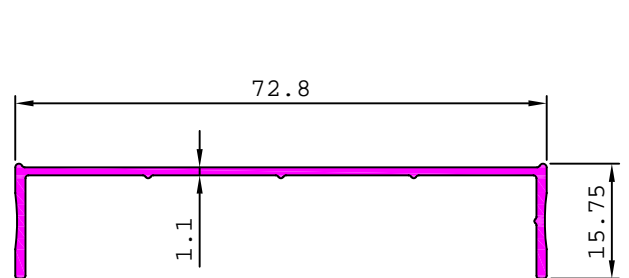

ARCHITECTURAL

WINDOW SECTIONS

21629

0.425 kg/m

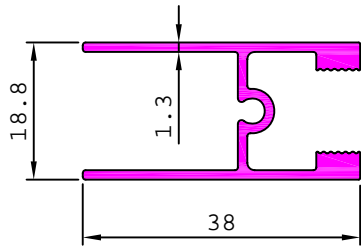

21631

0.393 kg/m

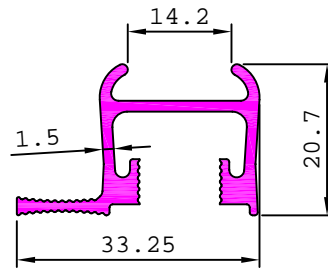

21642

0.257 kg/m

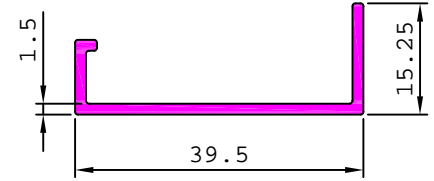

21630

0.599 kg/m

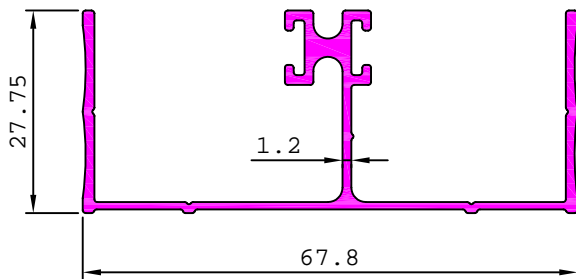

21641

1.425 kg/m

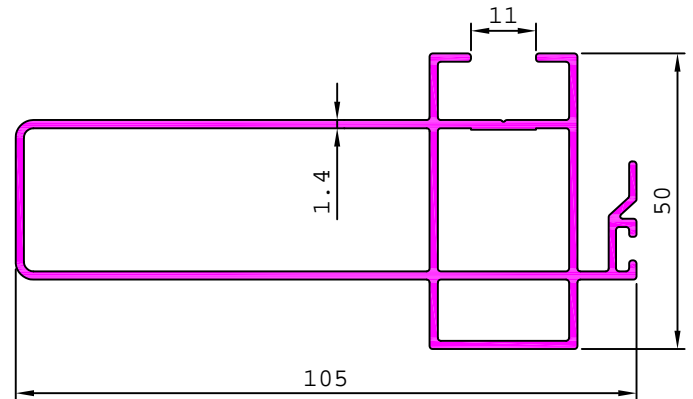

21640

1.445 kg/m

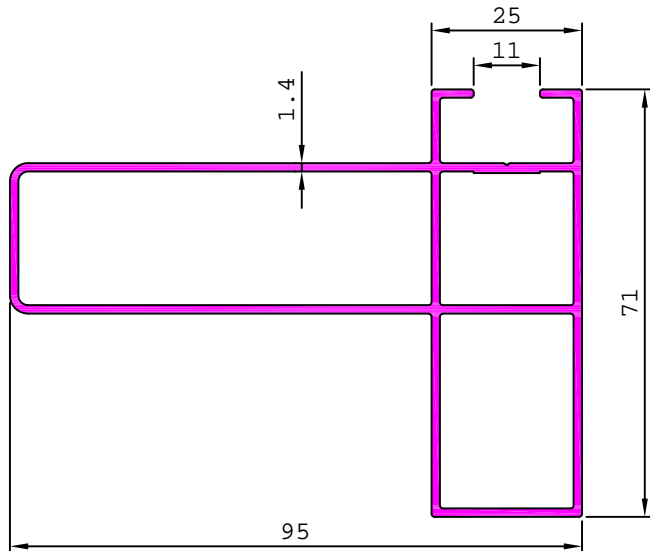

21648

1.458 kg/m

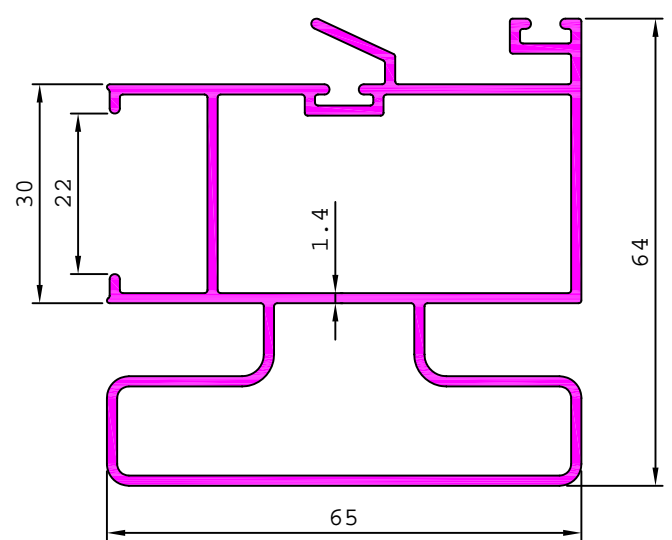

21628

0.770 kg/m

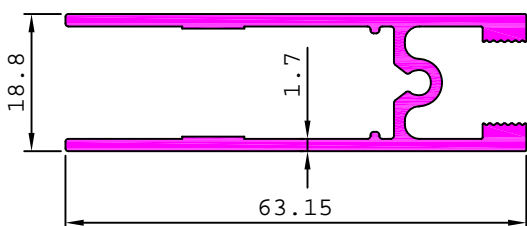

21658

0.125 kg/m

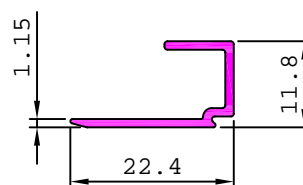

21688

0.186 kg/m

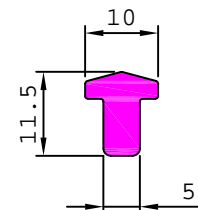

ARCHITECTURAL

WINDOW SECTIONS

21678

1.268 kg/m

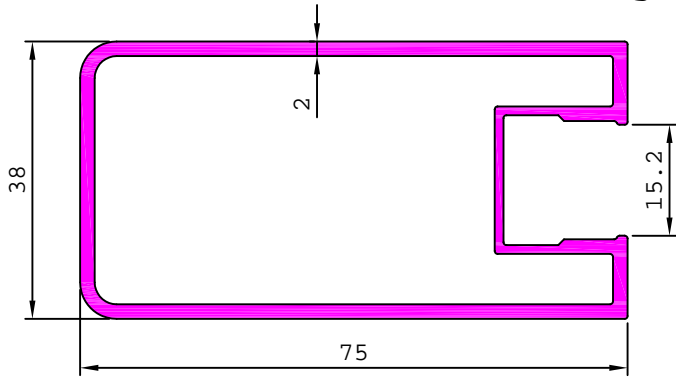

21681

1.292 kg/m

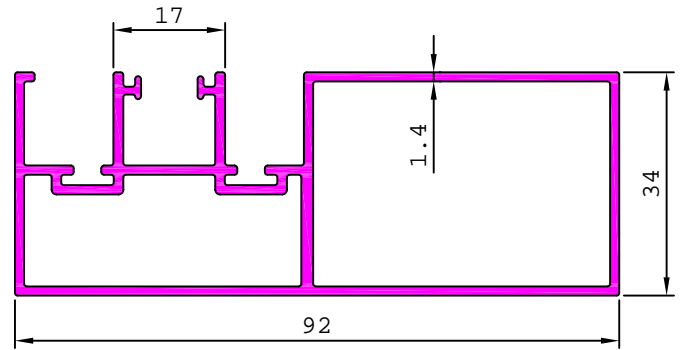

21682

1.472 kg/m

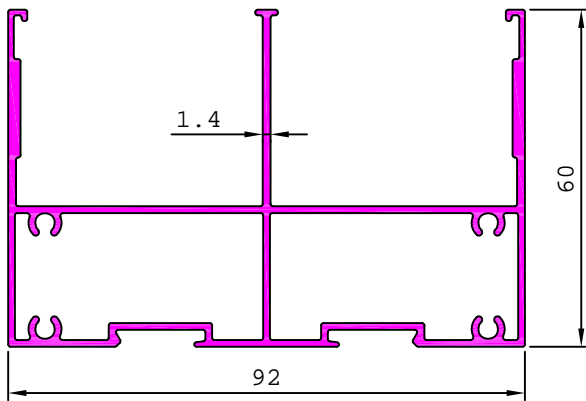

21683

1.473 kg/m

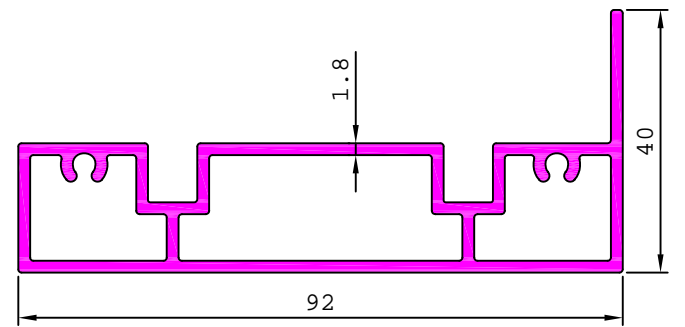

21685

0.755 kg/m

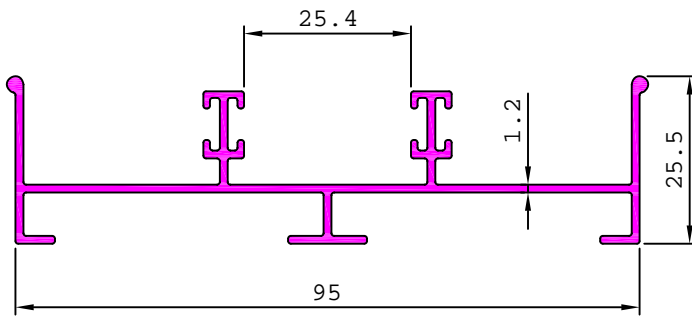

21691

1.522 kg/m

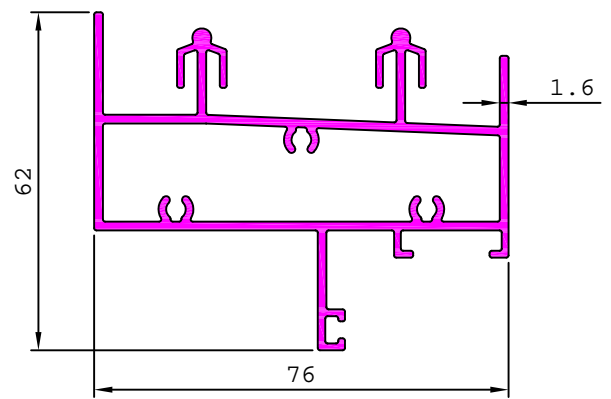

21698

1.068 kg/m

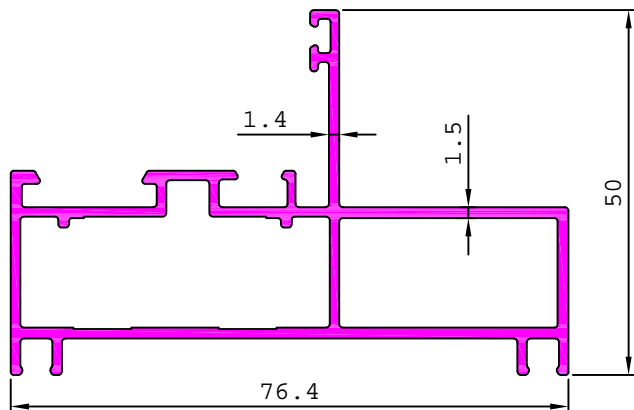

21707

1.834 kg/m

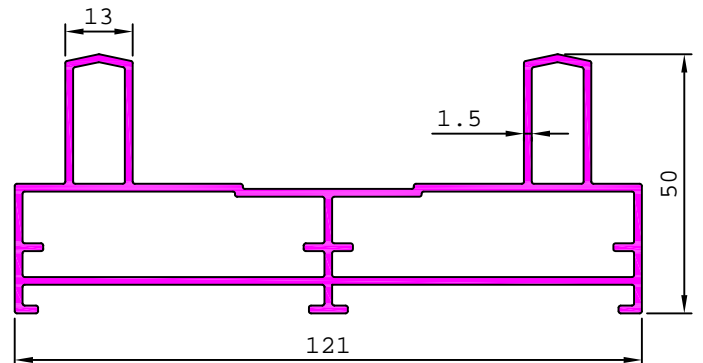

ARCHITECTURAL

WINDOW SECTIONS

21697 1.309 kg/m

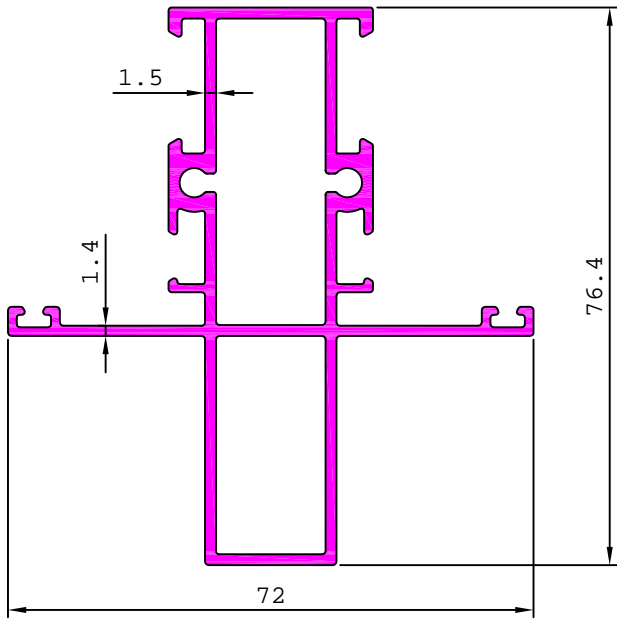

21706 1.110 kg/m

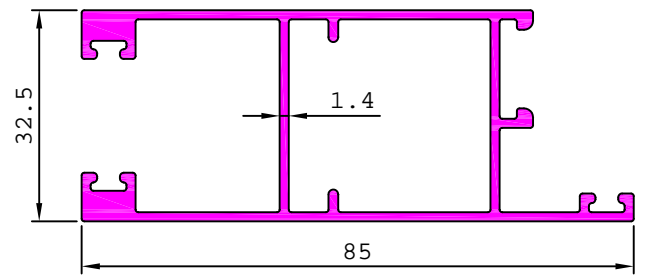

21705 0.280 kg/m

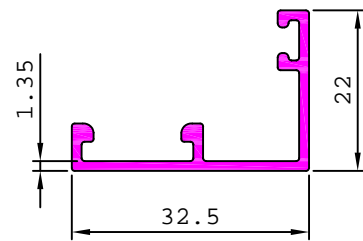

21708 1.218 kg/m

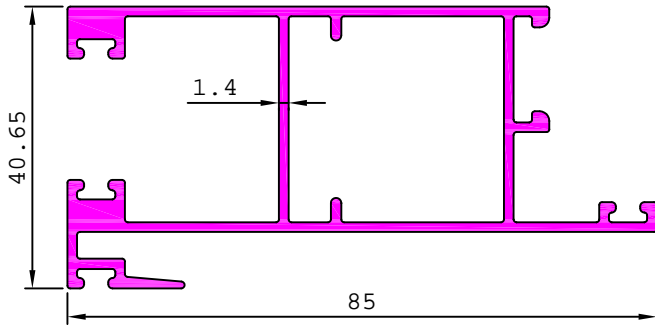

21709 1.218 kg/m

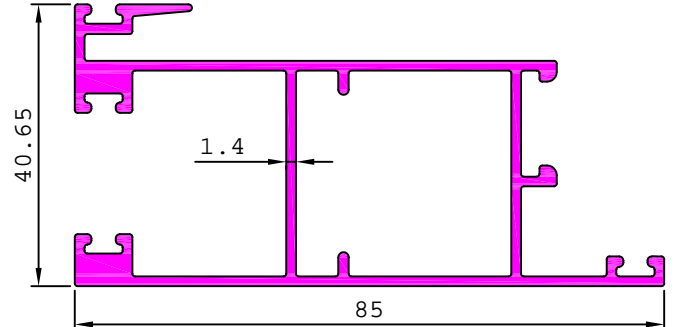

21710 1.345 kg/m

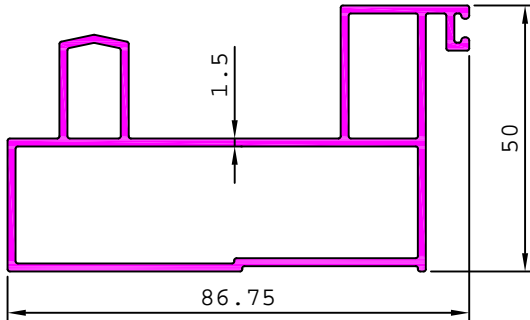

21711 0.965 kg/m

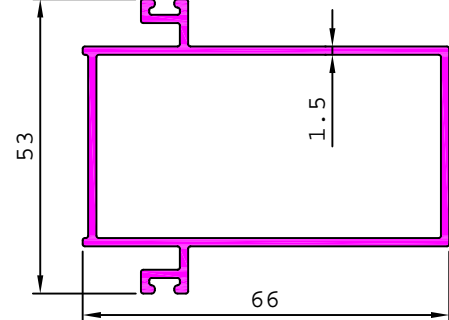

21714 0.146 kg/m

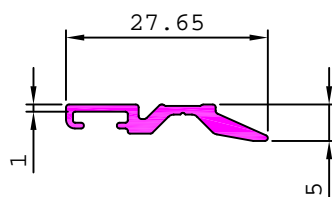

21715 0.605 kg/m

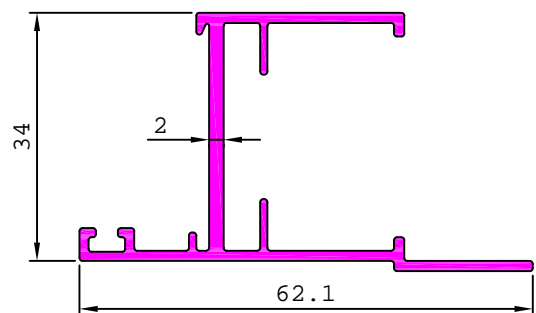

ARCHITECTURAL

WINDOW SECTIONS

15183

0.778 kg/m

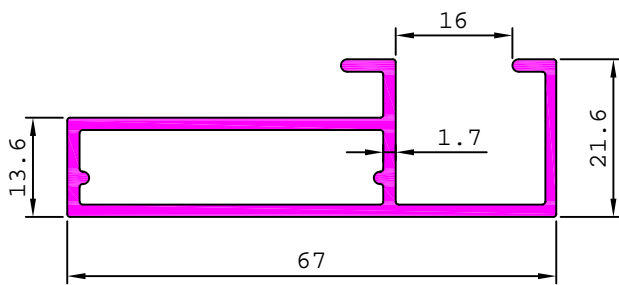

S4240

0.505 kg/m

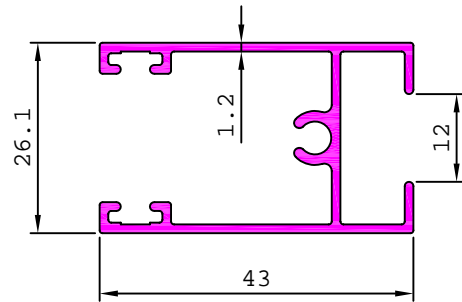

S4241

0.486 kg/m

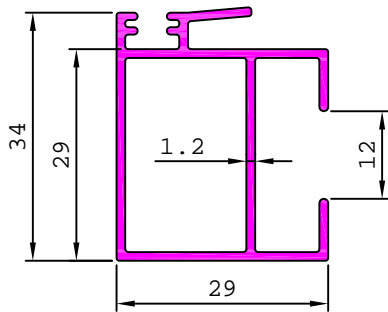

S4242

0.650 kg/m

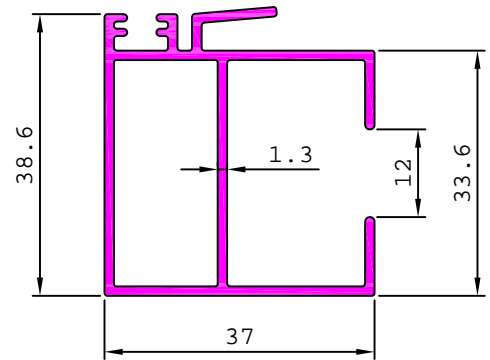

S4243

0.811 kg/m

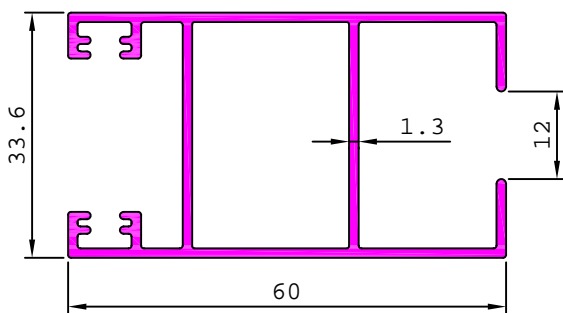

S4244

0.790 kg/m

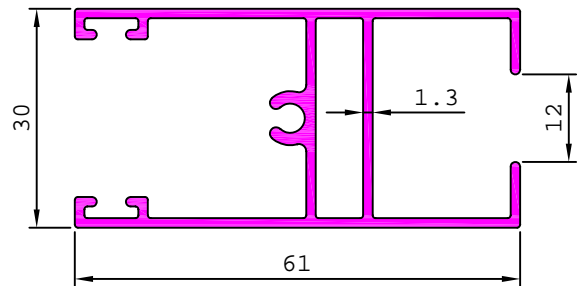

S4314

0.979 kg/m

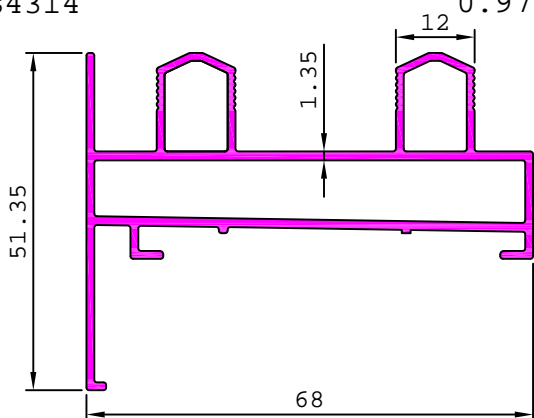

S4575

1.361 kg/m

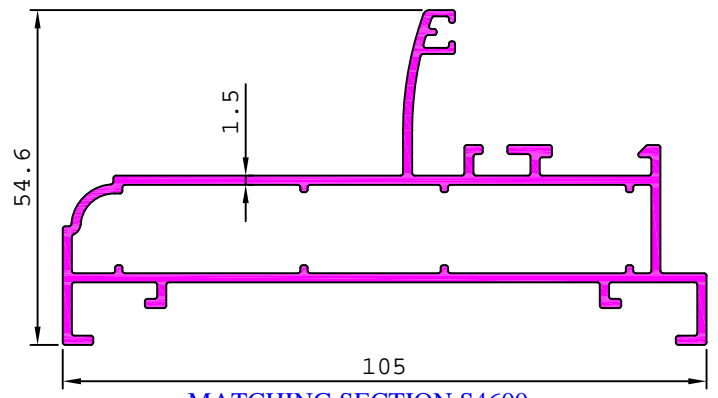

MATCHING SECTION S4600

ARCHITECTURAL

WINDOW SECTIONS

S4576 0.841 kg/m

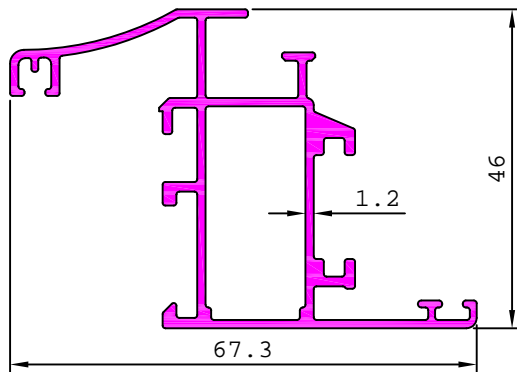

MATCHING SECTION S4599

S4577 1.795 kg/m

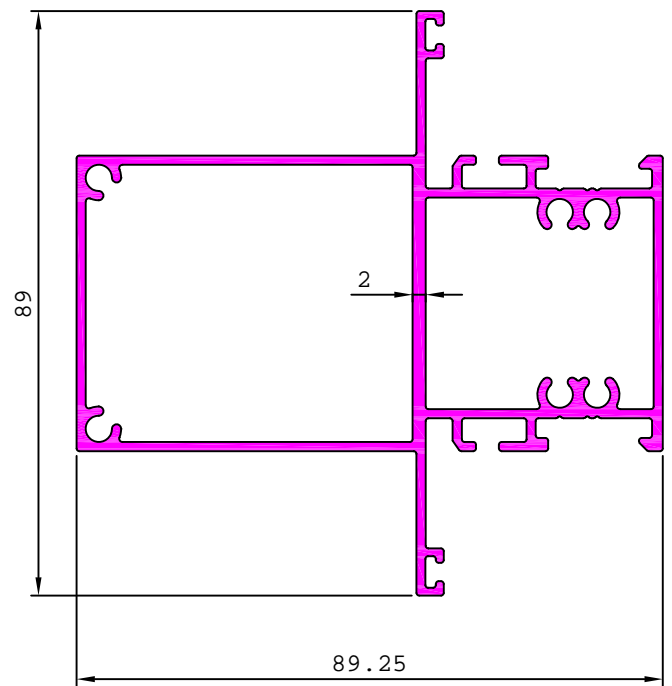

MATCHING SECTION S4599 & S4600

S4578 0.989 kg/m

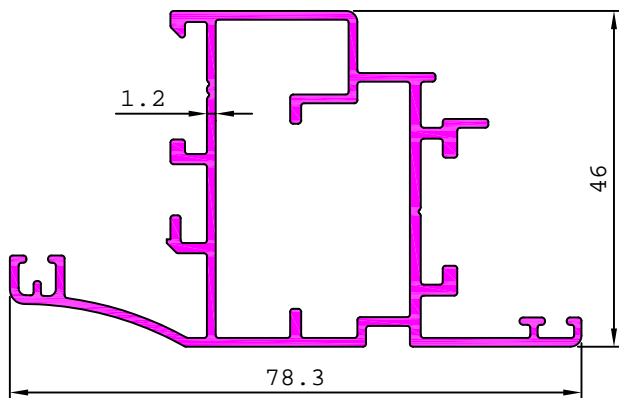

S4581 0.546 kg/m

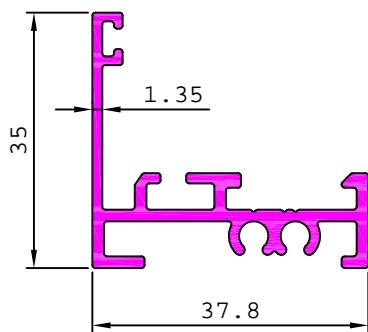

S4582 0.469 kg/m

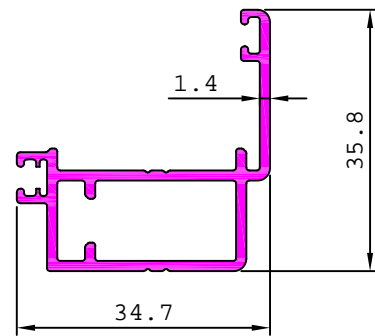

S4599 0.139 kg/m

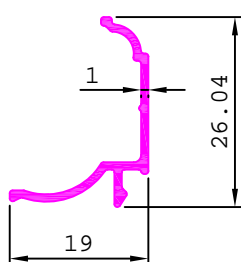

S4600 0.215 kg/m

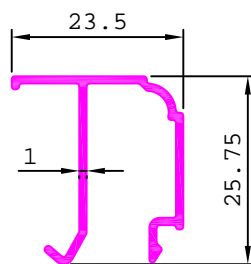

S4601 0.277 kg/m

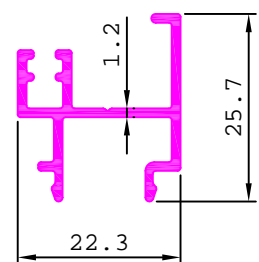

ARCHITECTURAL

WINDOW SECTIONS

S4580

1.663 kg/m

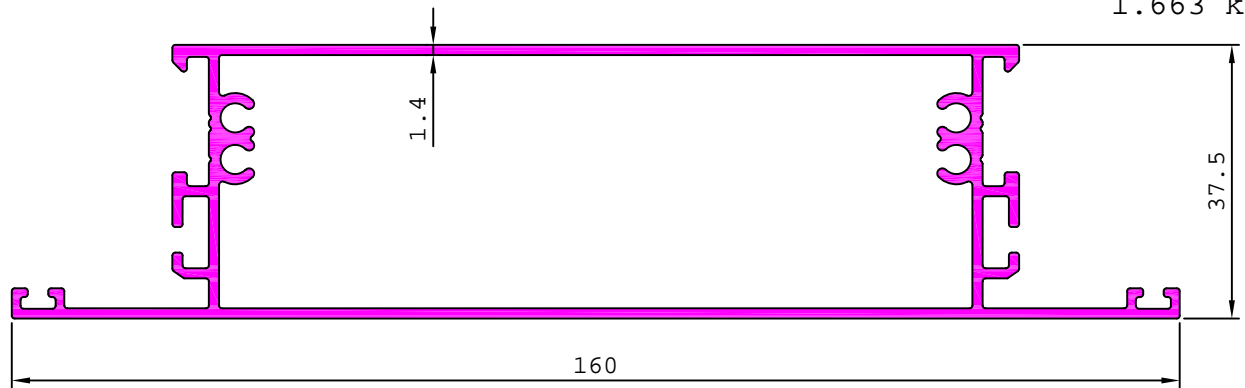

S4583

0.719 kg/m

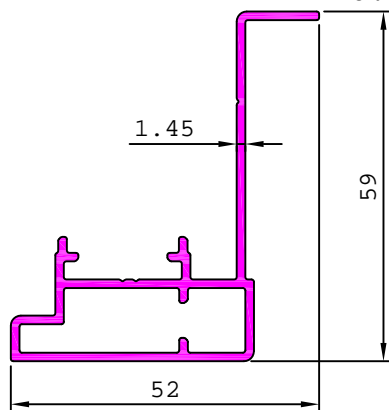

S4585

1.794 kg/m

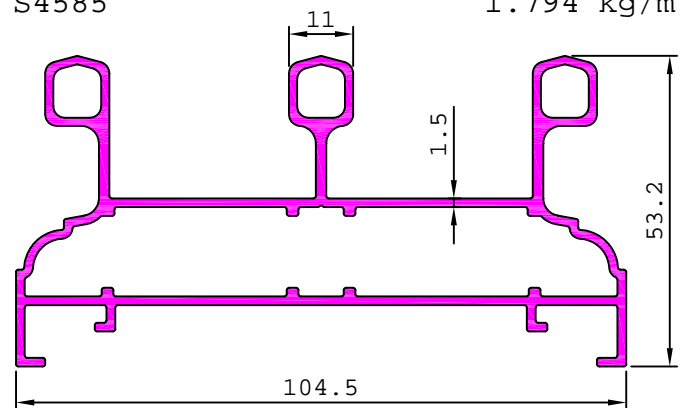

S4584

0.352 kg/m

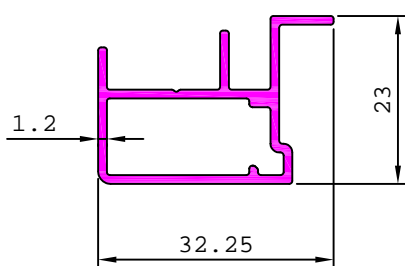

S4586

0.406 kg/m

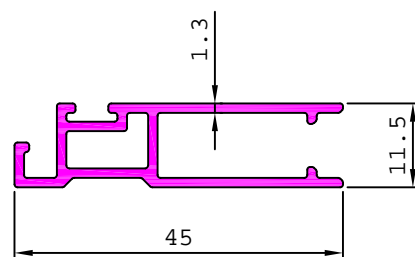

S4587

0.286 kg/m

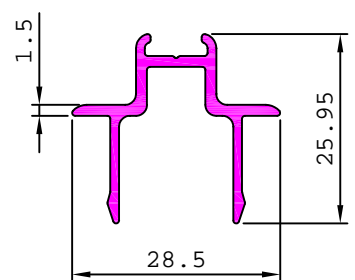

S4593

0.115 kg/m

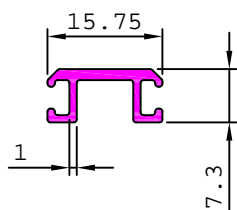

S4591

0.212 kg/m

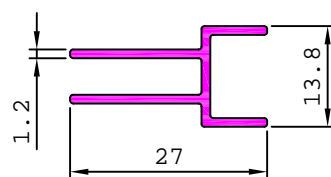

S4594

0.495 kg/m

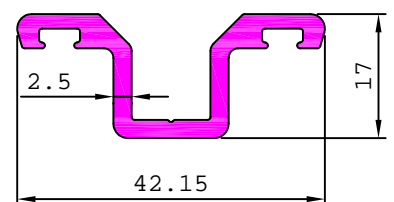

ARCHITECTURAL

WINDOW SECTIONS

S4589

1.169 kg/m

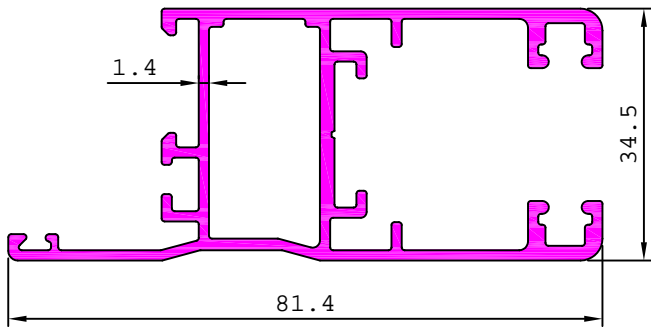

S4590

0.446 kg/m

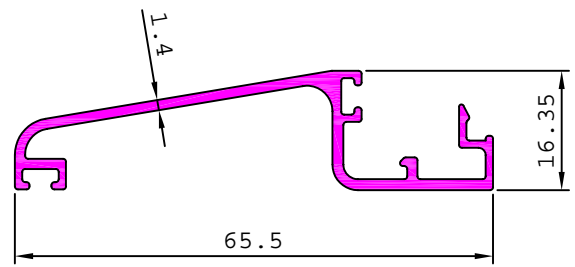

S4597

0.297 kg/m

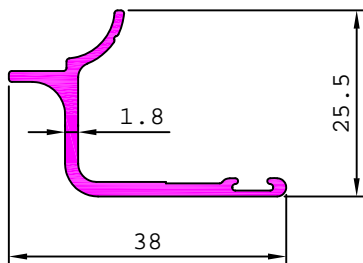

S4605

1.209 kg/m

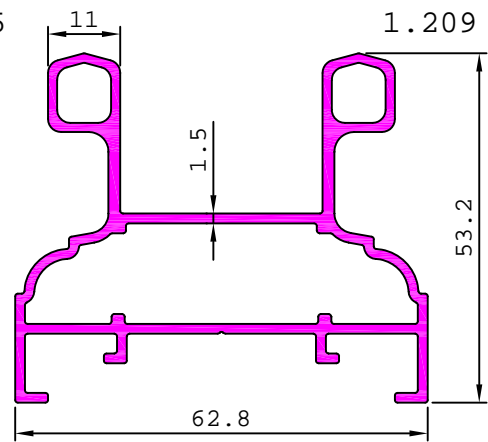

S4606

0.983 kg/m

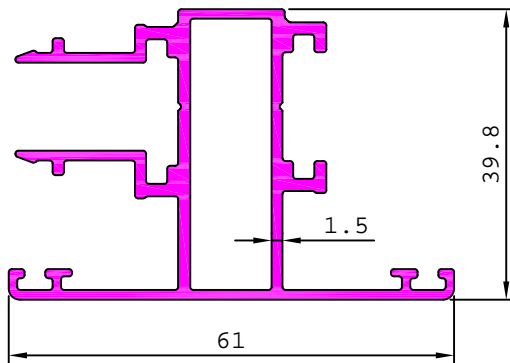

S4607

0.924 kg/m

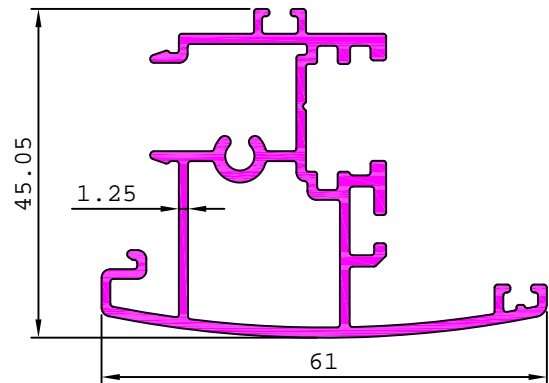

S4609

1.035 kg/m

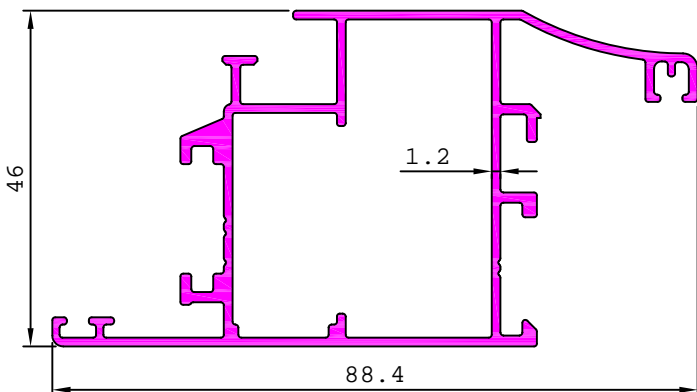

S4610

1.127 kg/m

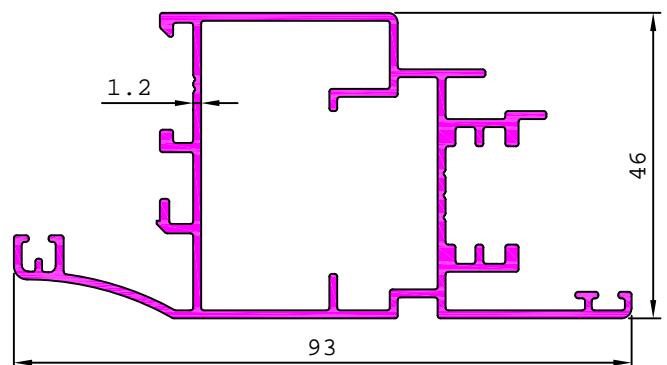

ARCHITECTURAL

WINDOW SECTIONS

S4735

1.162 kg/m

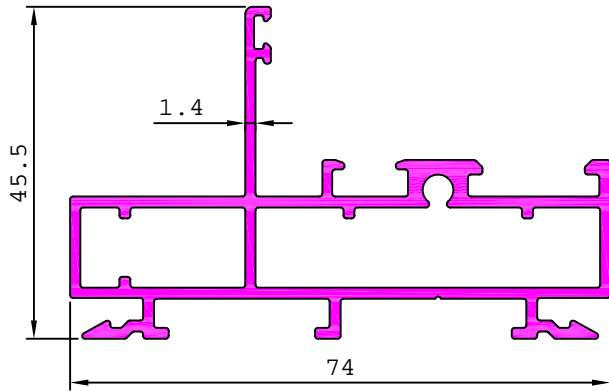

S4736

1.226 kg/m

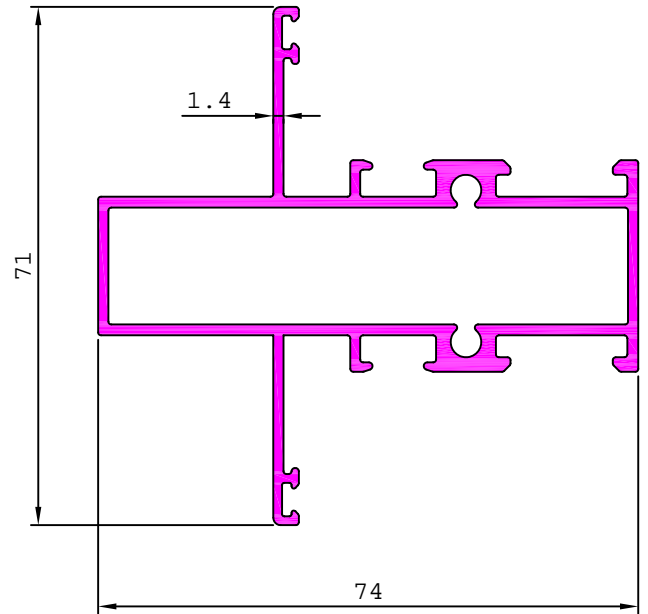

S4385

0.559 kg/m

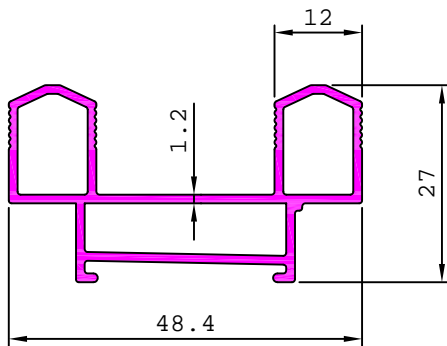

S4622

0.878 kg/m

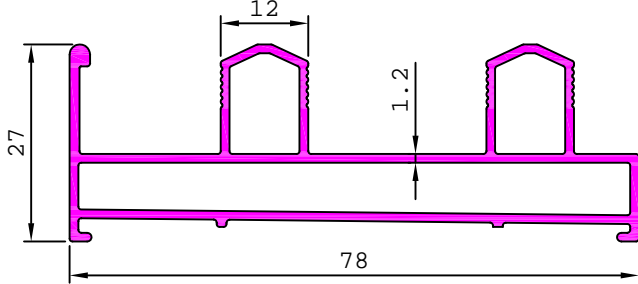

S4574

0.795 kg/m

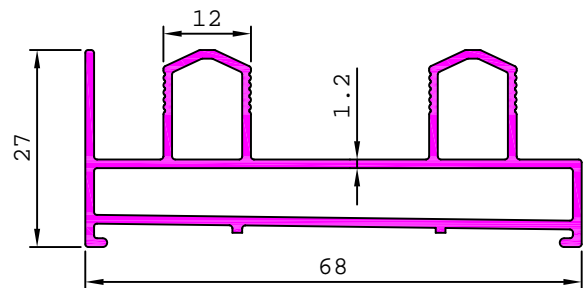

S4232

0.822 kg/m

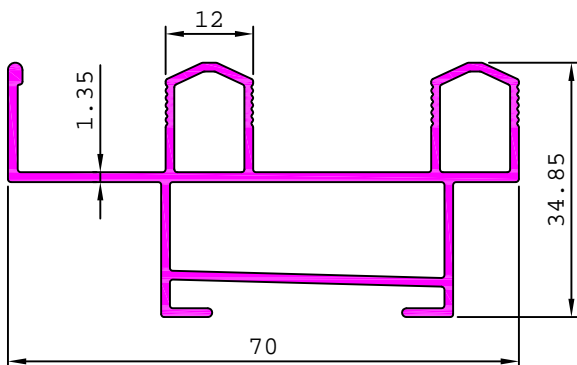

21686

1.268 kg/m

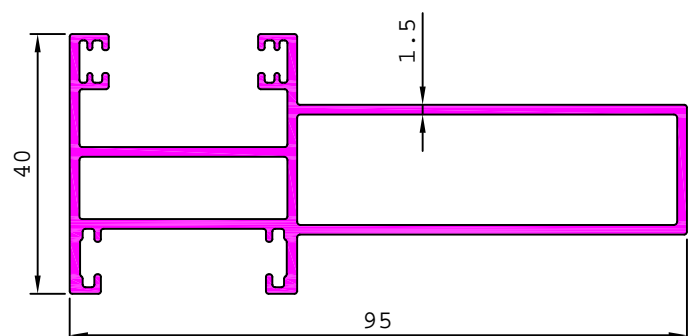

ARCHITECTURAL

WINDOW SECTIONS

S4897 1.076 kg/m

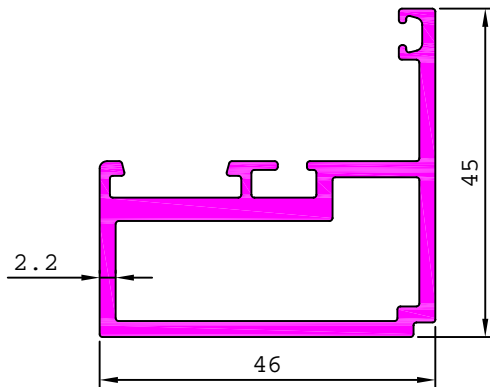

S4915 0.967 kg/m

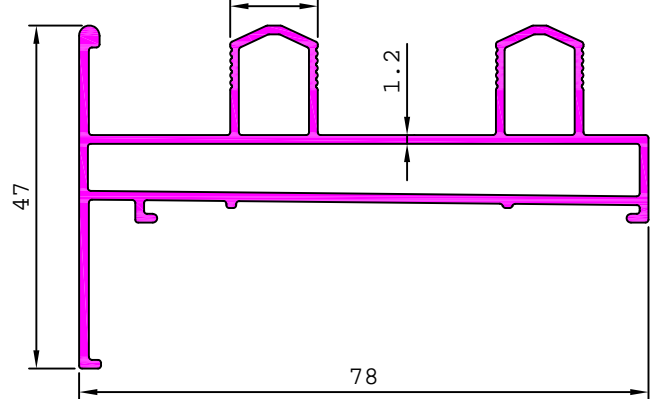

S4932 0.971 kg/m

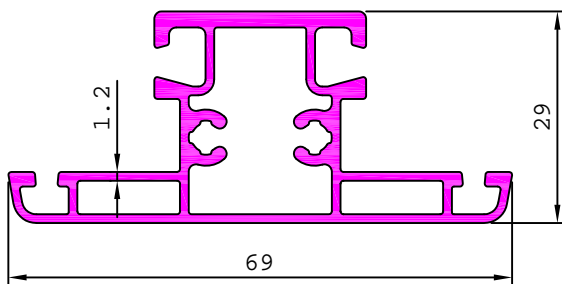

S4961 0.962 kg/m

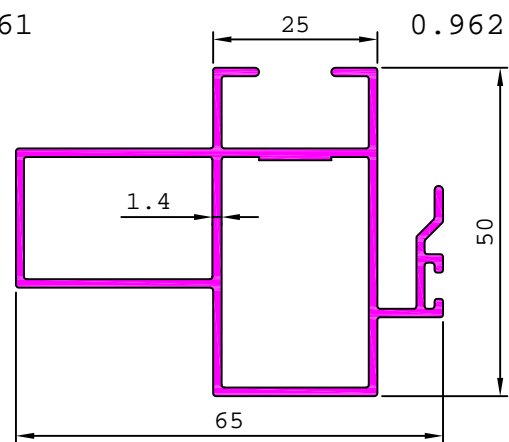

S4969 0.842 kg/m

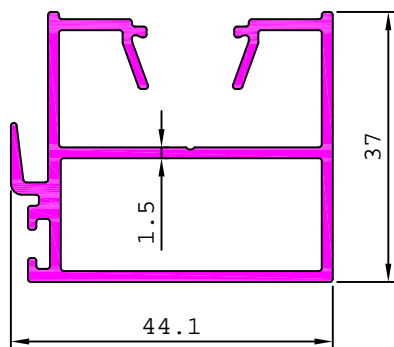

S4970 1.140 kg/m

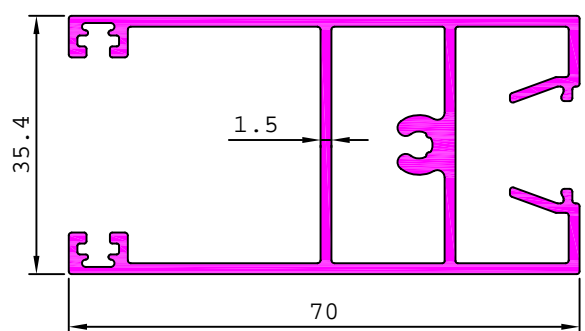

S4971 1.192 kg/m

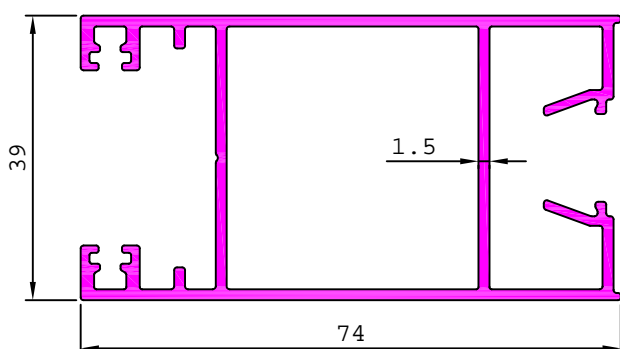

S4972 1.452 kg/m

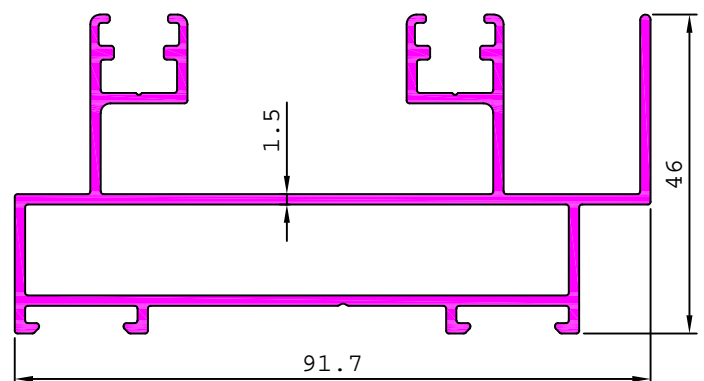

ARCHITECTURAL

WINDOW SECTIONS

S4973 1.750 kg/m

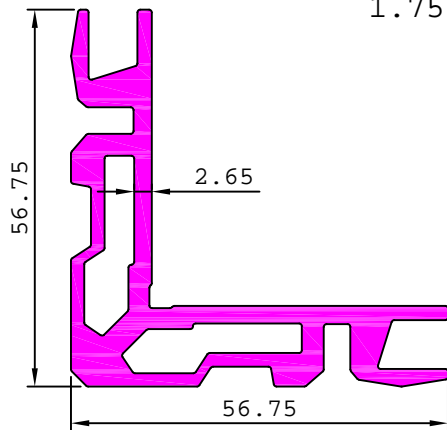

S5143 1.002 kg/m

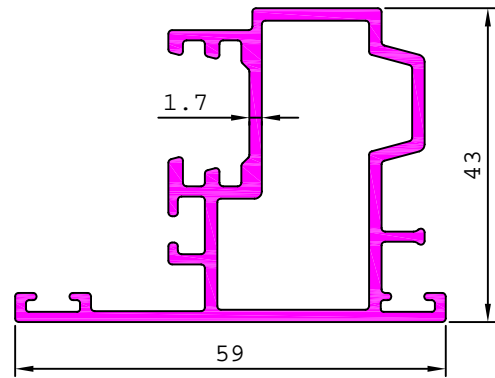

21723 0.650 kg/m

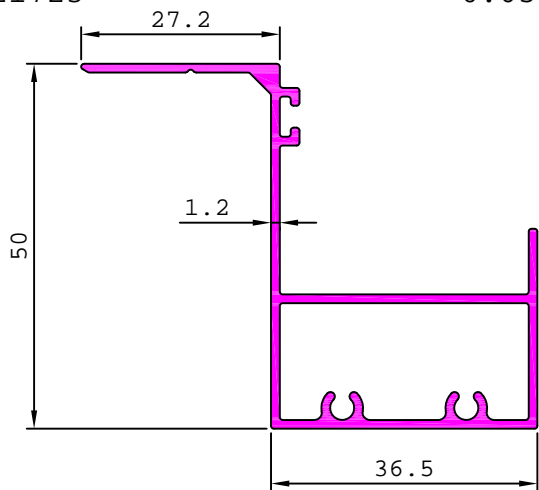

21730 0.835 kg/m

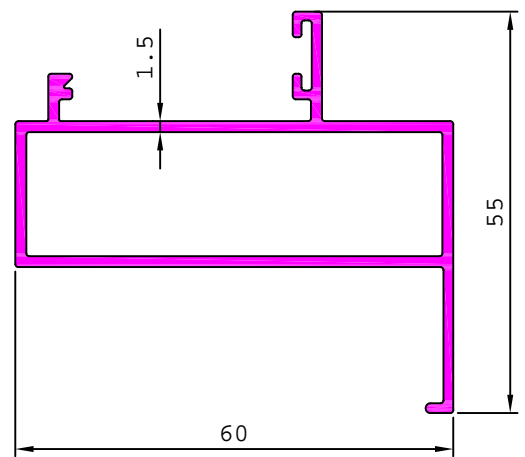

S4275 0.109 kg/m

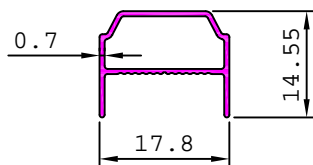

ARCHITECTURAL

SYNTEX SECTION & GRILL FRAMES

20501 0.299 kg/m

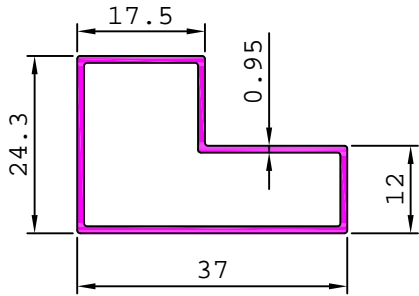

20502 0.440 kg/m

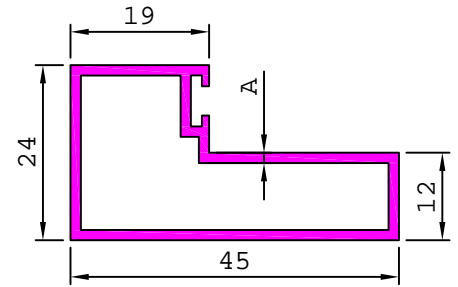
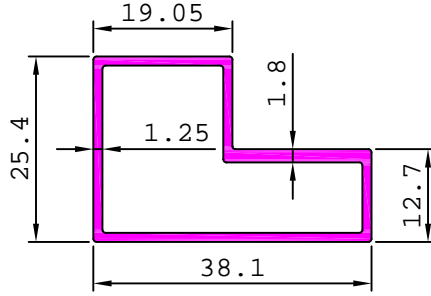

SL. No.	Section No.	A	Weight kg/m
1	20734	1.04	0.395
2	20843	1.42	0.526

21102 0.826 kg/m

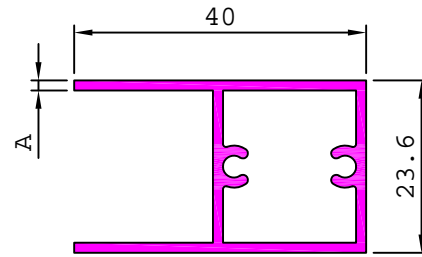
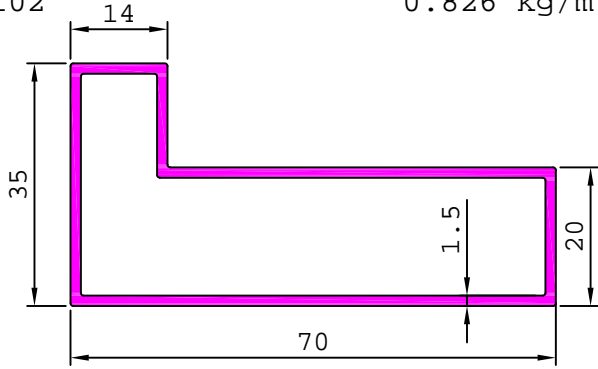

20828 0.535 kg/m

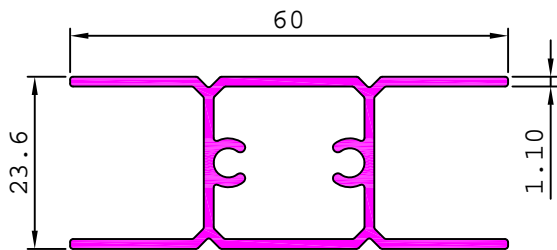

SL. No.	Section No.	A	Weight kg/m
1	20872	0.73	0.273
2	20849	0.84	0.314
3	20848	1.12	0.414
4	20827	1.38	0.506

GRILL FRAMES

20698 0.272 kg/m

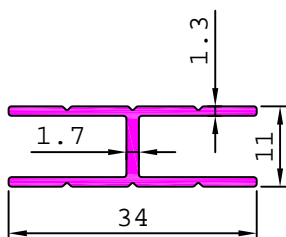

ARCHITECTURAL

LOUVER SECTION

20552

0.599 kg/m

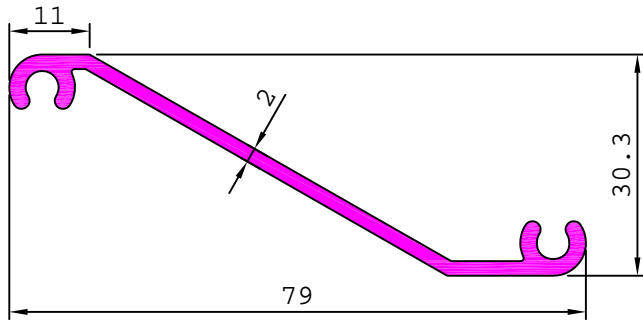

20778

0.483 kg/m

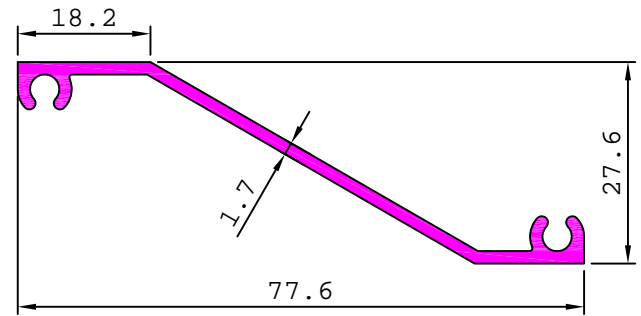

20782

0.429 kg/m

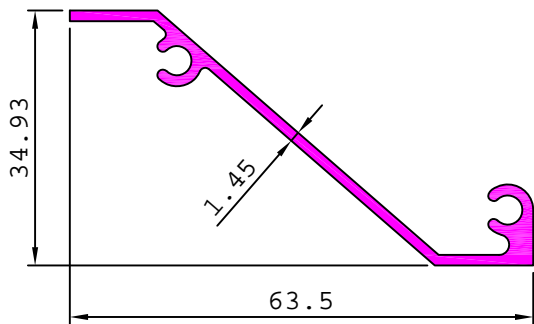

20853

0.391 kg/m

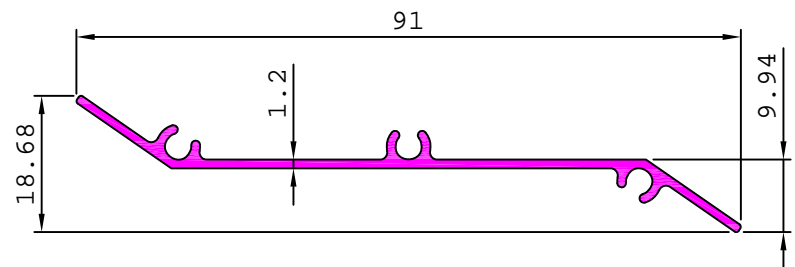

20860

0.249 kg/m

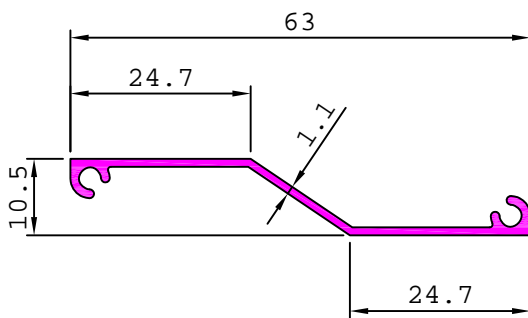

20967

0.369 kg/m

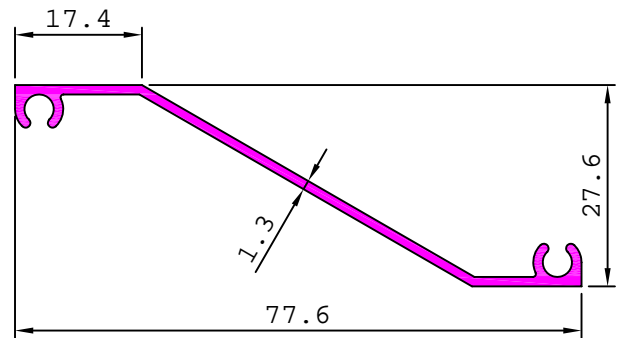

20970

0.248 kg/m

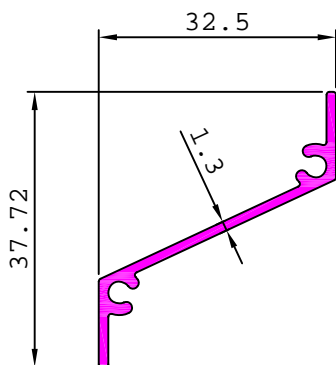

21150

0.519 kg/m

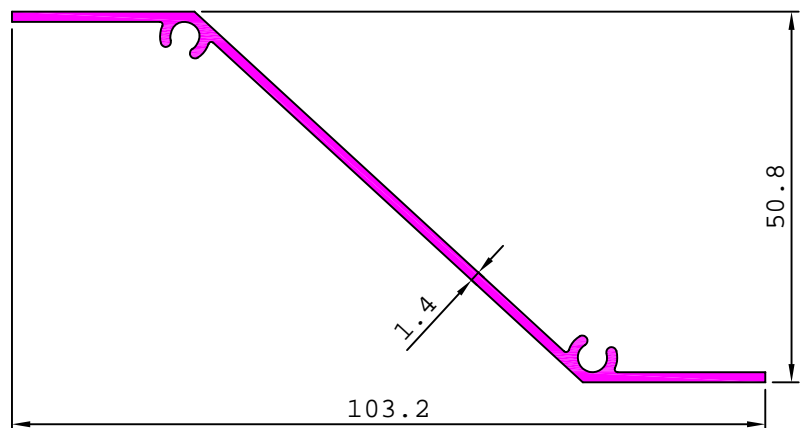

ARCHITECTURAL

LOUVER SECTION

21240

3.228 kg/m

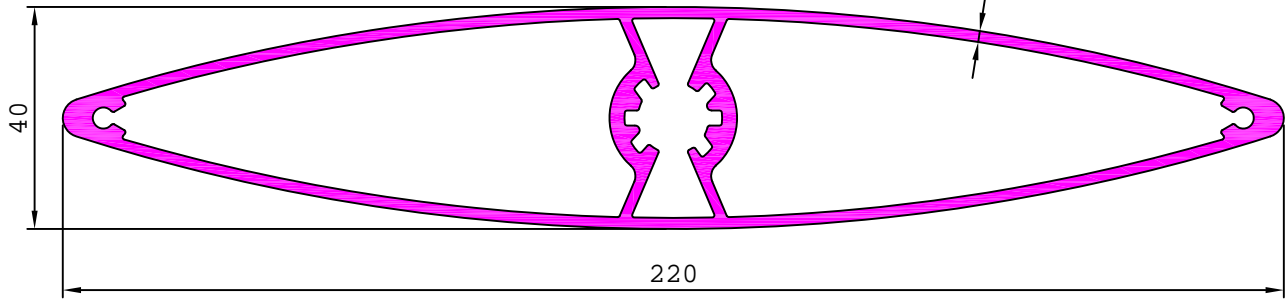

21238

0.506 kg/m

21305

0.402 kg/m

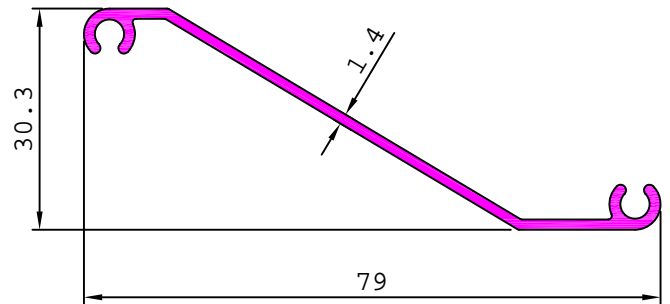
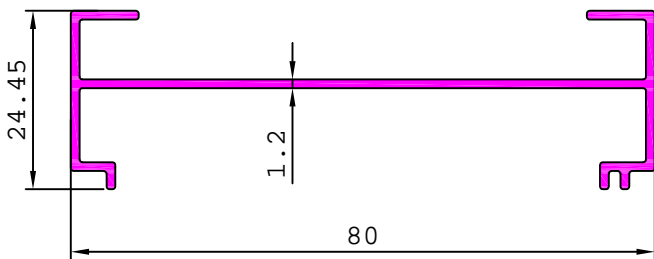

21316

1.518 kg/m

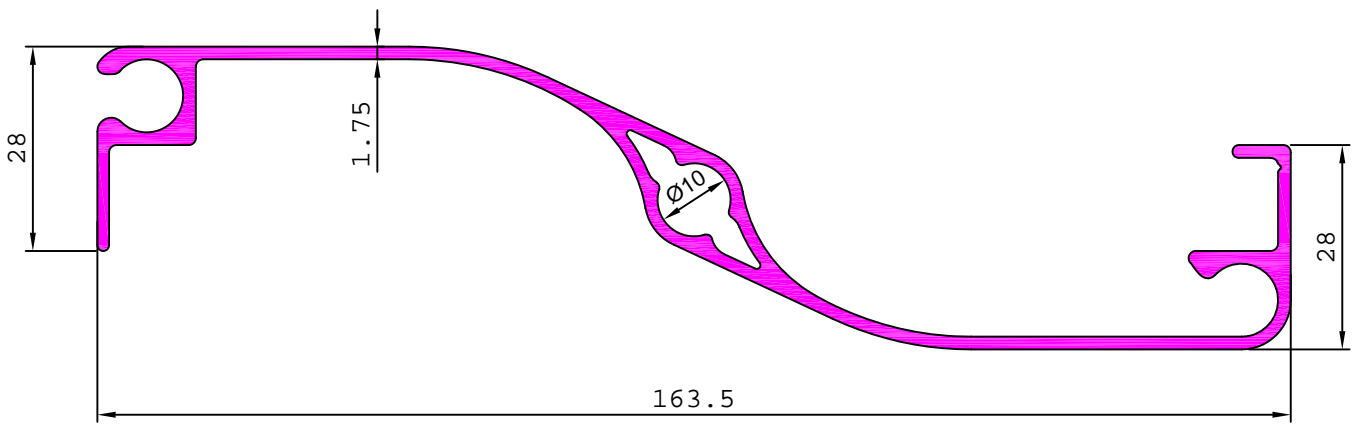

21318

0.514 kg/m

21334

0.543 kg/m

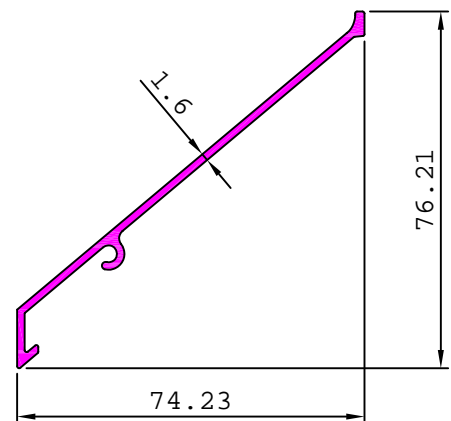
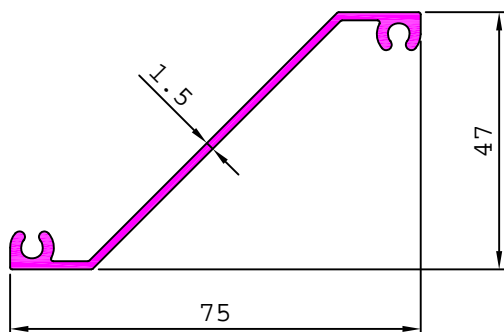

ARCHITECTURAL

LOUVER SECTION

21333

1.086 kg/m

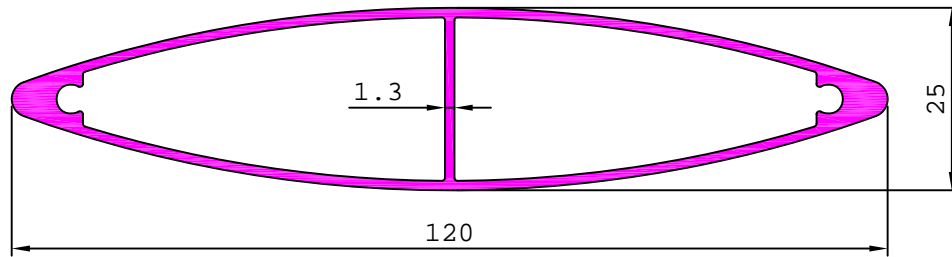

21335

3.289 kg/m

21347

0.420 kg/m

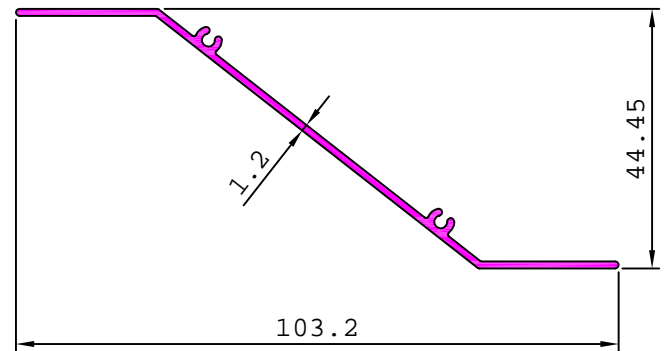
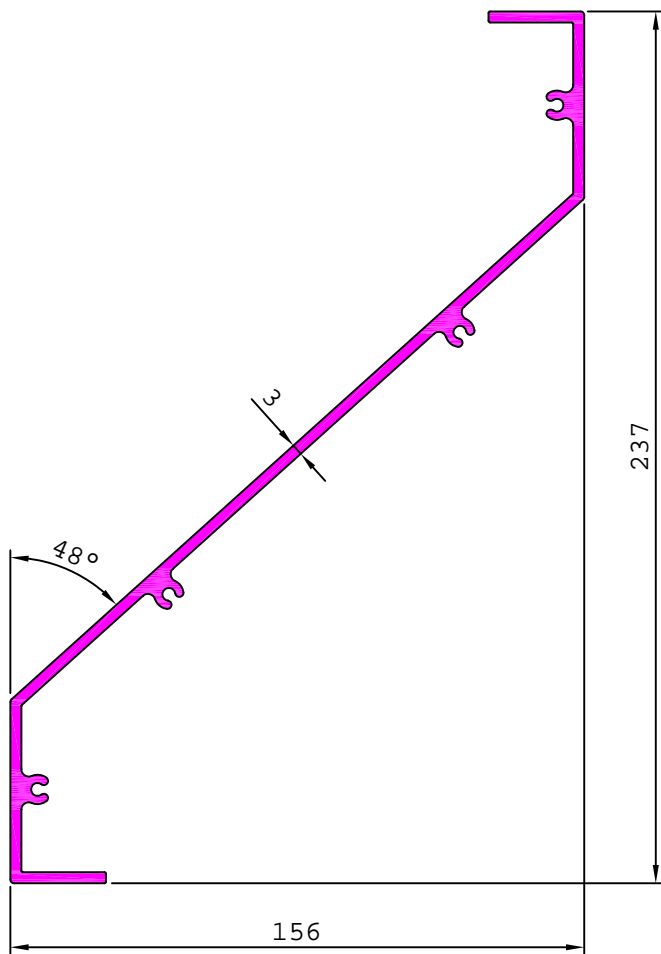

21351

0.288 kg/m

21340

6.426 kg/m

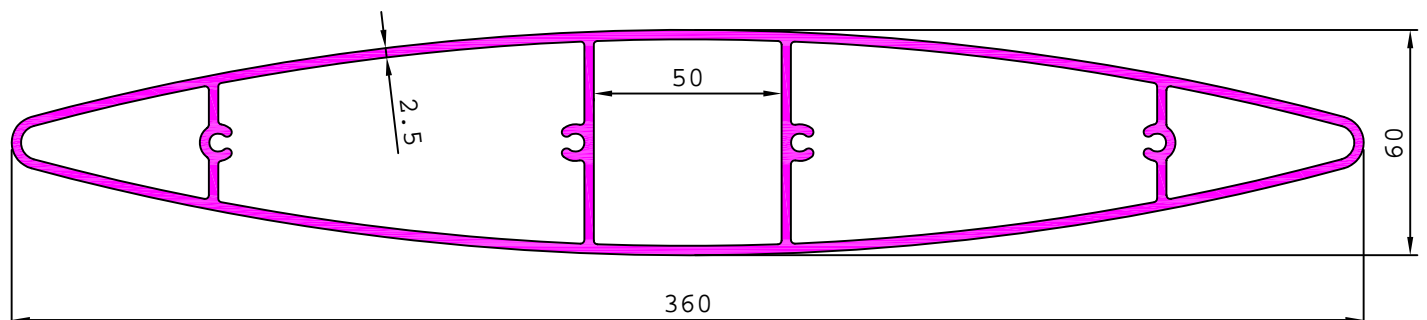

ARCHITECTURAL

LOUVER SECTION

21395

1.480 kg/m

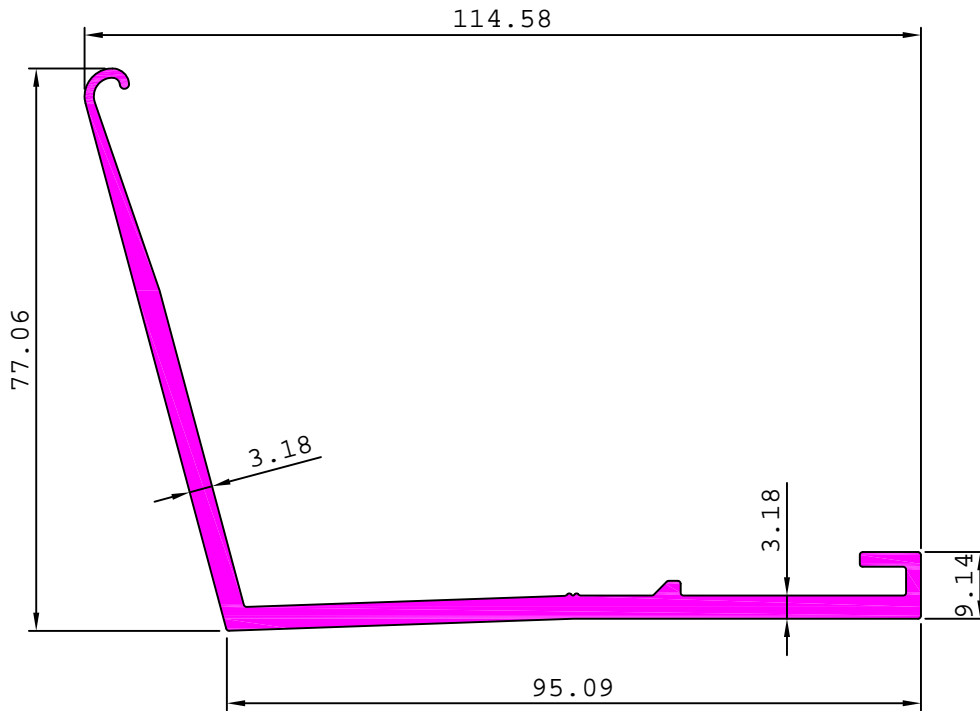

21396

1.058 kg/m

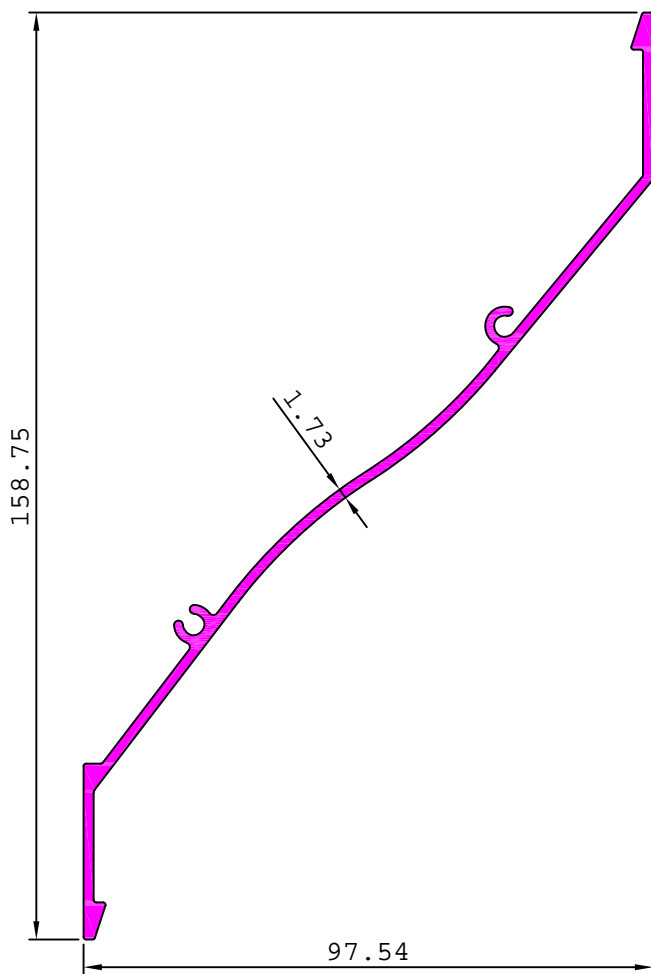

21408

3.680 kg/m

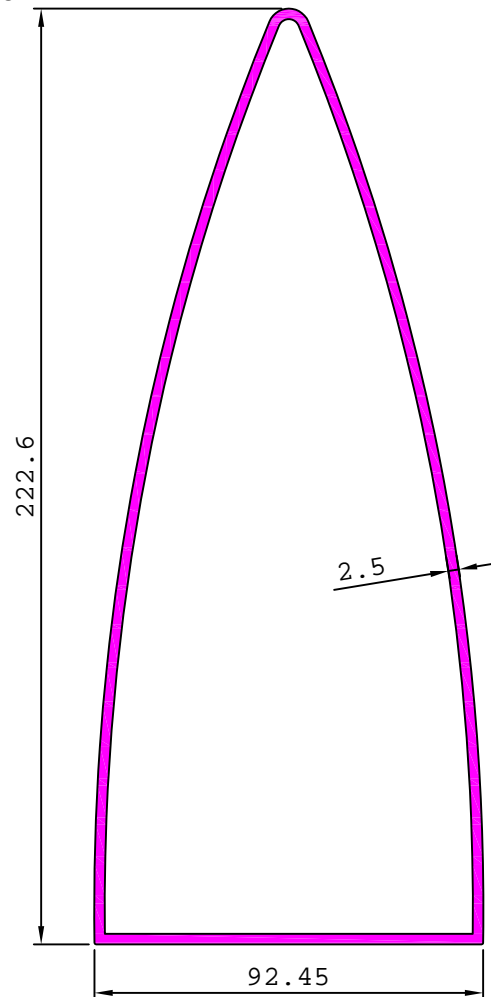

ARCHITECTURAL

LOUVER SECTION

21409

1.547 kg/m

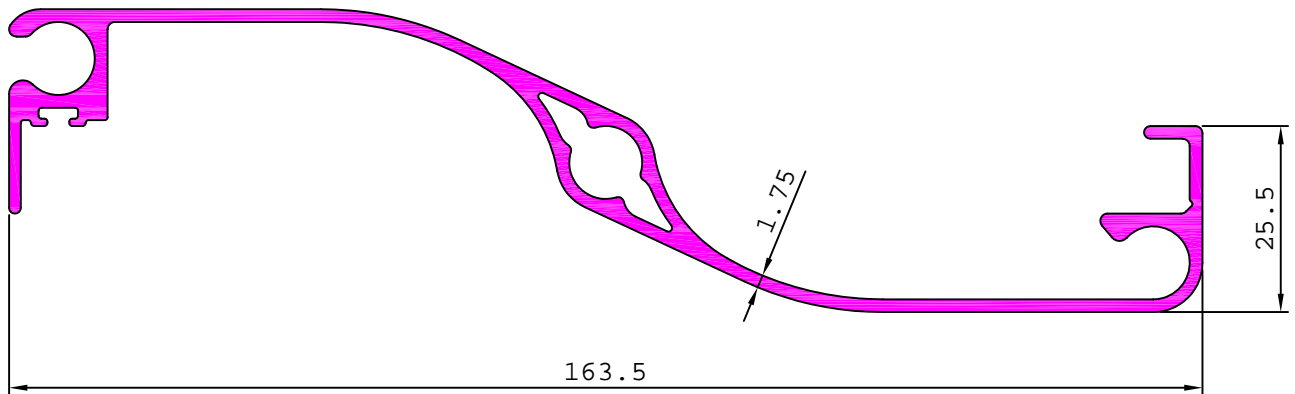

21417

2.014 kg/m

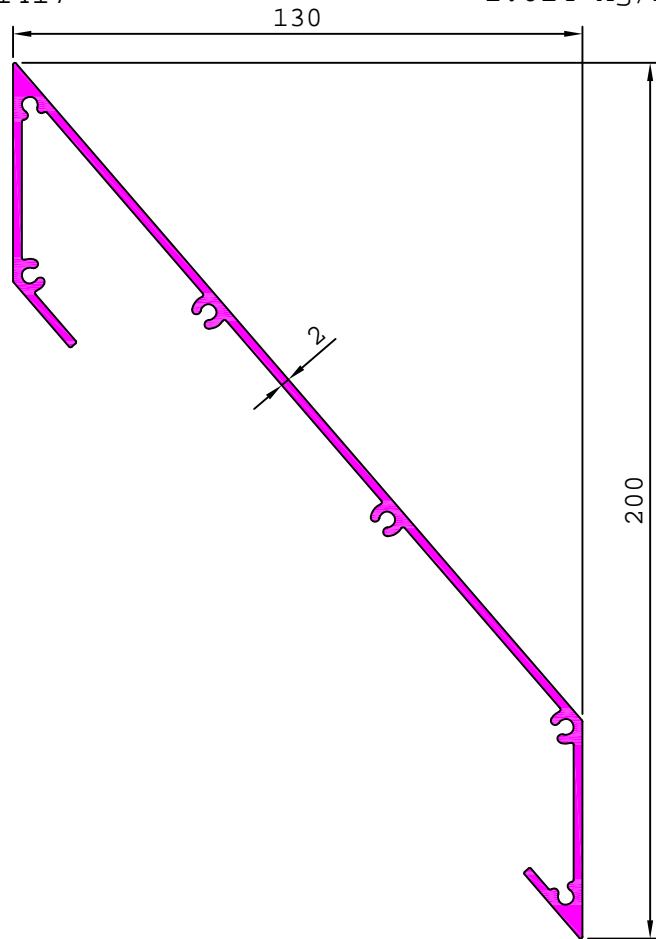

21420

0.947kg/m

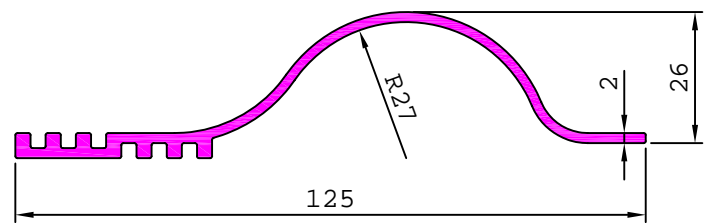

21421

0.728 kg/m

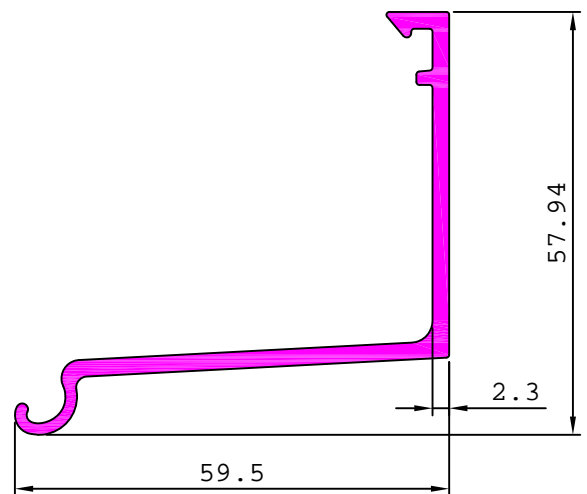

21450

0.678 kg/m

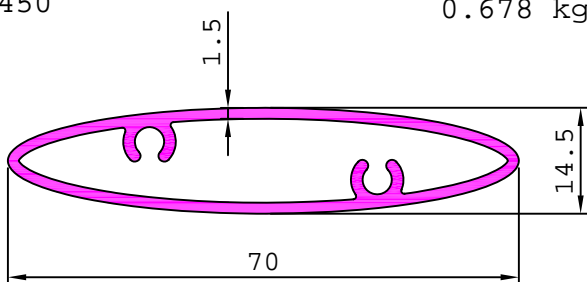

21451

0.249 kg/m

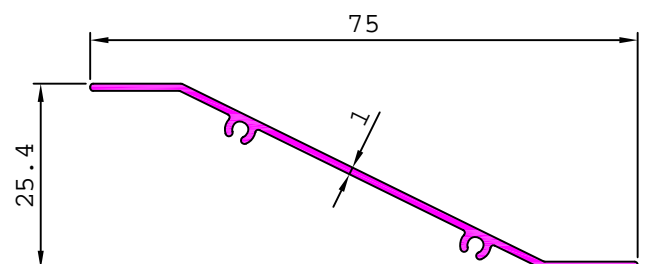

ARCHITECTURAL

LOUVER SECTION

21472

1.111 kg/m

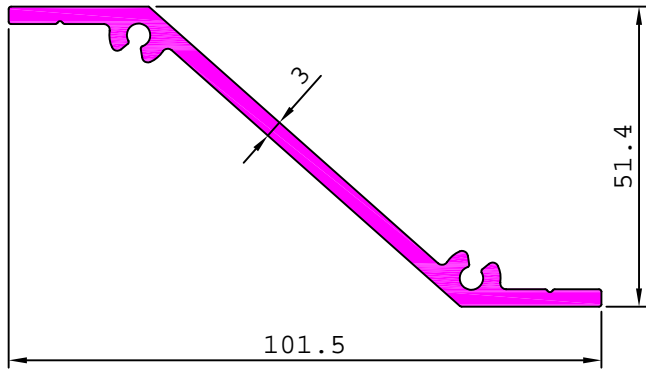

21468

0.843 kg/m

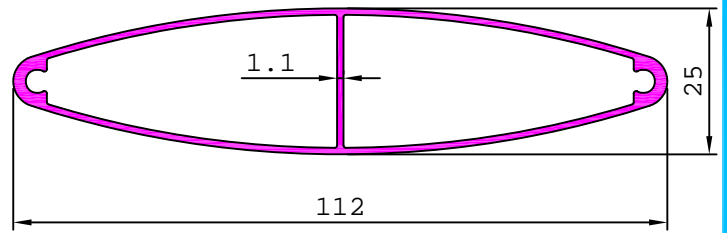

21637

2.038 kg/m

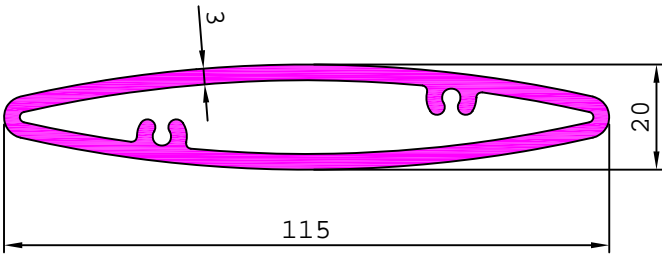

21639

0.854 kg/m

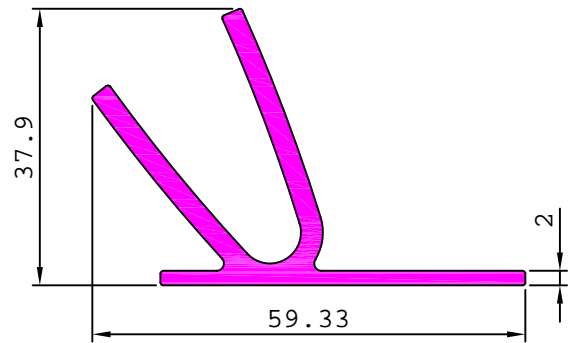

21652

2.740 kg/m

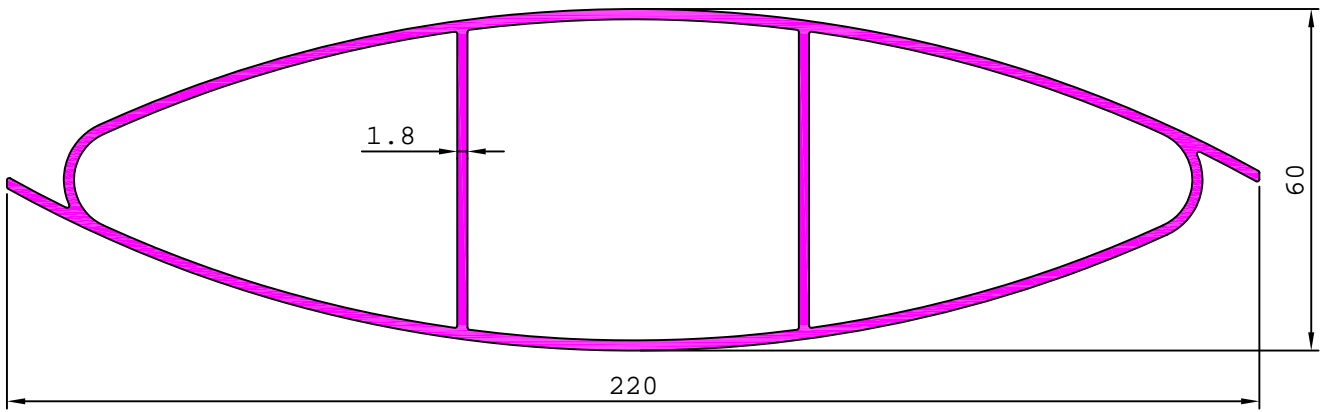

21689

6.093 kg/m

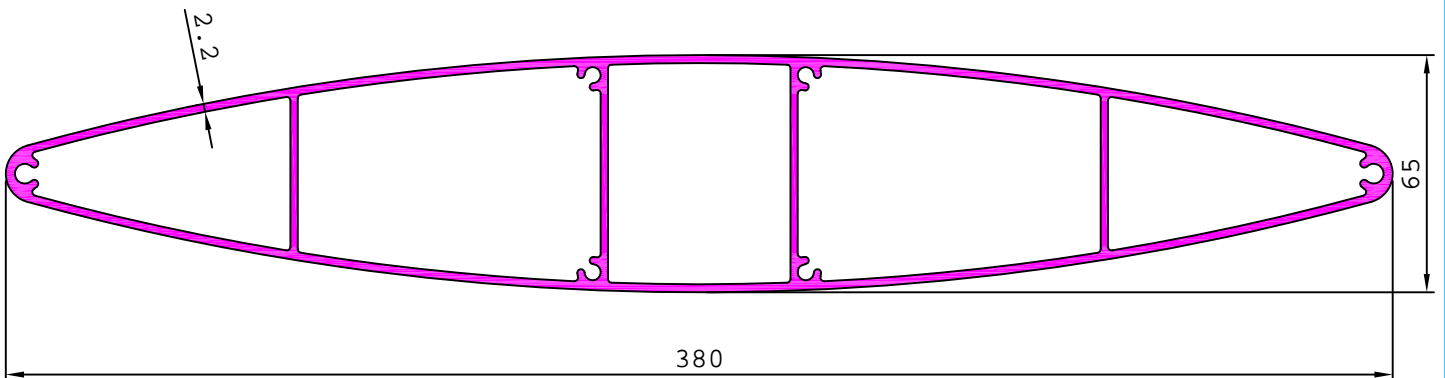

ARCHITECTURAL

LOUVER SECTION

21712

1.267 kg/m

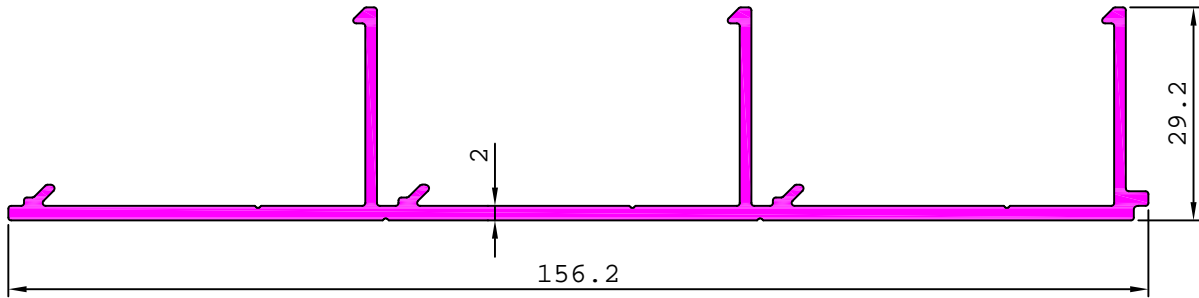

21713

0.385 kg/m

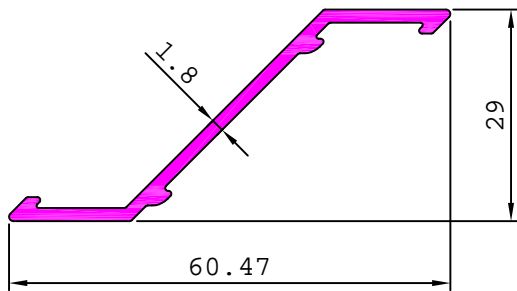

21719

1.048 kg/m

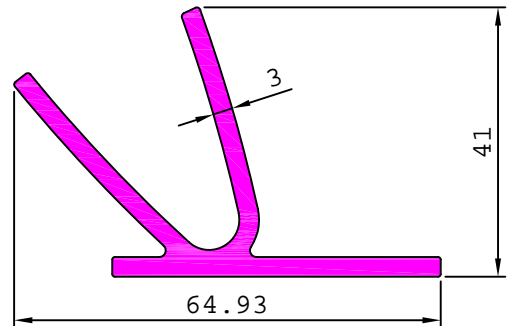

21720

1.129 kg/m

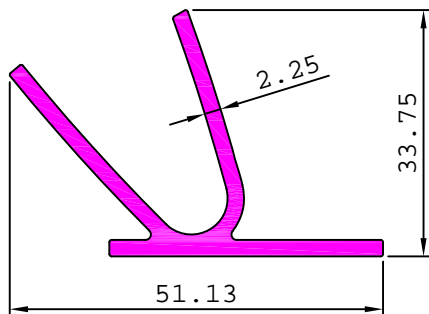

S4669

0.954 kg/m

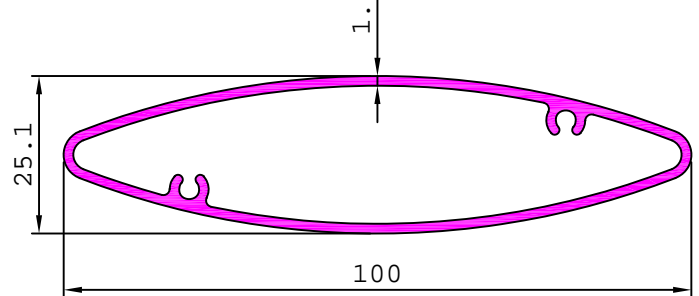

S4313

1.992 kg/m

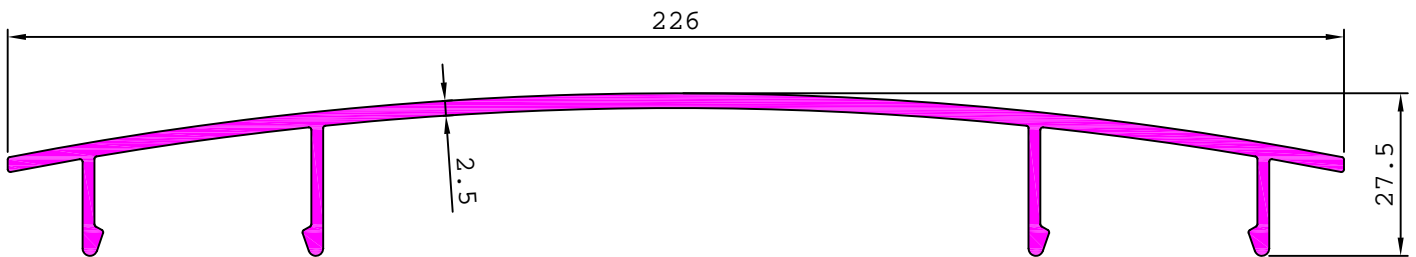

28802

0.706 kg/m

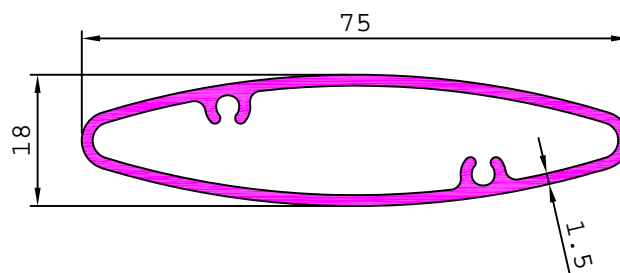

ARCHITECTURAL

LOUVER SECTION

28803

1.573 kg/m

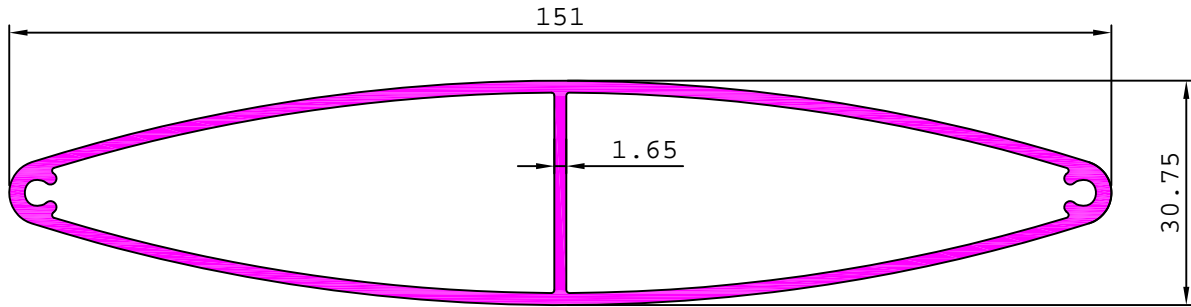

22560

3.266 kg/m

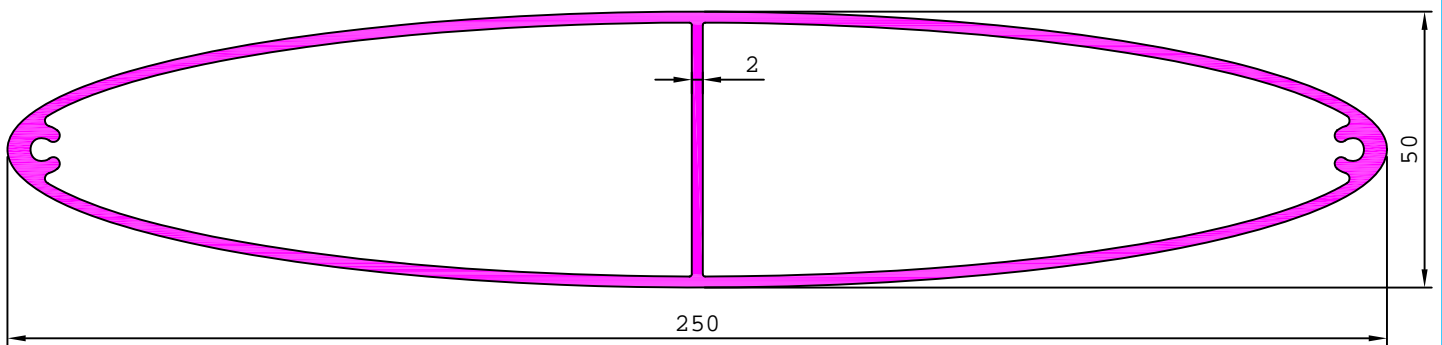

28973

0.462 kg/m

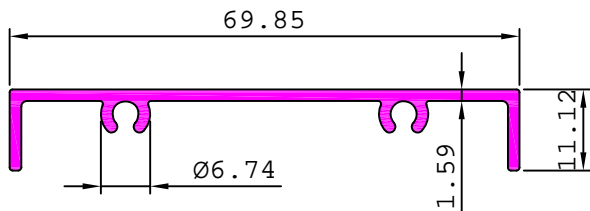

28974

0.426 kg/m

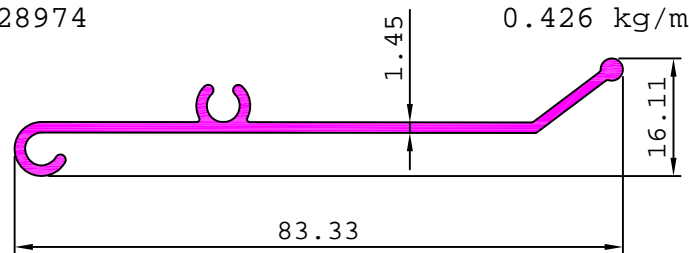

29129

1.091 kg/m

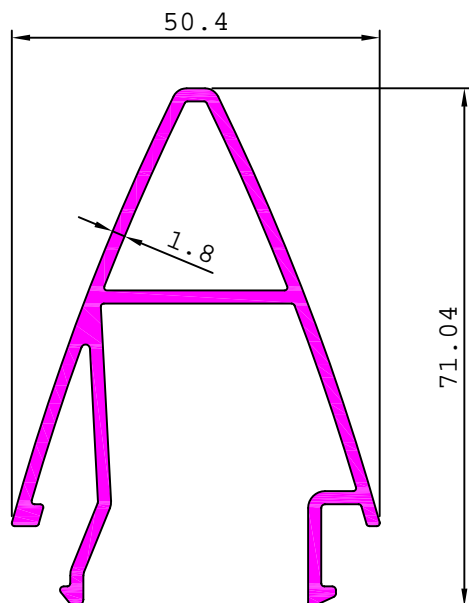

29370

6.401 kg/m

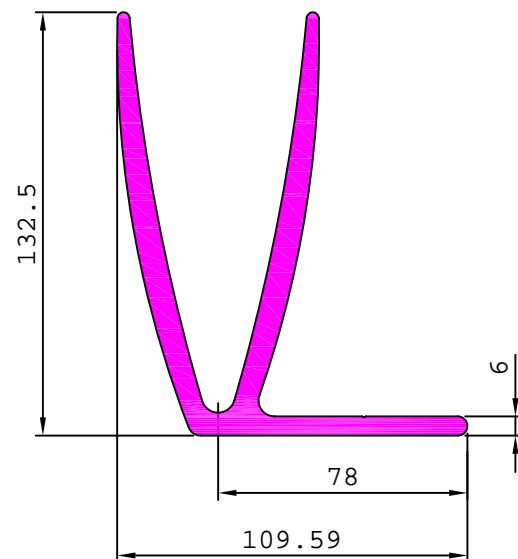

ARCHITECTURAL

LOUVER SECTION

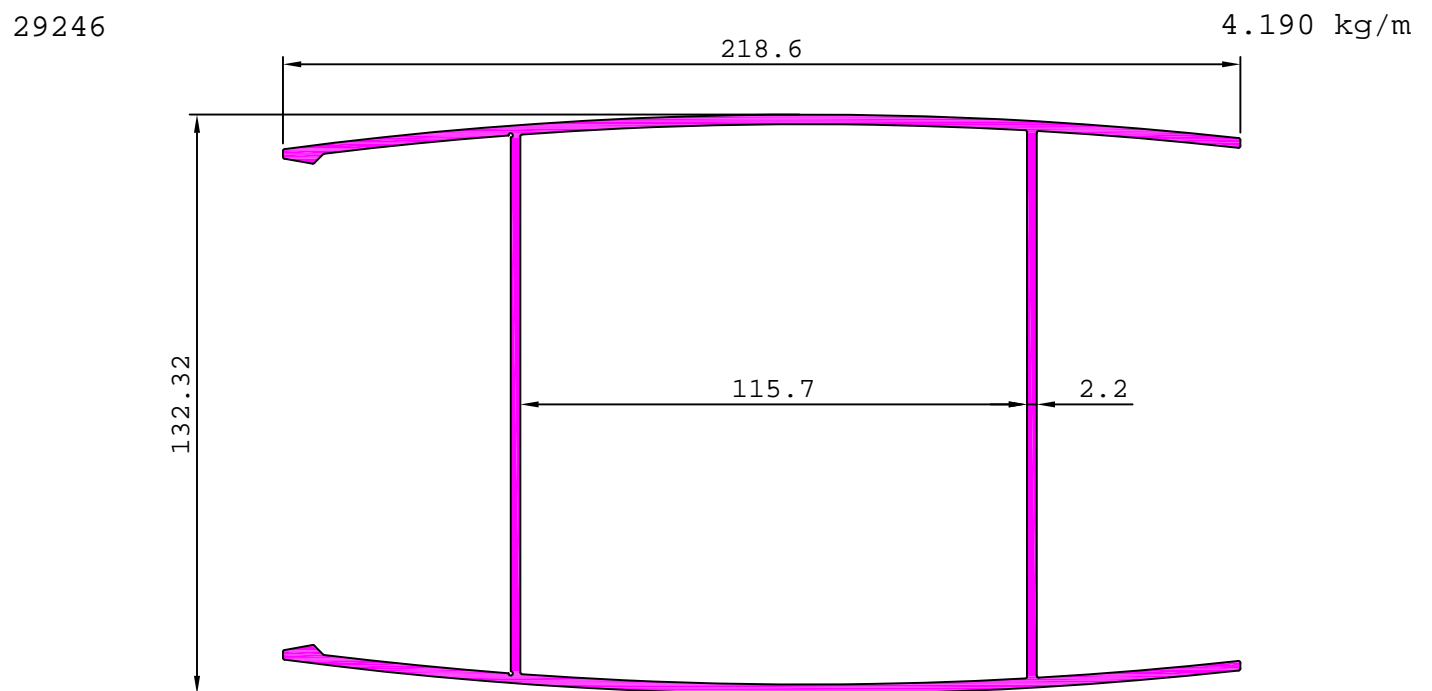
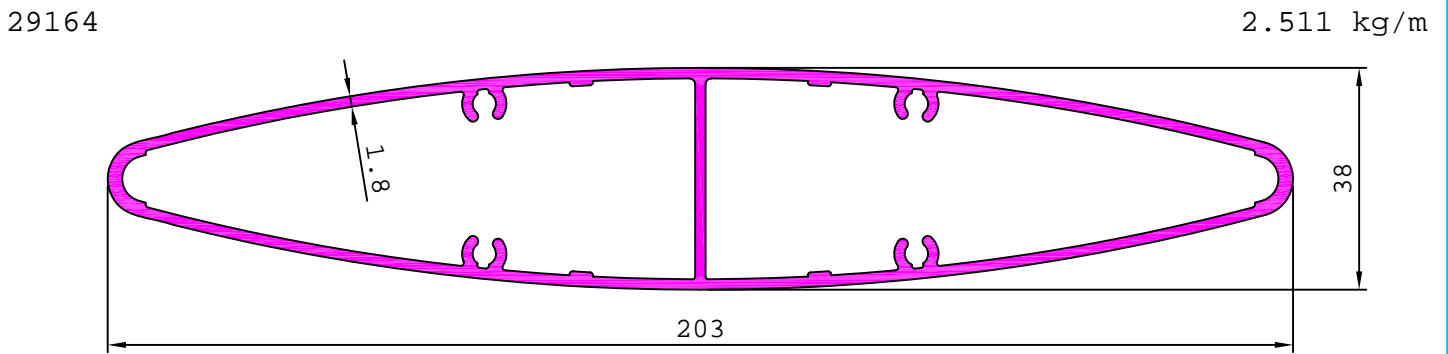
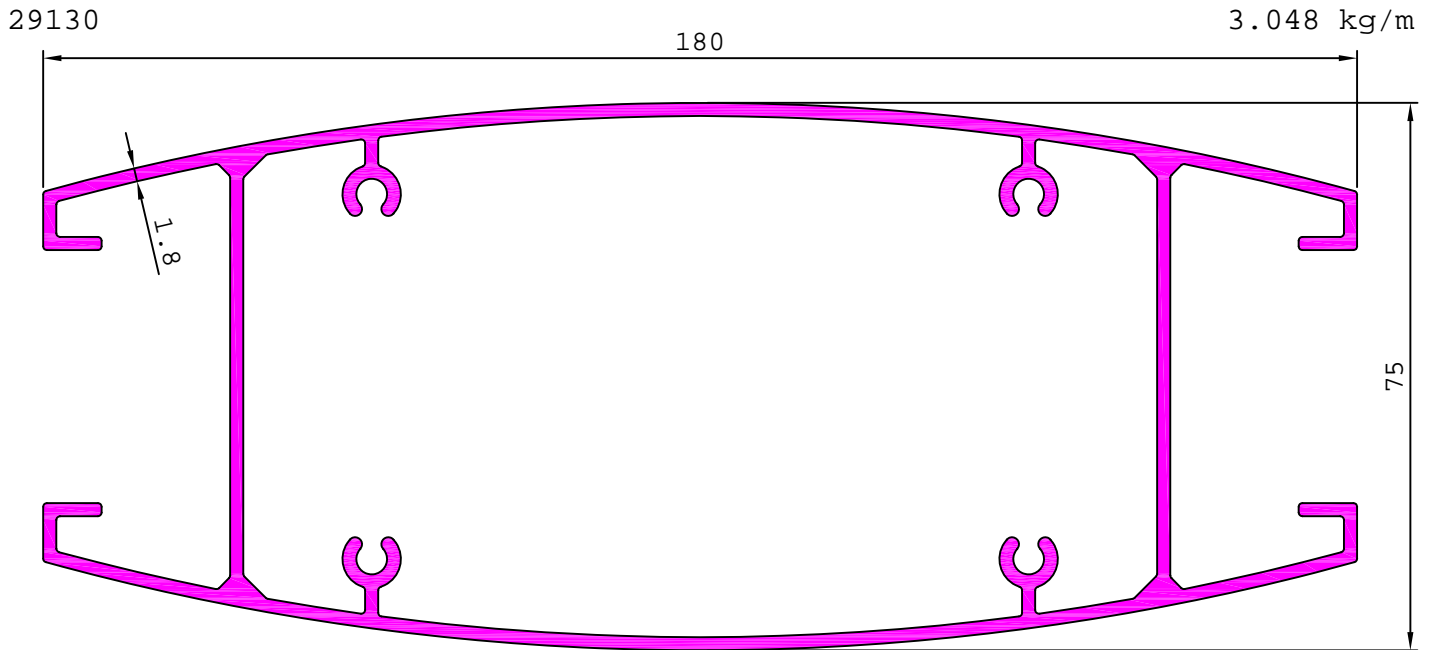

ARCHITECTURAL

LOUVER SECTION

29180

3.646 kg/m

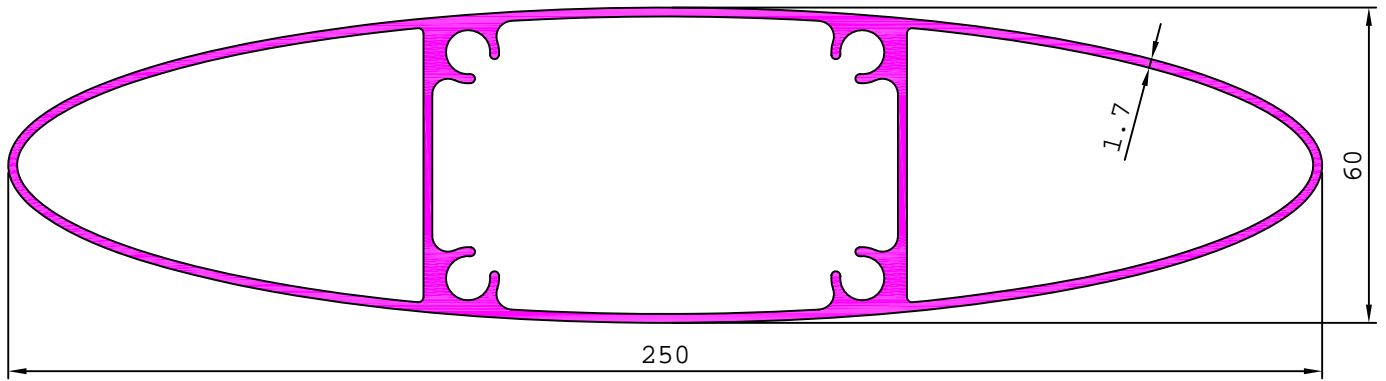

29247

3.230 kg/m

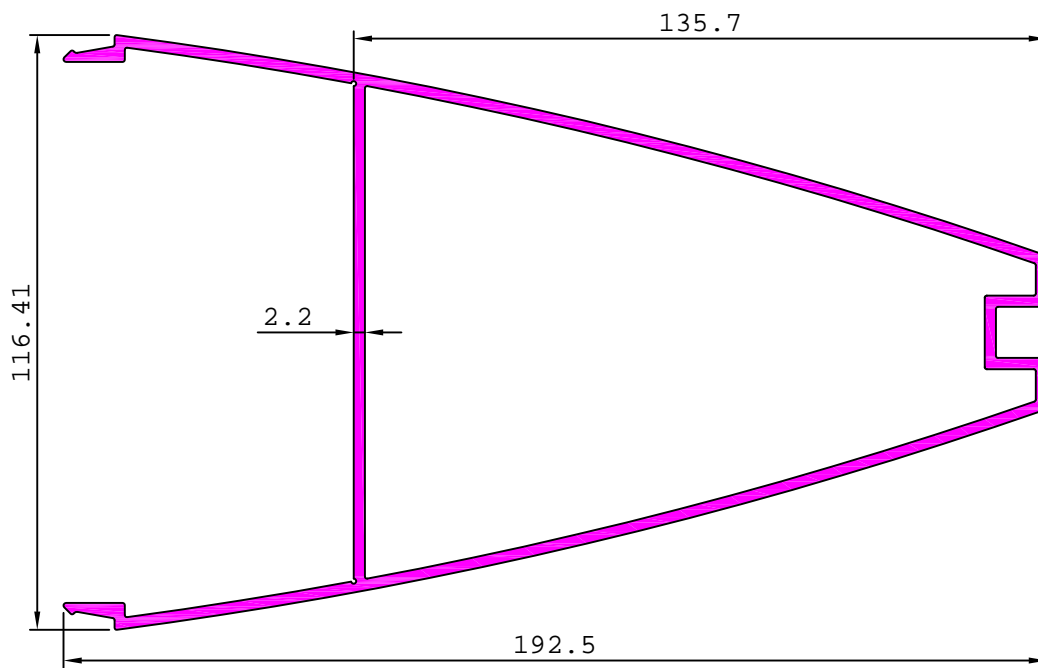

29328

2.477 kg/m

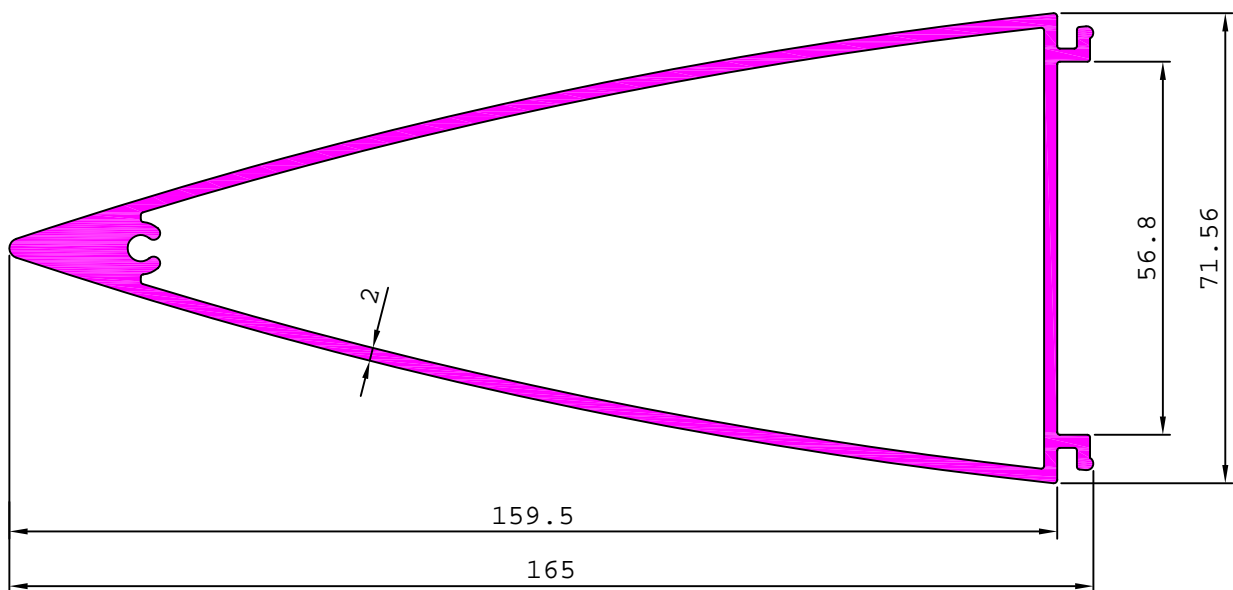

ARCHITECTURAL

LOUVER SECTION

29330

3.243 kg/m

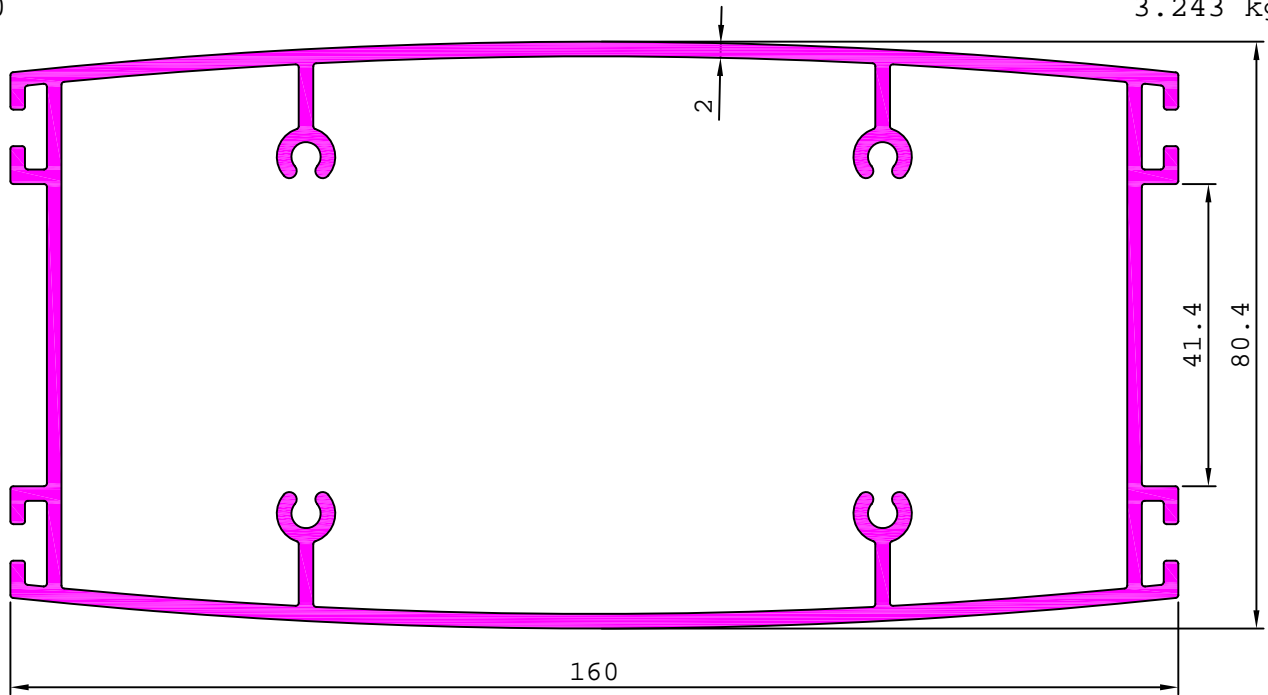

29382

6.174 kg/m

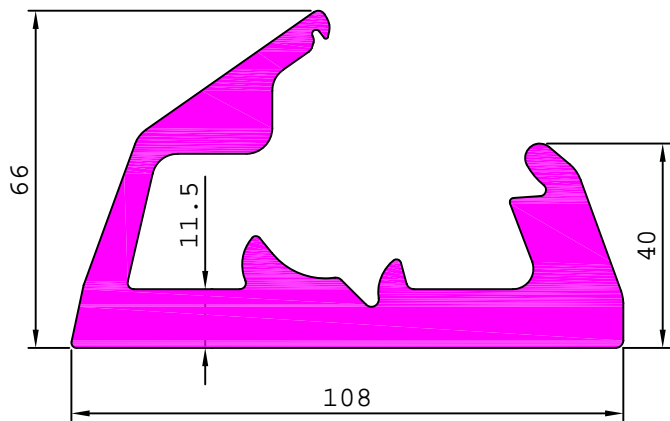

29383

3.032 kg/m

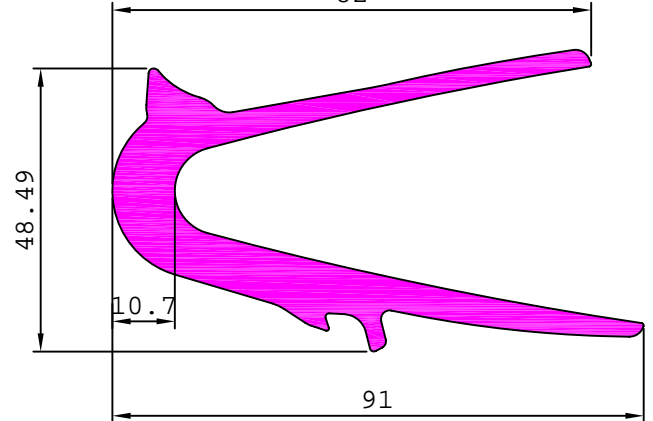

29404

3.048 kg/m

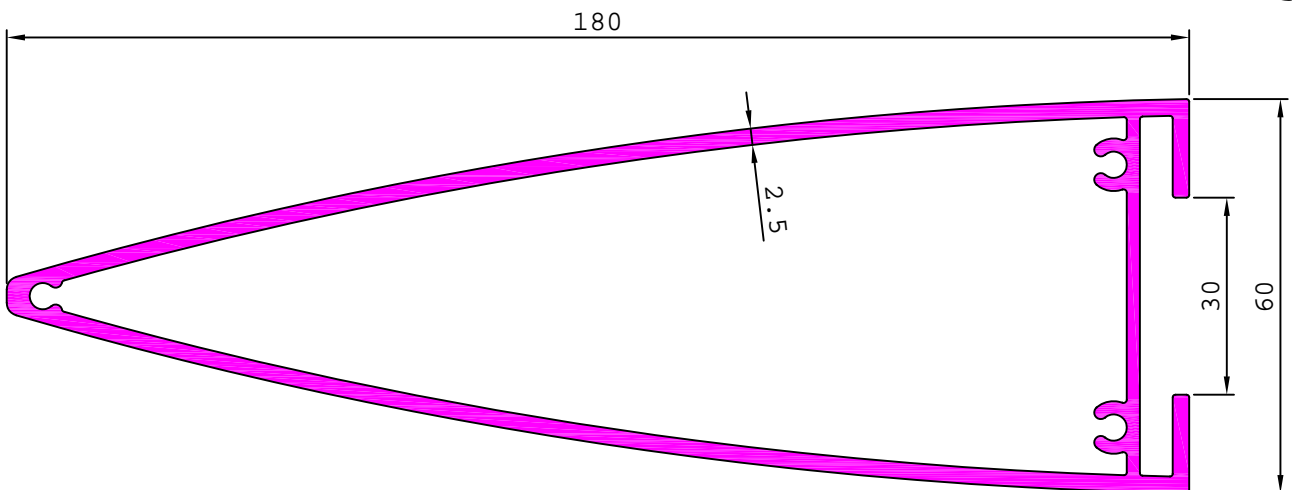

ARCHITECTURAL

LOUVER SECTION

29332

6.336 kg/m

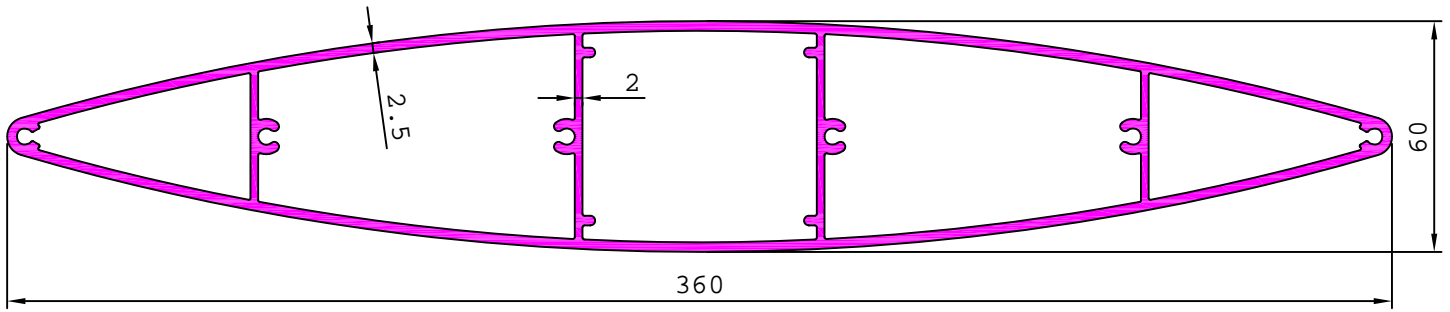

21591

0.610 kg/m

S5088

1.001 kg/m

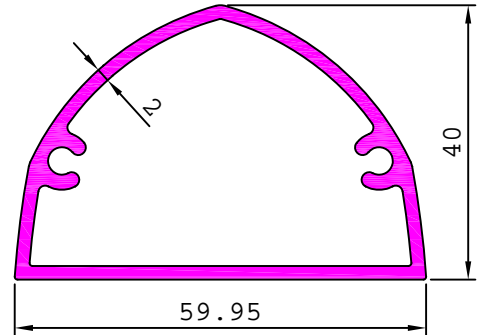
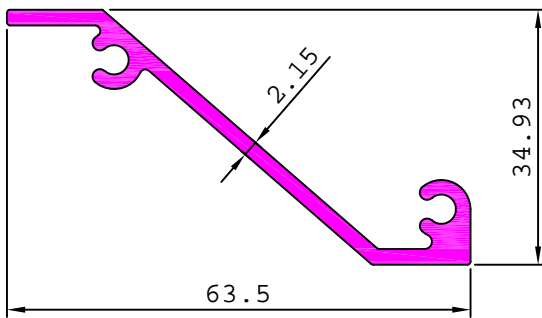

21595

5.979 kg/m

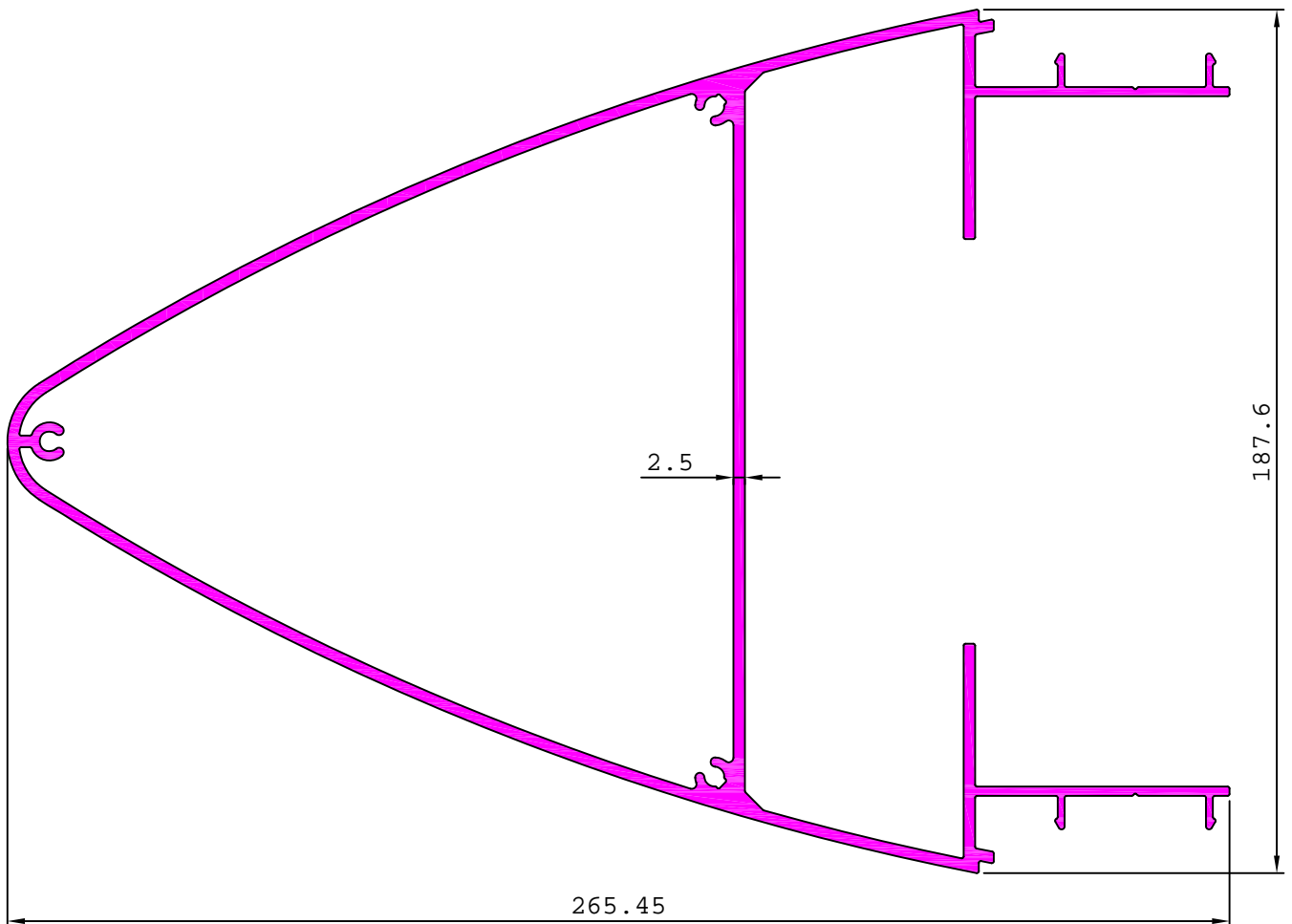

ARCHITECTURAL

LOUVER SECTION

S5087

1.492 kg/m

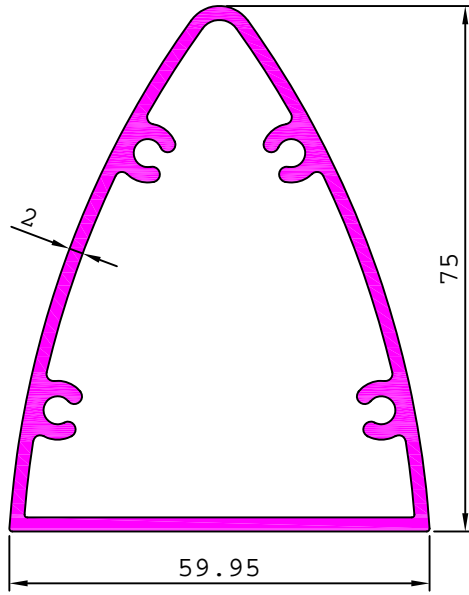

S5215

0.893 kg/m

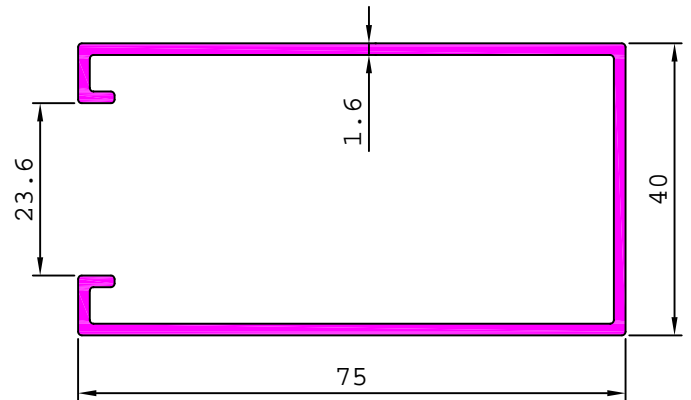

S5116

3.334 kg/m

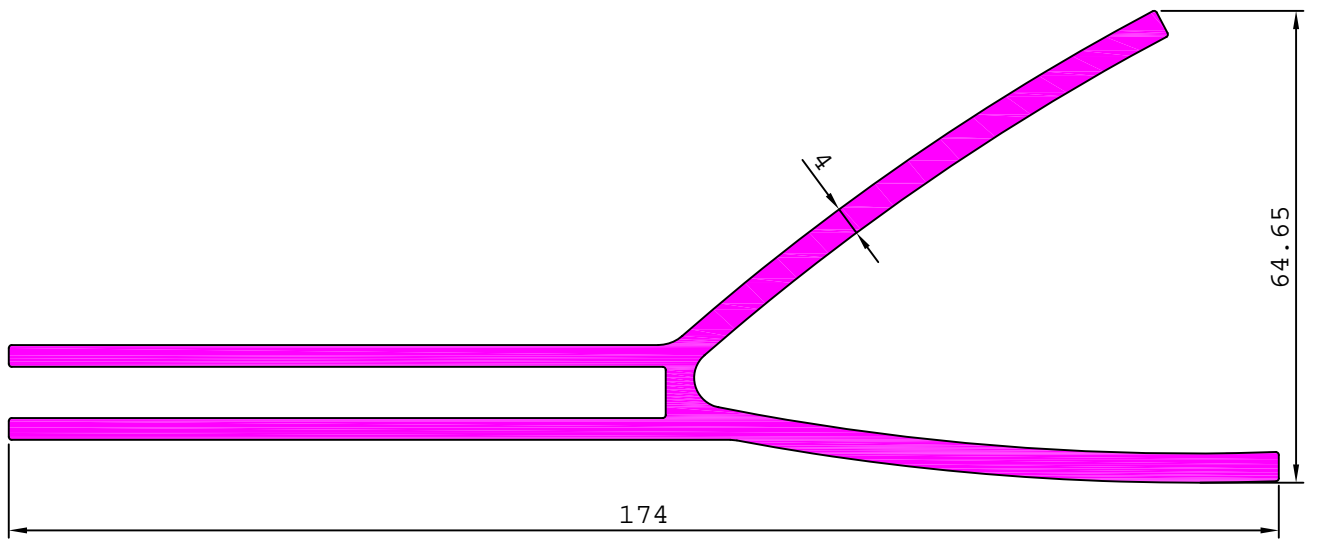

S5117

5.576 kg/m

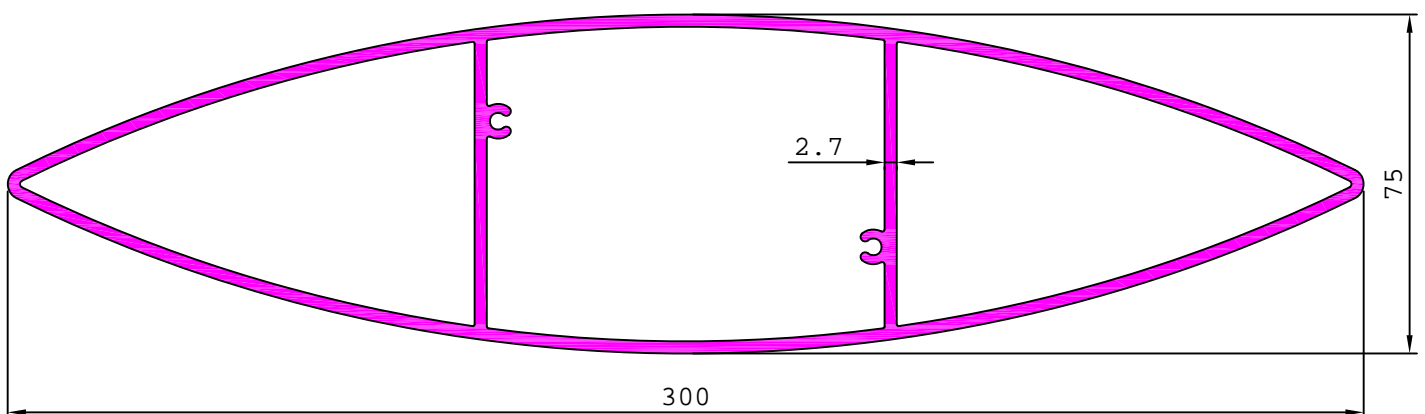

ARCHITECTURAL

FLY SCREEN

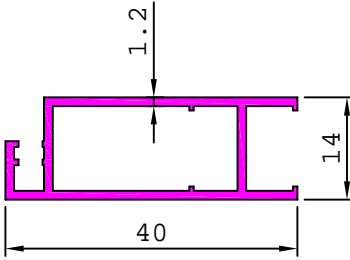
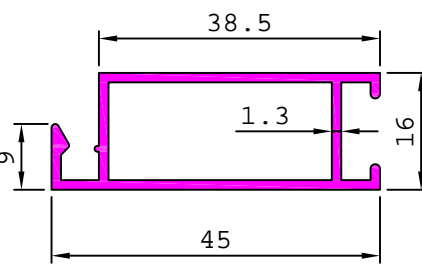
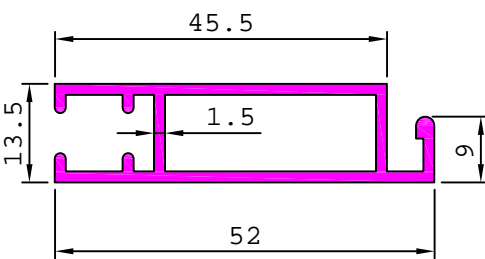
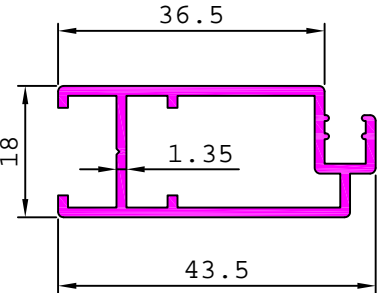
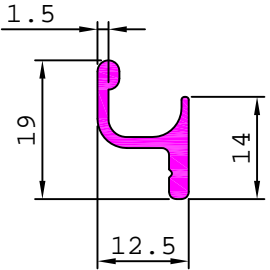
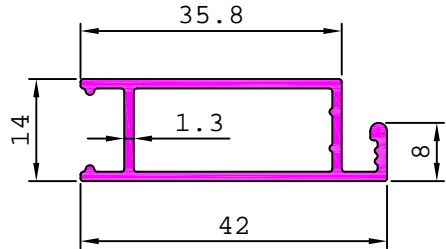
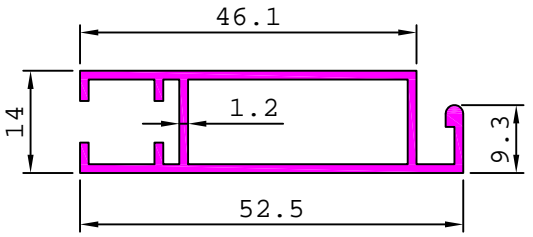
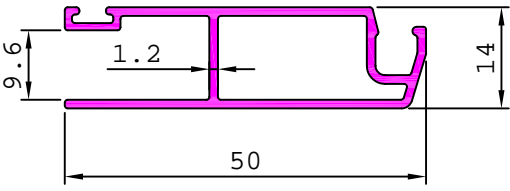
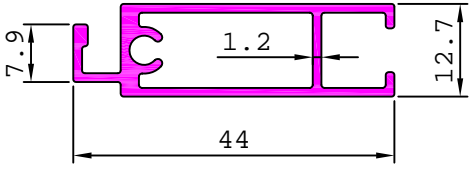
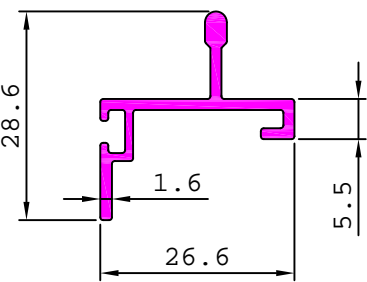
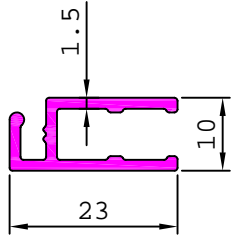
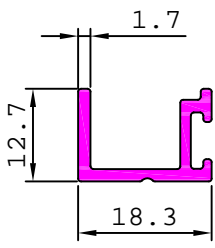
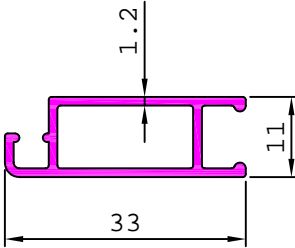
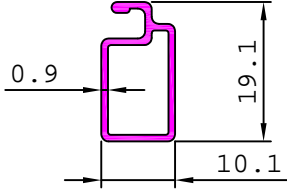
<p>20747 0.346 kg/m</p> 	<p>20758 0.430 kg/m</p> 	<p>20777 0.560 kg/m</p> 
<p>20791 0.466 kg/m</p> 	<p>20866 0.173 kg/m</p> 	<p>21041 0.390 kg/m</p> 
<p>20985 0.467 kg/m</p> 		<p>29059 0.424 kg/m</p> 
<p>21154 0.421 kg/m</p> 	<p>21155 0.275 kg/m</p> 	<p>21325 0.233 kg/m</p> 
<p>21326 0.198 kg/m</p> 	<p>21389 0.274 kg/m</p> 	<p>21368 0.139 kg/m</p> 

ARCHITECTURAL

FLY SCREEN

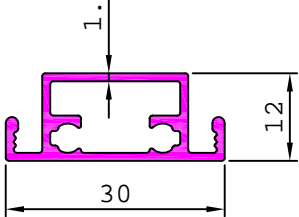
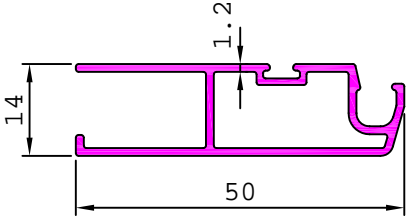
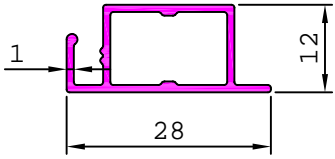
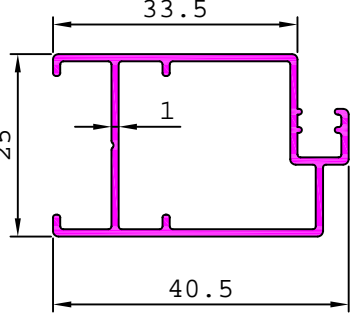
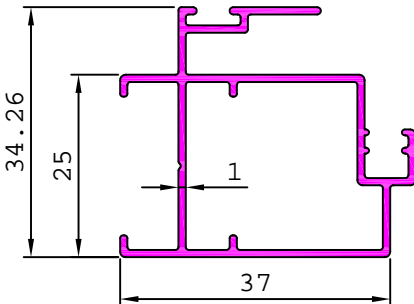
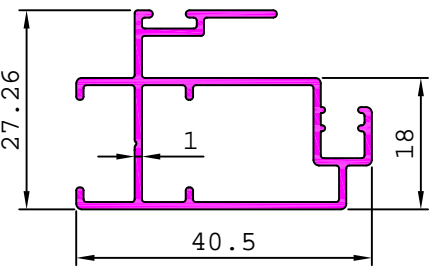
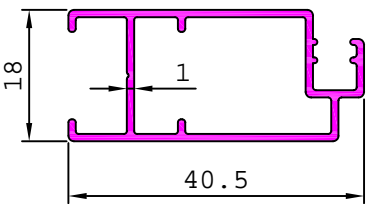
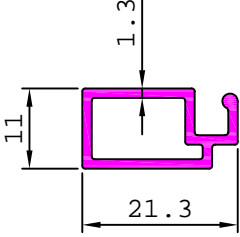
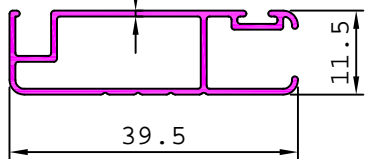
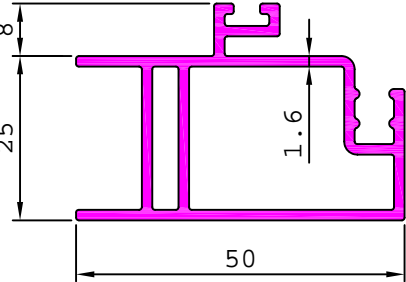
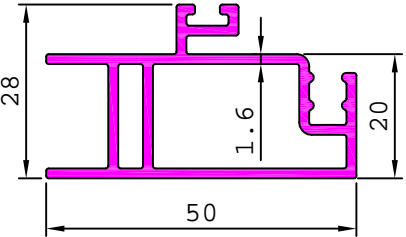
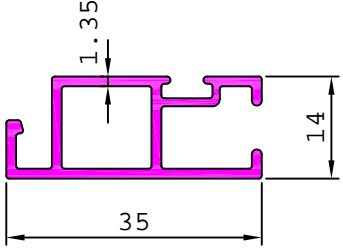
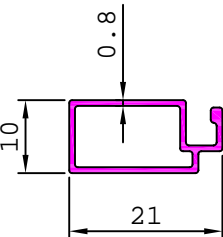
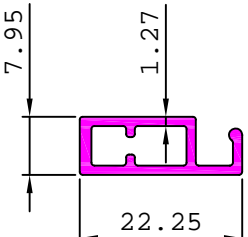
<p>21341 0.287 kg/m</p> 	<p>21386 0.432 kg/m</p> 	<p>21445 0.205 kg/m</p> 
<p>21443 0.377 kg/m</p> 	<p>21444 0.466 kg/m</p> 	<p>21465 0.430 kg/m</p> 
<p>21466 0.340 kg/m</p> 	<p>21578 0.219 kg/m</p> 	<p>21612 0.242 kg/m</p> 
<p>21598 0.854 kg/m</p> 	<p>21599 0.790 kg/m</p> 	<p>21664 0.370 kg/m</p> 
<p>21638 0.136 kg/m</p> 	<p>21703 0.201 kg/m</p> 	

ARCHITECTURAL

VENETIAN BLINDS

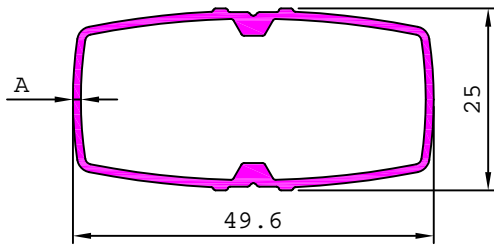

SL. No.	Section No.	A	Weight kg/m
1	S4749	1.10	0.442
2	22049	1.20	0.474
3	22006	1.35	0.545
4	22002	1.60	0.620

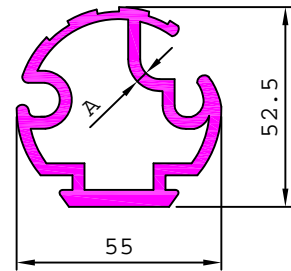

SL. No.	Section No.	A	Weight kg/m
1	22077	1.10	0.749
2	22048	1.20	0.811
3	22010	1.25	0.872
4	22007	1.50	1.028
5	22003	2.00	1.276

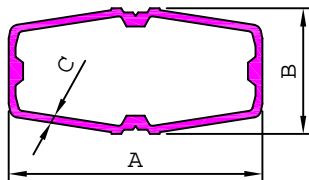

SL. No.	Section No.	A	B	C	Weight kg/m
1	22004	60.60	30.50	1.35	0.709
2	22018	60.60	30.50	1.62	0.800
3	22009	75.00	36.10	1.70	0.983

22001 0.399 kg/m

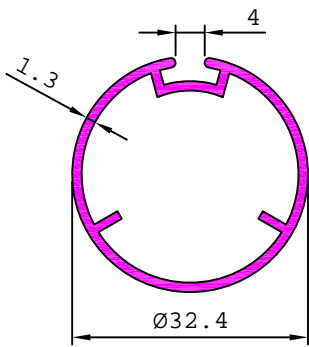

22012 0.728 kg/m

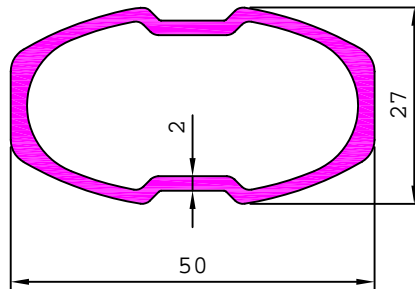

22011 1.215 kg/m

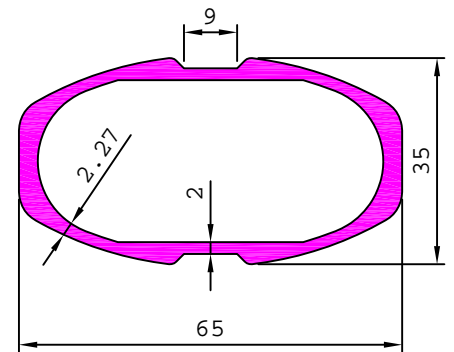

22005 1.060 kg/m

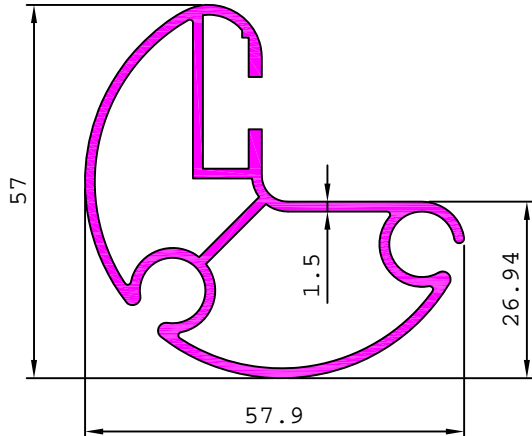

22013 1.404 kg/m

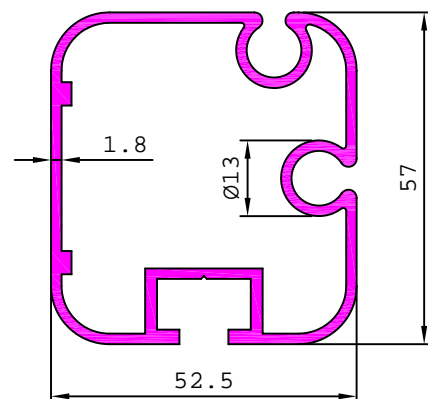

ARCHITECTURAL

VENETIAN BLINDS

22014 1.260 kg/m

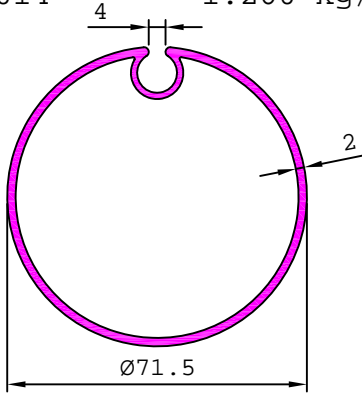

22015 0.303 kg/m

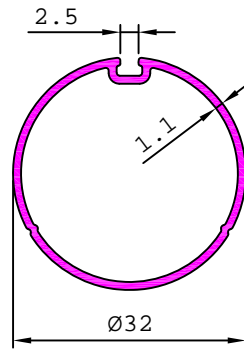

22021 0.529 kg/m

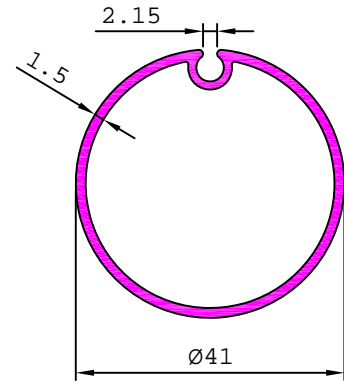

22019 0.217 kg/m

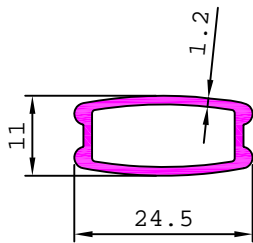

22020 0.316 kg/m

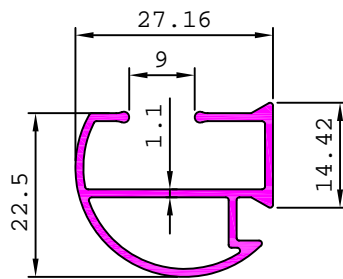

22016 0.270 kg/m

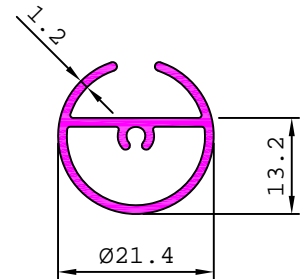

22022 0.505 kg/m

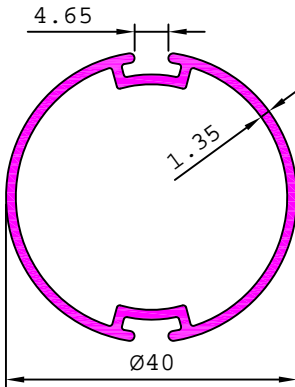

22024 0.483 kg/m

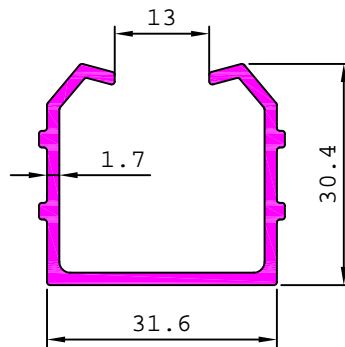

22025 0.491 kg/m

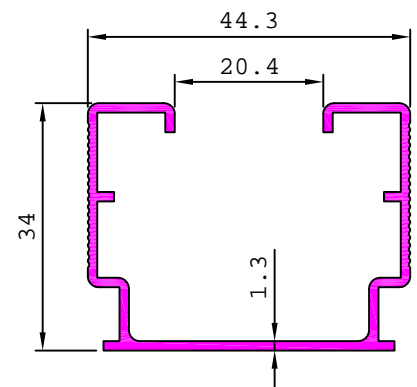

22026 0.261 kg/m

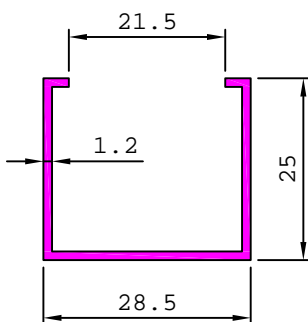

22027 0.375 kg/m

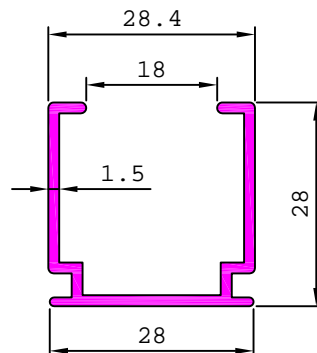

22029 0.431 kg/m

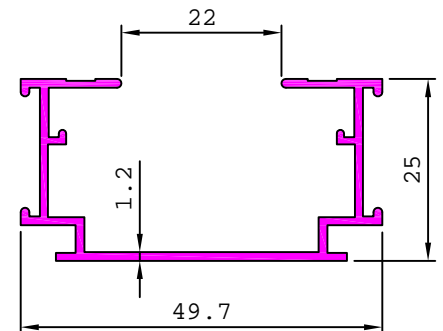

ARCHITECTURAL

VENETIAN BLINDS

22034 0.328 kg/m

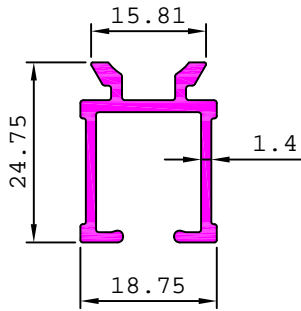

22035 0.190 kg/m

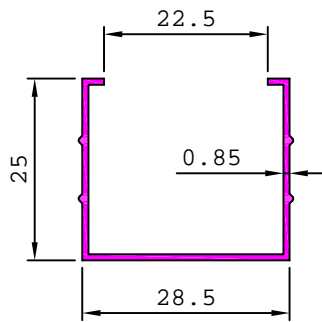

22036 0.440 kg/m

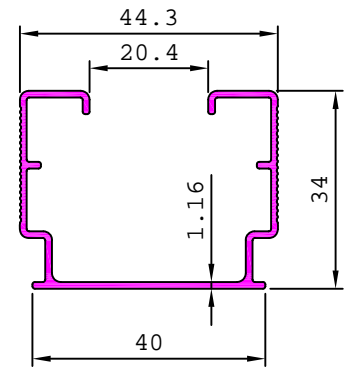

22037 0.381 kg/m

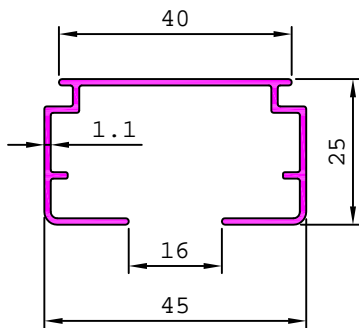

22038 0.136 kg/m

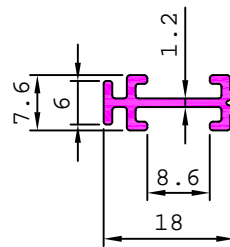

22039 0.370 kg/m

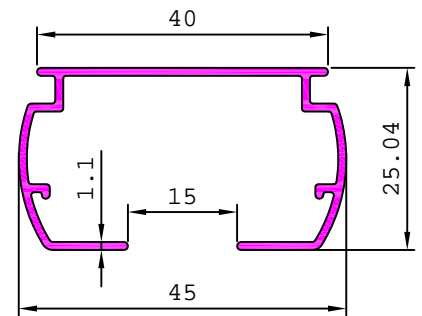

22040 0.387 kg/m

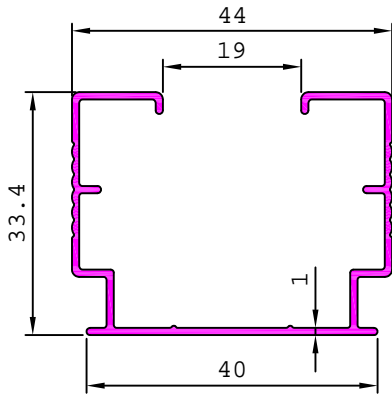

22044 0.436 kg/m

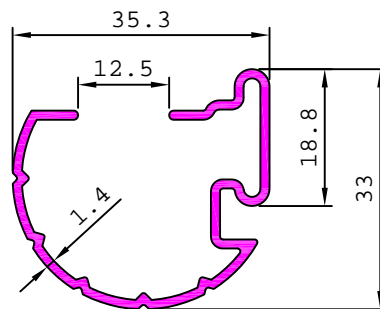

22045 0.489 kg/m

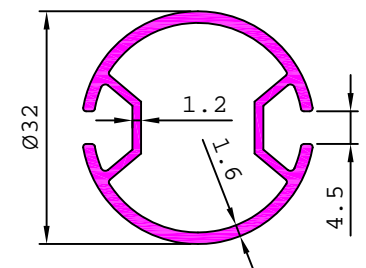

22046 0.521 kg/m

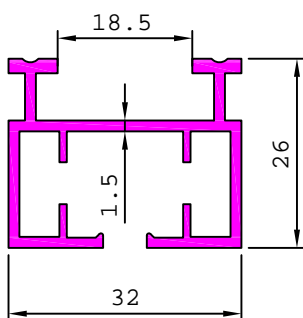

22051 0.370 kg/m

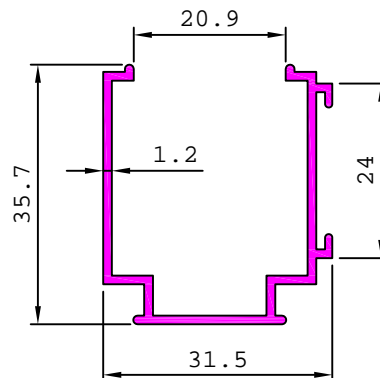

22052 0.324 kg/m

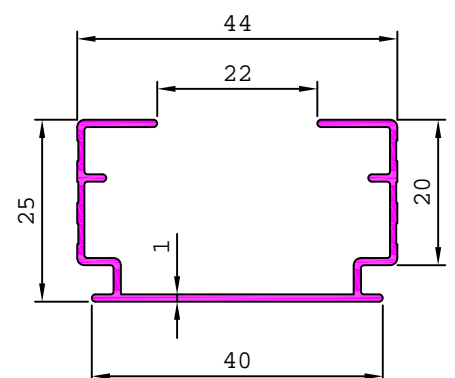

ARCHITECTURAL

VENETIAN BLINDS

22053 0.247 kg/m

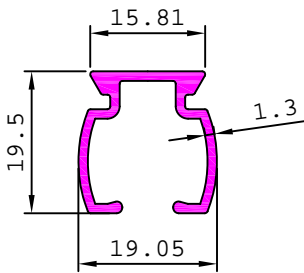

22054 0.613 kg/m

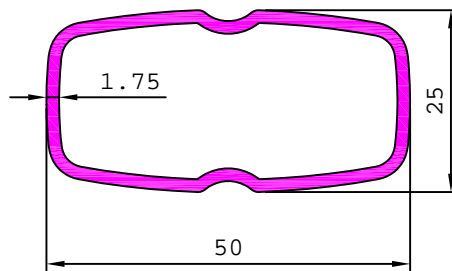

22056 0.269 kg/m

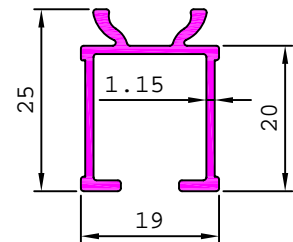

22057 0.403 kg/m

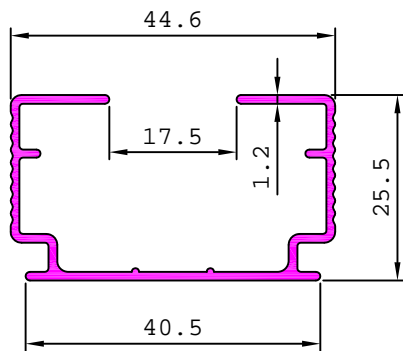

22058 0.343 kg/m

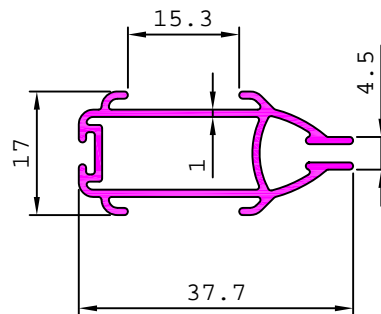

22059 1.346 kg/m

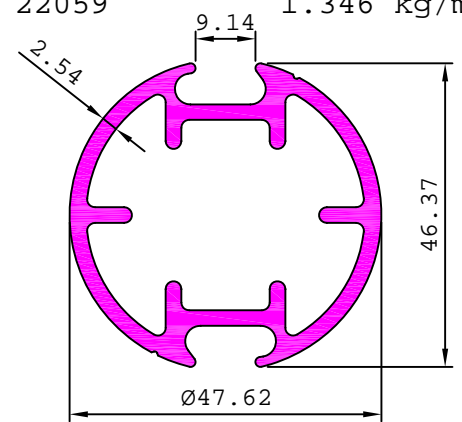

22061 0.371 kg/m

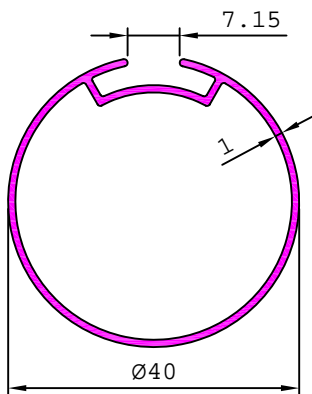

22062 0.461 kg/m

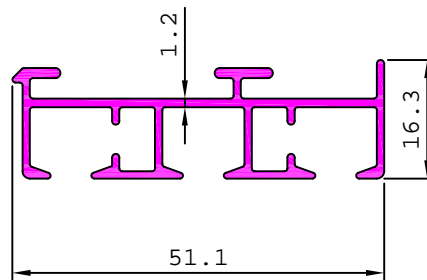

22065 0.412 kg/m

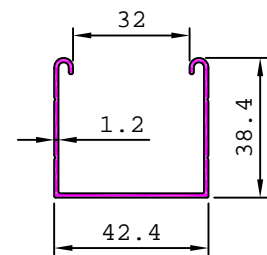

22063 0.610 kg/m

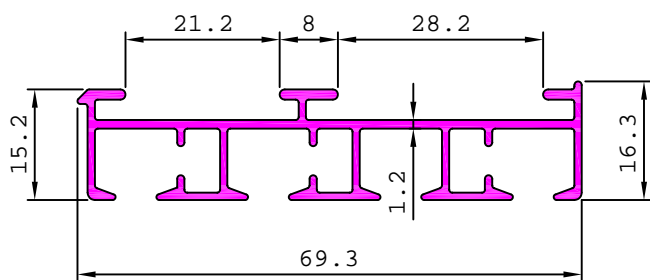

22064 0.742 kg/m

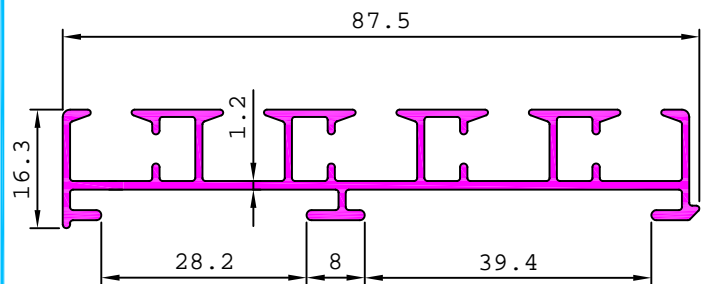

ARCHITECTURAL

VENETIAN BLINDS

22066 0.203 kg/m

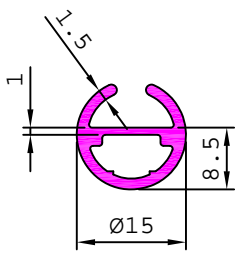

22068 0.670 kg/m

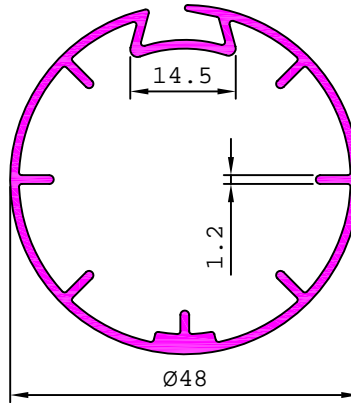

22070 0.419 kg/m

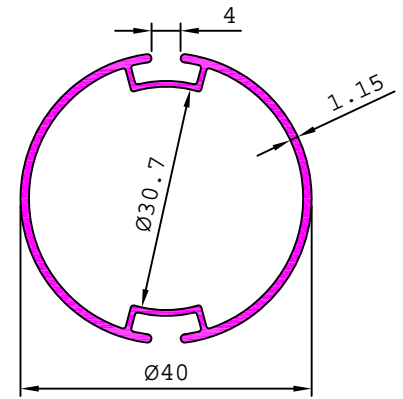

22071 0.235 kg/m

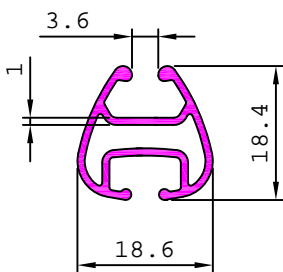

22076 0.249 kg/m

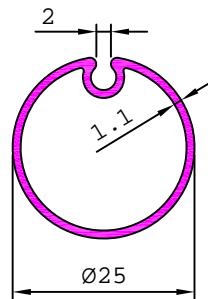

22078 0.195 kg/m

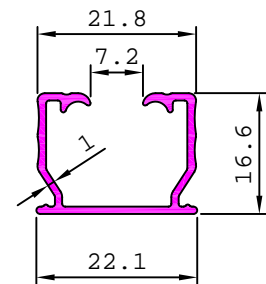

22079 0.569 kg/m

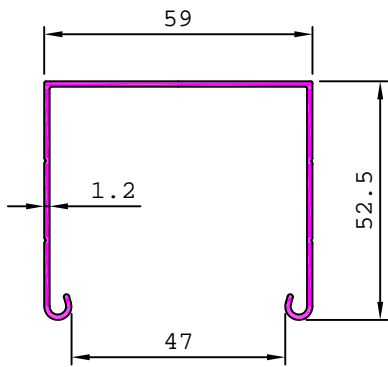

22081 0.402 kg/m

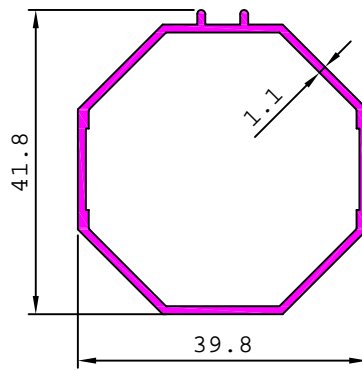

22082 0.549 kg/m

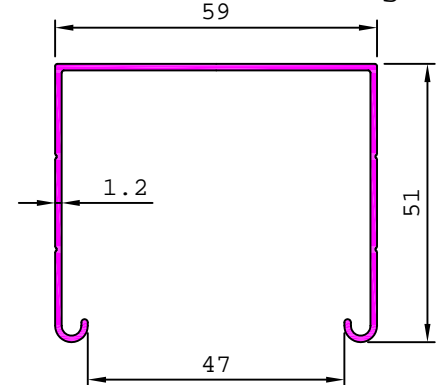

22083 0.794 kg/m

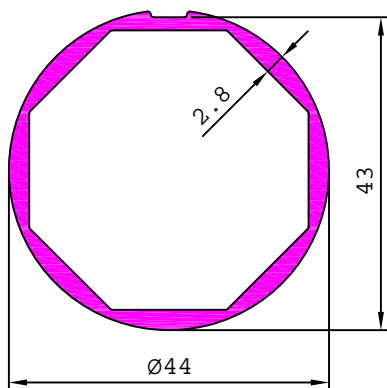

22084 0.623 kg/m

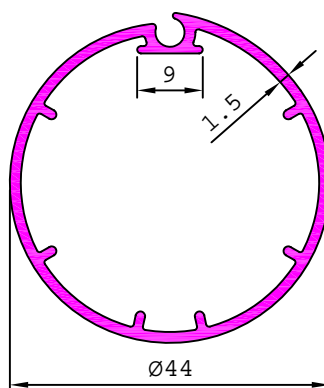

22085 0.380 kg/m

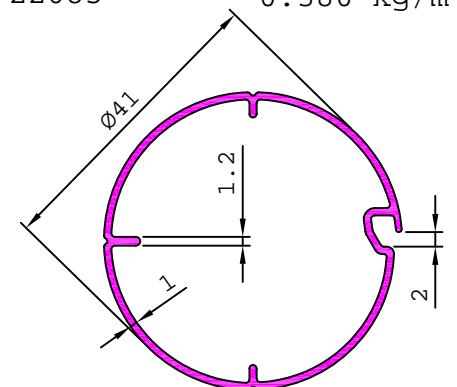

ARCHITECTURAL

VENETIAN BLINDS

<p>22086 0.452 kg/m</p> <p>Ø40</p>	<p>22087 0.493 kg/m</p> <p>Ø39.5</p>	<p>22089 0.195 kg/m</p>
<p>22090 0.130 kg/m</p>	<p>22091 0.390 kg/m</p> <p>Ø38.5</p>	<p>22092 0.220 kg/m</p> <p>Ø20.1</p>
<p>22093 0.297 kg/m</p>	<p>22095 0.194 kg/m</p> <p>Ø19</p>	<p>22099 0.215 kg/m</p>
<p>22096 0.724 kg/m</p>	<p>22100 0.571 kg/m</p> <p>Ø40.6</p>	

ARCHITECTURAL

VENETIAN BLINDS

34001 0.947 kg/m

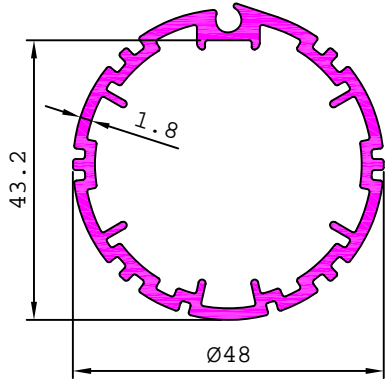

34002 0.465 kg/m

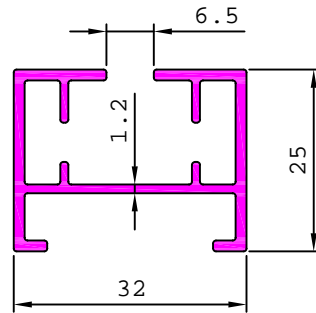

34003 0.367 kg/m

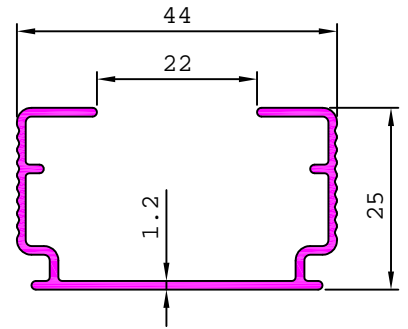

34004 0.465 kg/m

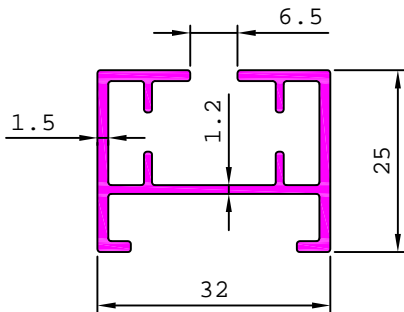

34005 0.280 kg/m

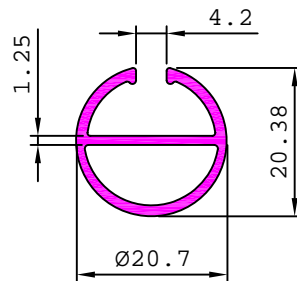

34006 0.243 kg/m

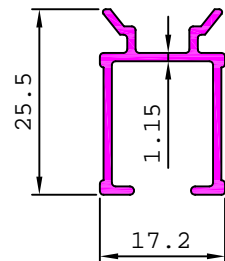

34007 0.210 kg/m

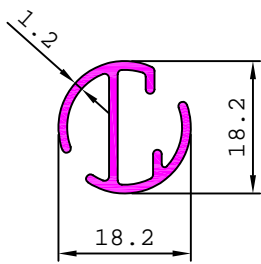

34008 0.602 kg/m

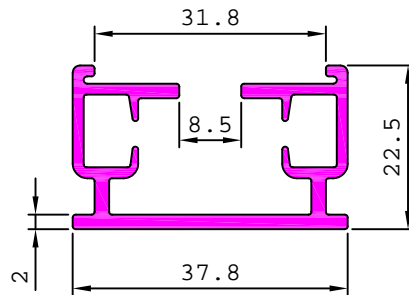

34009 0.378kg/m

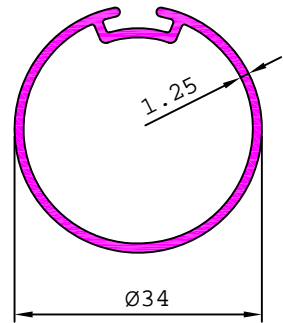

34010 0.550 kg/m

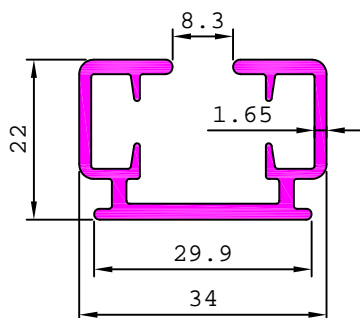

34011 0.757kg/m

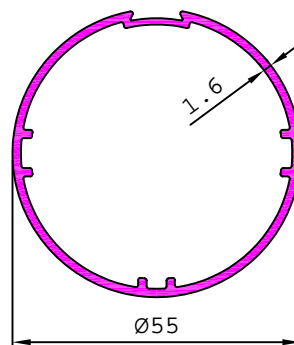

34013 0.312 kg/m

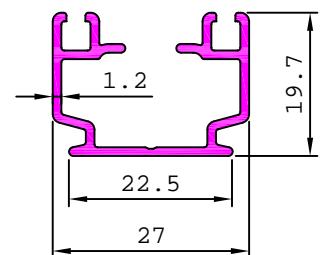

ARCHITECTURAL

VENETIAN BLINDS

34012

0.479 kg/m

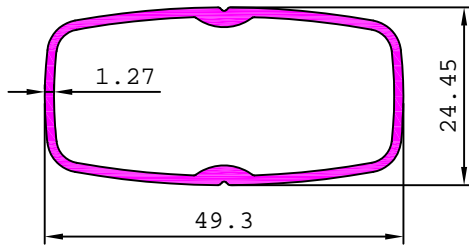

34014

0.403 kg/m

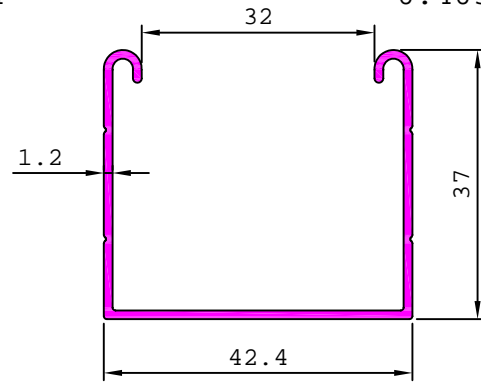

34015

0.370 kg/m

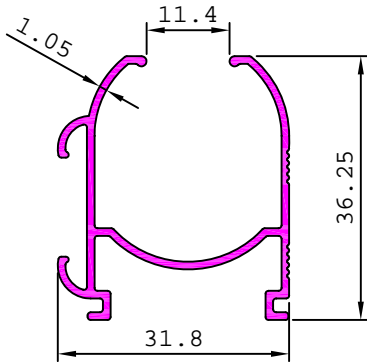

34016

0.830 kg/m

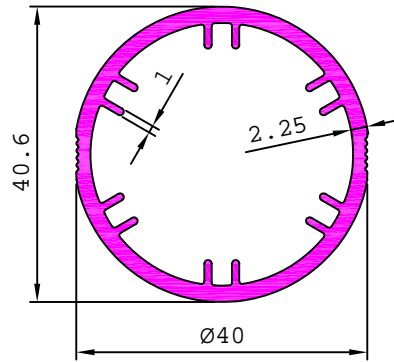

34017

0.463 kg/m

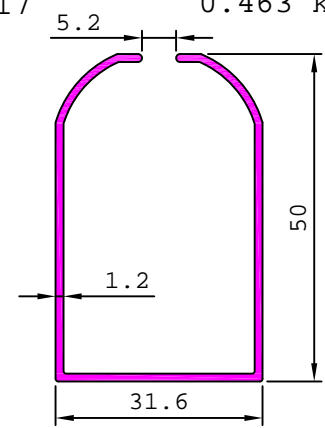

34018

0.211 kg/m

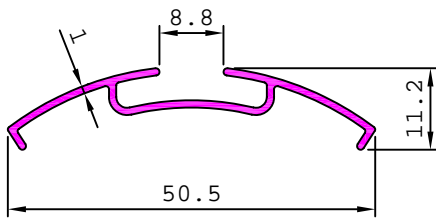

34019

0.193 kg/m

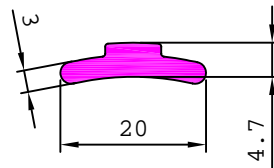

34020

0.469 kg/m

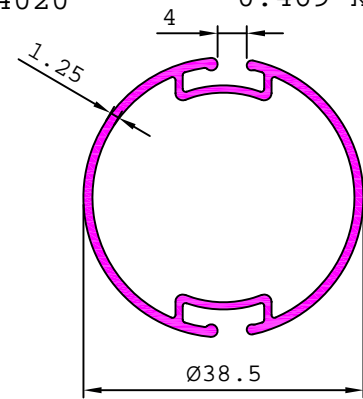

34022

0.303 kg/m

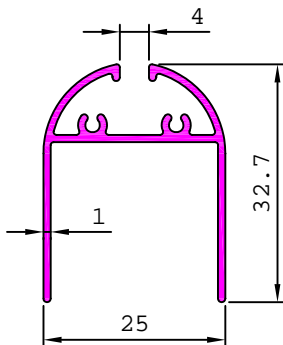

34023

0.189 kg/m

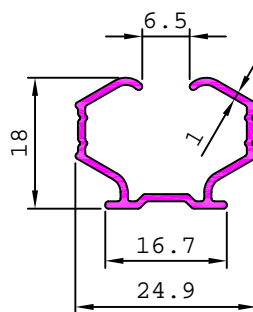

34024

0.211 kg/m

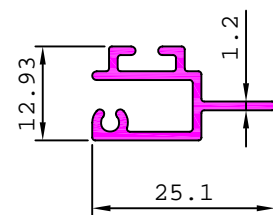

ARCHITECTURAL

VENETIAN BLINDS

34021

0.702 kg/m

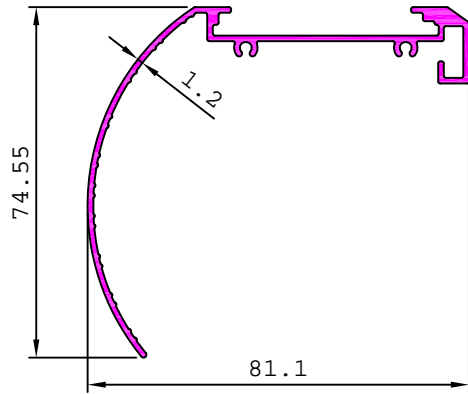

34025

0.922 kg/m

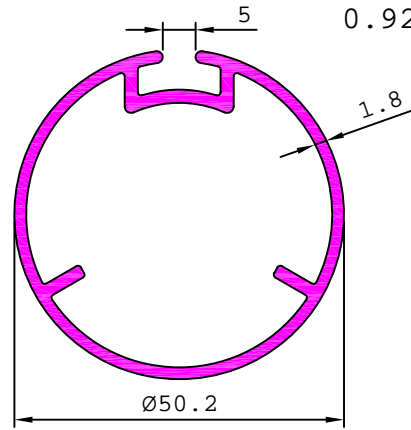

34026

0.370 kg/m

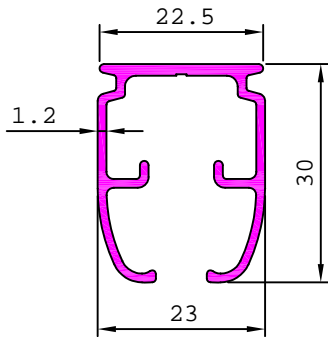

34027

0.429 kg/m

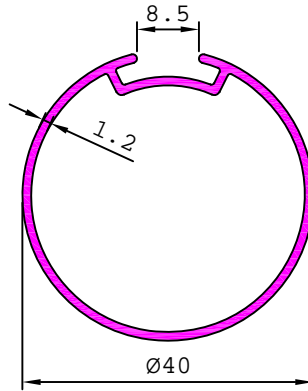

34029

0.527 kg/m

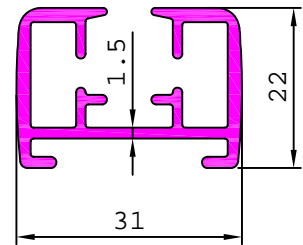

34028

0.570 kg/m

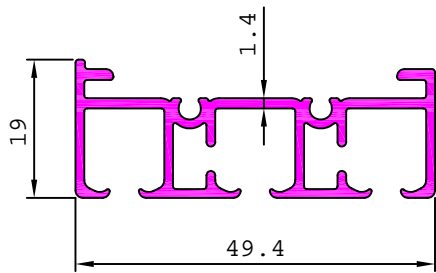

34030

0.671 kg/m

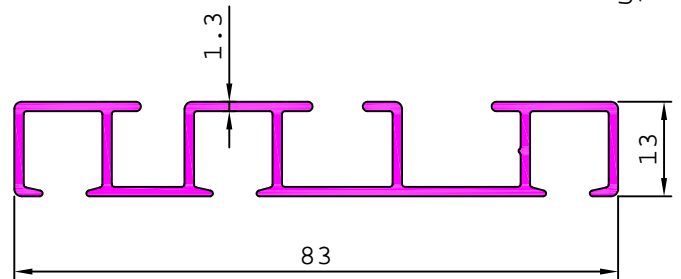

34031

0.130 kg/m

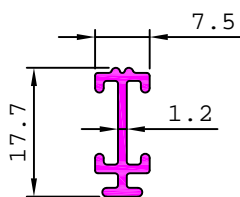

34032

0.126 kg/m

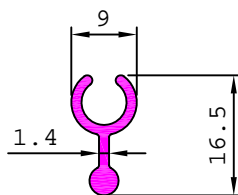

34033

0.355 kg/m

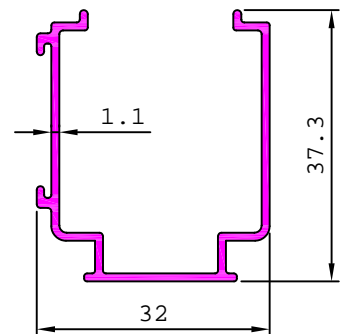

ARCHITECTURAL

VENETIAN BLINDS

34034 0.354 kg/m

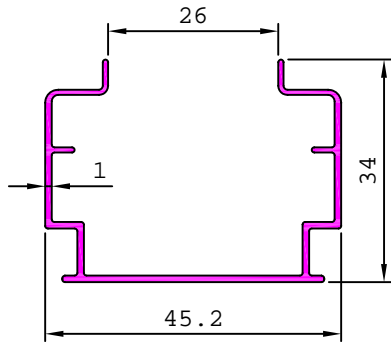

34035 0.375 kg/m

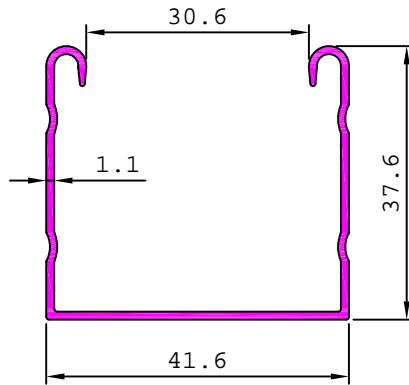

34036 1.092 kg/m

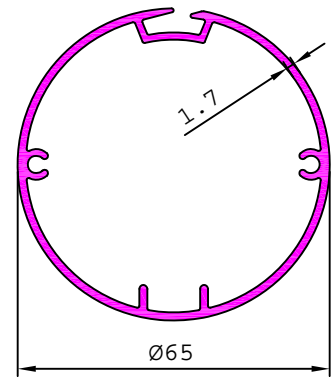

34037 0.248 kg/m

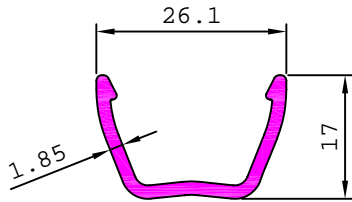

34038 0.329 kg/m

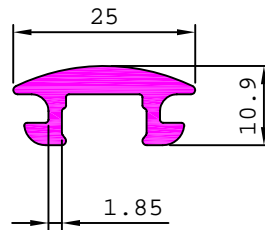

34039 0.469 kg/m

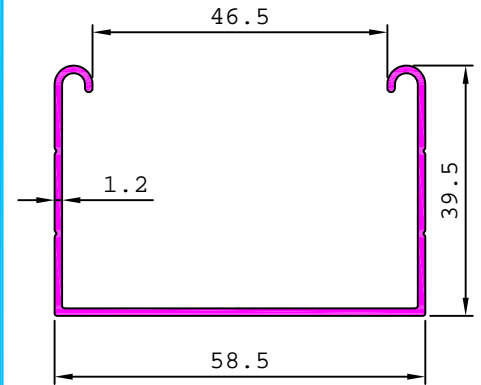

34040 0.112 kg/m

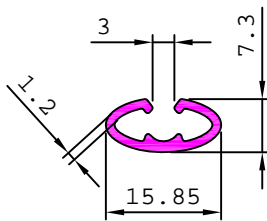

34041 0.146 kg/m

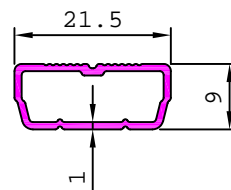

34042 0.170 kg/m

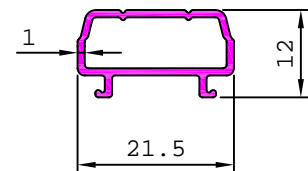

34043 0.167 kg/m

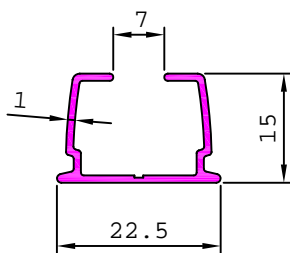

34044 0.586 kg/m

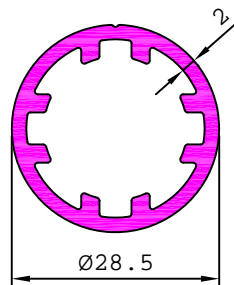

34045 0.184 kg/m

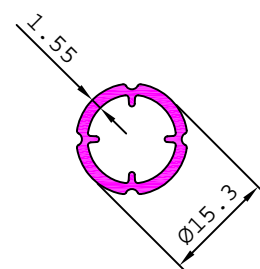

ARCHITECTURAL

VENETIAN BLINDS

34046

0.358 kg/m

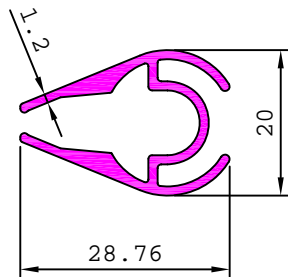

34047

0.236 kg/m

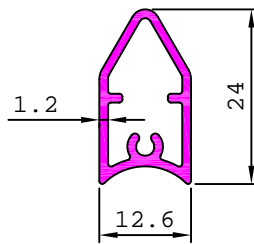

34048

0.234 kg/m

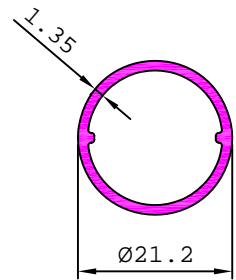

34049

0.739 kg/m

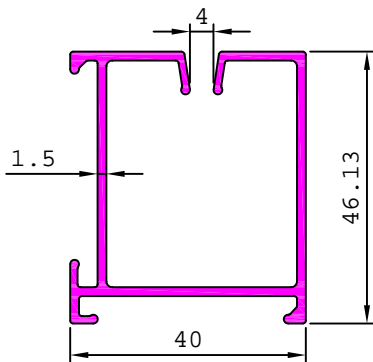

34050

0.512 kg/m

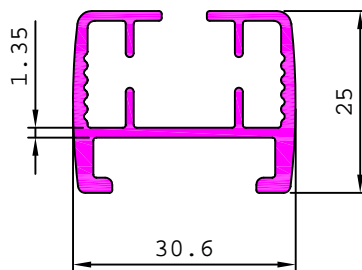

34051

0.359 kg/m

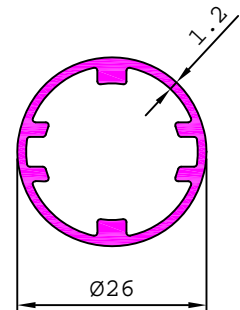

34052

0.277 kg/m

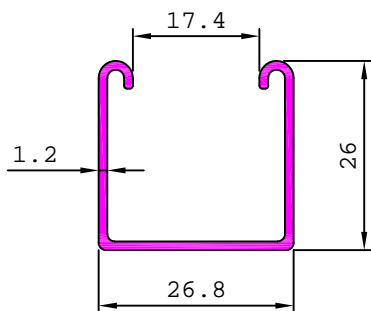

34053

0.531 kg/m

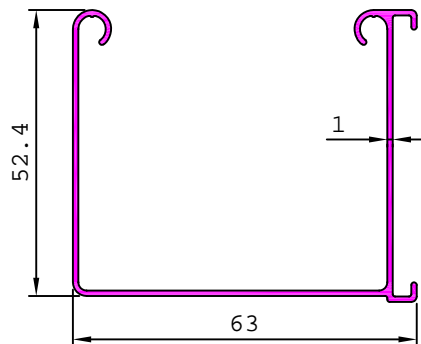

34054

0.356 kg/m

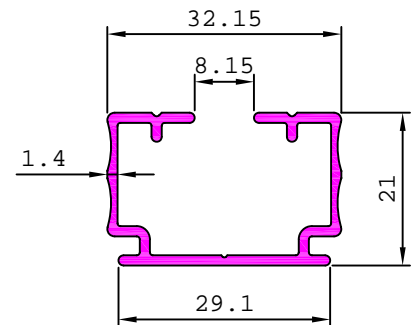

34055

0.273 kg/m

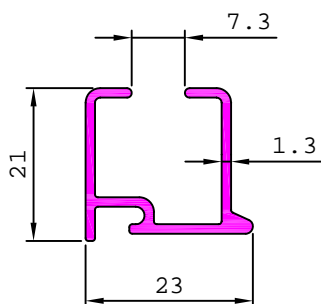

34056

0.208 kg/m

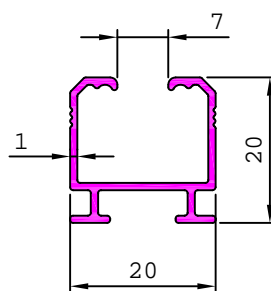

34057

0.462 kg/m

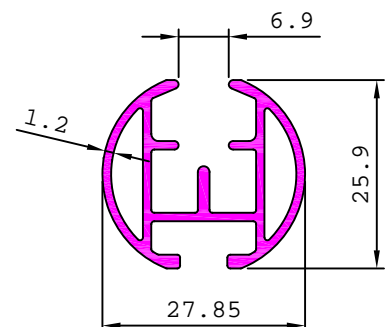

ARCHITECTURAL

VENETIAN BLINDS

<p>34058 0.153 kg/m</p>	<p>34059 0.431 kg/m</p>	<p>34060 0.378 kg/m</p>
<p>34061 0.606 kg/m</p>	<p>34064 0.927 kg/m</p>	<p>34065 0.147 kg/m</p>
<p>34066 0.183 kg/m</p>	<p>34067 0.269 kg/m</p>	<p>34068 0.401 kg/m</p>
<p>34069 0.348 kg/m</p>	<p>34071 0.192 kg/m</p>	<p>34072 0.756 kg/m</p>

ARCHITECTURAL

VENETIAN BLINDS

34070

1.855 kg/m

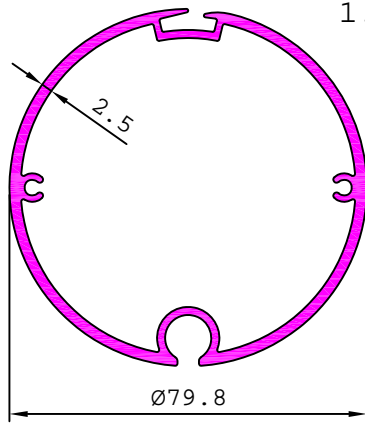

34073

0.290 kg/m

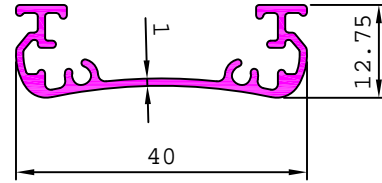

29368

0.434 kg/m

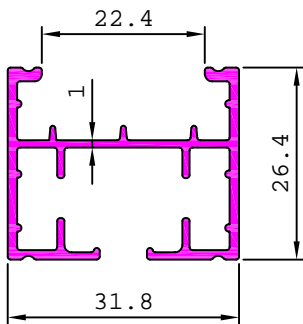

28706

1.114 kg/m

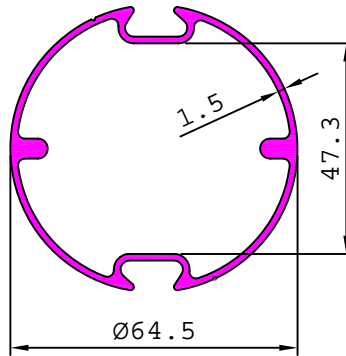

S4220

0.453 kg/m

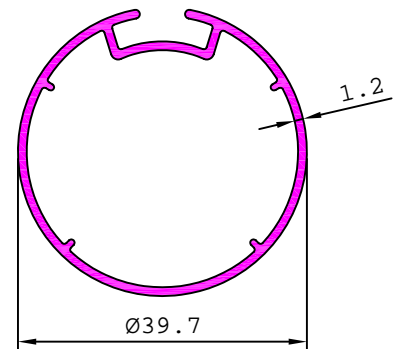

S4390

0.358 kg/m

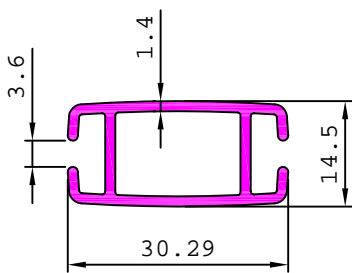

S4391

0.322 kg/m

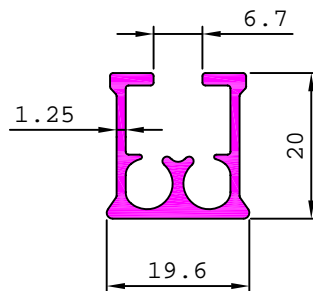

S4419

0.275 kg/m

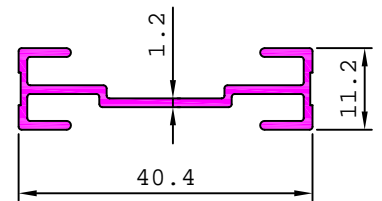

S4420

0.254 kg/m

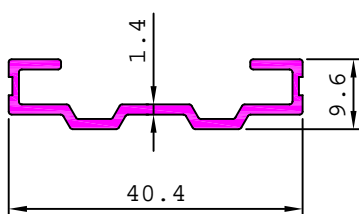

S4450

0.251 kg/m

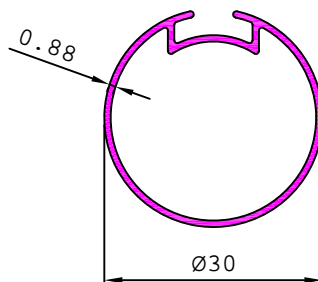

S4497

0.567 kg/m

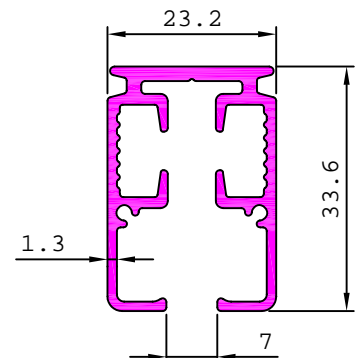

ARCHITECTURAL

VENETIAN BLINDS

S4723 0.355 kg/m

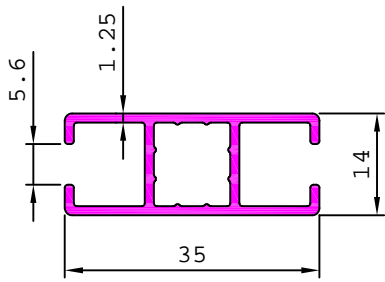

S4732 0.726 kg/m

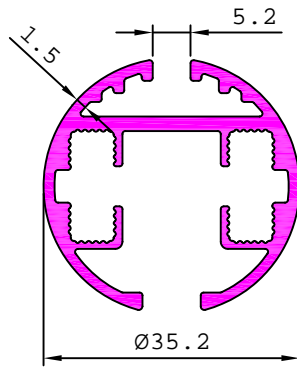

S4786 0.376 kg/m

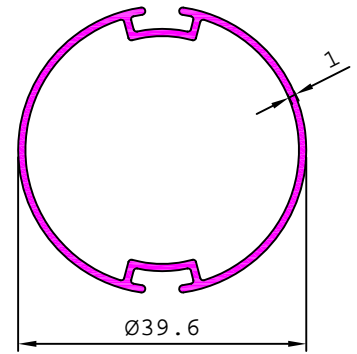

29617 0.380 kg/m

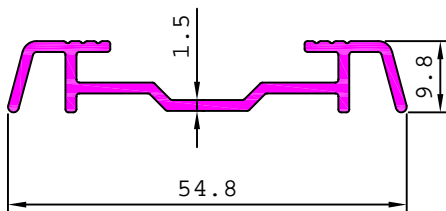

S4843 0.411 kg/m

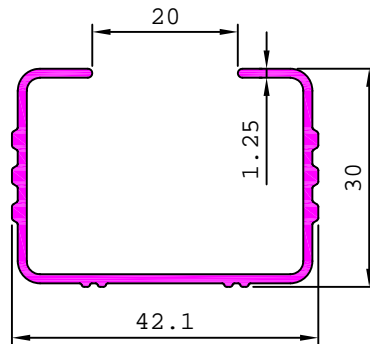

S4890 0.318 kg/m

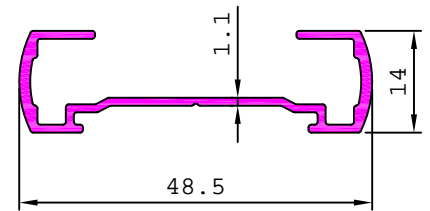

S4891 0.092 kg/m

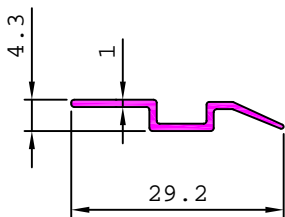

S4913 0.295 kg/m

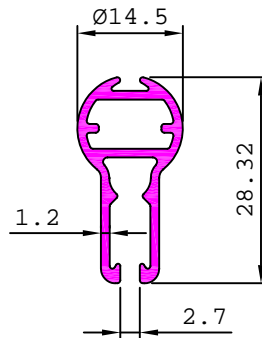

S4916 0.254 kg/m

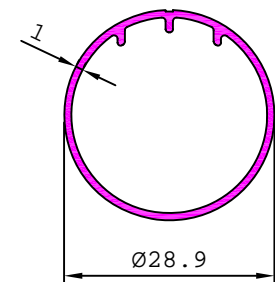

S4917 0.225 kg/m

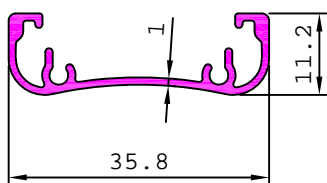

S4937 0.501 kg/m

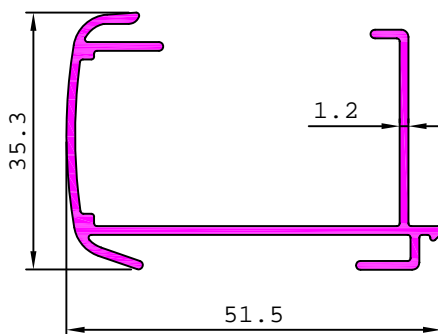

29648 0.750 kg/m

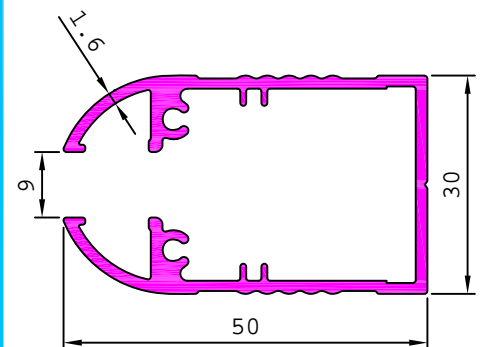

ARCHITECTURAL

VENETIAN BLINDS

S4421

0.304 kg/m

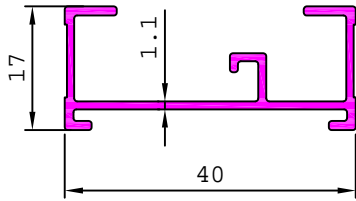

S4832

0.316 kg/m

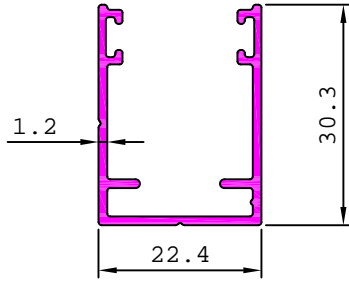

S5075

0.450 kg/m

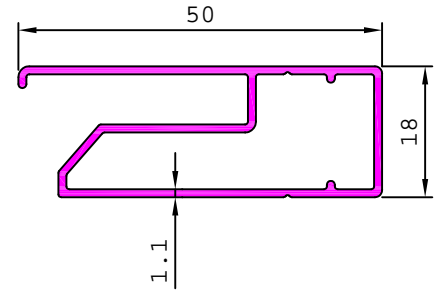

S5190

0.081 kg/m

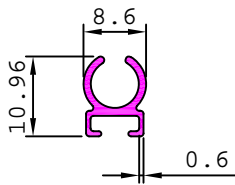

S5216

0.428 kg/m

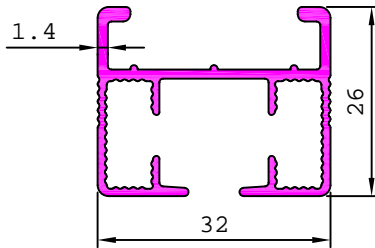

S5231

0.293 kg/m

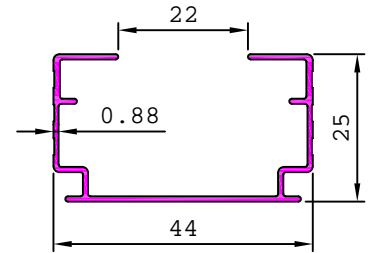

ARCHITECTURAL

KITCHEN CABINET

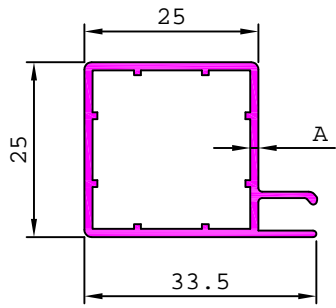

SL. No.	Section No.	A	Weight kg/m
1	22107	0.85	0.273
2	22117	1.10	0.343

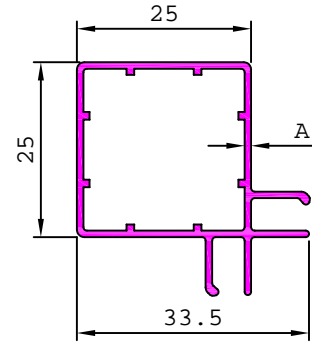

SL. No.	Section No.	A	Weight kg/m
1	22108	0.85	0.314
2	22118	1.10	0.396

22101

0.386 kg/m

22106

0.312 kg/m

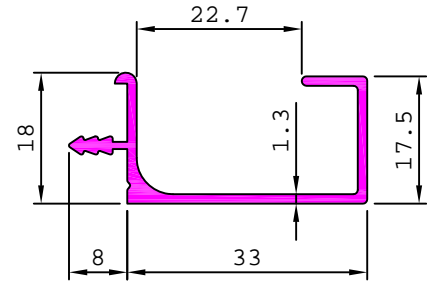
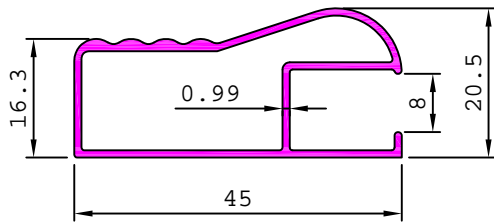

22110

0.545 kg/m

22113

0.484 kg/m

22114

0.423 kg/m

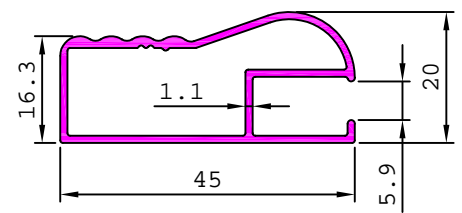
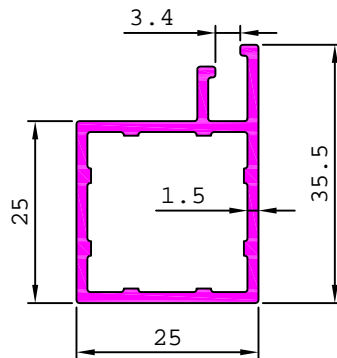
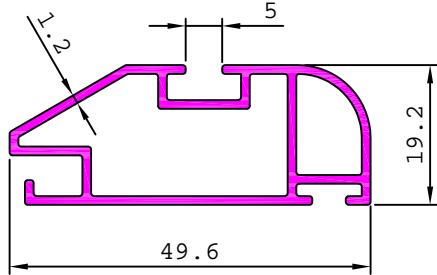

22115

0.666 kg/m

22116

0.457 kg/m

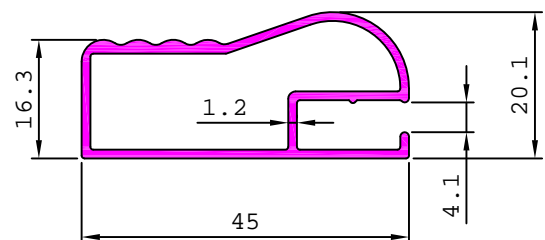
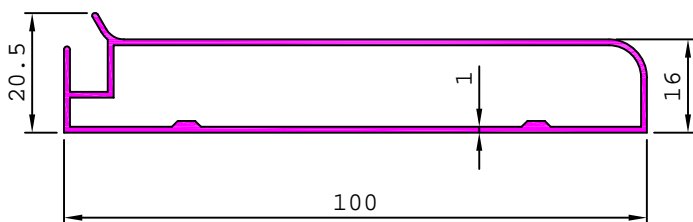

ARCHITECTURAL

KITCHEN CABINET

22109

1.256 kg/m

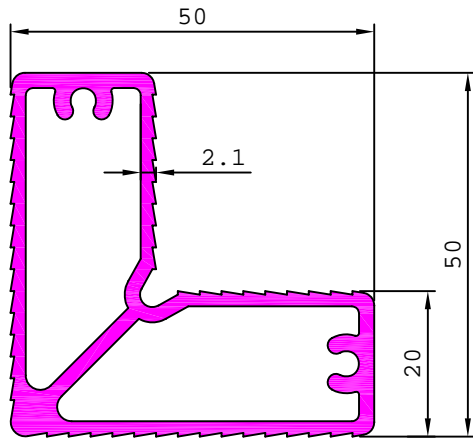

22119

0.594 kg/m

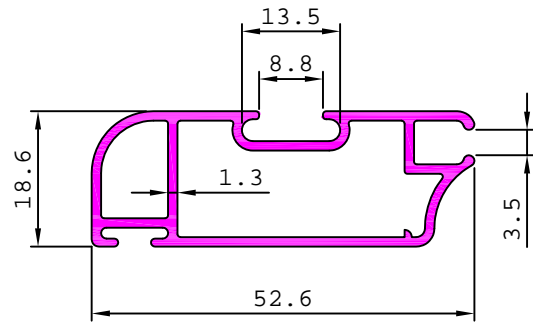

22121

0.389 kg/m

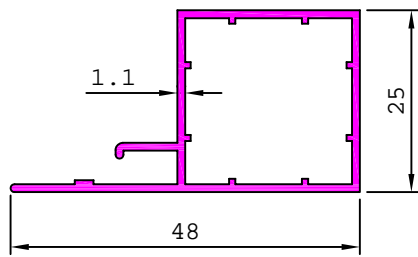

22122

0.111 kg/m

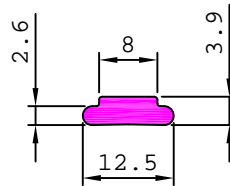

22132

0.540 kg/m

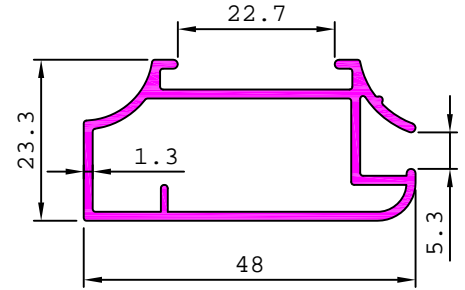

22123

0.581 kg/m

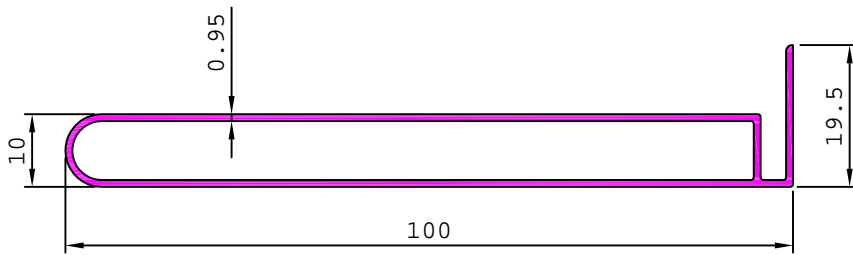

22124

0.521 kg/m

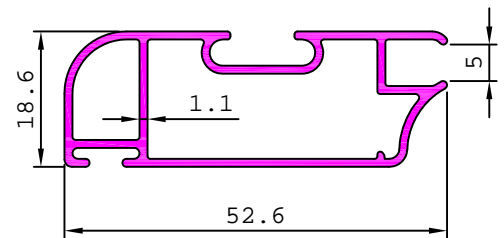

22133

0.620 kg/m

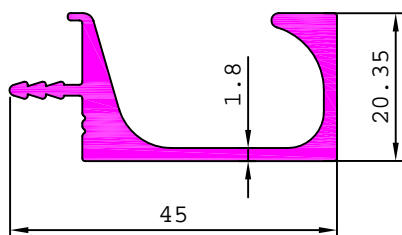

22134

0.723 kg/m

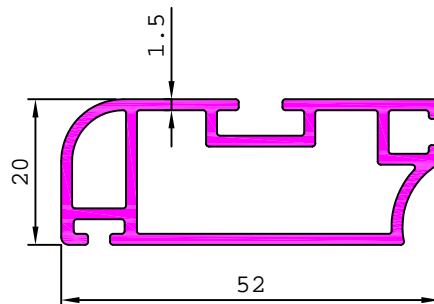

22135

0.290 kg/m

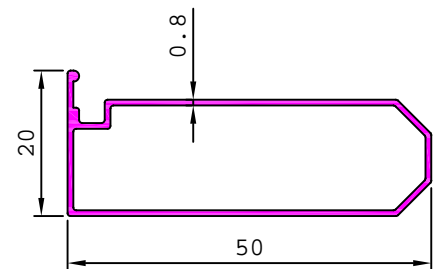

ARCHITECTURAL

KITCHEN CABINET

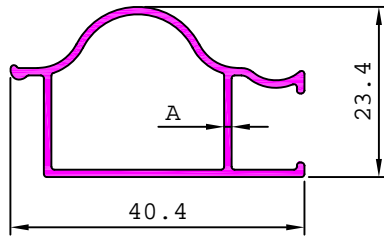

SL. No.	Section No.	A	Weight kg/m
1	15208	0.76	0.239
2	15209	1.03	0.315

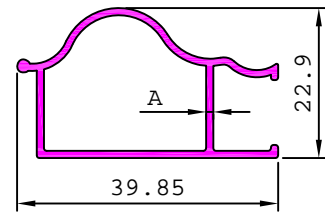

SL. No.	Section No.	A	Weight kg/m
1	15184	0.80	0.247
2	15147	0.95	0.288
3	15132	1.10	0.331

19629

0.388 kg/m

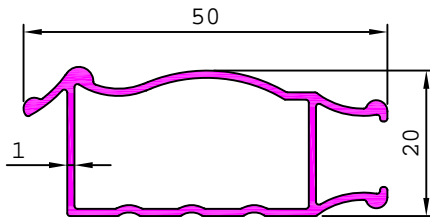

35044

0.225 kg/m

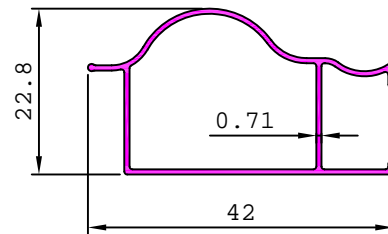

22136

0.194 kg/m

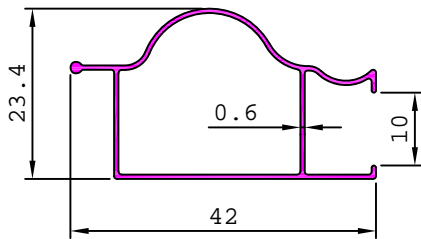

22137

0.224 kg/m

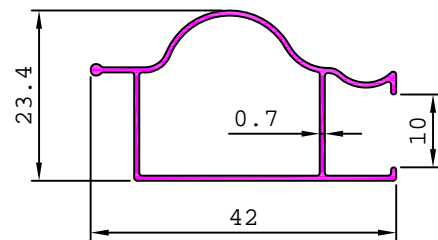

22138

0.268 kg/m

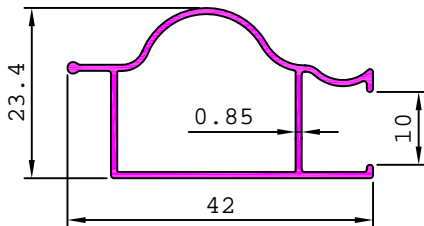

22139

0.303 kg/m

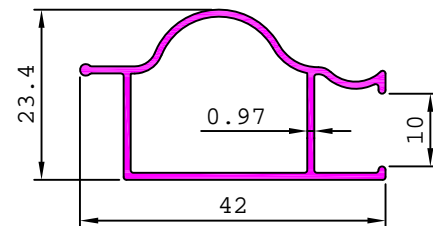

22140

0.277 kg/m

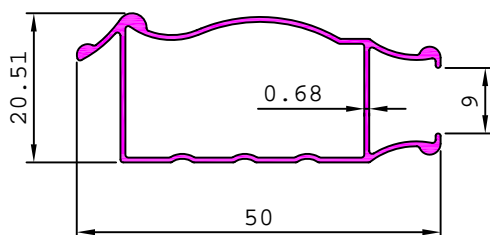

22141

0.284 kg/m

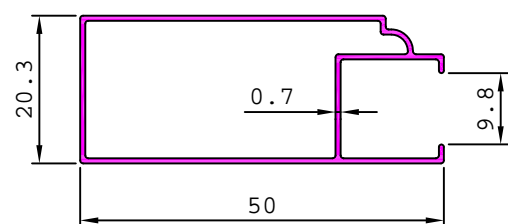

ARCHITECTURAL

KITCHEN CABINET

22142

0.202 kg/m

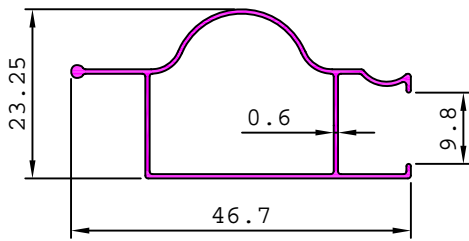

22143

0.358 kg/m

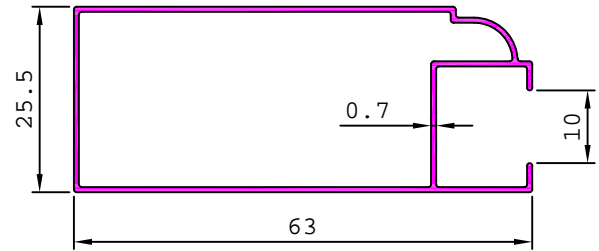

22144

0.296 kg/m

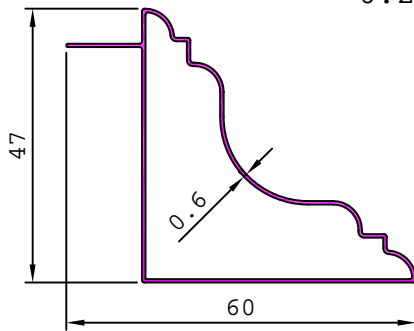

22145

0.256 kg/m

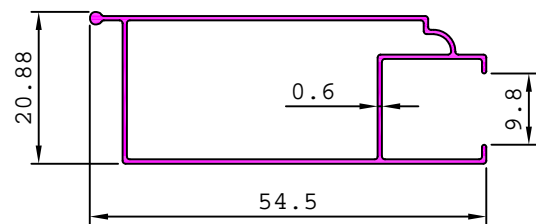

22146

0.274 kg/m

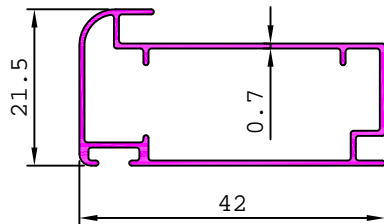

22149

0.288 kg/m

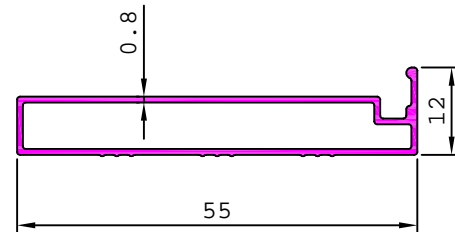

22147

0.159 kg/m

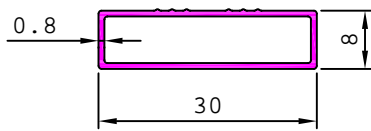

22148

0.228 kg/m

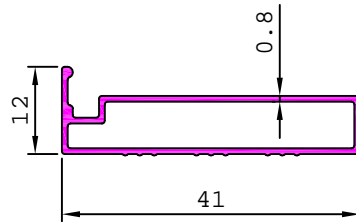

22150

0.093 kg/m

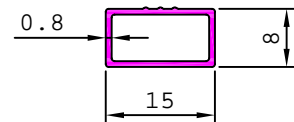

22151

0.340 kg/m

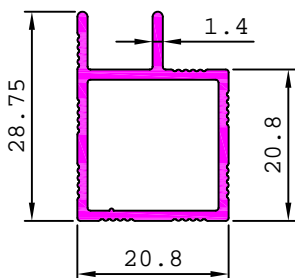

22152

0.413 kg/m

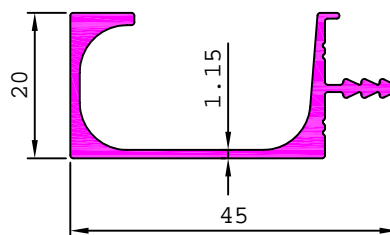

22154

0.343 kg/m

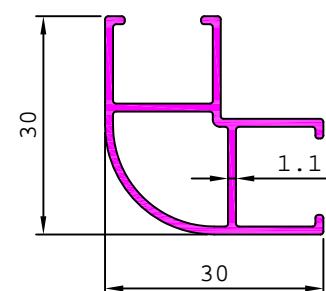

ARCHITECTURAL

KITCHEN CABINET

22153

0.370 kg/m

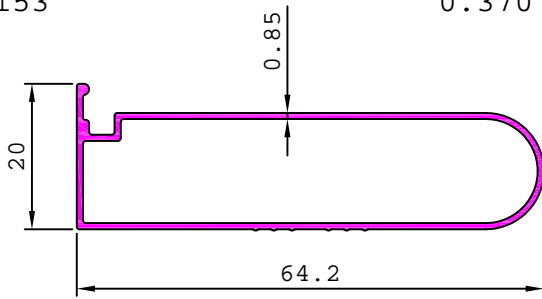

22155

0.711 kg/m

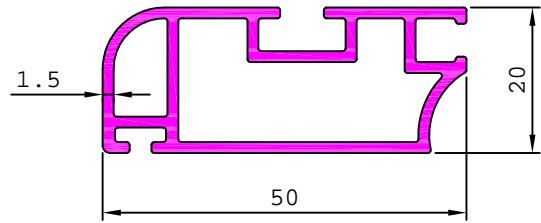

15211

0.250 kg/m

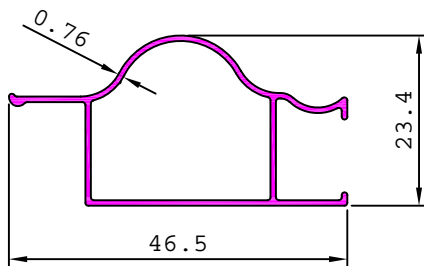

29394

0.491 kg/m

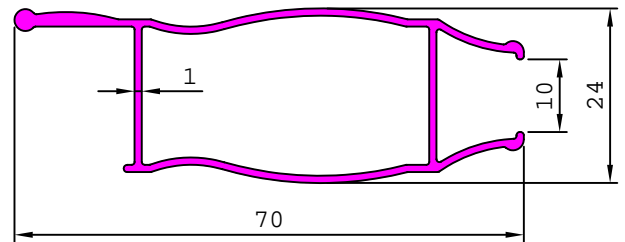

28868

0.301 kg/m

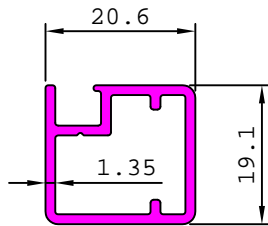

15262

0.330 kg/m

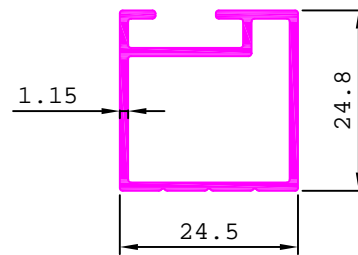

S4948

0.583 kg/m

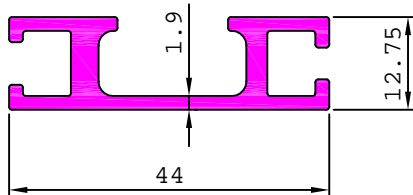

ARCHITECTURAL

MODULAR FURNITURE SECTION

22214

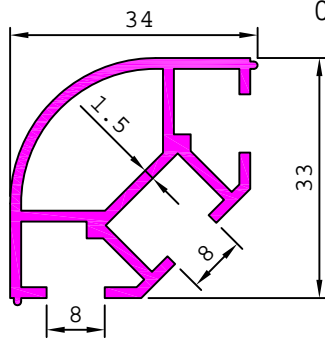

0.594 kg/m

22258

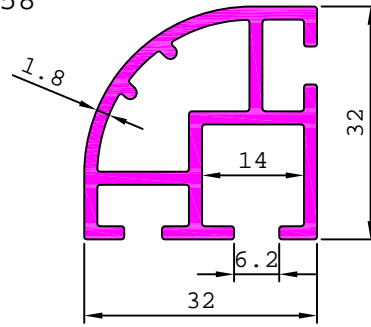

0.746 kg/m

22325

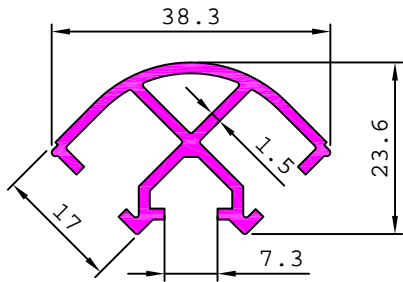

0.460 kg/m

22215

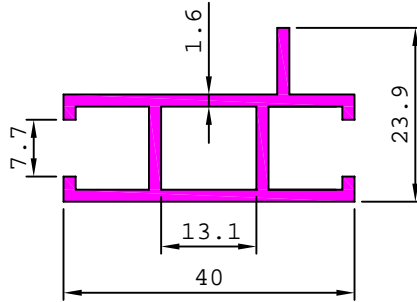

0.517 kg/m

22245

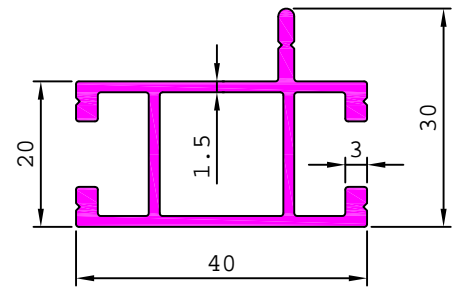

0.645 kg/m

22268

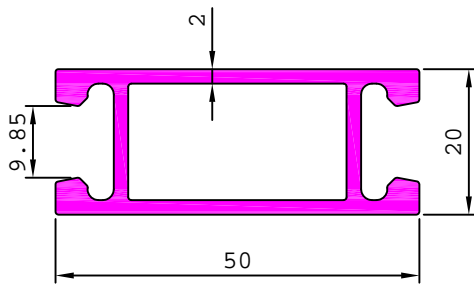

0.852 kg/m

ARCHITECTURAL

MODULAR FURNITURE SECTION

22201

0.091 kg/m

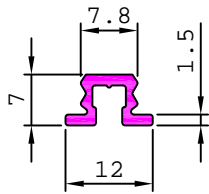

22203

0.350 kg/m

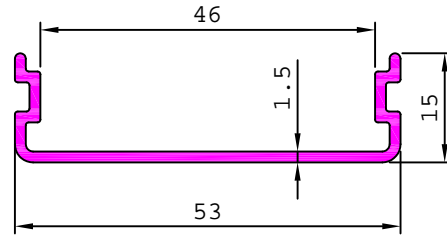

22205

0.290 kg/m

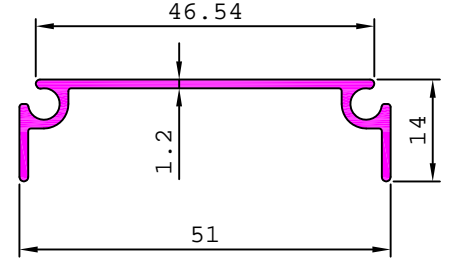

22211

0.785 kg/m

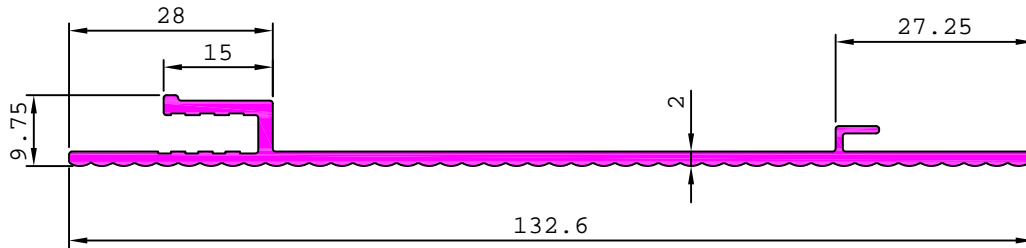

22218

0.462 kg/m

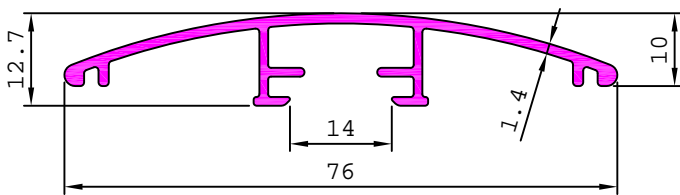

22219

1.428 kg/m

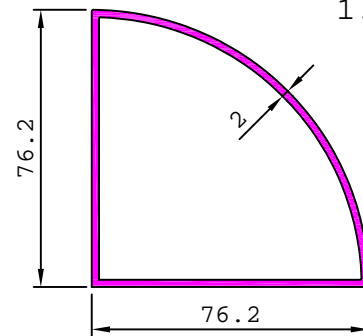

22223

0.375 kg/m

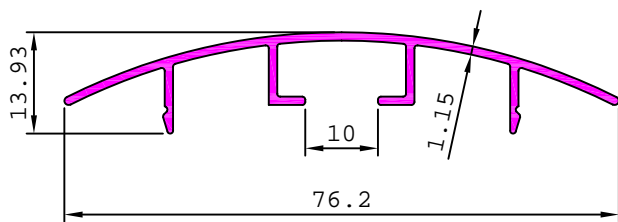

22227

0.569 kg/m

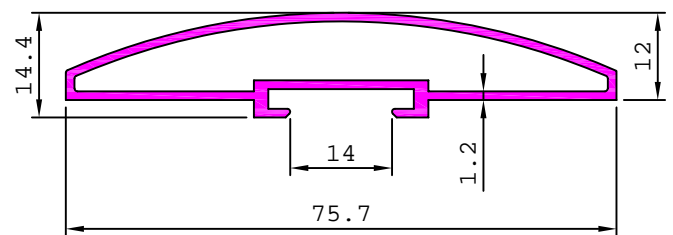

22225

1.553 kg/m

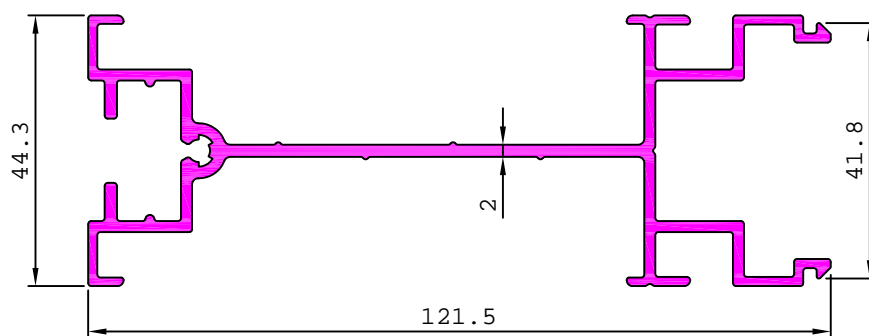

ARCHITECTURAL

MODULAR FURNITURE SECTION

22228

0.567 kg/m

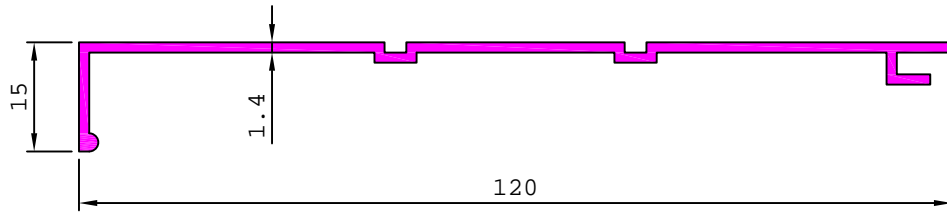

22232

2.060 kg/m

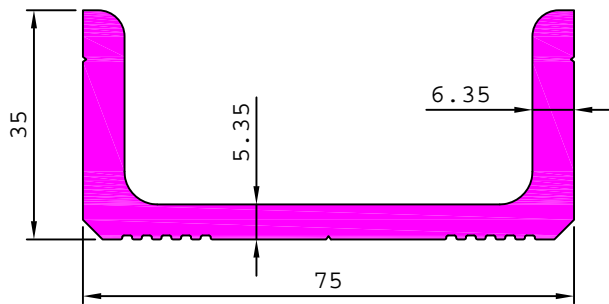

22239

0.595 kg/m

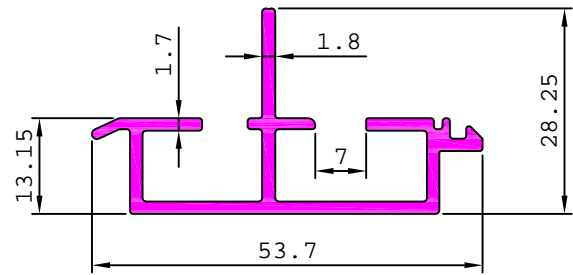

22240

0.480 kg/m

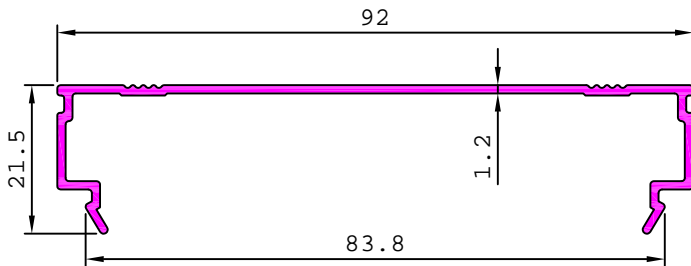

22243

0.727 kg/m

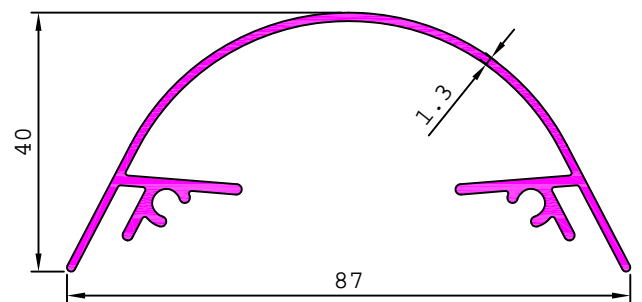

22254

0.432 kg/m

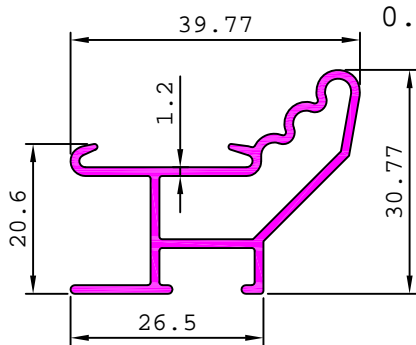

22255

0.327 kg/m

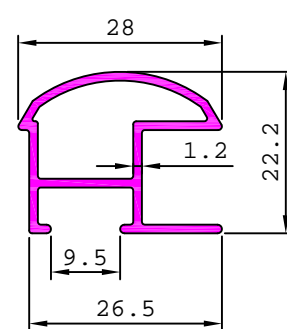

22259

0.502 kg/m

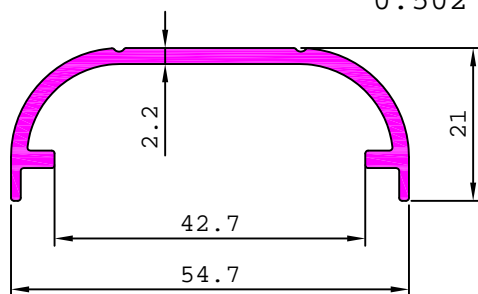

22260

0.885 kg/m

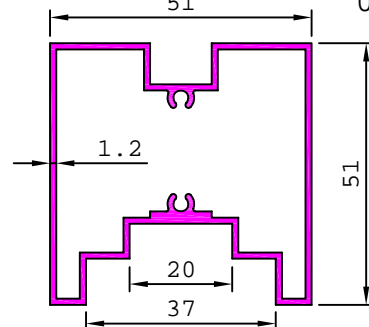

ARCHITECTURAL

MODULAR FURNITURE SECTION

22262

0.637 kg/m

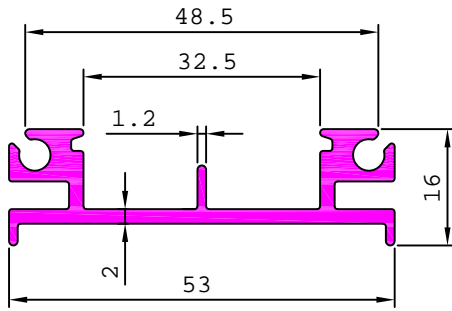

22280

0.482 kg/m

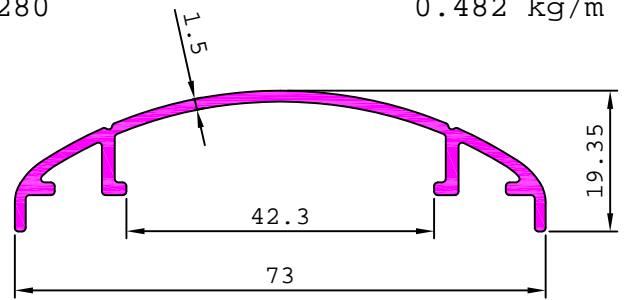

22288

0.588 kg/m

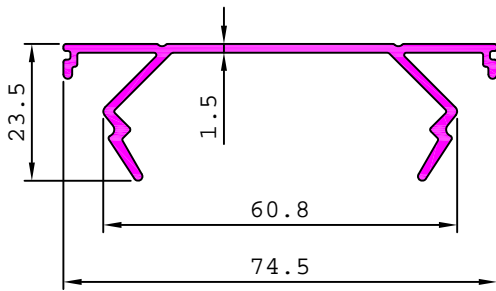

22287

0.827 kg/m

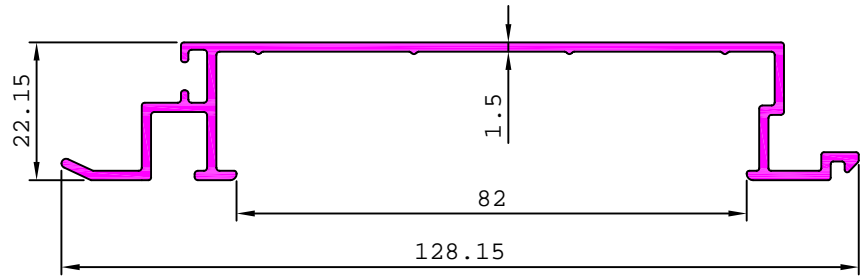

22286

0.266 kg/m

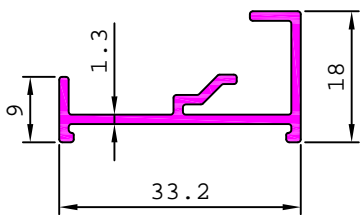

22289

0.196 kg/m

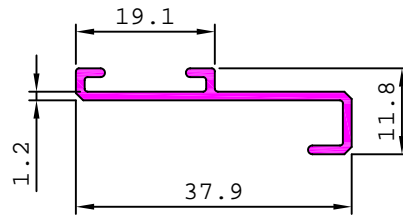

22296

0.171 kg/m

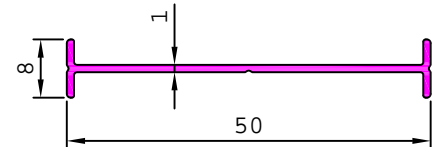

22290

0.564 kg/m

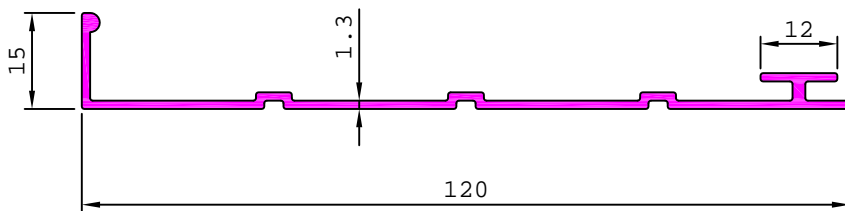

22297

0.300 kg/m

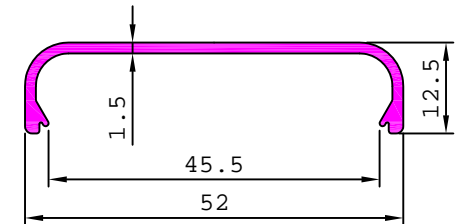

22293

0.273 kg/m

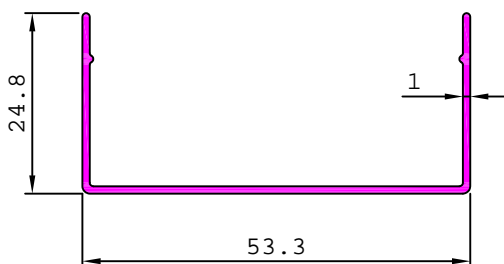

22298

0.356 kg/m

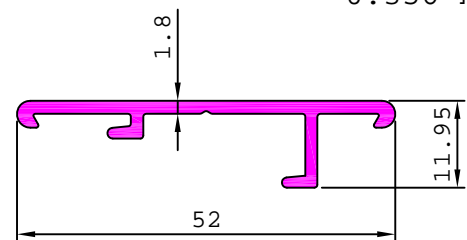

ARCHITECTURAL

MODULAR FURNITURE SECTION

22291 0.863 kg/m

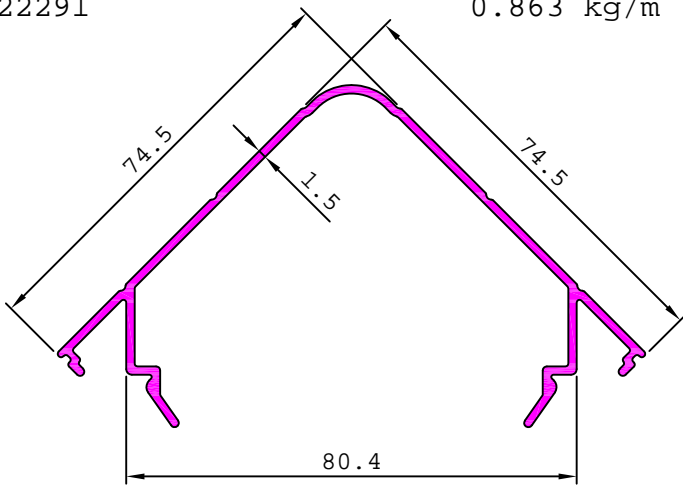

22292 3.194 kg/m

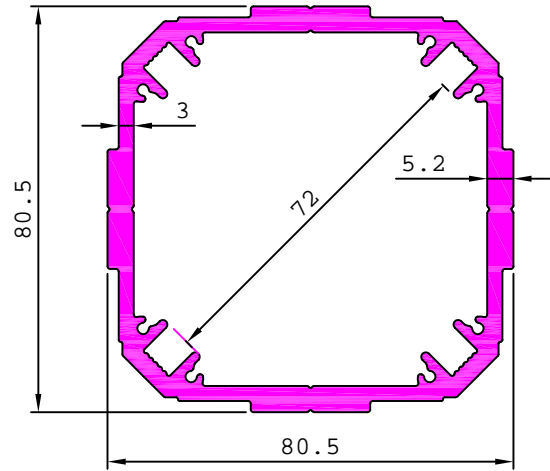

22299 1.500 kg/m

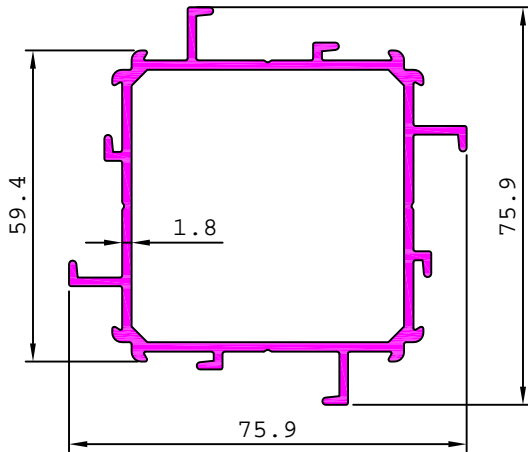

22300 1.160 kg/m

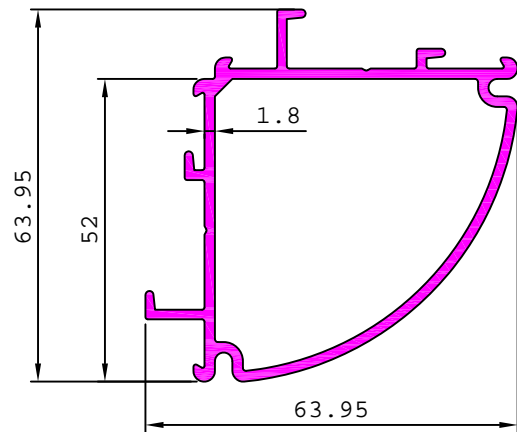

22303 1.395 kg/m

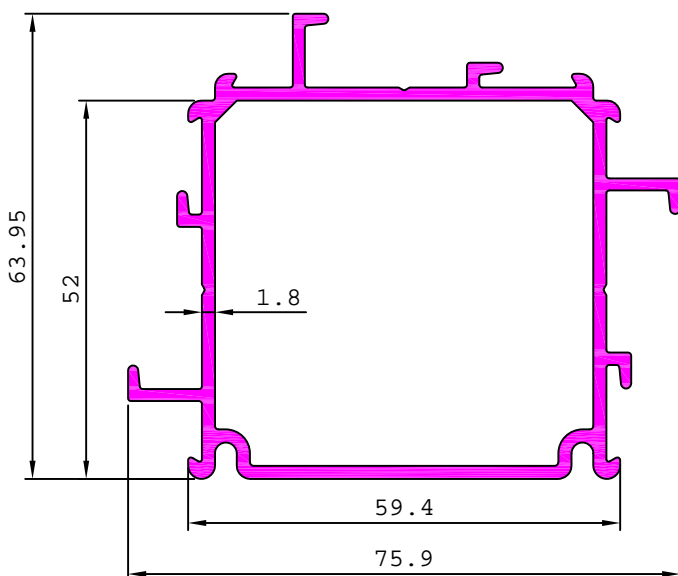

22301 0.500 kg/m

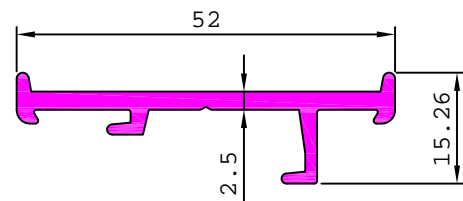

22302 0.530 kg/m

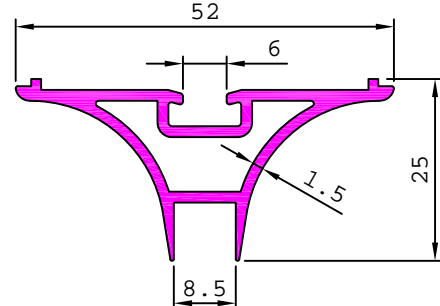

ARCHITECTURAL

MODULAR FURNITURE SECTION

22308 0.137 kg/m

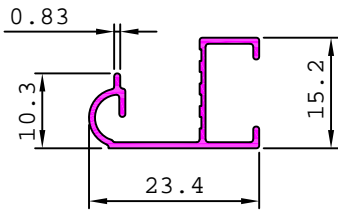

22316 0.125 kg/m

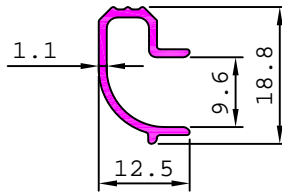

22326 0.260 kg/m

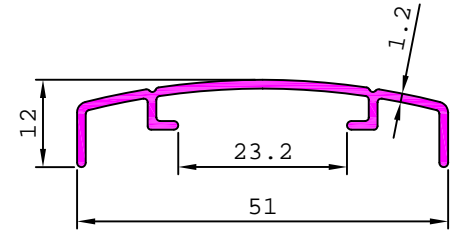

22314

1.660 kg/m

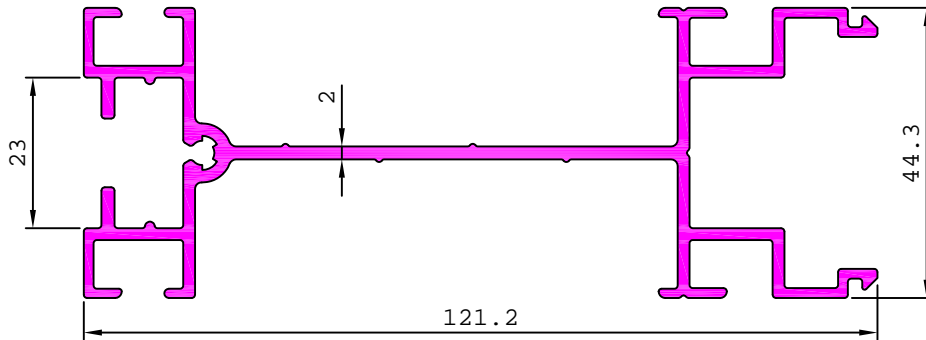

22317 0.631 kg/m

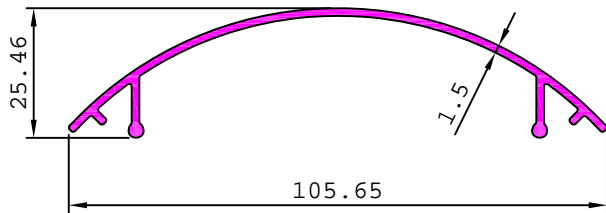

22319 2.005 kg/m

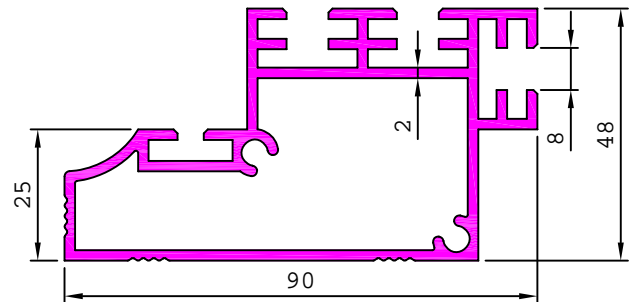

22324 0.892 kg/m

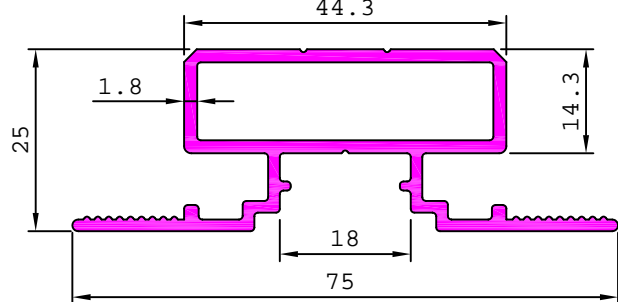

22333 0.502 kg/m

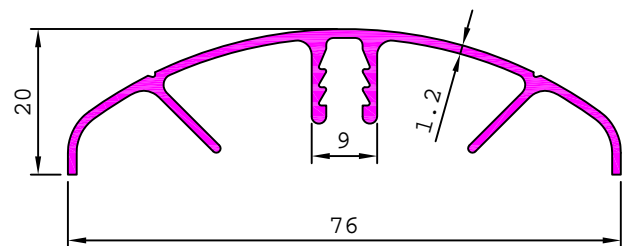

22329 0.404 kg/m

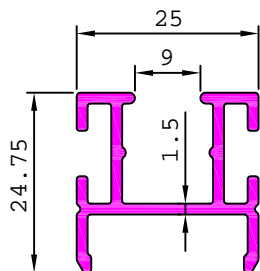

22335 0.151 kg/m

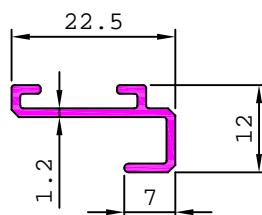

22340 0.234 kg/m

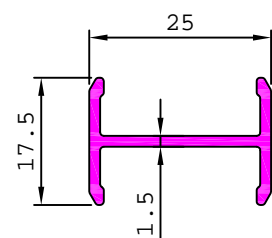

ARCHITECTURAL

MODULAR FURNITURE SECTION

22339 0.444 kg/m

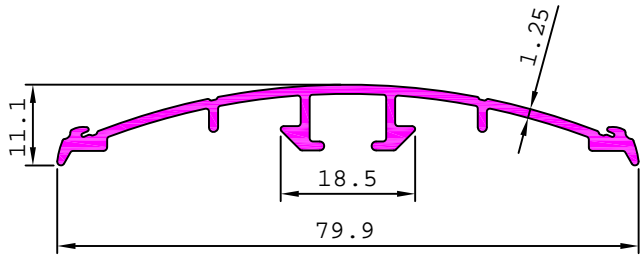

22342 0.984 kg/m

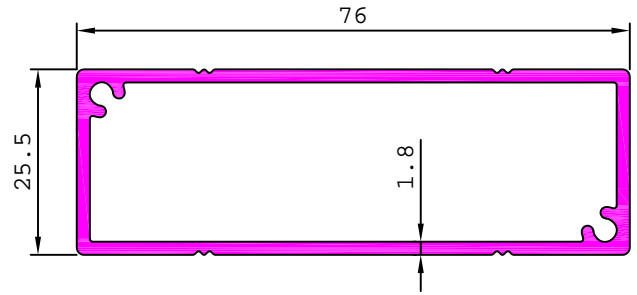

22341 0.400 kg/m

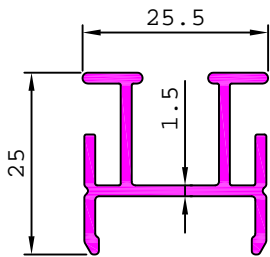

22343 0.238 kg/m

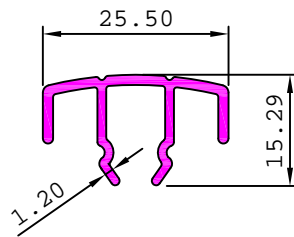

22366 0.269 kg/m

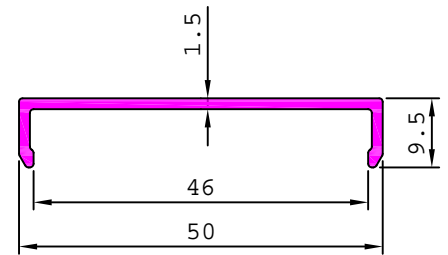

22354 0.942 kg/m

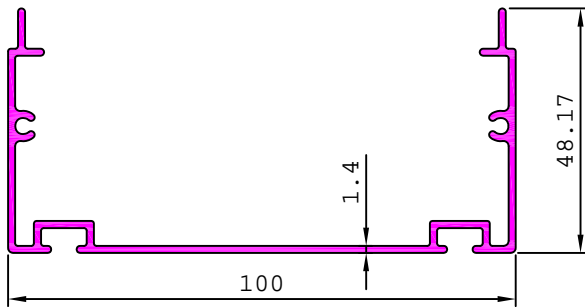

22356 0.552 kg/m

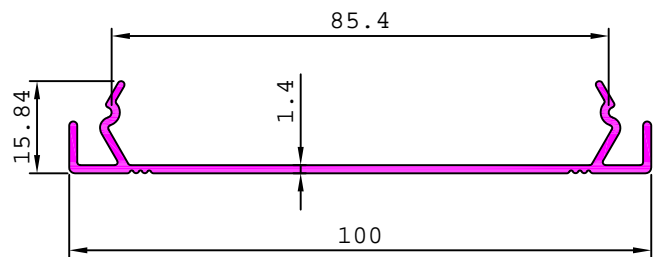

22355 1.851 kg/m

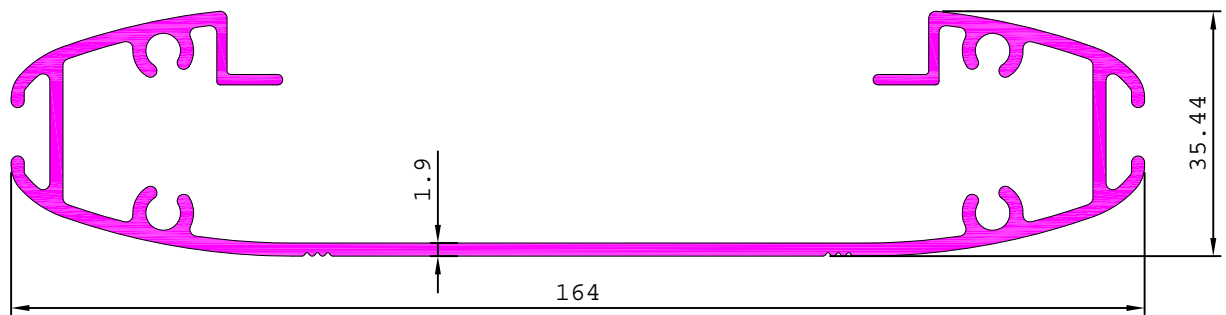

22360 1.673 kg/m

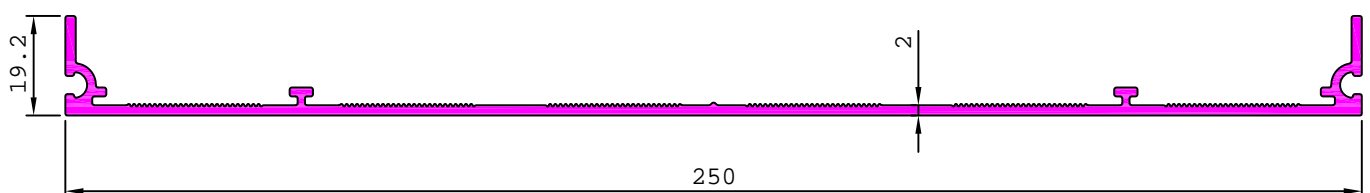

ARCHITECTURAL

MODULAR FURNITURE SECTION

22357

3.043 kg/m

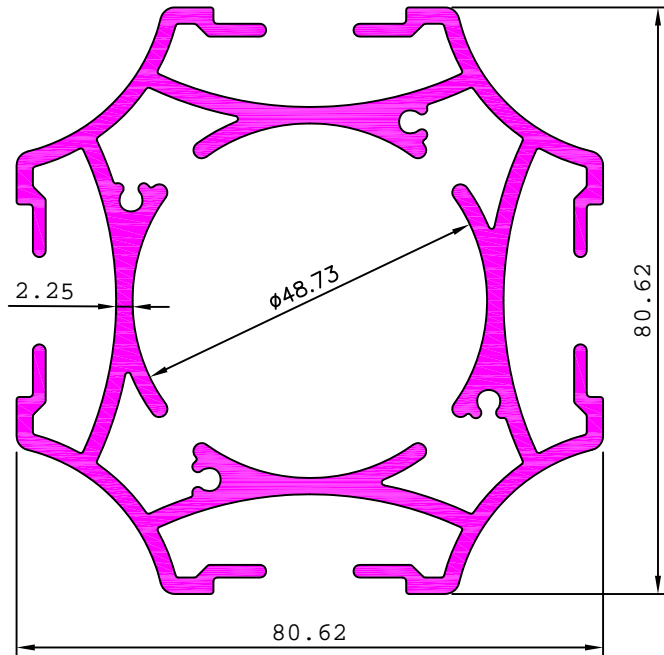

22364

0.386 kg/m

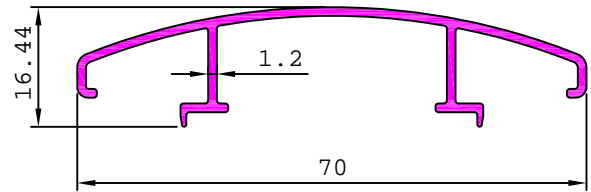

22370

0.501 kg/m

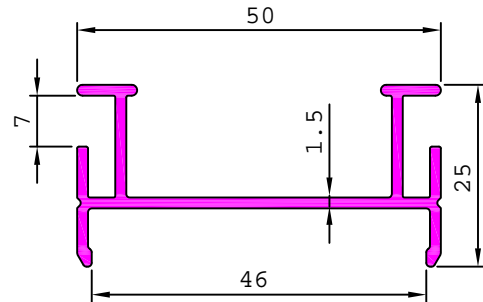

22371

0.302 kg/m

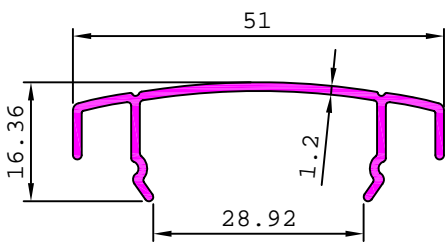

22380

0.347 kg/m

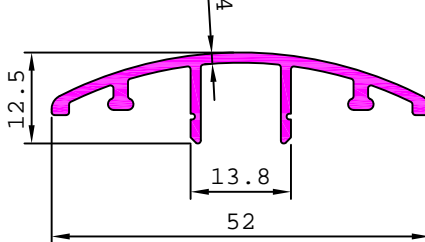

22400

0.189 kg/m

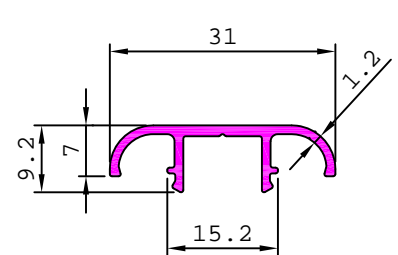

22376

0.617 kg/m

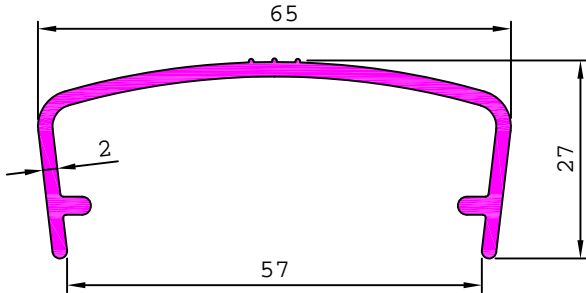

22382

0.615 kg/m

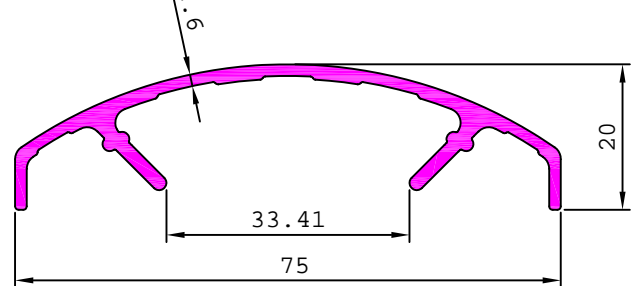

22383

0.512 kg/m

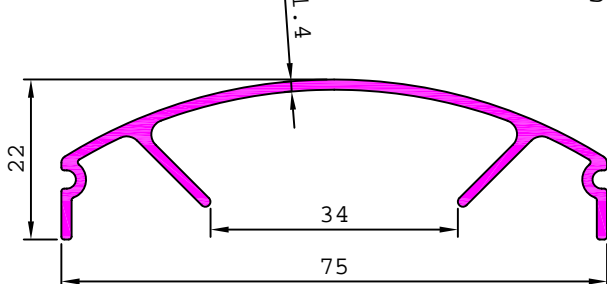

22386

0.584 kg/m

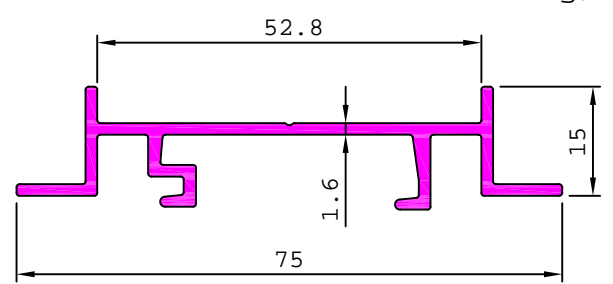

ARCHITECTURAL

MODULAR FURNITURE SECTION

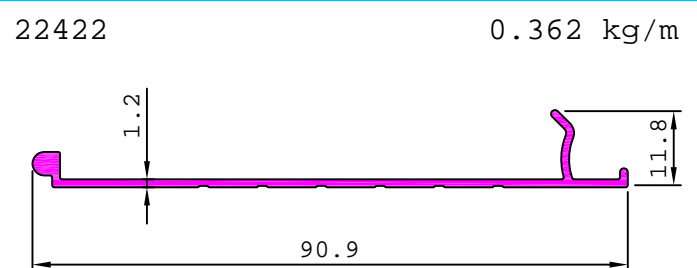
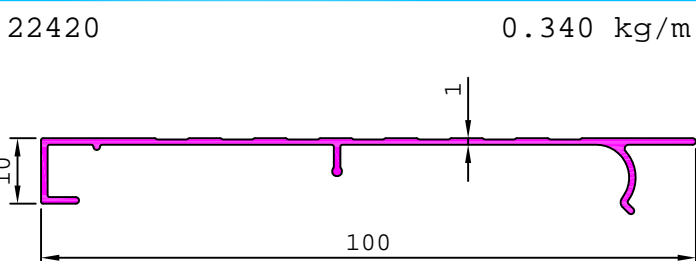
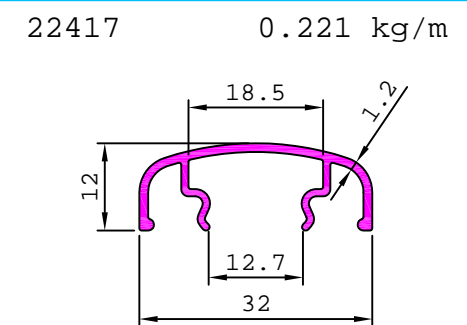
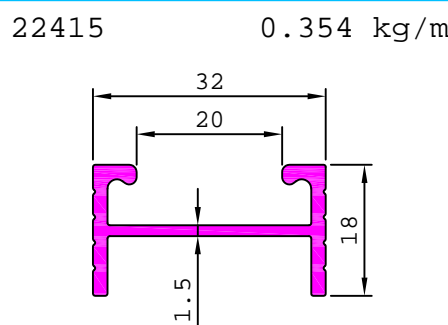
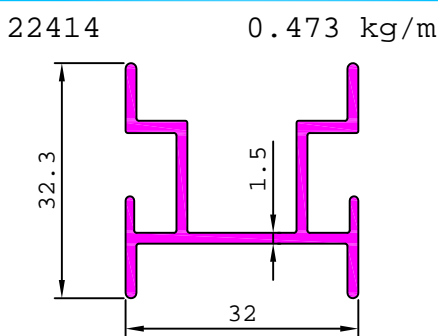
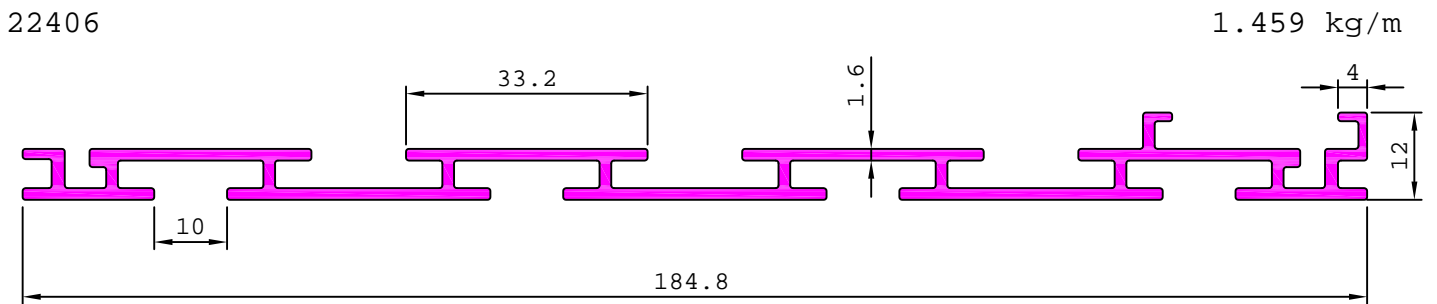
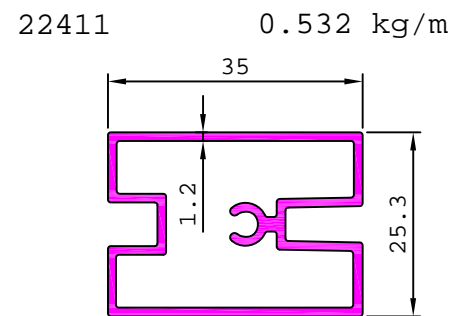
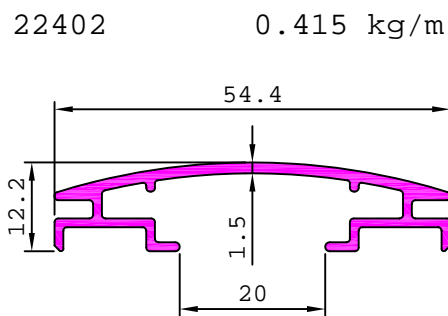
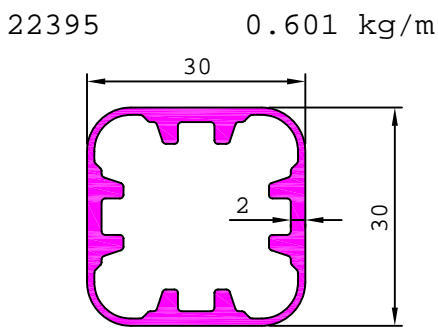
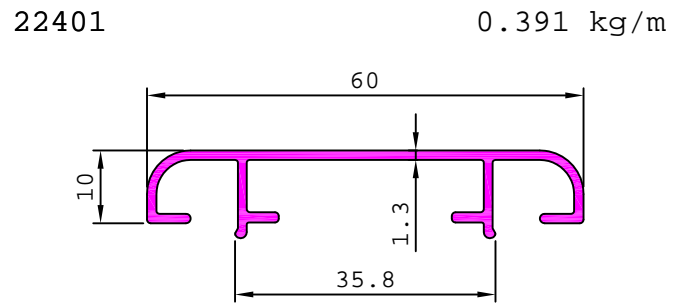
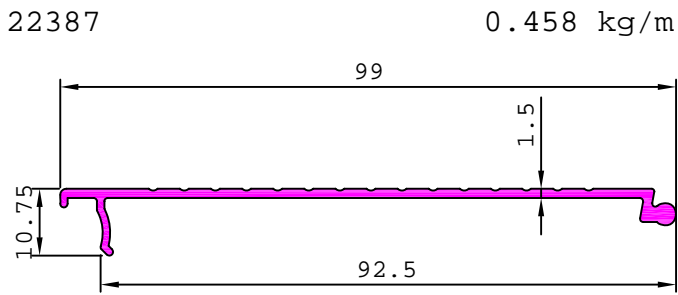

ARCHITECTURAL

MODULAR FURNITURE SECTION

22423 1.024 kg/m

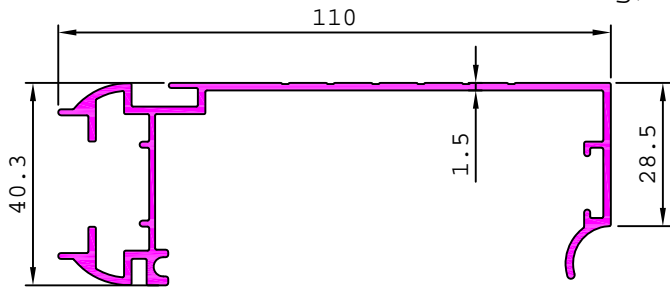

22425 0.244 kg/m

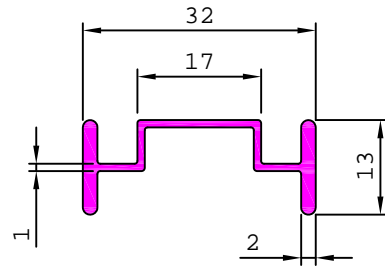

22427 0.409 kg/m

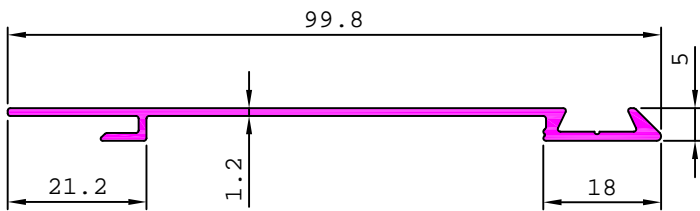

22432 0.494 kg/m

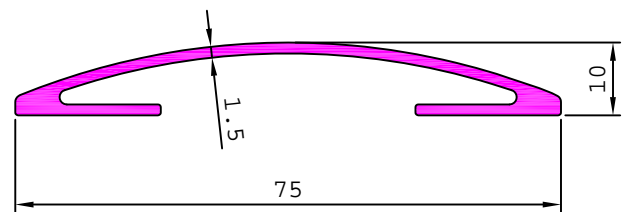

22433 0.447 kg/m

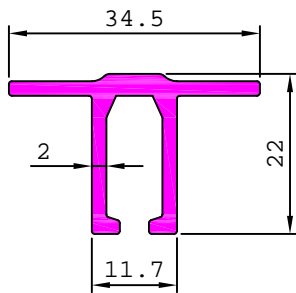

22439 0.299 kg/m

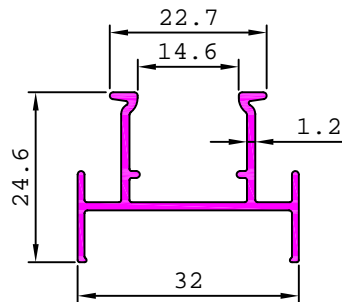

22443 0.377 kg/m

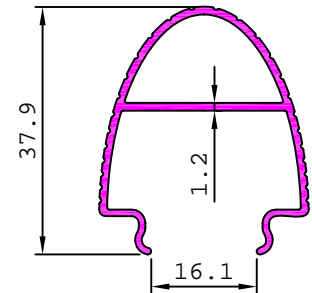

22434 0.480 kg/m

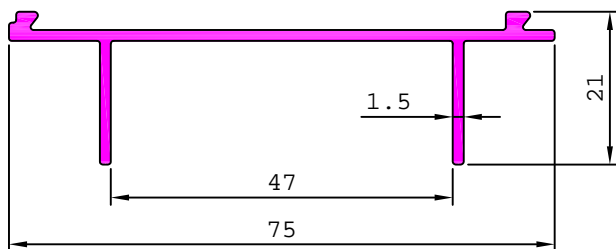

22442 0.488 kg/m

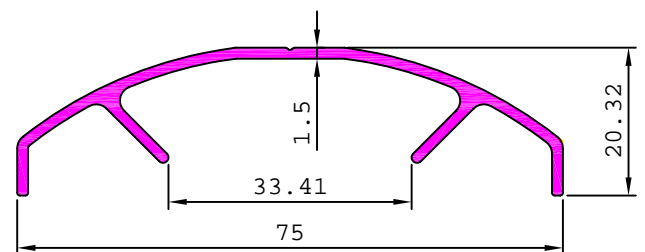

22444 0.733 kg/m

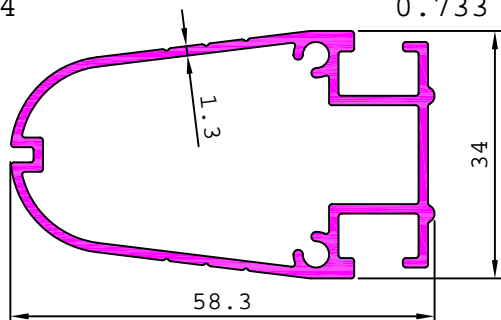

22445 0.461 kg/m

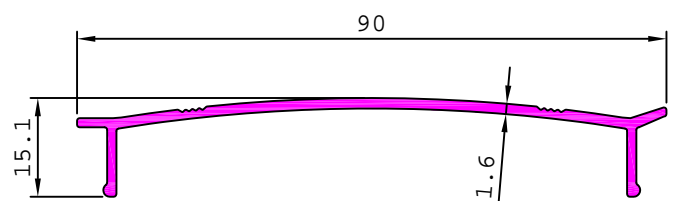

ARCHITECTURAL

MODULAR FURNITURE SECTION

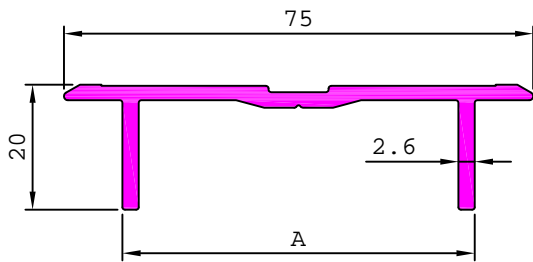

SL. No.	Section No.	A	Weight kg/m
1	22465	56.30	0.731
2	22466	50.70	0.731

22455 0.455 kg/m

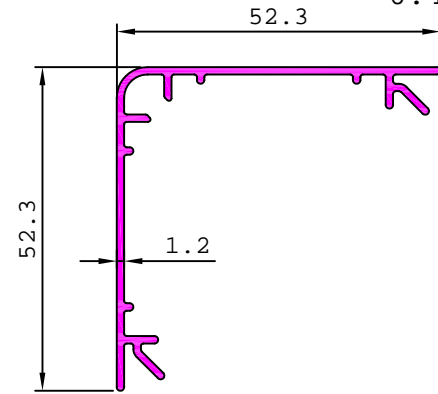

22453 0.230 kg/m

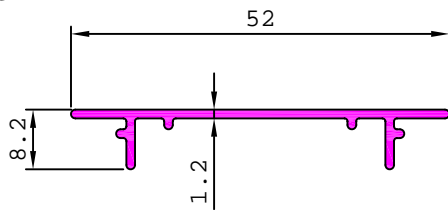

22457 0.424 kg/m

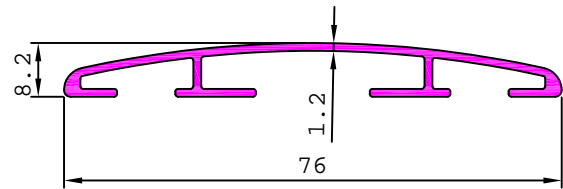

22459 0.327 kg/m

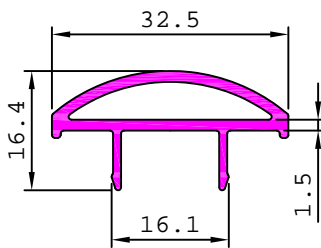

22460 0.323 kg/m

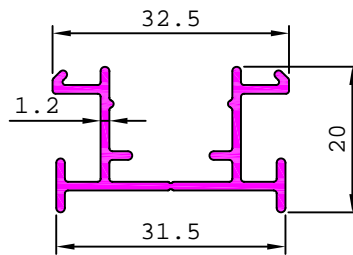

22461 0.269 kg/m

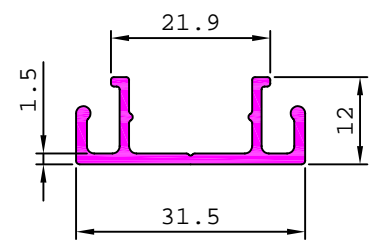

22462 0.215 kg/m

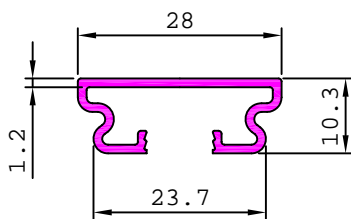

22463 0.352 kg/m

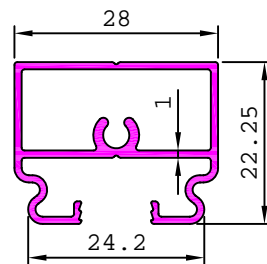

22468 0.994 kg/m

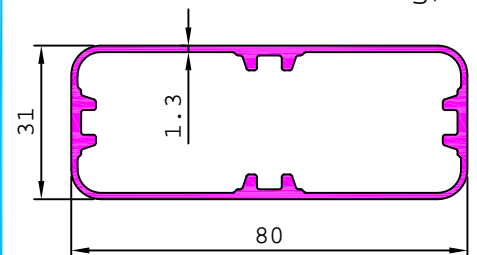

22471 0.949 kg/m

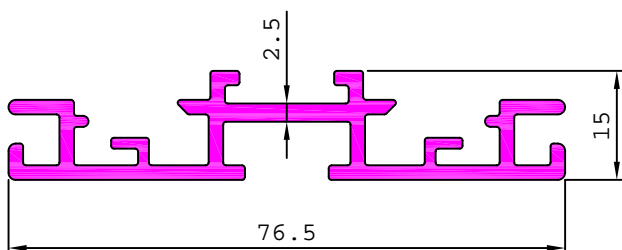

22473 1.718 kg/m

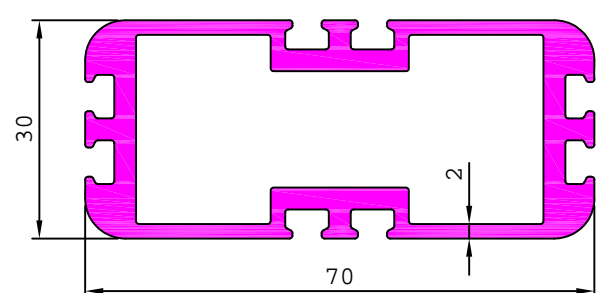

ARCHITECTURAL

MODULAR FURNITURE SECTION

22470 2.620 kg/m

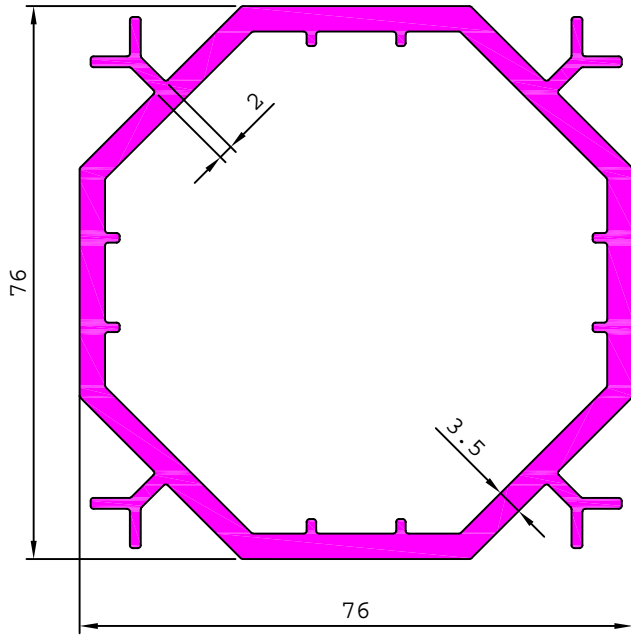

22472 0.273 kg/m

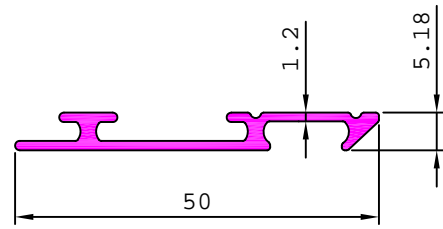

22476 0.449 kg/m

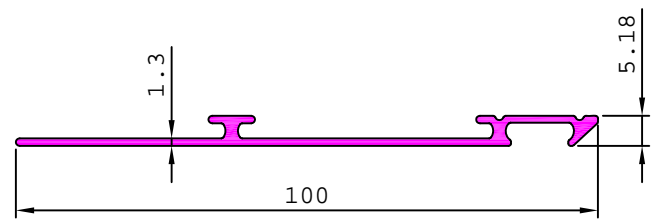

22474 0.140 kg/m

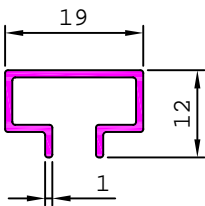

22478 0.521 kg/m

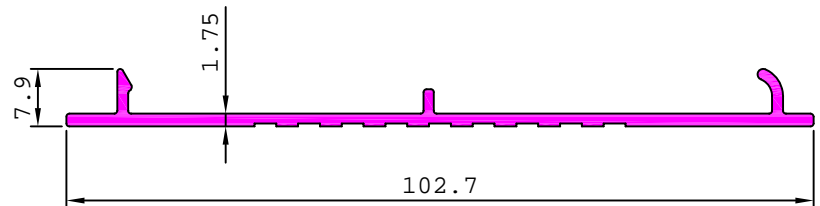

22477 0.361 kg/m

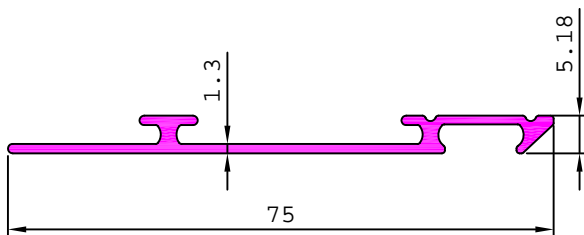

22479 1.862 kg/m

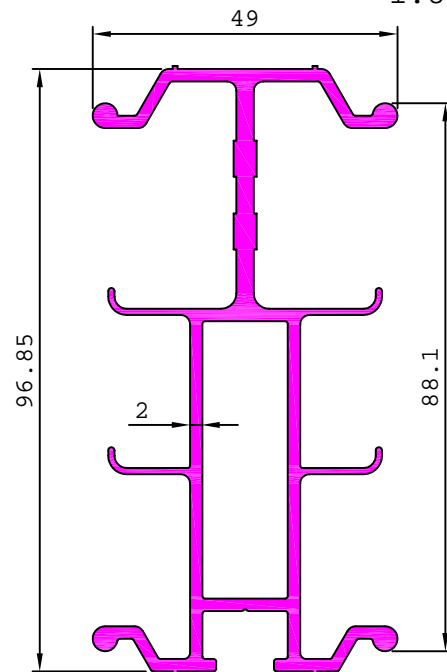

22481 0.301 kg/m

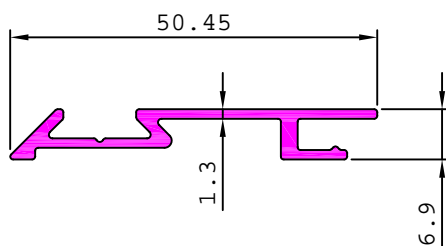

ARCHITECTURAL

MODULAR FURNITURE SECTION

22482 0.331 kg/m

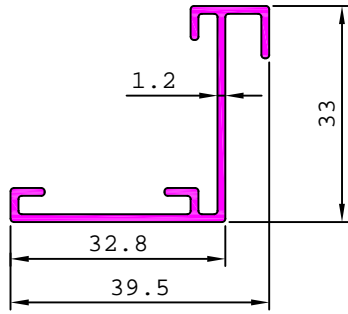

22483 0.513 kg/m

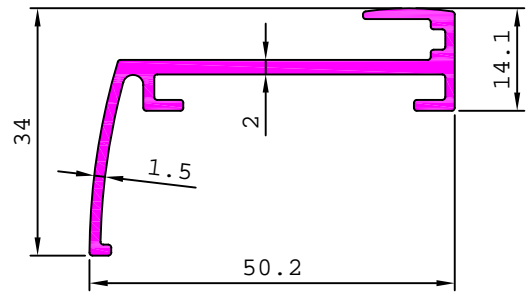

22484 0.489 kg/m

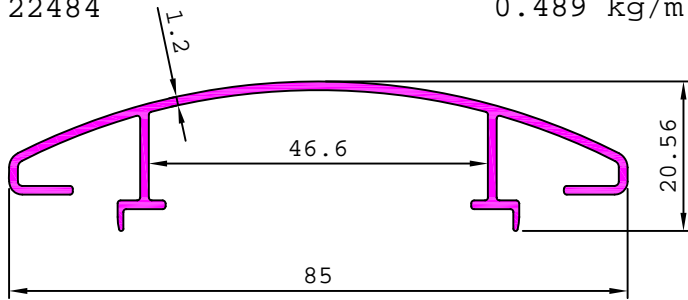

22485 0.369 kg/m

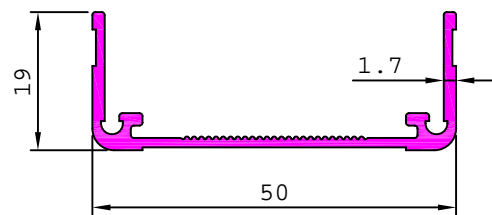

22486 0.600 kg/m

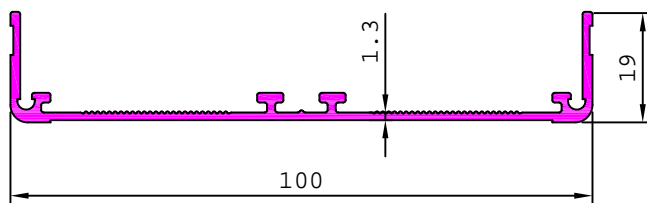

22487 0.350 kg/m

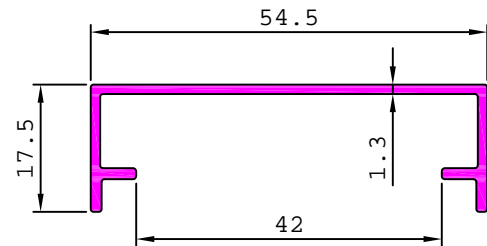

22488 0.452 kg/m

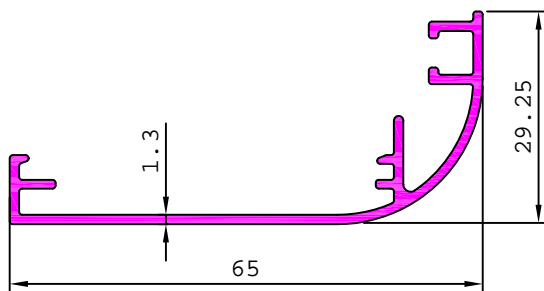

22489 2.711 kg/m

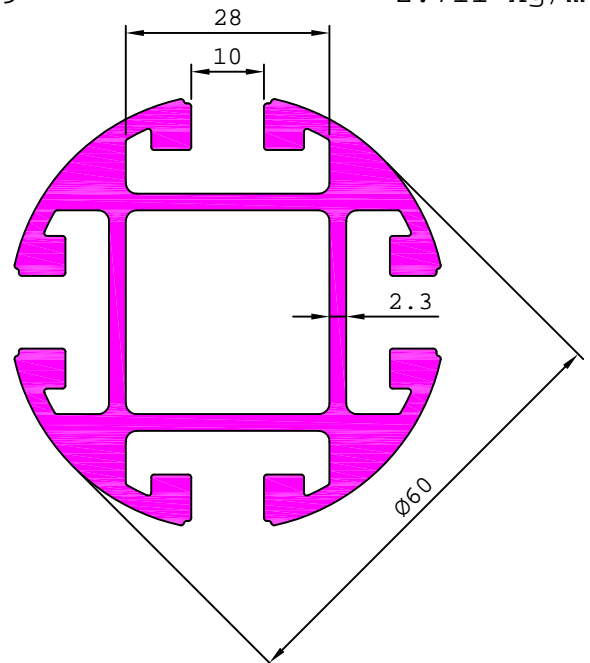

22492 0.970 kg/m

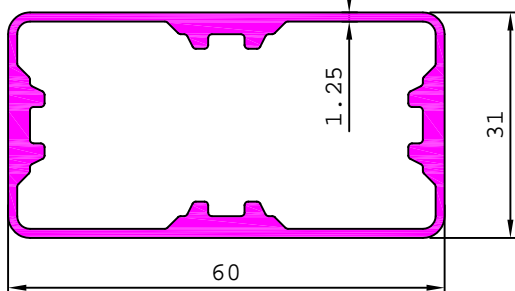

ARCHITECTURAL

MODULAR FURNITURE SECTION

22490

0.035 kg/m

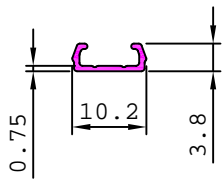

22493

0.792 kg/m

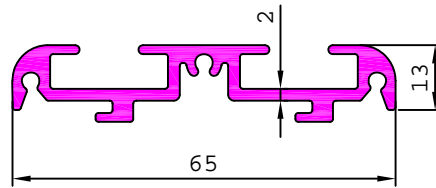

22494

0.294 kg/m

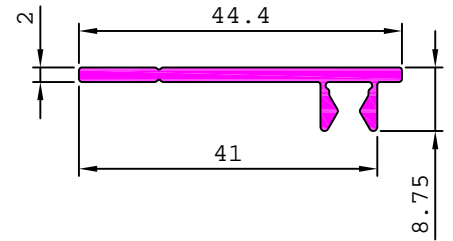

22495

0.477 kg/m

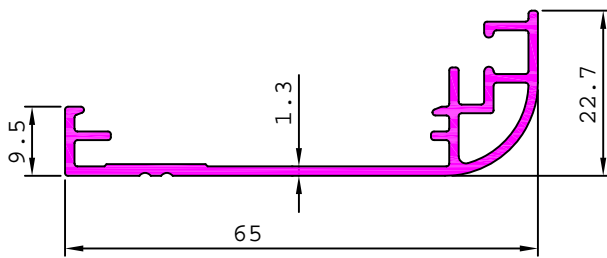

22499

0.556 kg/m

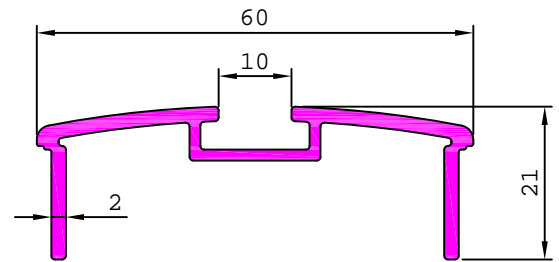

22496

0.998 kg/m

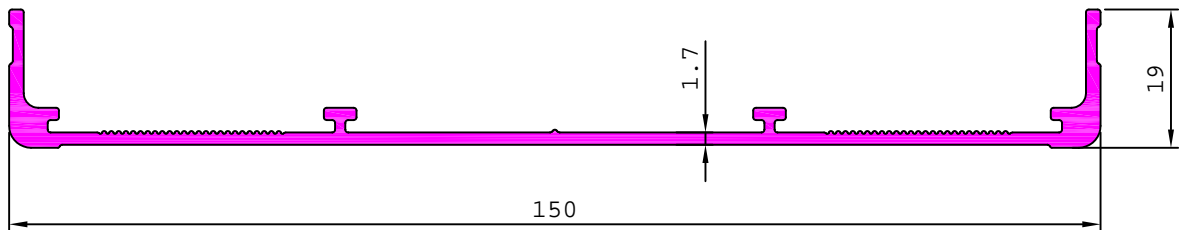

22500

0.433 kg/m

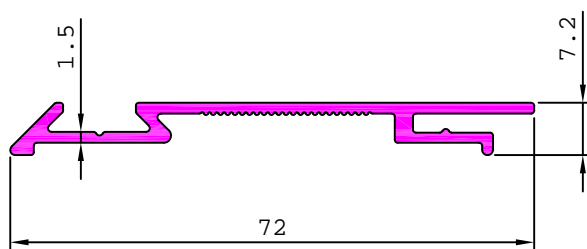

34502

0.401 kg/m

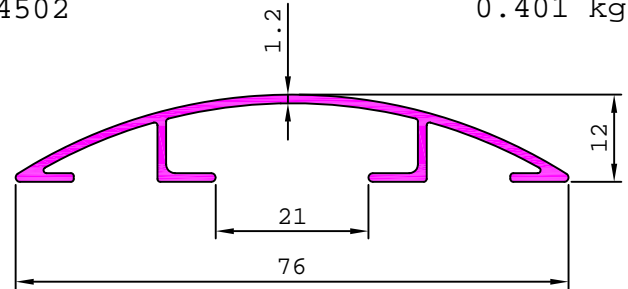

34503

0.381 kg/m

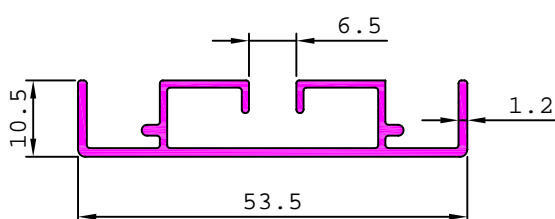

34504

0.365 kg/m

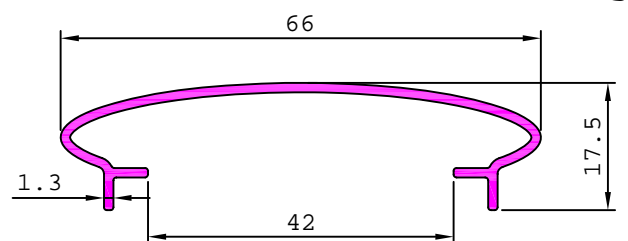

ARCHITECTURAL

MODULAR FURNITURE SECTION

34505

1.526 kg/m

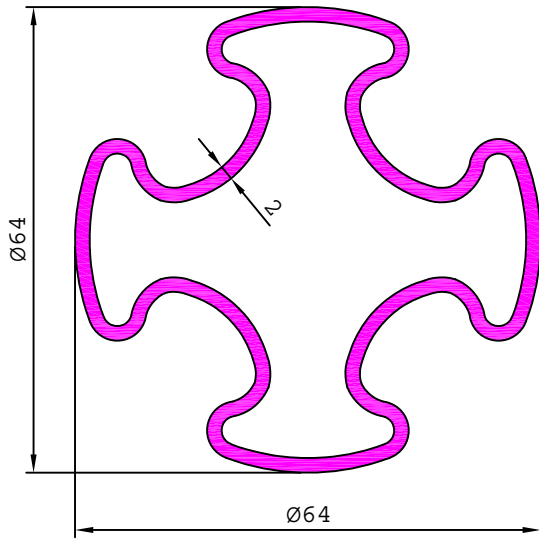

34516

2.842 kg/m

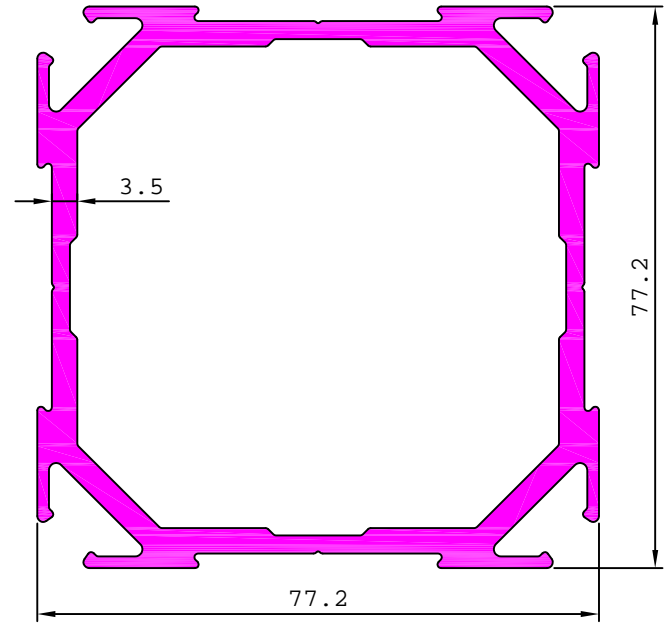

34508

0.376 kg/m

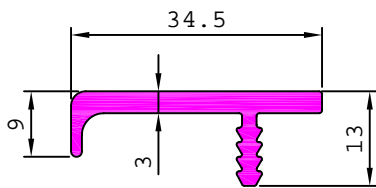

34513

0.162 kg/m

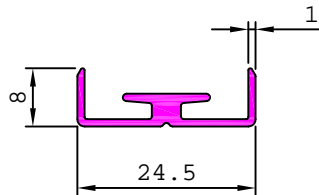

34515

0.252 kg/m

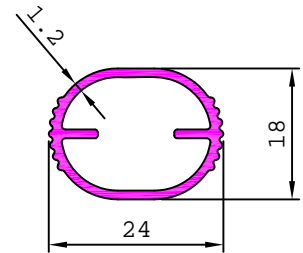

34511

0.763 kg/m

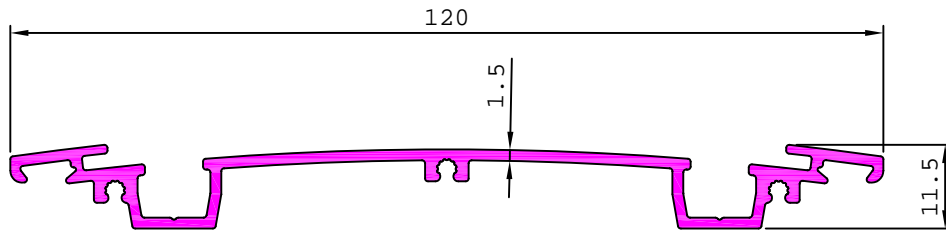

34512

1.751 kg/m

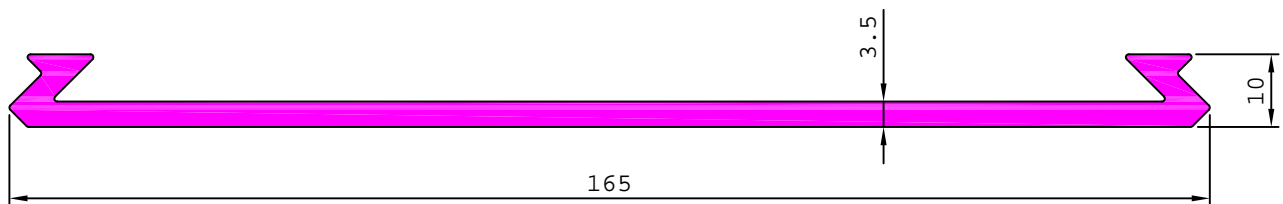

ARCHITECTURAL

MODULAR FURNITURE SECTION

34514 0.485 kg/m

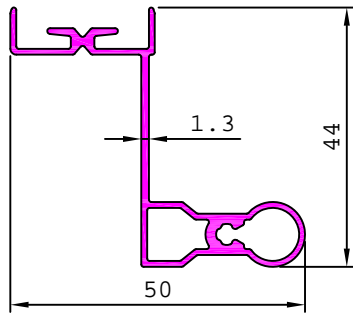

34518 0.681 kg/m

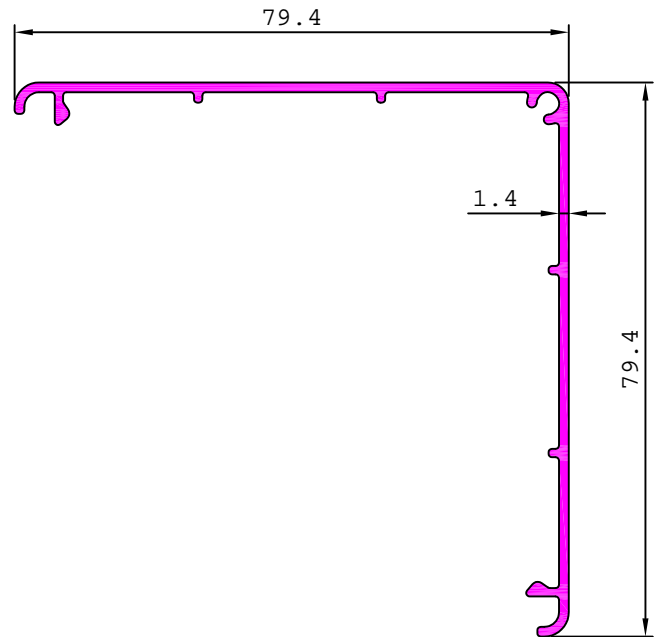

34517 0.362 kg/m

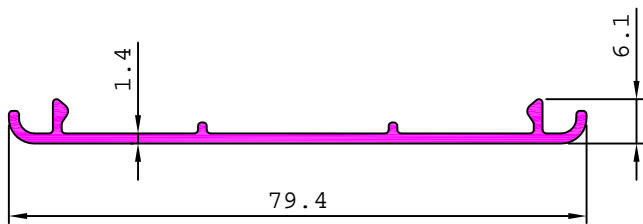

34519 0.489 kg/m

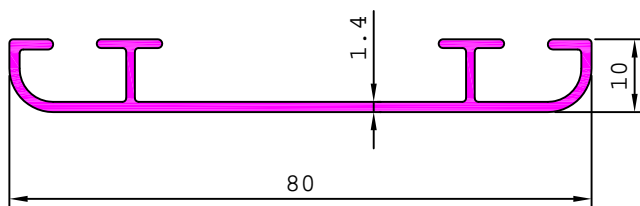

34524 0.467 kg/m

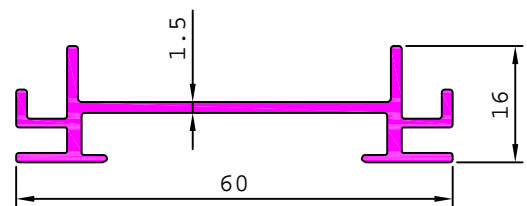

34521 0.344 kg/m

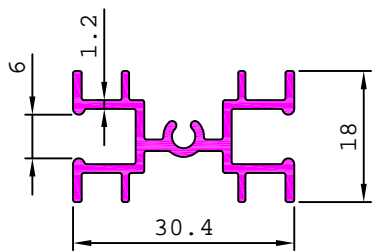

34522 0.306 kg/m

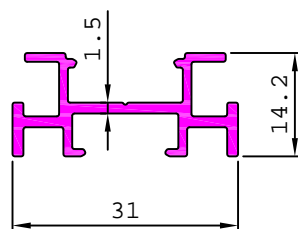

34525 0.498 kg/m

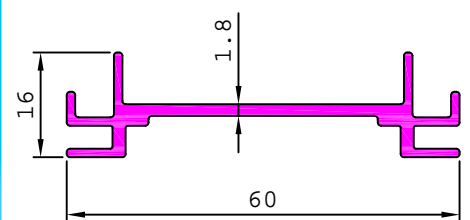

34523 1.432 kg/m

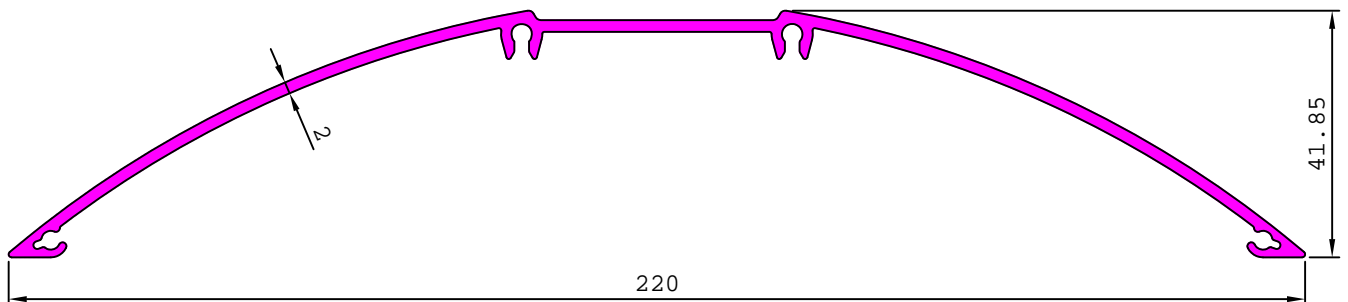

ARCHITECTURAL

MODULAR FURNITURE SECTION

34527

0.533 kg/m

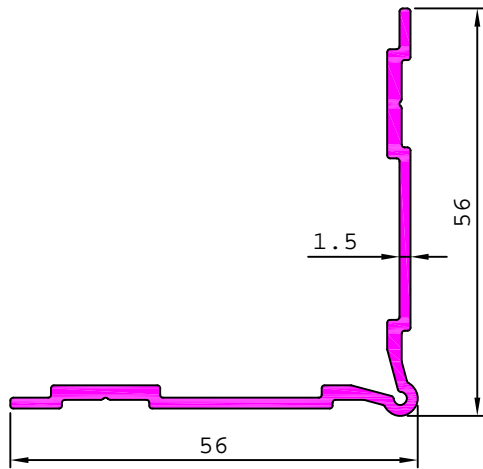

34526

0.525 kg/m

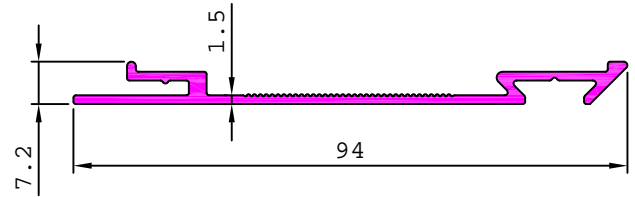

34528

0.948 kg/m

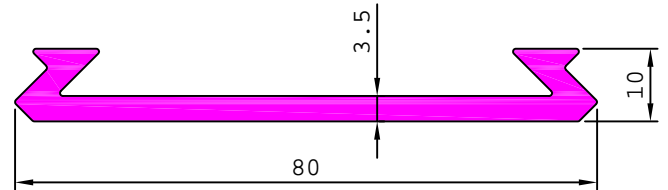

34529

1.374 kg/m

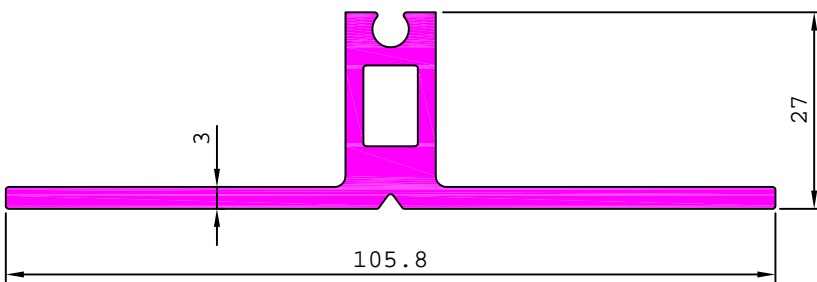

34530

0.288 kg/m

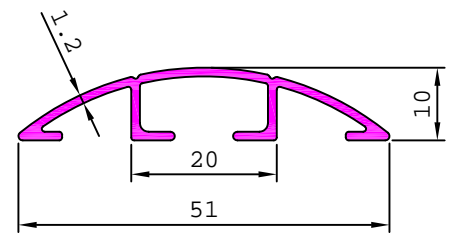

34531

0.722 kg/m

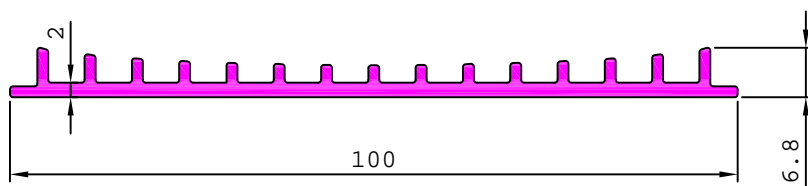

34534

0.547 kg/m

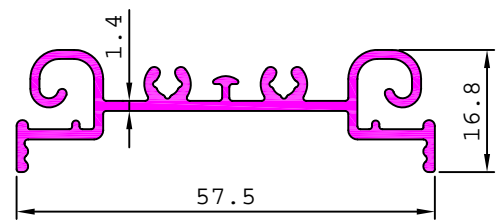

34533

0.563 kg/m

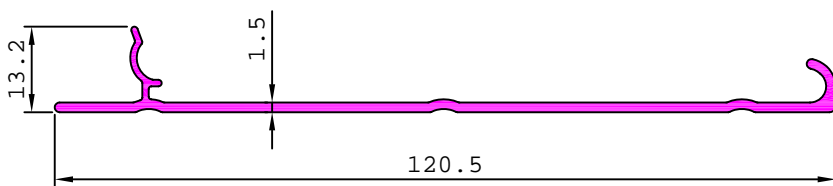

34536

0.281 kg/m

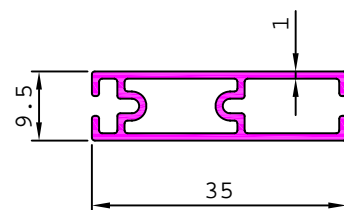

ARCHITECTURAL

MODULAR FURNITURE SECTION

34532

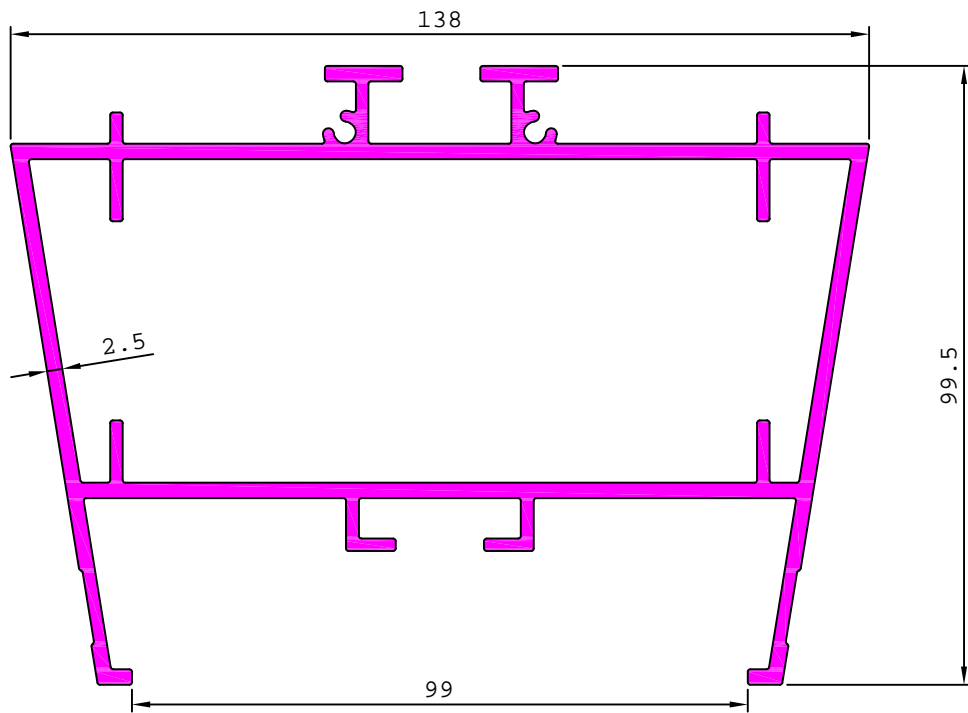

3.633 kg/m

34535

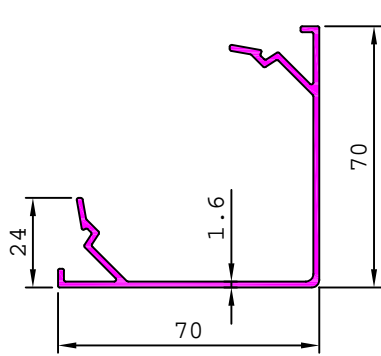

0.882 kg/m

34539

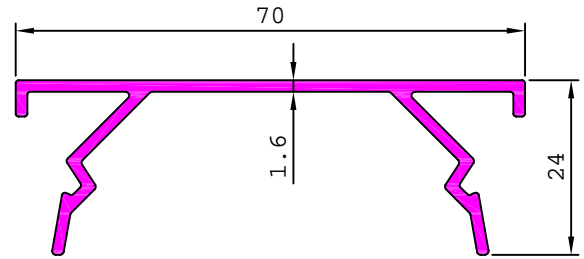

0.587 kg/m

34537

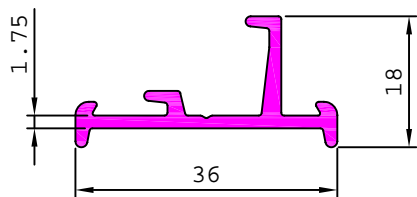

0.335 kg/m

34540

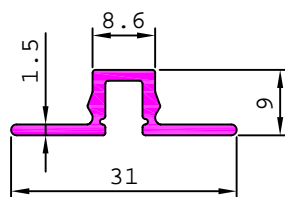

0.199 kg/m

34546

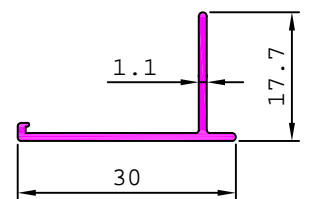

0.142 kg/m

34541

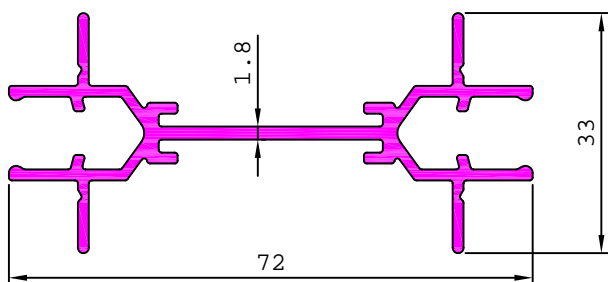

0.808 kg/m

34545

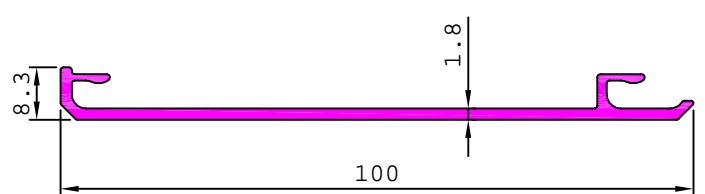

0.572 kg/m

MATCHING WITH 34587

ARCHITECTURAL

MODULAR FURNITURE SECTION

34538

0.729 kg/m

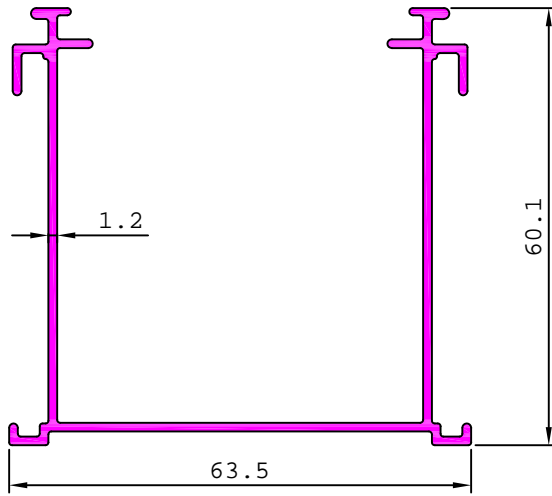

34547

0.475 kg/m

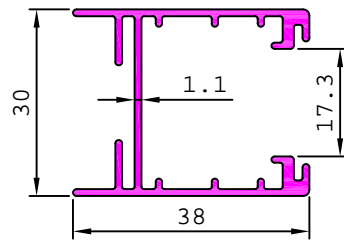

34548

1.385 kg/m

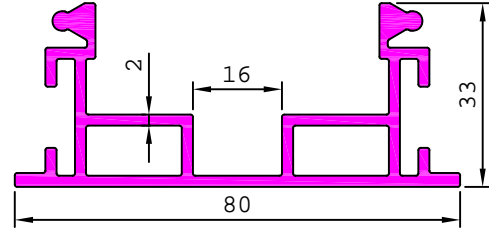

34542

8.233 kg/m

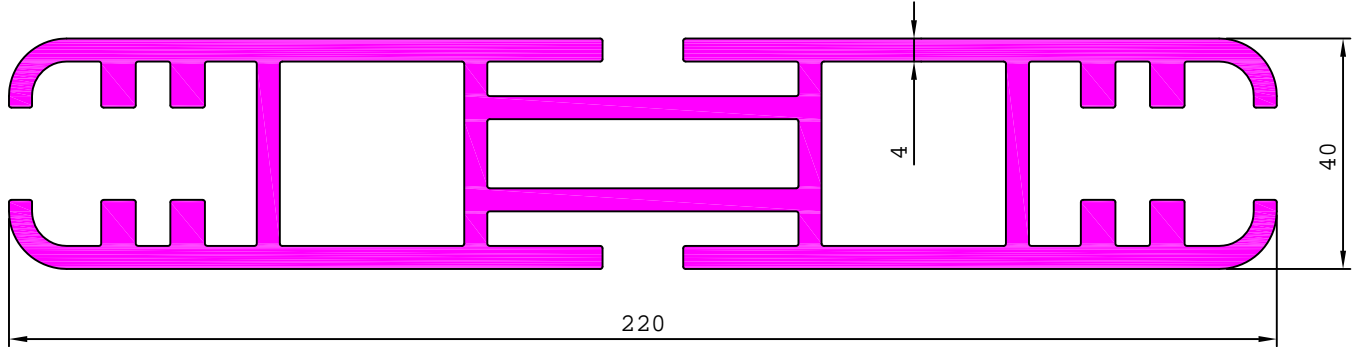

34543

3.413 kg/m

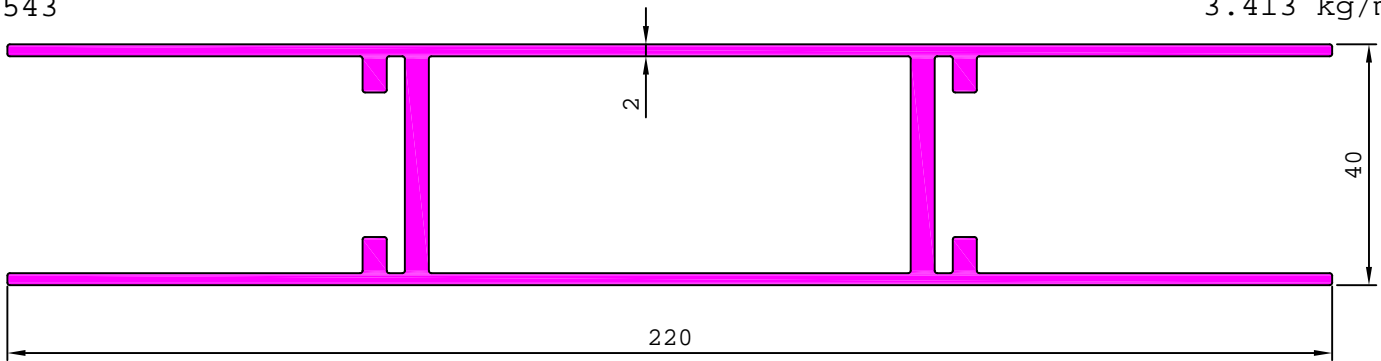

34544

0.659 kg/m

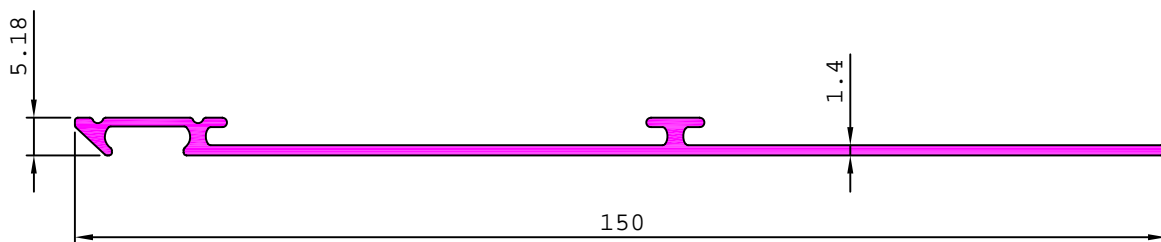

ARCHITECTURAL

MODULAR FURNITURE SECTION

34552 0.451 kg/m

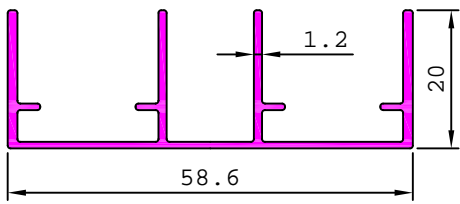

34553 0.310 kg/m

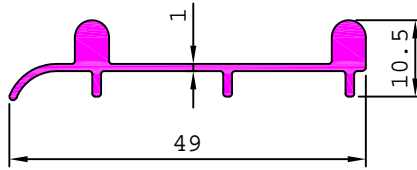

34557 0.120 kg/m

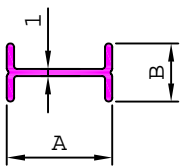
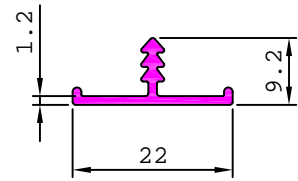

SL. No.	Section No.	A	B	Weight kg/m
1	34554	14.50	8.00	0.075
2	34558	21.00	12.00	0.114

34555 0.718 kg/m

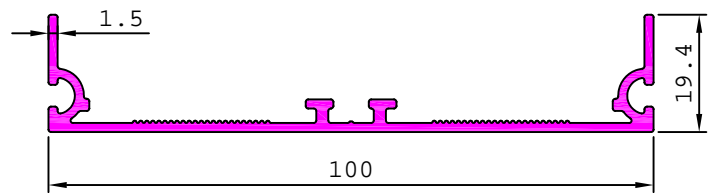

34568 0.508 kg/m

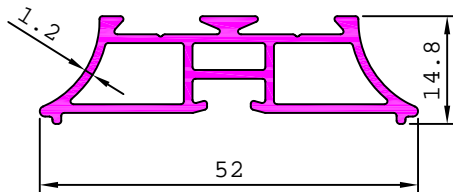

34567 0.533 kg/m

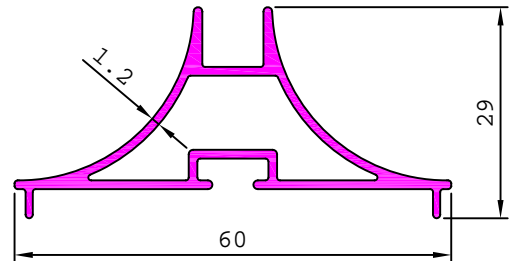

19454 0.126 kg/m

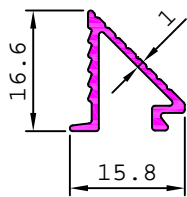

34559 0.164 kg/m

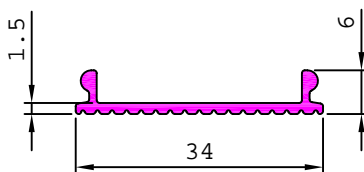

34561 0.731 kg/m

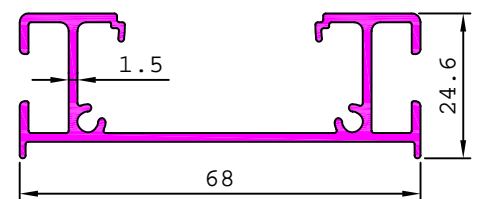

MATCHING WITH 34568, 34567

34556 0.380 kg/m

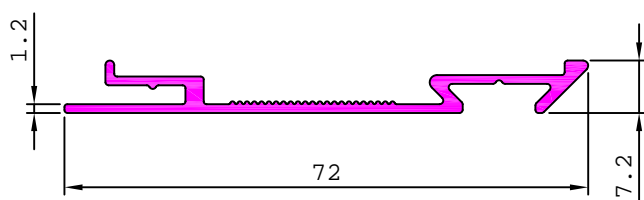

S4996 0.820 kg/m

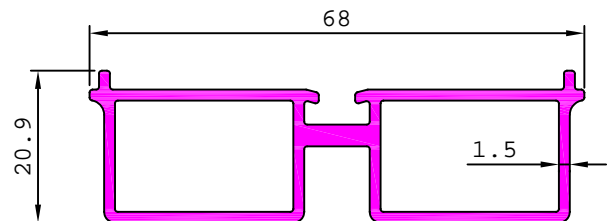

ARCHITECTURAL

MODULAR FURNITURE SECTION

34560 1.471 kg/m

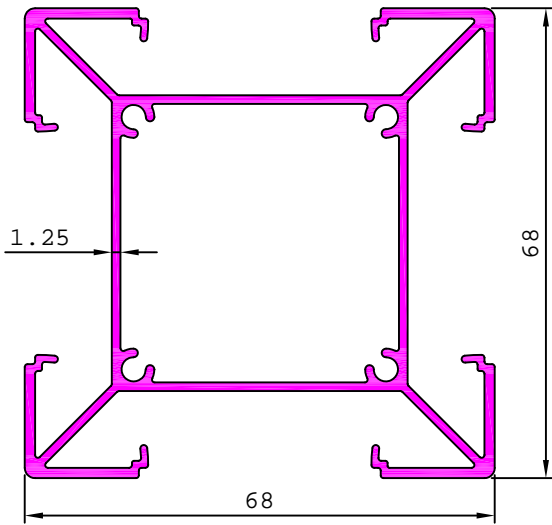

34562 4.865 kg/m

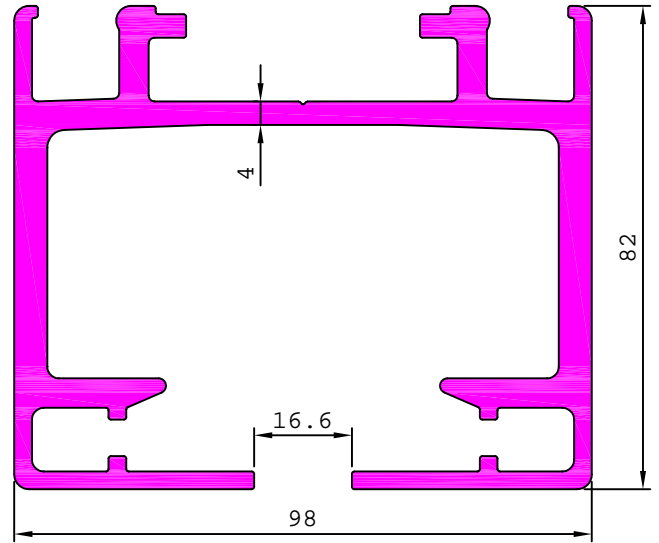

34565 1.095 kg/m

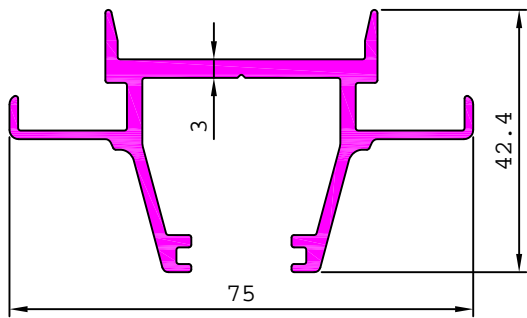

34566 1.278 kg/m

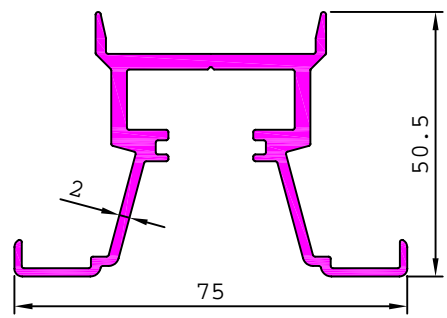

34569 0.223 kg/m

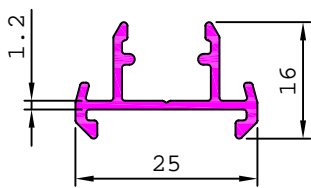

34570 0.198 kg/m

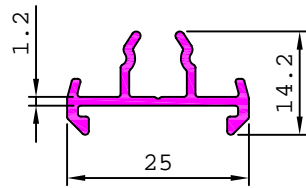

34572 0.317 kg/m

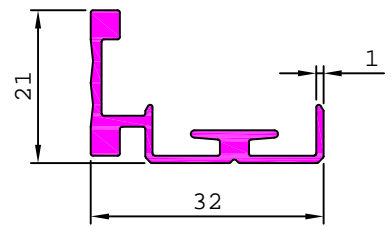

34571 1.308 kg/m

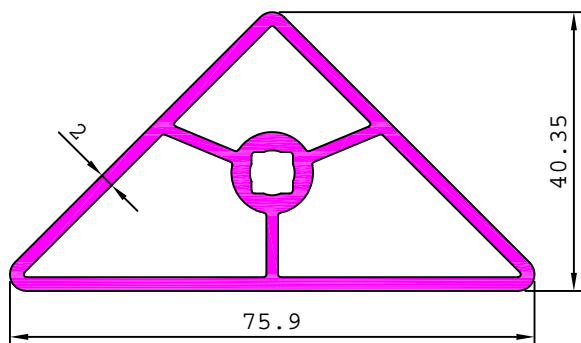

34573 1.116 kg/m

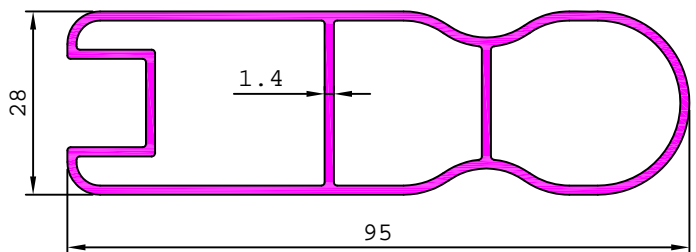

ARCHITECTURAL

MODULAR FURNITURE SECTION

34574

0.160 kg/m

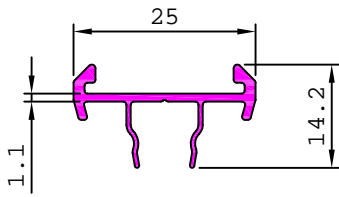

34575

0.247 kg/m

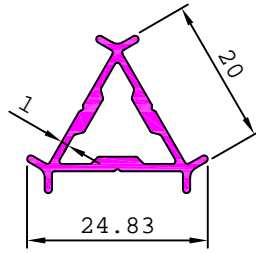

34576

0.485 kg/m

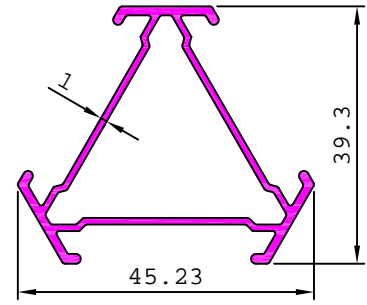

34577

0.416 kg/m

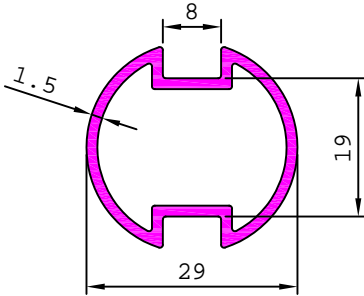

34578

0.274 kg/m

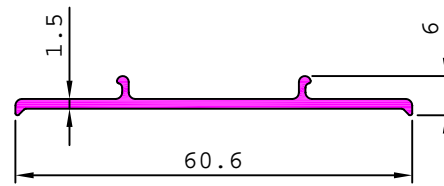

34588

0.100 kg/m

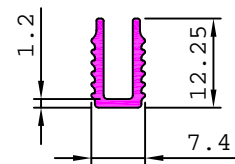

34579

1.597 kg/m

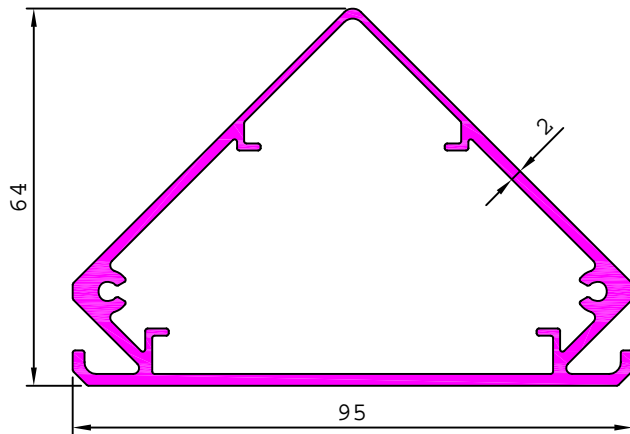

34580

1.241 kg/m

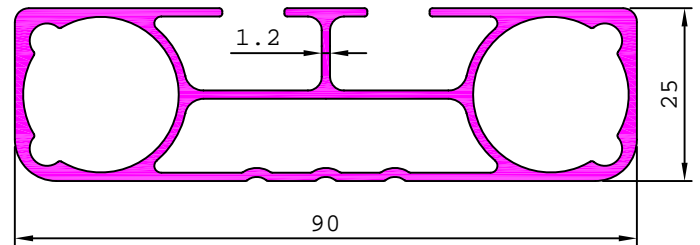

34581

0.523 kg/m

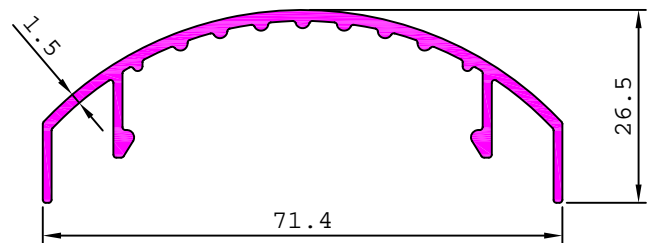

34582

0.573 kg/m

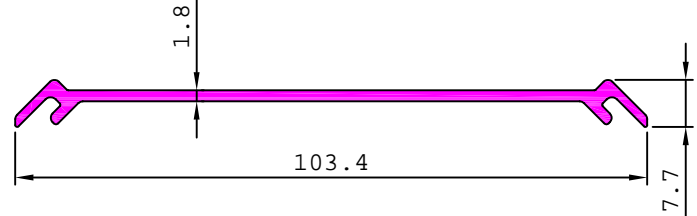

34586

0.345 kg/m

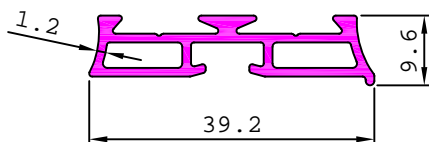

34583

0.463 kg/m

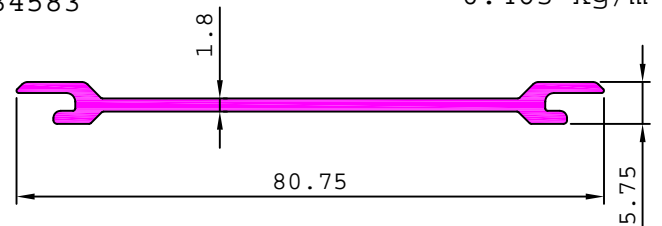

ARCHITECTURAL

MODULAR FURNITURE SECTION

34584

2.369 kg/m

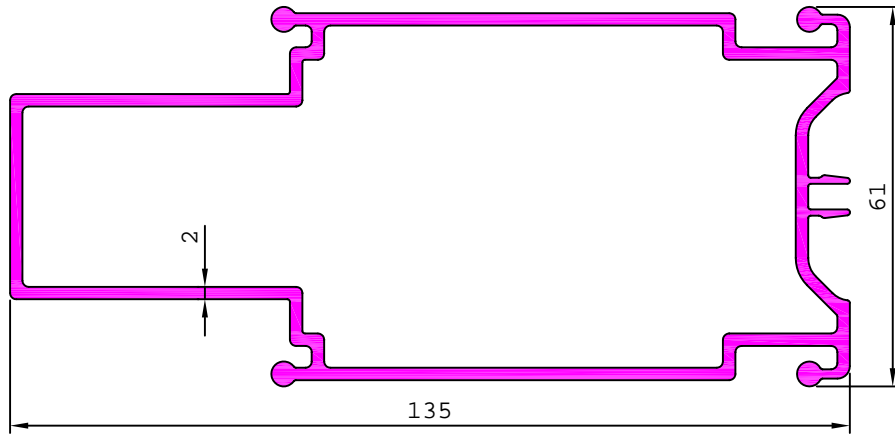

34585

0.588 kg/m

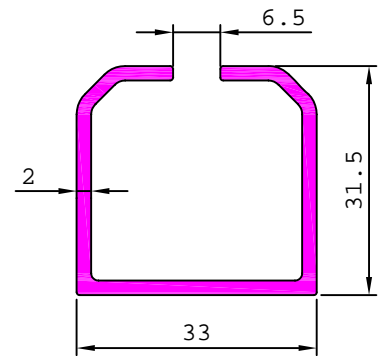

34587

2.080 kg/m

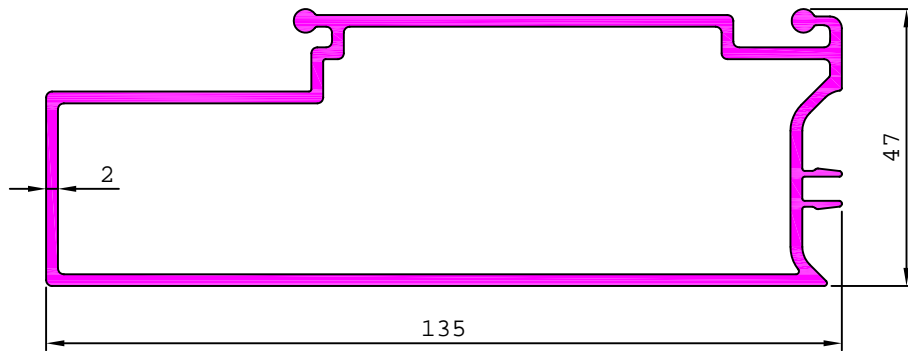

34589

0.729 kg/m

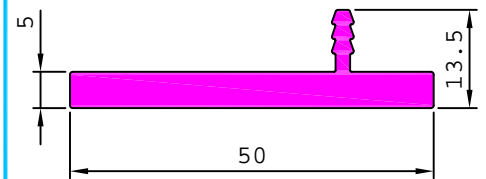

MATCHING WITH 34545

34590

0.301 kg/m

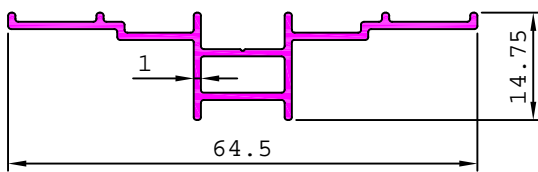

34591

0.598 kg/m

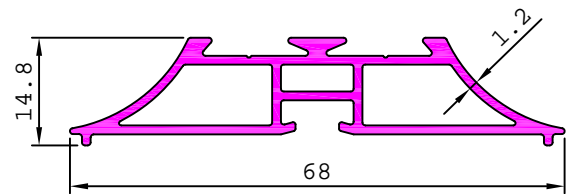

34592

0.644 kg/m

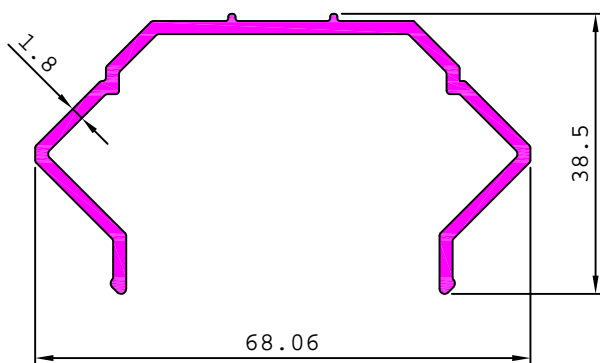

34594

1.526 kg/m

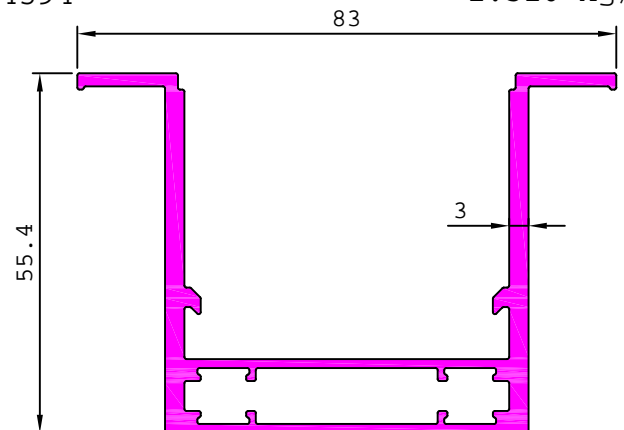

ARCHITECTURAL

MODULAR FURNITURE SECTION

34595 83 1.539 kg/m

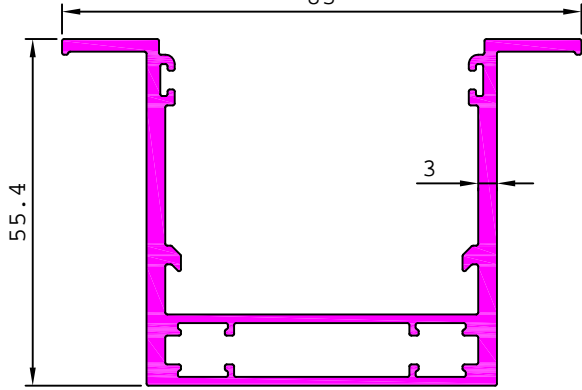

34596 100 1.793 kg/m

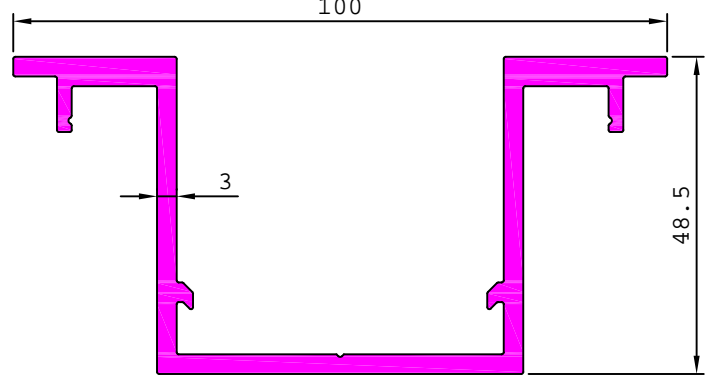

34597 100 1.273 kg/m

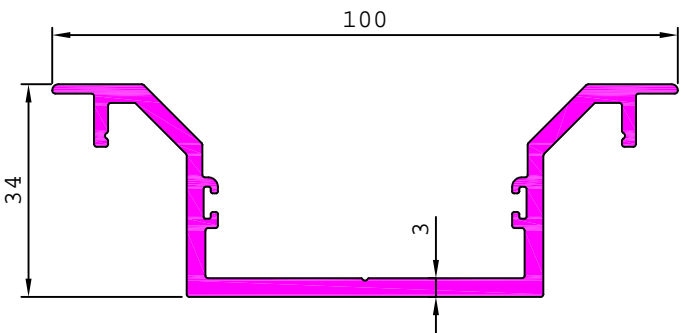

34600 0.445 kg/m

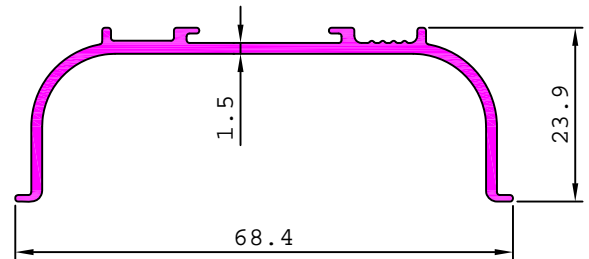

34598 169.5 1.923 kg/m

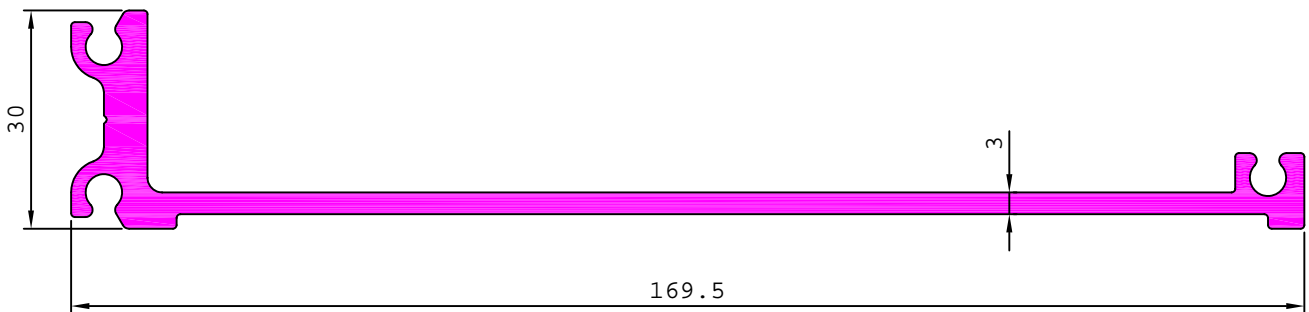

34593 0.500 kg/m

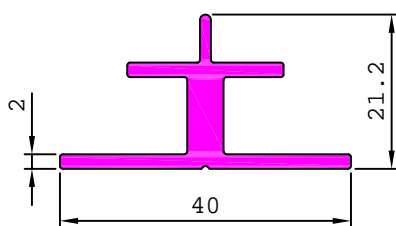

34599 0.570 kg/m

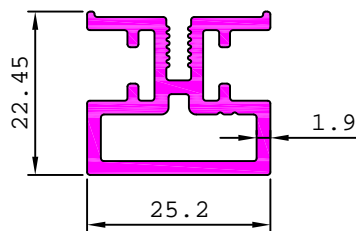

34601 0.332 kg/m

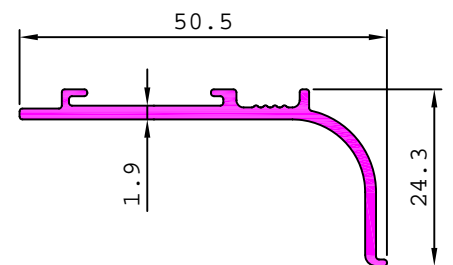

ARCHITECTURAL

MODULAR FURNITURE SECTION

34602

0.273 kg/m

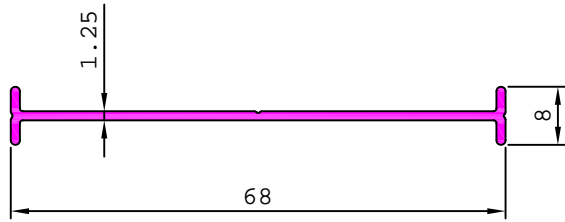

34604

0.439 kg/m

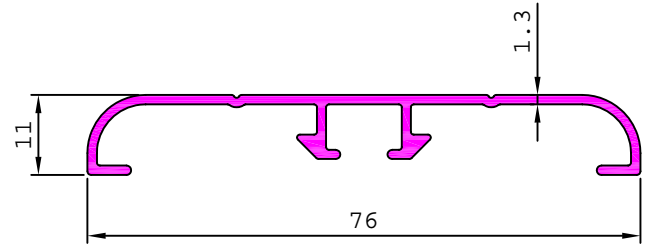

29072

0.551 kg/m

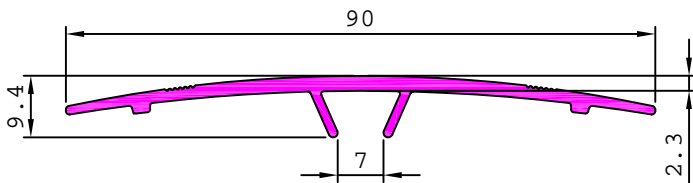

29543

0.749 kg/m

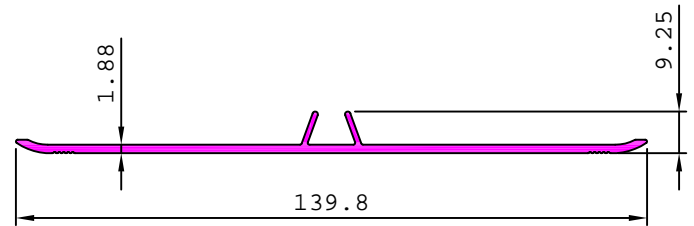

34603

0.347 kg/m

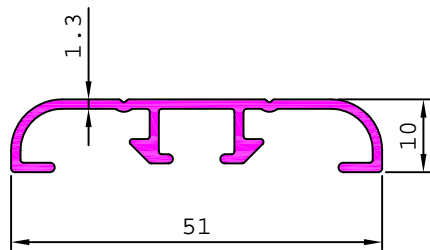

S4284

0.631 kg/m

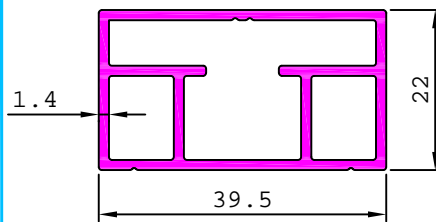

S4285

0.172 kg/m

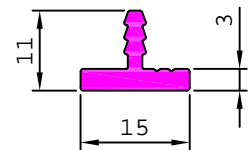

S4286

0.400 kg/m

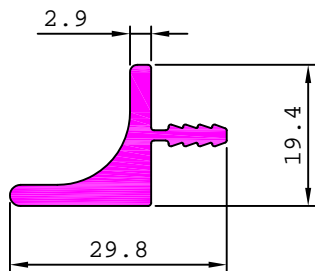

S4287

0.270 kg/m

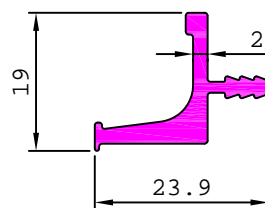

S4288

0.597 kg/m

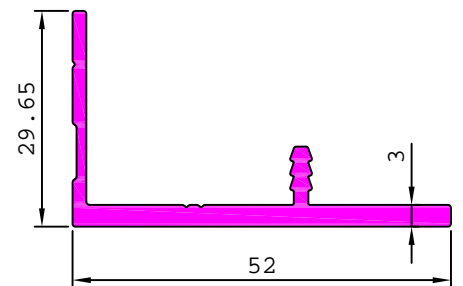

S4289

0.495 kg/m

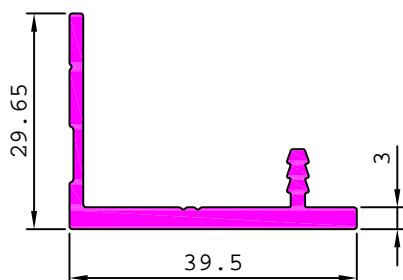

S4290

0.865 kg/m

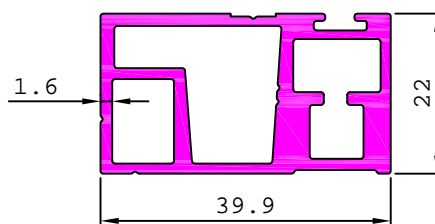

S4320

0.331 kg/m

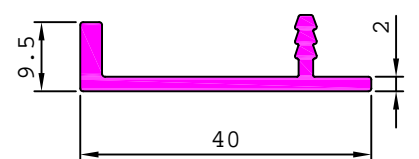

ARCHITECTURAL

MODULAR FURNITURE SECTION

S4399

0.208 kg/m

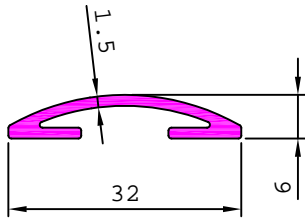

S4542

0.122 kg/m

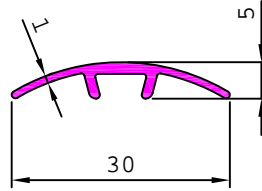

S4962

0.396 kg/m

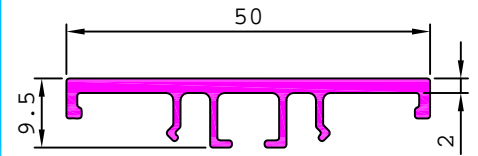

S4965

0.943 kg/m

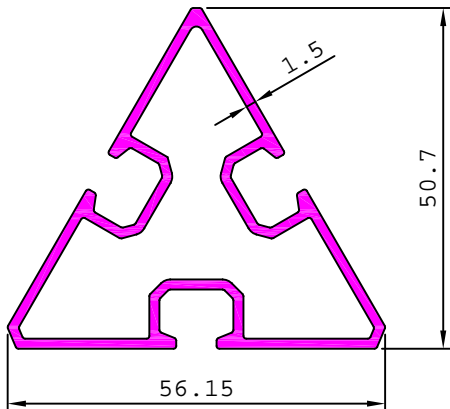

24482

1.855 kg/m

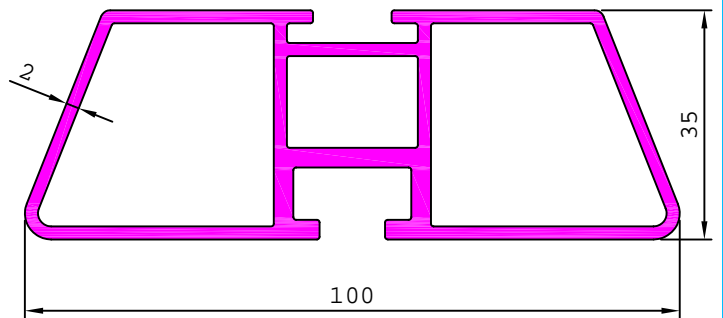

29575

0.544 kg/m

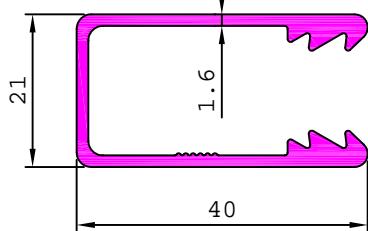

S4631

1.289 kg/m

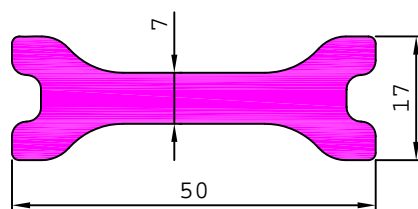

S4944

0.850 kg/m

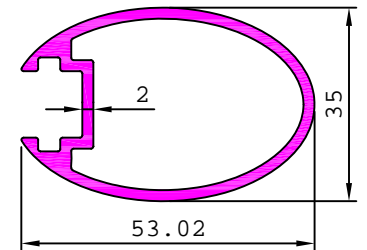

S5212

5.007 kg/m

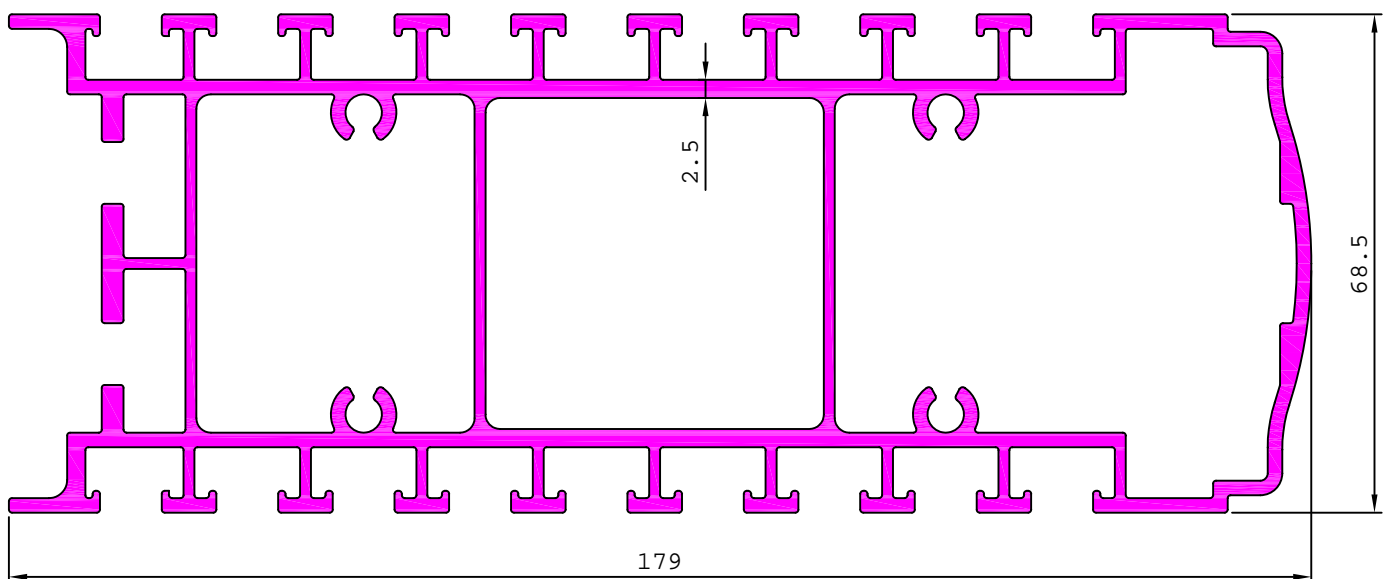

ARCHITECTURAL

MODULAR FURNITURE SECTION

S5213

0.251 kg/m

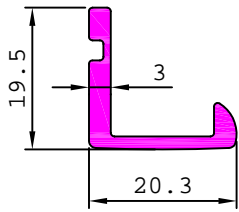

ARCHITECTURAL

LADDERS

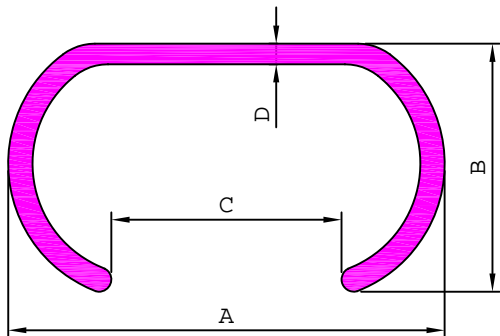

SL. No.	Section No.	A	B	C	D	Weight kg/m
1	22552	62.00	28.00	40.00	1.10	0.335
2	22544	66.65	31.75	41.30	1.20	0.410
3	22511	66.65	31.75	41.30	1.81	0.607
4	22571	66.65	31.75	41.30	2.20	0.732
5	22503	66.65	31.75	41.30	2.54	0.837
6	22504	66.67	31.75	41.27	3.18	1.046
7	22505	66.68	31.75	47.00	4.00	1.247

22513 0.976 kg/m

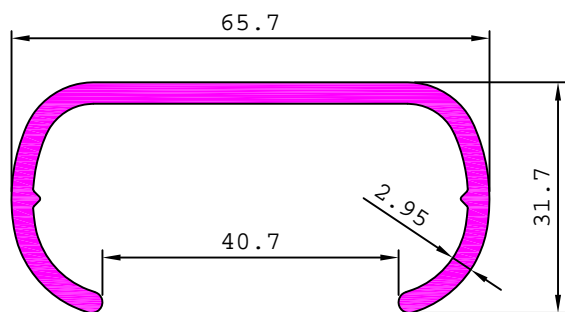

22516 1.009 kg/m

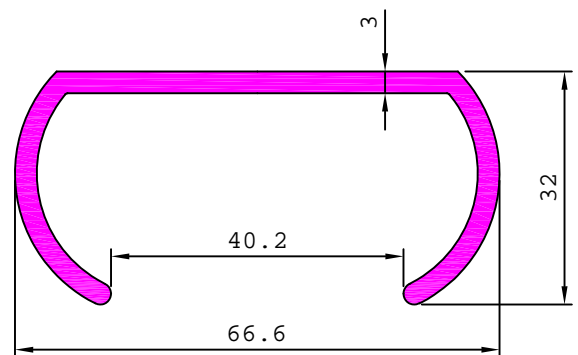

22524 0.668 kg/m

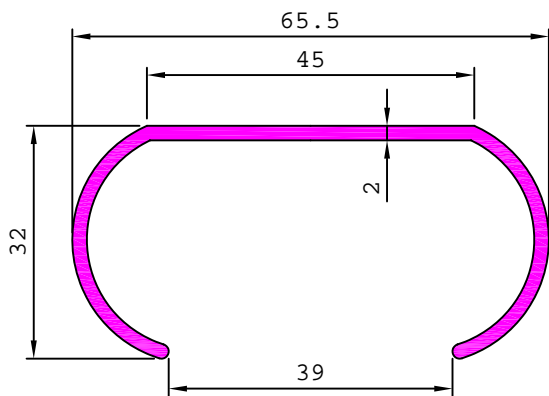

22554 0.556 kg/m

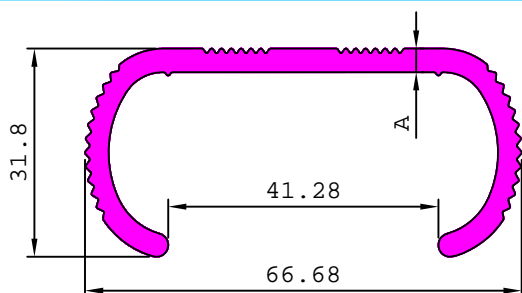
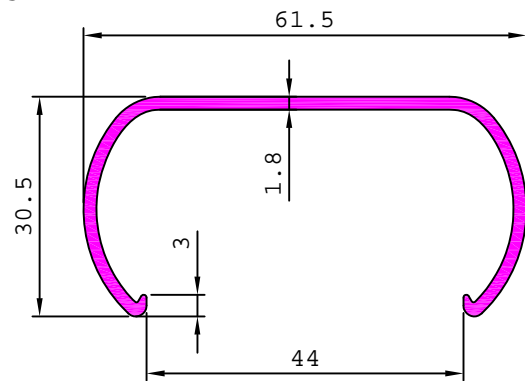

SL. No.	Section No.	A	Weight kg/m
1	22583	3.20	0.985
2	22575	3.60	1.105

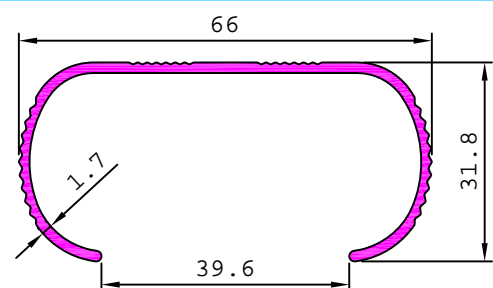

SL. No.	Section No.	A	Weight kg/m
1	22573	1.70	0.544
2	22574	2.50	0.800

ARCHITECTURAL

LADDERS

22515 0.535 kg/m

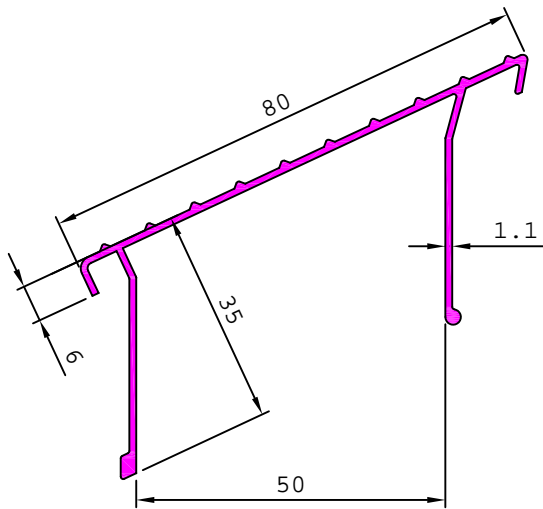

22526 0.506 kg/m

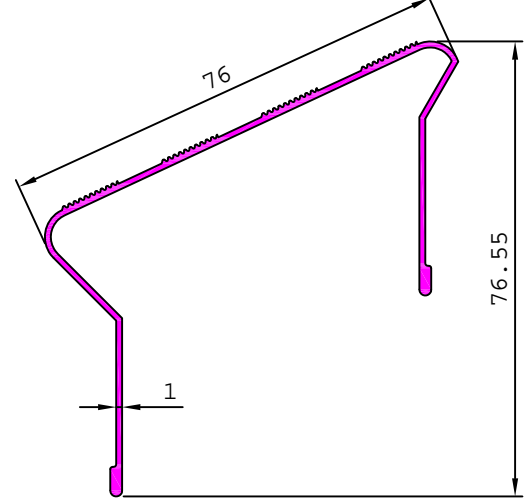

22525 0.486 kg/m

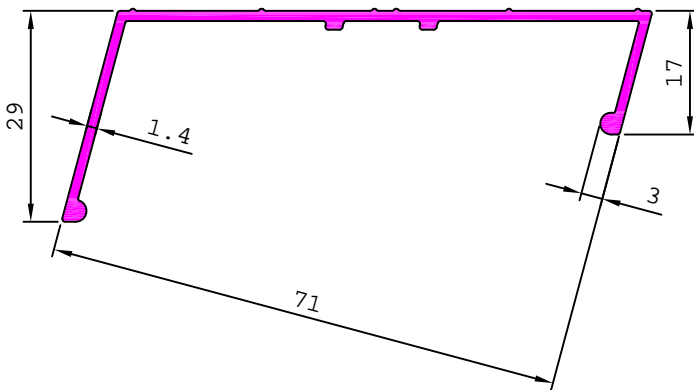

22547 0.875 kg/m

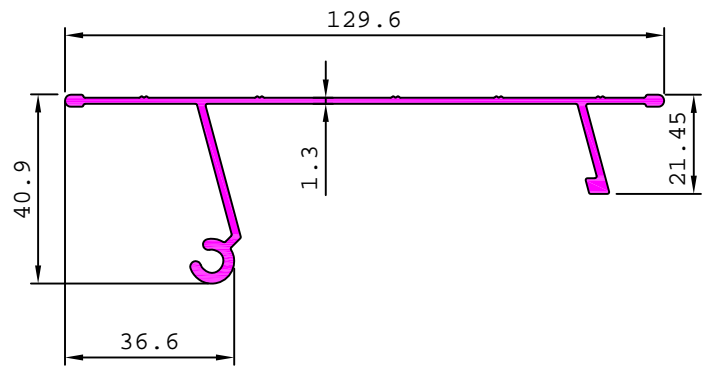

22550 1.296 kg/m

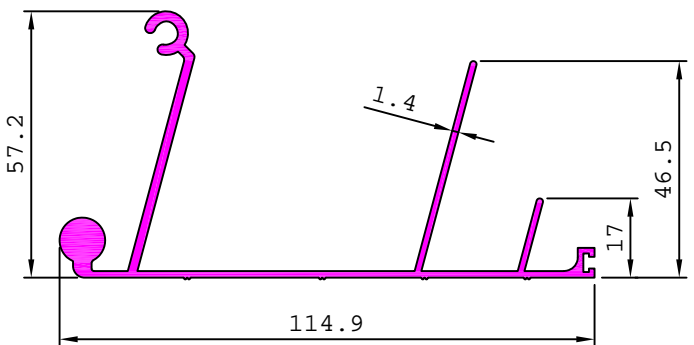

22551 1.103 kg/m

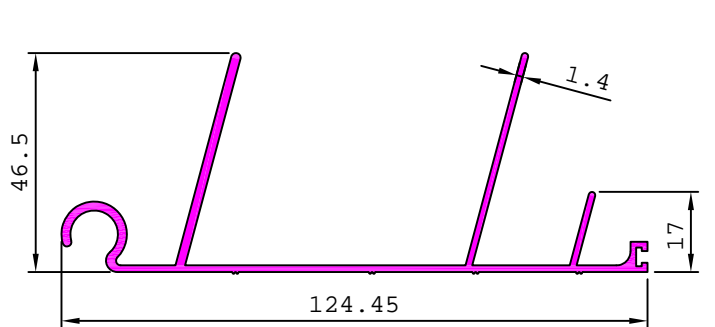

22549 0.360 kg/m

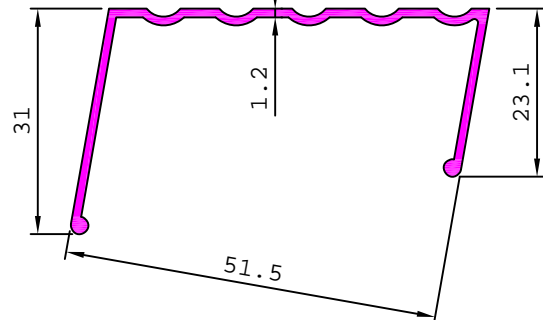

22553 0.287 kg/m

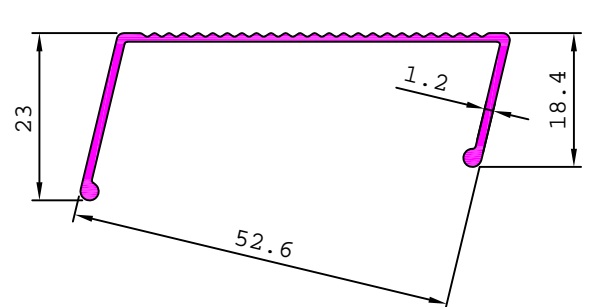

ARCHITECTURAL

LADDERS

22565

0.328 kg/m

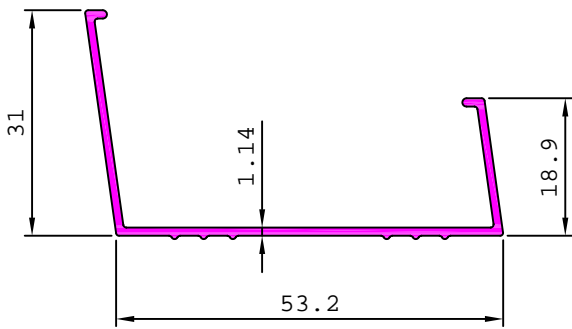

22568

0.594 kg/m

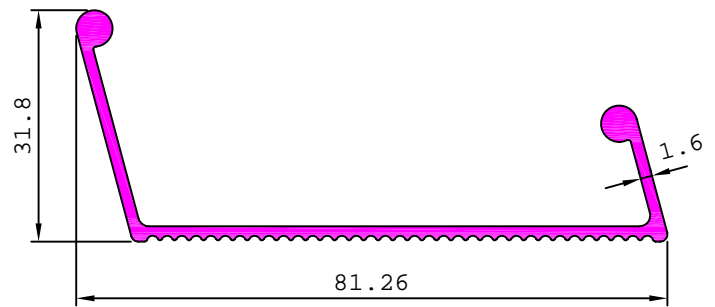

22570

0.609 kg/m

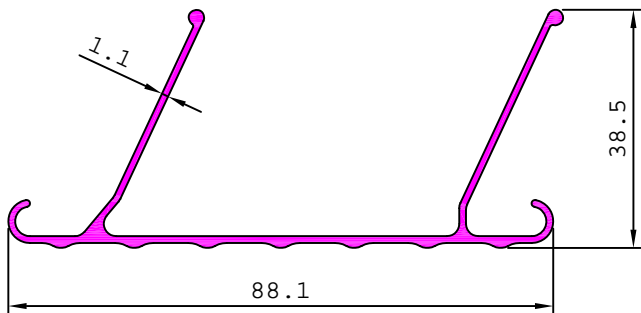

22558

0.777 kg/m

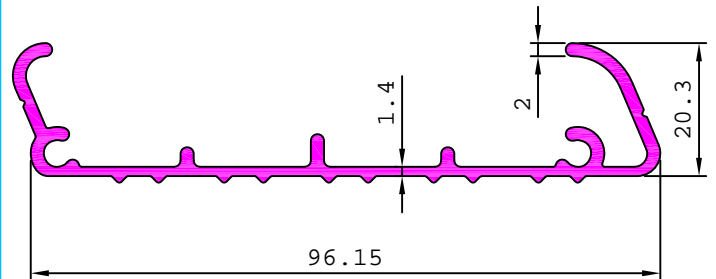

22507

0.673 kg/m

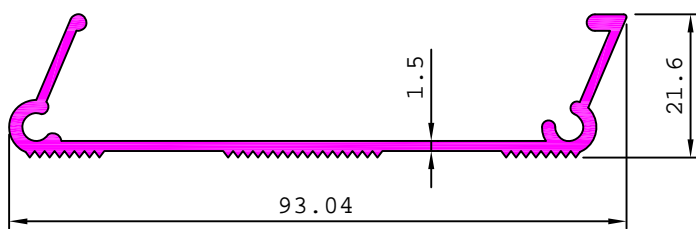

22581

0.404 kg/m

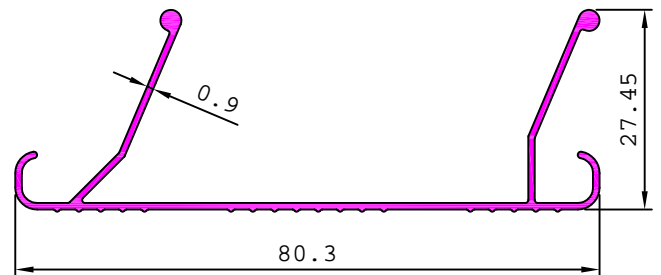

22588

0.681 kg/m

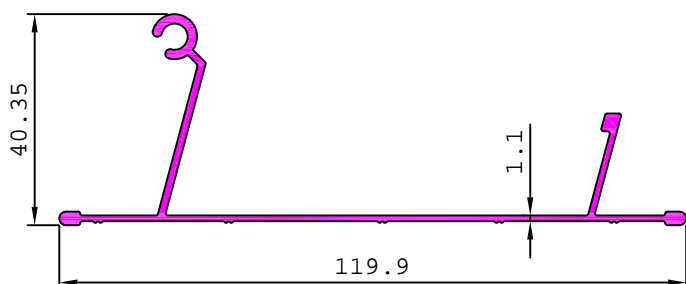

ARCHITECTURAL

LADDERS

22506 0.767 kg/m

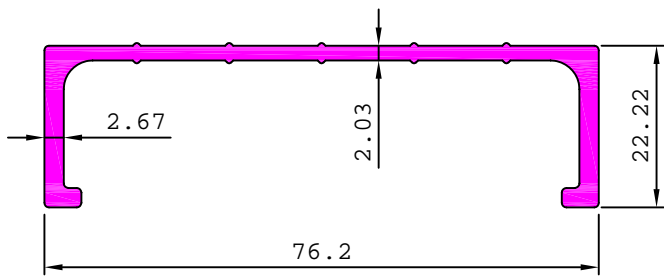

22508 0.662 kg/m

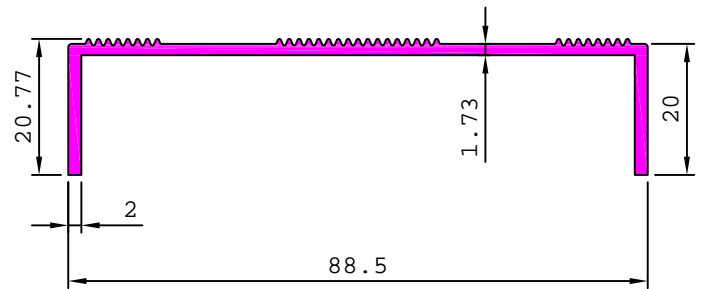

22512 0.575 kg/m

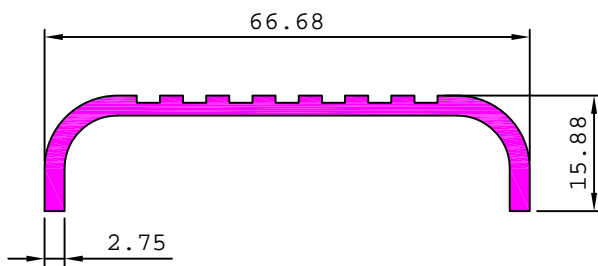

22548 0.355 kg/m

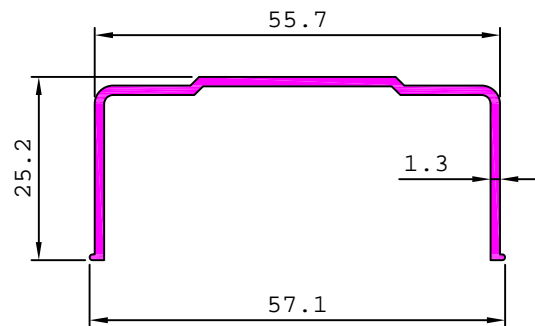

22563 0.327 kg/m

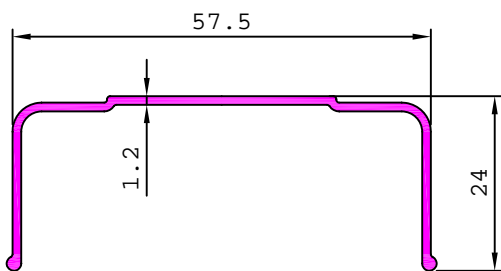

22567 0.640 kg/m

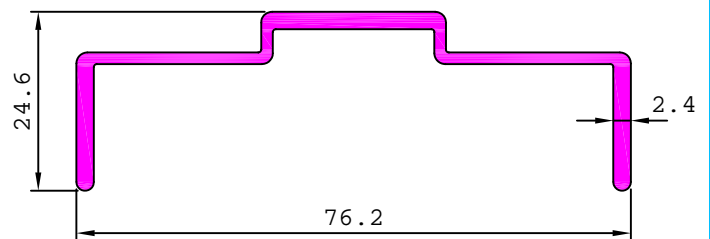

22572 0.739 kg/m

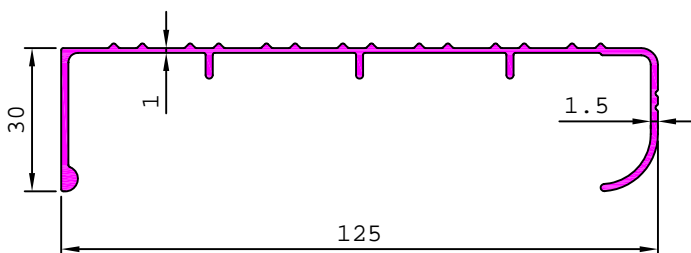

22584 0.793 kg/m

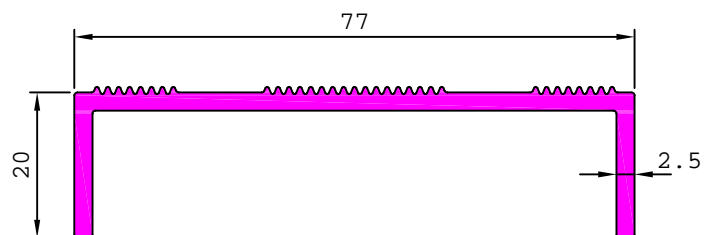

ARCHITECTURAL

LADDERS

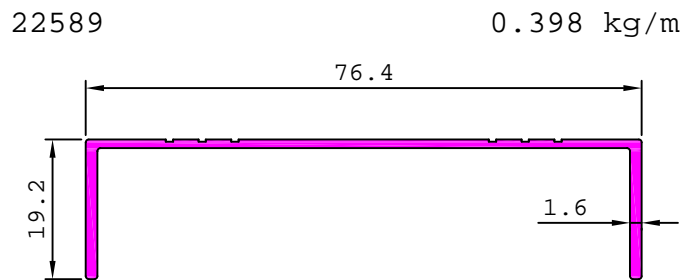
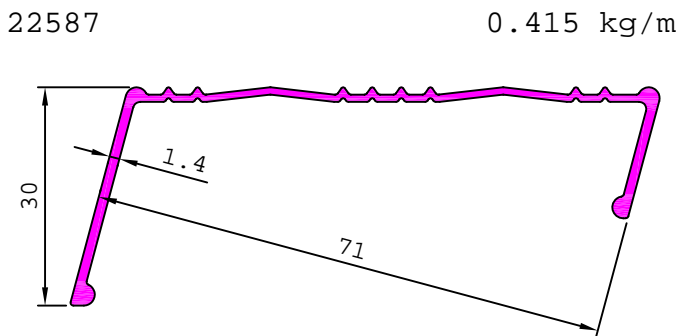
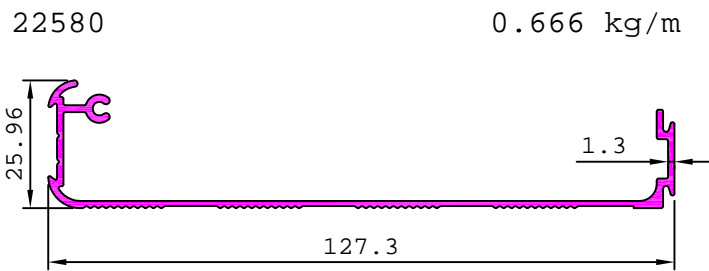
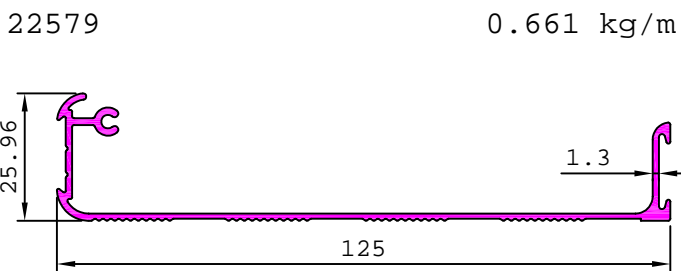
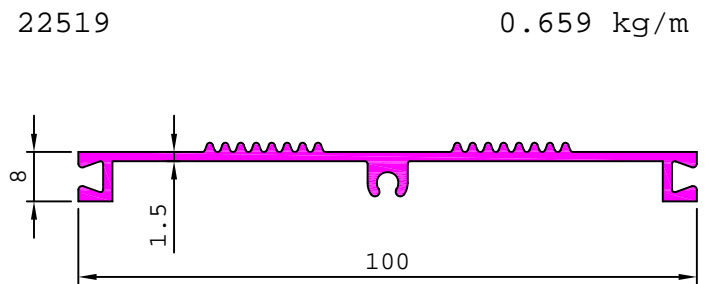
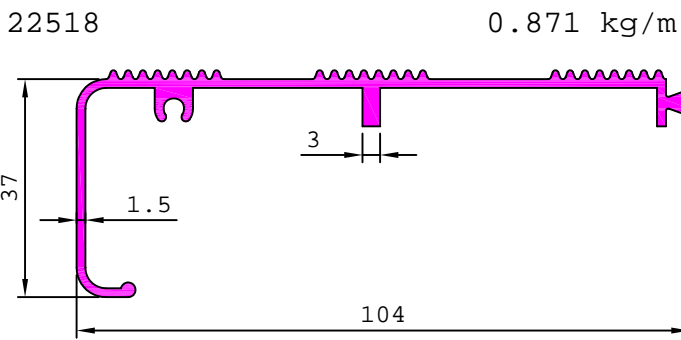
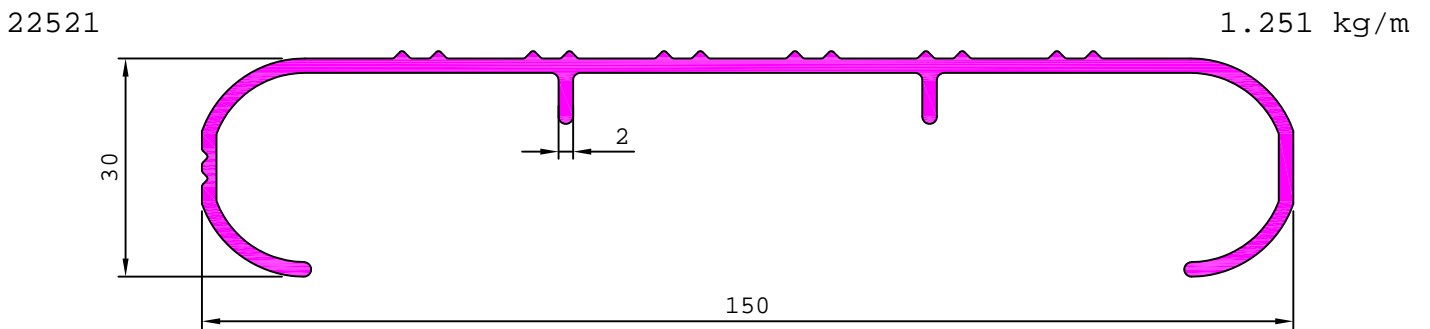
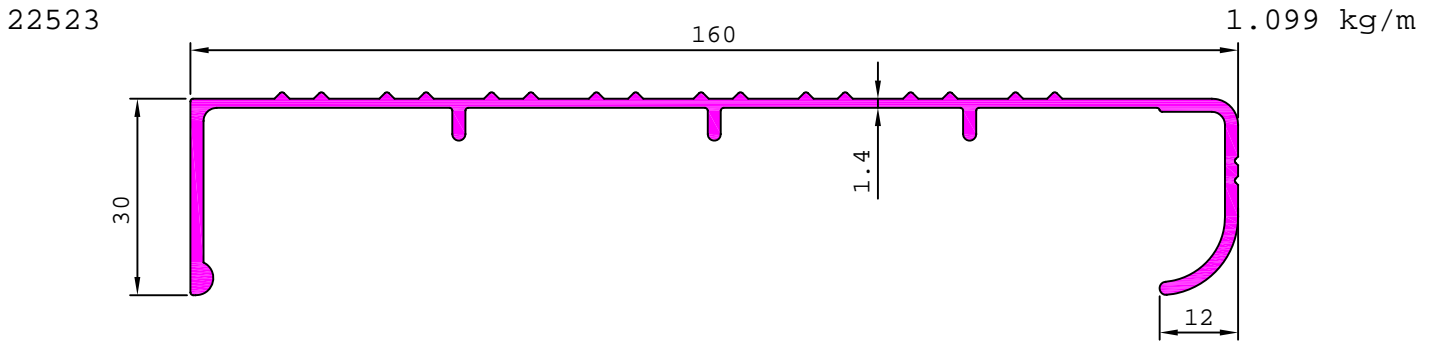

ARCHITECTURAL

LADDERS

22591

1.538 kg/m

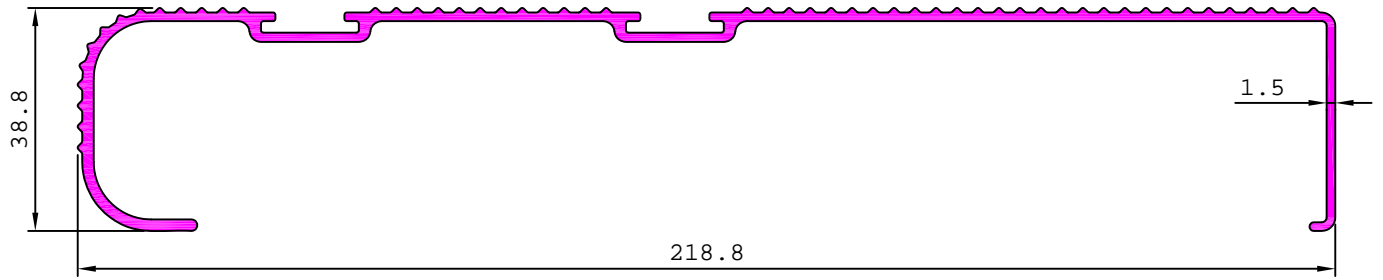

S4546

1.551 kg/m

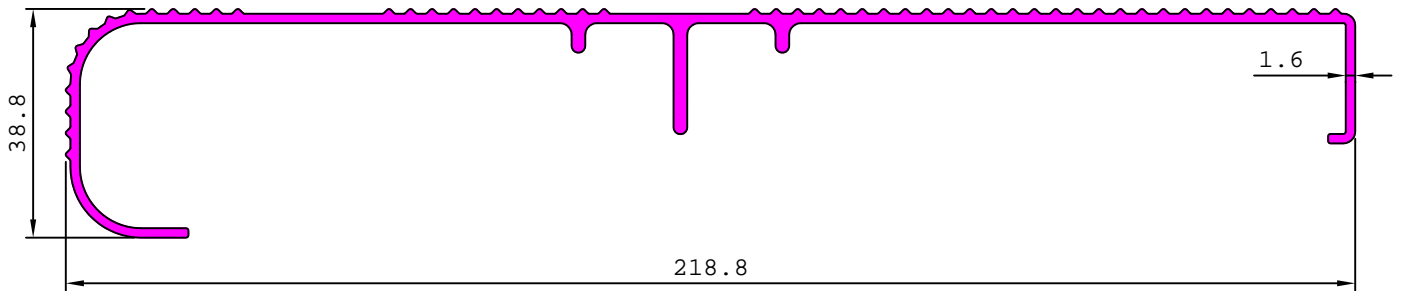

ARCHITECTURAL

LADDERS

22510

0.769 kg/m

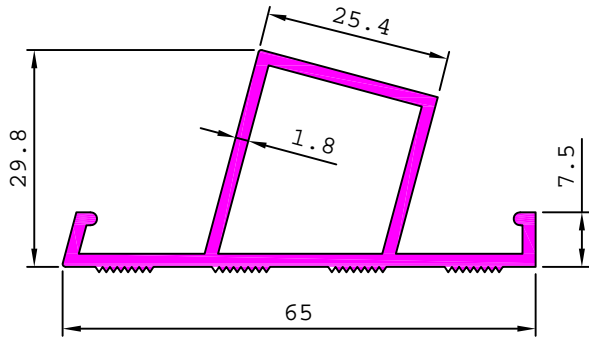

22520

1.038 kg/m

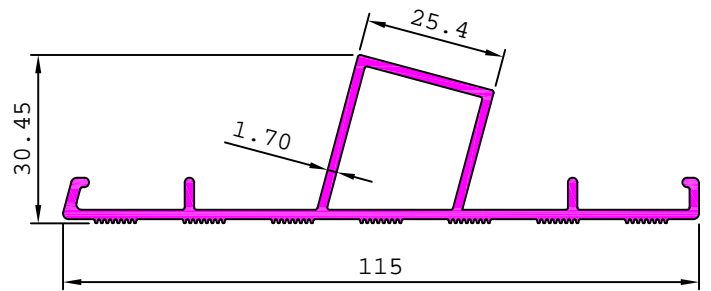

22562

0.516 kg/m

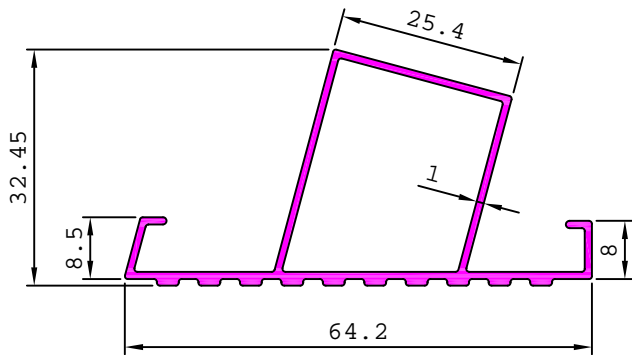

22566

0.692 kg/m

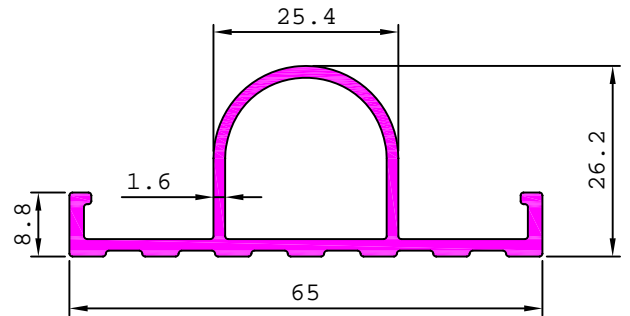

22582

0.510 kg/m

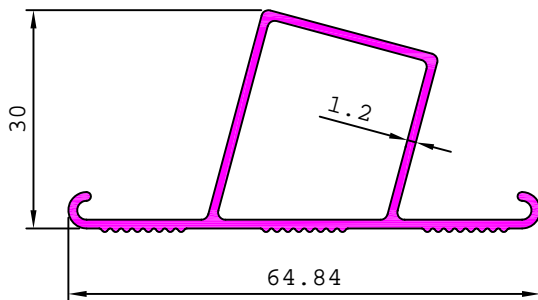

ARCHITECTURAL

LADDERS

22501

0.350 kg/m

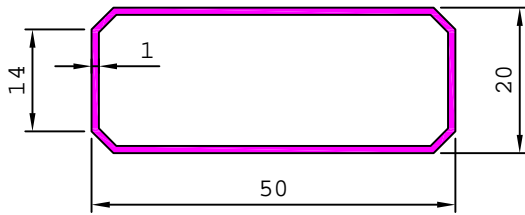

22502

0.252 kg/m

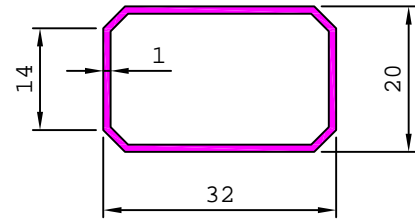

22522

0.536 kg/m

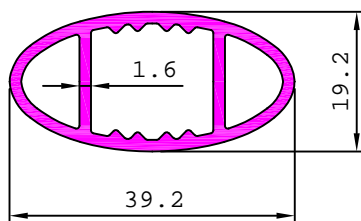

22545

0.197 kg/m

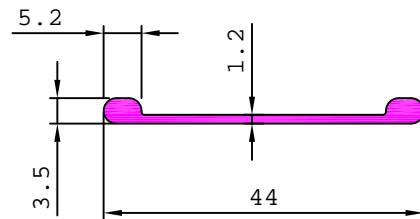

22546

0.371 kg/m

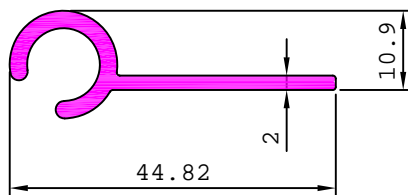

22564

0.133 kg/m

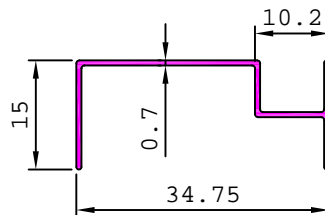

22559

0.345 kg/m

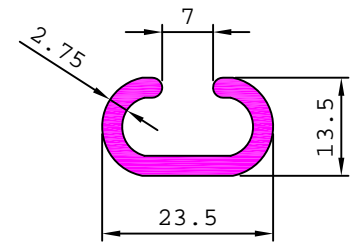

22561

0.362 kg/m

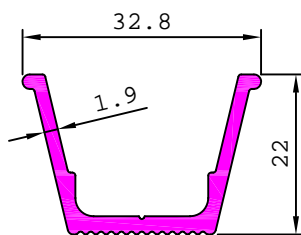

24491

0.270 kg/m

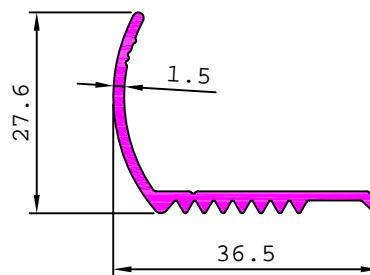

22576

0.441 kg/m

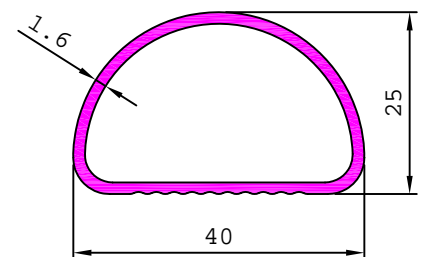

22577

0.263 kg/m

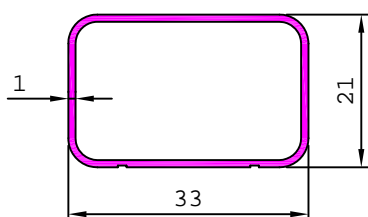

22578

0.349 kg/m

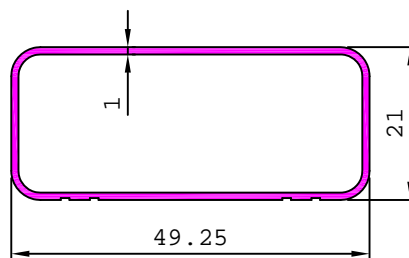

22590

0.271 kg/m

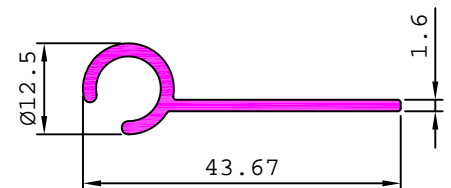

MATCHING WITH 22588

ARCHITECTURAL

LADDERS

22586

17.378 kg/m

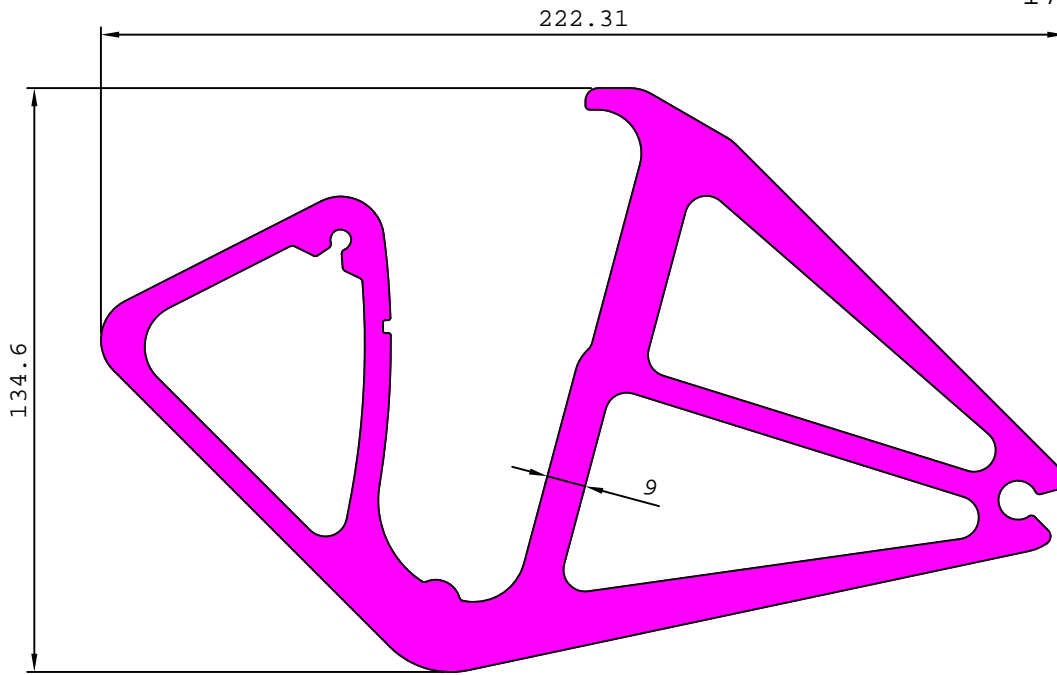

S4440

0.448 kg/m

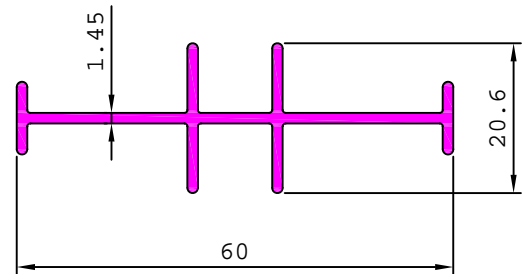
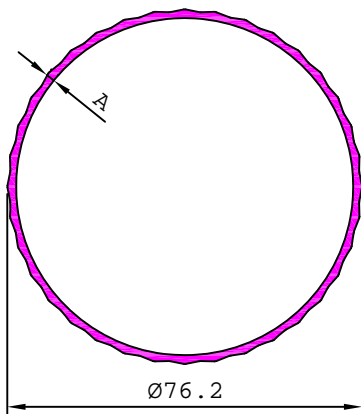

SL. No.	Section No.	A	Weight kg/m
1	S4879	1.60	0.839
2	22585	1.90	1.024

ARCHITECTURAL

LADDERS

FLUTED ROUND TUBES

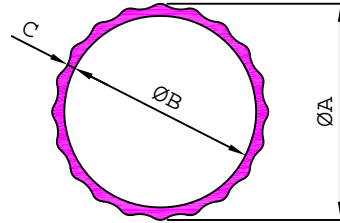

SL. No.	Section No.	ØA	ØB	C	Weight kg/m
1	14904	18.50	16.75	0.67	0.114
2	14907	18.50	17.33	0.38	0.074
3	14913	18.80	16.70	0.70	0.127
4	14901	19.05	16.90	0.70	0.130
5	14910	20.50	17.70	0.90	0.186
6	14909	20.70	19.20	0.52	0.109
7	14915	24.00	22.62	0.49	0.114
8	14903	24.80	22.60	0.70	0.179
9	14916	24.80	22.97	0.67	0.156
10	14906	24.80	23.56	0.416	0.107
11	14921	24.80	22.84	0.40	0.148
12	14902	25.40	20.34	1.83	0.410
13	14914	25.40	22.01	0.93	0.252
14	14912	25.40	22.07	0.90	0.247
15	14908	25.40	22.20	0.79	0.226
16	14917	25.40	22.68	0.60	0.189
17	14919	25.40	20.80	1.60	0.370
18	14905	28.00	25.50	0.80	0.237
19	14911	28.00	26.32	0.63	0.171
20	14918	32.06	27.00	1.83	0.533
21	14920	37.00	33.00	1.50	0.511

ARCHITECTURAL

NORTH LIGHT GLAZING BARS & SHOES

22529 0.516 kg/m

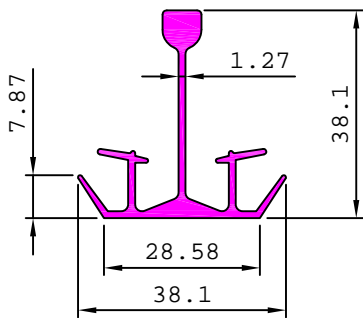

22530 0.486 kg/m

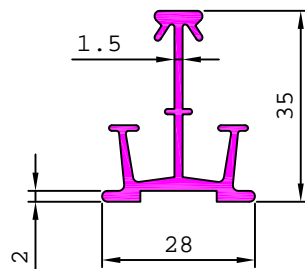

MATCHING SECTION 22534

22531 0.488 kg/m

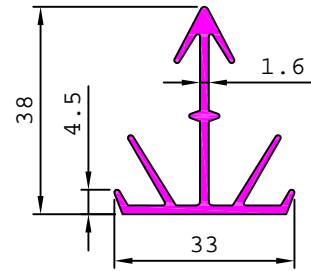

MATCHING SECTION 22532

22532 0.332 kg/m

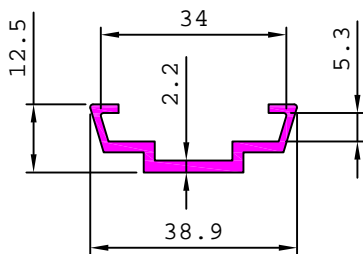

MATCHING SECTION 22531

22534 0.310 kg/m

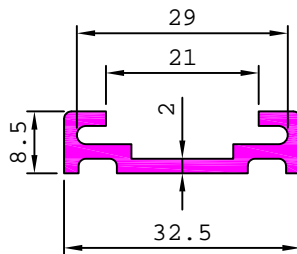

MATCHING SECTION 22530,

22536 0.471 kg/m

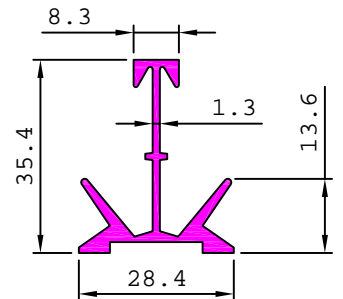

MATCHING SECTION 22537

22537 0.385 kg/m

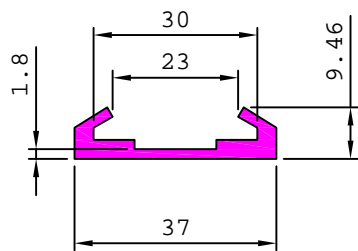

MATCHING SECTION 22536

22569 0.400 kg/m

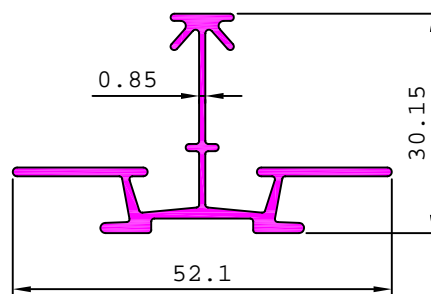

22543 0.190 kg/m

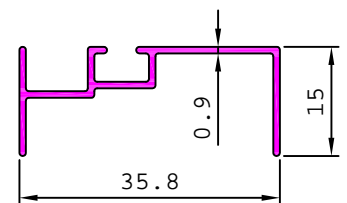

ARCHITECTURAL

EXPANDABLE GRILL

22603

2.911 kg/m

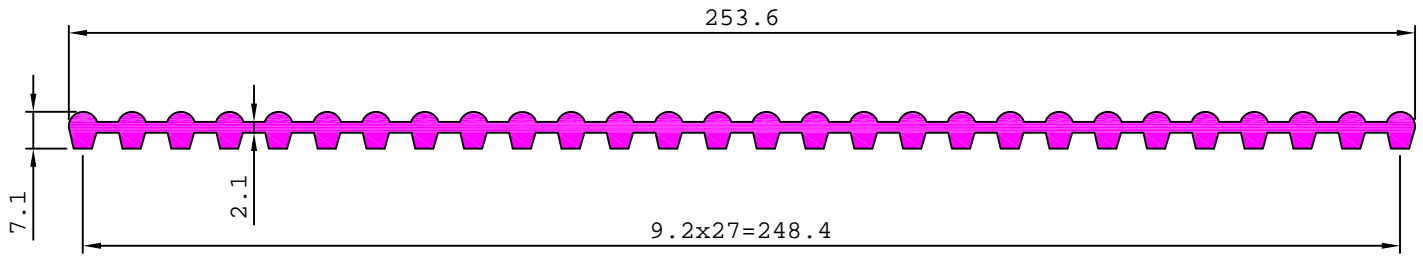

22610

2.608 kg/m

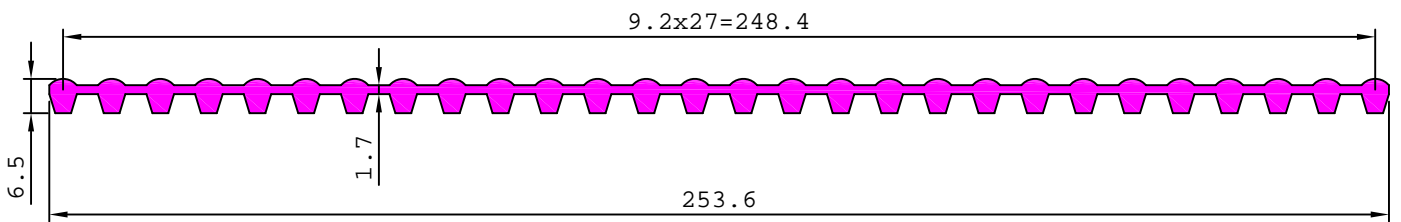

22611

2.795 kg/m

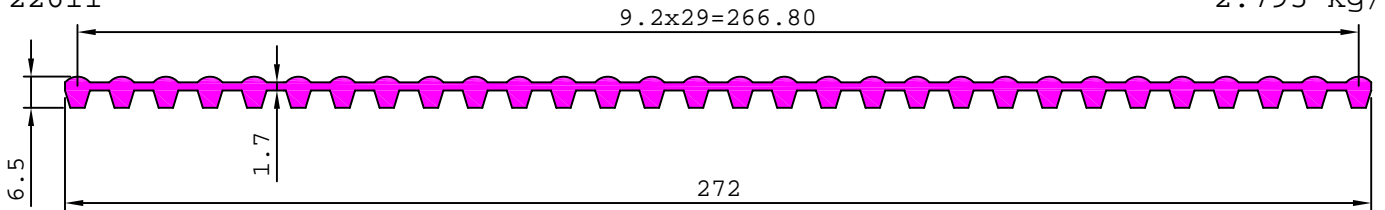

22614

1.597 kg/m

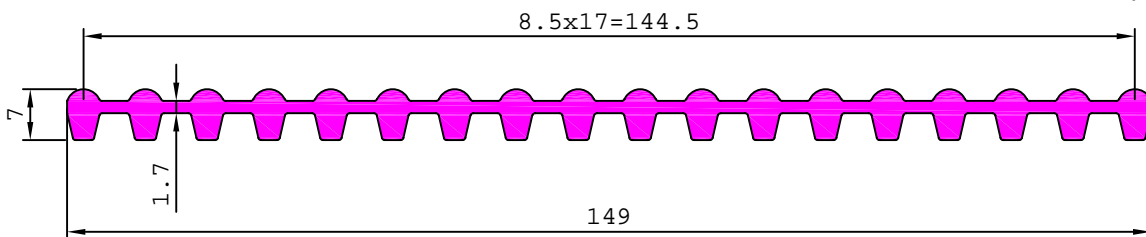

22615

1.776 kg/m

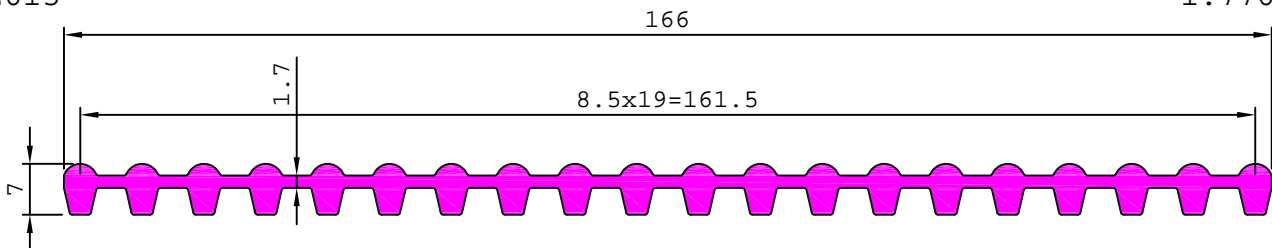

22616

1.956 kg/m

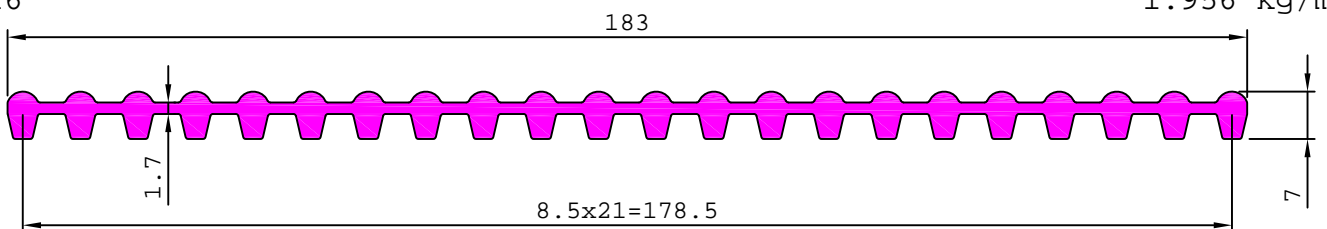

ARCHITECTURAL

EXPANDABLE GRILL

22619

2.226 kg/m

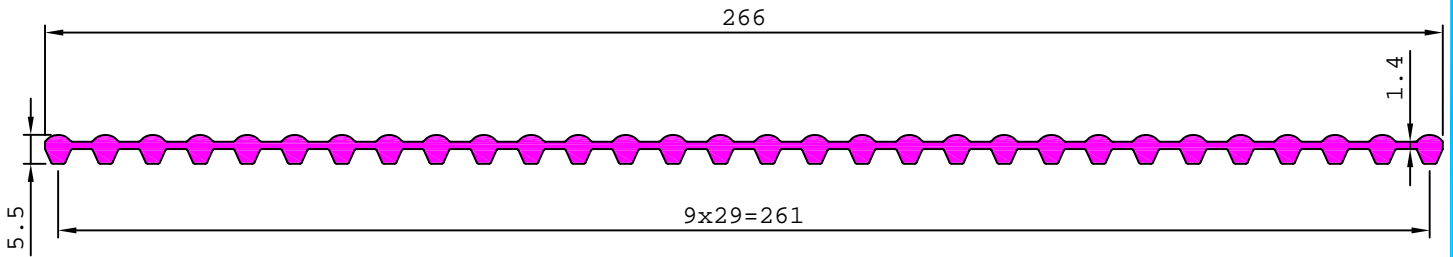

22620

2.408 kg/m

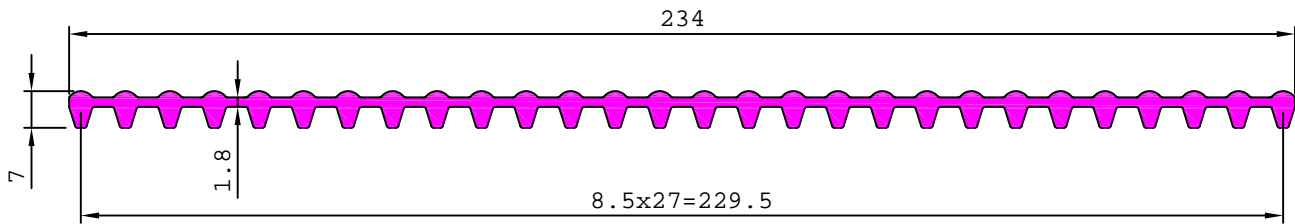

22621

2.581 kg/m

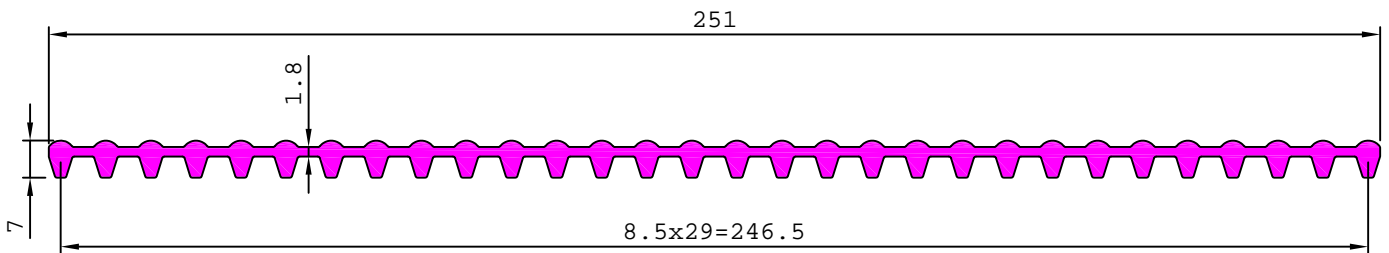

22622

1.930 kg/m

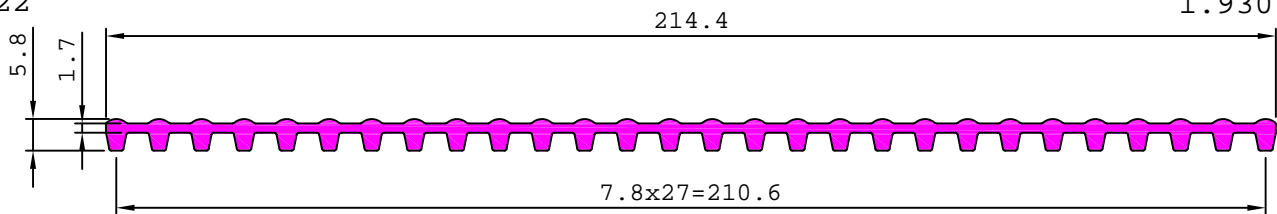

22623

1.470 kg/m

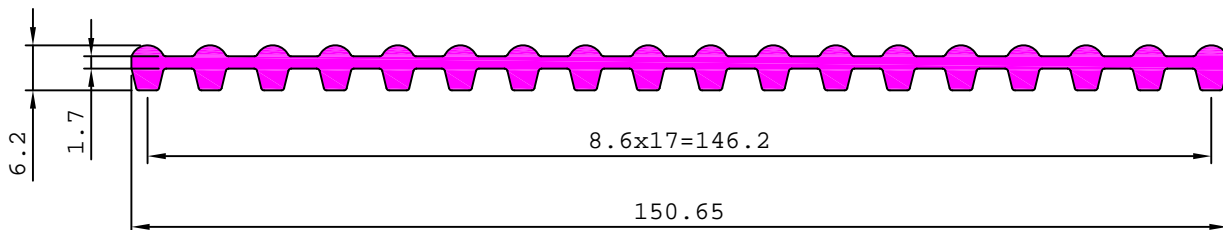

22624

2.208 kg/m

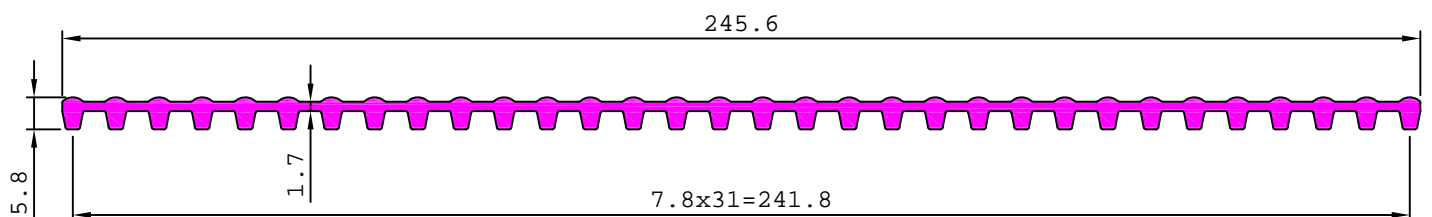

ARCHITECTURAL

EXPANDABLE GRILL

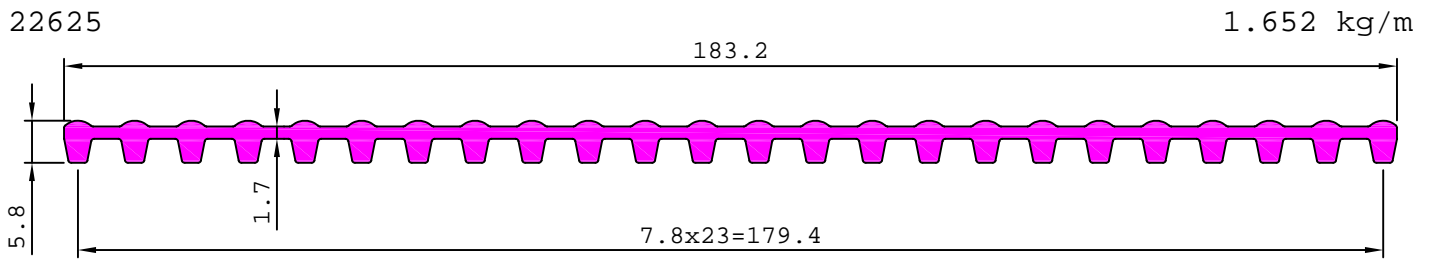

ARCHITECTURAL

TURN BUTTONS

22652

0.563 kg/m

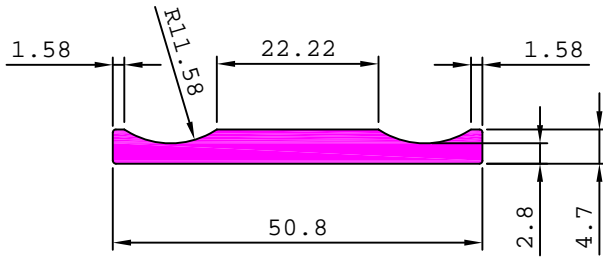

ARCHITECTURAL

CURTAIN WALL SECTION

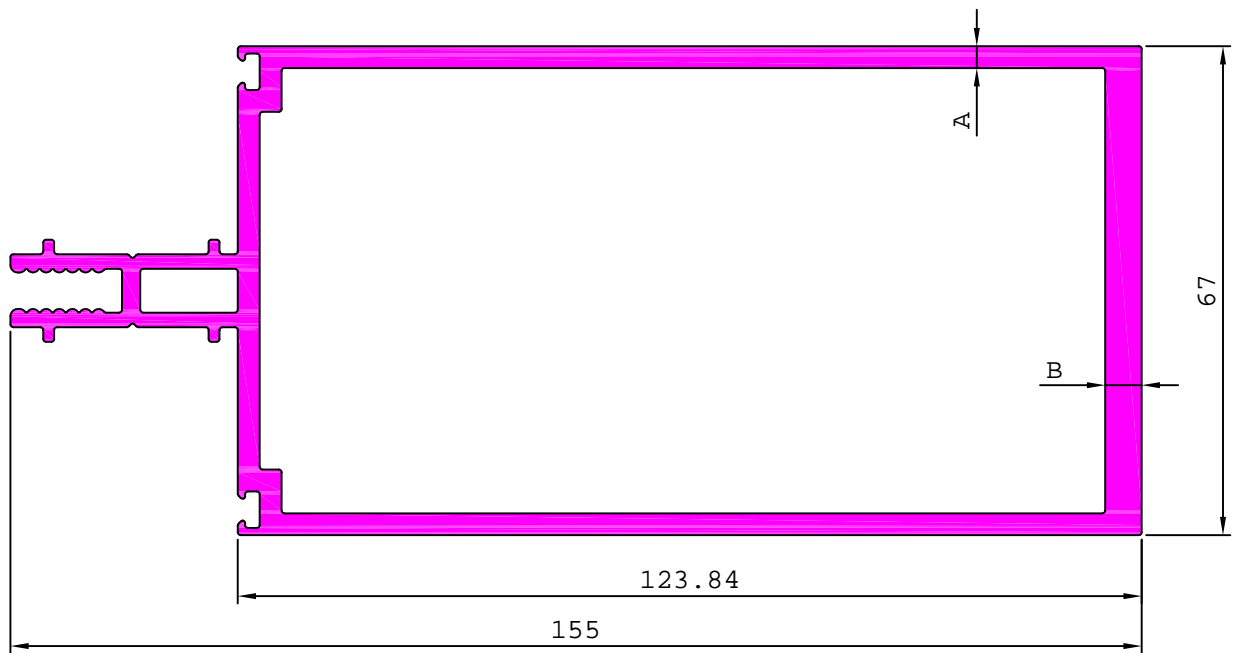

SL No	SECTION No	A	B	WEIGHT kg/m
1	35501	3.00	5.00	3.781
2	35504	2.50	2.50	2.966

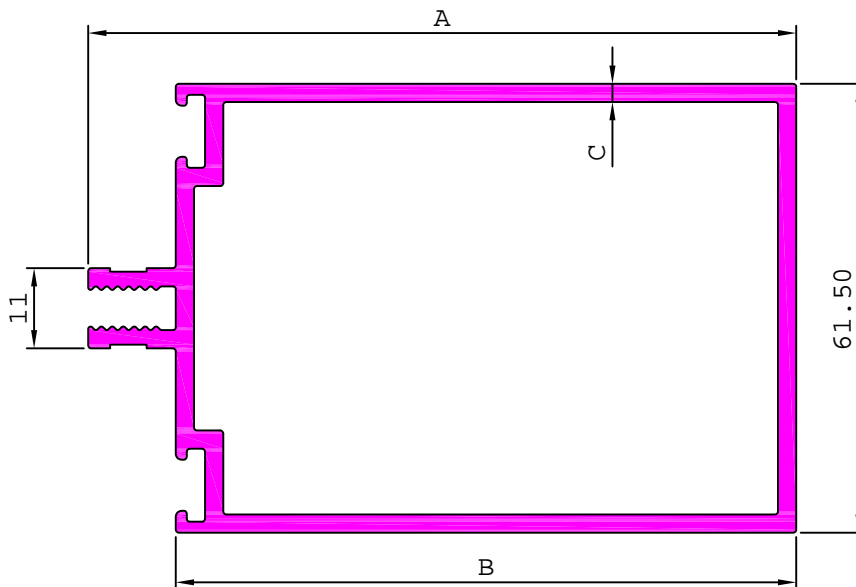

SL No	SECTION No	A	B	C	WEIGHT kg/m
1	35505	82.00	70.00	2.00	1.595
2	35506	97.00	85.00	2.50	2.128

ARCHITECTURAL

CURTAIN WALL SECTION

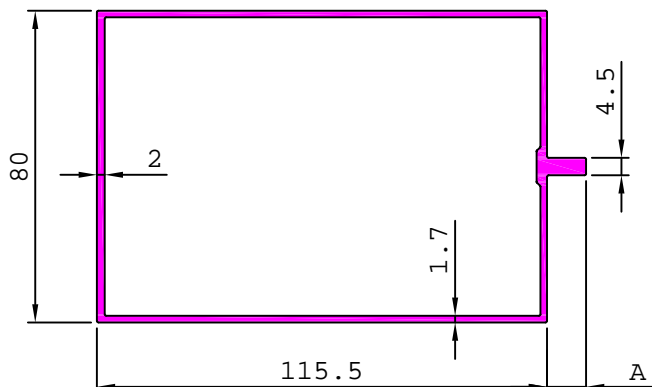

SL. No.	Section No.	A	Weight kg/m
1	22819	10.00	1.971
2	22820	21.50	2.111

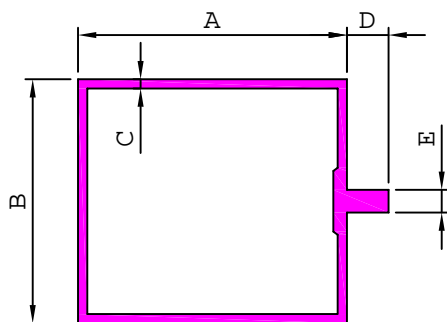

SL. No.	Section No.	A	B	C	D	E	Weight kg/m
1	22719	63.50	63.50	2.50	5.00	5.00	1.755
2	22796	64.00	58.00	1.63	5.00	5.00	1.126
3	22716	64.00	58.00	2.00	10.00	5.00	1.450
4	29231	64.00	58.00	1.50	10.00	3.00	1.081
5	35704	64.00	58.00	1.70	5.00	5.00	1.197
6	22735	64.00	58.00	1.70	10.00	5.00	1.264
7	35535	80.00	60.00	2.00	21.50	4.50	1.754
8	22718	114.30	63.50	2.50	5.00	5.00	2.440

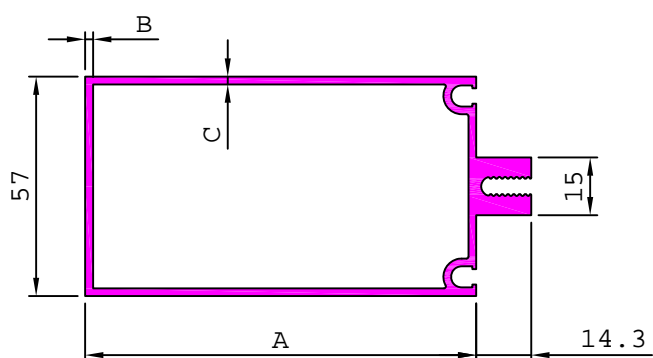

SL. No.	Section No.	A	B	C	Weight kg/m
1	22715	64.00	2.00	2.00	1.777
2	22713	101.60	2.10	2.00	2.187
3	22702	101.60	3.00	2.50	2.664
4	22714	101.60	4.00	3.00	3.124

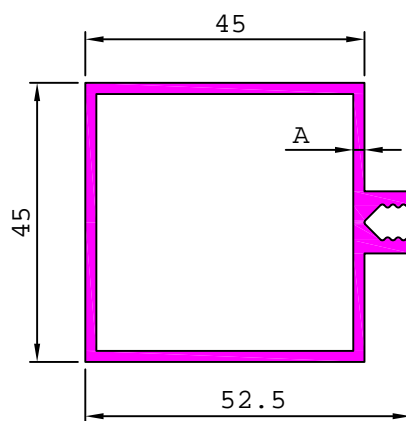

SL. No.	Section No.	C	Weight kg/m
1	22754	1.40	0.765
2	22717	1.80	0.951

ARCHITECTURAL

CURTAIN WALL SECTION

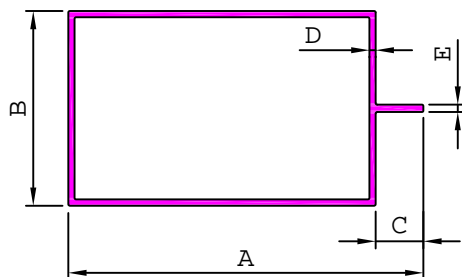

SL. No.	Section No.	A	B	C	D	E	Weight kg/m
1	35587	55.00	50.00	5.00	1.40	1.40	0.754
2	35586	69.00	58.00	5.00	1.40	1.40	0.920
3	35752	74.00	67.00	24.00	1.50	3.00	1.119
4	35871	85.50	51.00	5.00	1.64	1.95	1.162
5	35551	86.00	50.00	6.00	1.90	1.80	1.324
6	35544	86.00	50.00	6.00	2.85	1.80	1.942
7	35862	86.00	50.00	6.00	3.00	2.80	2.054
8	35548	86.50	50.00	26.50	3.00	2.00	1.498
9	35512	91.50	57.00	28.00	2.25	6.00	1.863
10	22753	93.00	51.00	12.50	1.64	1.95	1.201
11	22764	112.00	55.00	12.00	2.00	2.00	1.696
12	35565	134.30	63.50	20.00	2.50	3.00	2.494
13	35648	150.00	57.00	10.00	3.00	5.00	2.506
14	22776	160.00	50.00	10.00	2.00	2.00	2.171
15	35750	160.16	67.00	24.00	2.00	3.00	2.346
16	22785	175.00	50.00	25.00	2.00	2.00	2.252
16	S4206	190.00	50.00	10.00	3.00	5.00	3.764

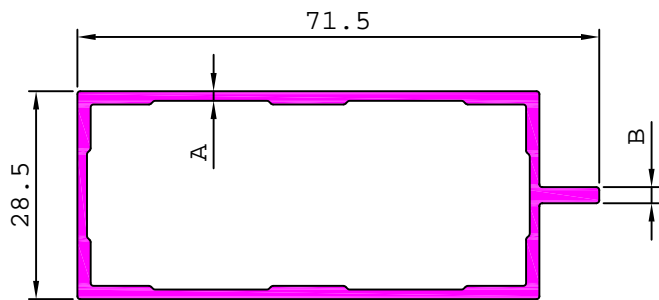

SL. No.	Section No.	A	B	Weight kg/m
1	35861	0.80	1.10	0.484
2	22786	1.10	1.40	0.634
3	22768	1.32	2.20	0.796

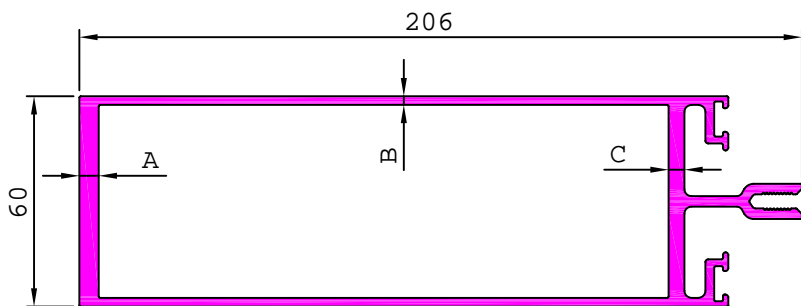

SL. No.	Section No.	A	B	C	Weight kg/m
1	22822	2.00	2.00	2.00	3.270
2	22821	5.50	2.50	4.50	4.616

ARCHITECTURAL

CURTAIN WALL SECTION

21017

126.4

2.888 kg/m

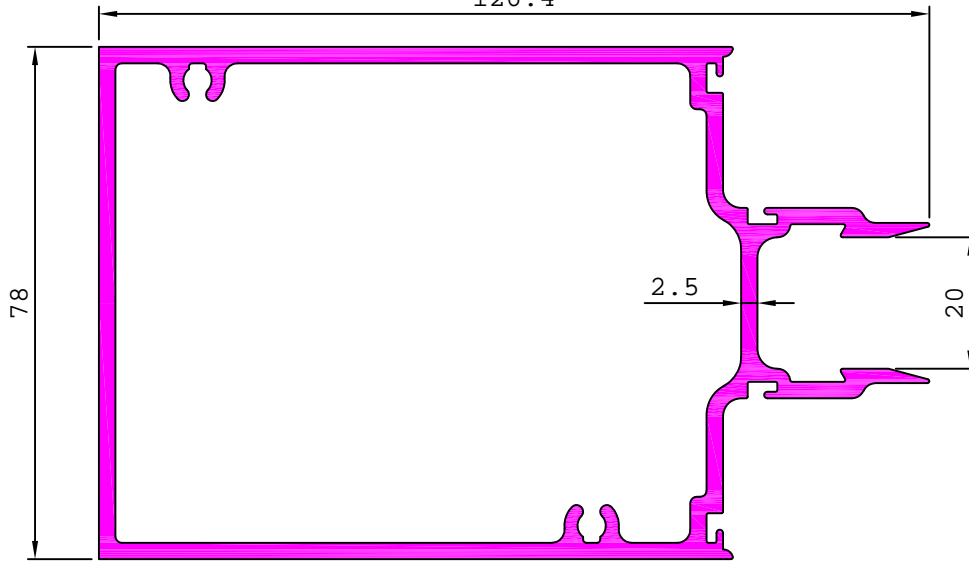

22703

1.751 kg/m

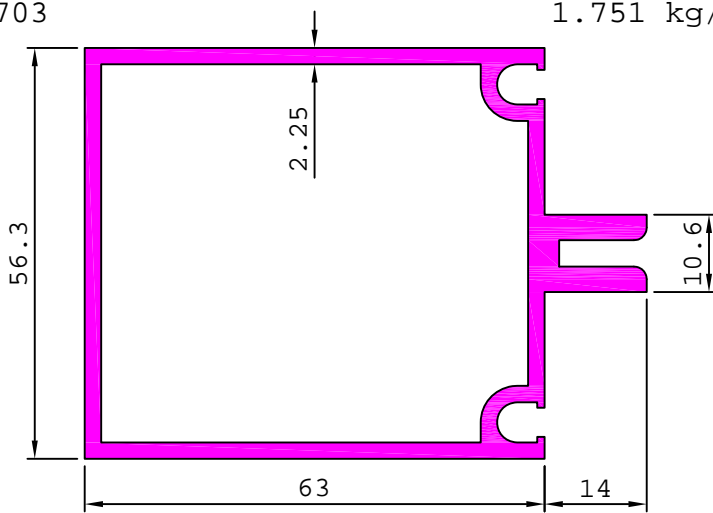

22704

0.245 kg/m

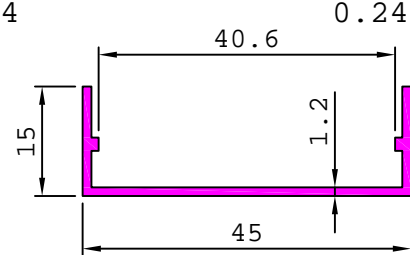

22706

0.529 kg/m

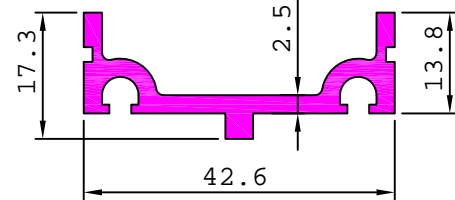

22705

1.915 kg/m

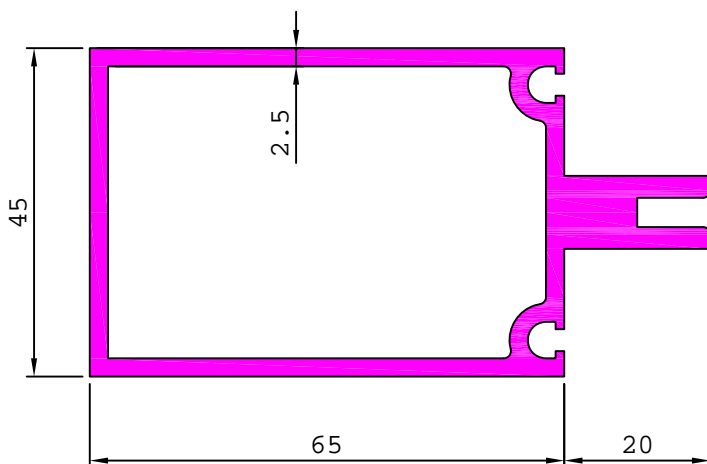

22707

0.395 kg/m

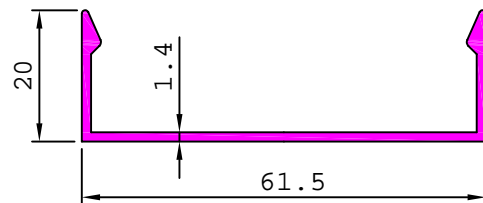

22709

0.536 kg/m

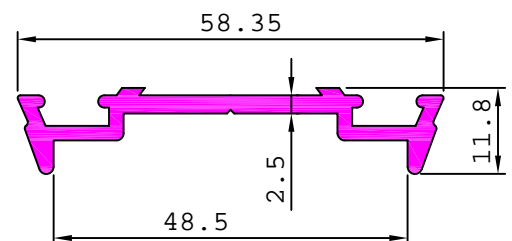

ARCHITECTURAL

CURTAIN WALL SECTION

22710 2.166 kg/m

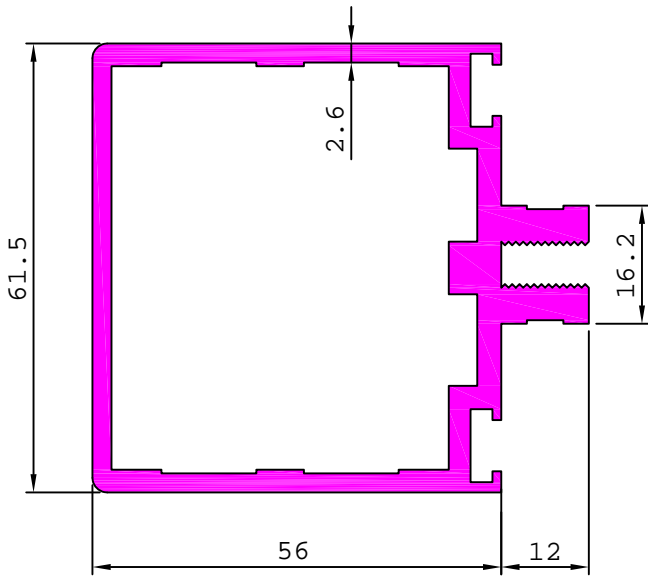

22711 0.434 kg/m

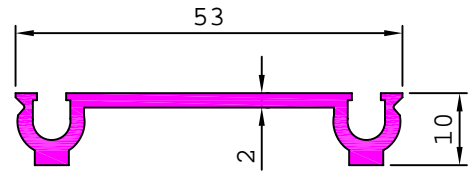

MATCHING WITH 22712

22712 0.343 kg/m

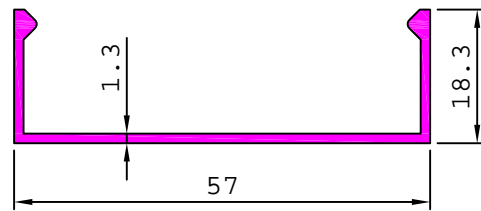

MATCHING WITH 22711

22720 2.341 kg/m

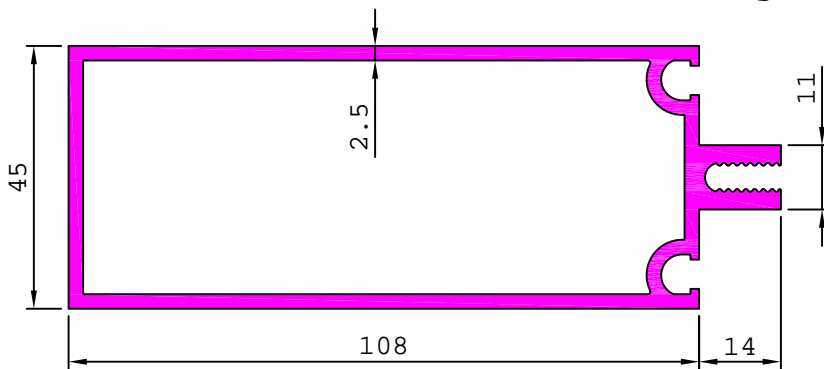

22721 1.946 kg/m

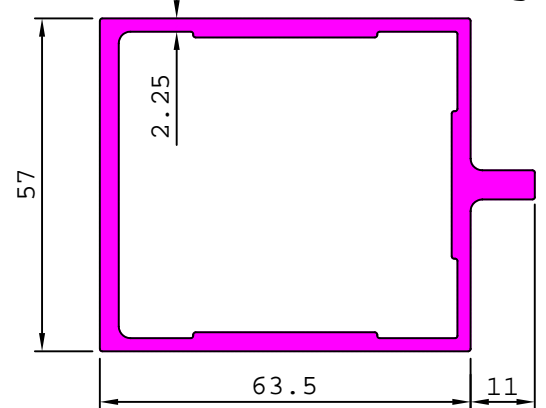

22722 1.965 kg/m

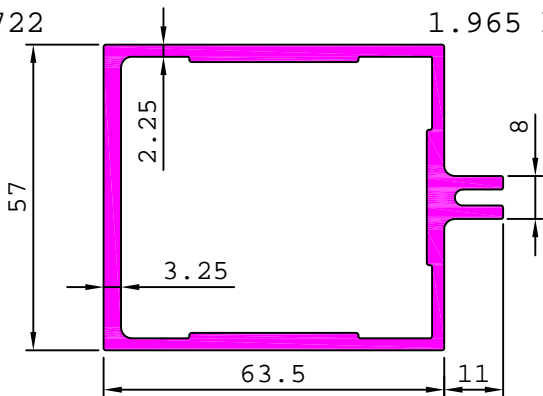

22723 1.144 kg/m

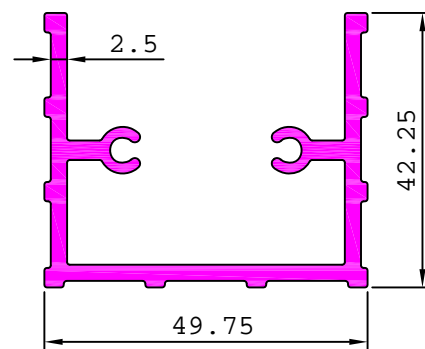

22724 0.279 kg/m

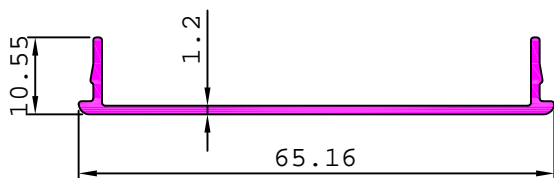

22728 0.366 kg/m

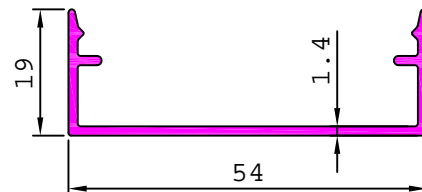

ARCHITECTURAL

CURTAIN WALL SECTION

22725 1.476 kg/m

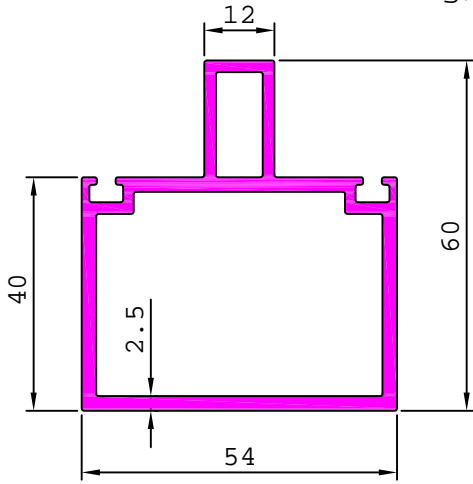

22727 2.286 kg/m

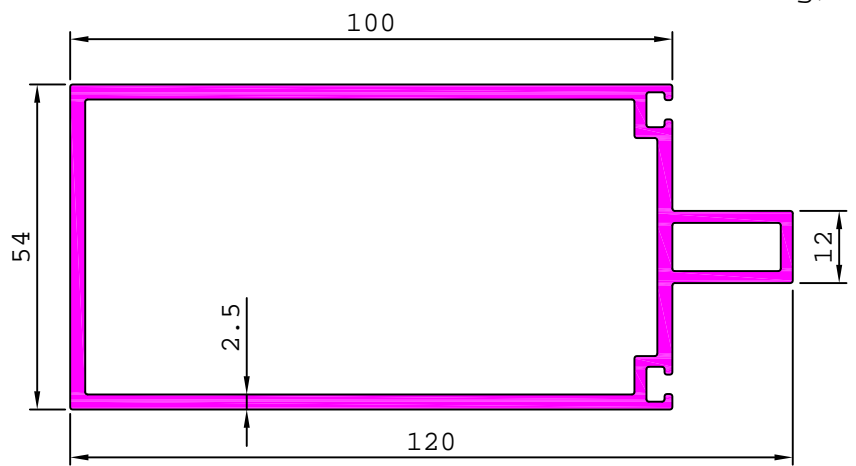

22729 0.441 kg/m

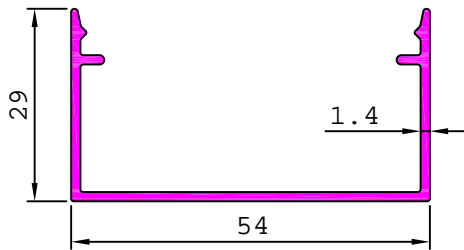

22731 0.527 kg/m

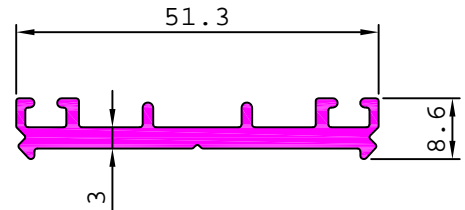

22730 0.820 kg/m

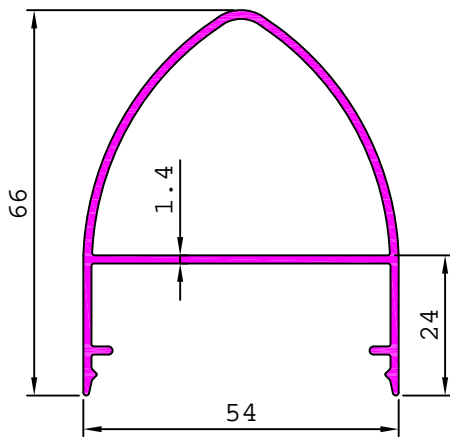

22736 1.615 kg/m

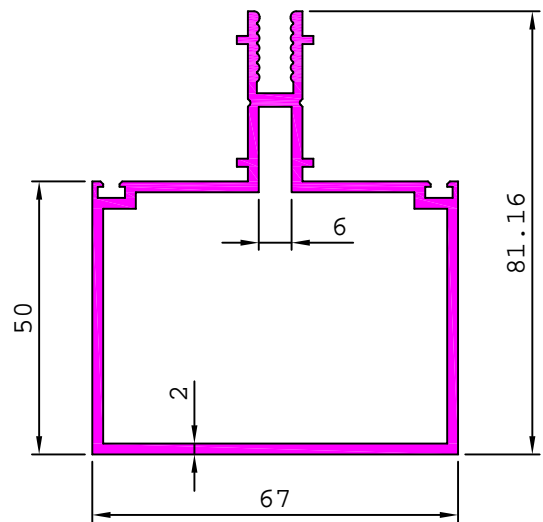

22746 1.607 kg/m

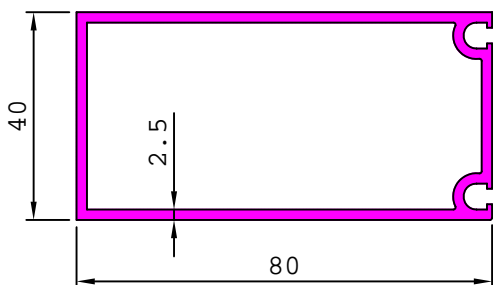

22750 0.792 kg/m

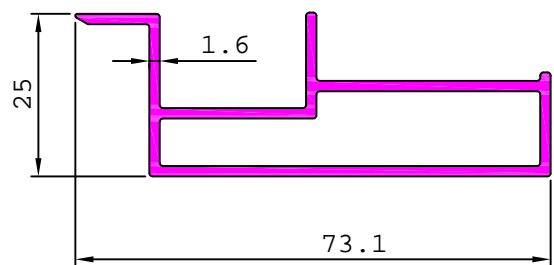

ARCHITECTURAL

CURTAIN WALL SECTION

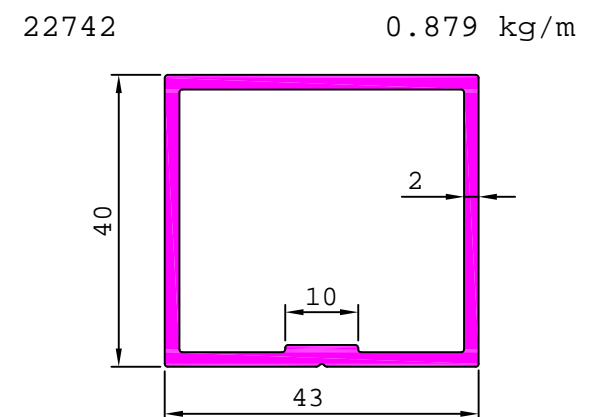
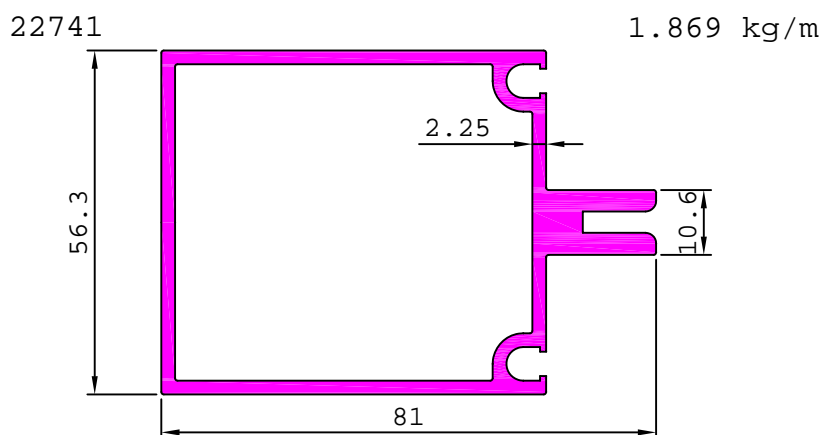
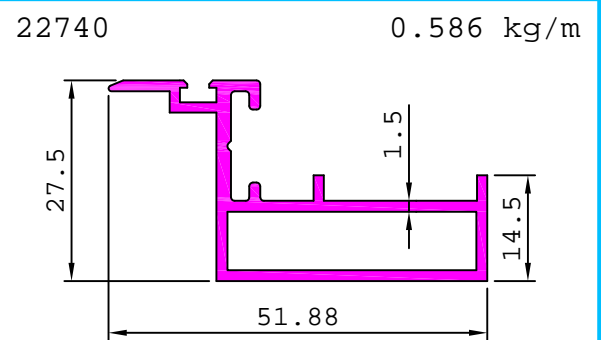
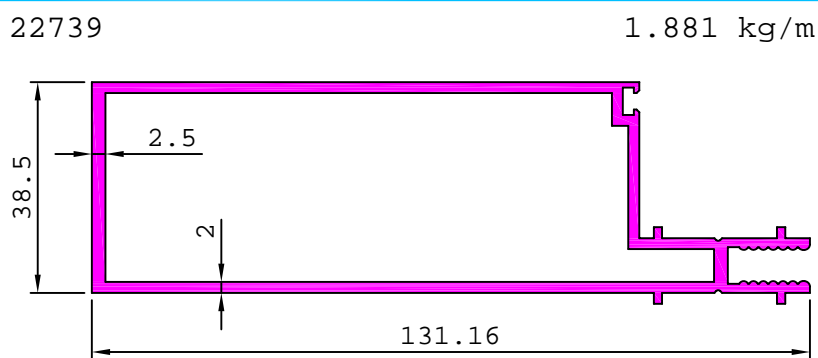
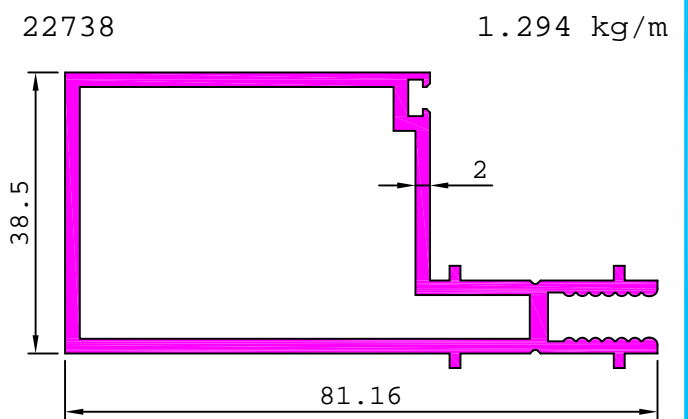
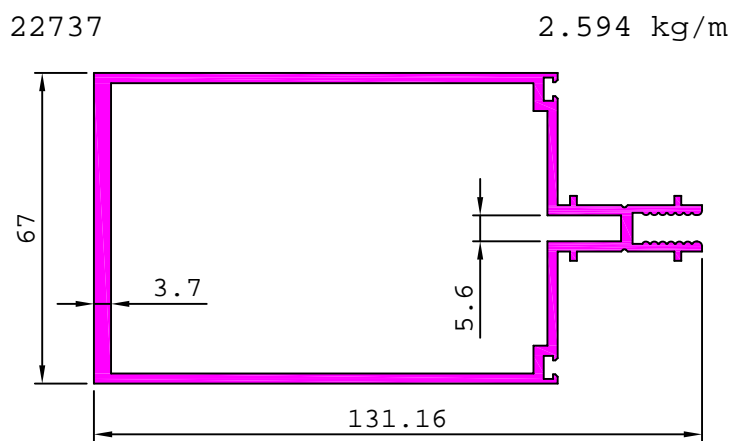
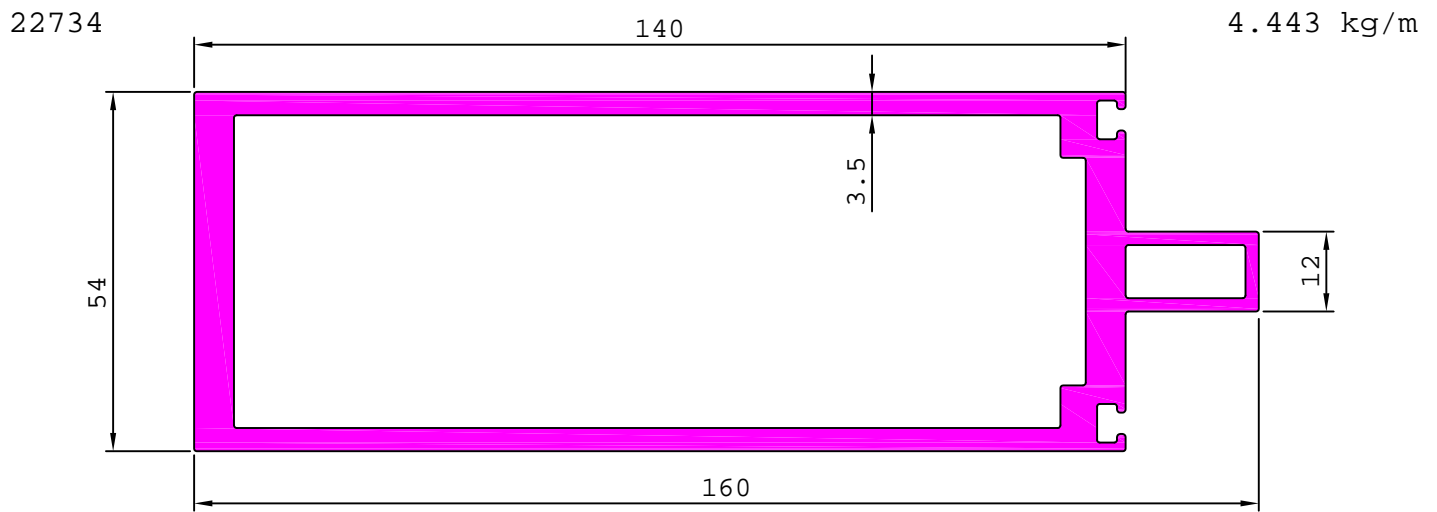

ARCHITECTURAL

CURTAIN WALL SECTION

22743 2.359 kg/m

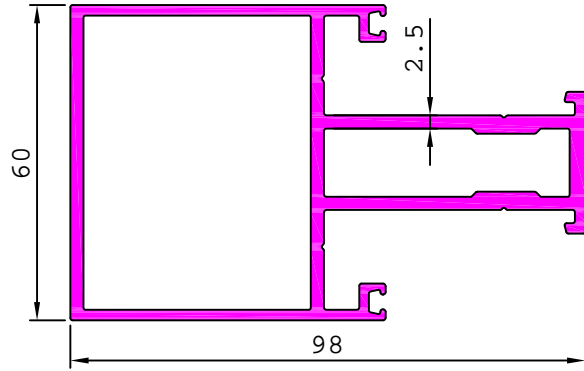

22744 2.553 kg/m

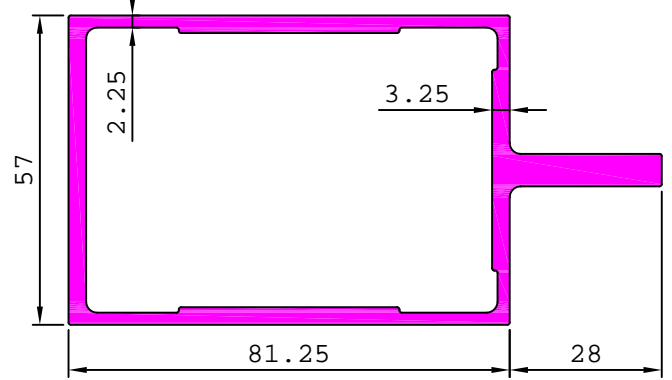

22748 1.701 Kg/m

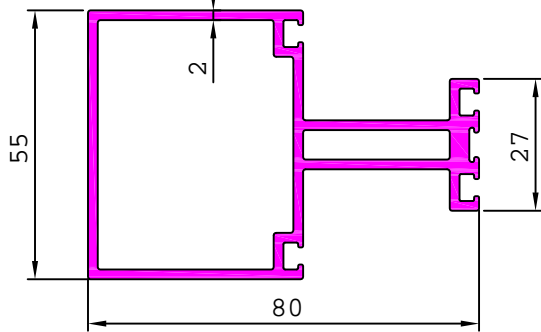

22749 2.783 Kg/m

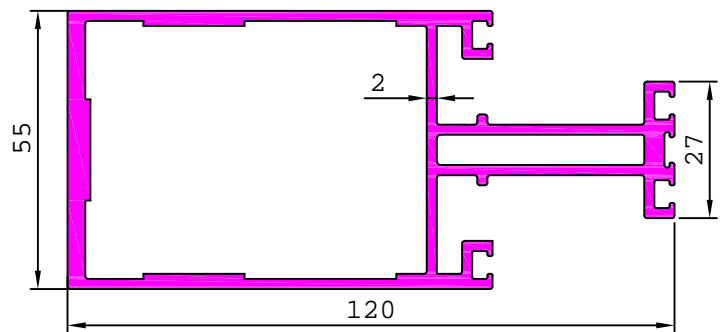

22751 1.402 kg/m

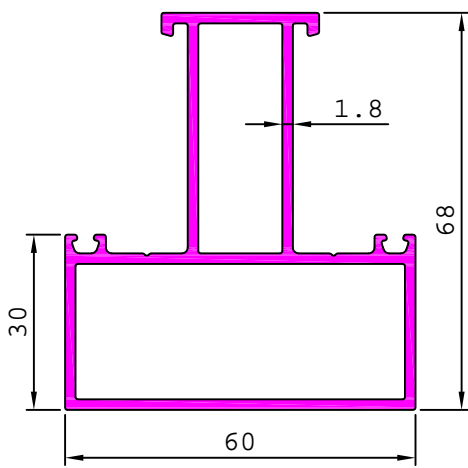

22752 3.389 kg/m

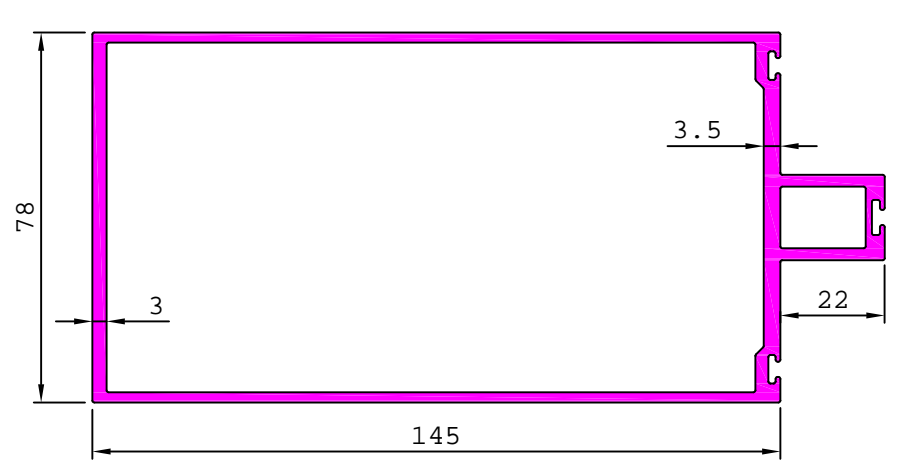

22765 1.254 kg/m

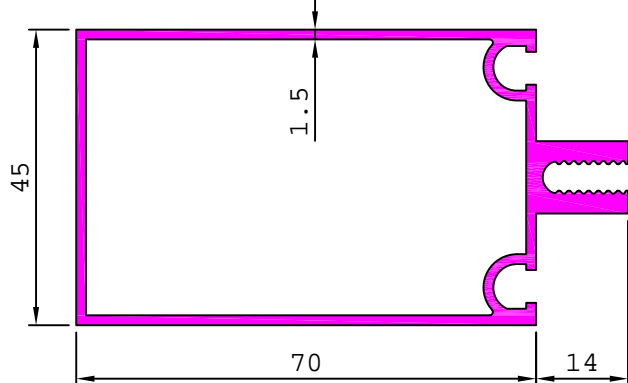

22766 0.906 kg/m

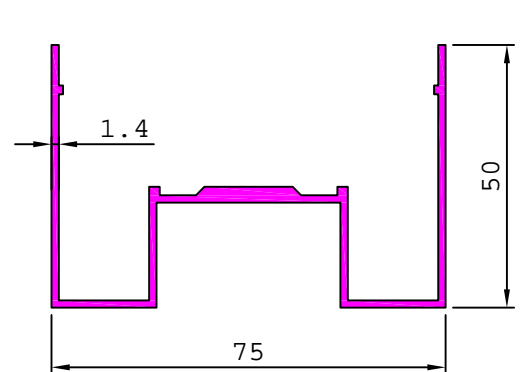

ARCHITECTURAL

CURTAIN WALL SECTION

22767 0.808 kg/m

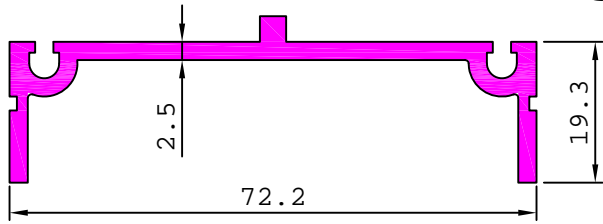

22769 0.243 kg/m

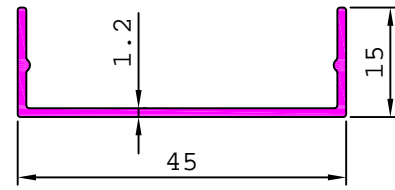

22770 1.391 kg/m

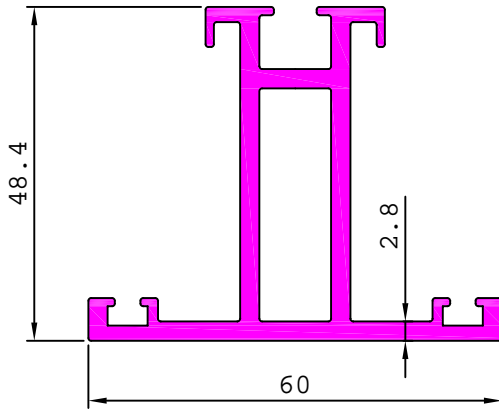

22771 2.147 kg/m

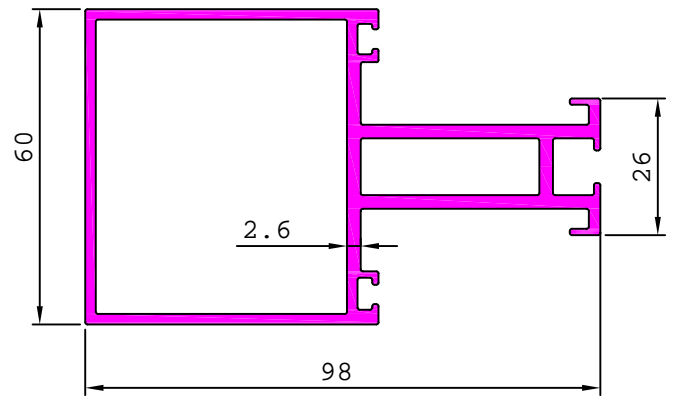

22773 0.318 kg/m

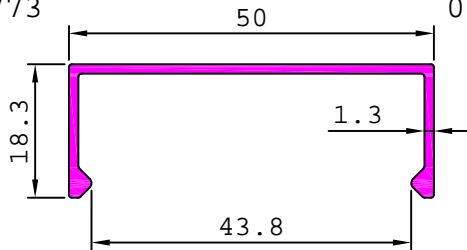

22774 0.404 kg/m

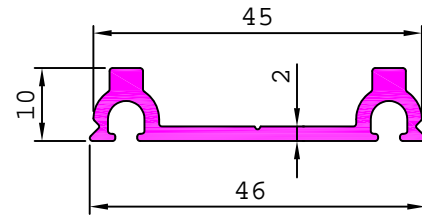

22777 1.889 kg/m

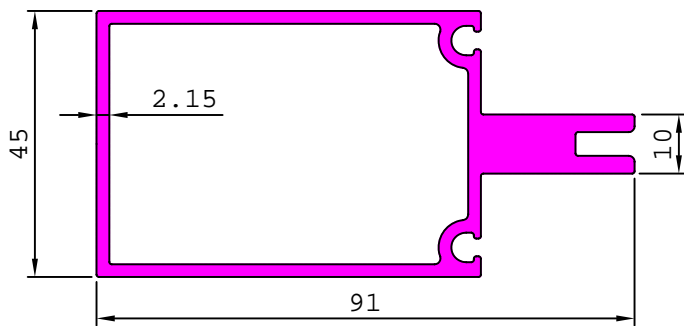

22780 2.023 kg/m

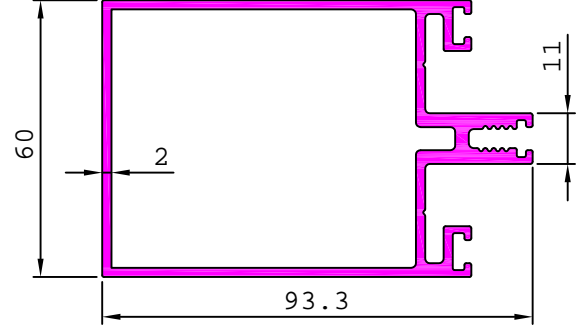

22779 0.387 kg/m

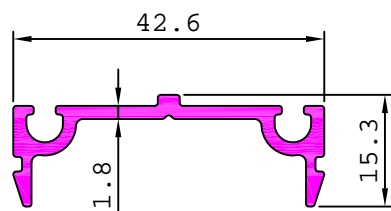

22782 1.532 kg/m

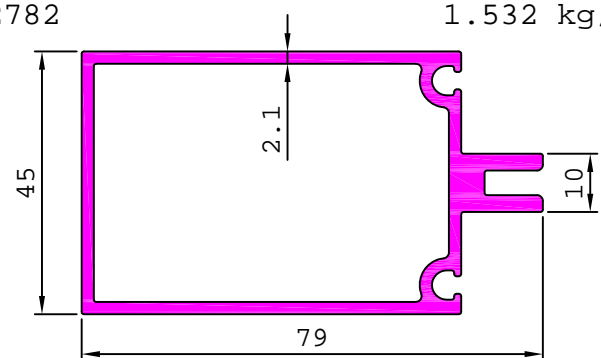

ARCHITECTURAL

CURTAIN WALL SECTION

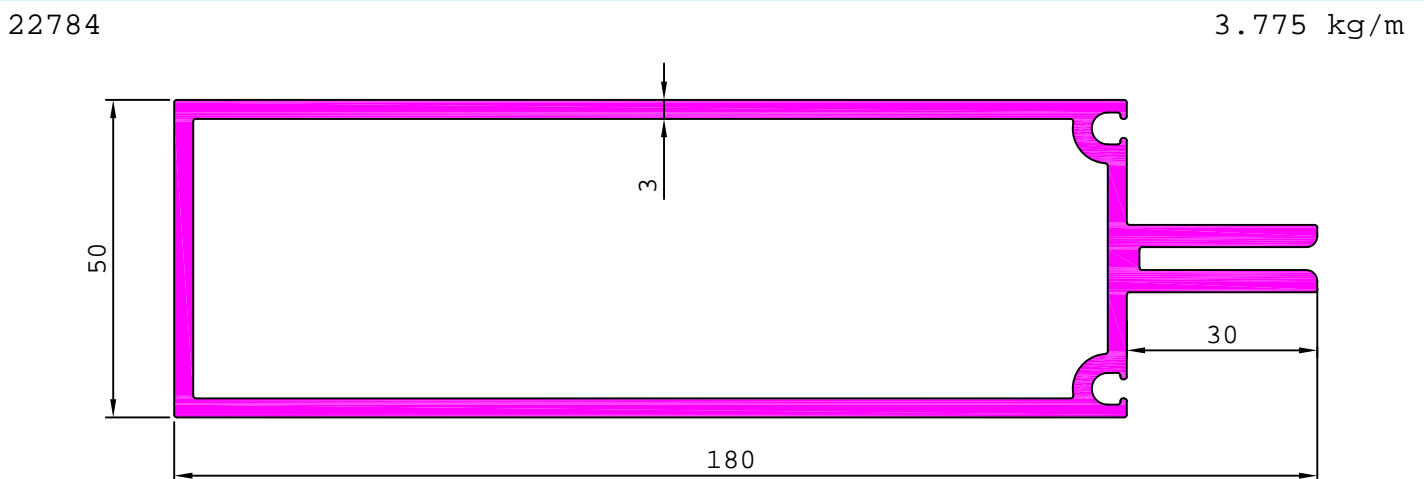
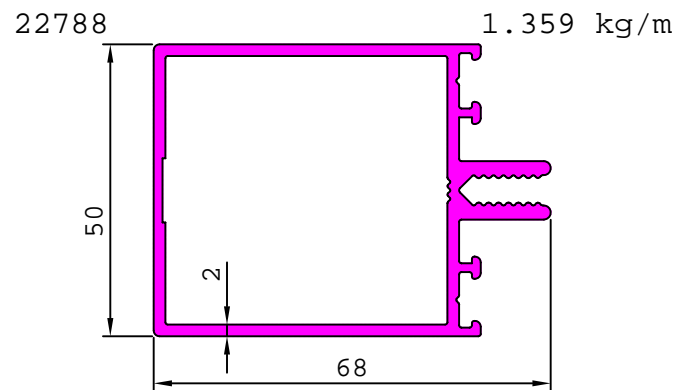
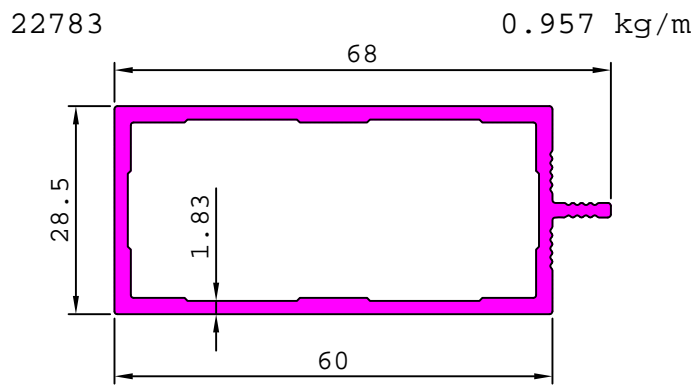
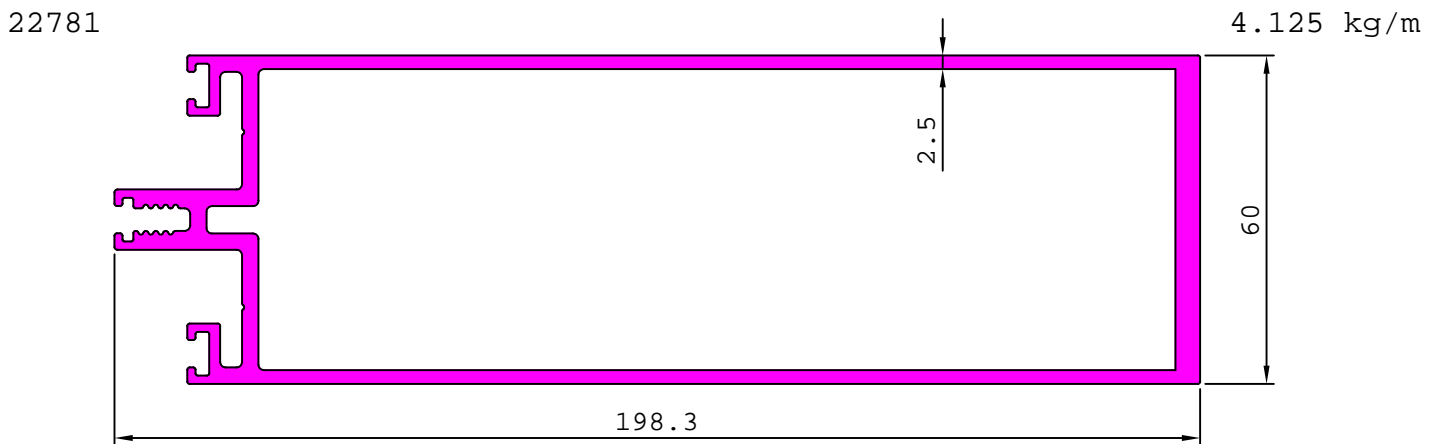
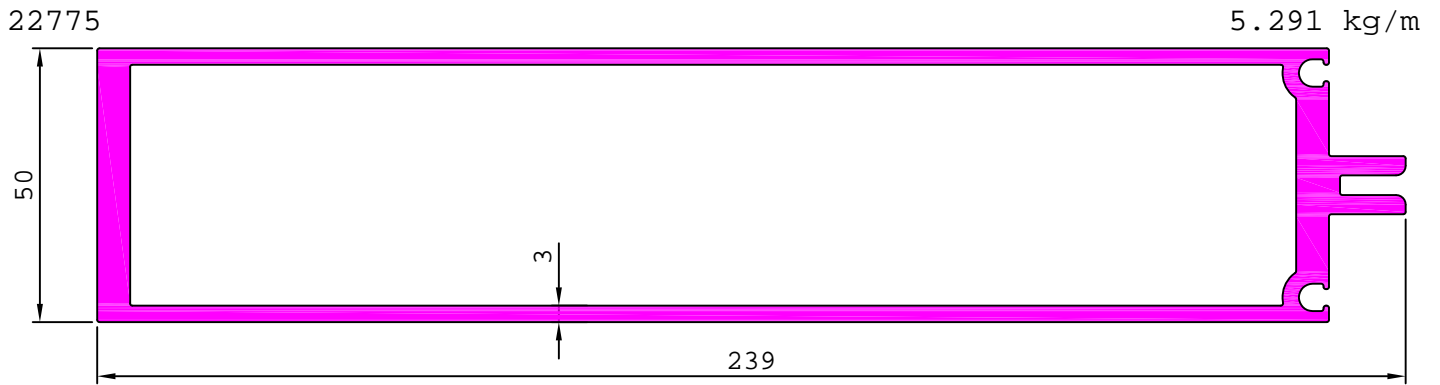

ARCHITECTURAL

CURTAIN WALL SECTION

22787

3.440 kg/m

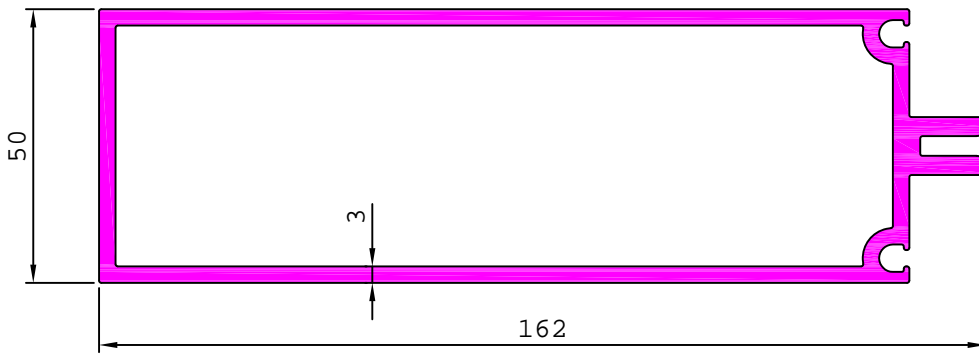

22789

3.548 kg/m

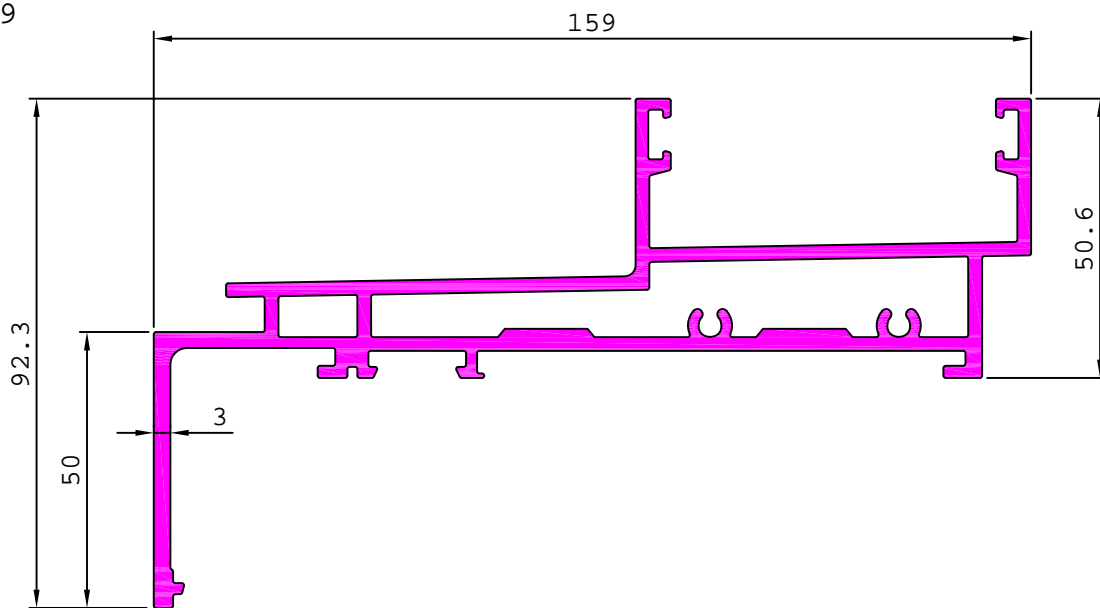

22791

4.580 kg/m

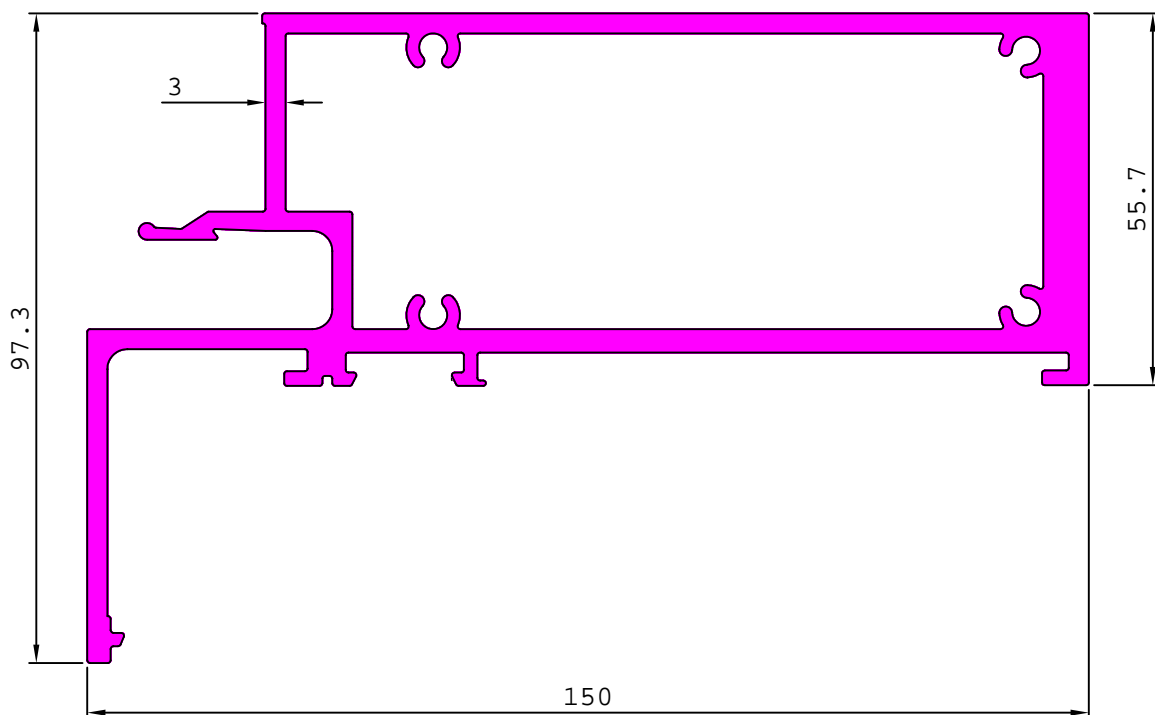

ARCHITECTURAL

CURTAIN WALL SECTION

22790 3.927 kg/m

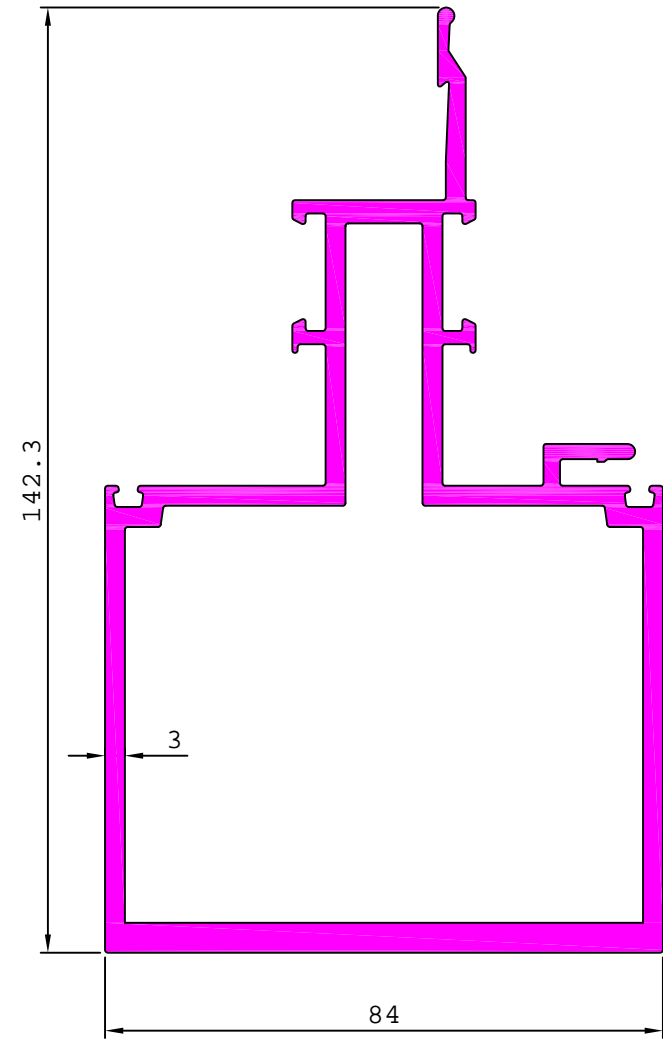

22792 5.308 kg/m

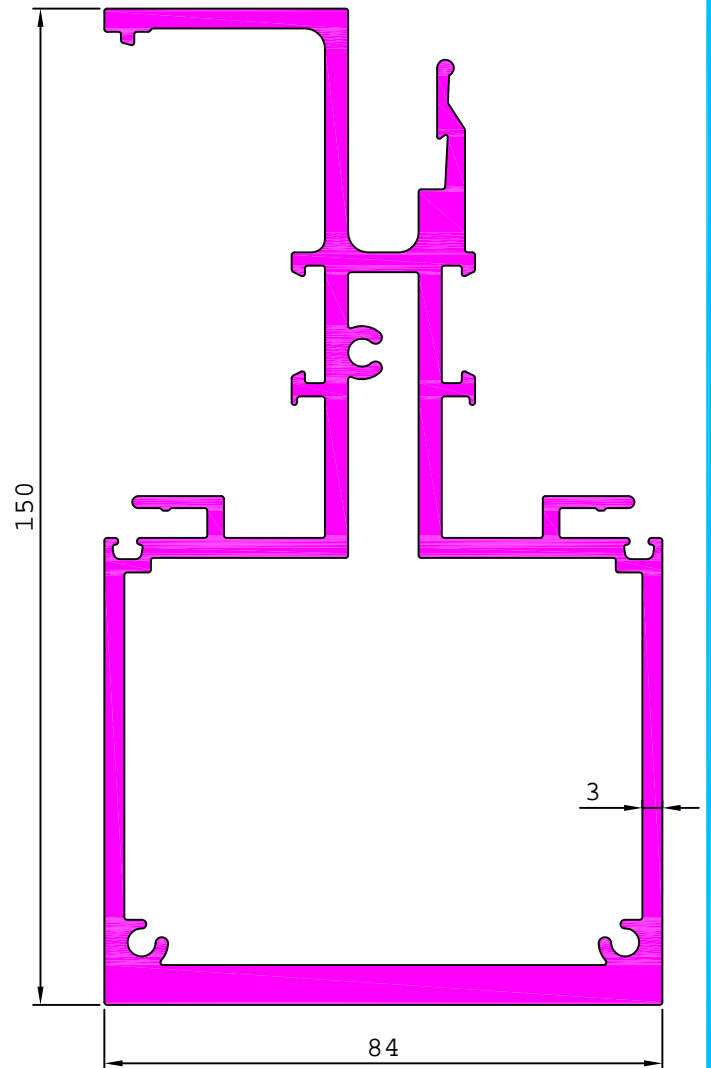

22794 2.399 kg/m

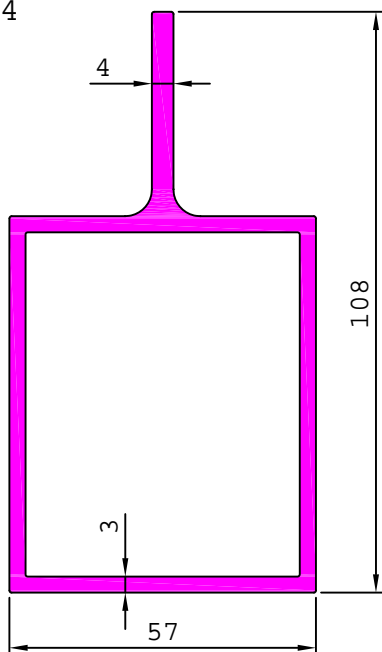

22795 2.921 kg/m

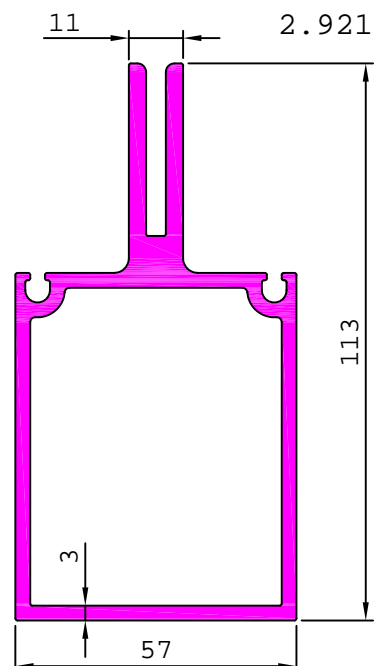

ARCHITECTURAL

CURTAIN WALL SECTION

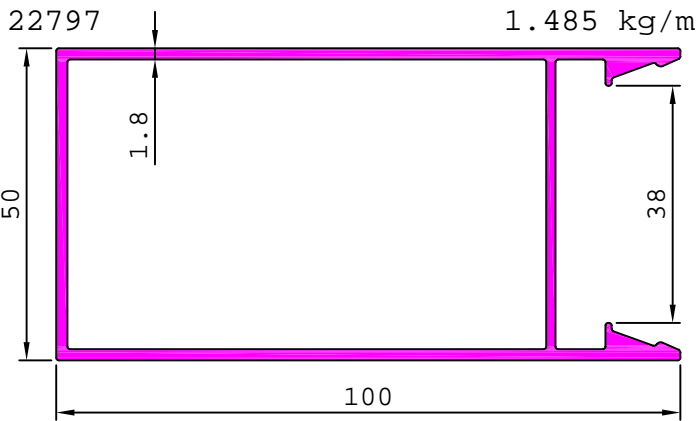

MATCHING SECTION No. 22798

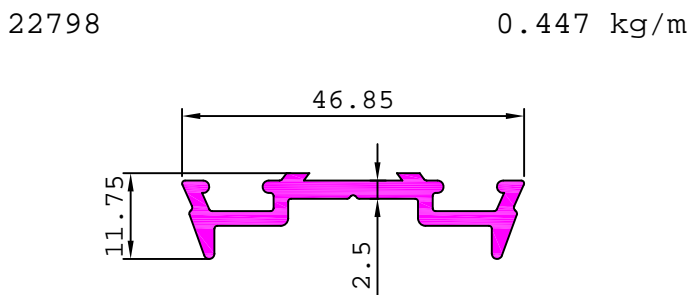
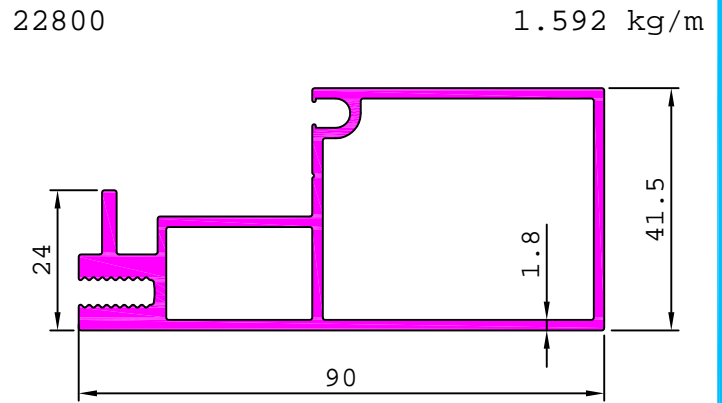

MATCHING SECTION No. 22797

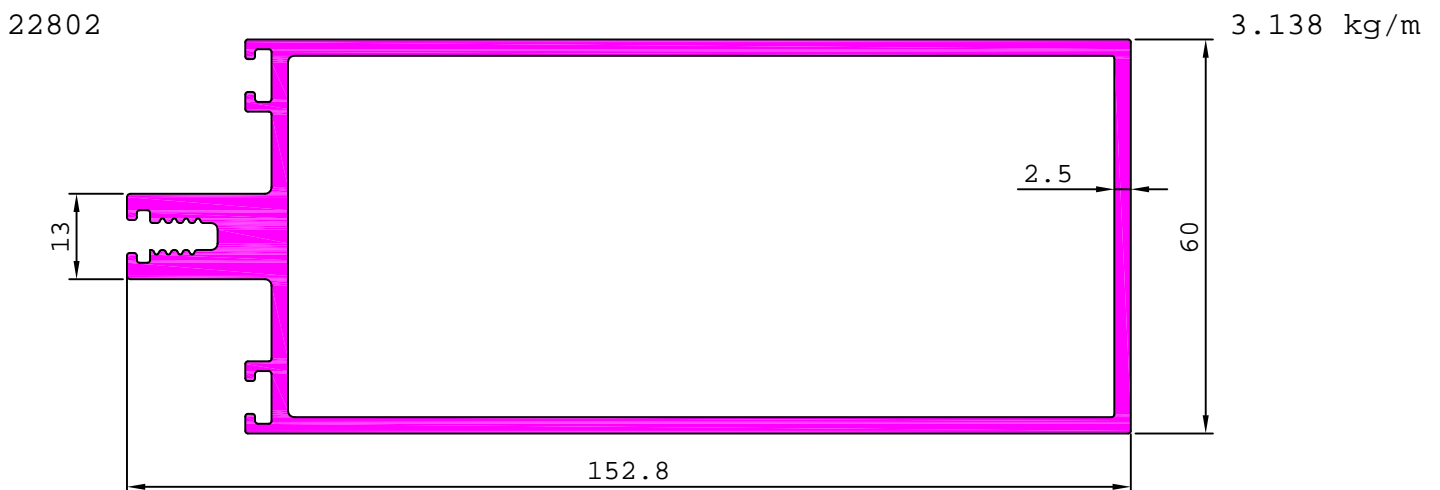
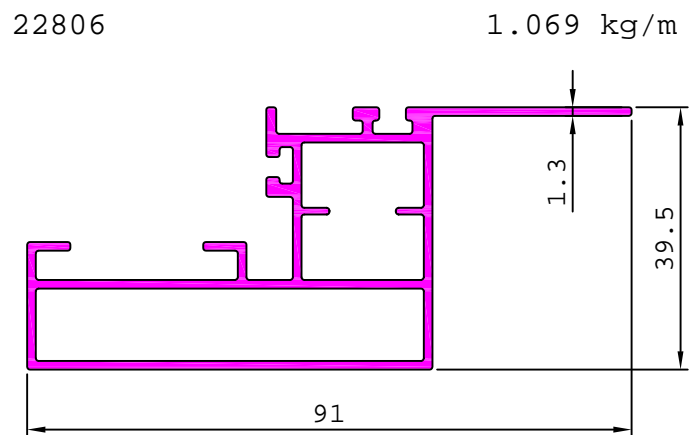
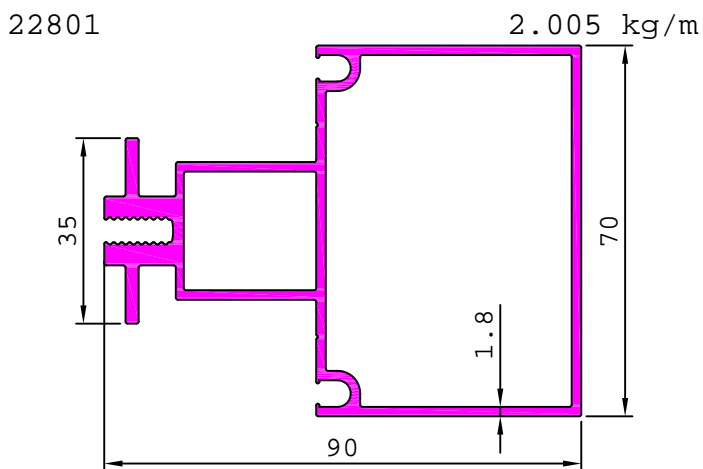
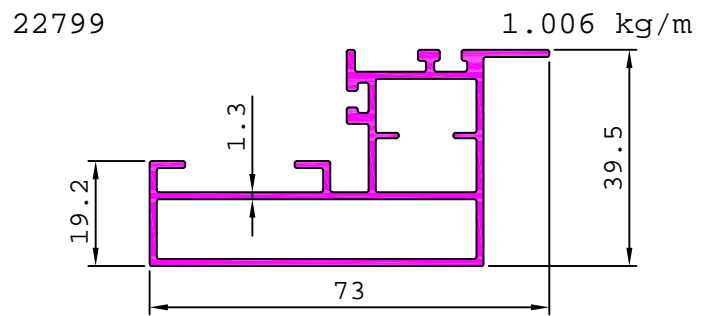

ARCHITECTURAL

CURTAIN WALL SECTION

22803

4.208 kg/m

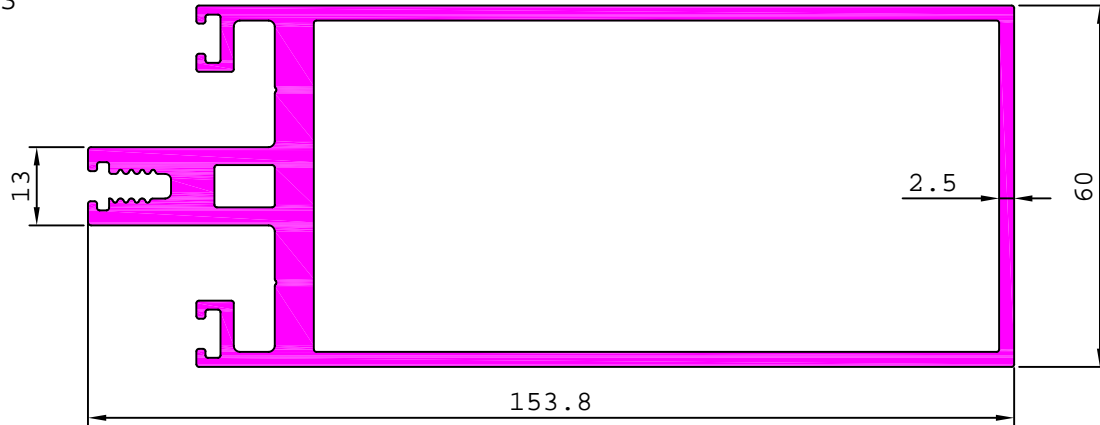

22804

5.626 kg/m

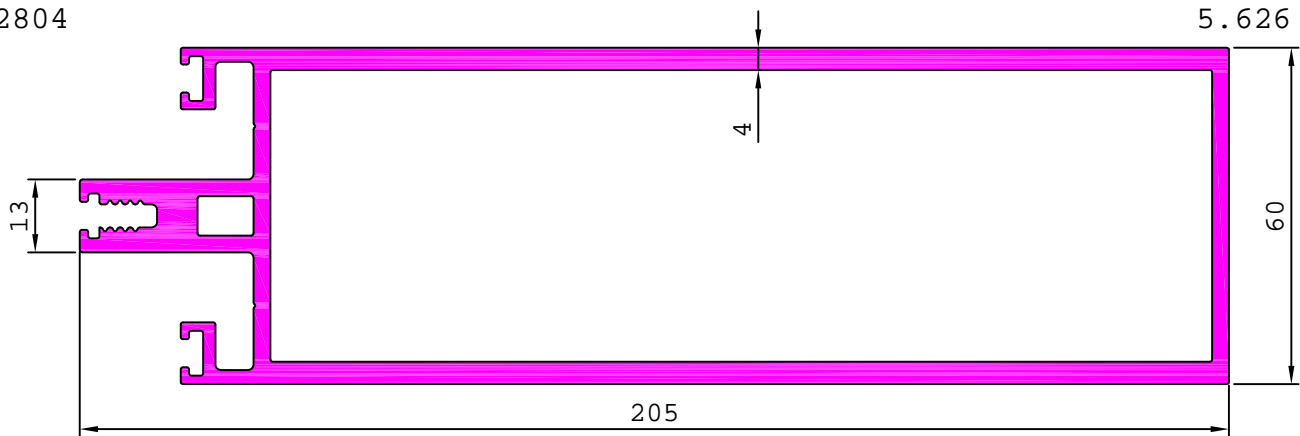

22805

3.874 kg/m

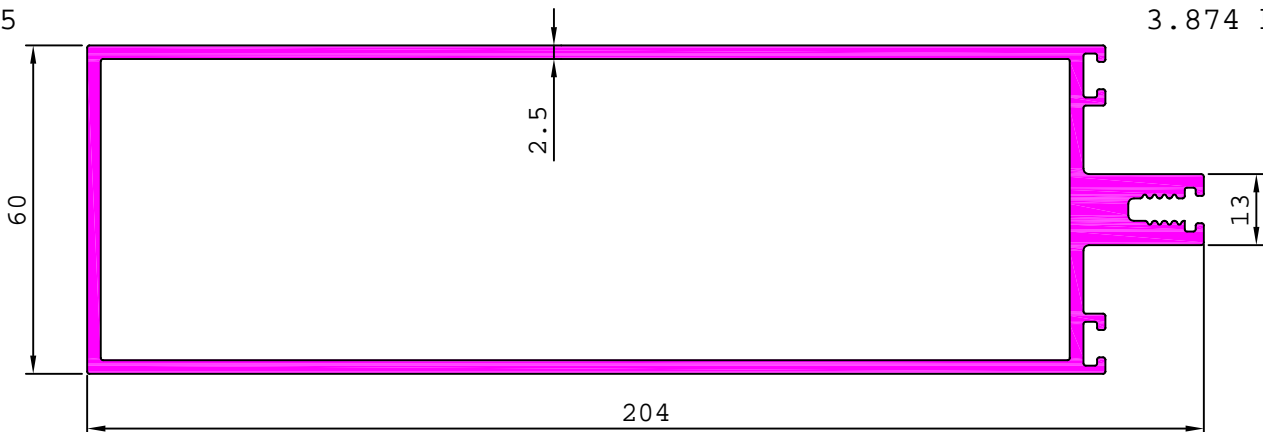

22807

2.595 kg/m

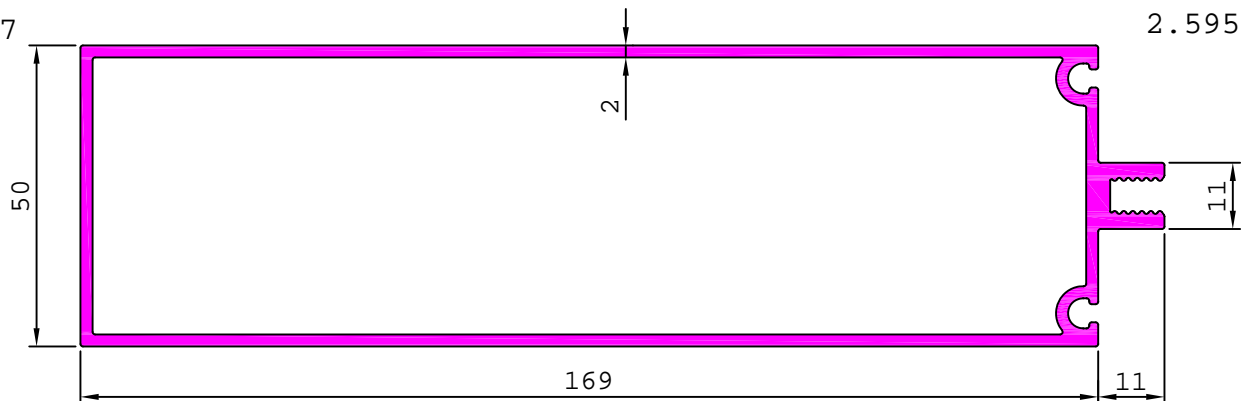

ARCHITECTURAL

CURTAIN WALL SECTION

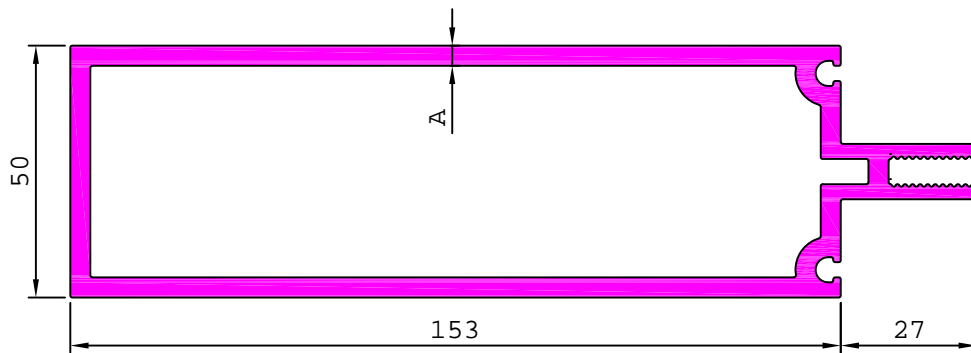
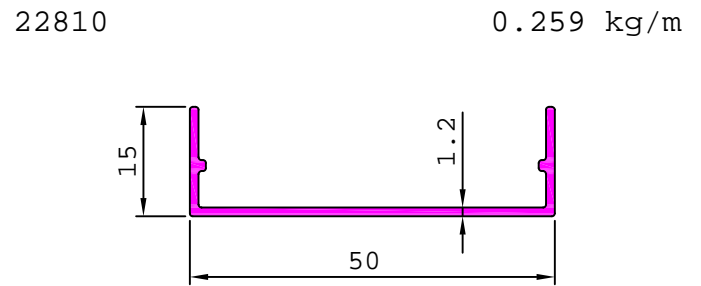
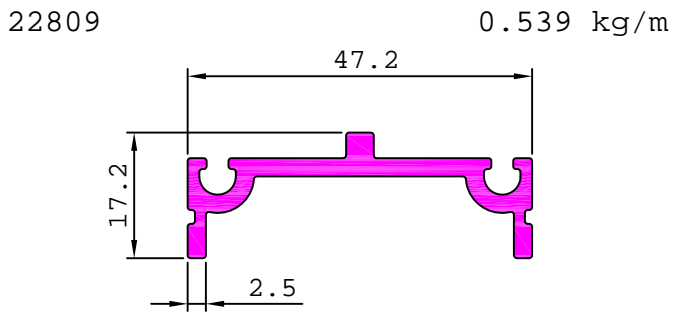
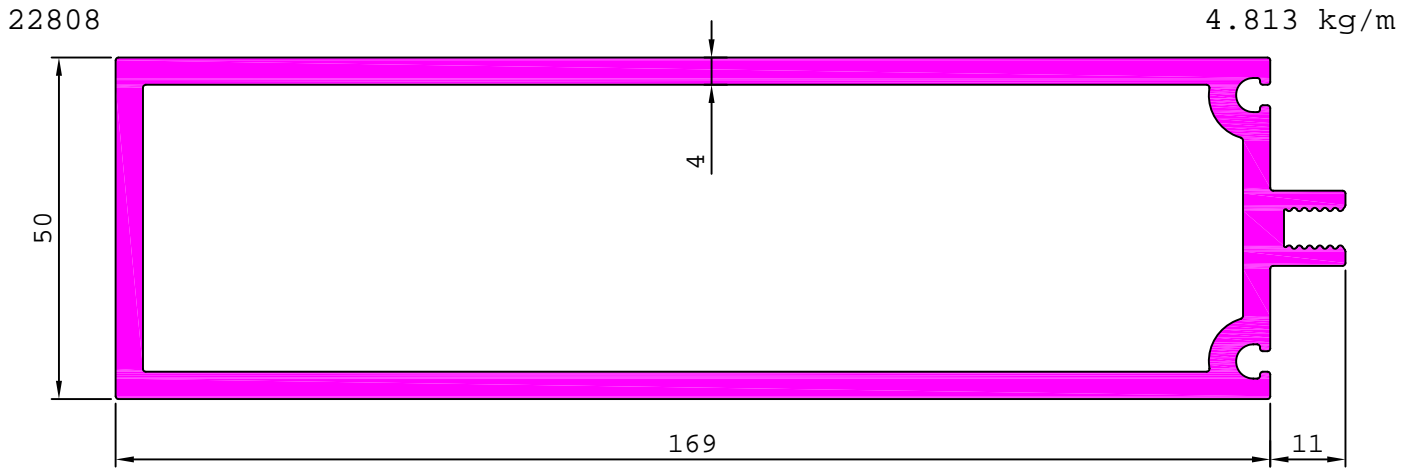

SL. No.	Section No.	A	Weight kg/m
1	22812	2.00	2.656
2	22811	4.00	4.689

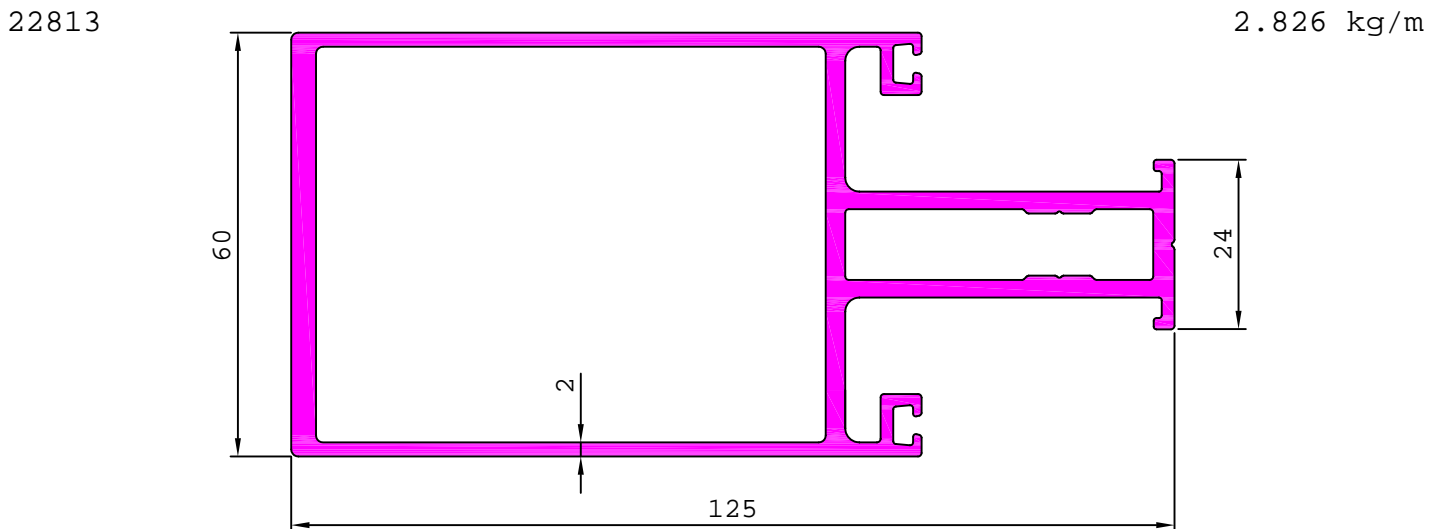

ARCHITECTURAL

CURTAIN WALL SECTION

22814 1.395 kg/m

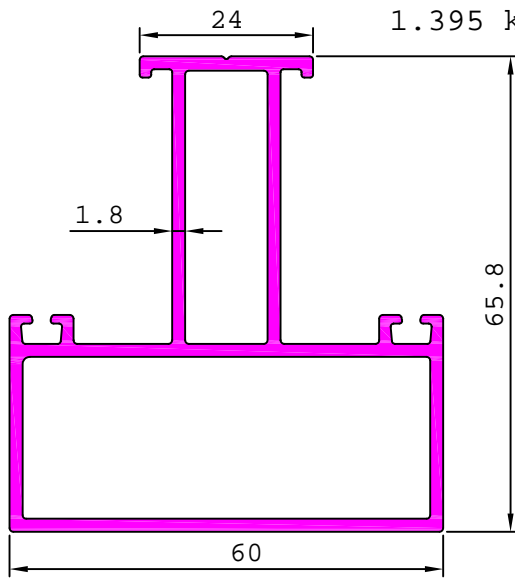

22826 0.618 kg/m

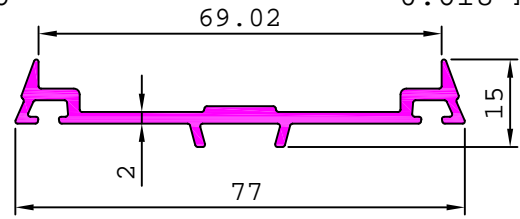

MATCHING WITH 22825

22825 0.528 kg/m

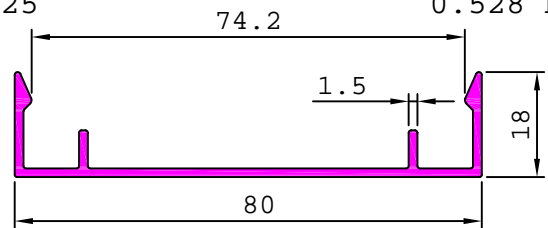

MATCHING WITH 22826

22815 0.644 kg/m

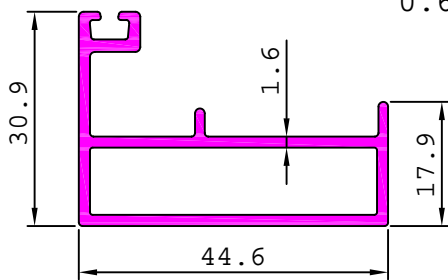

22828 0.501 kg/m

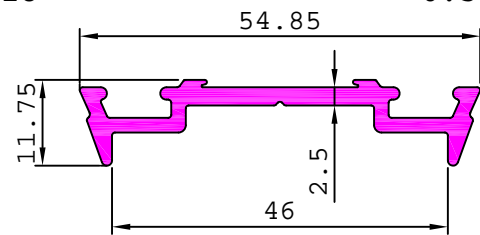

MATCHING WITH 22827

22823 2.848 kg/m

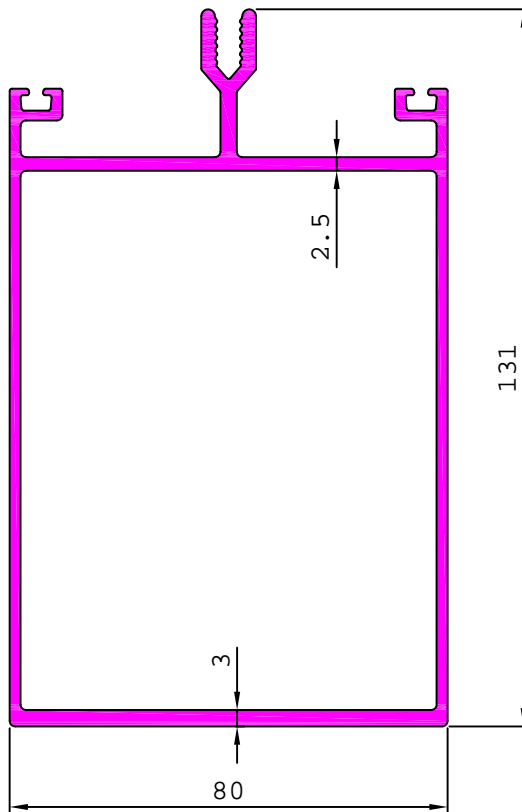

22827 1.848 kg/m

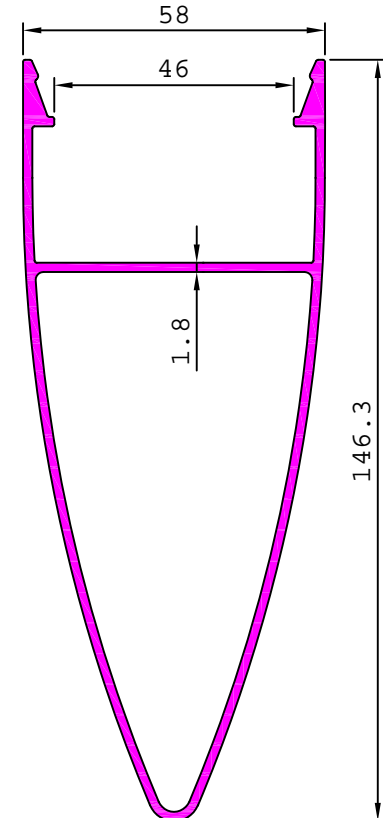

MATCHING WITH 22828

ARCHITECTURAL

CURTAIN WALL SECTION

22824 121.07 3.328 kg/m

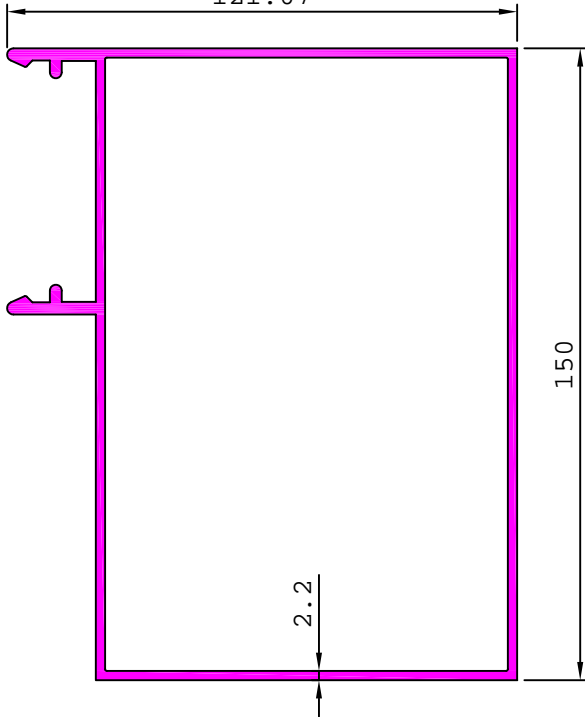

22830 1.445 kg/m

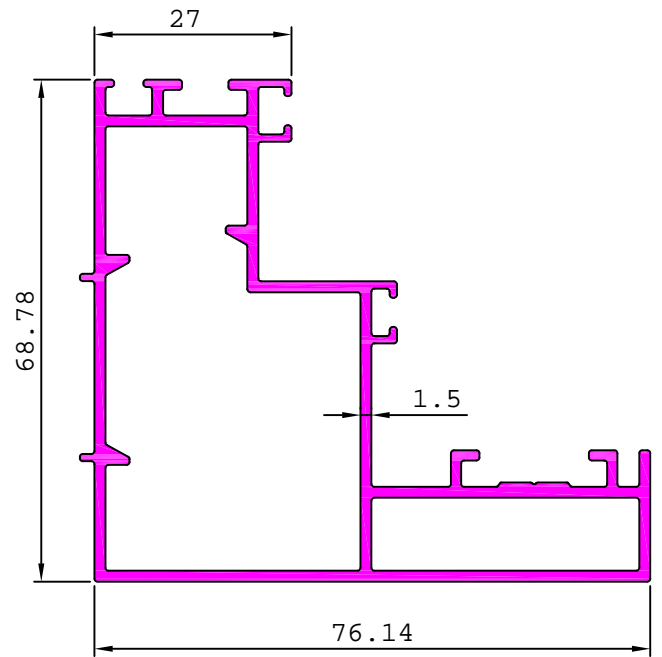

22829

1.619 kg/m

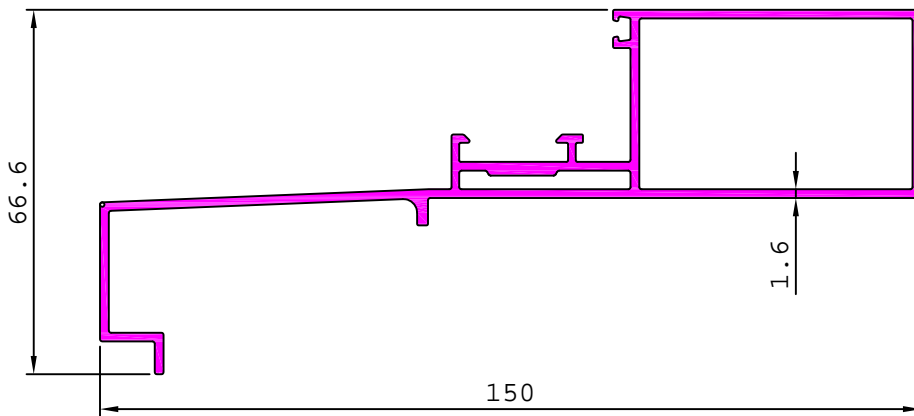

22832

1.711 kg/m

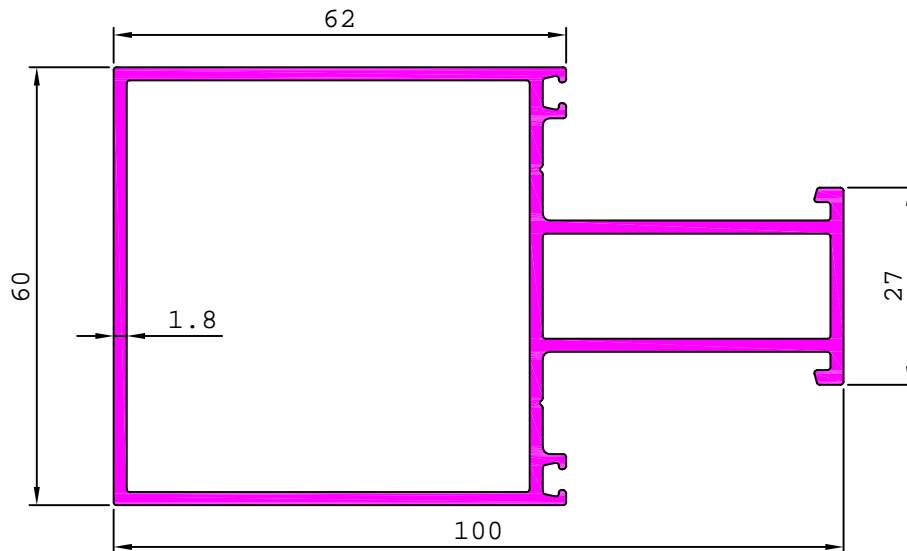

ARCHITECTURAL

CURTAIN WALL SECTION

22833

3.300 kg/m

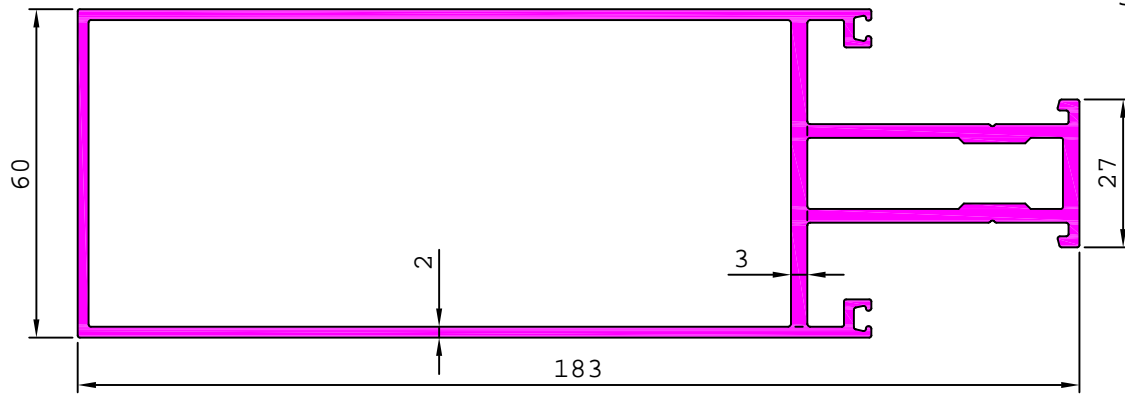

22834

3.039 kg/m

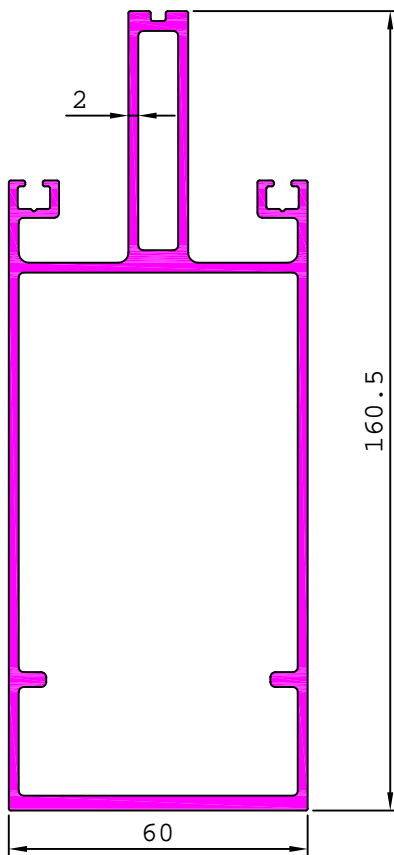

22835

1.976 kg/m

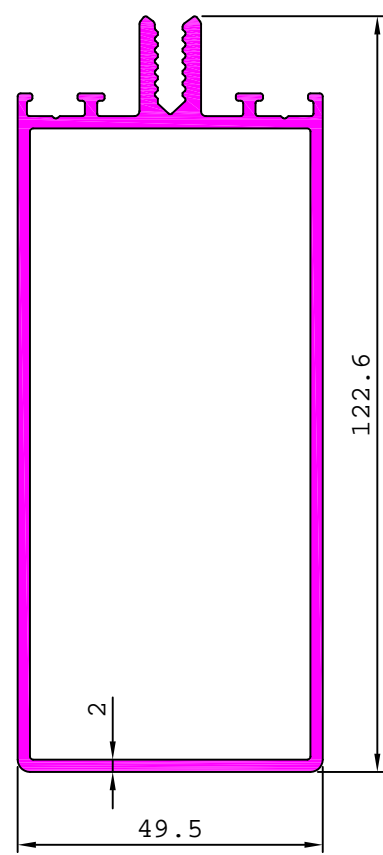

22836

2.923 kg/m

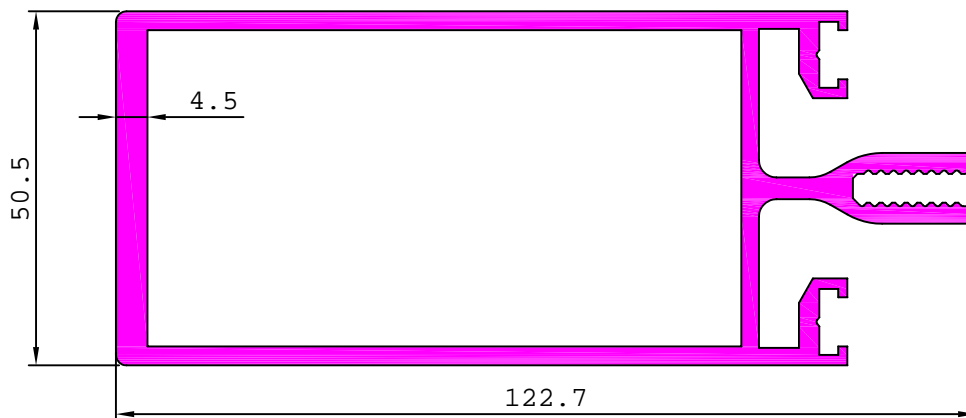

ARCHITECTURAL

CURTAIN WALL SECTION

22837

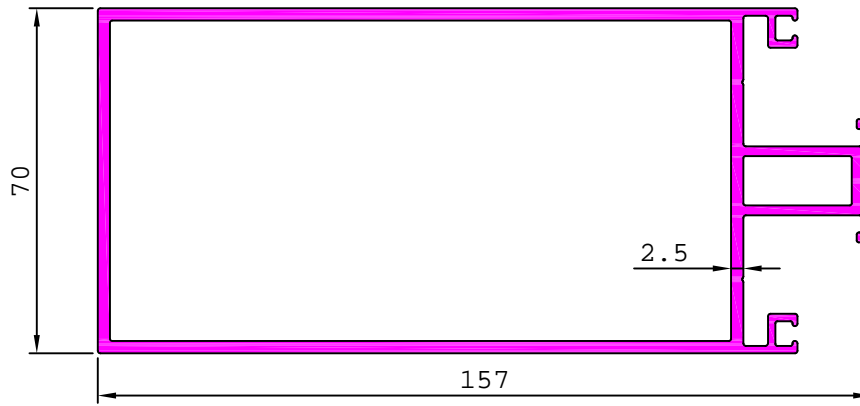

3.293 kg/m

22838

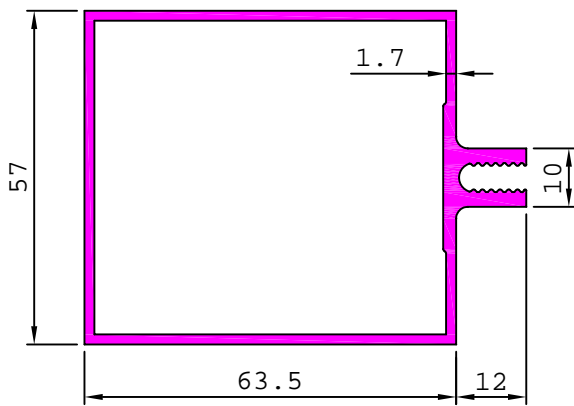

1.303 kg/m

22842

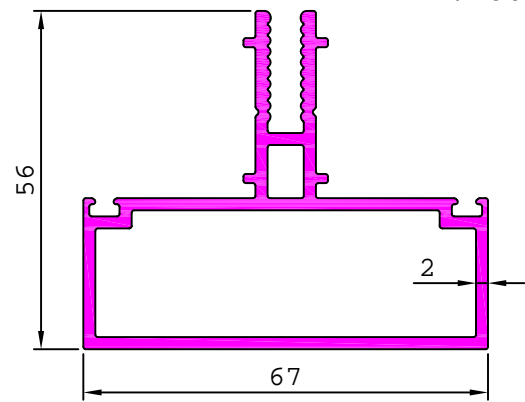

1.406 kg/m

22840

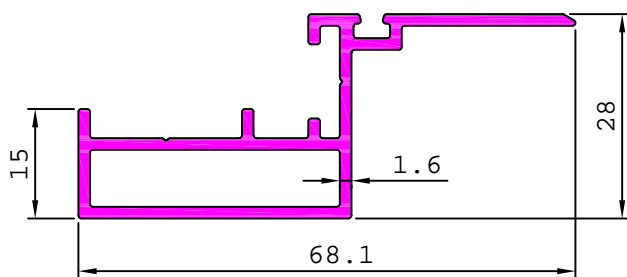

0.693 kg/m

22841

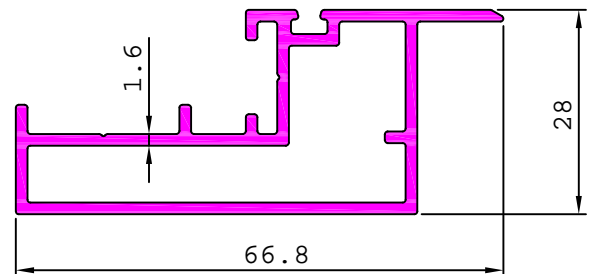

0.849 kg/m

22843

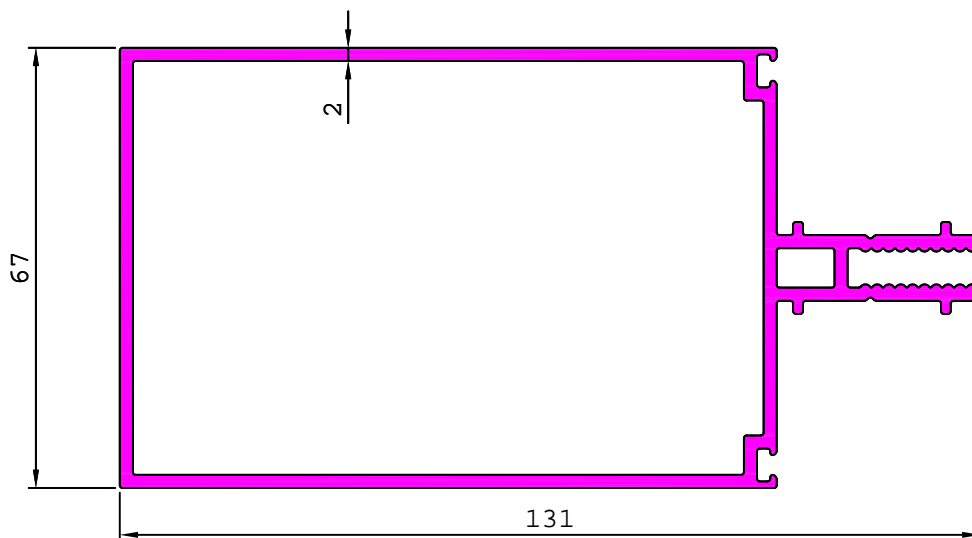

2.216 kg/m

ARCHITECTURAL

CURTAIN WALL SECTION

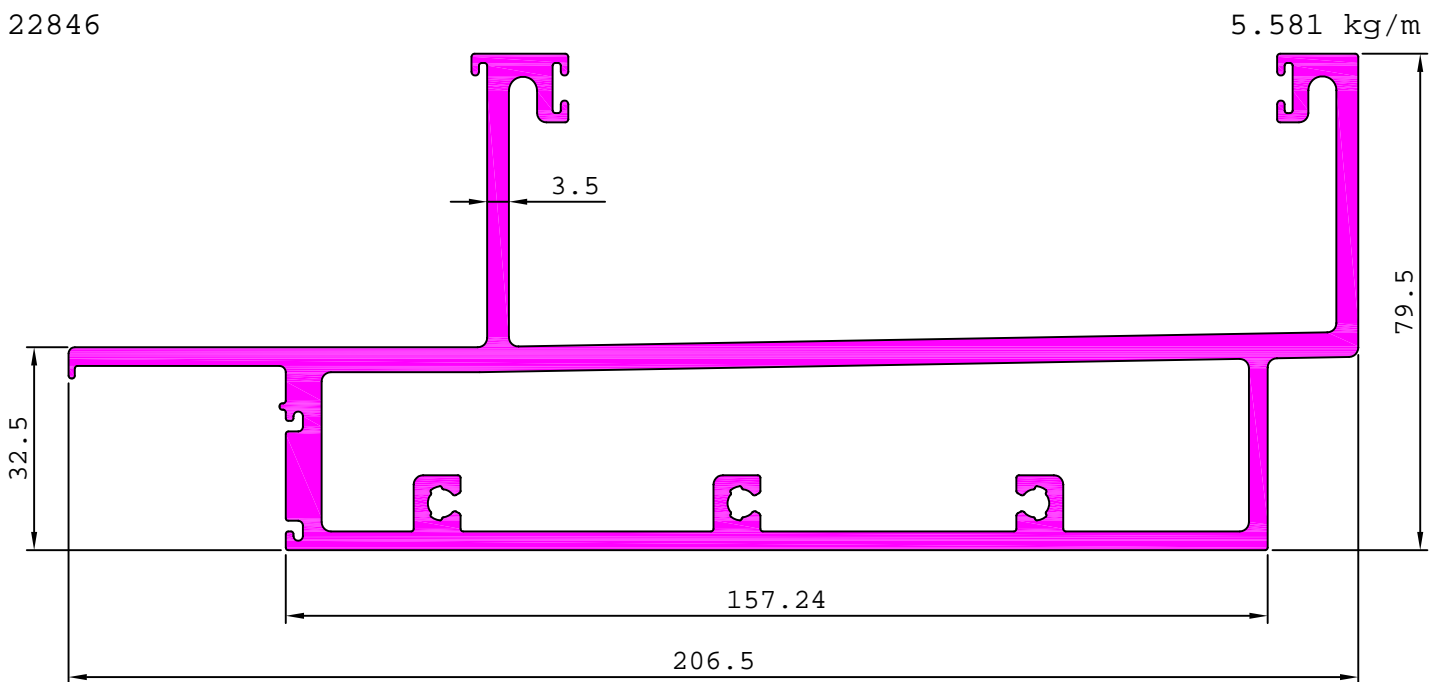
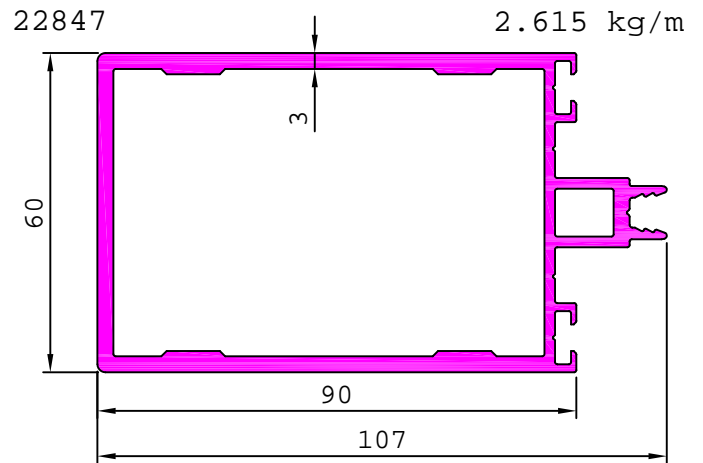
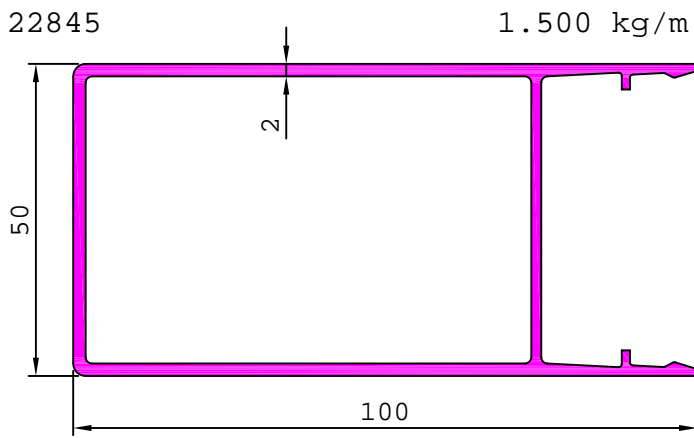
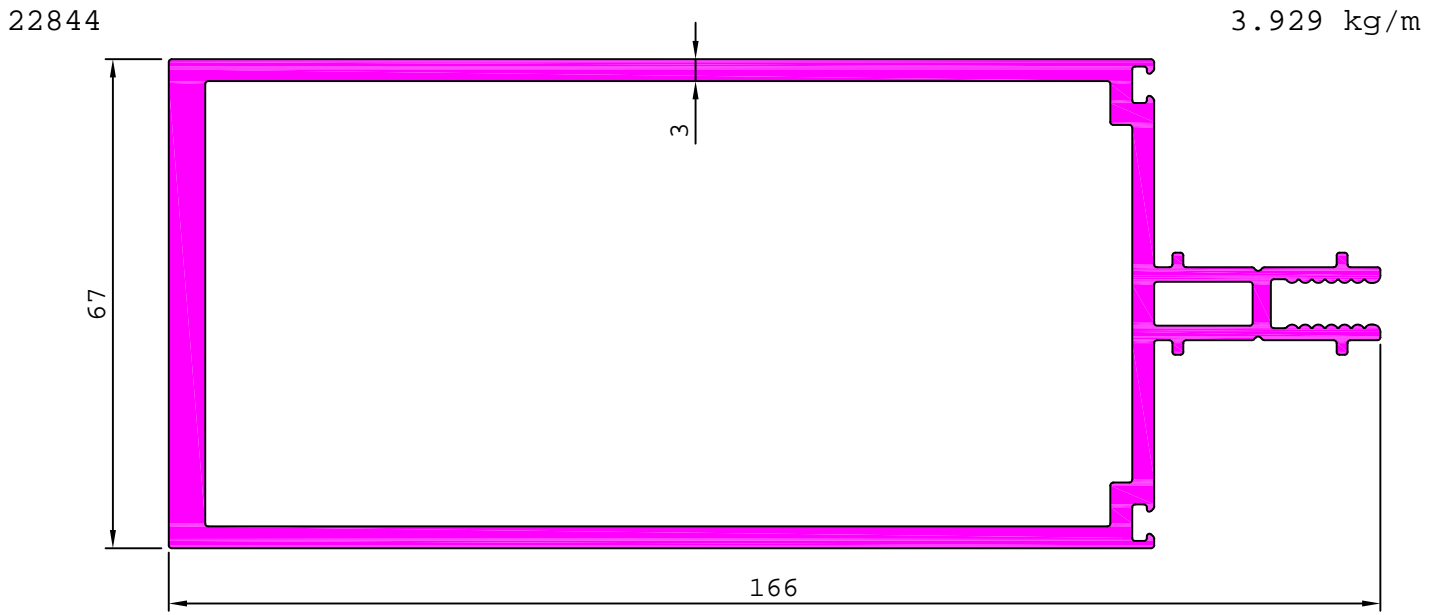

ARCHITECTURAL

CURTAIN WALL SECTION

22849

2.264 kg/m

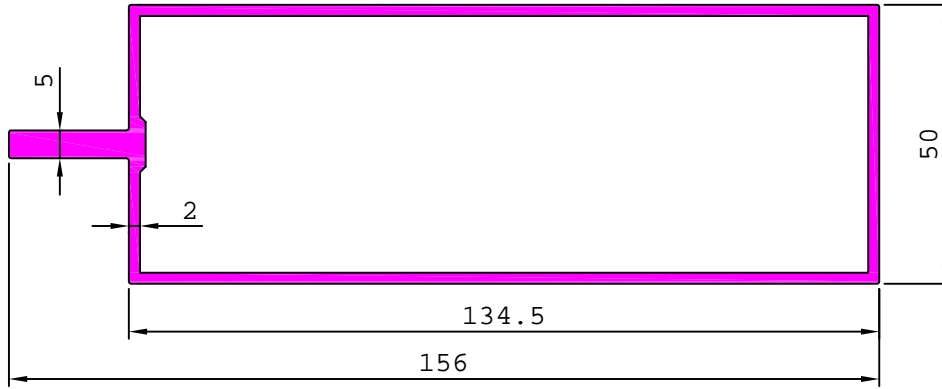

22850

2.926 kg/m

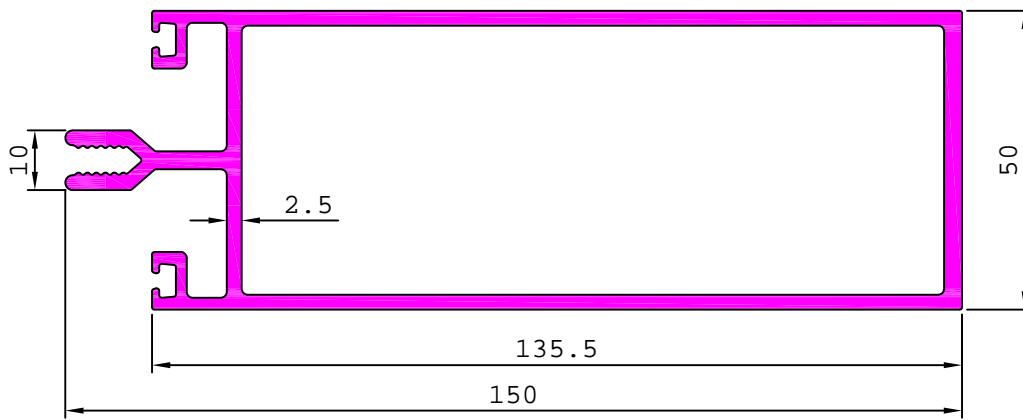

28827

3.385 kg/m

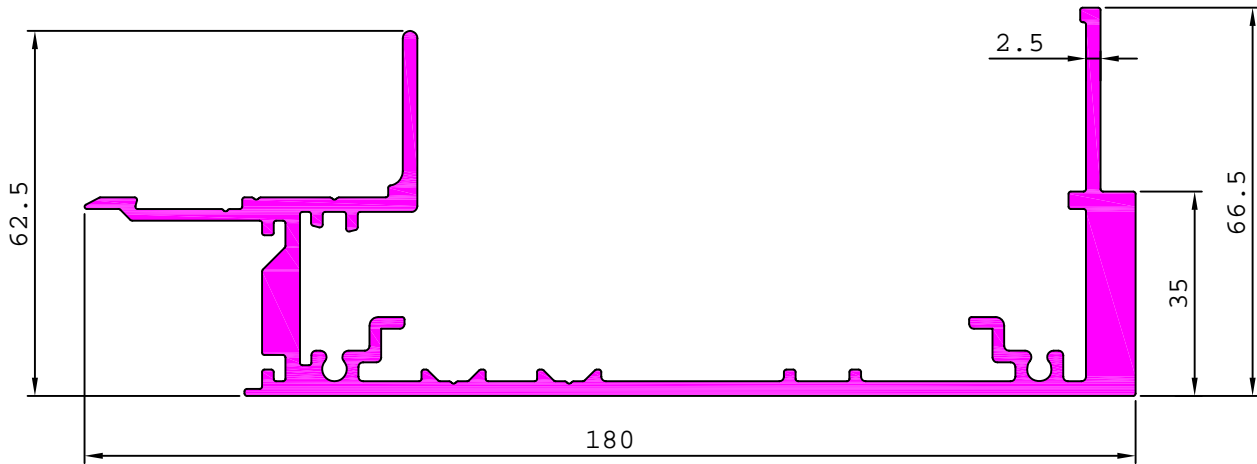

28828

2.378 kg/m

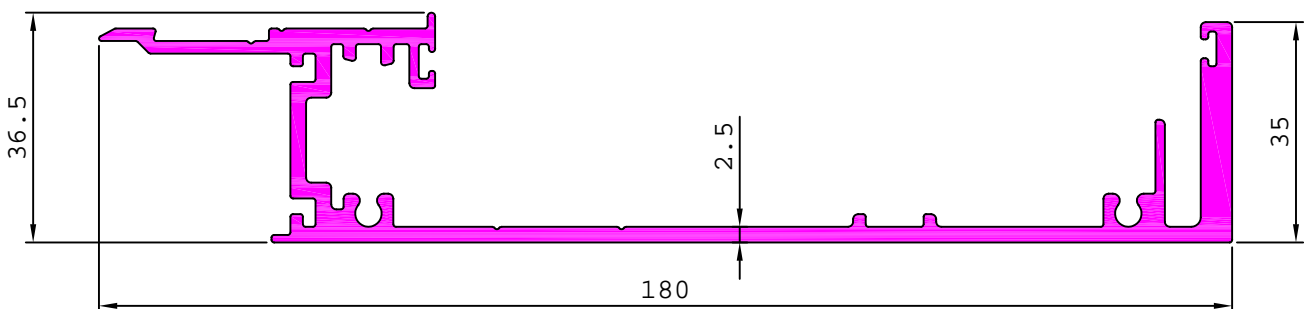

ARCHITECTURAL

CURTAIN WALL SECTION

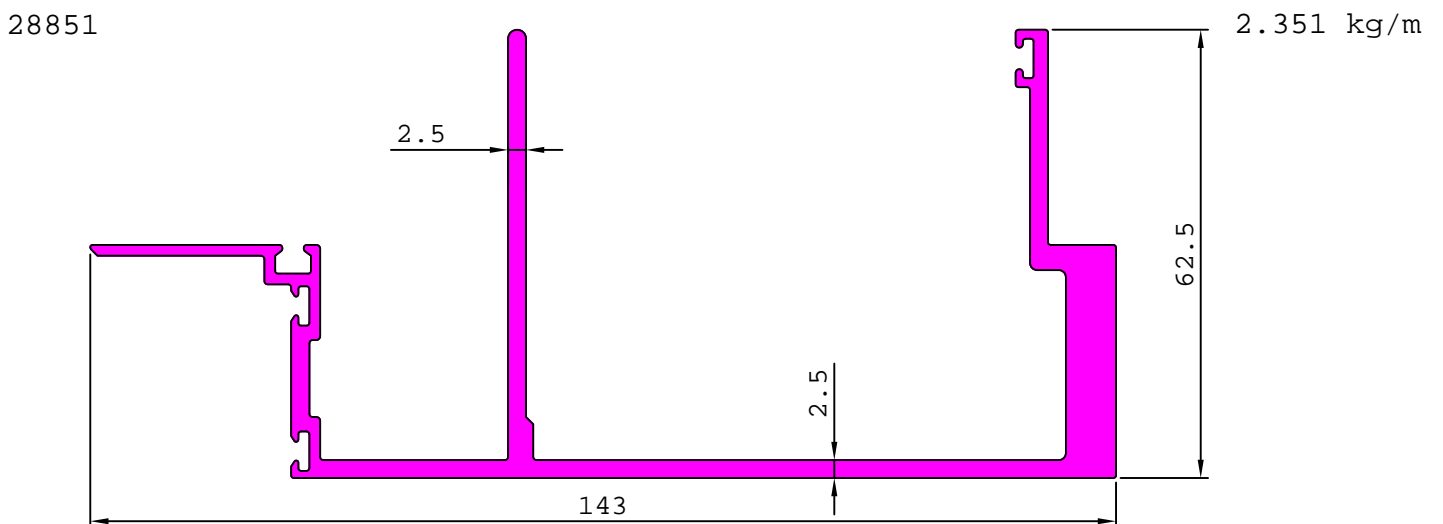
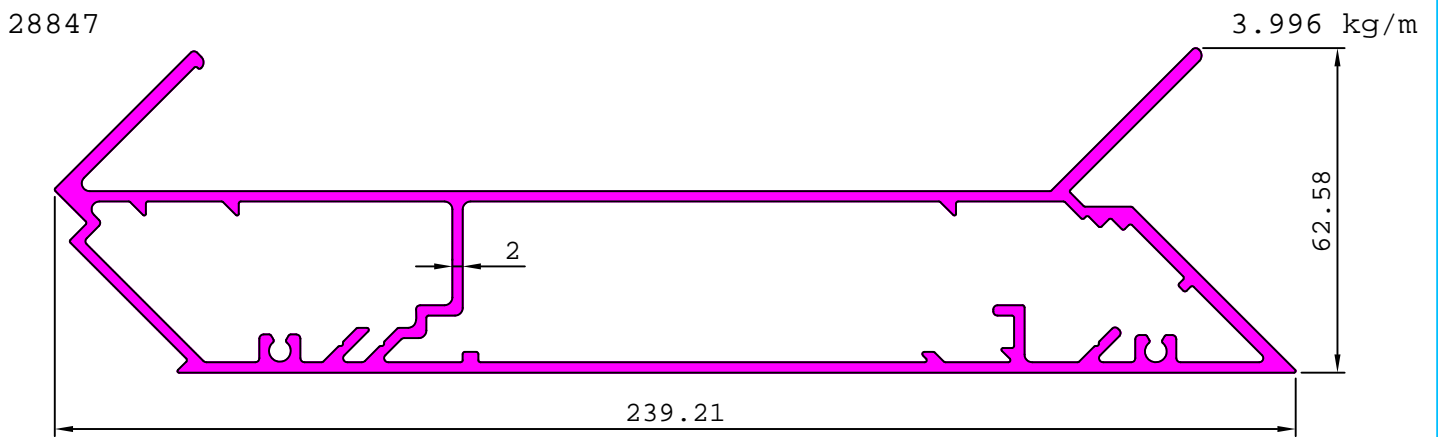
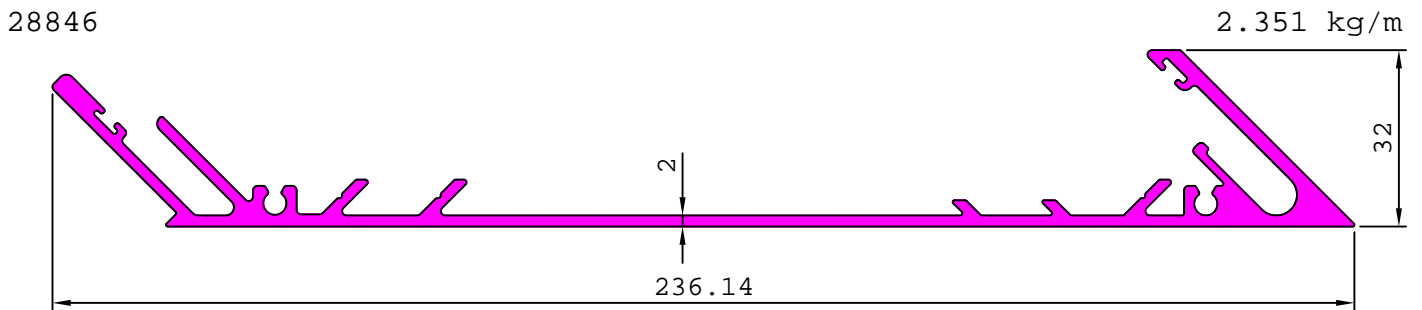
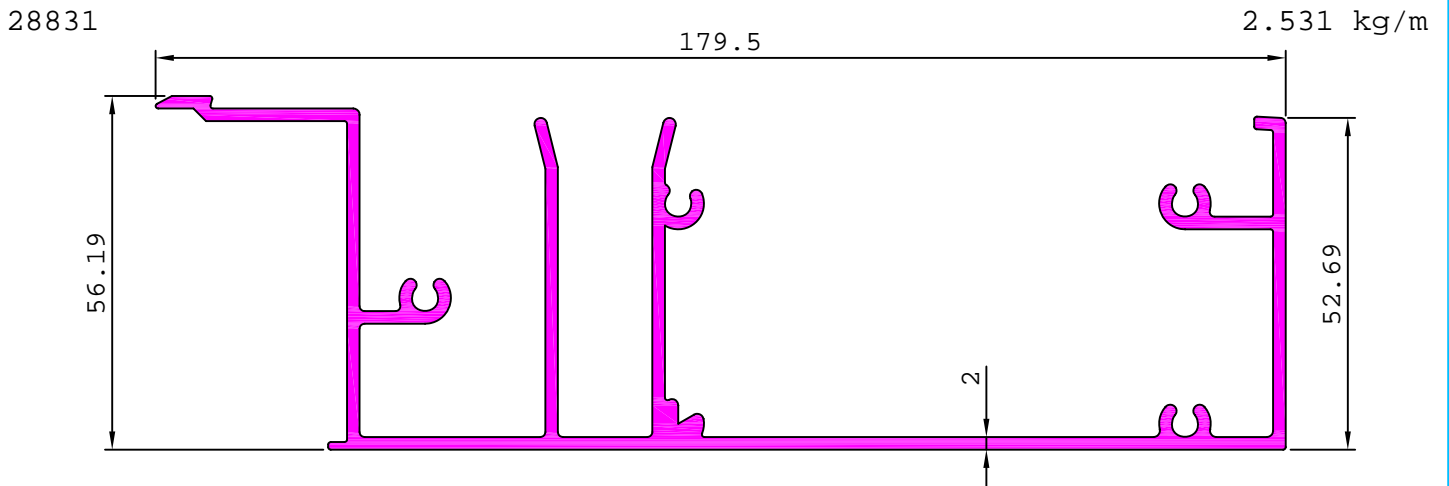

ARCHITECTURAL

CURTAIN WALL SECTION

28850

0.640 kg/m

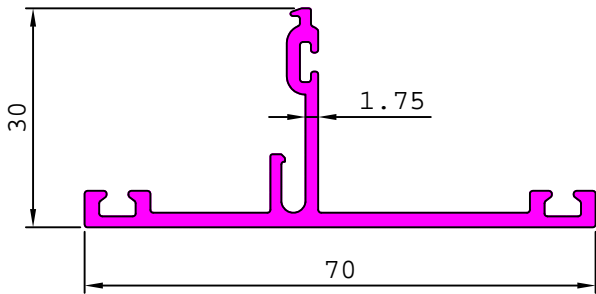

28853

2.481 kg/m

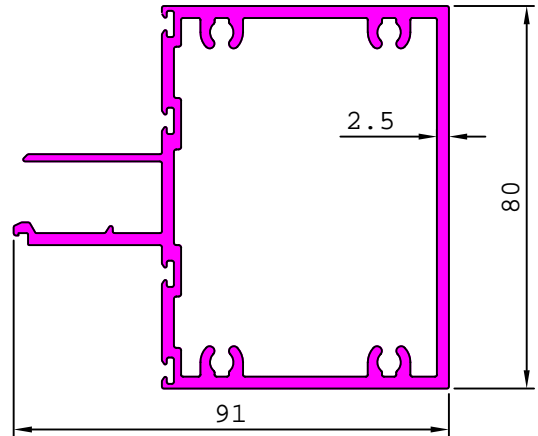

28852

1.881 kg/m

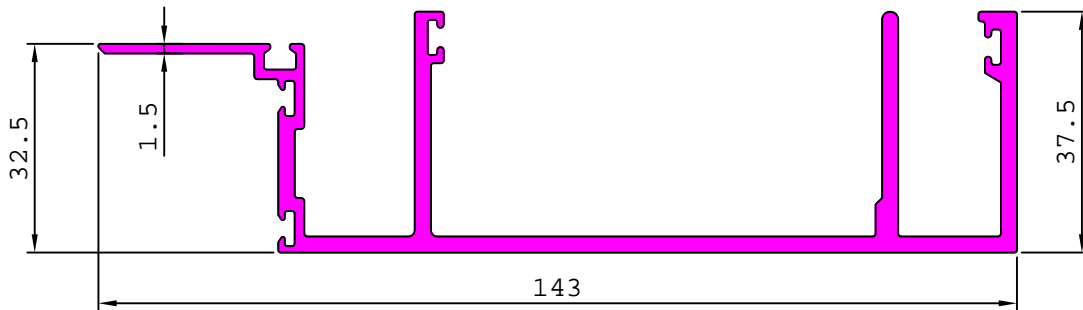

28854

2.140 kg/m

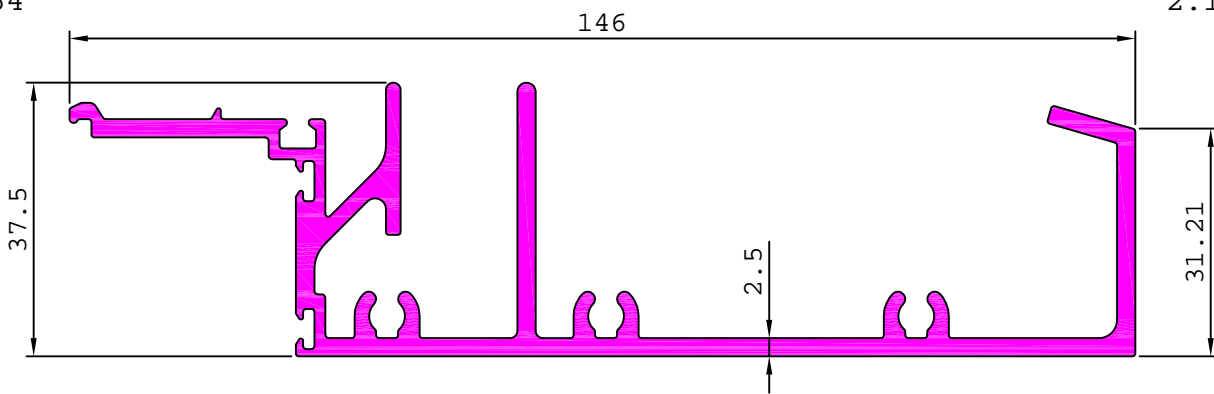

28908

2.592 kg/m

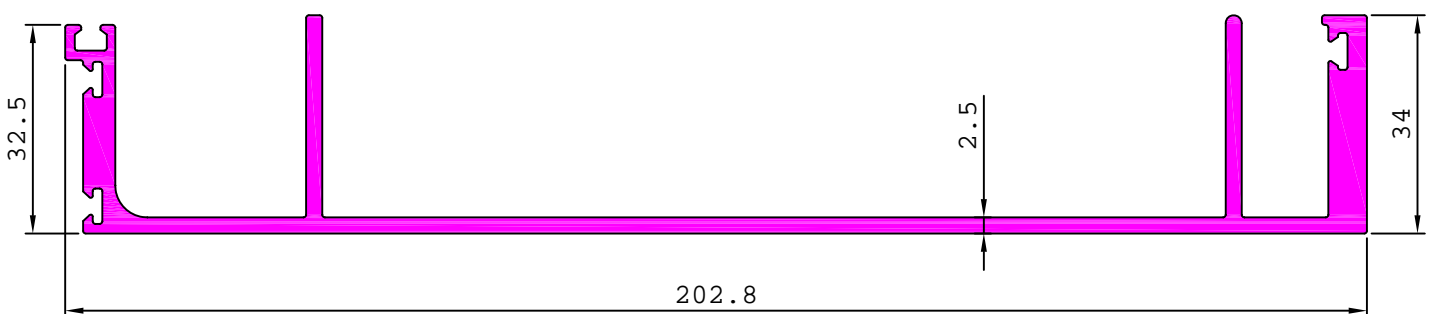

ARCHITECTURAL

CURTAIN WALL SECTION

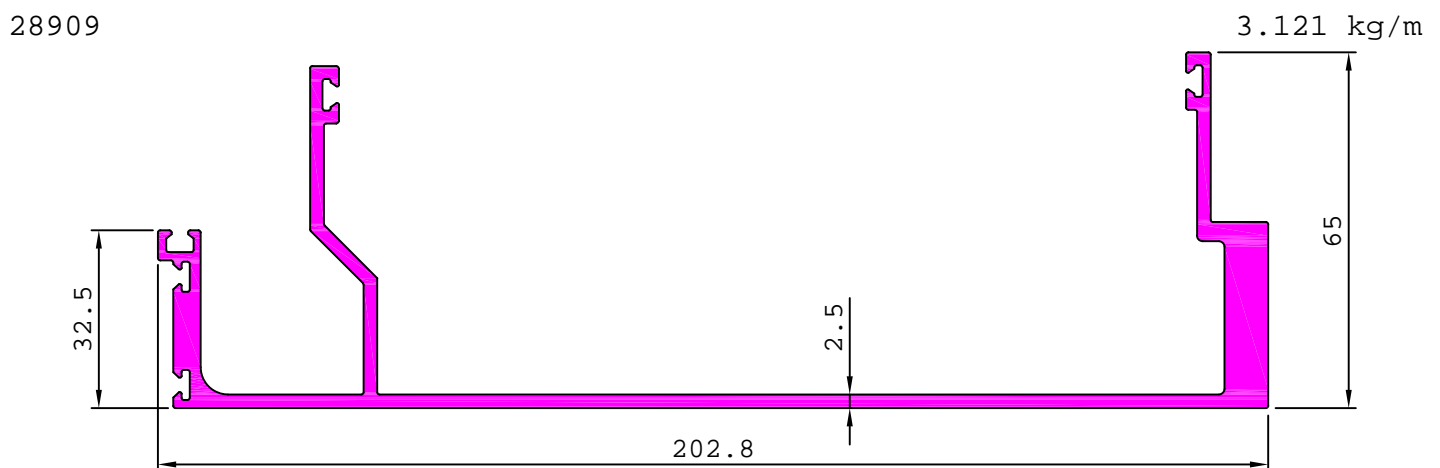
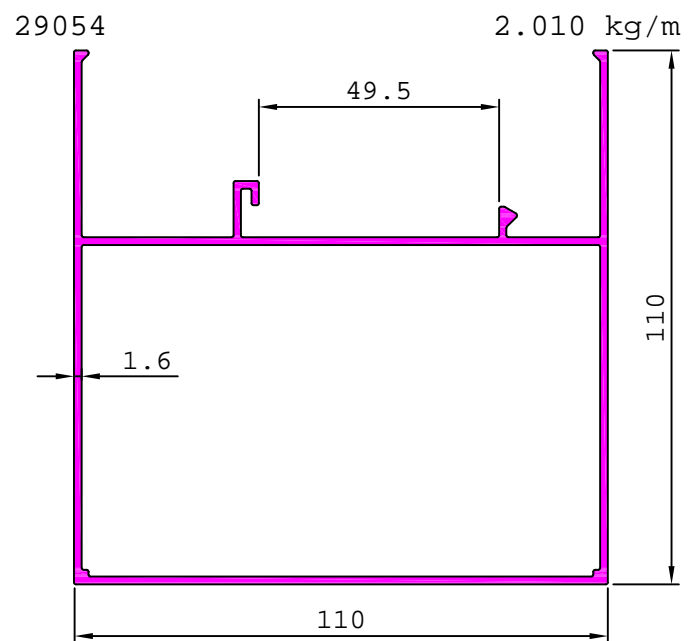
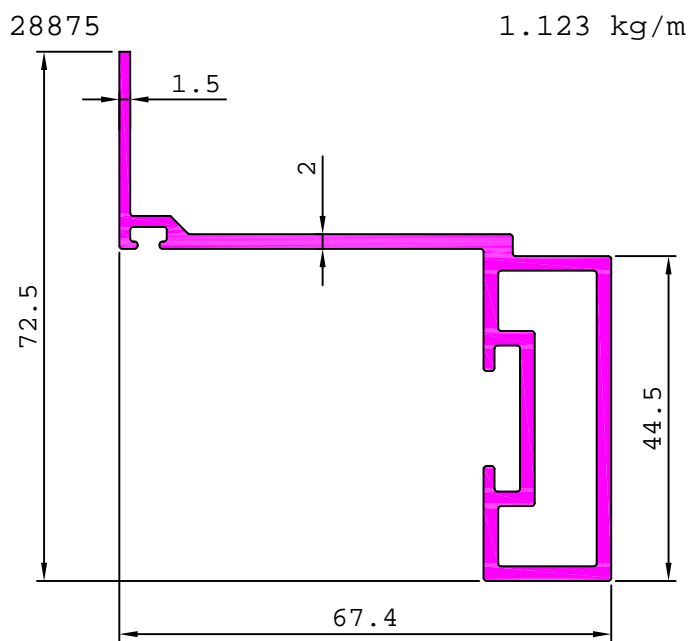
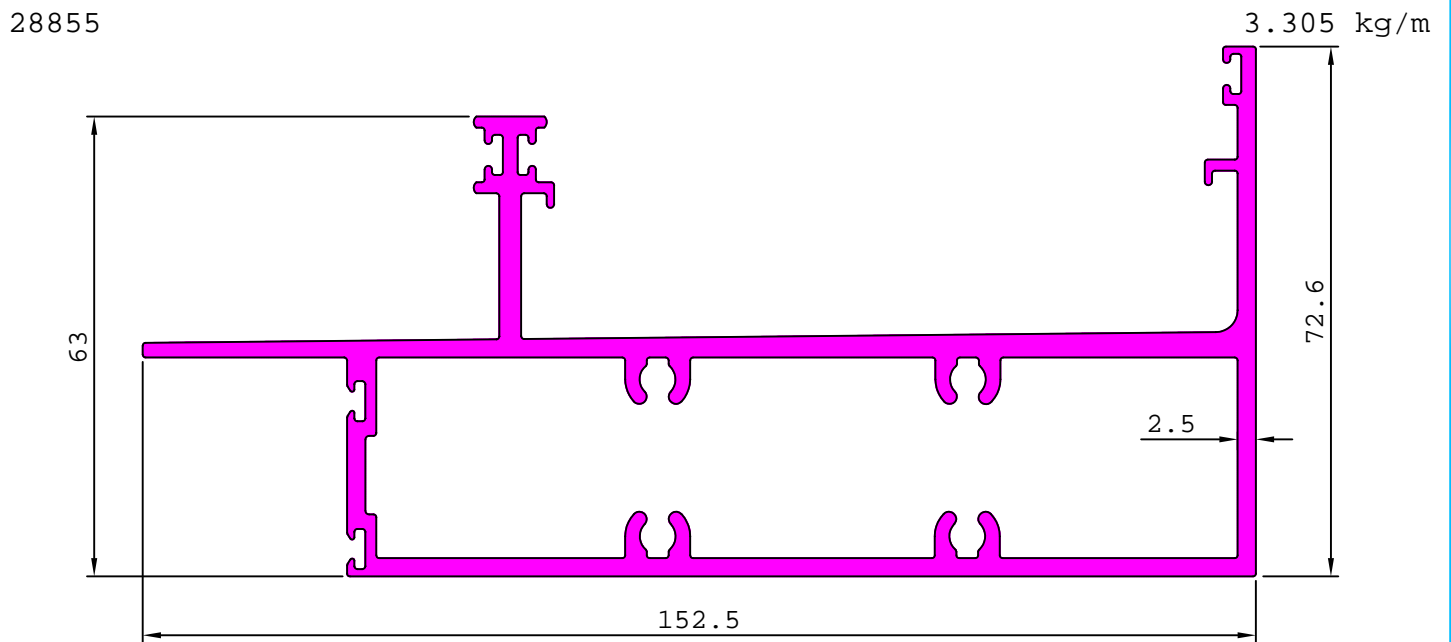

ARCHITECTURAL

CURTAIN WALL SECTION

28879

0.791 kg/m

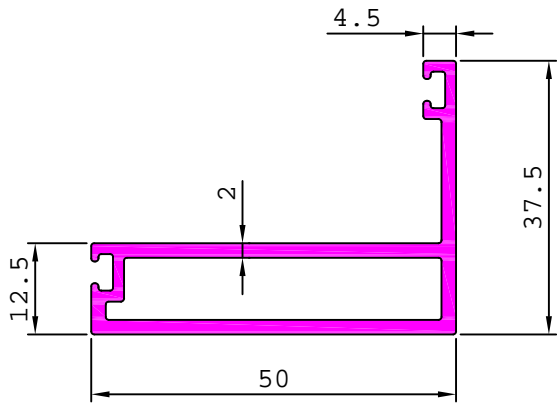

29055

1.665 kg/m

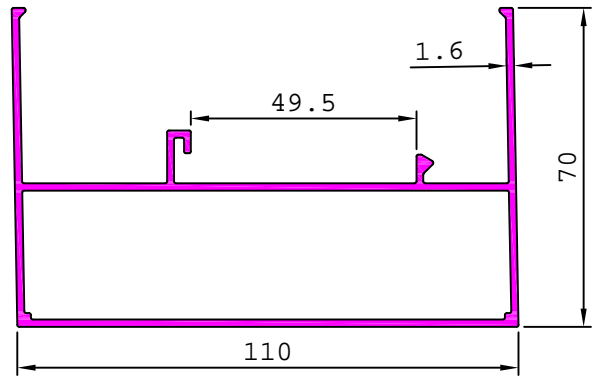

28910

2.749 kg/m

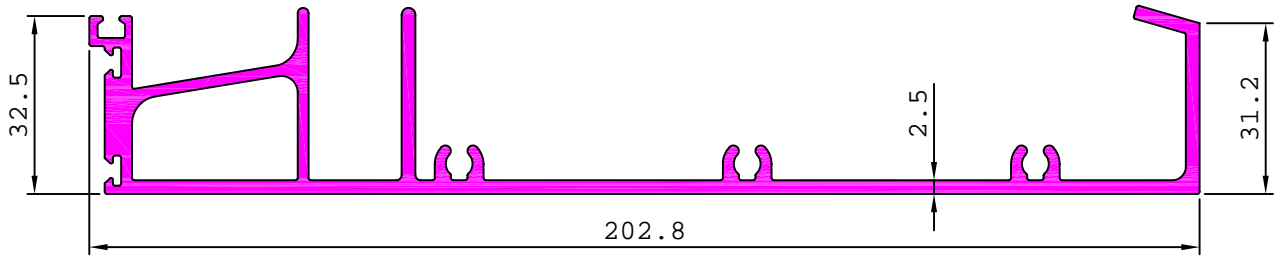

28912

4.542 kg/m

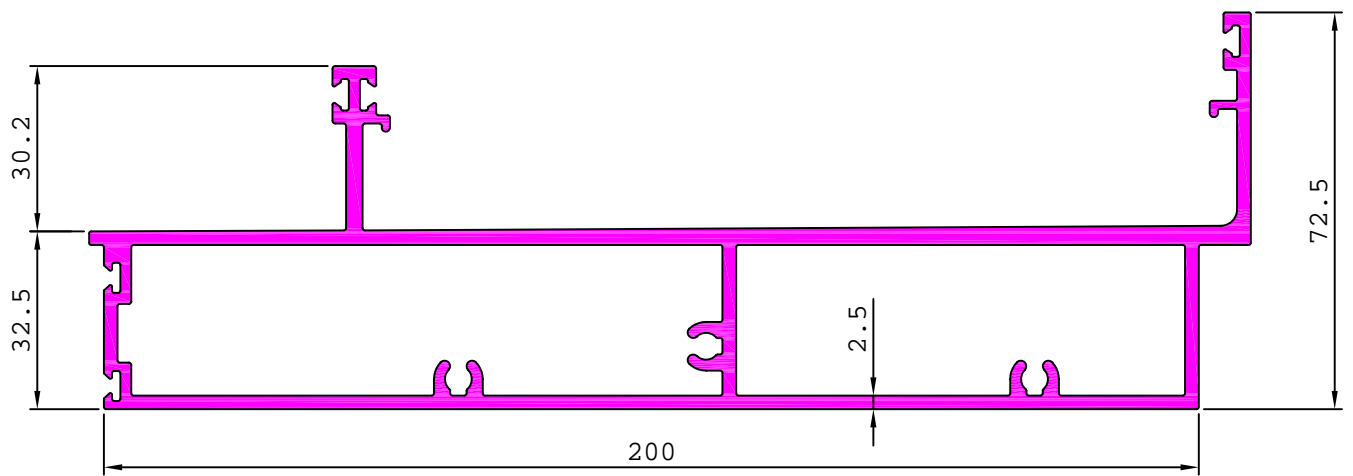

28941

2.517 kg/m

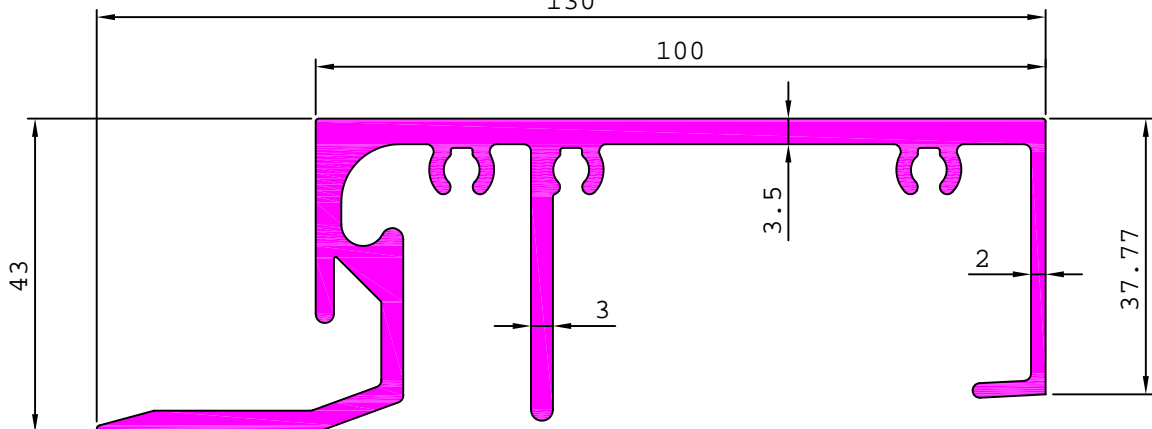

ARCHITECTURAL

CURTAIN WALL SECTION

28942

3.190 kg/m

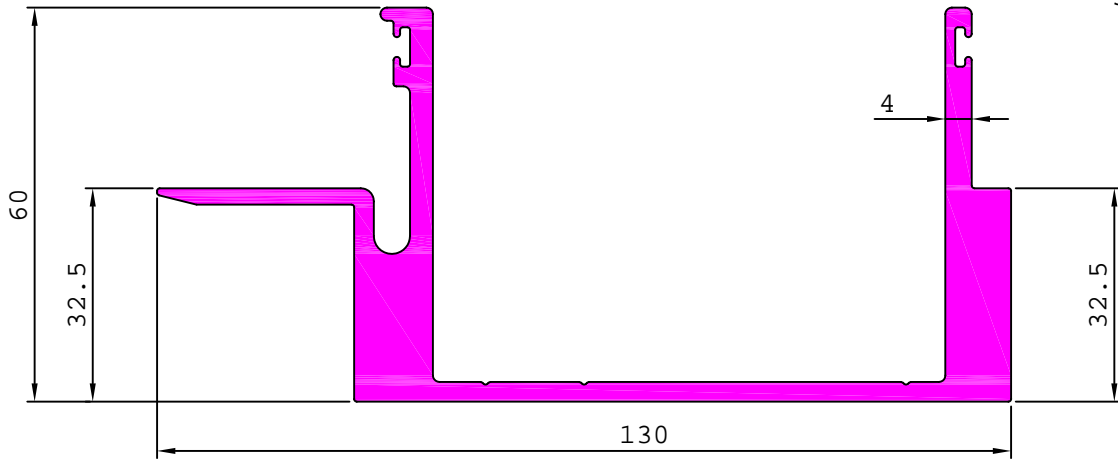

28943

2.961 kg/m

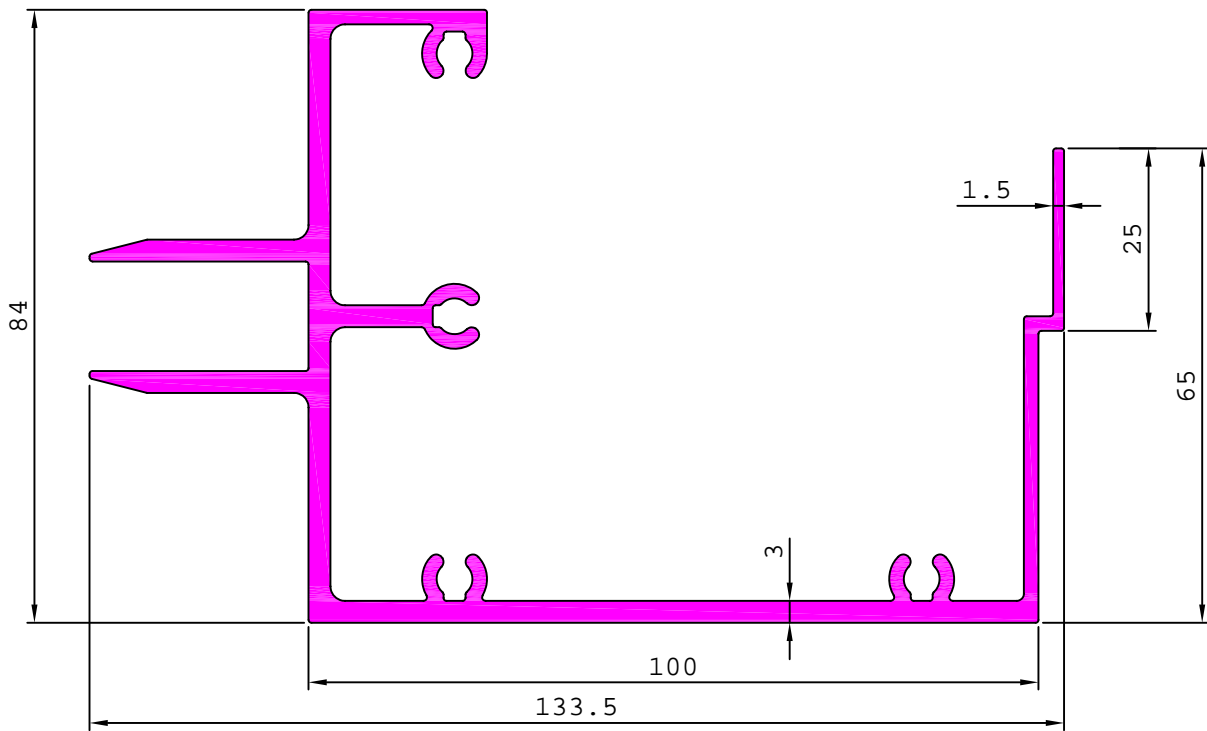

28965

2.814 kg/m

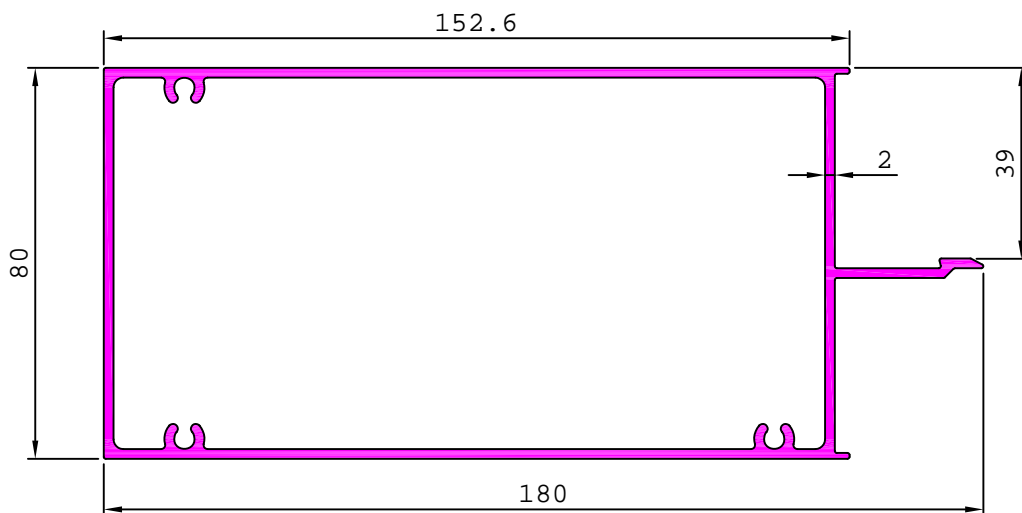

ARCHITECTURAL

CURTAIN WALL SECTION

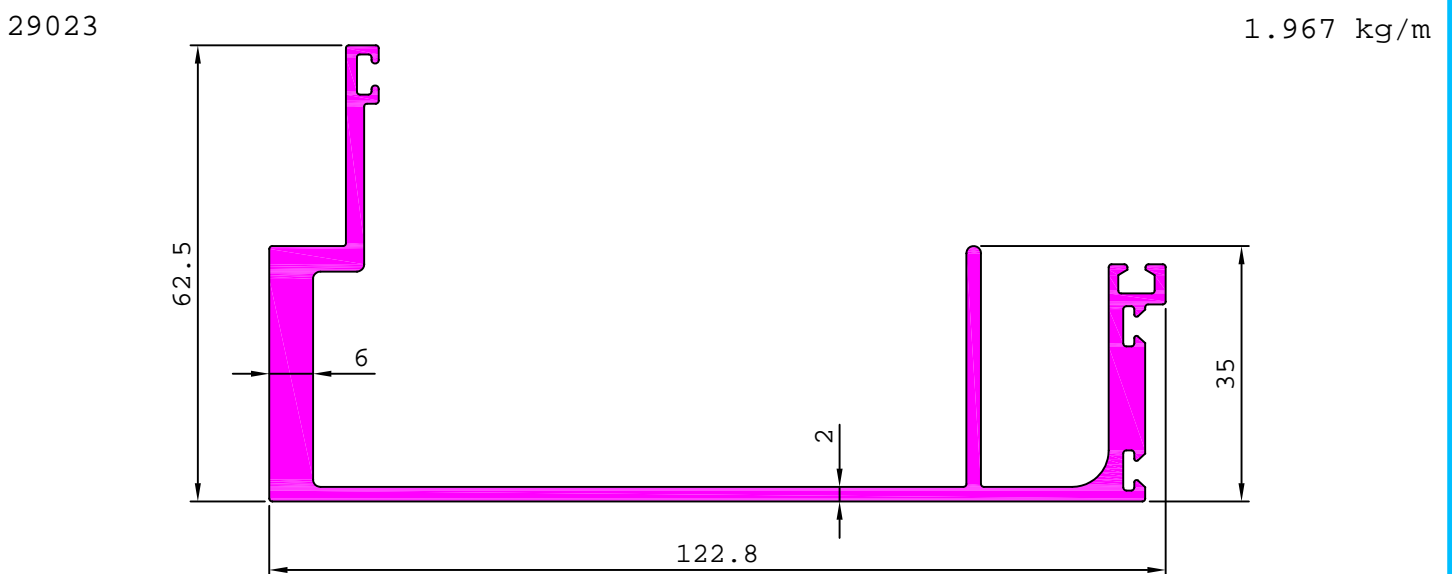
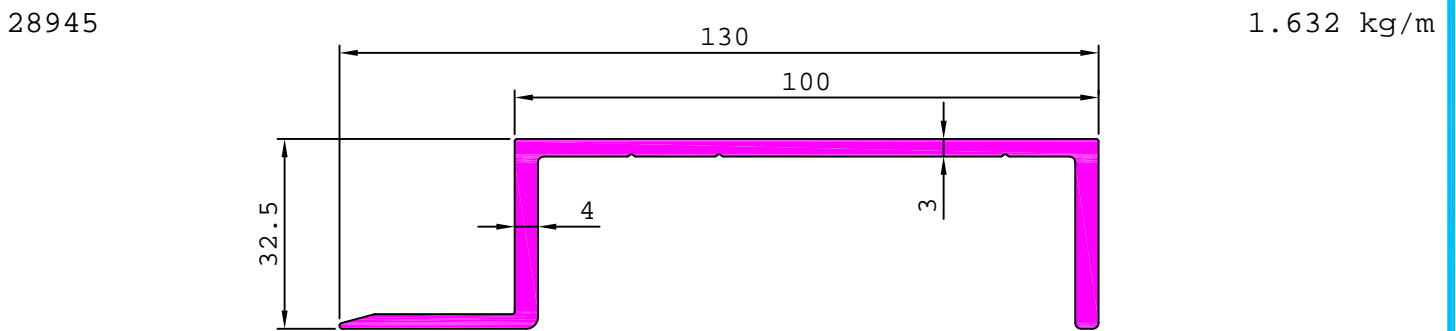
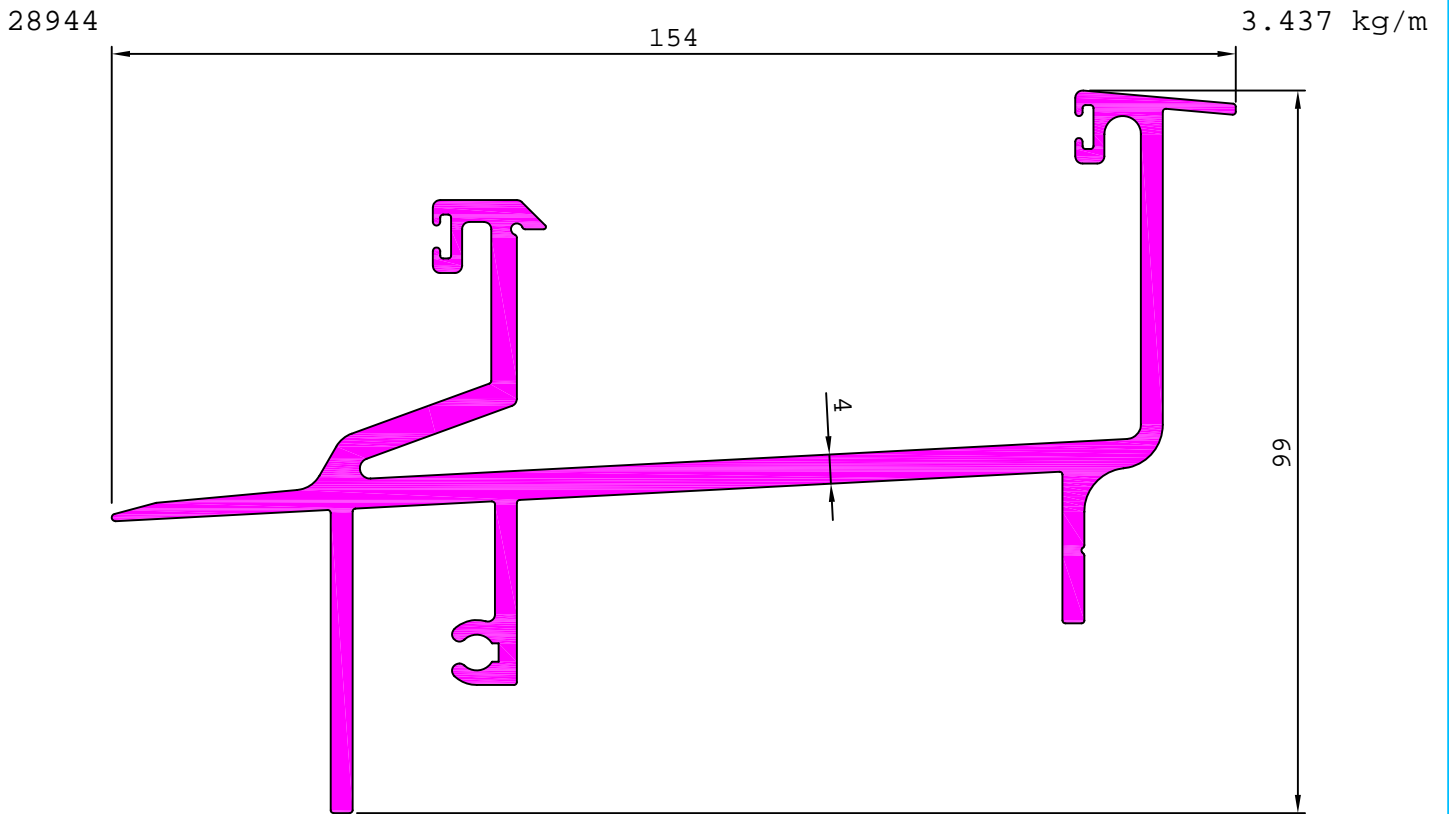

ARCHITECTURAL

CURTAIN WALL SECTION

29024

1.580 kg/m

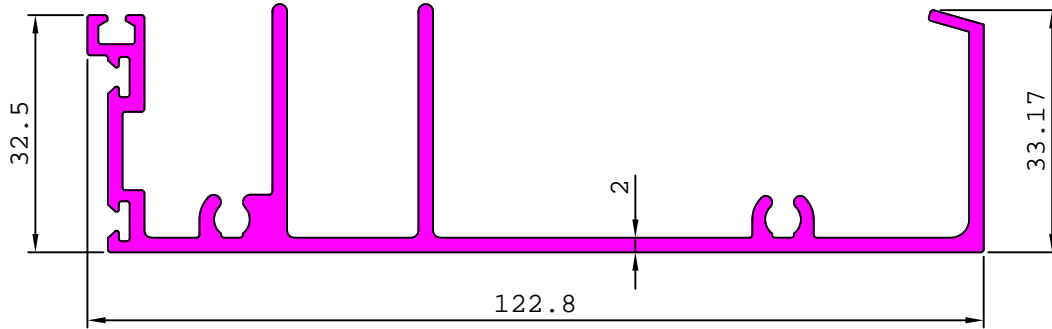

29027

2.809 kg/m

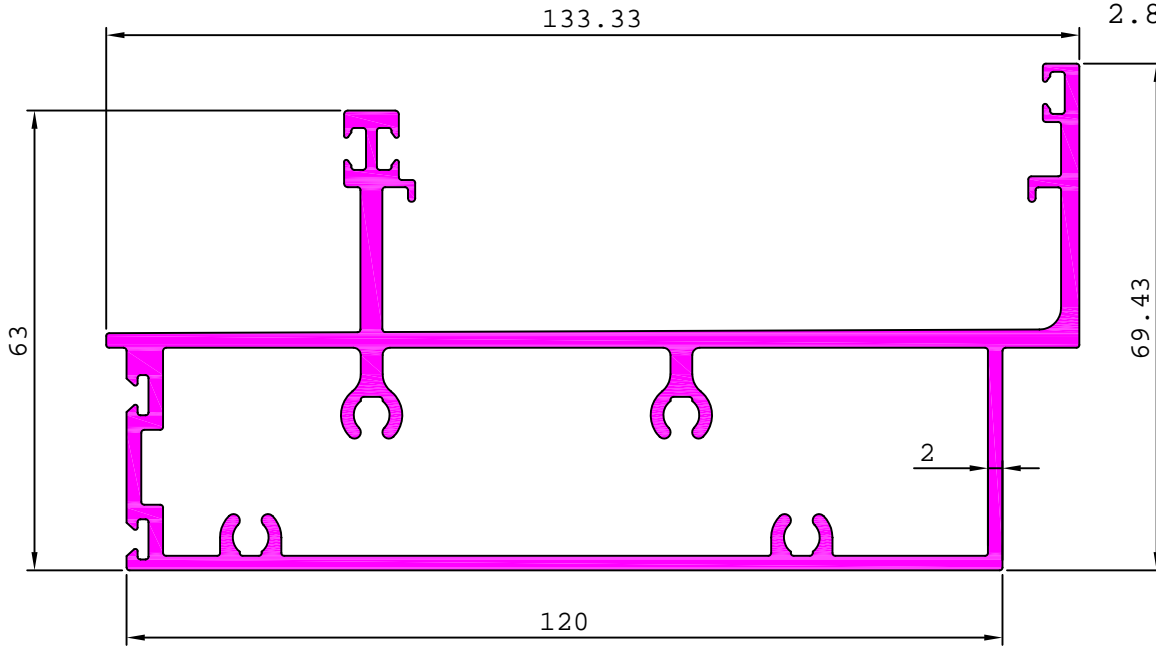

MATCHING WITH 29025

29025

1.281 kg/m

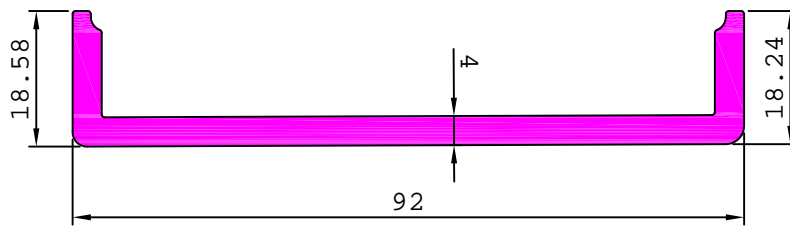

MATCHING WITH 29027

29030

1.965 kg/m

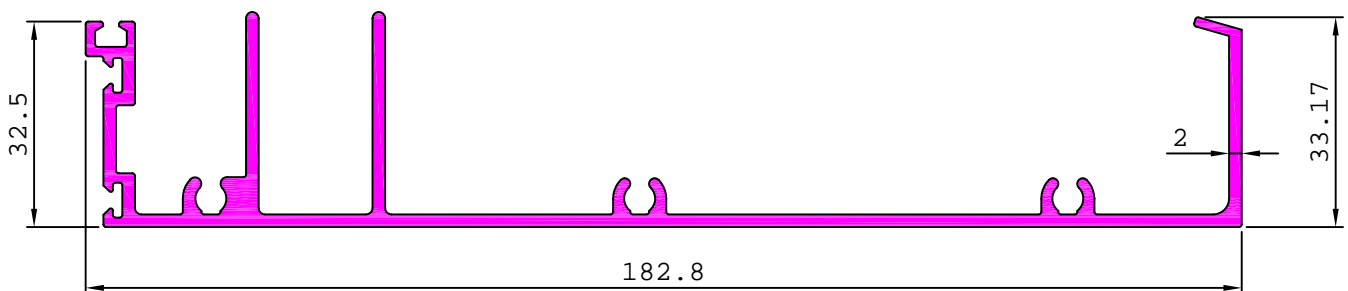

ARCHITECTURAL

CURTAIN WALL SECTION

29034

1.929 kg/m

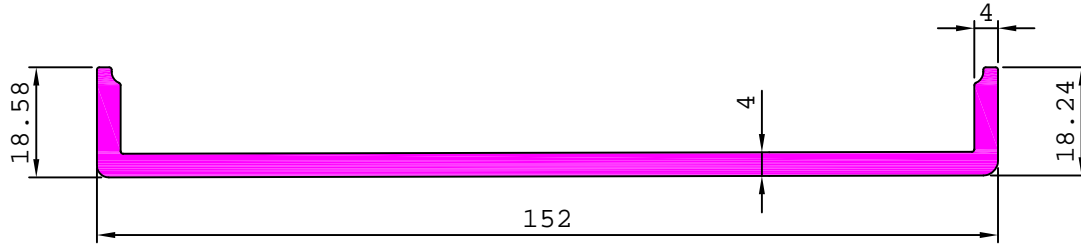

29043

4.126 kg/m

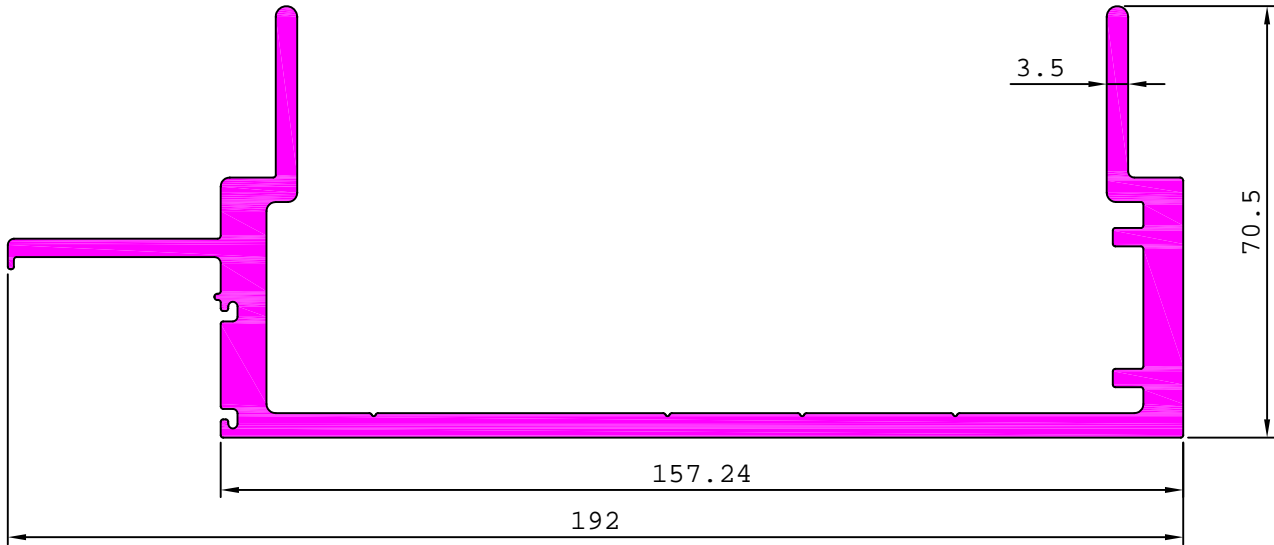

29044

5.083 kg/m

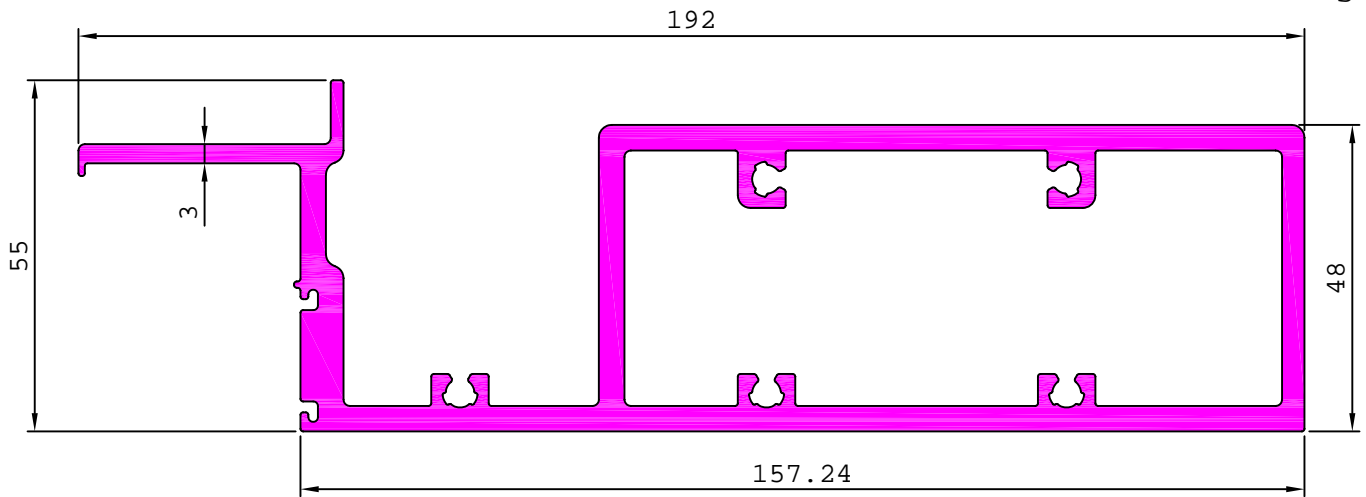

29057

0.702 kg/m

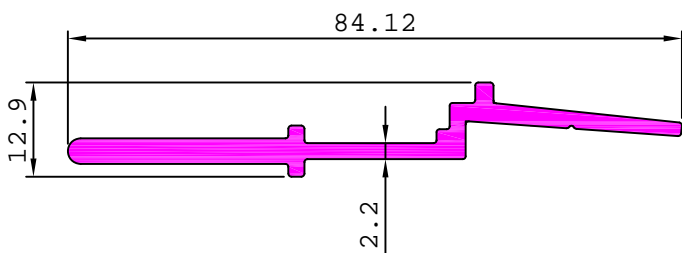

29081

0.903 kg/m

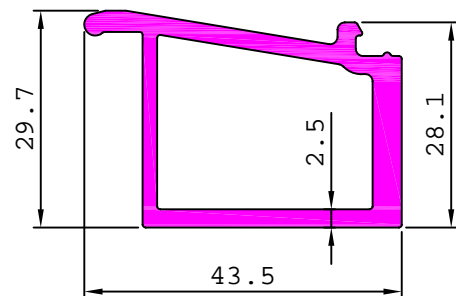

ARCHITECTURAL

CURTAIN WALL SECTION

29056 0.851 kg/m

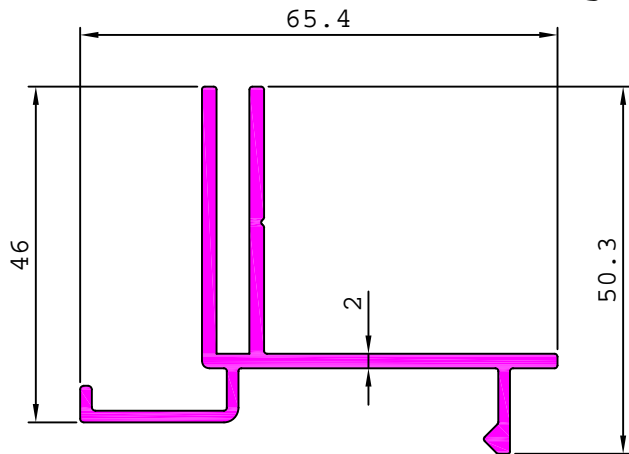

29084 0.881 kg/m

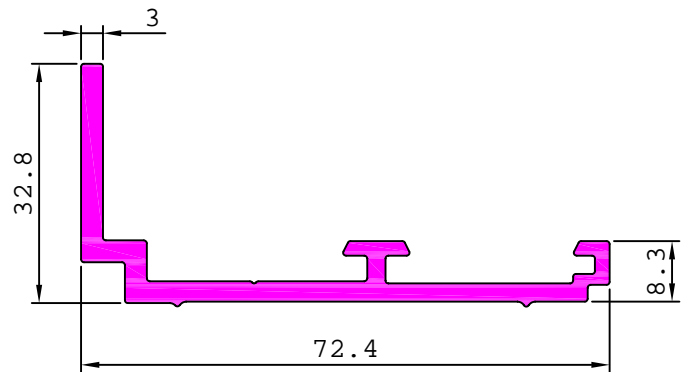

29087 4.643 kg/m

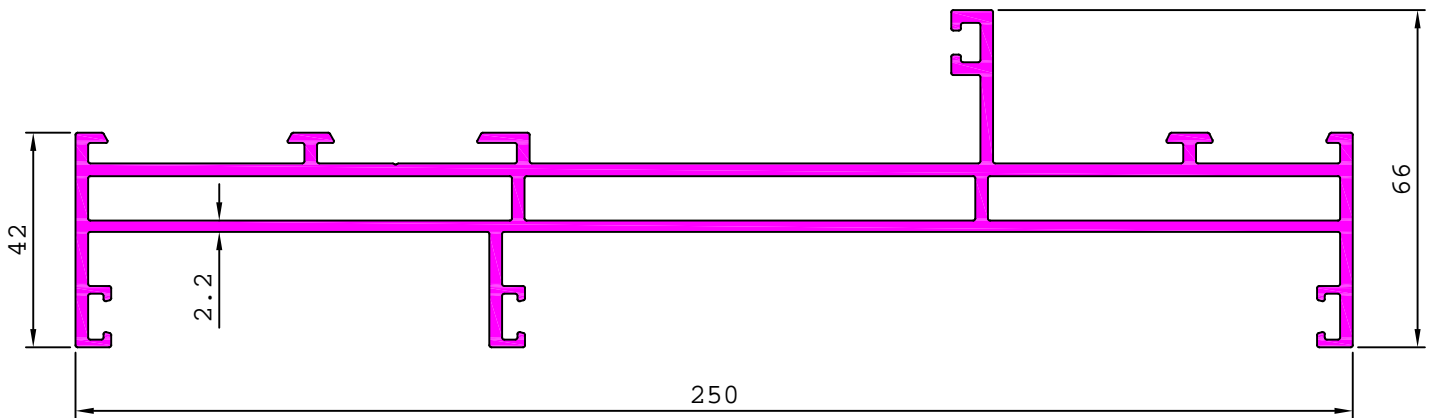

29085 1.209 kg/m

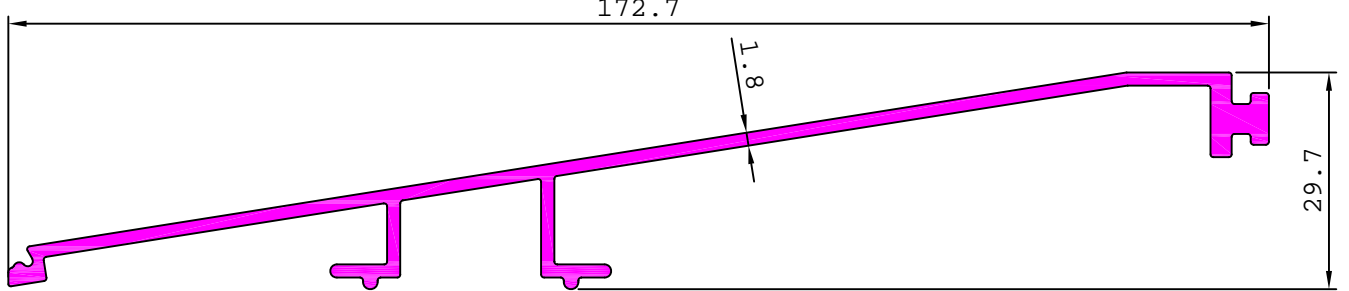

29086 4.946 kg/m

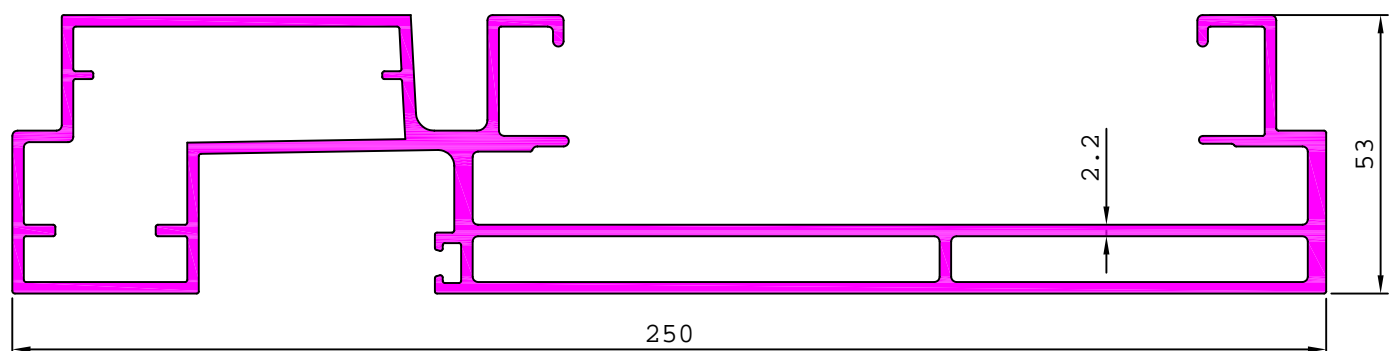

ARCHITECTURAL

CURTAIN WALL SECTION

29088

3.747 kg/m

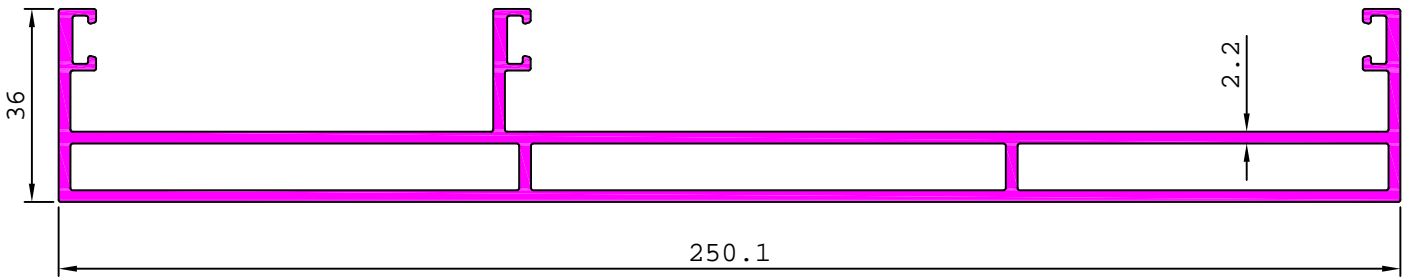

29090

4.649 kg/m

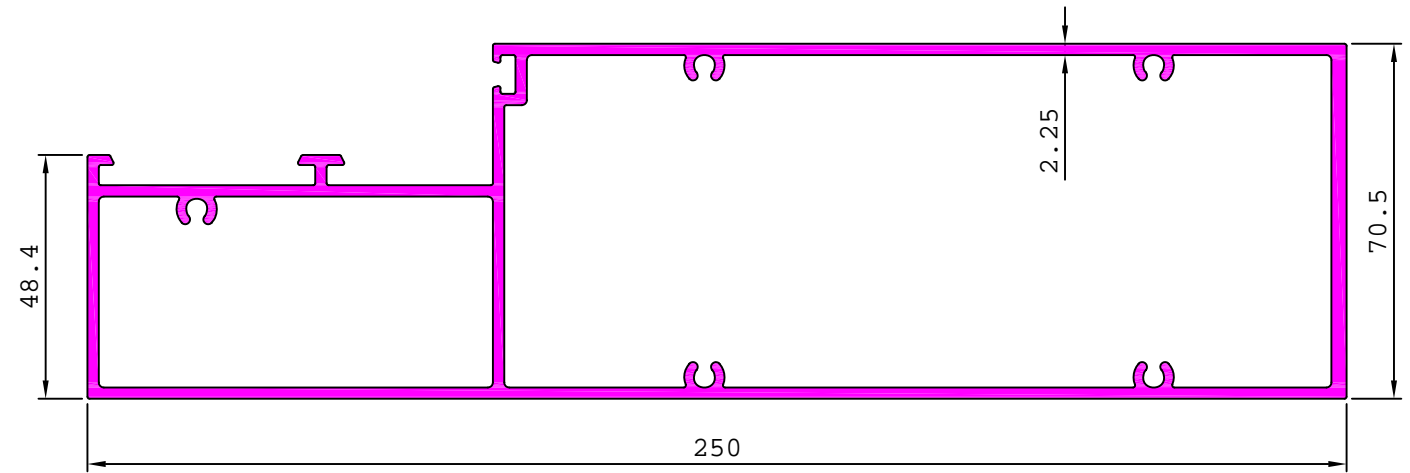

29091

3.292 kg/m

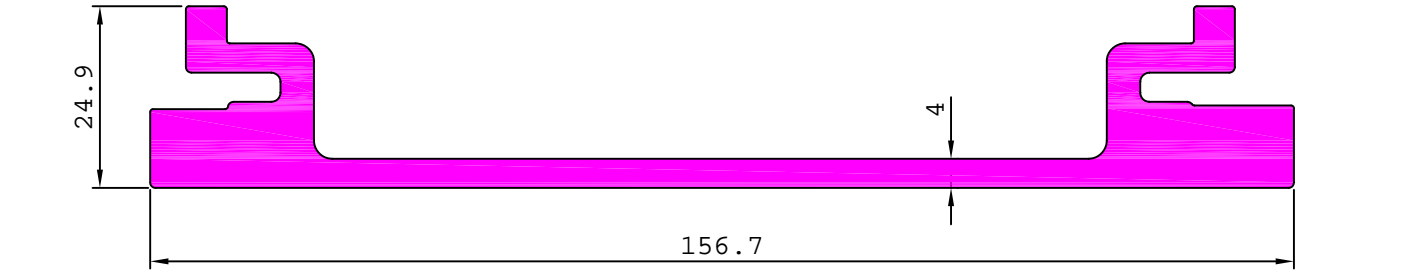

29094

3.682 kg/m

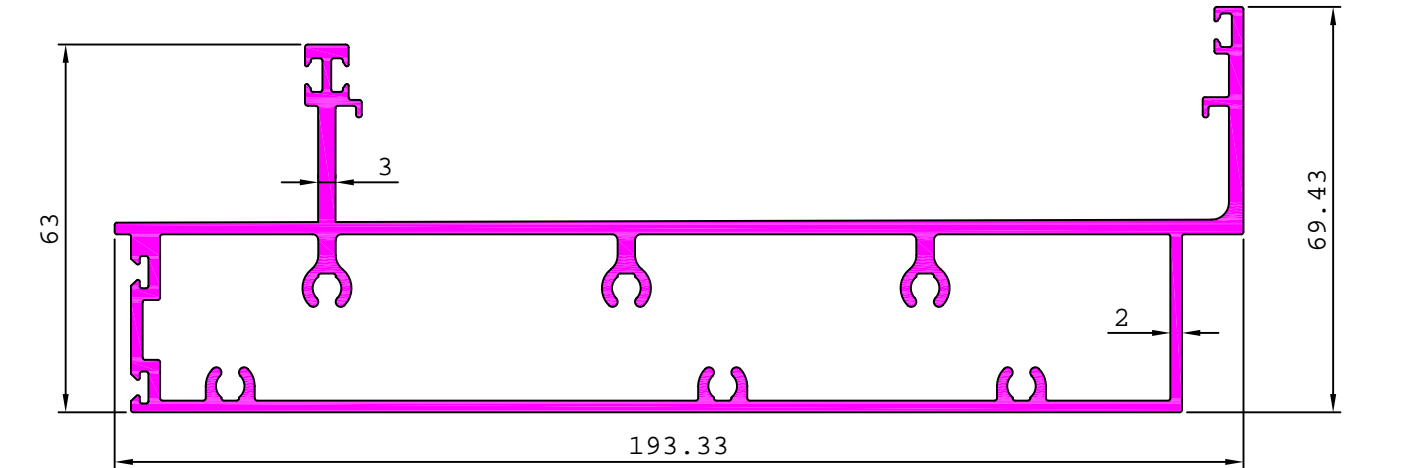

ARCHITECTURAL

CURTAIN WALL SECTION

29097

2.242 kg/m

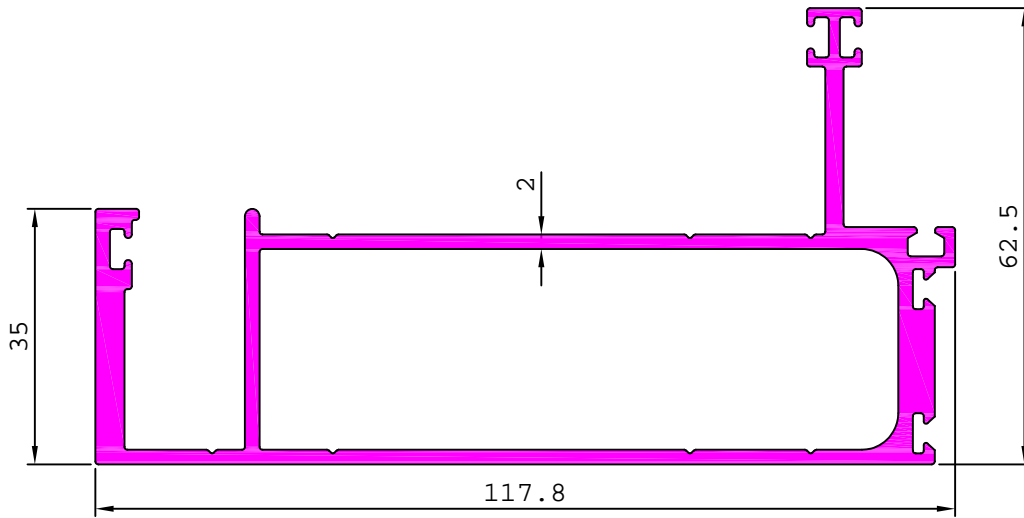

29098

2.241 kg/m

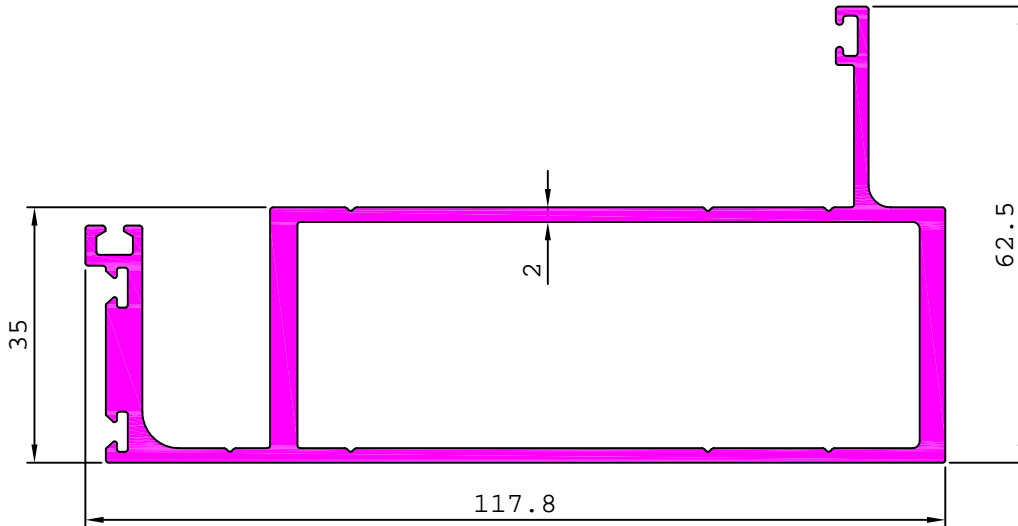

29101

2.750 kg/m

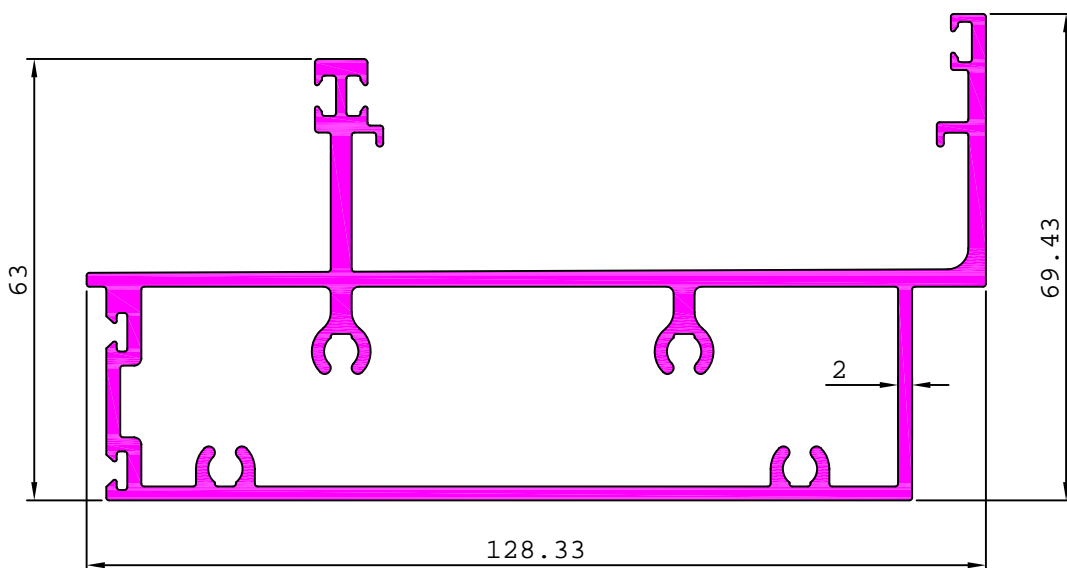

ARCHITECTURAL

CURTAIN WALL SECTION

29100

117.8

1.553 kg/m

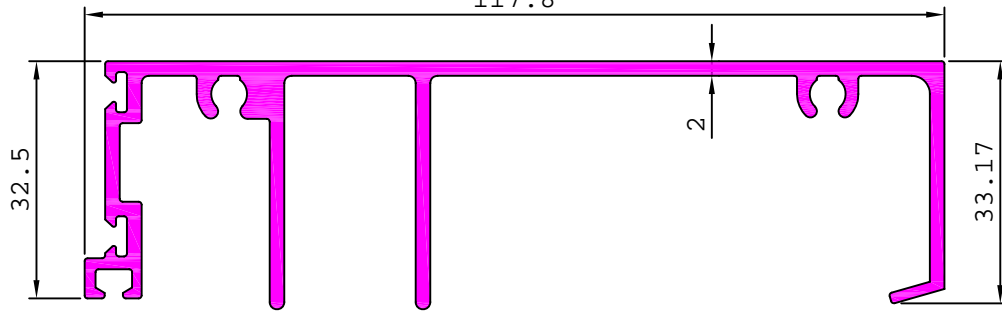

29102

1.215 kg/m

29105

0.497 kg/m

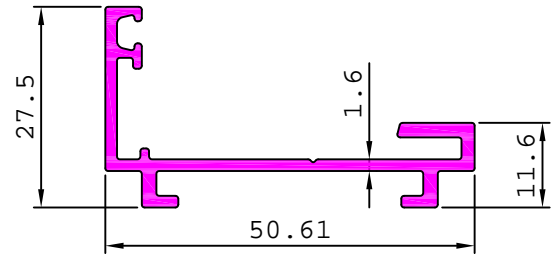
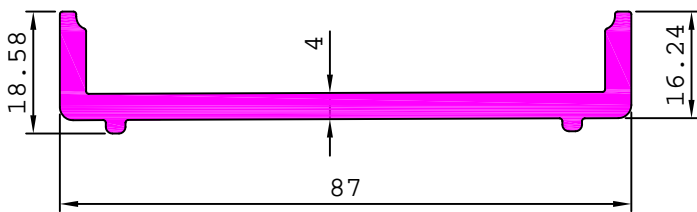

29106

1.379 kg/m

29150

0.692 kg/m

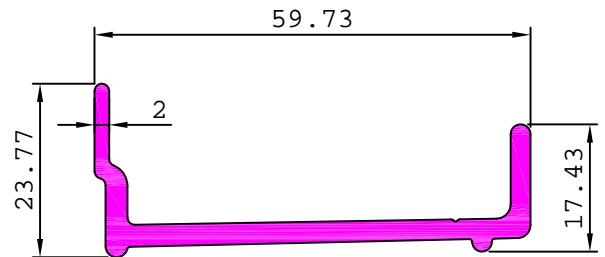
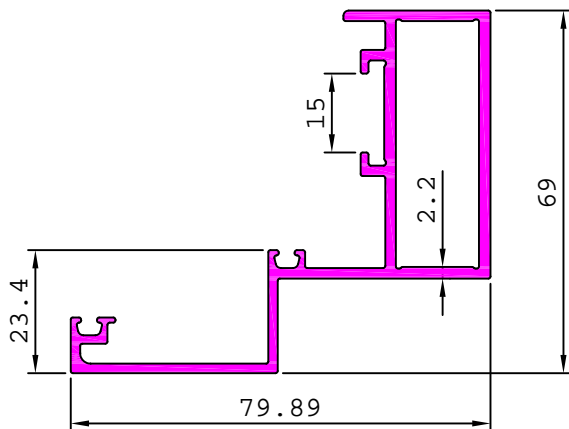

MATCHING WITH 29152

29116

3.555 kg/m

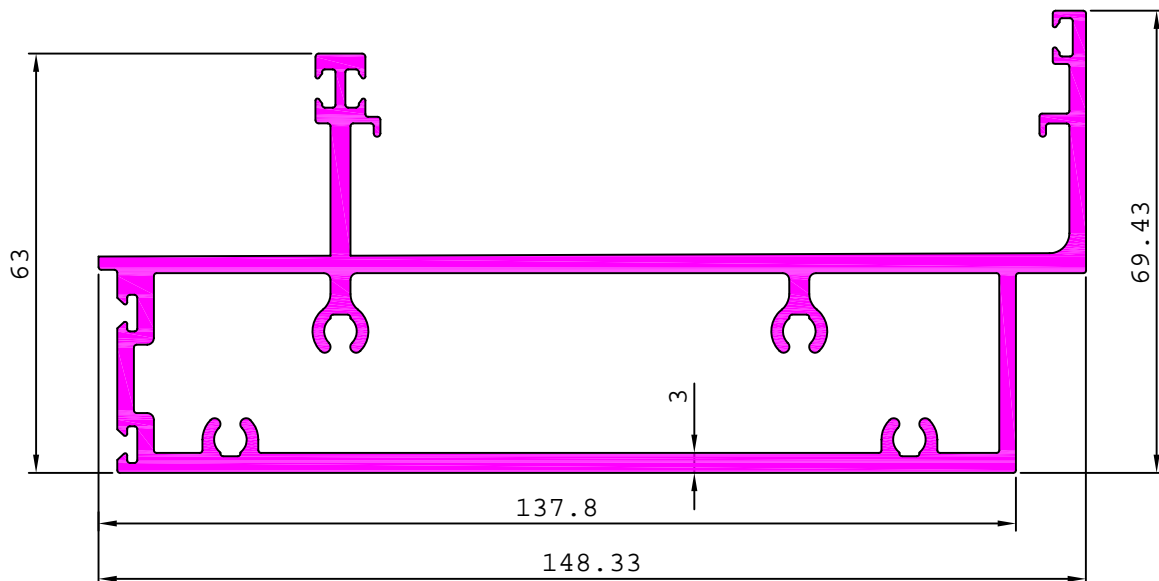

ARCHITECTURAL

CURTAIN WALL SECTION

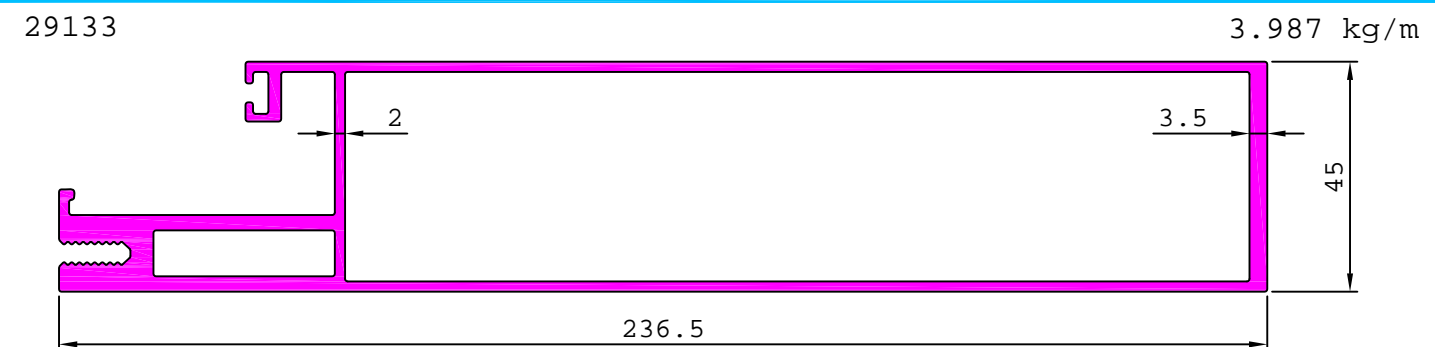
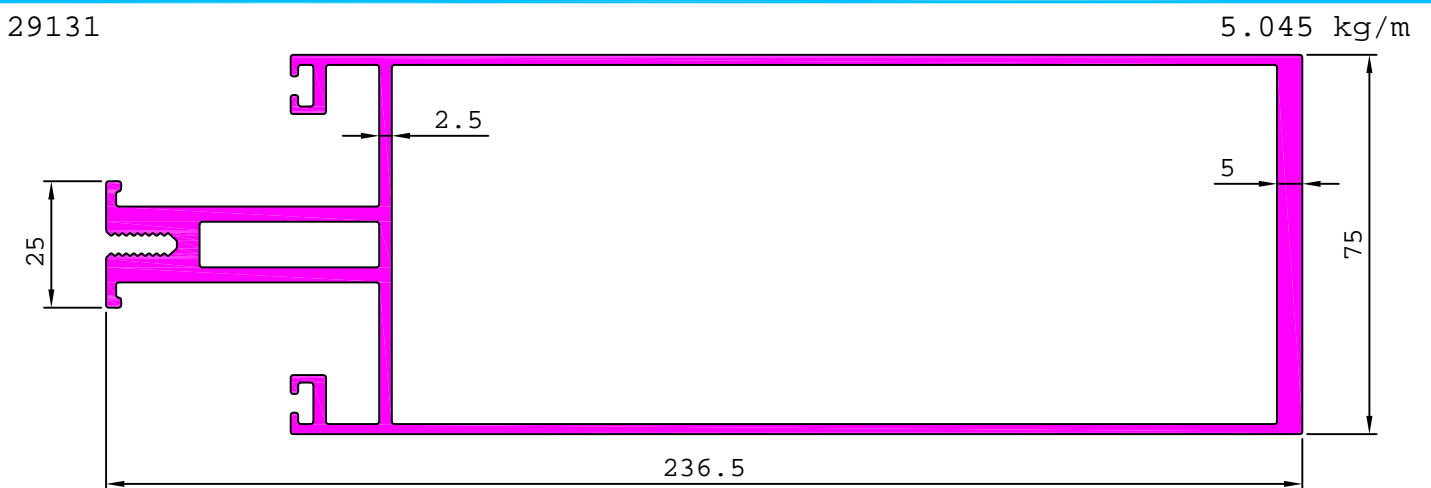
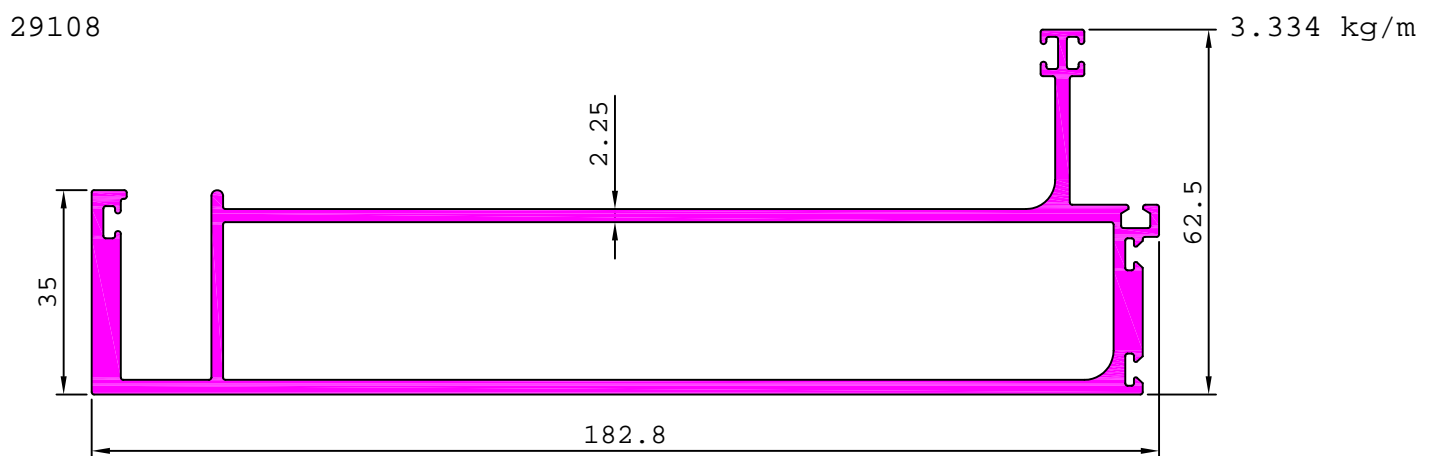
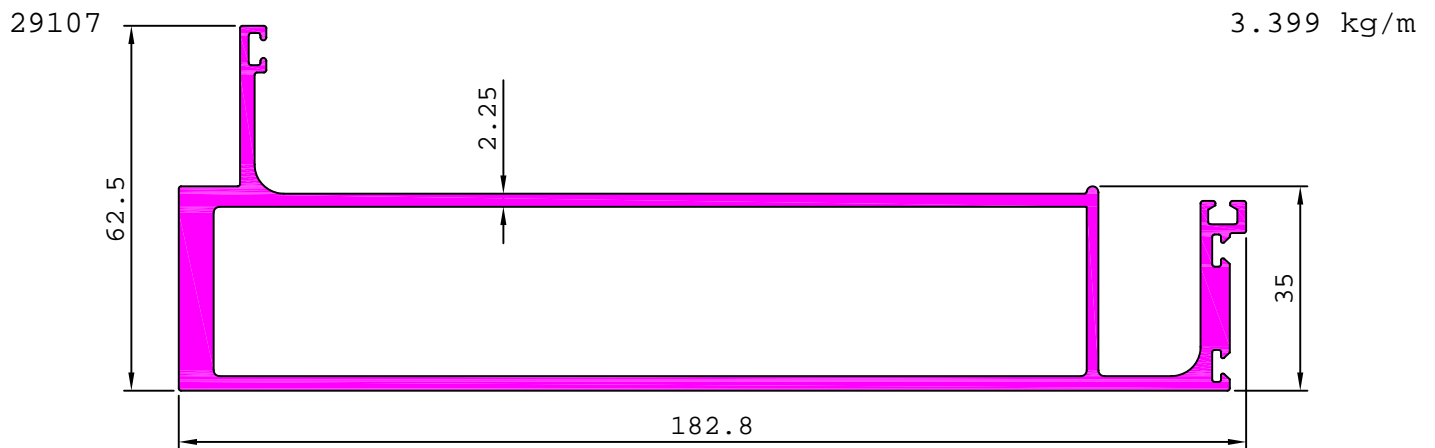

ARCHITECTURAL

CURTAIN WALL SECTION

29132

4.232 kg/m

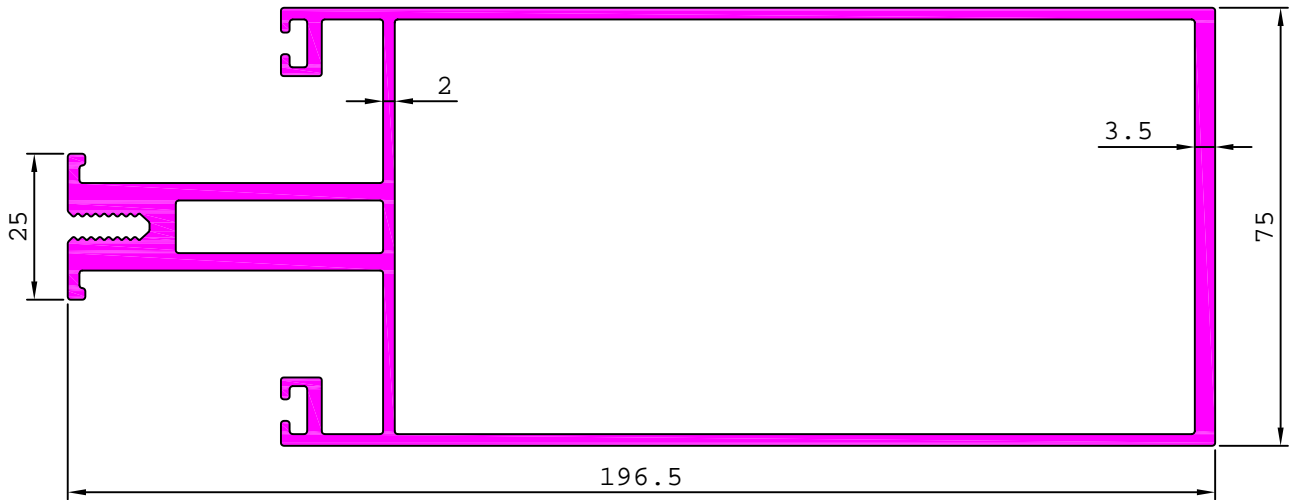

29134

3.555 kg/m

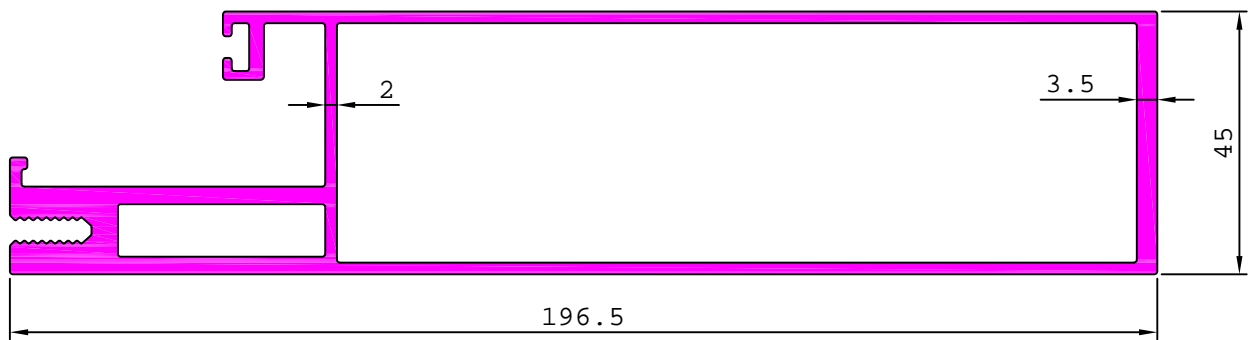

29148

2.859 kg/m

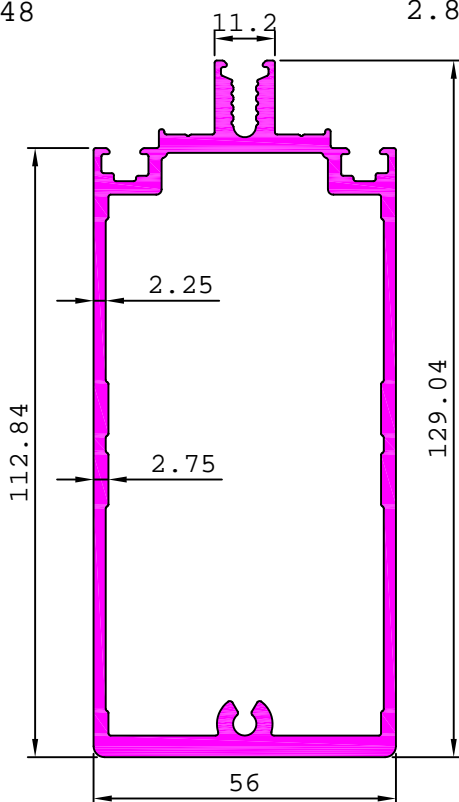

29149

3.309 kg/m

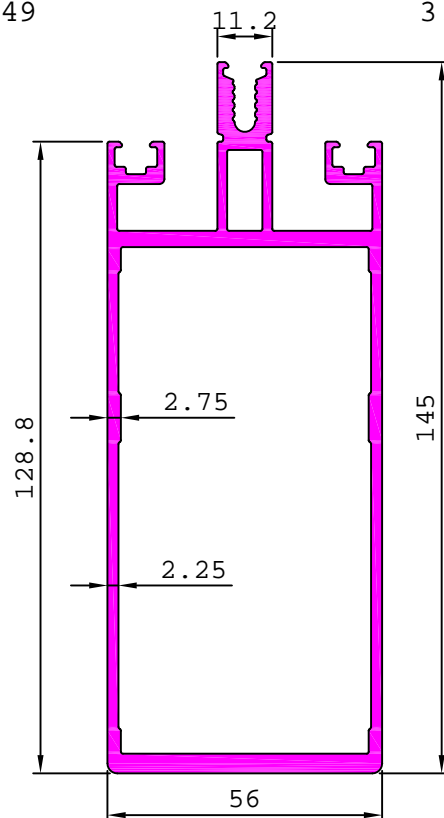

ARCHITECTURAL

CURTAIN WALL SECTION

29151

2.978 kg/m

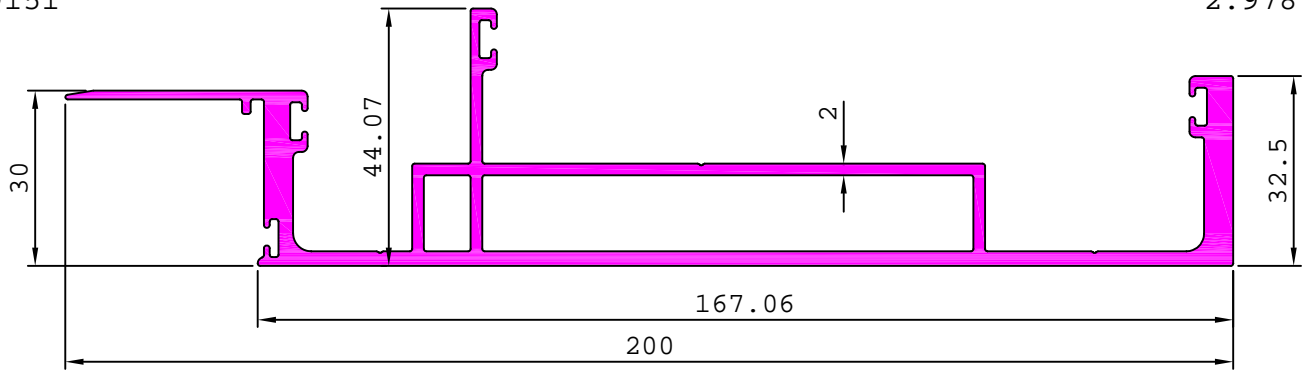

29152

2.672 kg/m

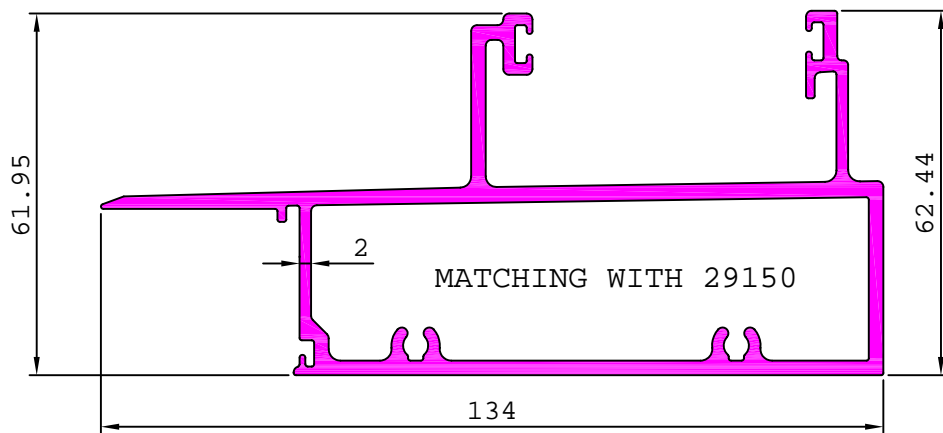

29153

3.156 kg/m

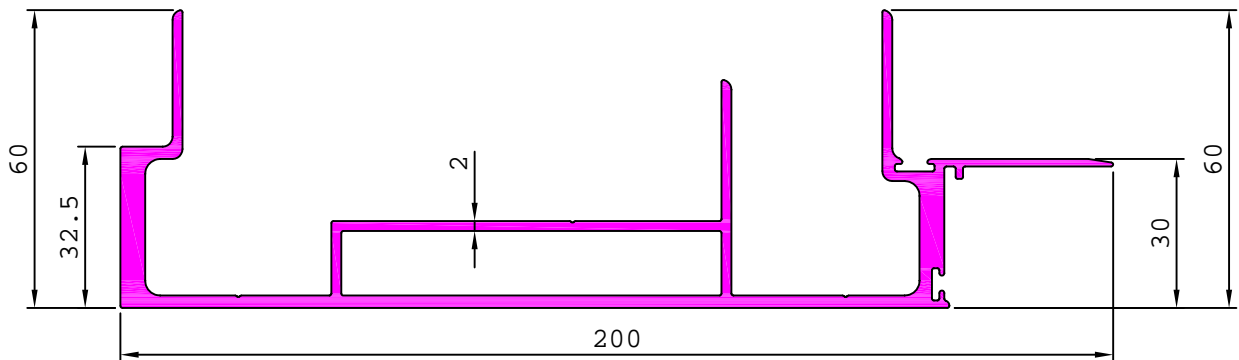

29154

1.497 kg/m

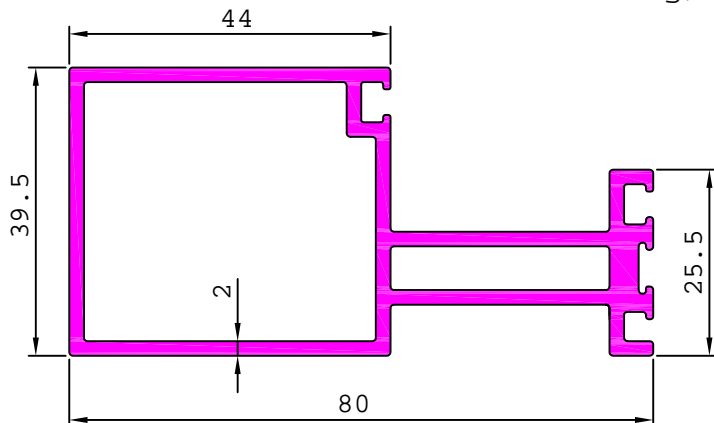

29155

0.688 kg/m

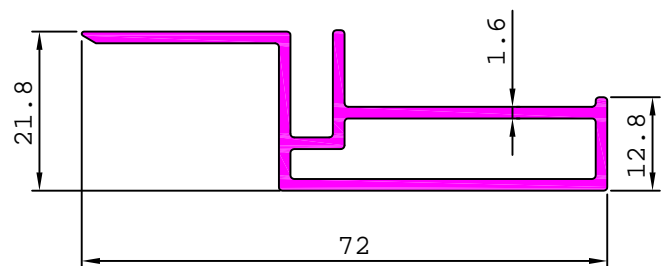

ARCHITECTURAL

CURTAIN WALL SECTION

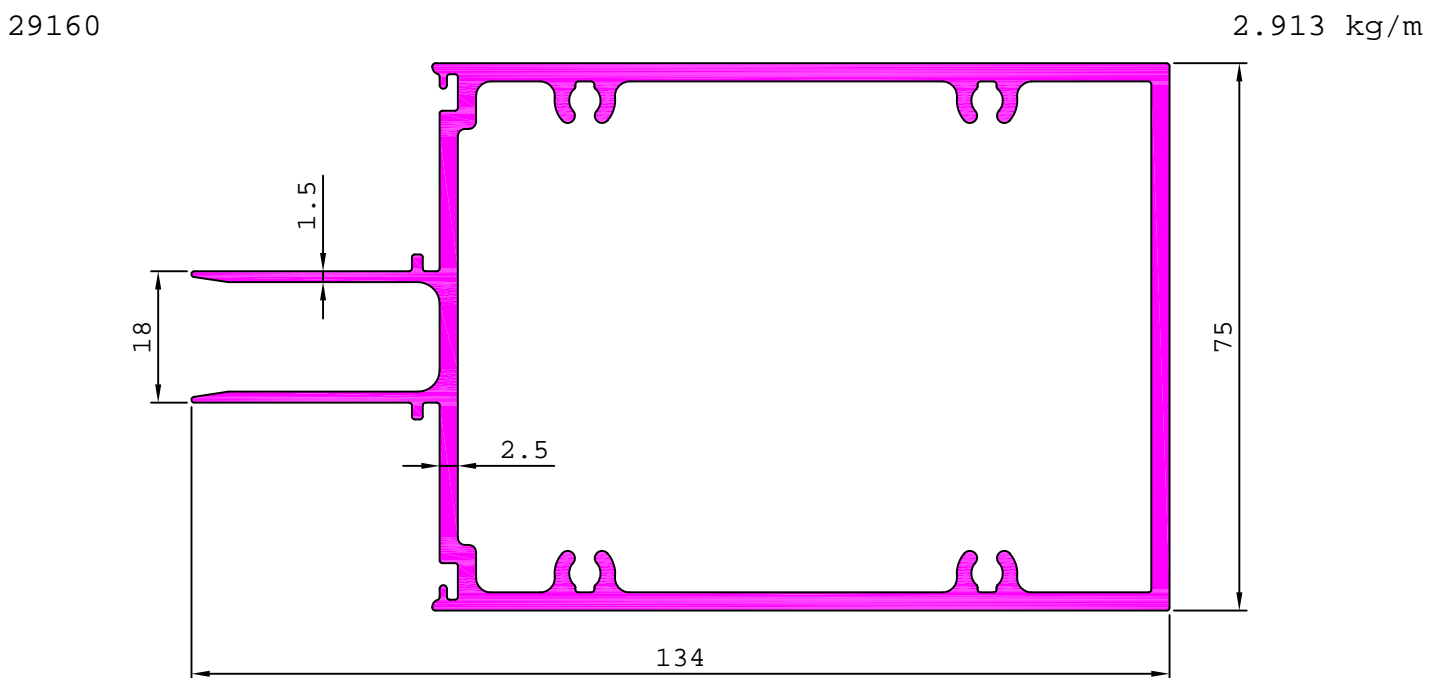
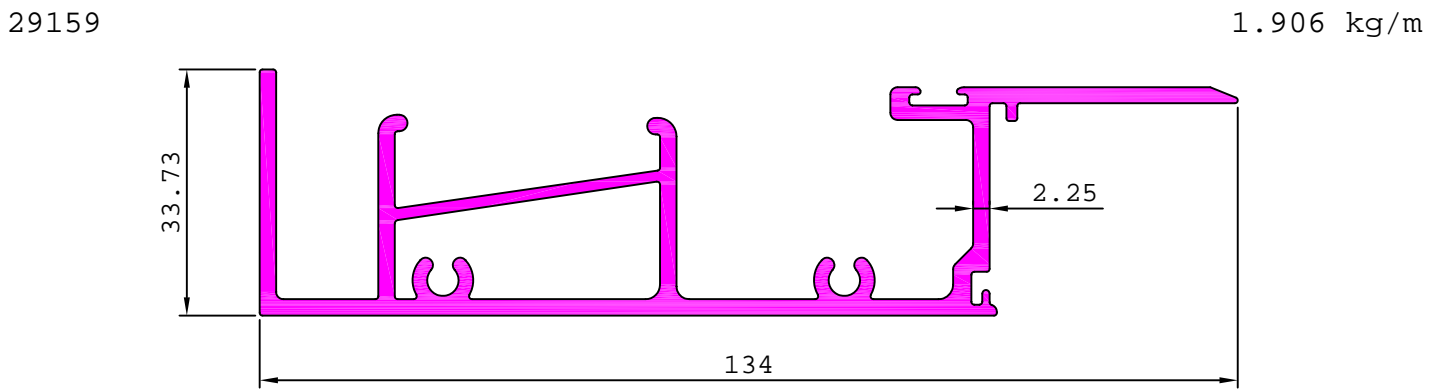
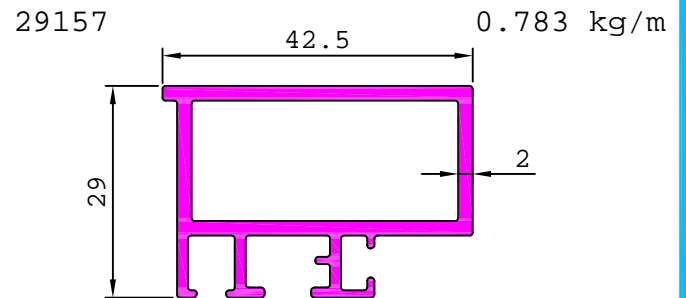
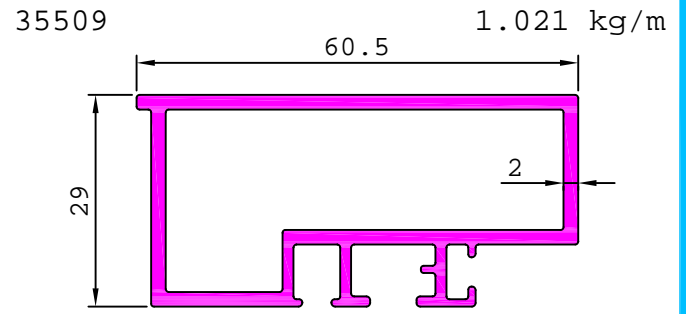
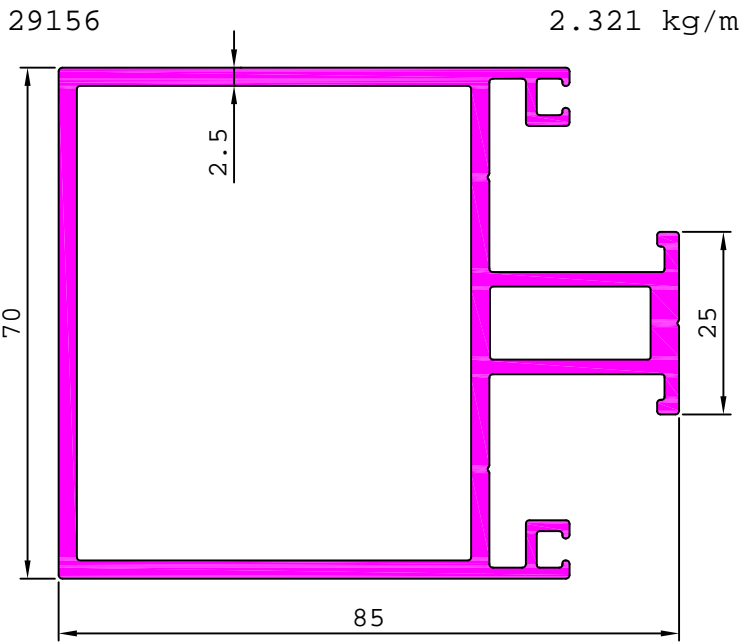

ARCHITECTURAL

CURTAIN WALL SECTION

29161

2.638 kg/m

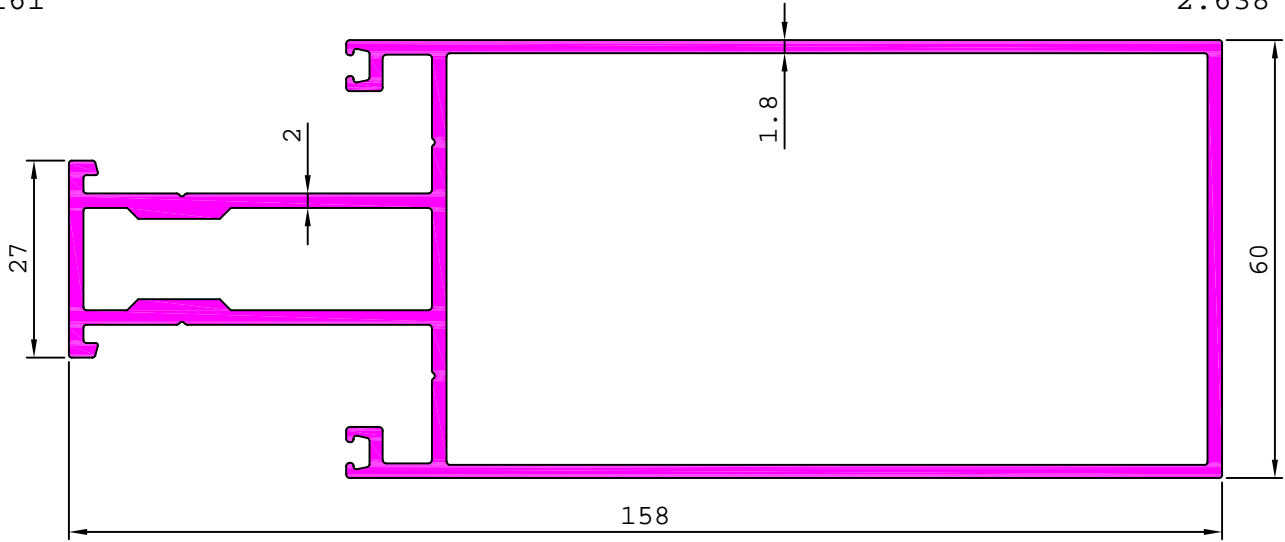

29187

1.674 kg/m

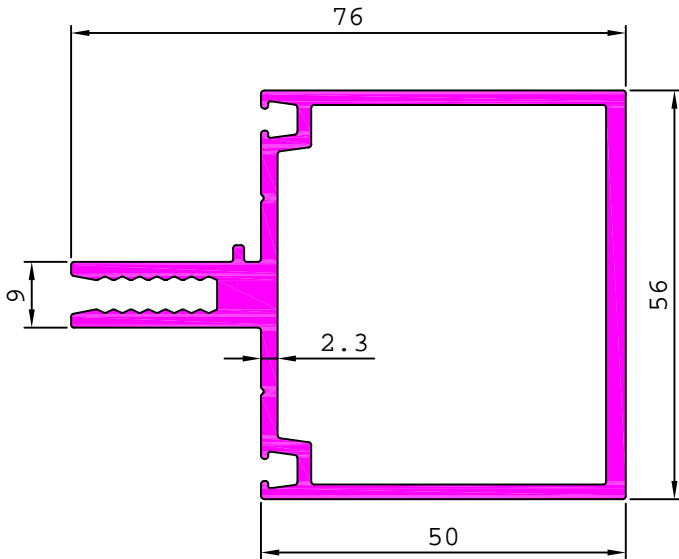

29188

1.458 kg/m

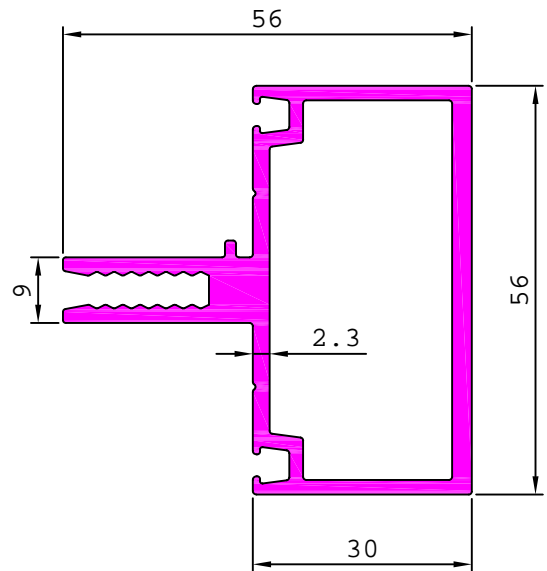

29189

2.268 kg/m

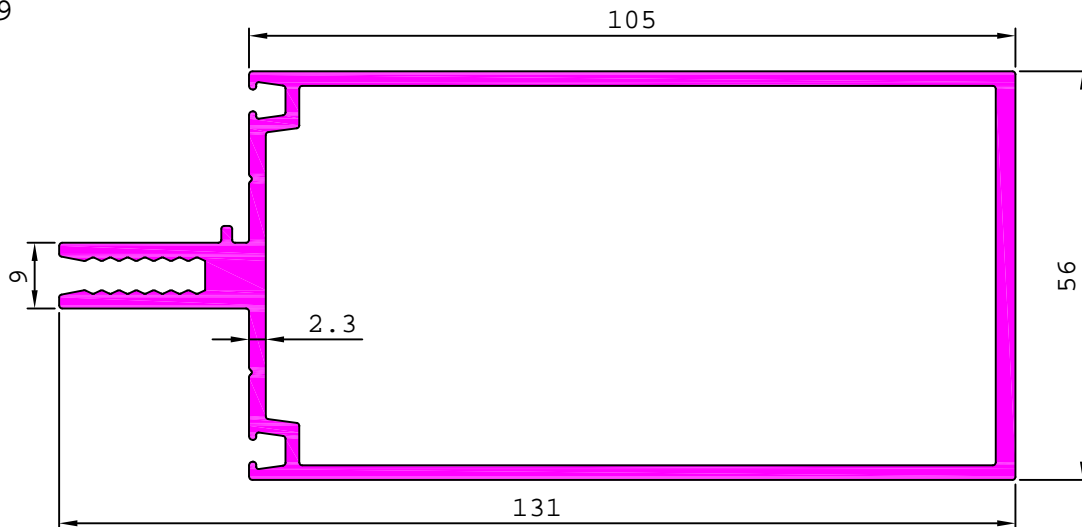

ARCHITECTURAL

CURTAIN WALL SECTION

29190

0.277 kg/m

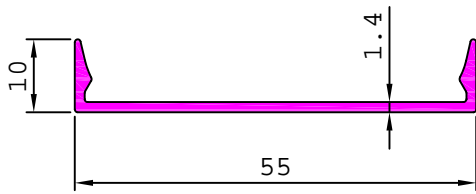

29191

0.532 kg/m

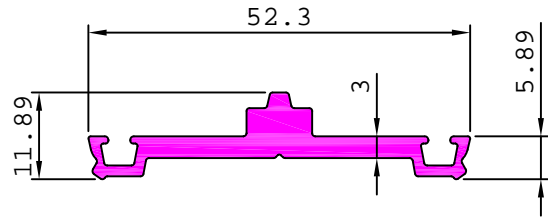

29200

4.222 kg/m

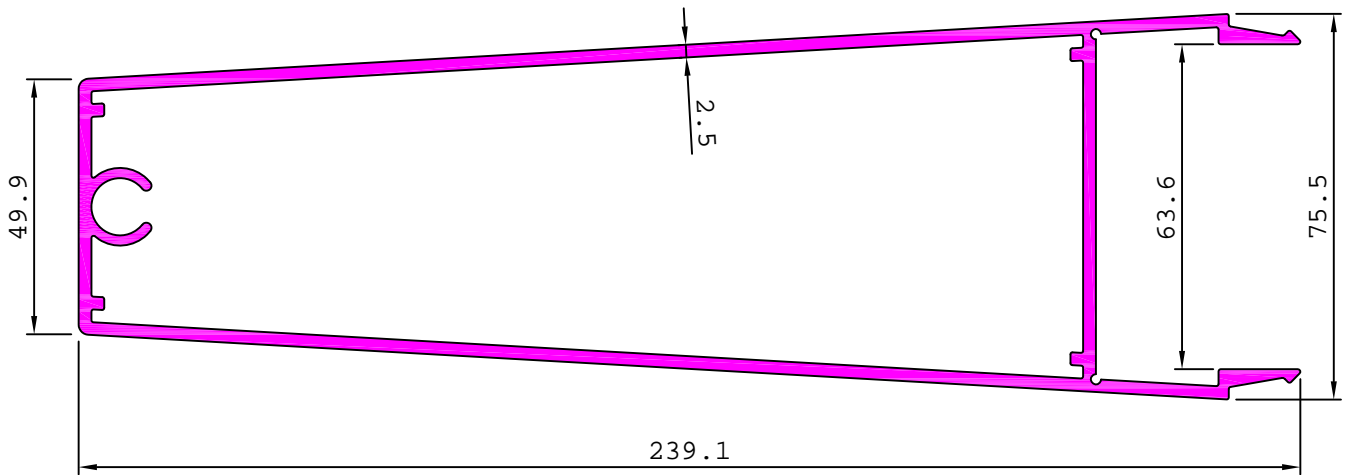

29201

4.296 kg/m

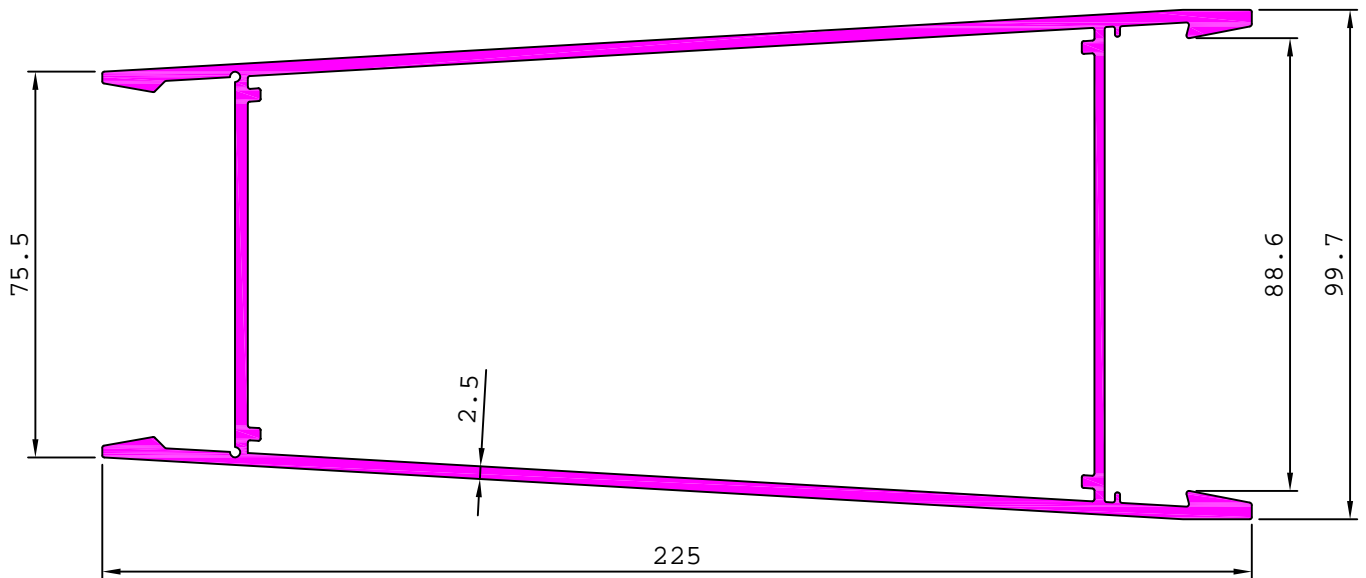

29202

0.392 kg/m

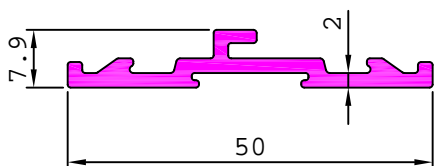

29205

0.137 kg/m

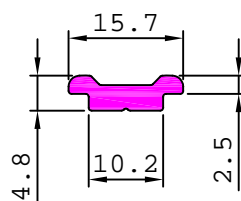

29207

0.377 kg/m

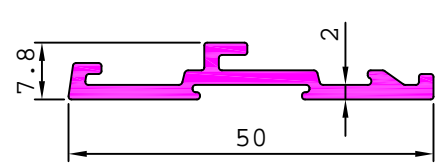

MATCHING WITH 29203, 29204

MATCHING WITH 29203, 29204

MATCHING WITH 29203, 29204

ARCHITECTURAL

CURTAIN WALL SECTION

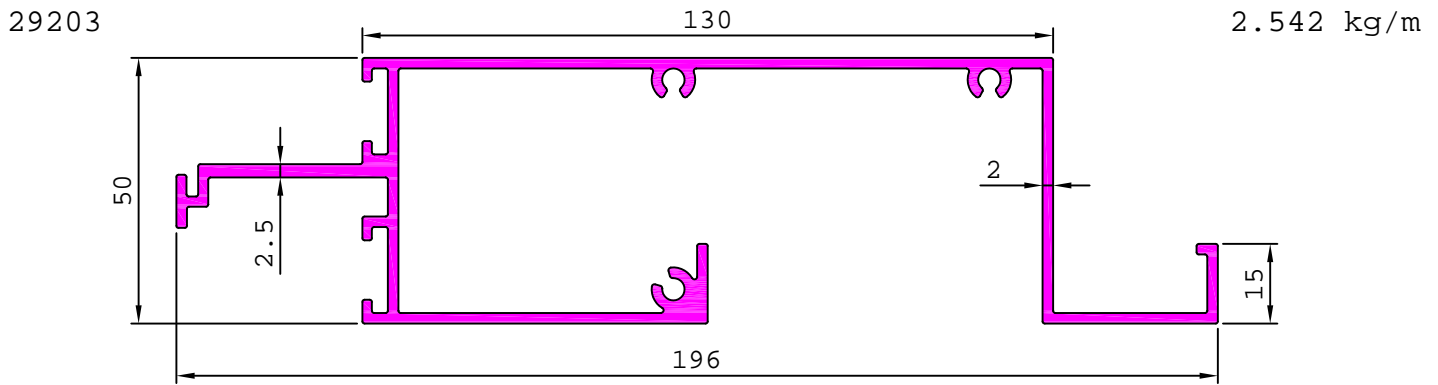

MATCHING WITH 29202, 29205, 29207

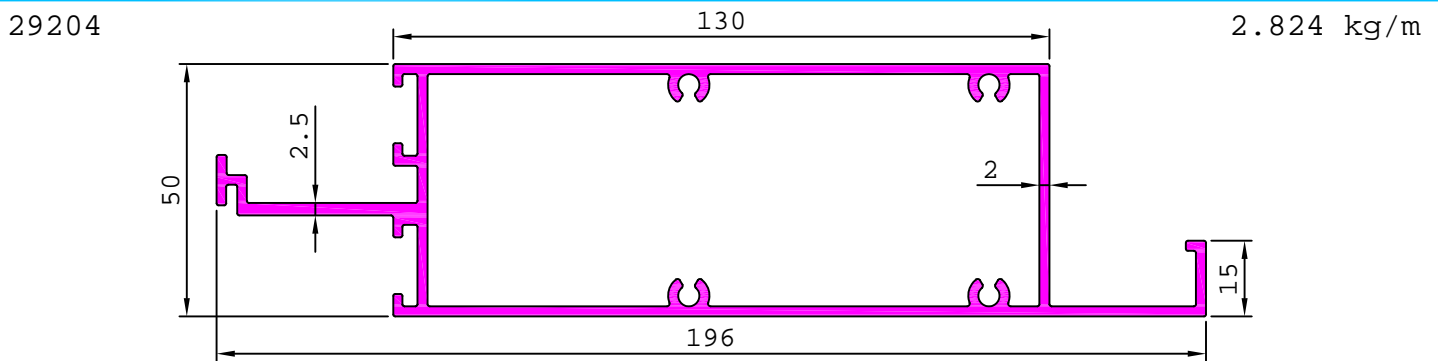

MATCHING WITH 29202, 29205, 29207

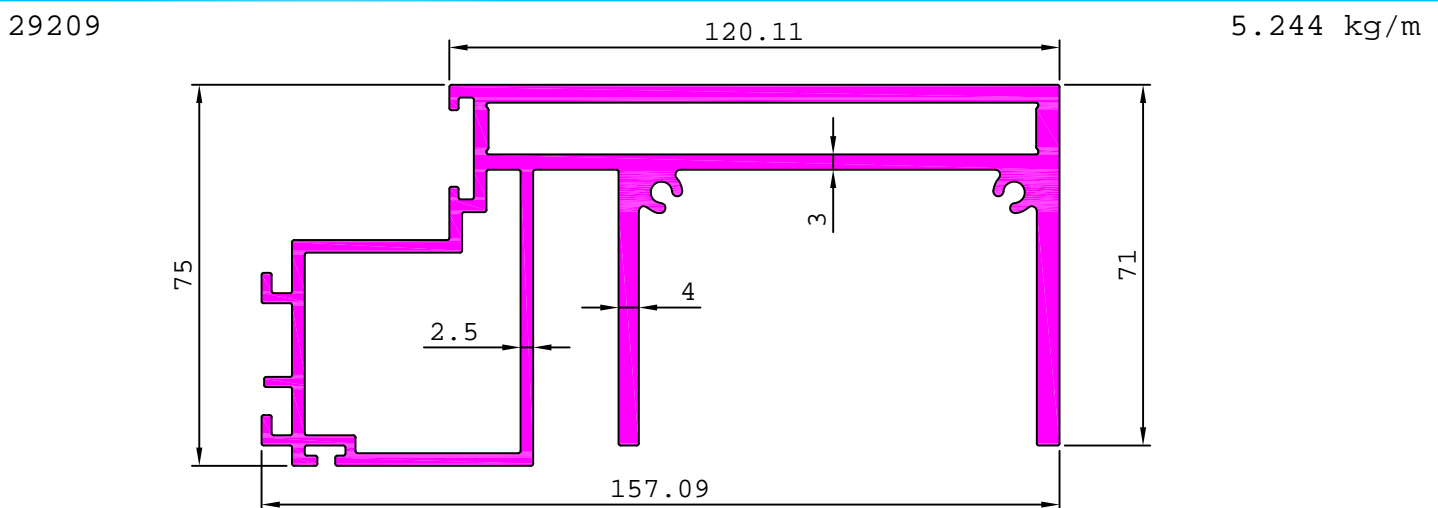
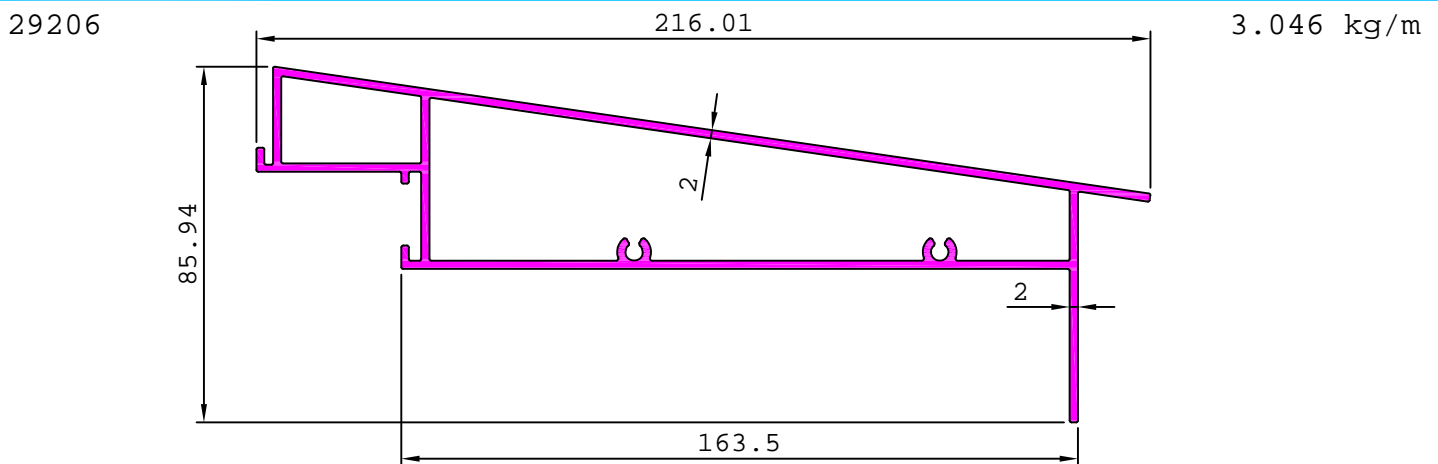

ARCHITECTURAL

CURTAIN WALL SECTION

29208

5.944 kg/m

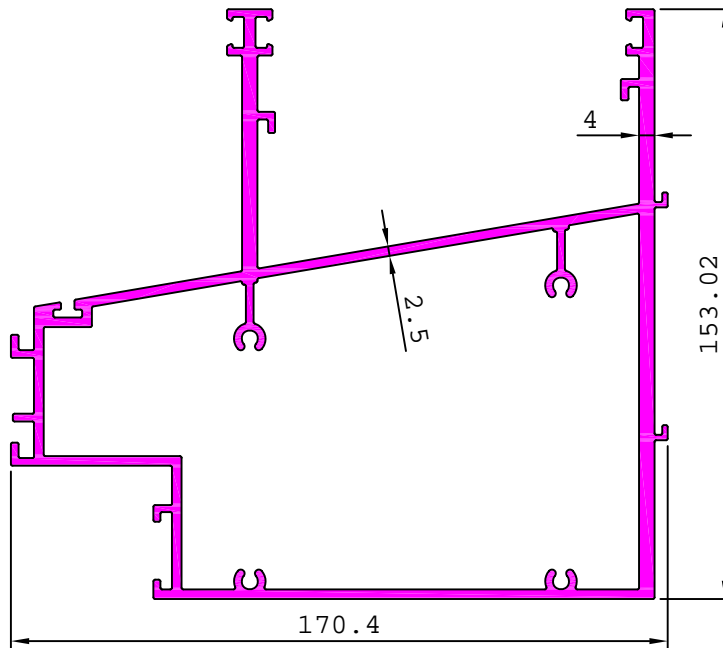

29214

2.896 kg/m

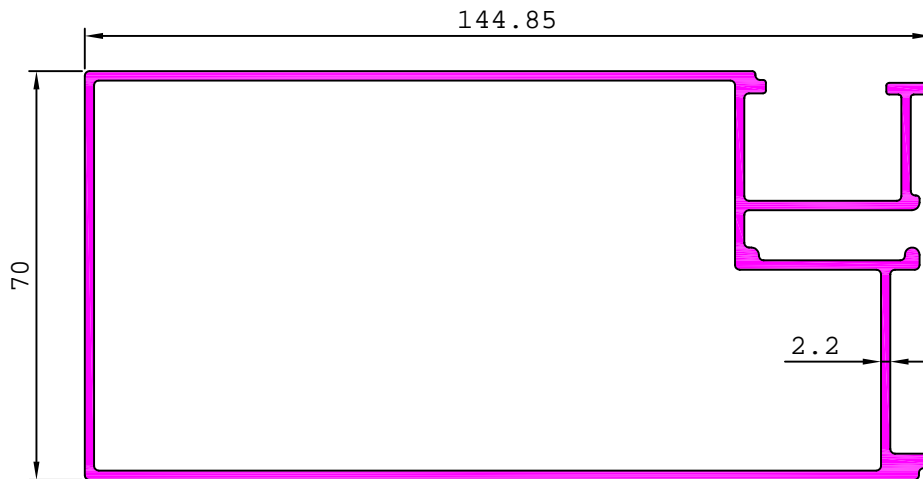

29215

2.181 kg/m

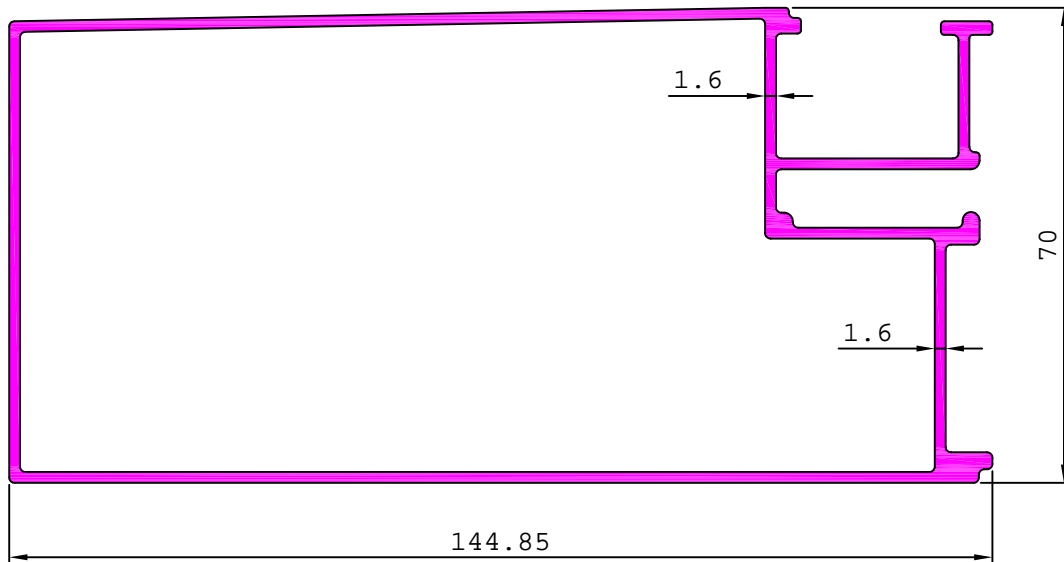

ARCHITECTURAL

CURTAIN WALL SECTION

29216

2.007 kg/m

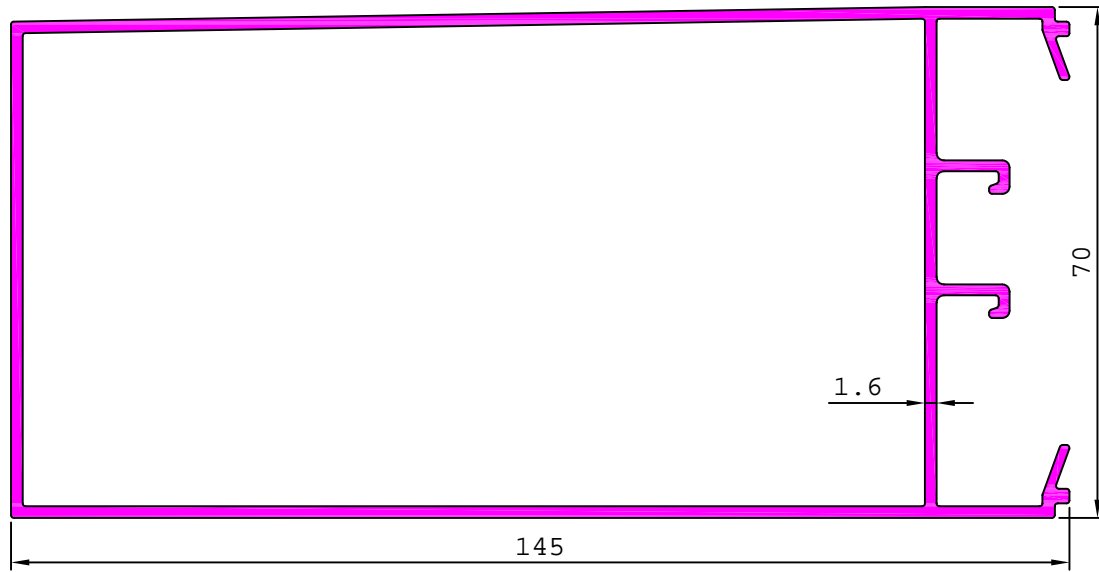

29218

2.367 kg/m

29224

0.572 kg/m

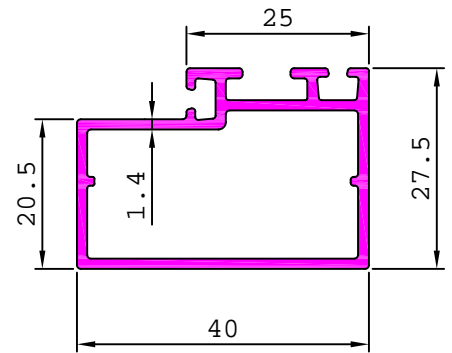
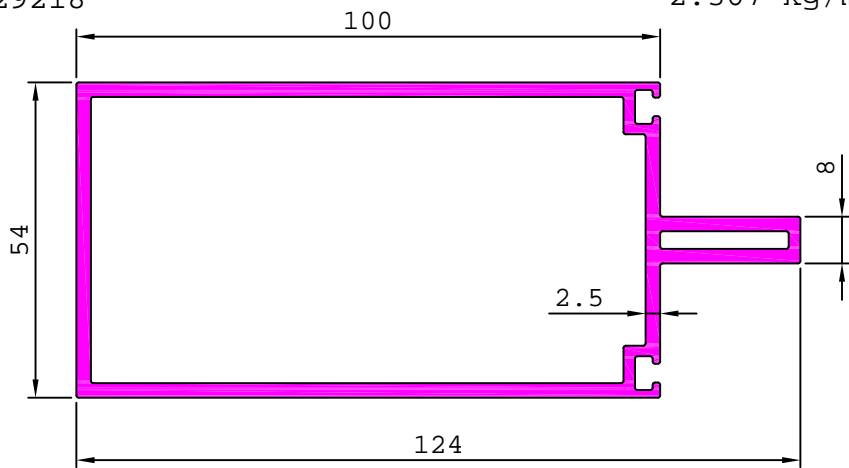

29217

1.557 kg/m

29221

2.040 kg/m

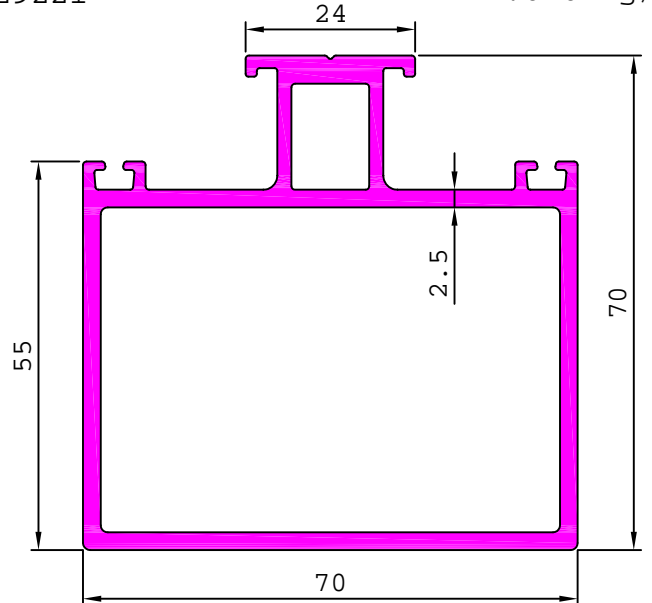
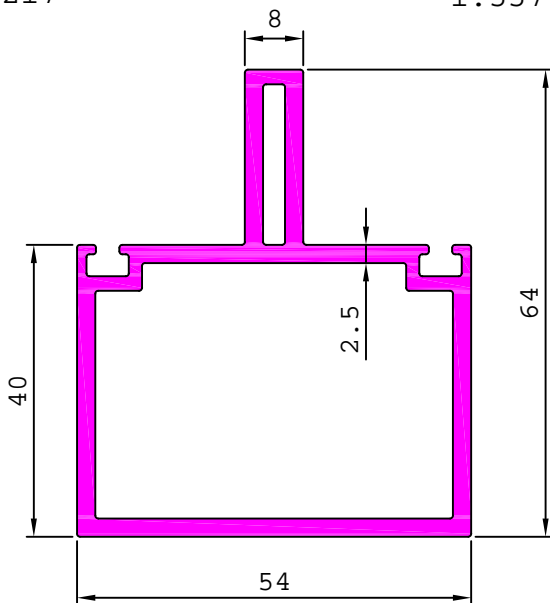

ARCHITECTURAL

CURTAIN WALL SECTION

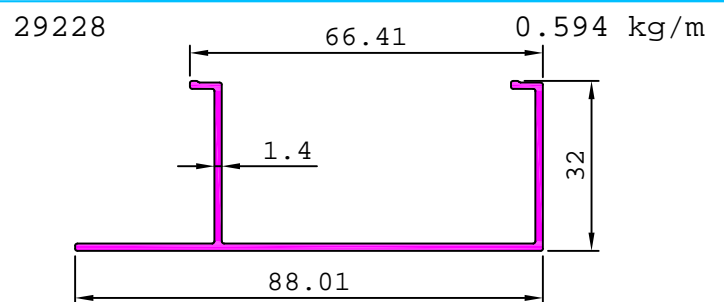
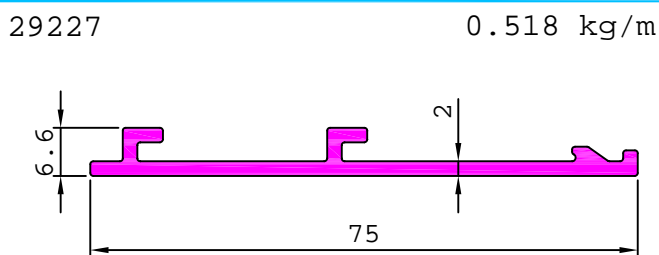
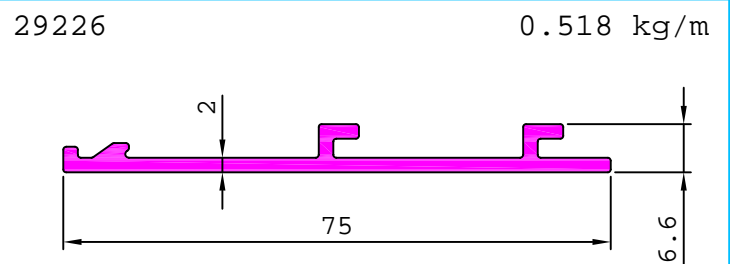
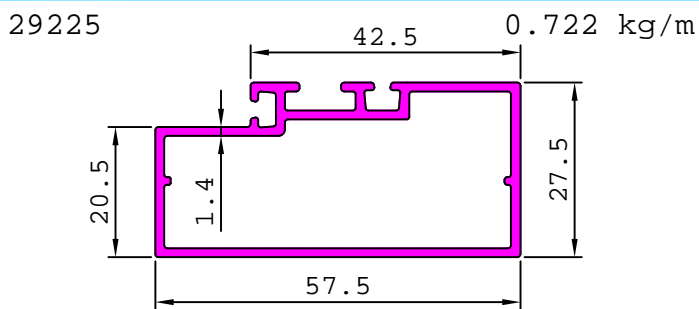
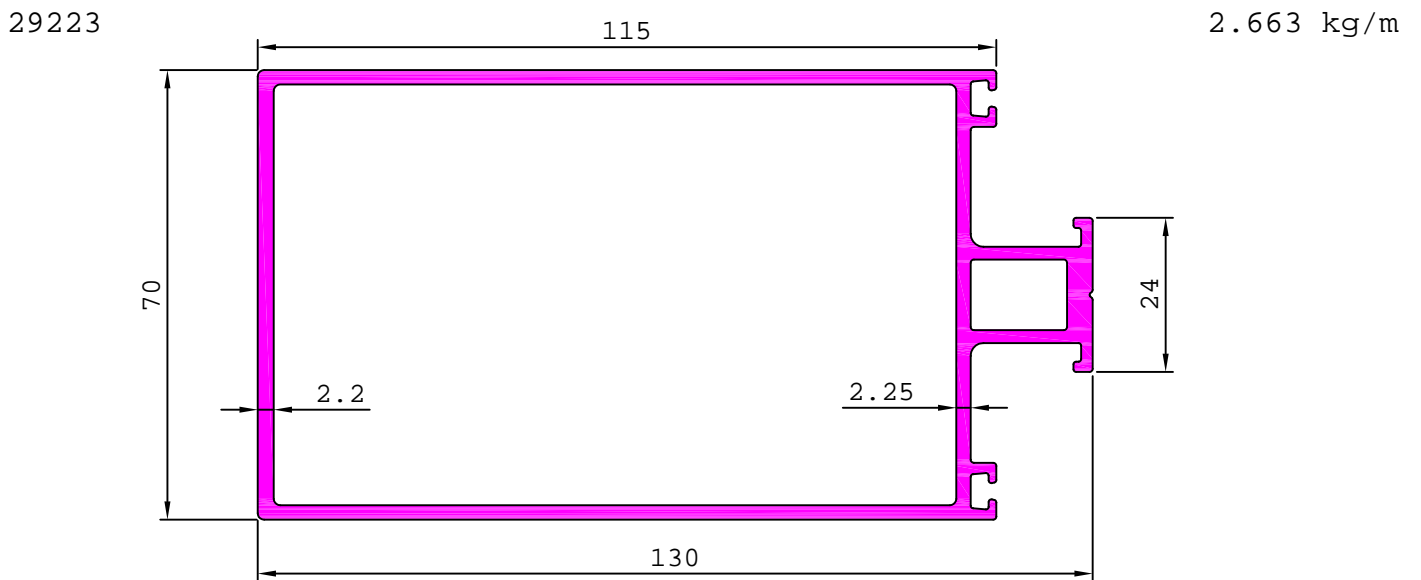
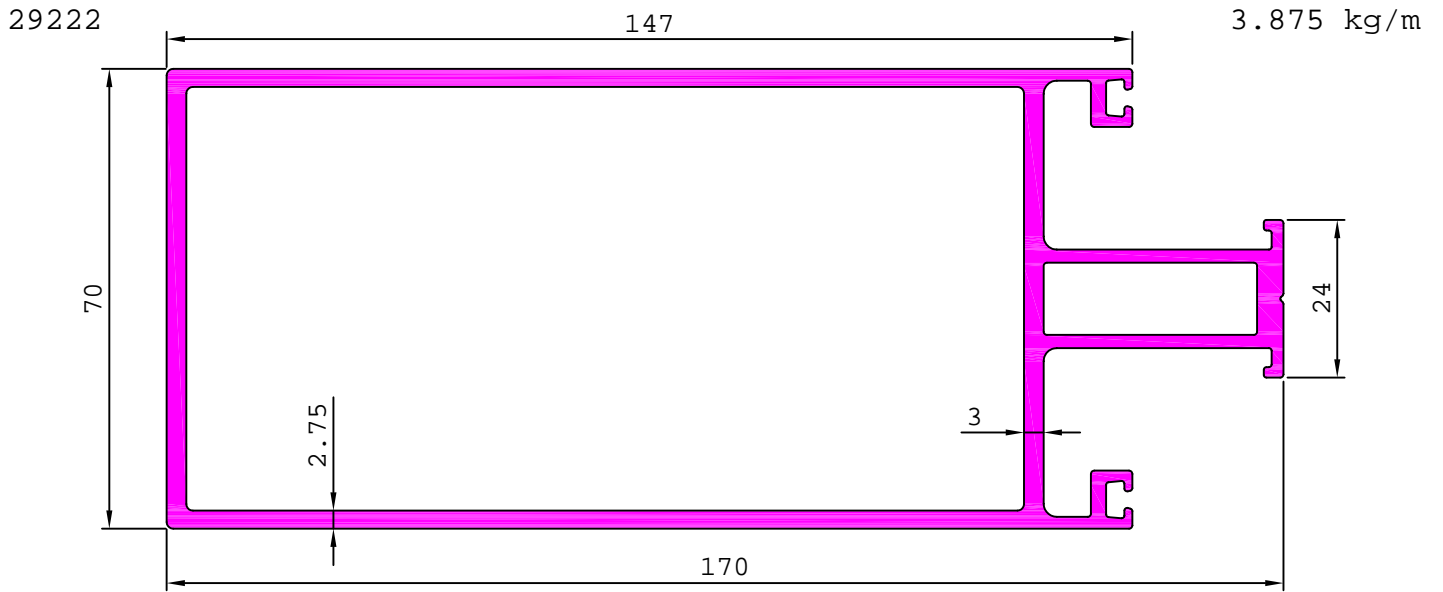

ARCHITECTURAL

CURTAIN WALL SECTION

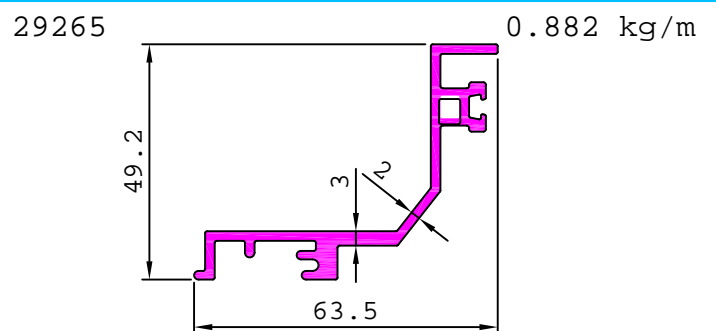
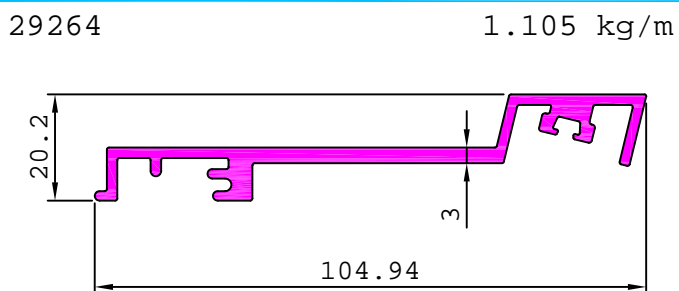
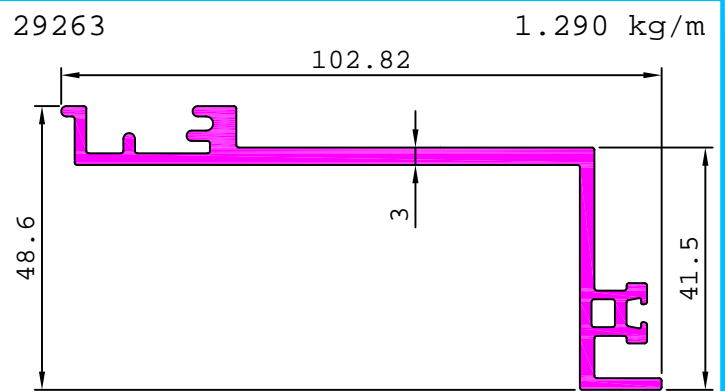
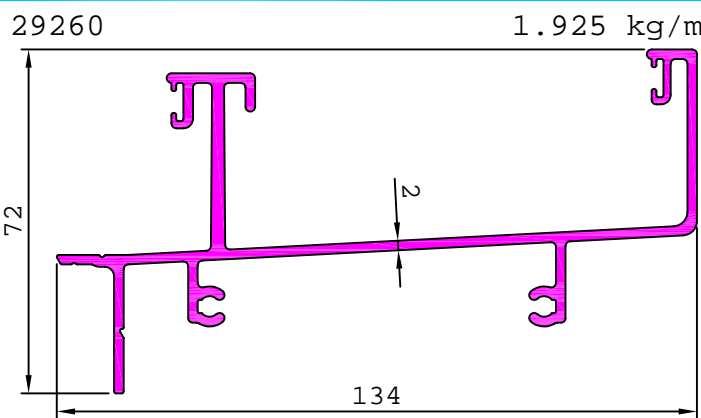
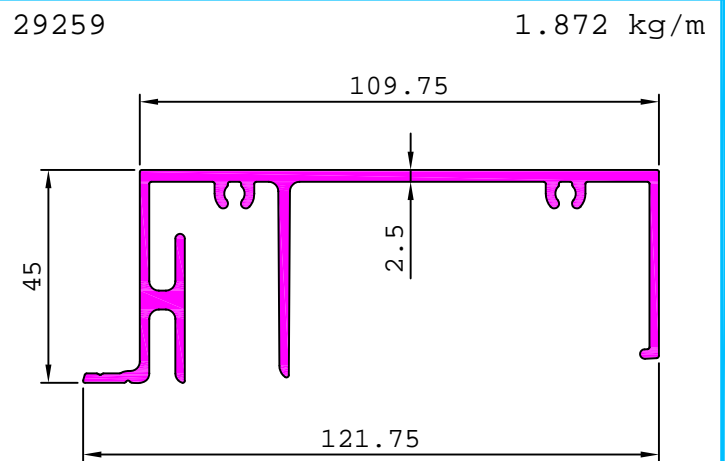
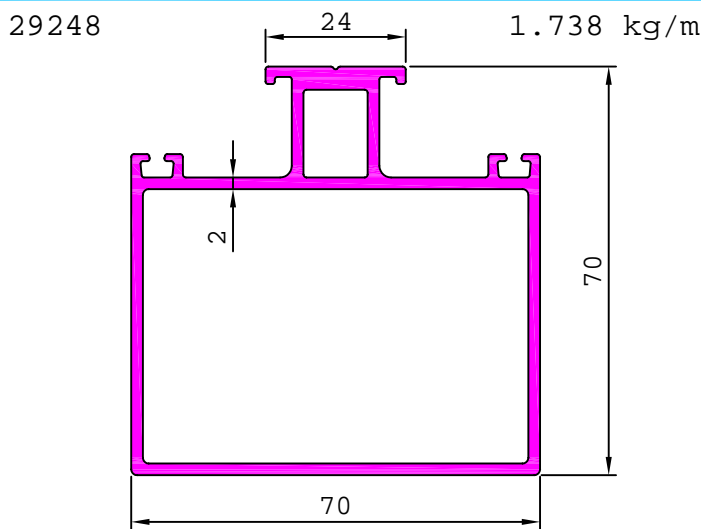
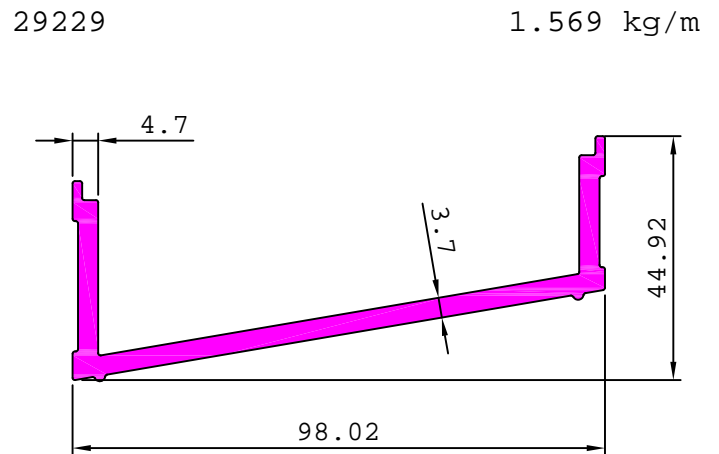
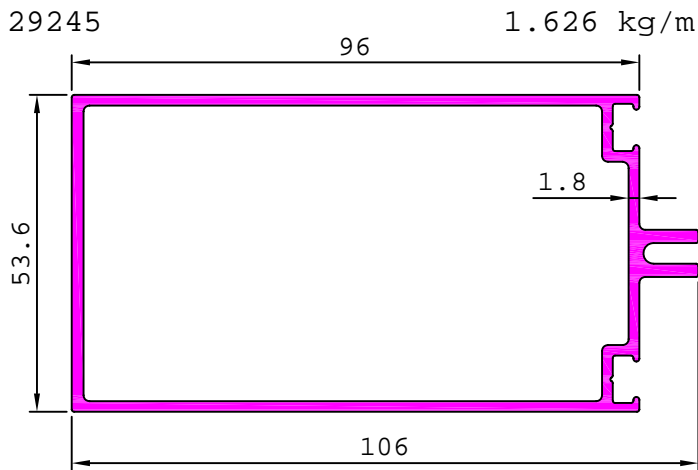

ARCHITECTURAL

CURTAIN WALL SECTION

29261

4.305 kg/m

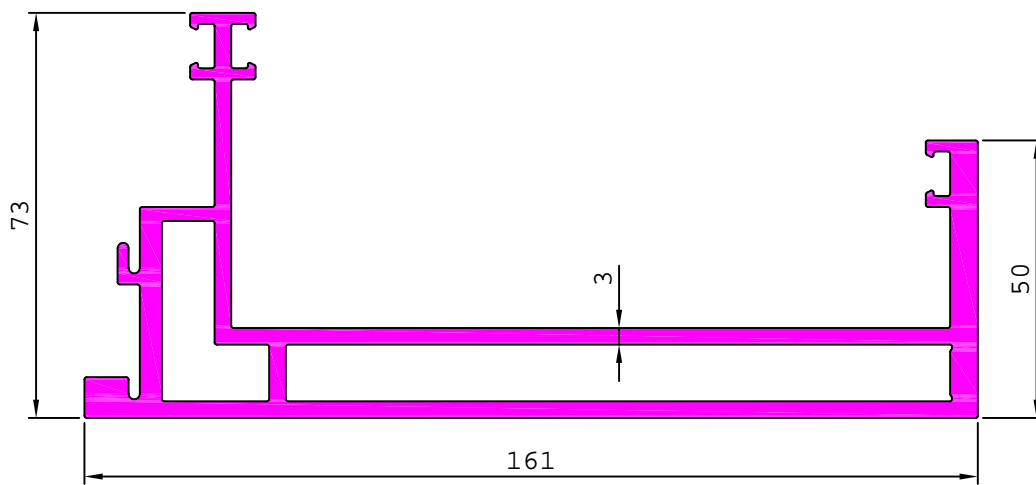

29262

4.059 kg/m

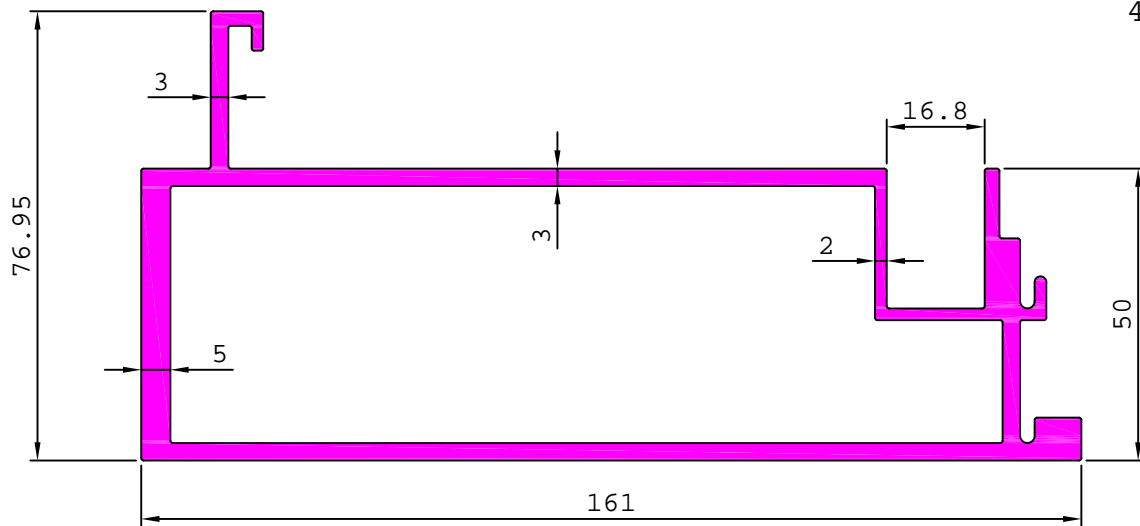

29268

5.991 kg/m

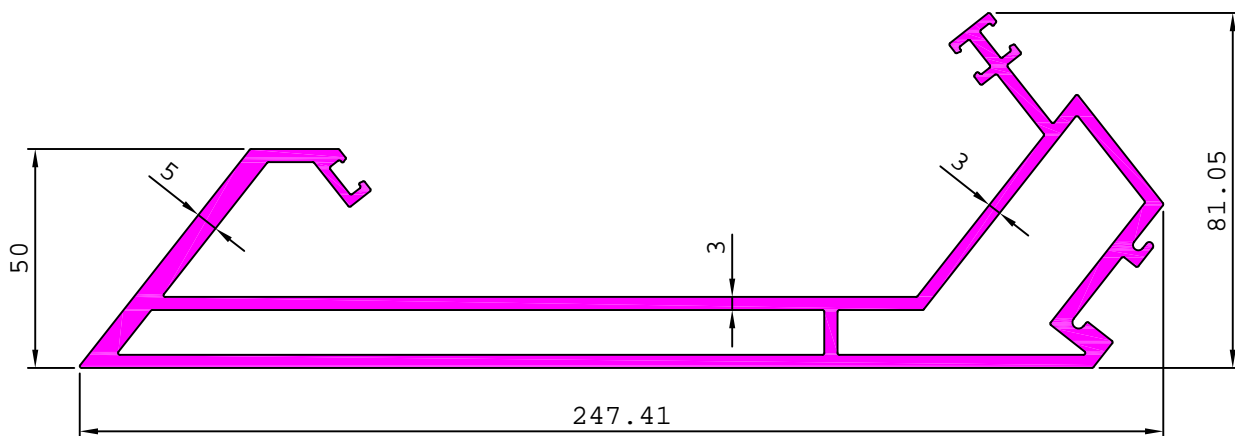

29266

0.981 kg/m

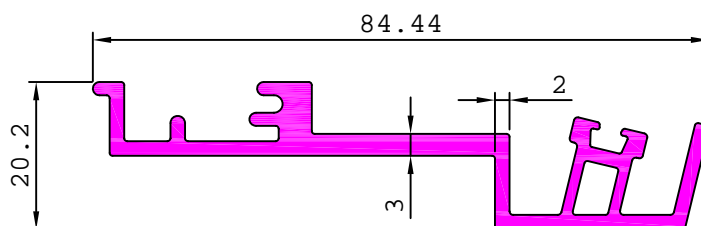

ARCHITECTURAL

CURTAIN WALL SECTION

29267

4.795 kg/m

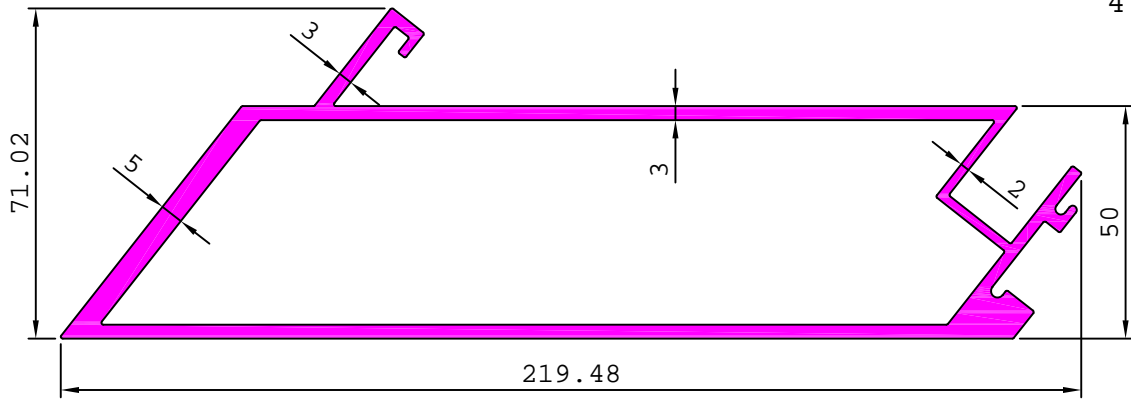

29269

5.964 kg/m

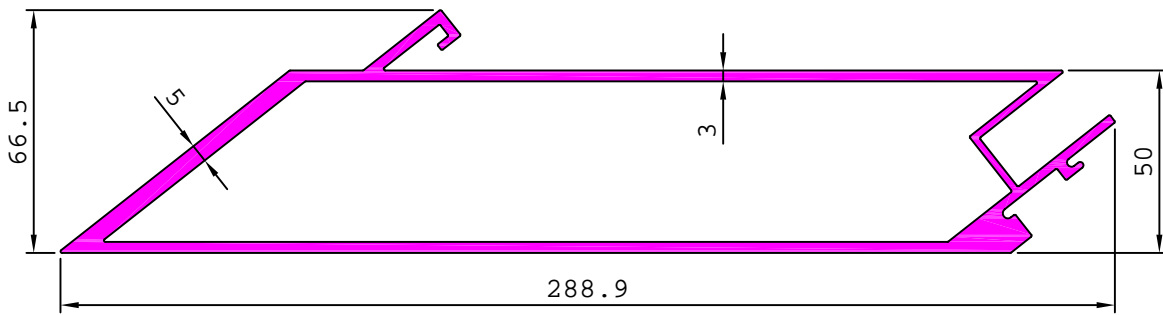

29270

7.553 kg/m

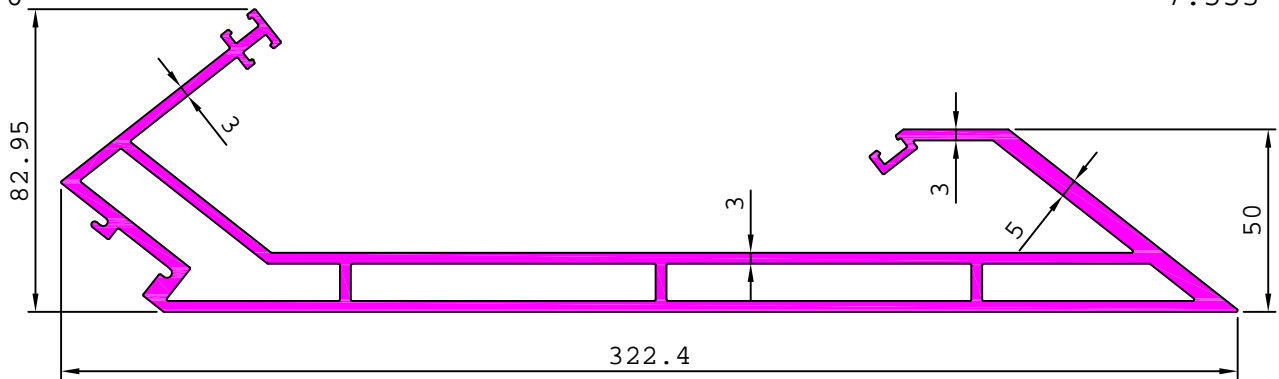

29271

5.686 kg/m

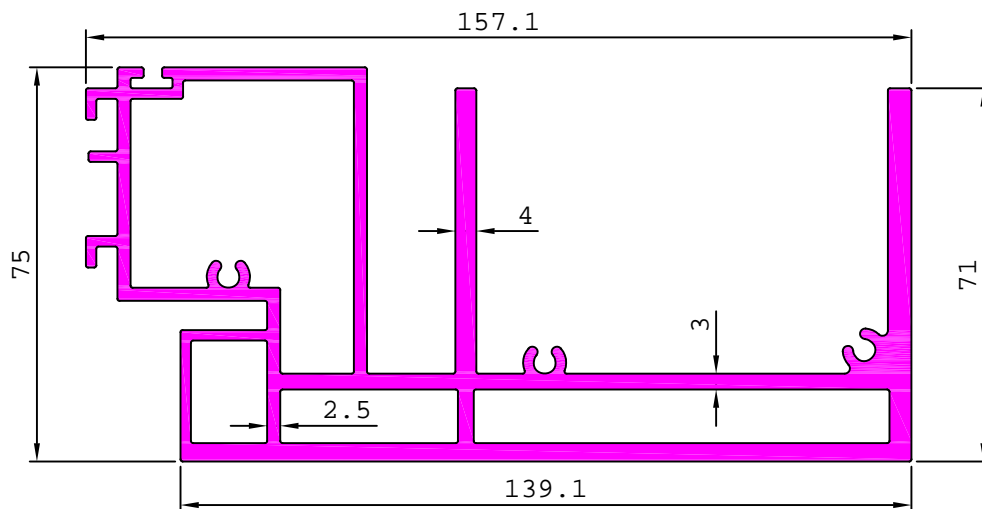

ARCHITECTURAL

CURTAIN WALL SECTION

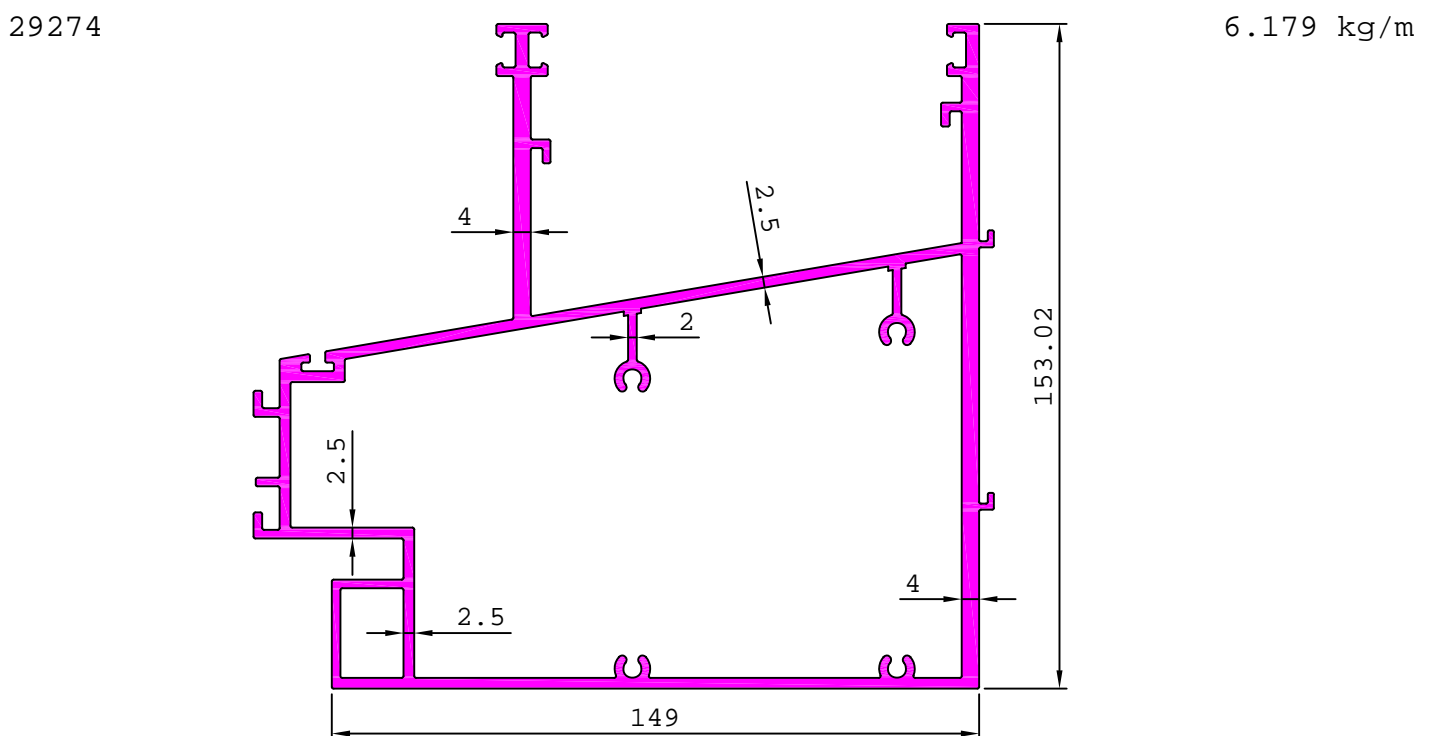
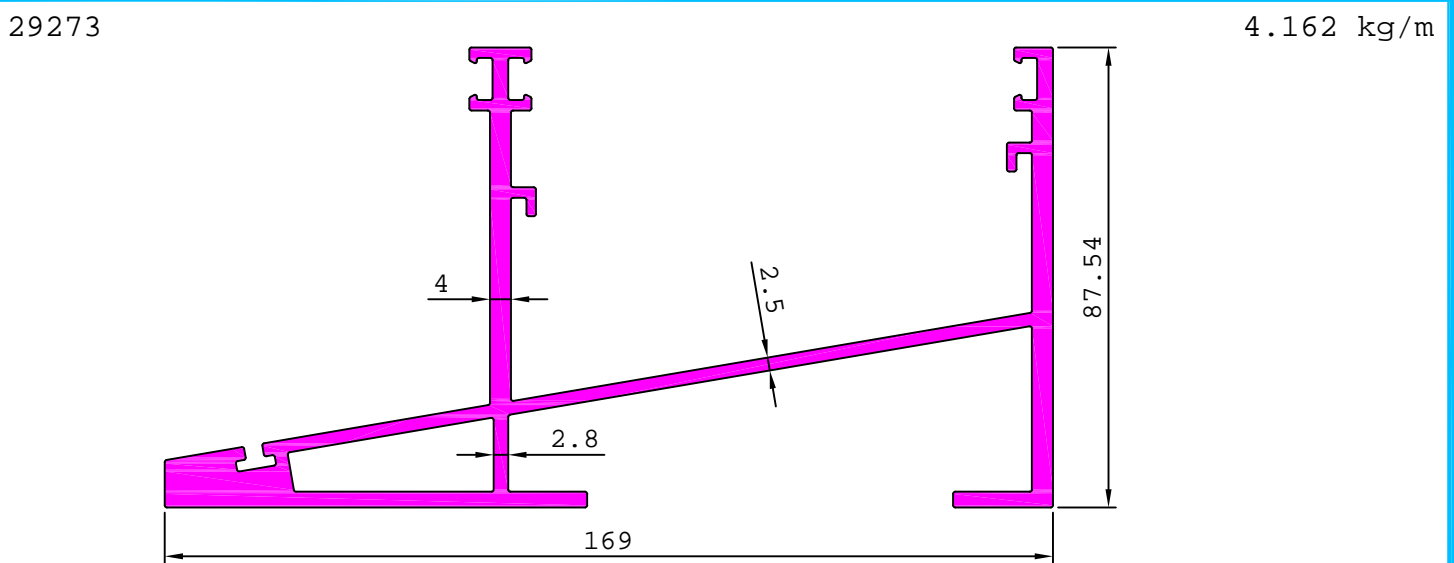
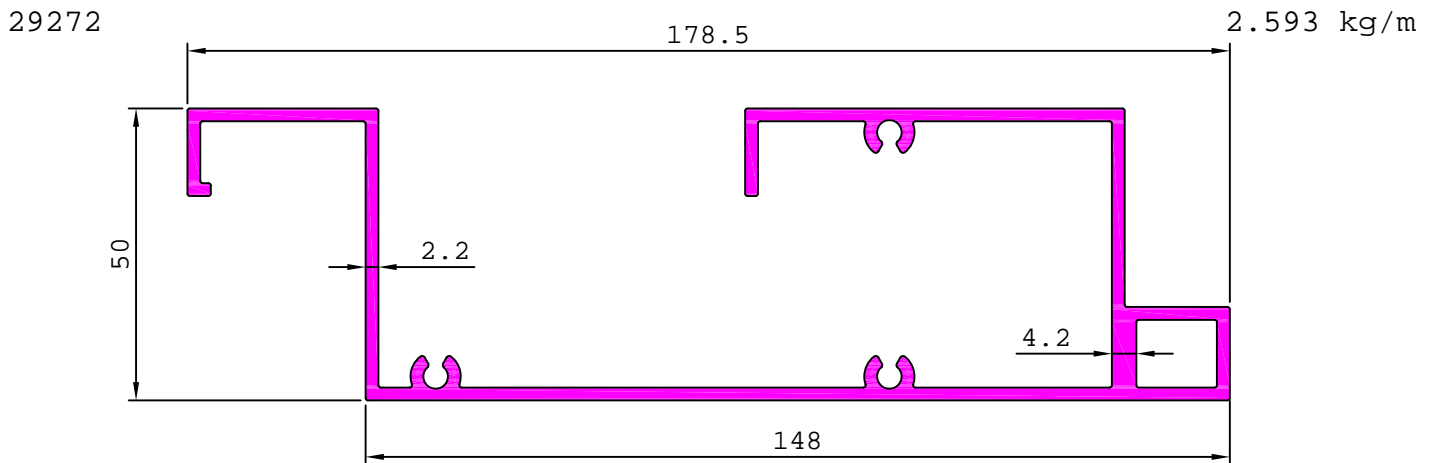

ARCHITECTURAL

CURTAIN WALL SECTION

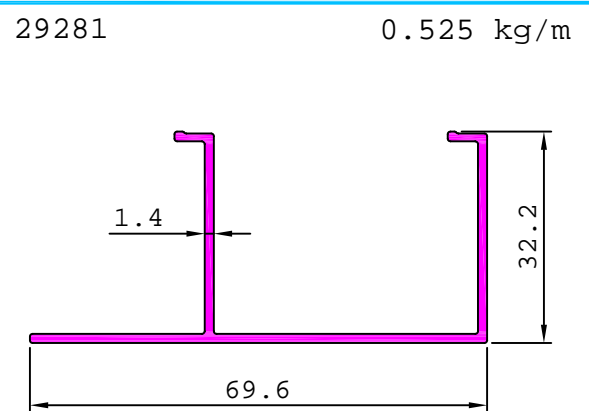
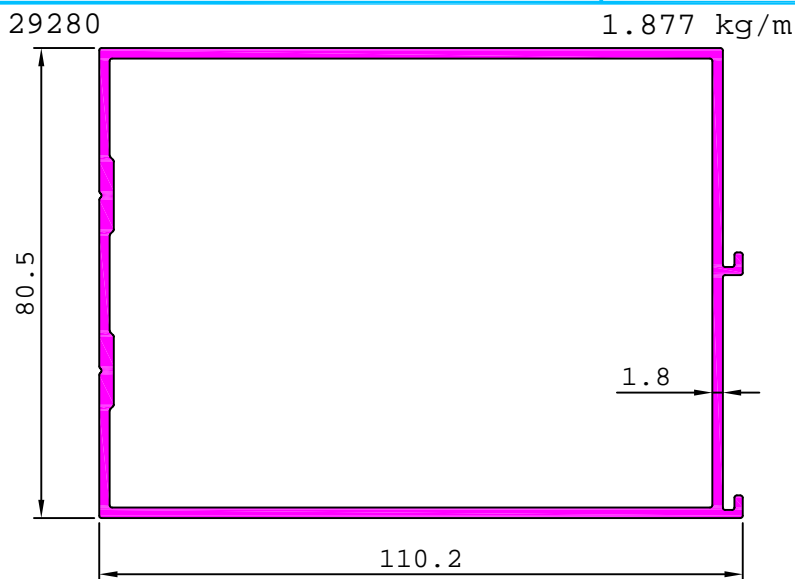
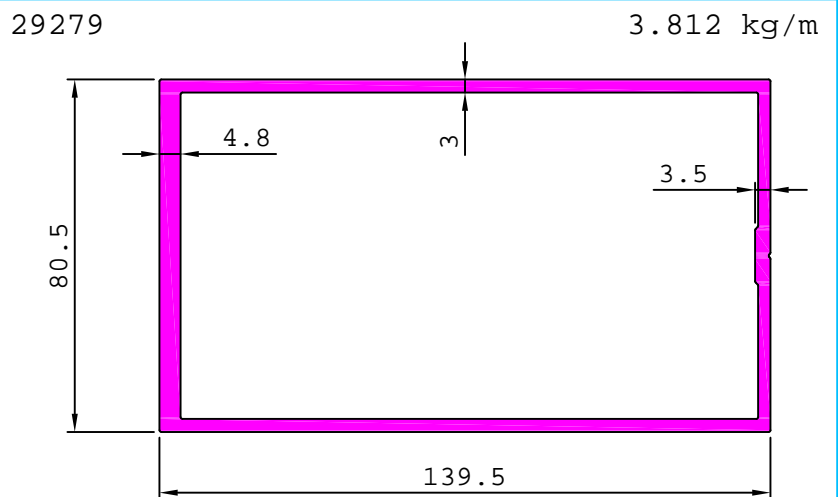
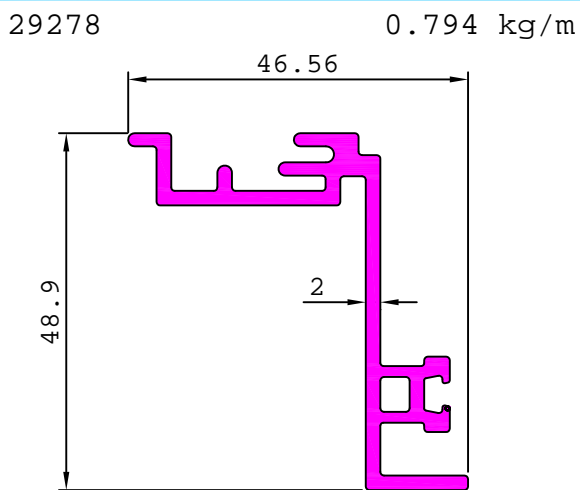
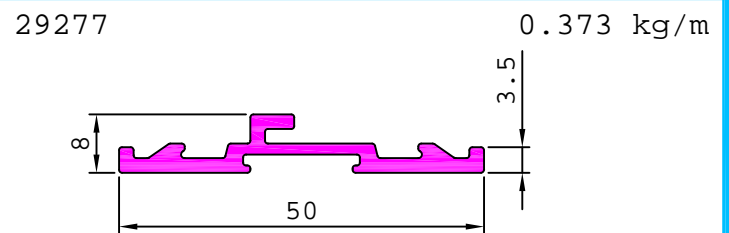
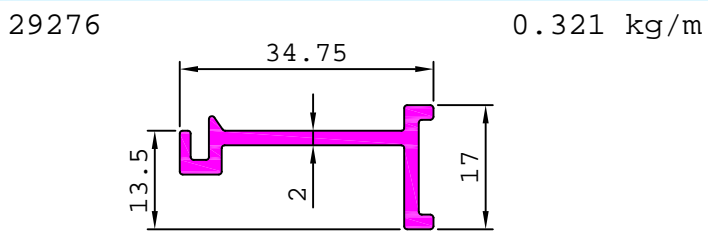
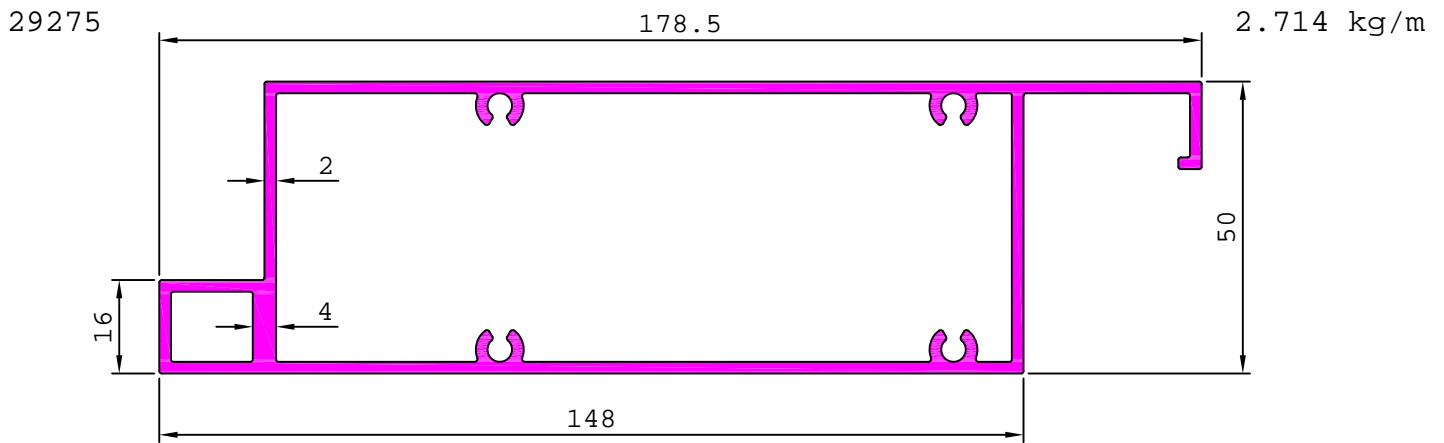

ARCHITECTURAL

CURTAIN WALL SECTION

29282

0.648 kg/m

29283

0.769 kg/m

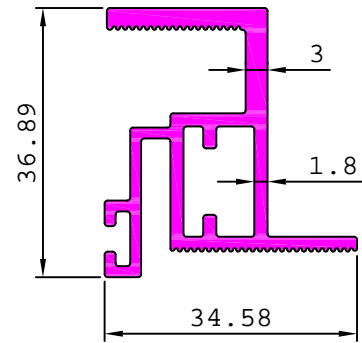
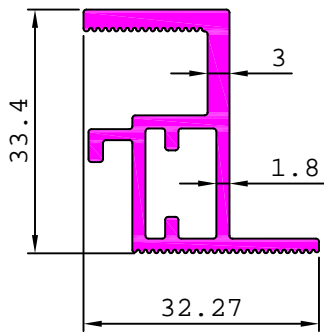

29296

2.737 kg/m

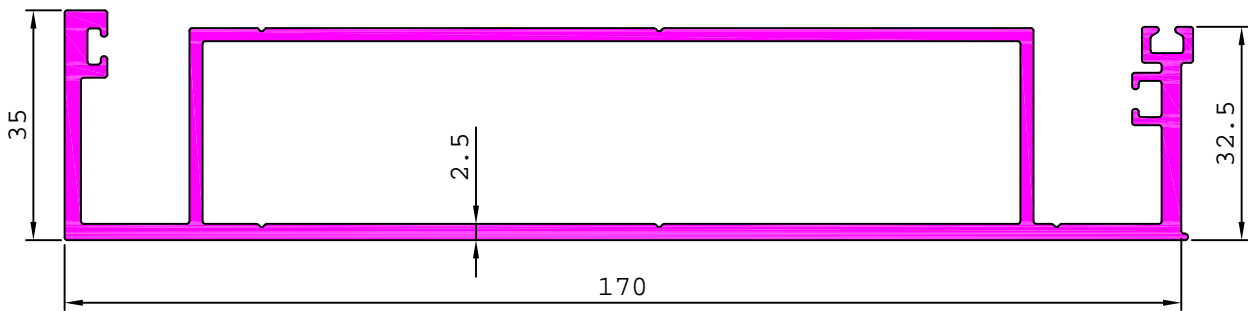

29297

2.037 kg/m

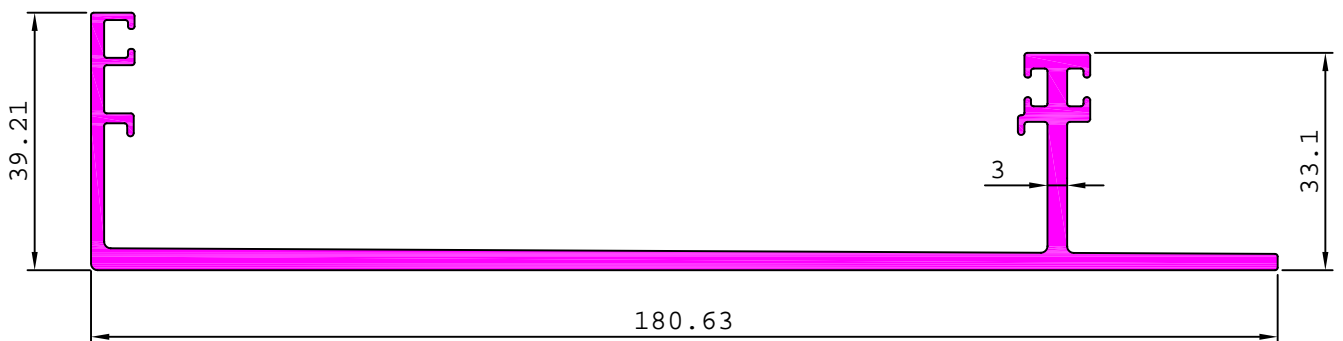

29298

3.865 kg/m

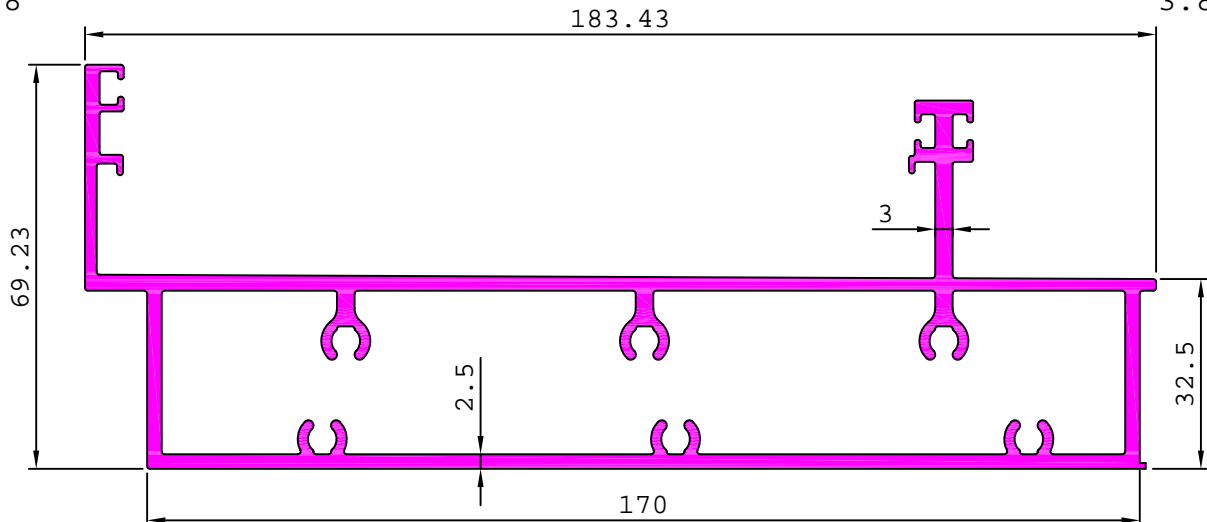

ARCHITECTURAL

CURTAIN WALL SECTION

29299

3.198 kg/m

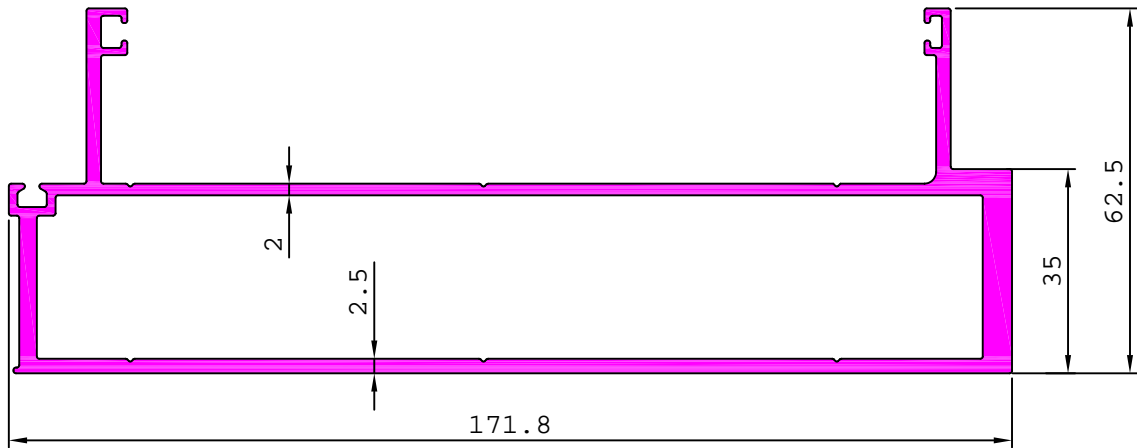

29301

2.007 kg/m

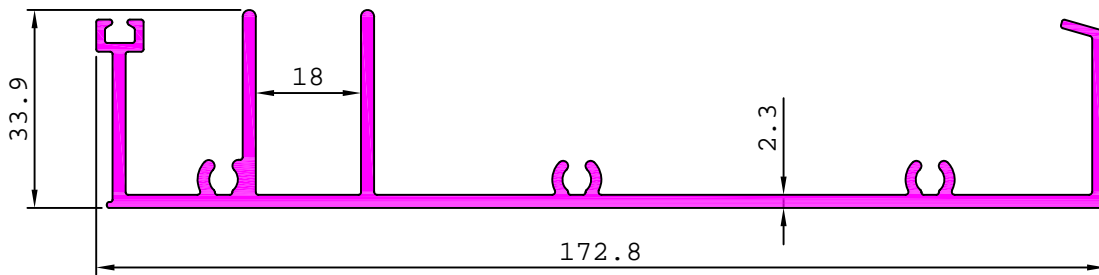

29302

1.832 kg/m

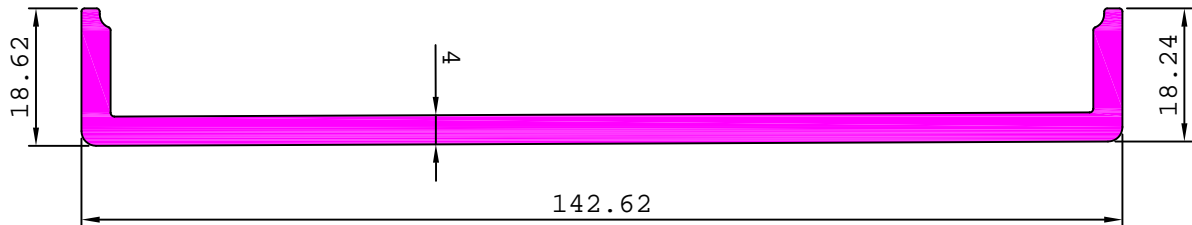

29371

7.136 kg/m

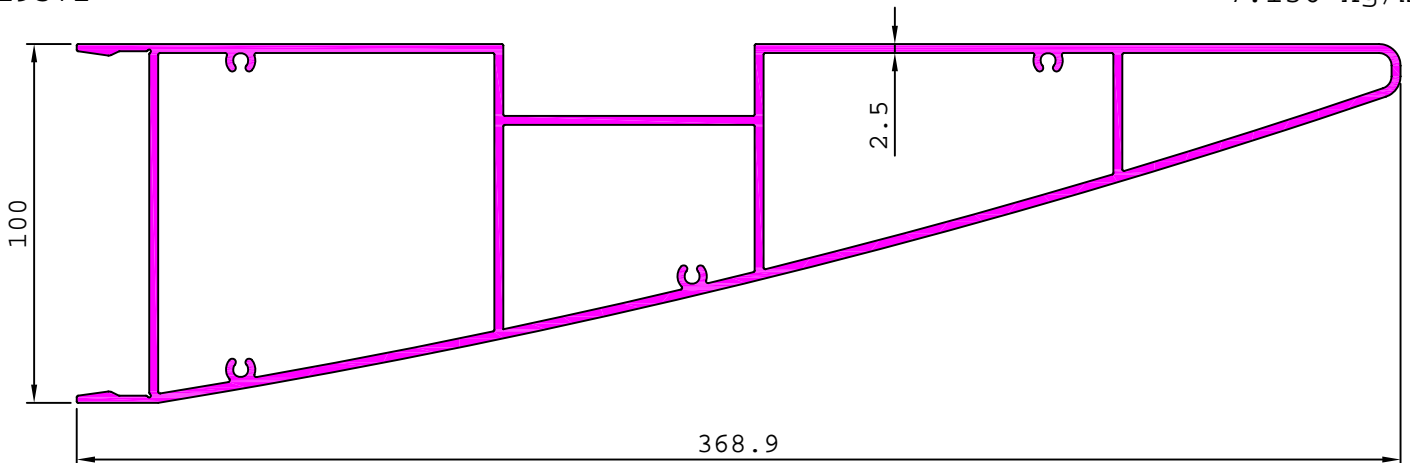

ARCHITECTURAL

CURTAIN WALL SECTION

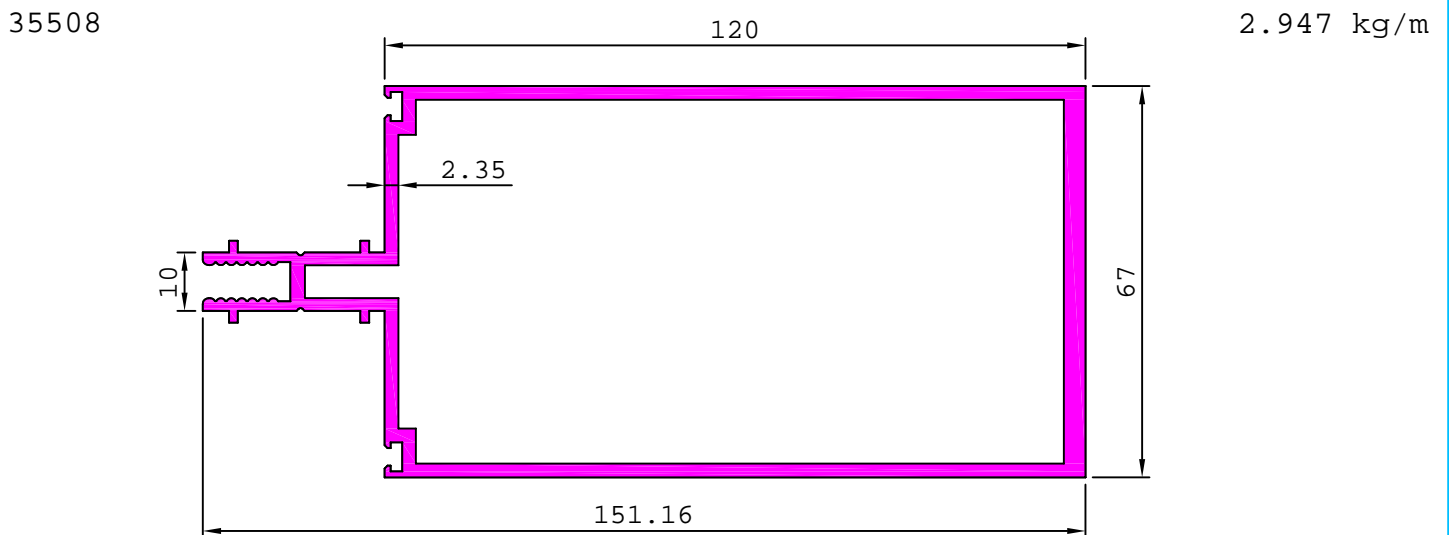
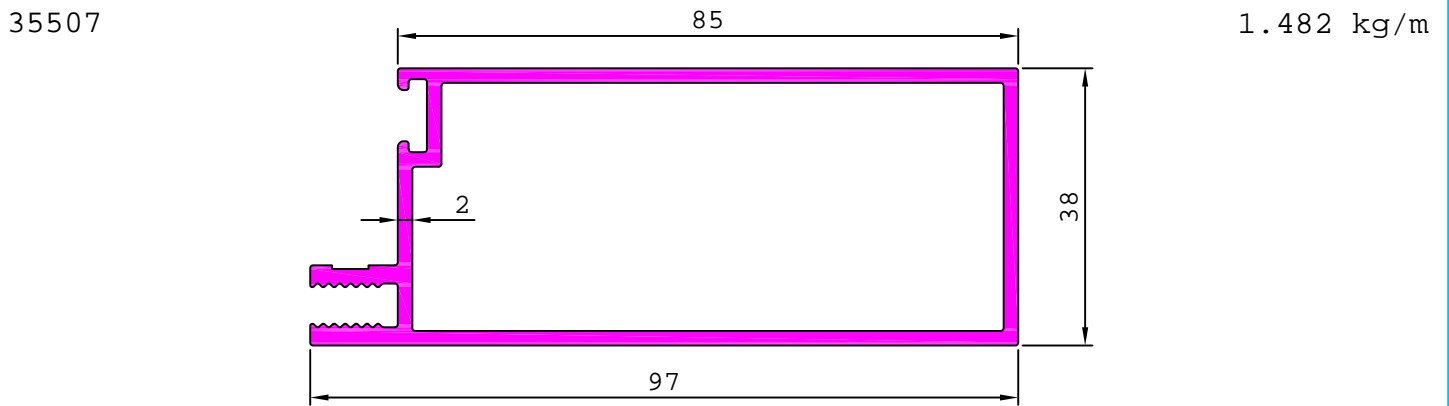
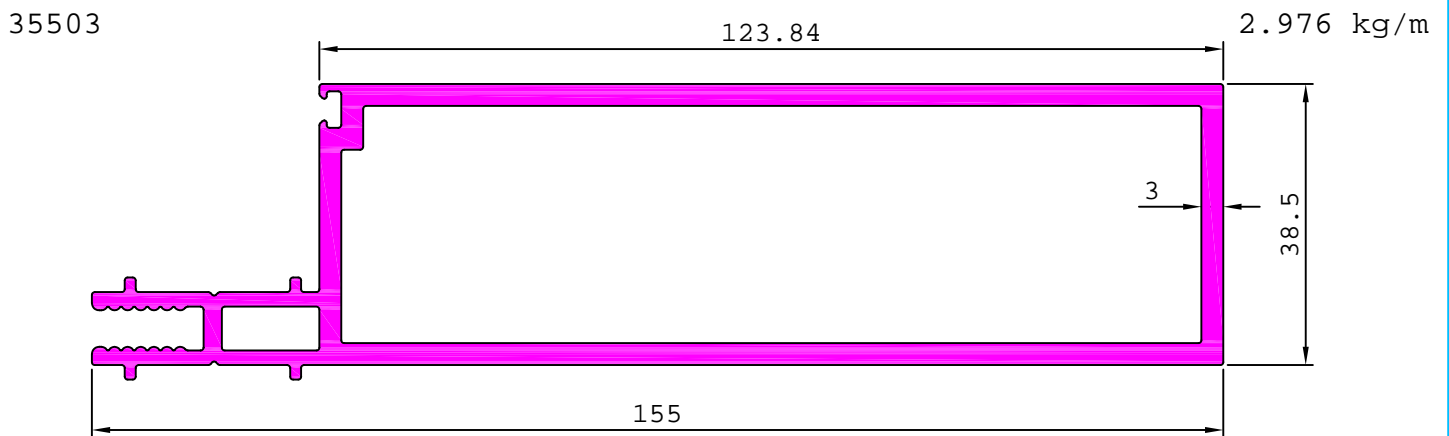
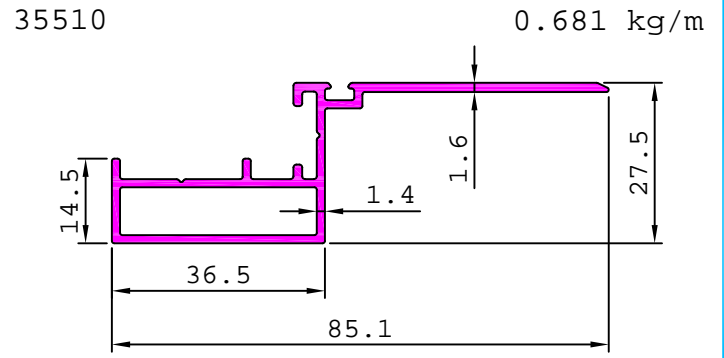
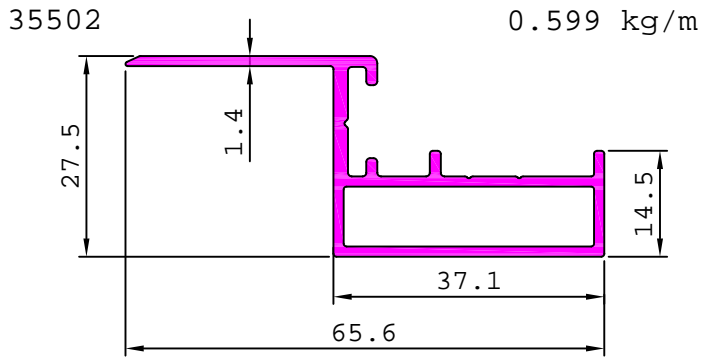

ARCHITECTURAL

CURTAIN WALL SECTION

35511

2.145 kg/m

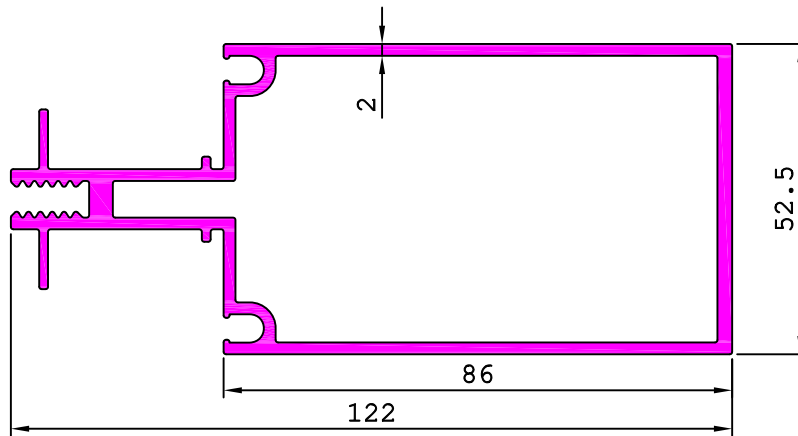

35513

2.004 kg/m

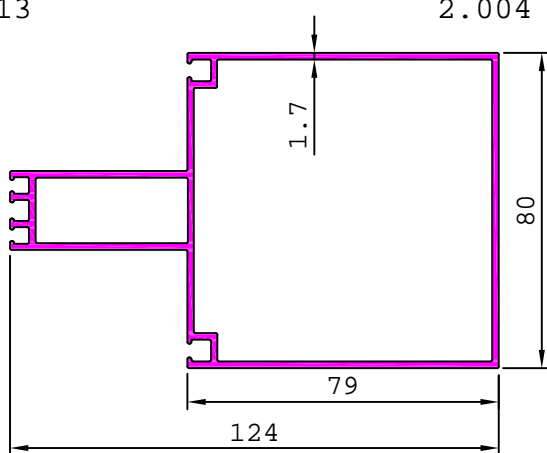

35514

3.070 kg/m

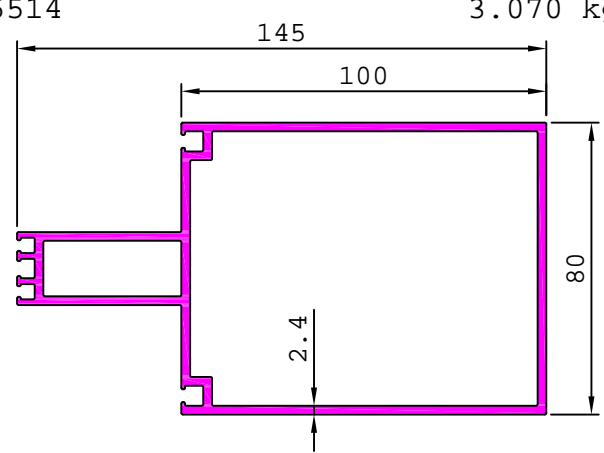

35517

0.872 kg/m

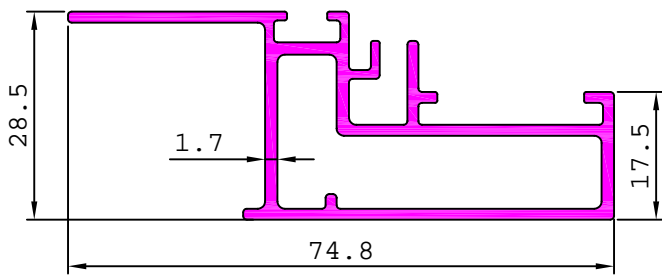

35518

1.111 kg/m

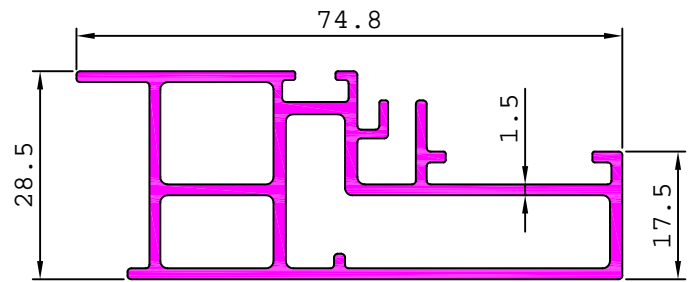

35516

1.946 kg/m

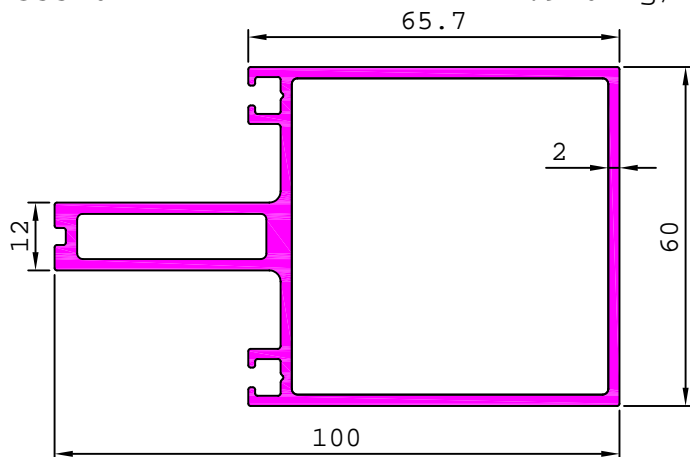

35515

2.962 kg/m

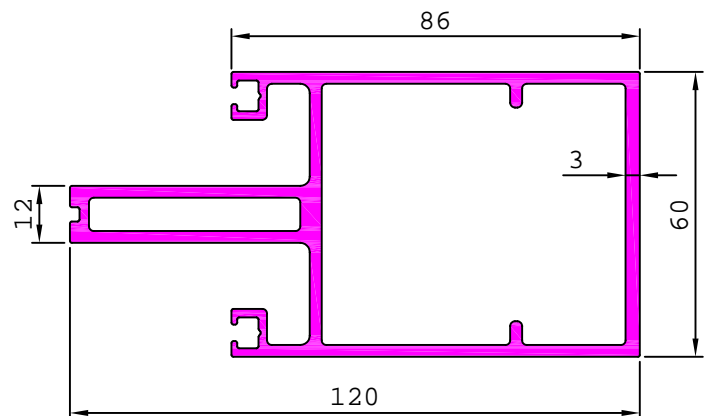

ARCHITECTURAL

CURTAIN WALL SECTION

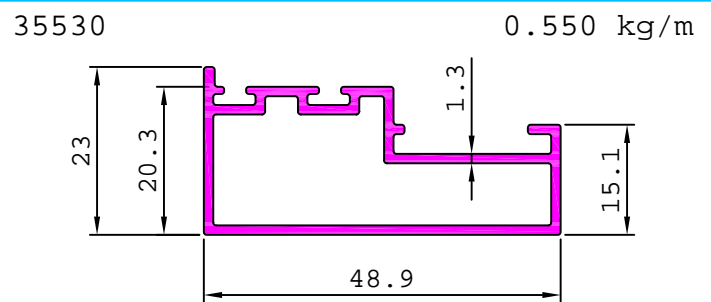
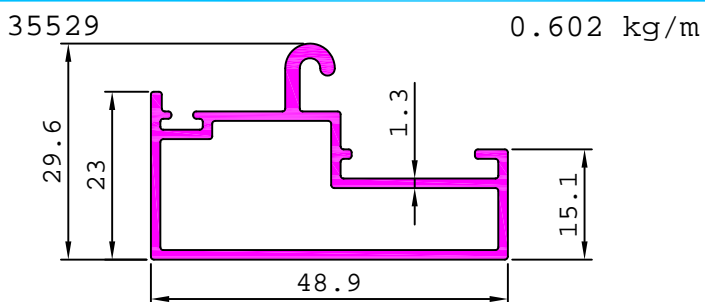
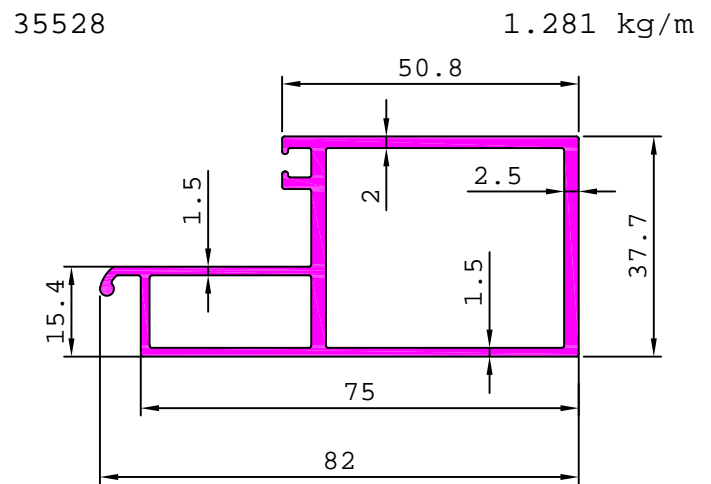
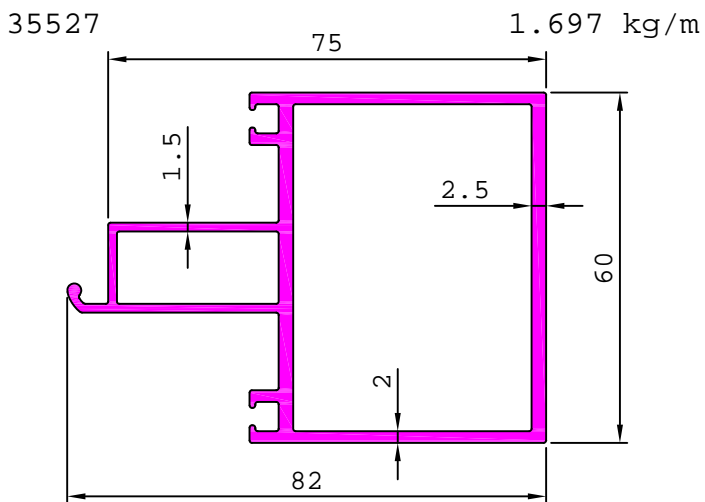
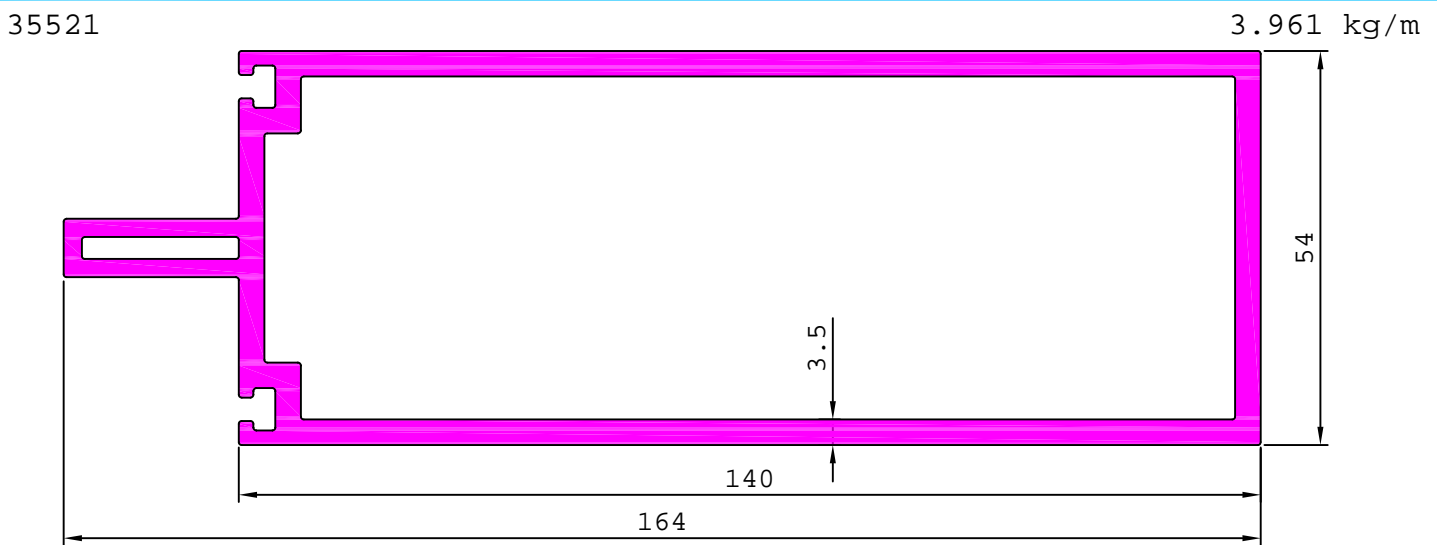
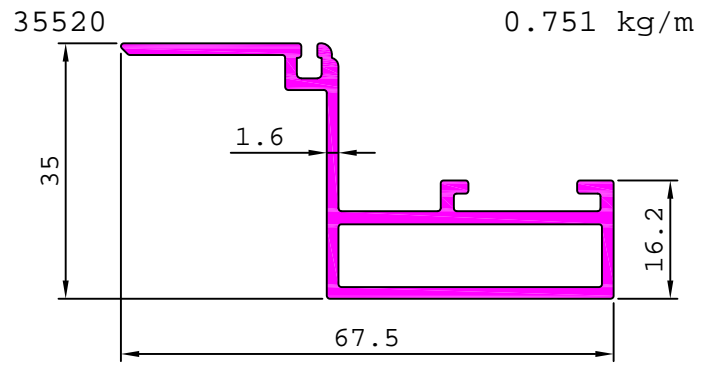
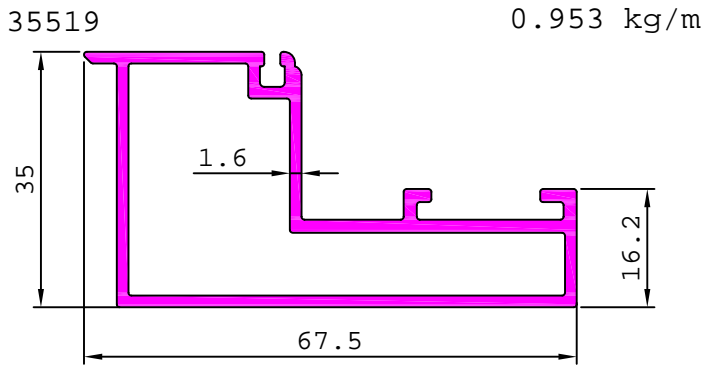

ARCHITECTURAL

CURTAIN WALL SECTION

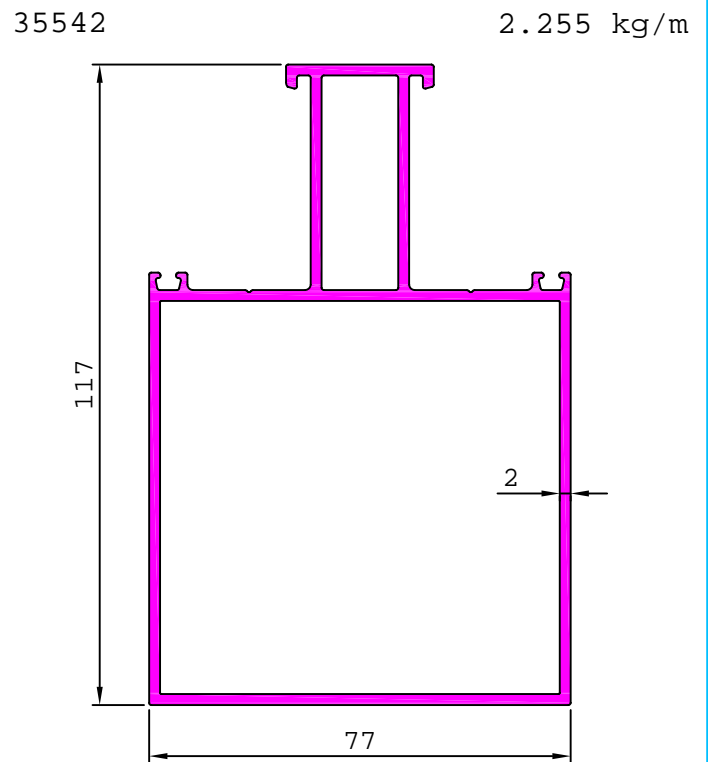
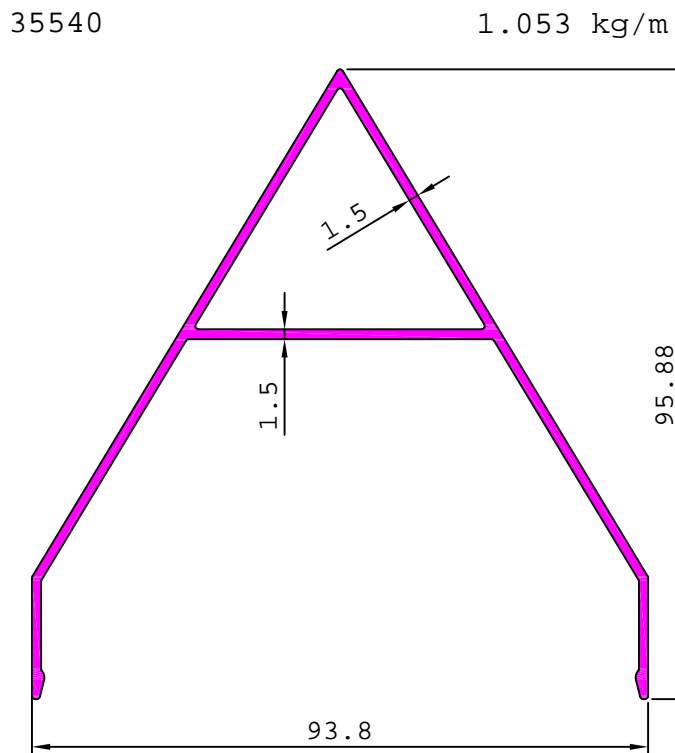
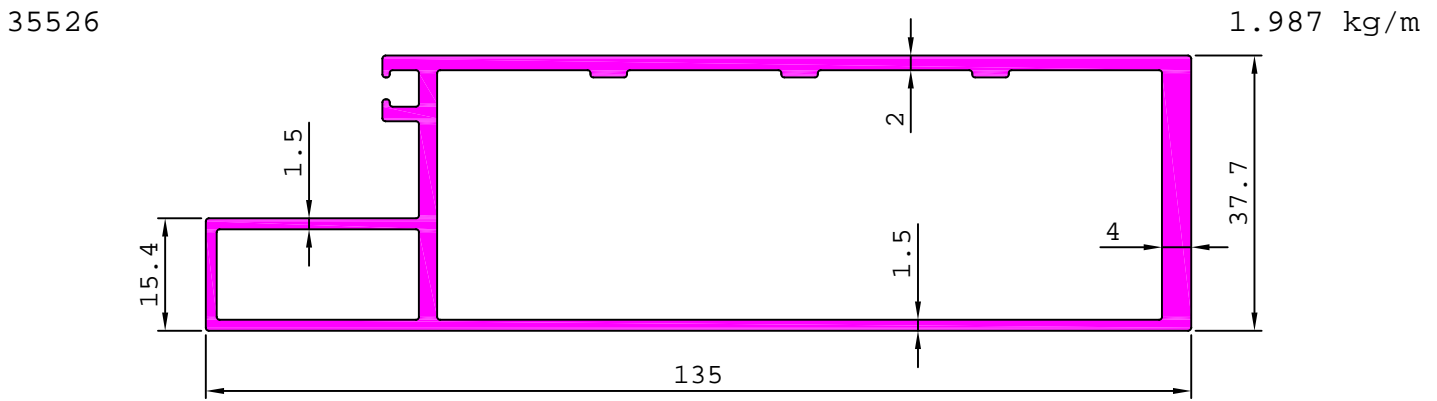
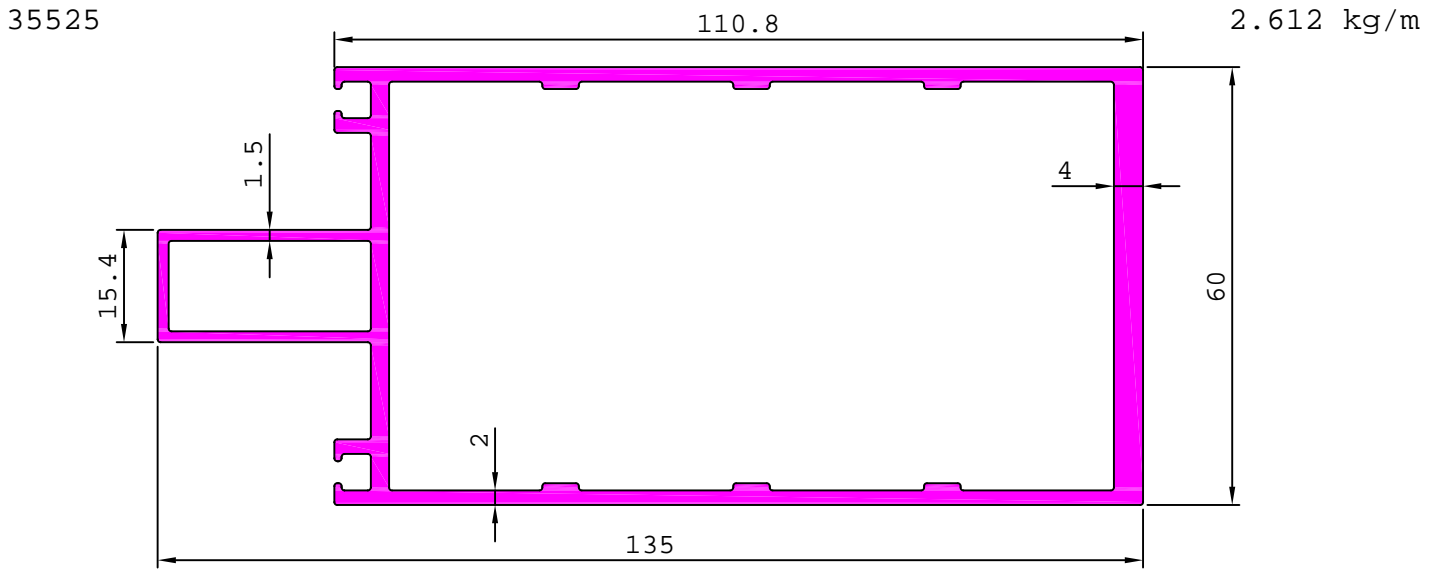

ARCHITECTURAL

CURTAIN WALL SECTION

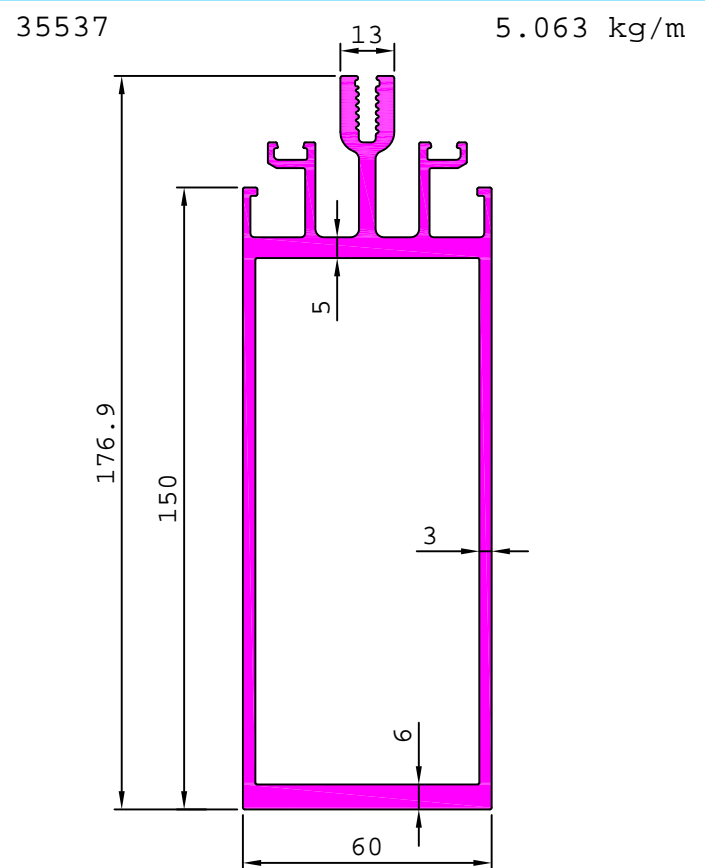
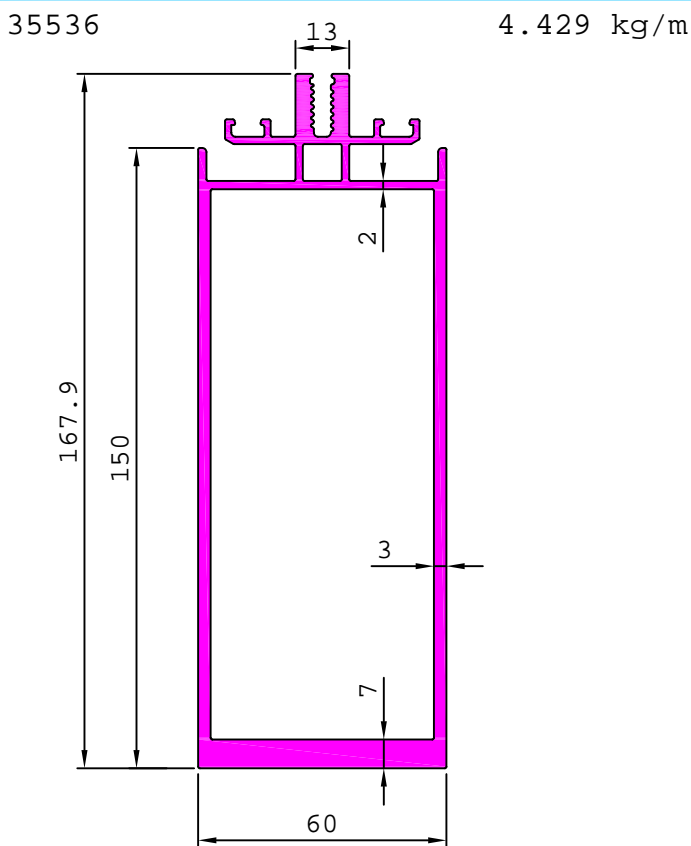
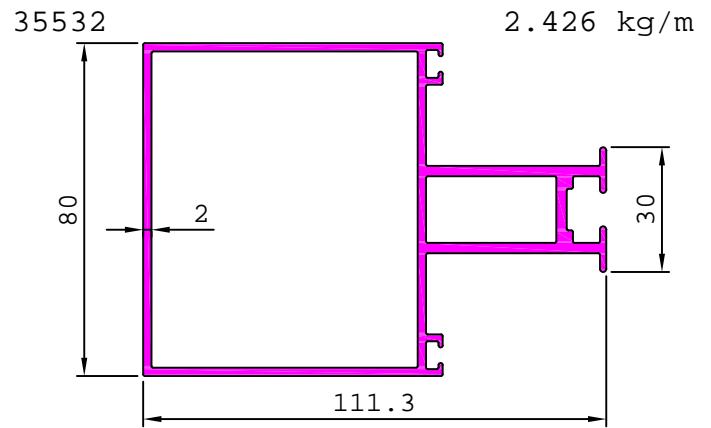
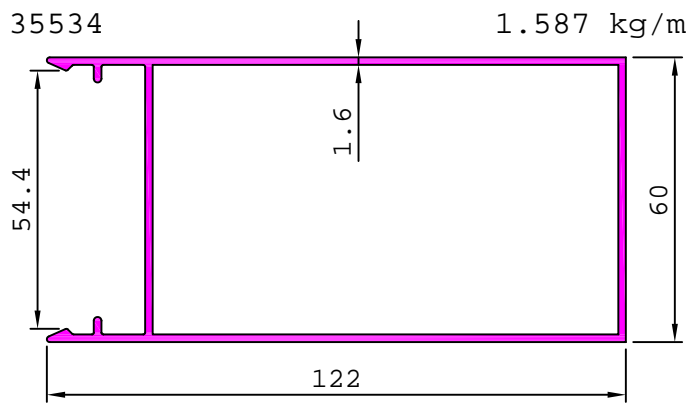
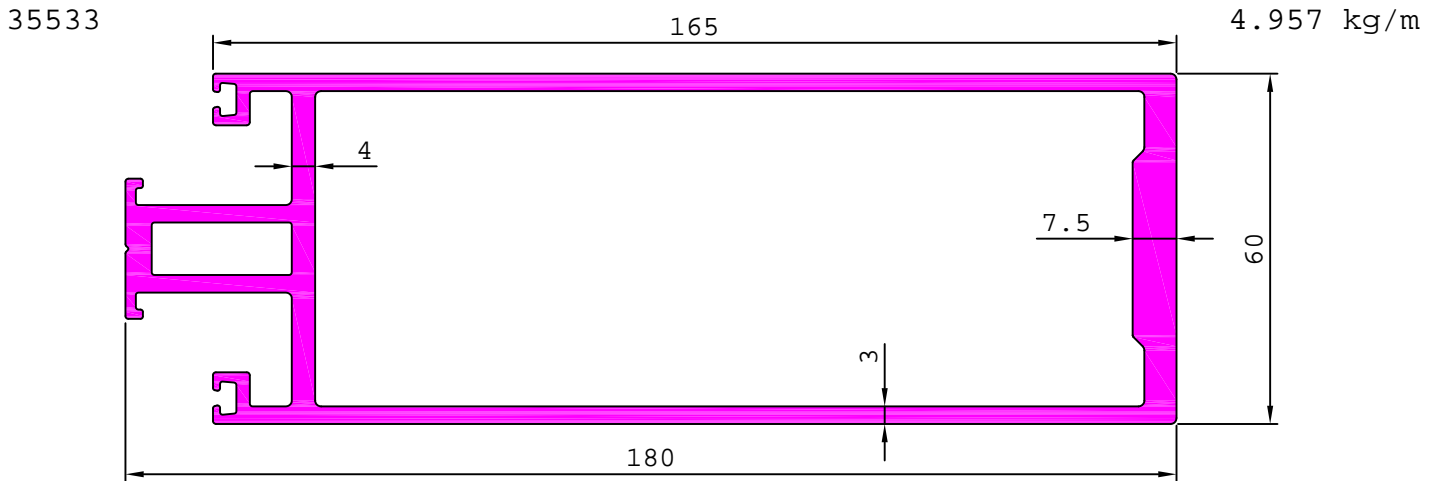

ARCHITECTURAL

CURTAIN WALL SECTION

35539 0.953 kg/m

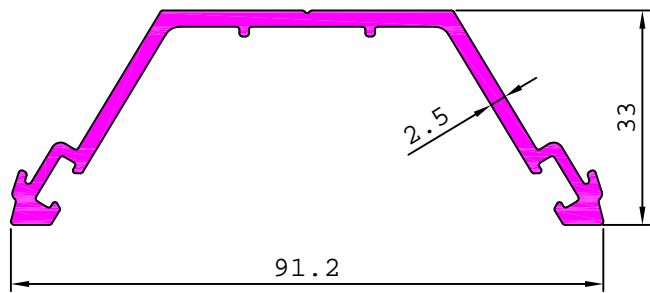

35546 1.301 kg/m

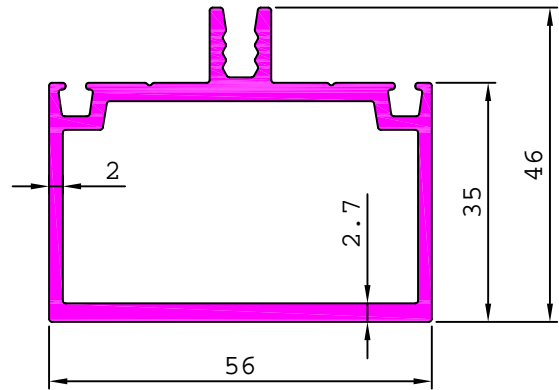

35541 3.619 kg/m

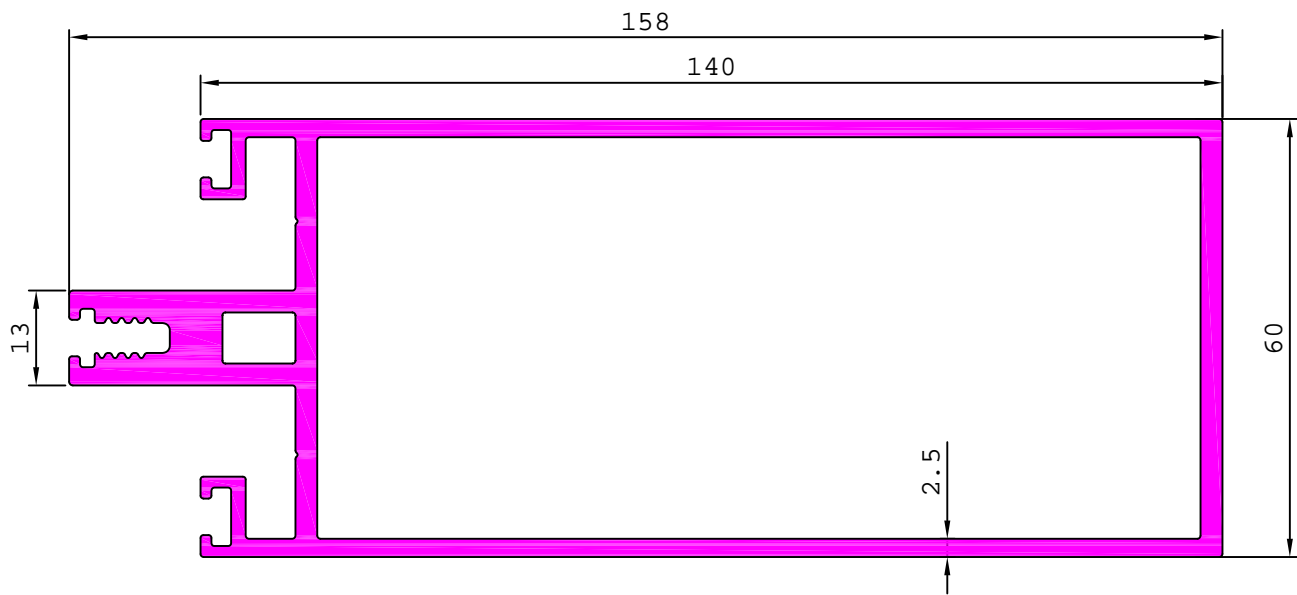

35543 4.230 kg/m

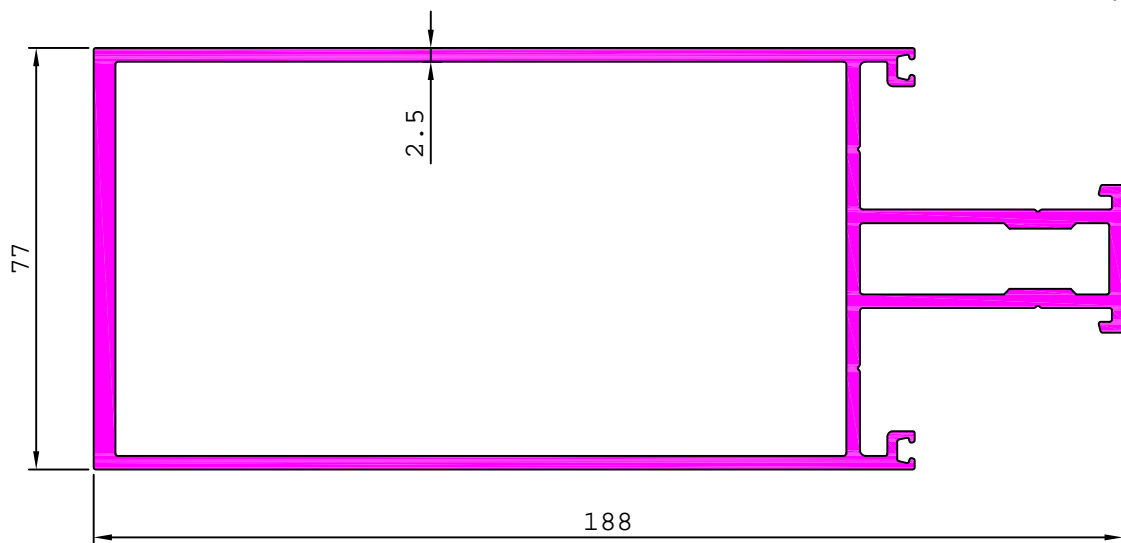

ARCHITECTURAL

CURTAIN WALL SECTION

35545

2.608 kg/m

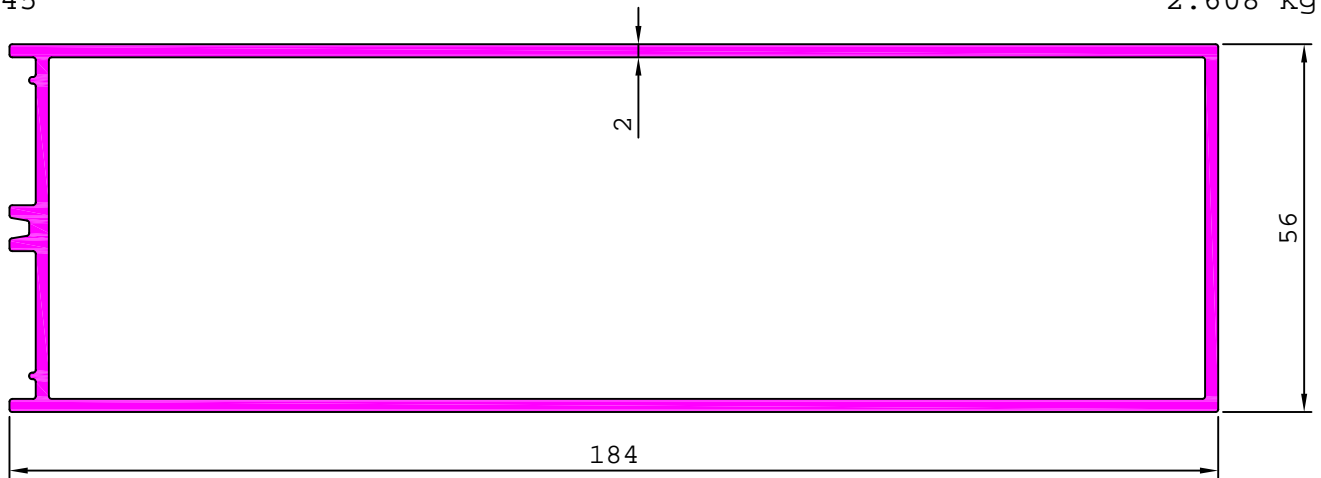

35547

0.459 kg/m

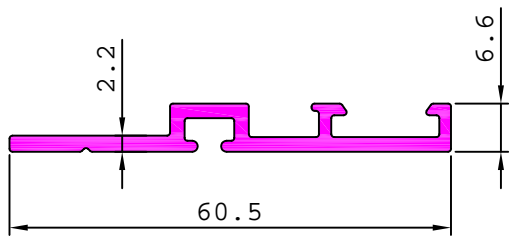

35552

3.044 kg/m

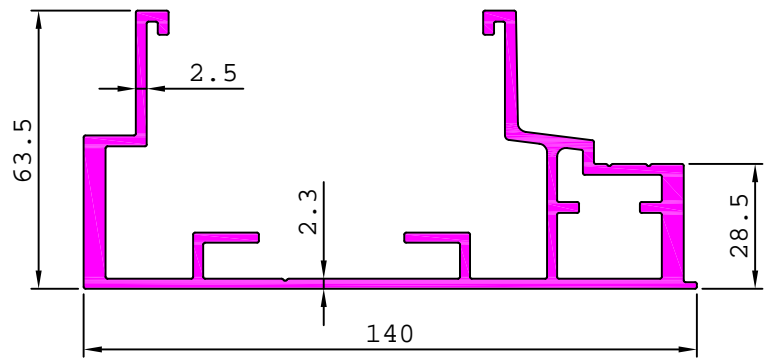

35550

4.598 kg/m

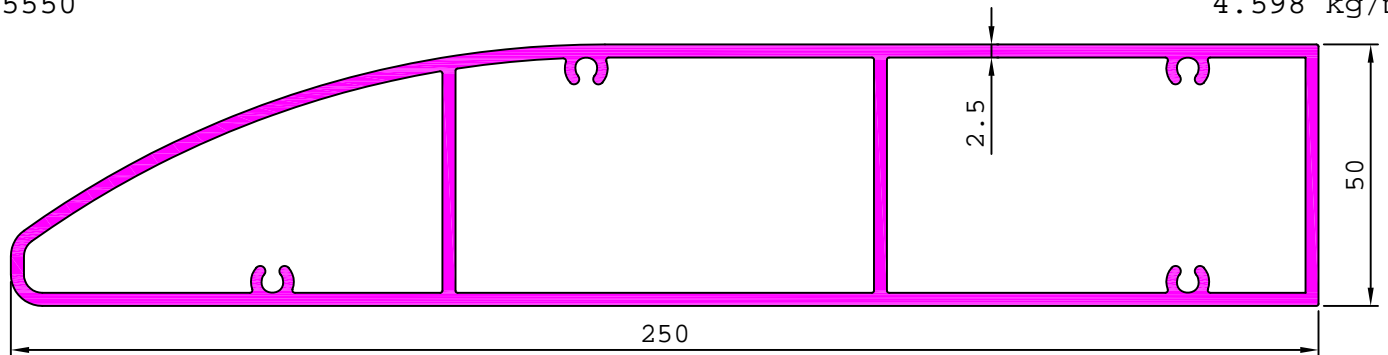

35554

3.238 kg/m

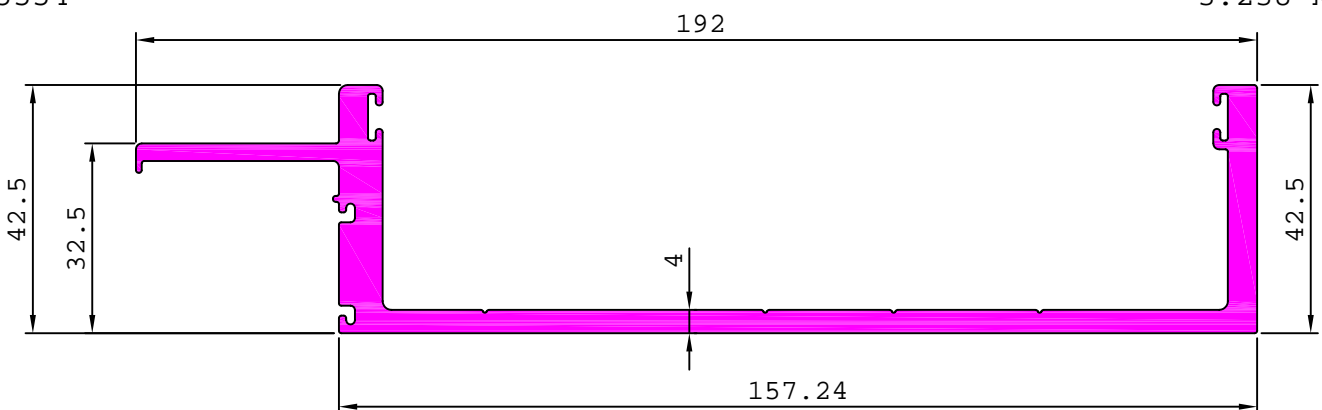

ARCHITECTURAL

CURTAIN WALL SECTION

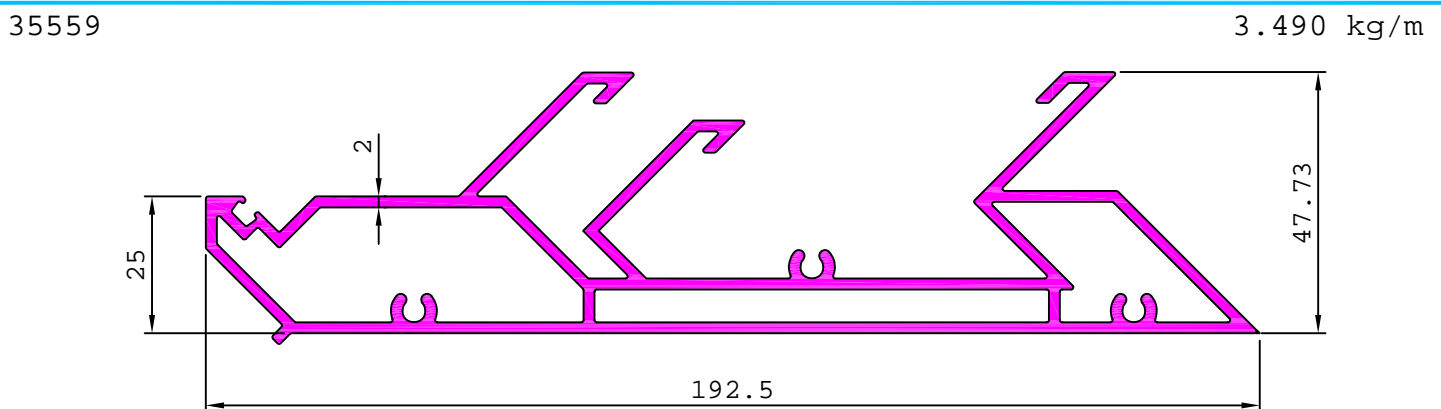
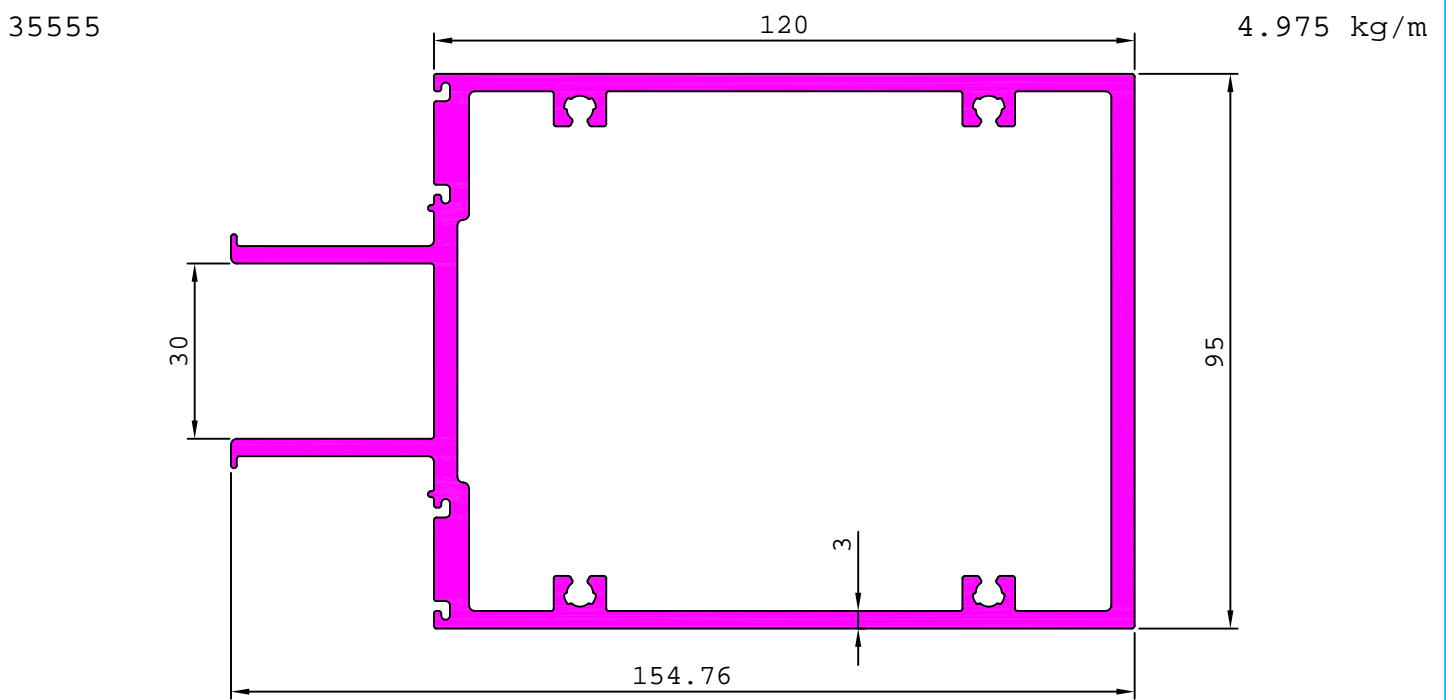
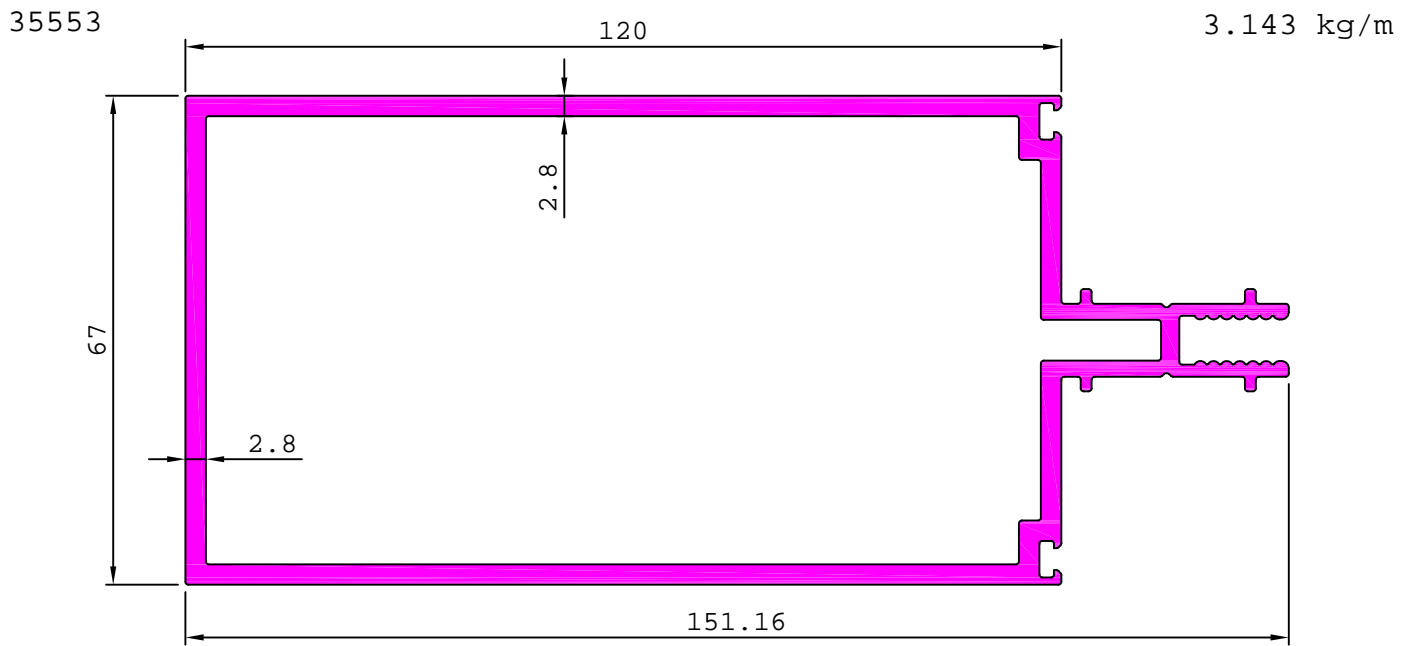

ARCHITECTURAL

CURTAIN WALL SECTION

35549 1.592 kg/m

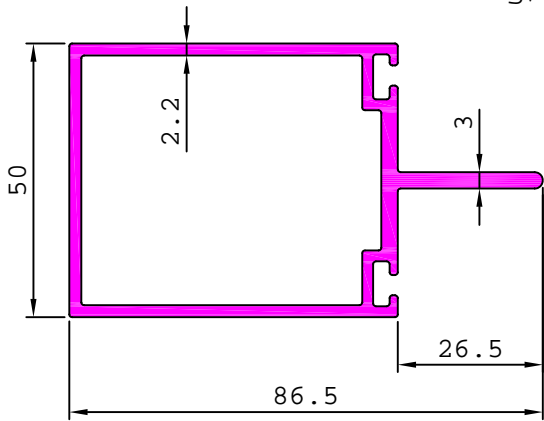

35562 2.703 kg/m

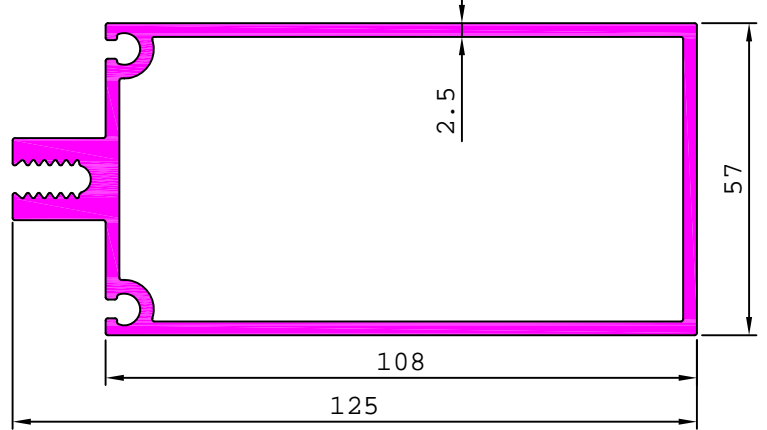

35563

4.135 kg/m

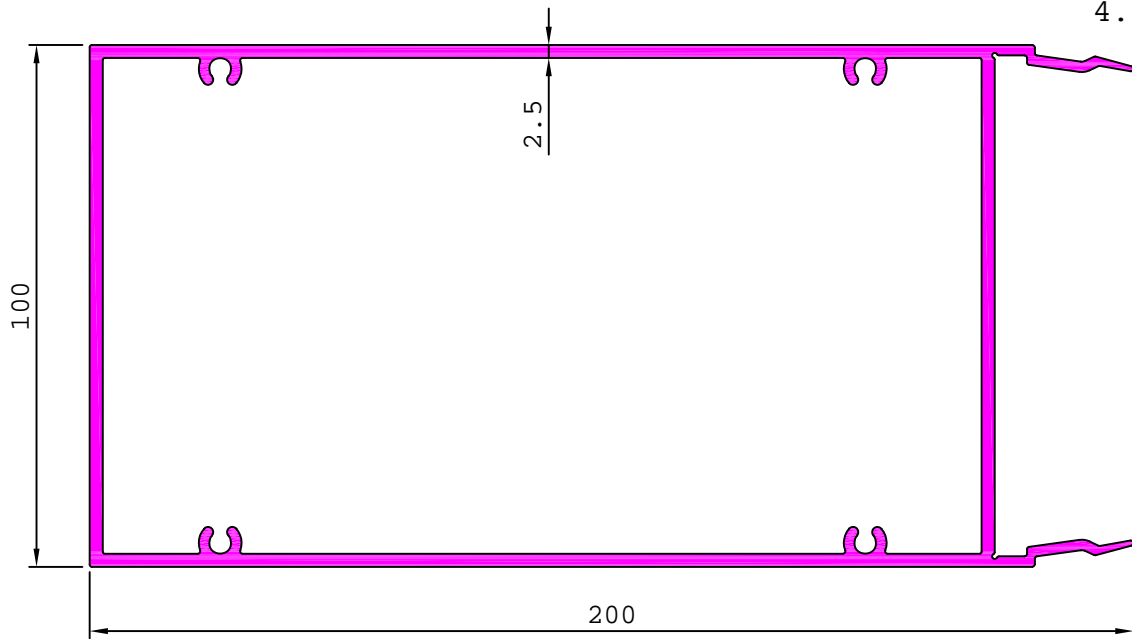

35569

4.080 kg/m

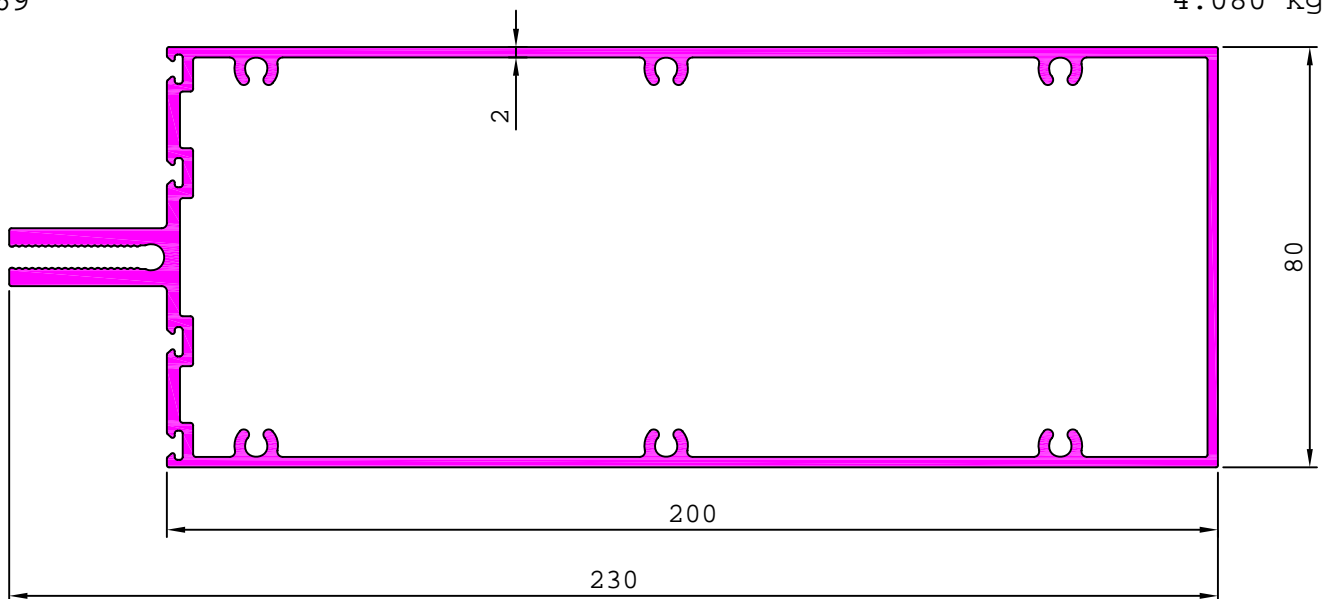

ARCHITECTURAL

CURTAIN WALL SECTION

35564

2.621 kg/m

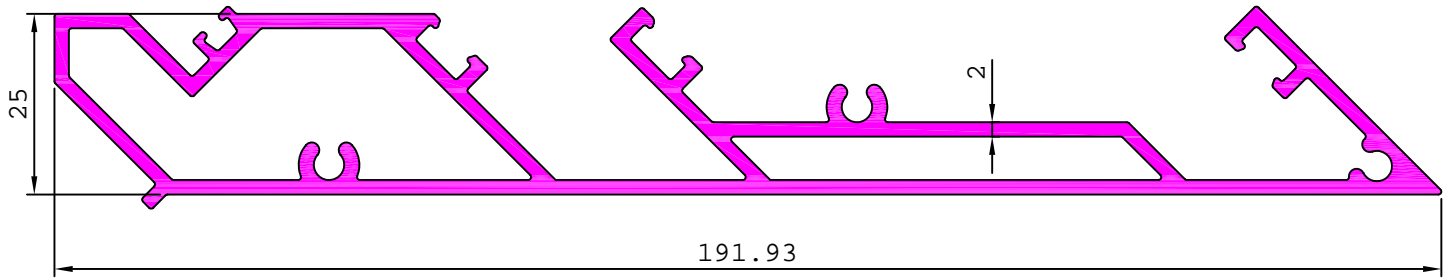

35567

0.531 kg/m

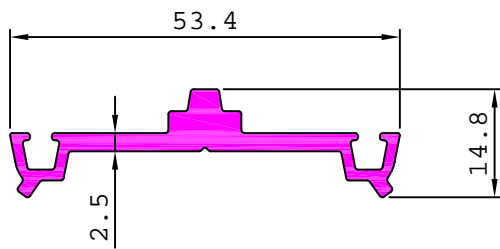

35568

0.392 kg/m

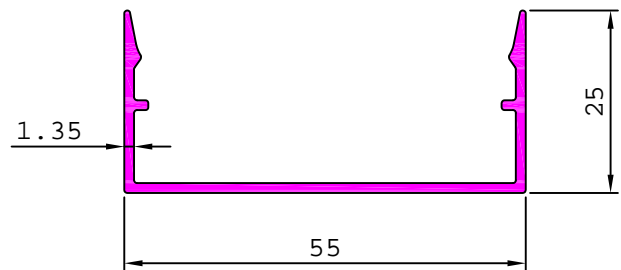

35566

0.755 kg/m

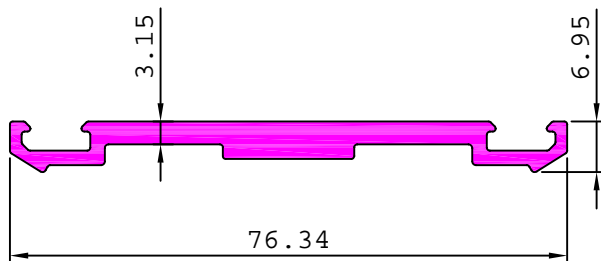

35583

3.061 kg/m

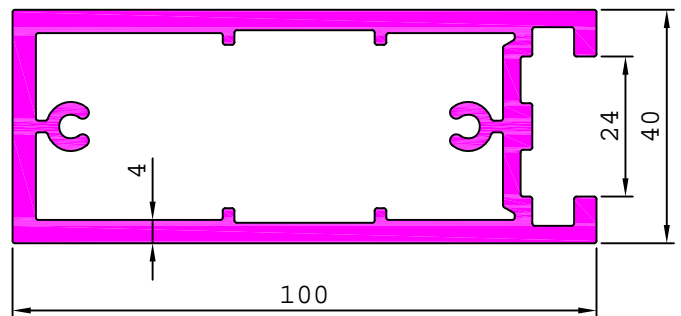

35571

2.402 kg/m

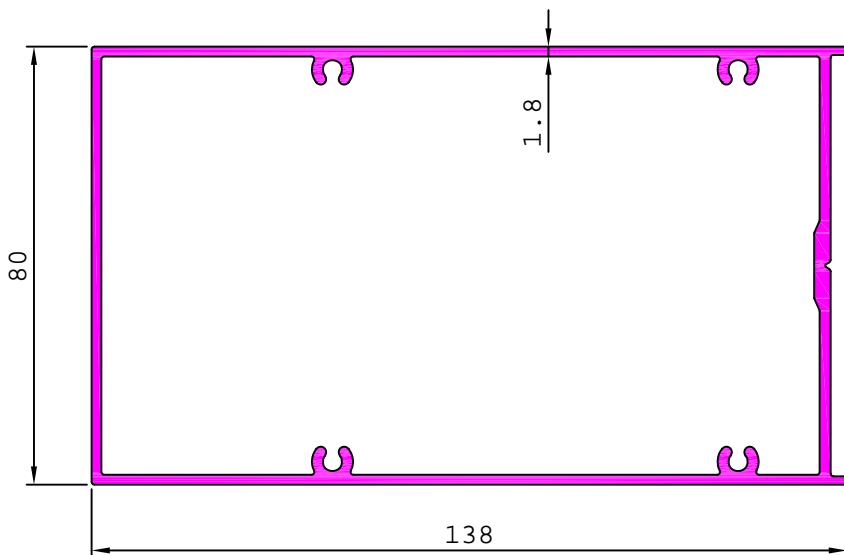

35572

1.707 kg/m

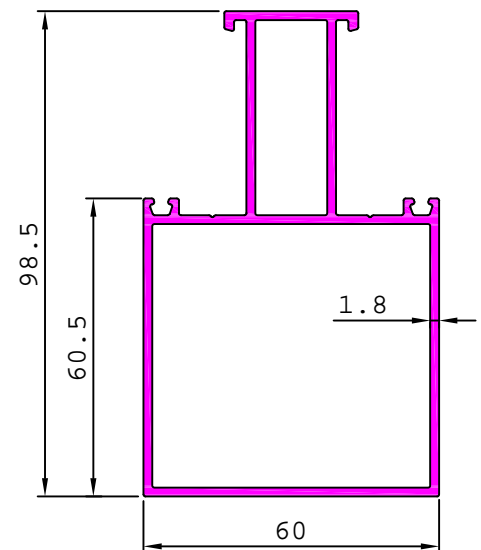

ARCHITECTURAL

CURTAIN WALL SECTION

35570

2.530 kg/m

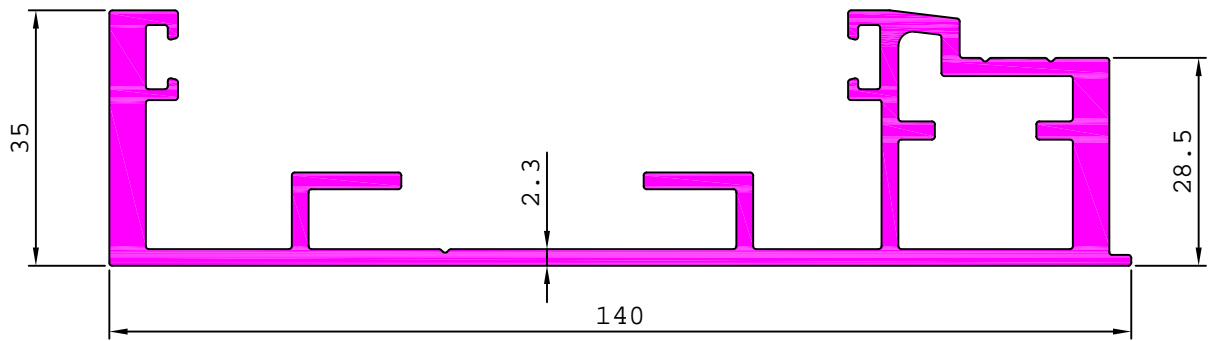

35573

3.072 kg/m

35574

3.884 kg/m

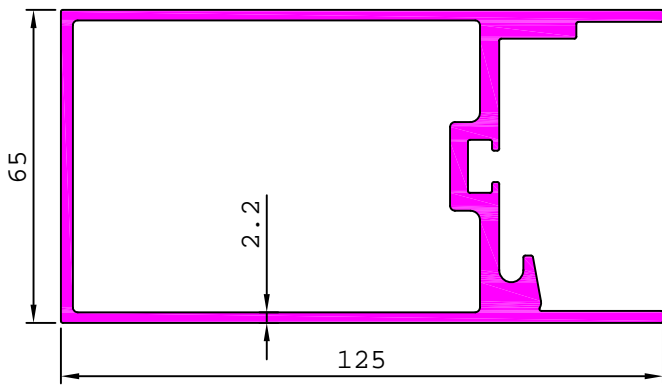

35575

3.236 kg/m

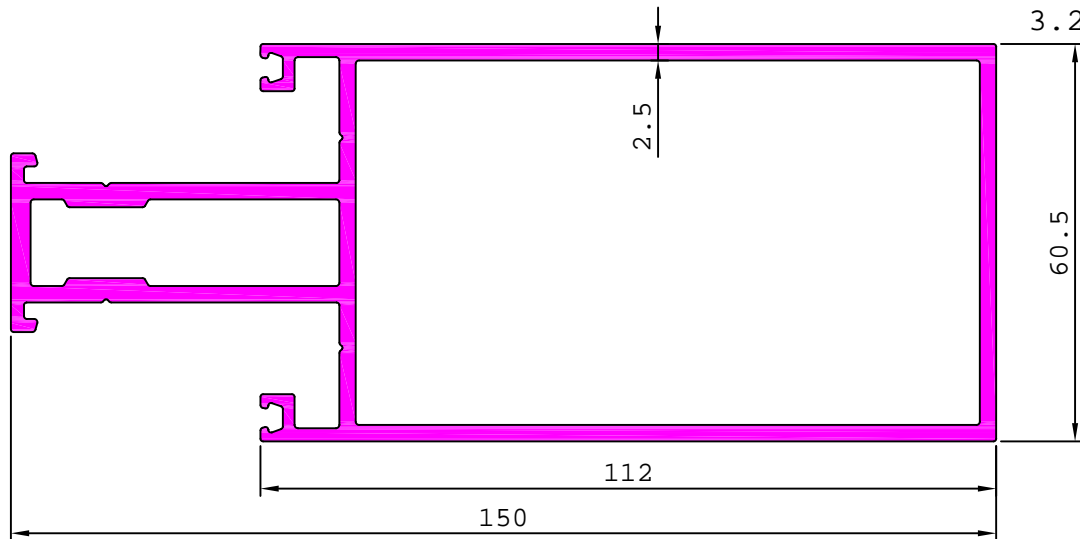

35580

0.545 kg/m

35576

0.589 kg/m

35582

0.471 kg/m

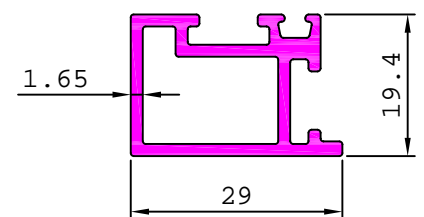
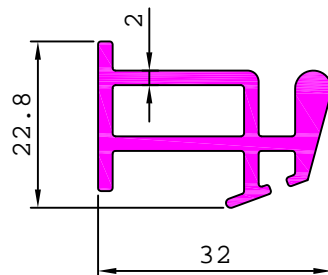
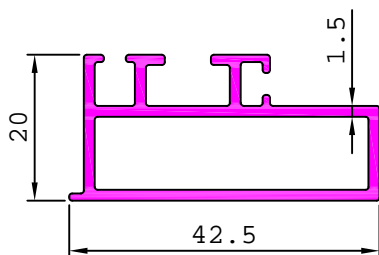

ARCHITECTURAL

CURTAIN WALL SECTION

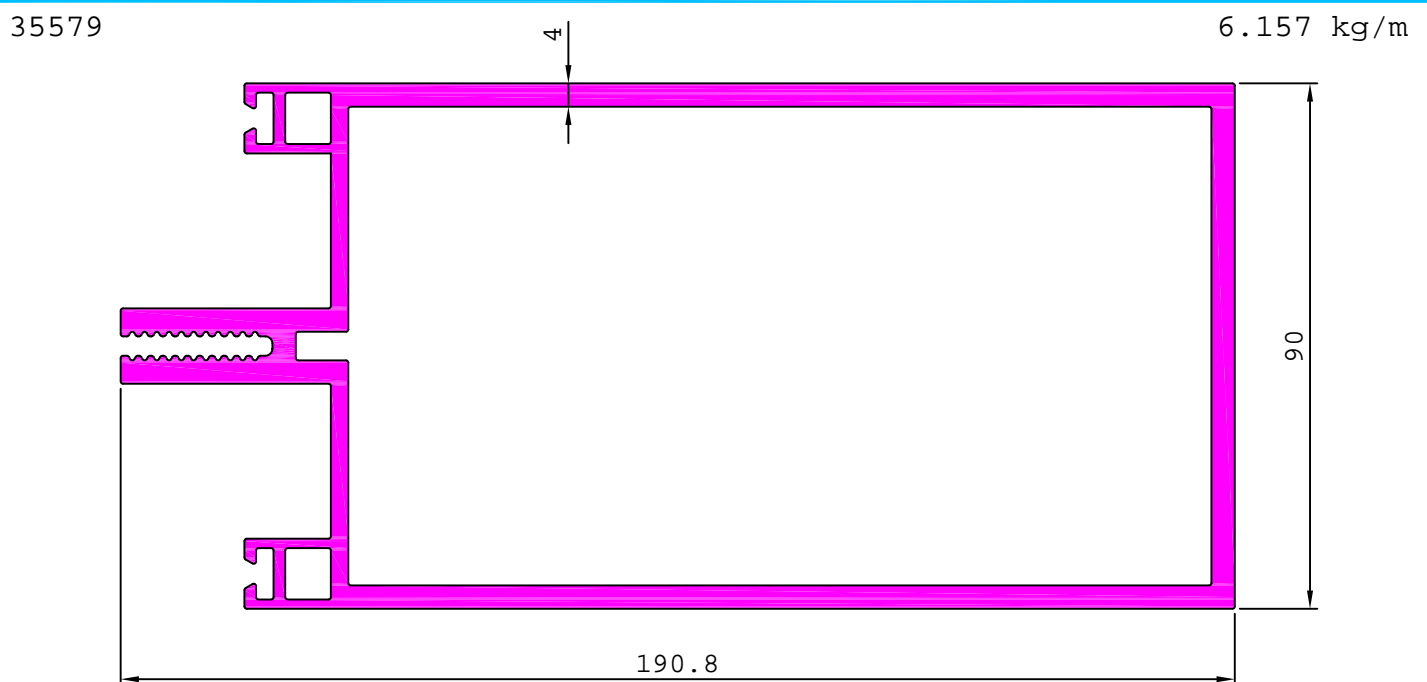
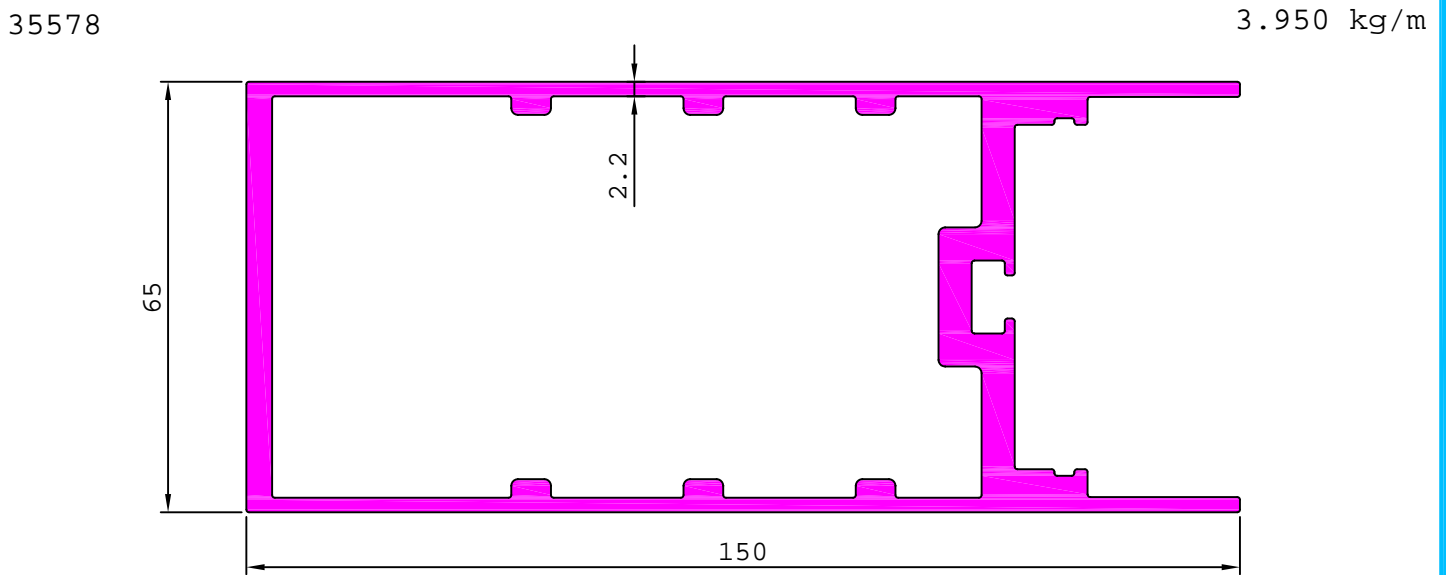
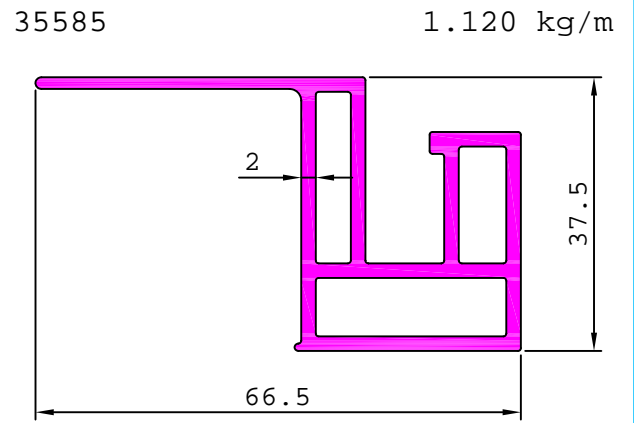
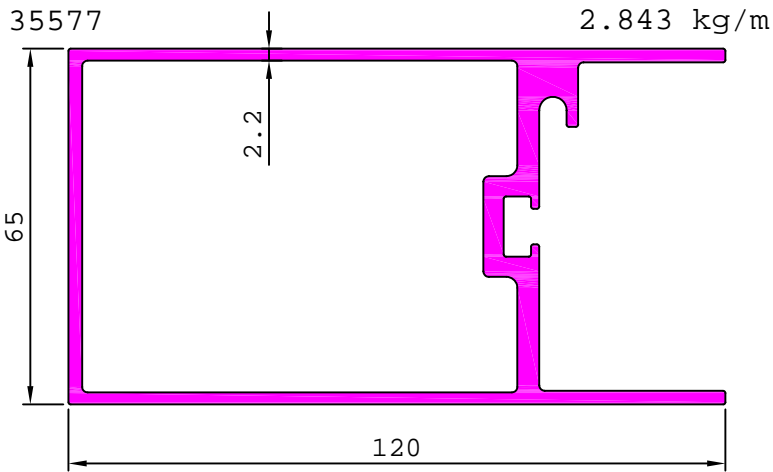

ARCHITECTURAL

CURTAIN WALL SECTION

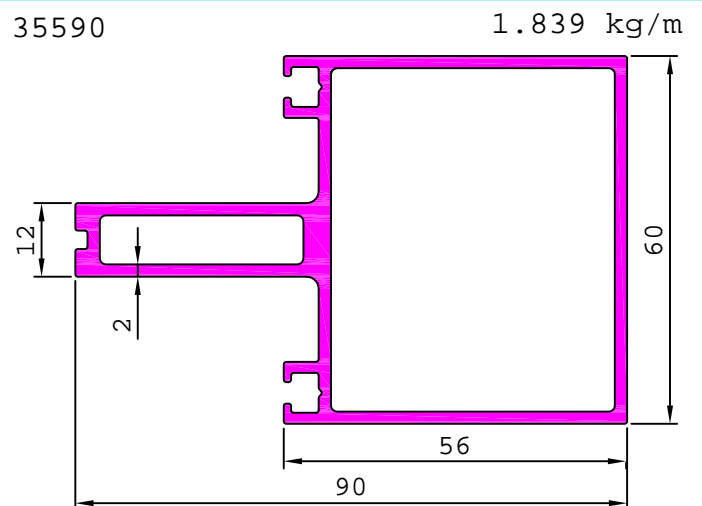
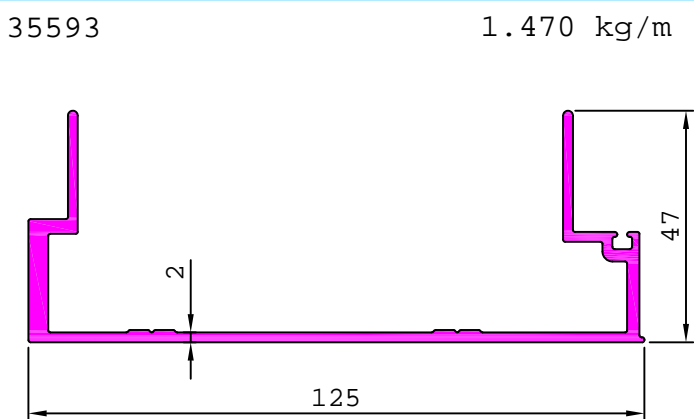
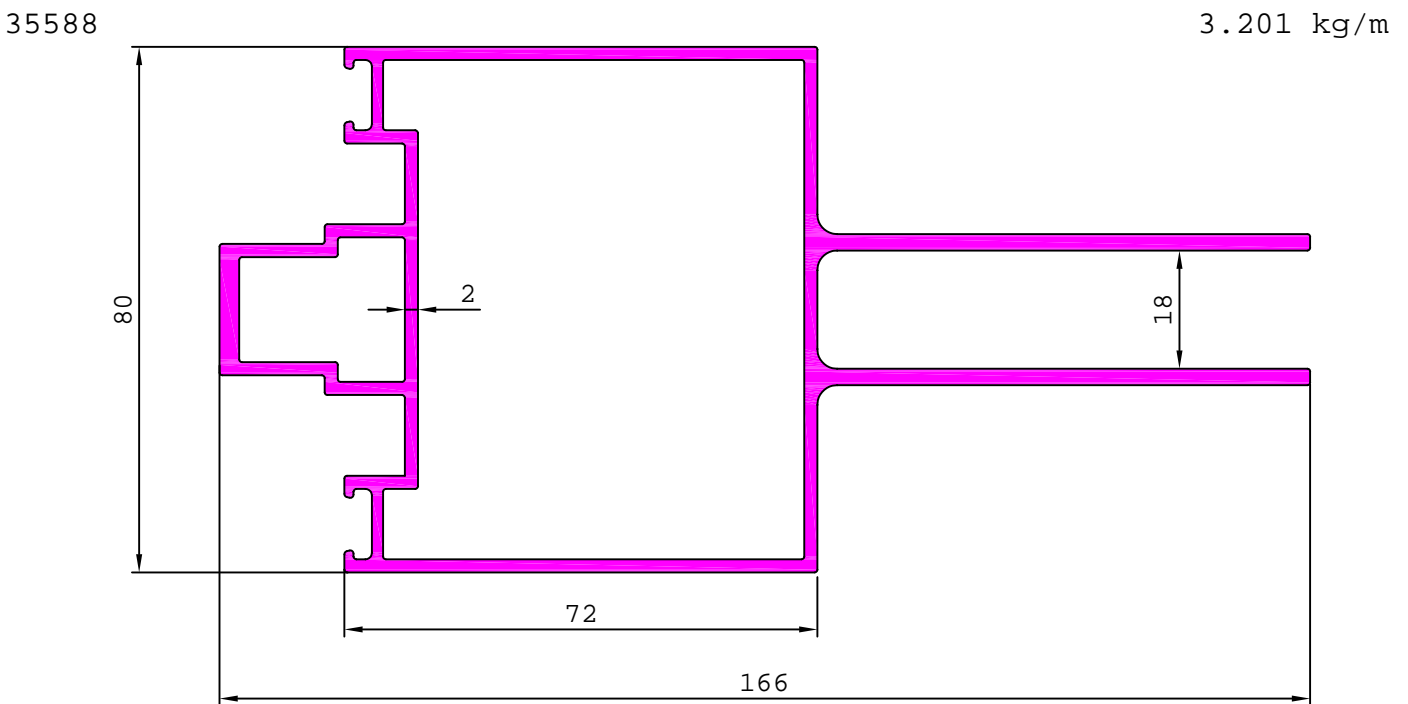
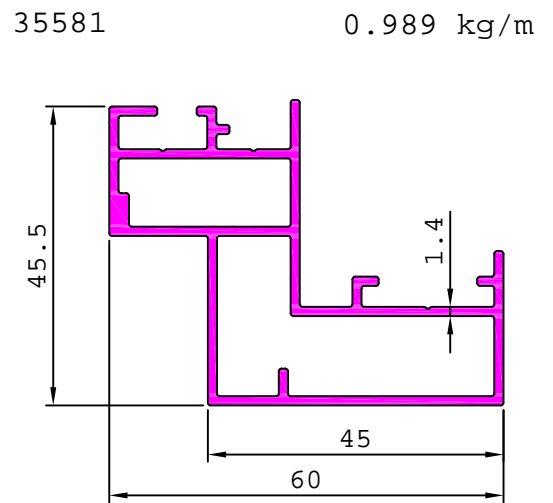
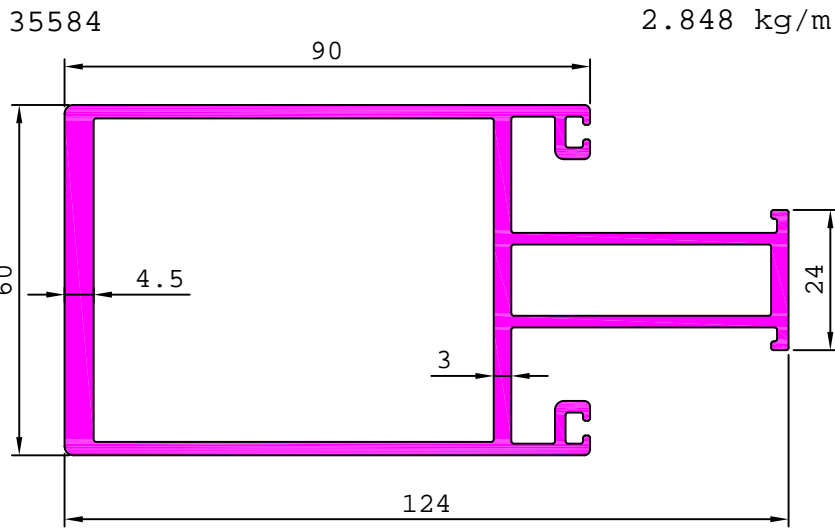

ARCHITECTURAL

CURTAIN WALL SECTION

35591

4.862 kg/m

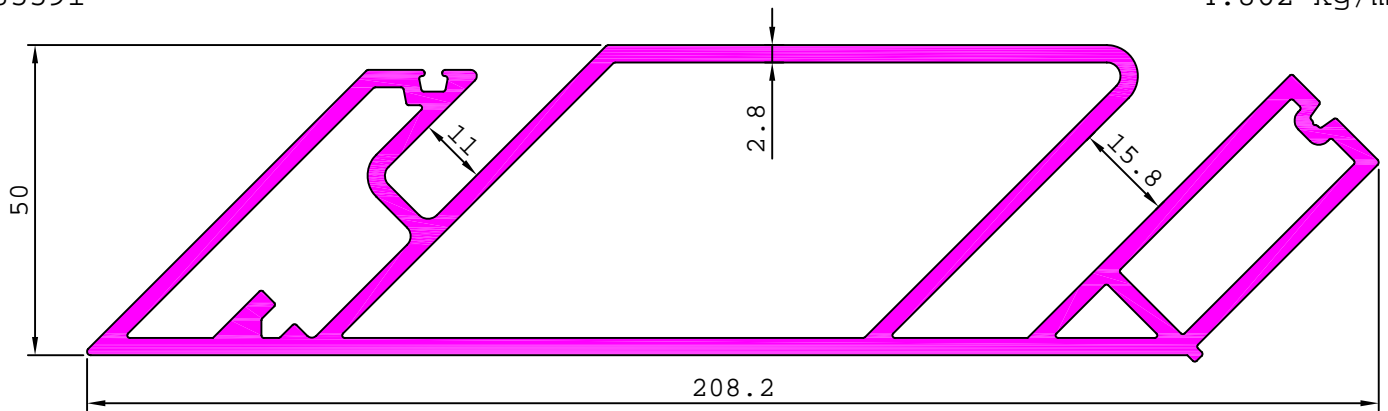

35592

4.153 kg/m

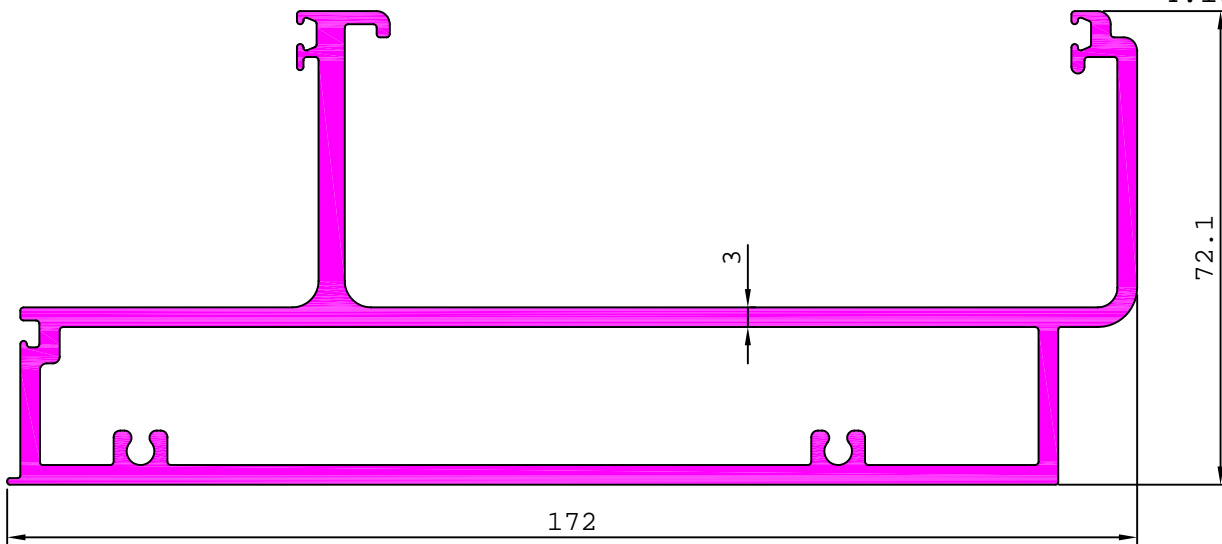

35594

3.837 kg/m

35595

4.095 kg/m

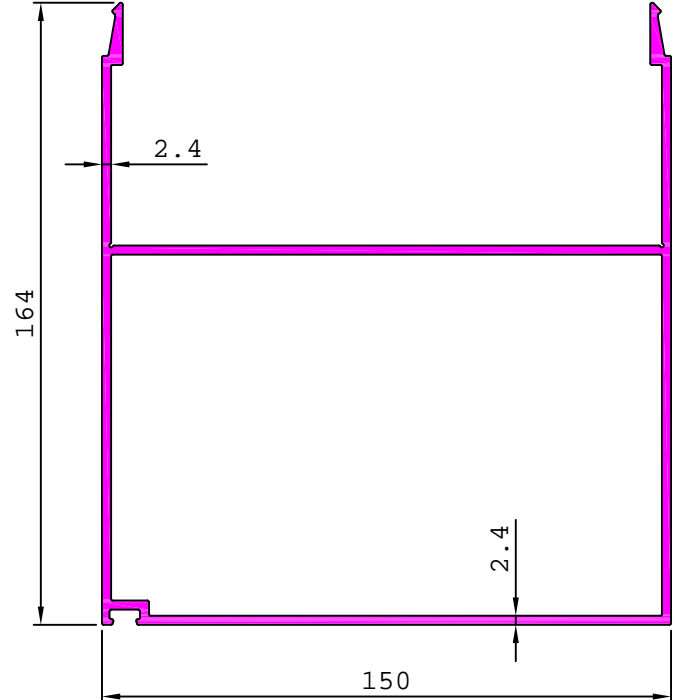
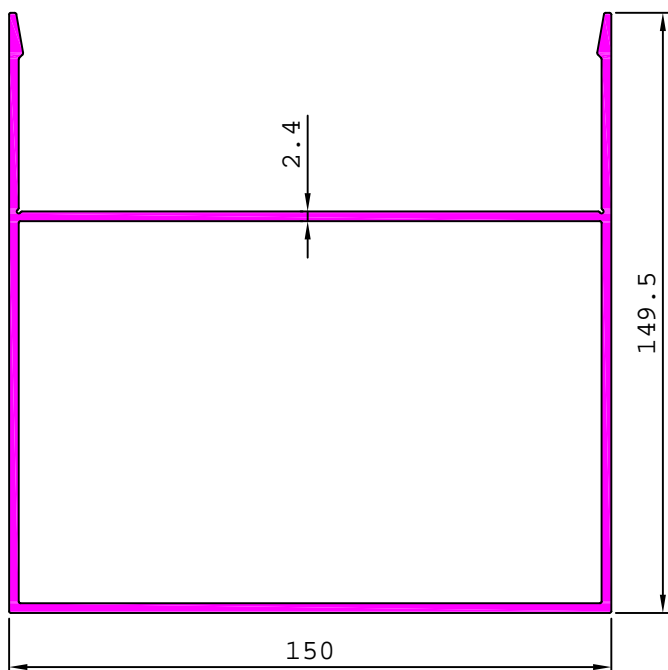

ARCHITECTURAL

CURTAIN WALL SECTION

35596 0.367 kg/m

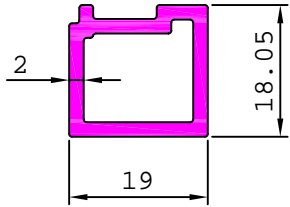

35597

2.385 kg/m

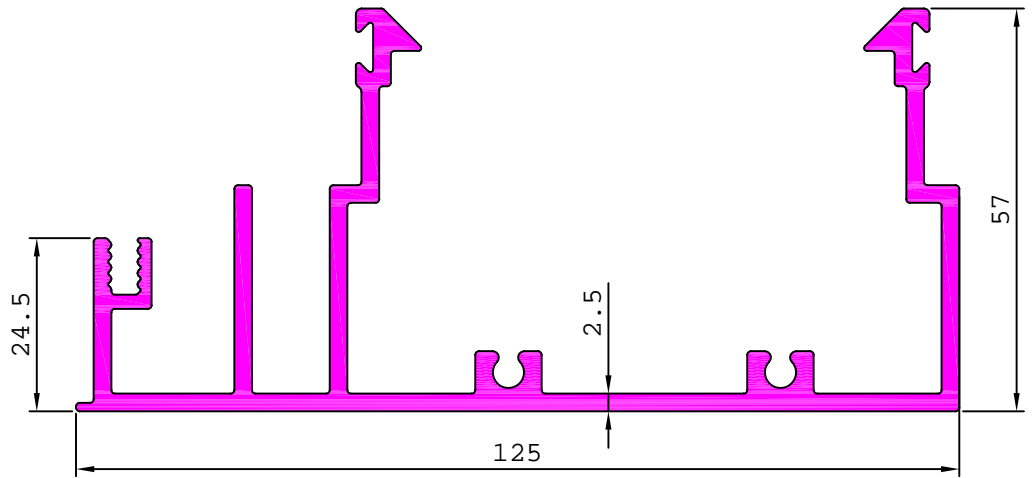

35599

1.853 kg/m

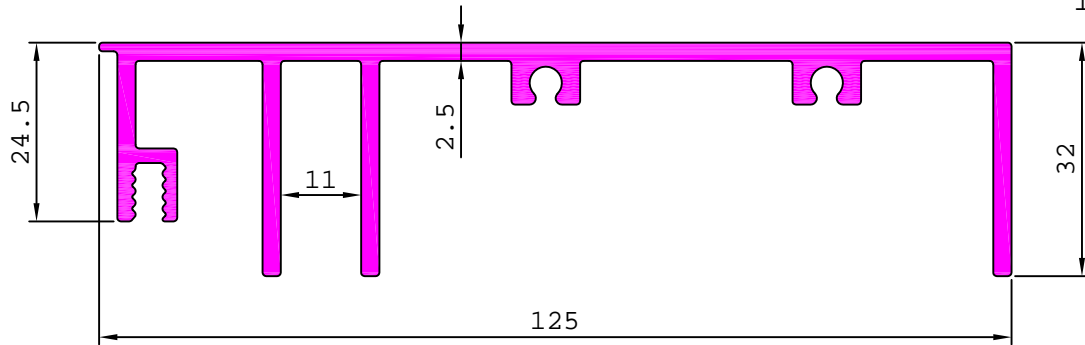

35603

2.514 kg/m

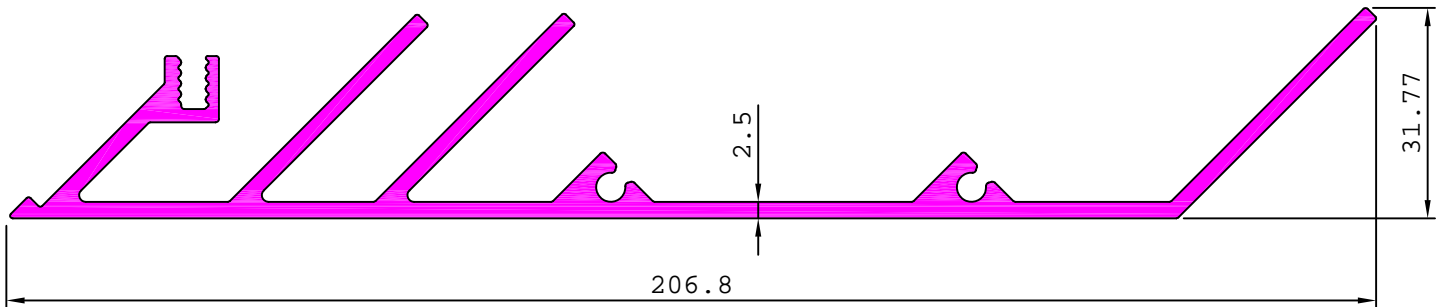

35610

3.069 kg/m

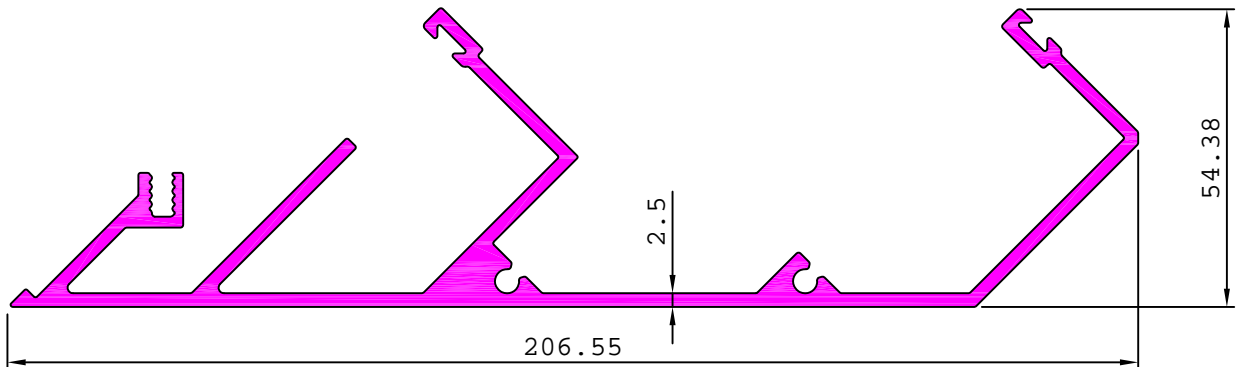

ARCHITECTURAL

CURTAIN WALL SECTION

35600

1.498 kg/m

35601

1.847 kg/m

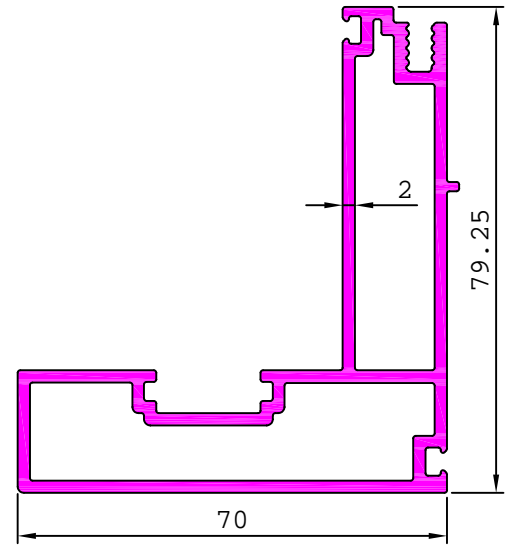
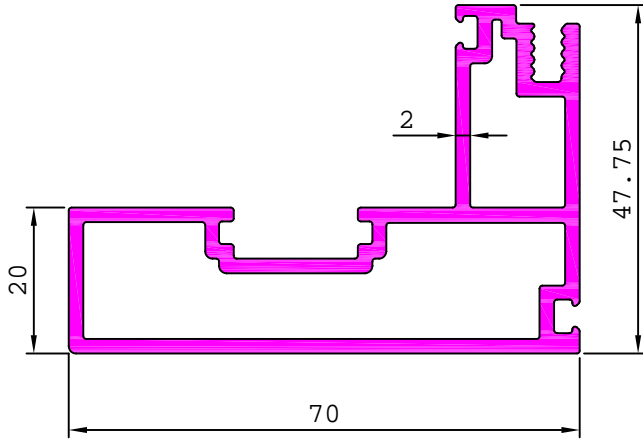

35602

2.977 kg/m

35607

0.579 kg/m

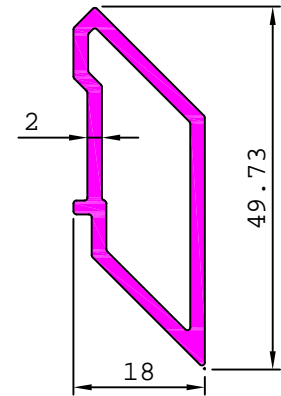
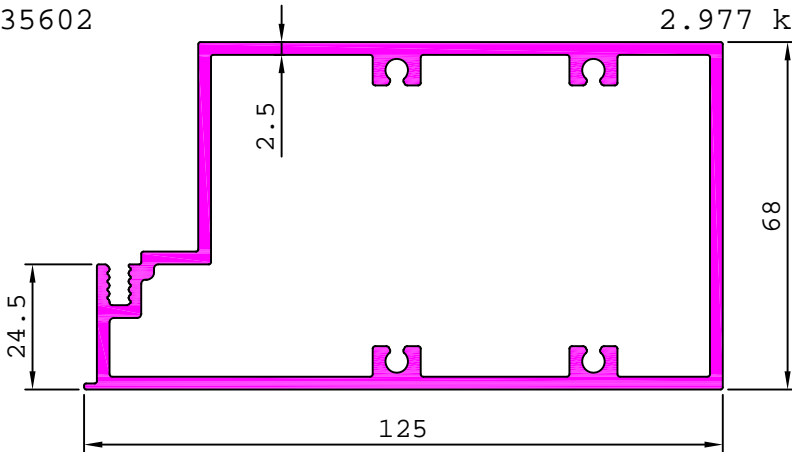

35604

2.444 kg/m

35605

1.749 kg/m

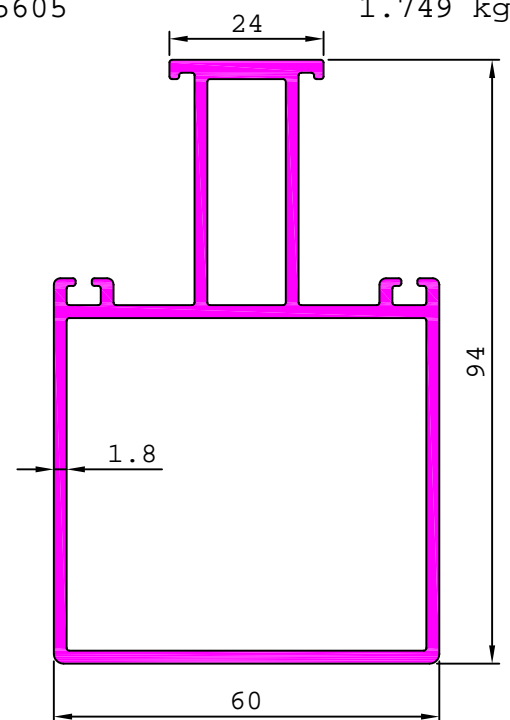
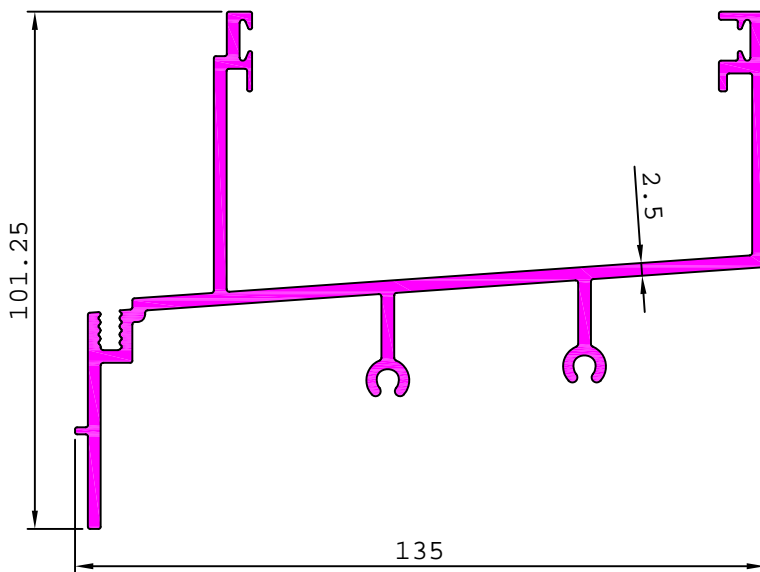

ARCHITECTURAL

CURTAIN WALL SECTION

35608

2.935 kg/m

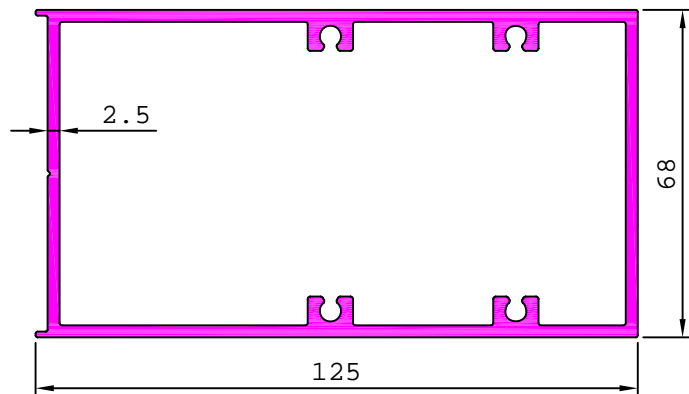

35609

0.905 kg/m

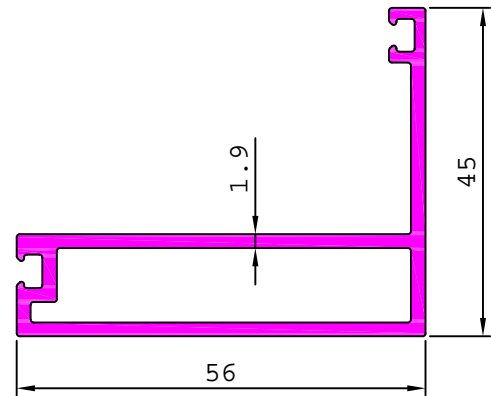

35611

2.238 kg/m

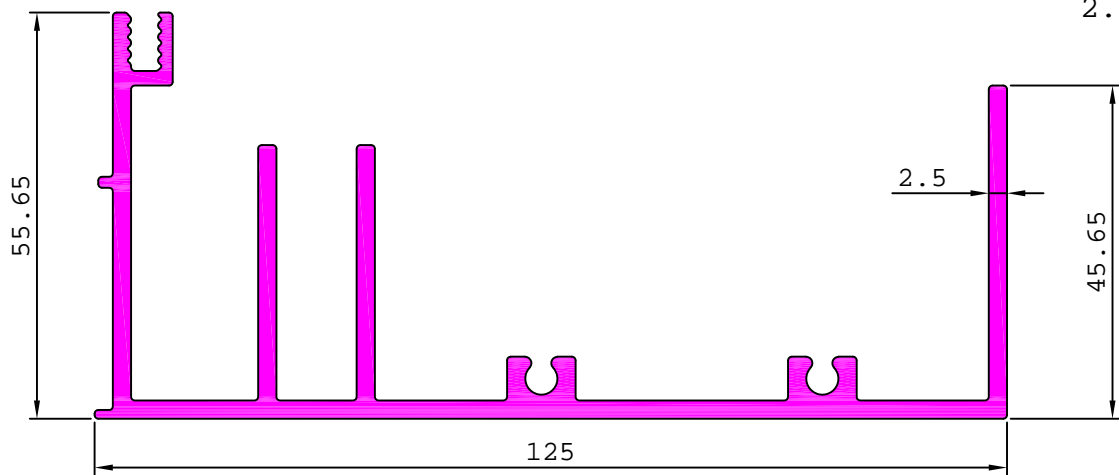

35612

2.462 kg/m

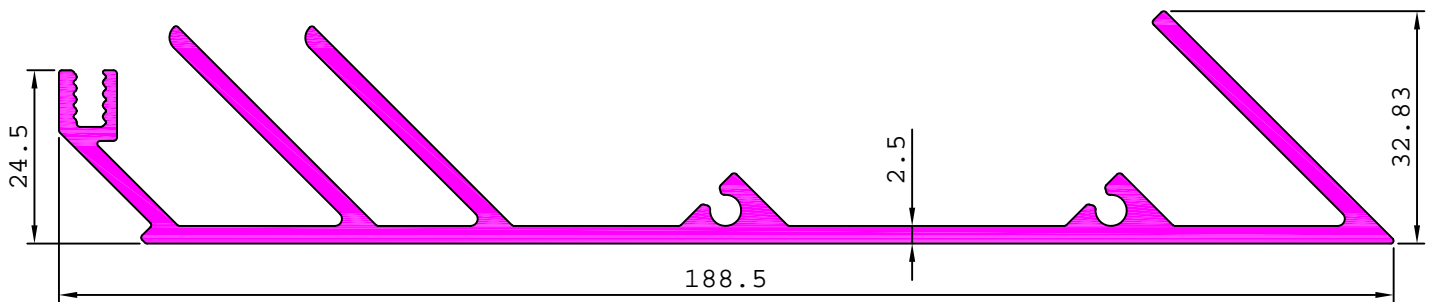

35613

3.046 kg/m

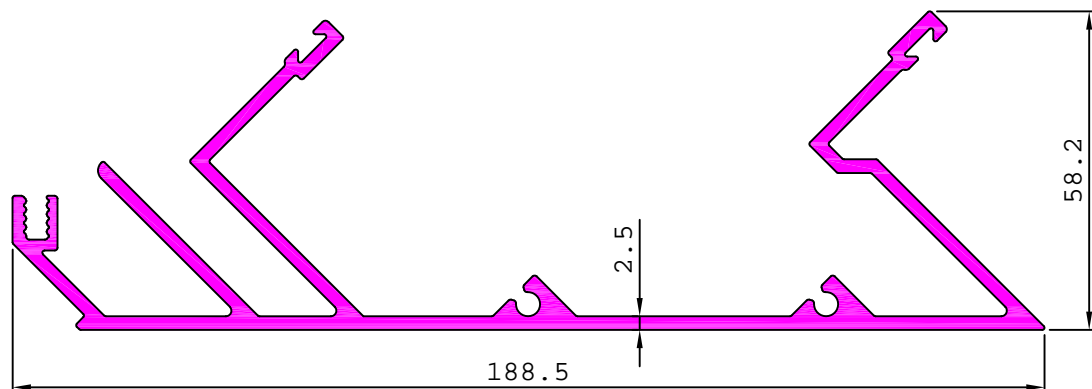

ARCHITECTURAL

CURTAIN WALL SECTION

35618

2.456 kg/m

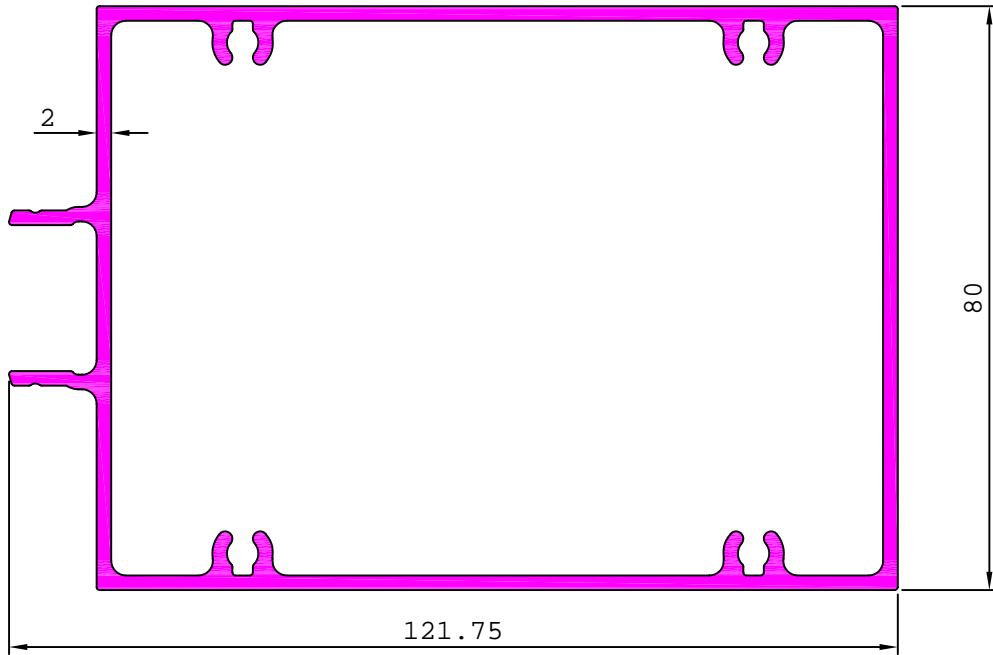

35620

2.464 kg/m

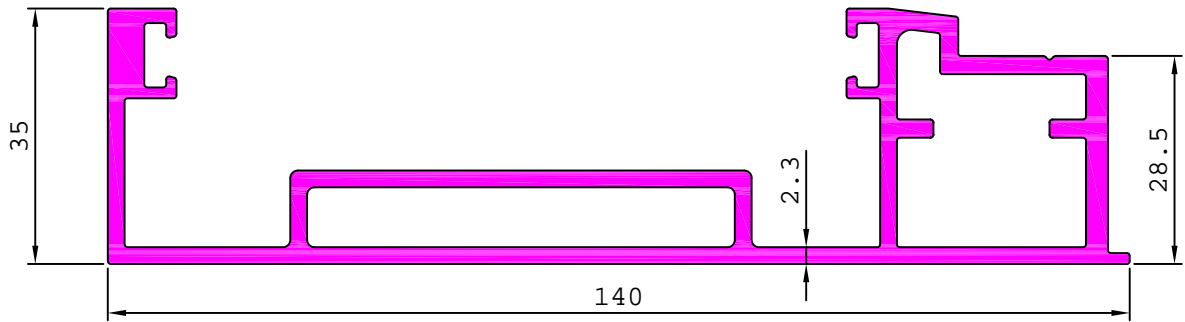

35621

0.284 kg/m

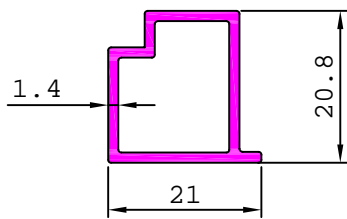

35623

0.836 kg/m

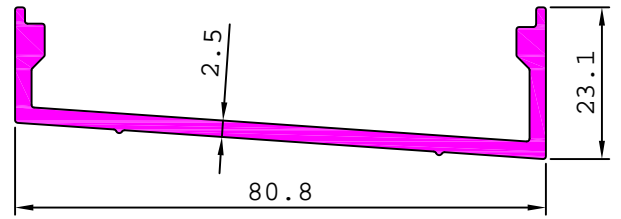

35619

0.899 kg/m

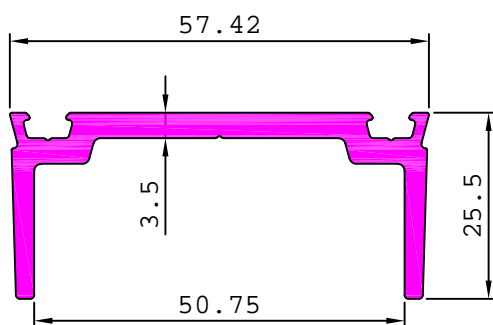

35622

0.525 kg/m

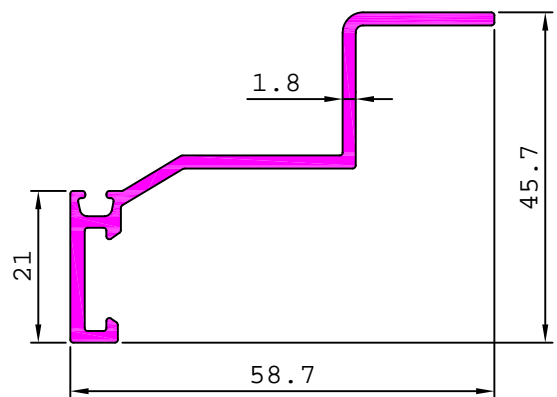

ARCHITECTURAL

CURTAIN WALL SECTION

35624

1.304 kg/m

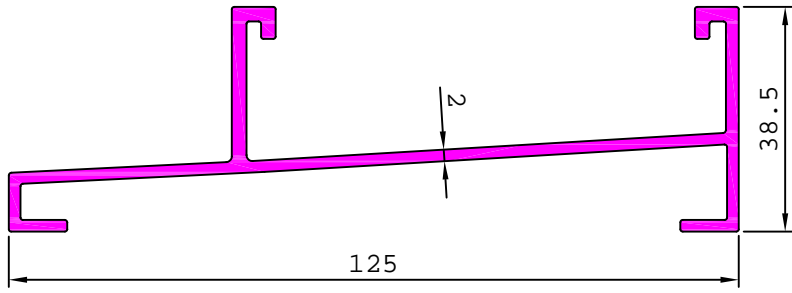

35626

0.397 kg/m

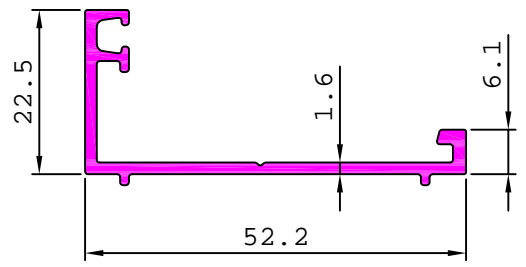

35625

3.447 kg/m

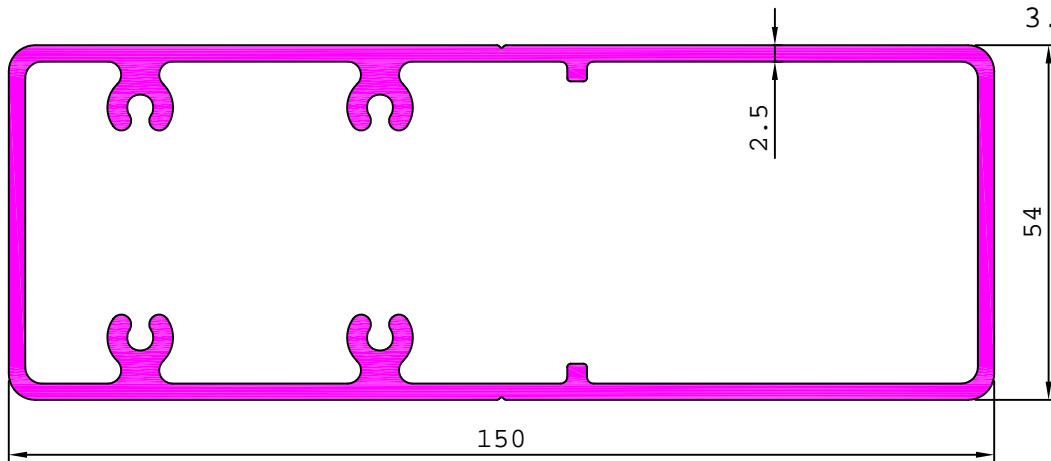

35627

0.976 kg/m

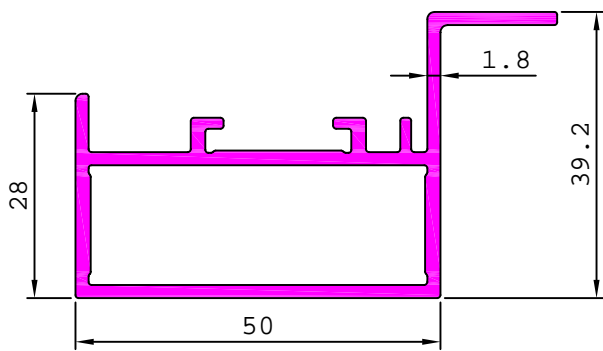

35628

0.726 kg/m

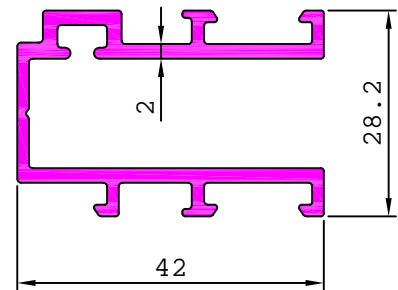

35631

2.143 kg/m

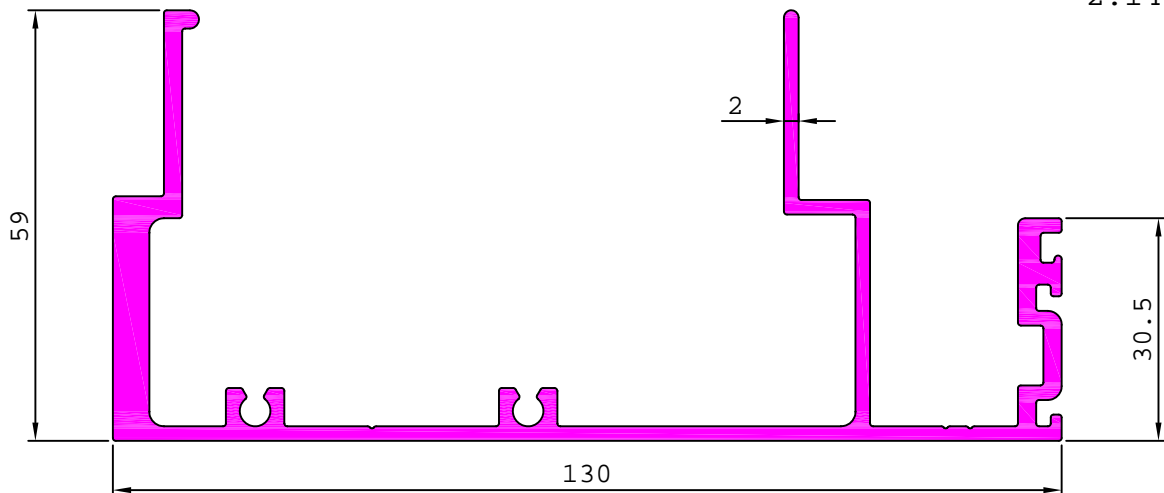

ARCHITECTURAL

CURTAIN WALL SECTION

35629 0.860 kg/m

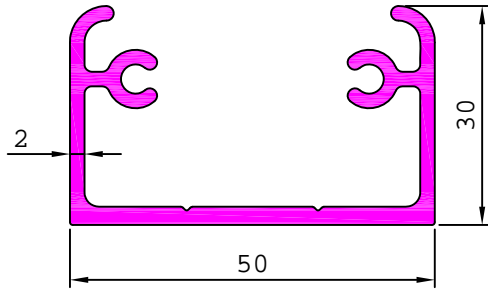

35630 0.368 kg/m

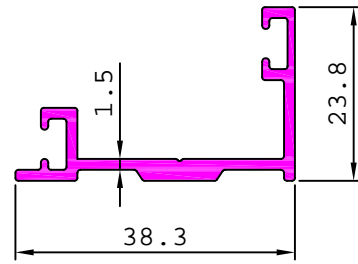

35632 1.780 kg/m

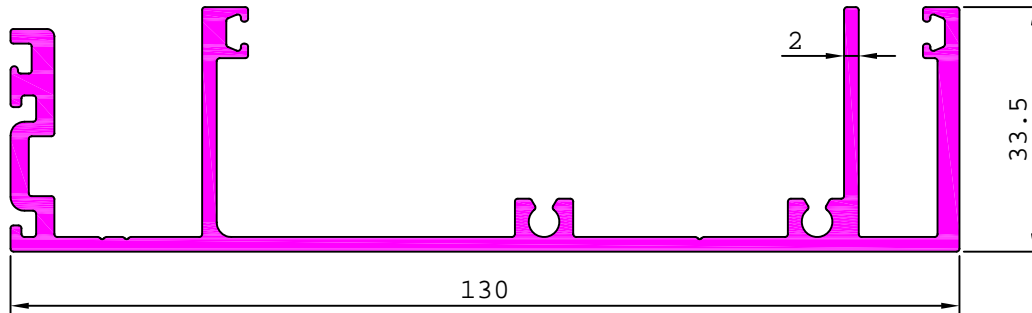

35633 2.008 kg/m

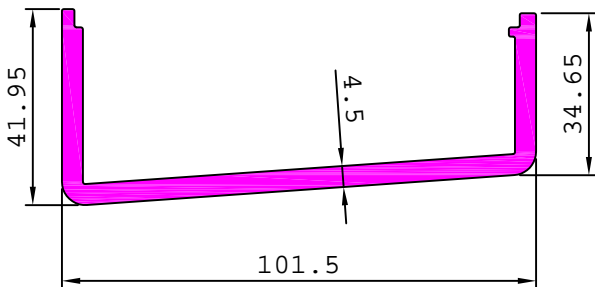

35634 3.098 kg/m

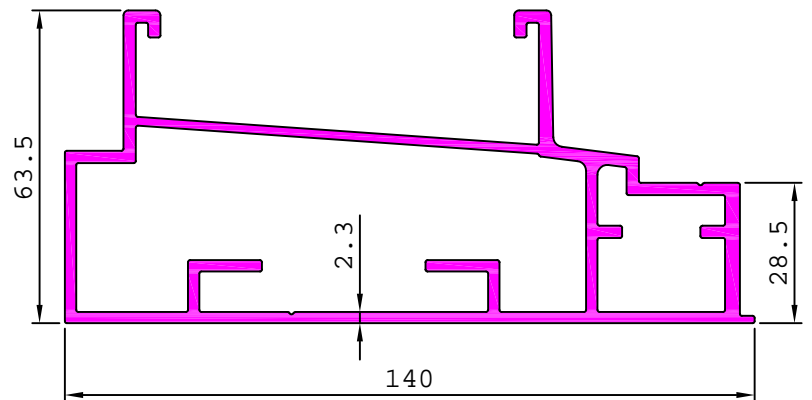

35635 2.111 kg/m

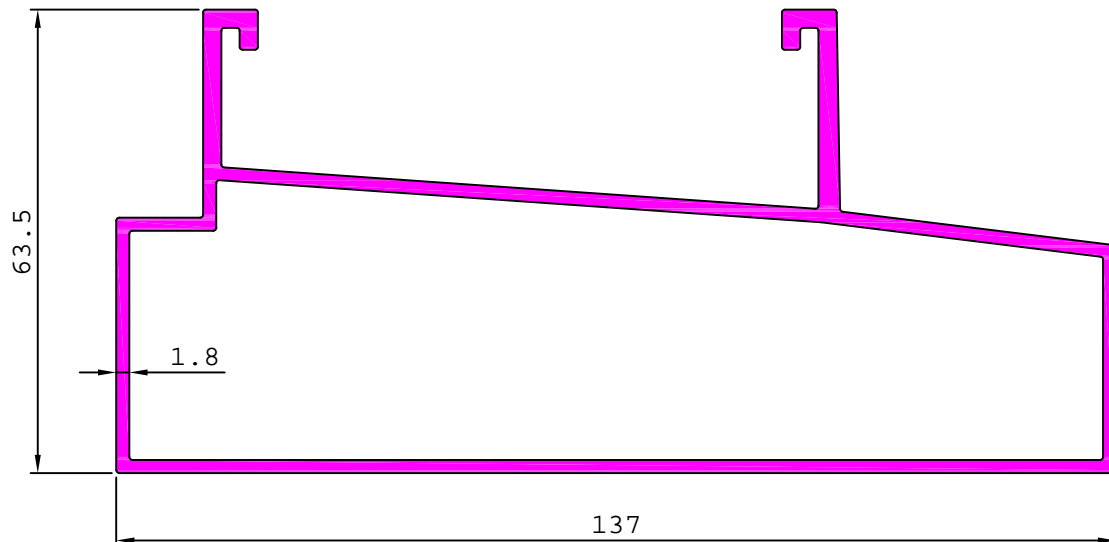

ARCHITECTURAL

CURTAIN WALL SECTION

35636 0.565 kg/m

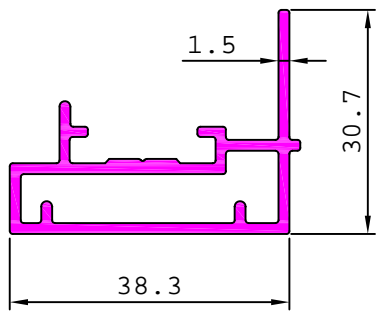

35637 140 2.517 kg/m

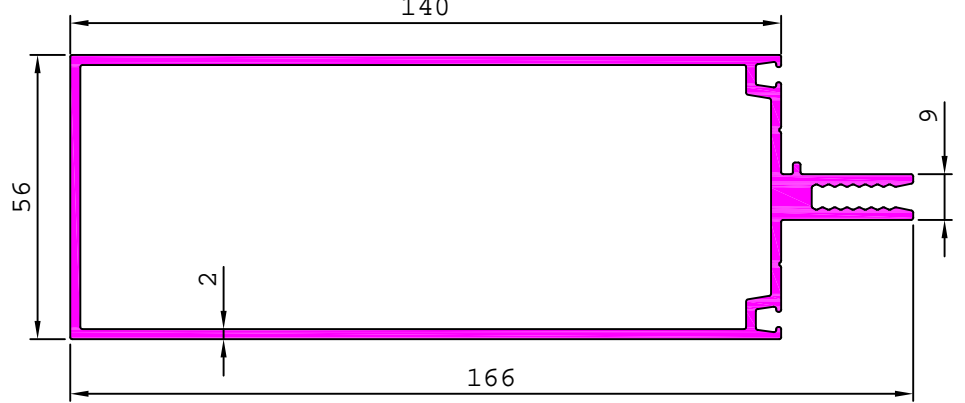

35638 65 1.707 kg/m

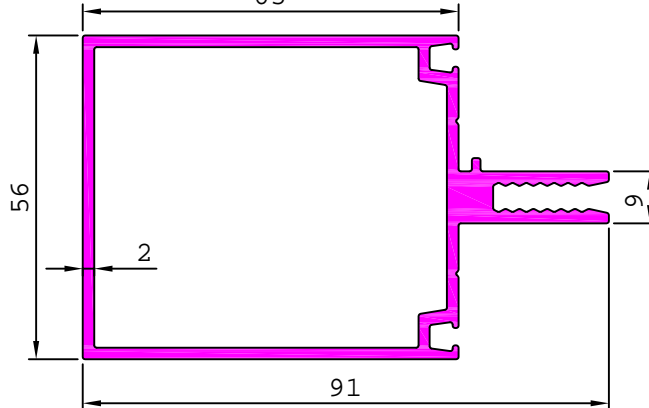

35640 0.446 kg/m

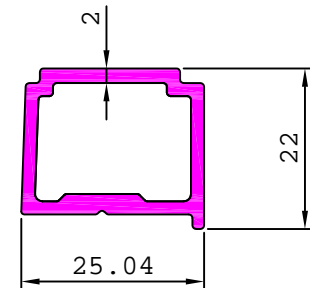

35639 155 2.679 kg/m

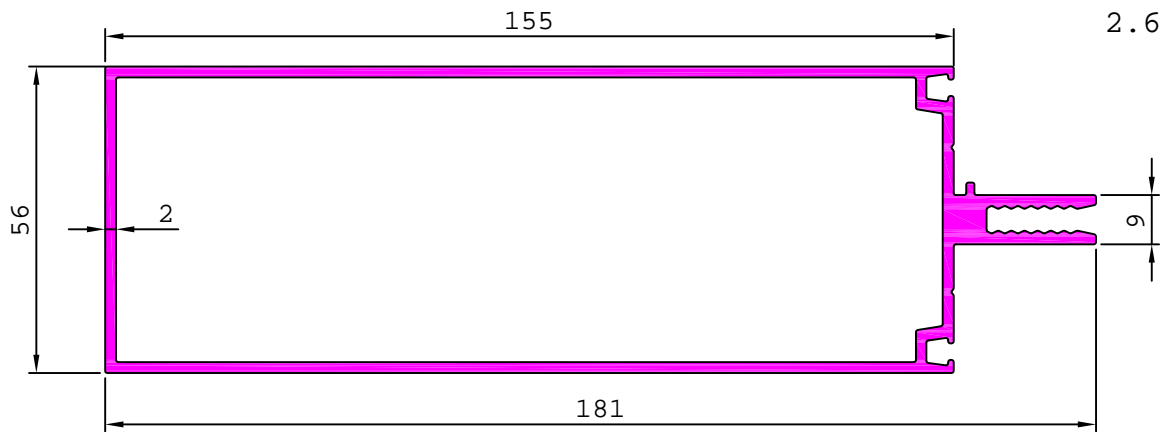

35642 155 2.591 kg/m

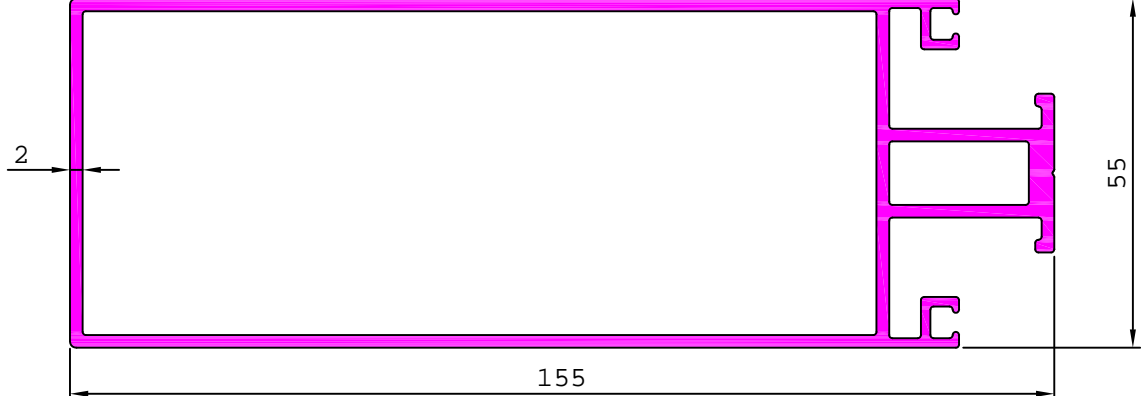

ARCHITECTURAL

CURTAIN WALL SECTION

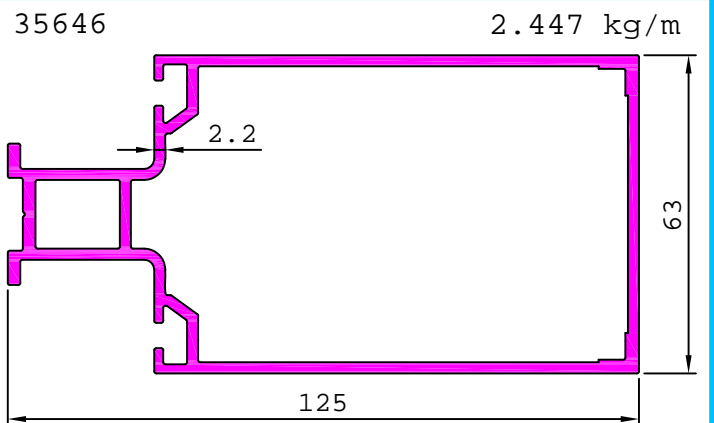
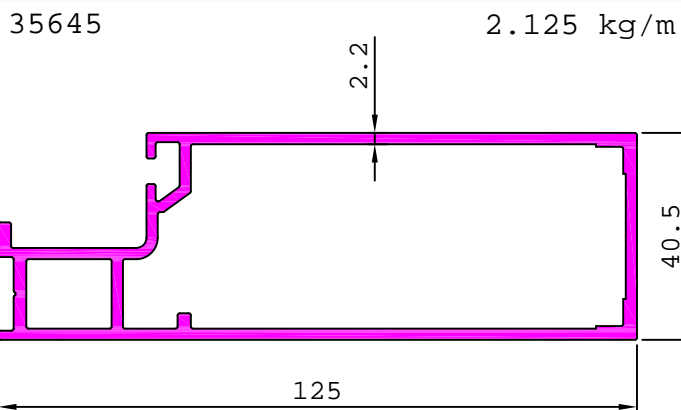
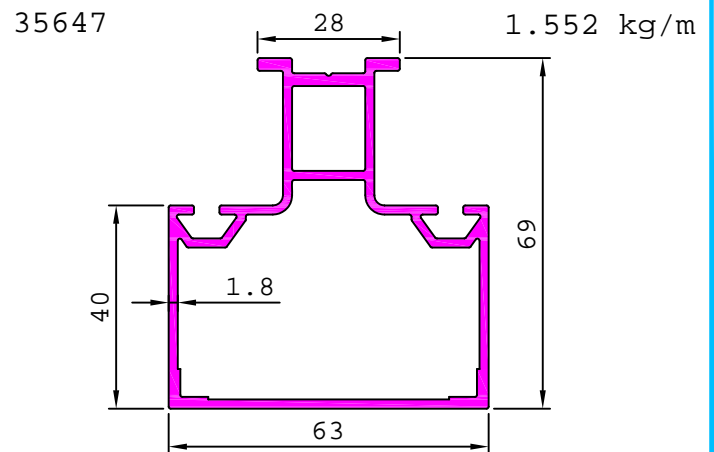
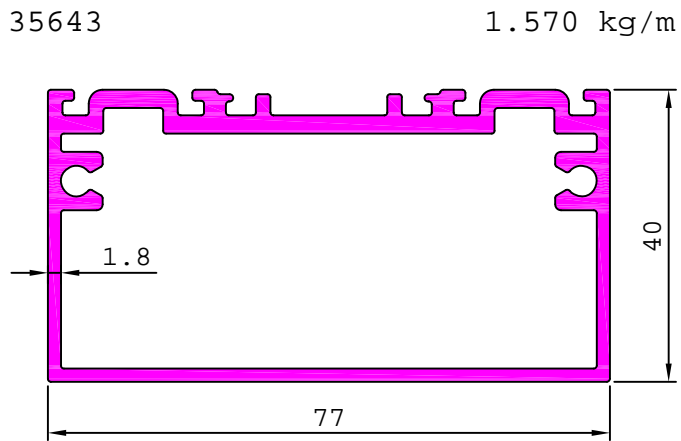
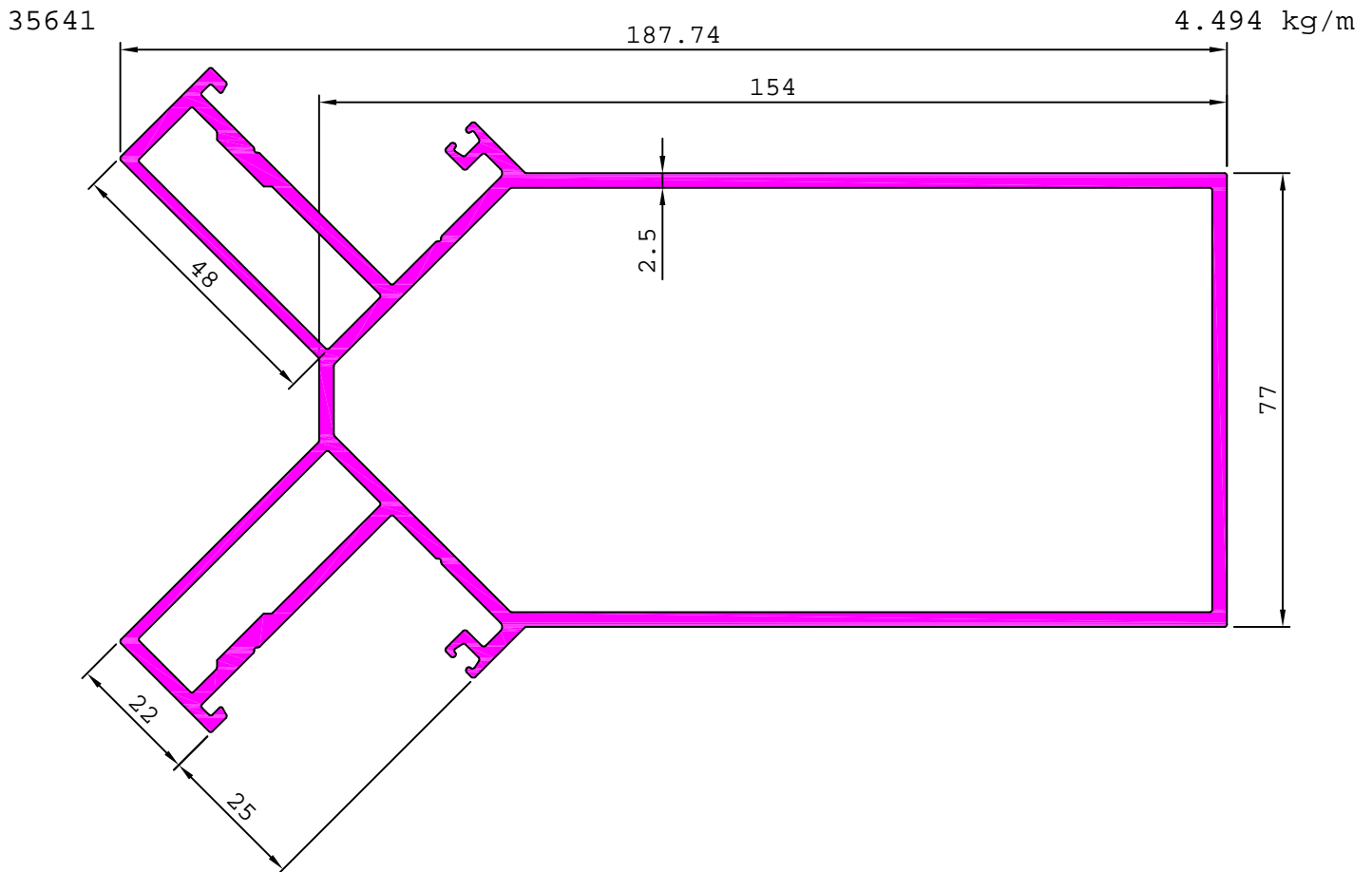

ARCHITECTURAL

CURTAIN WALL SECTION

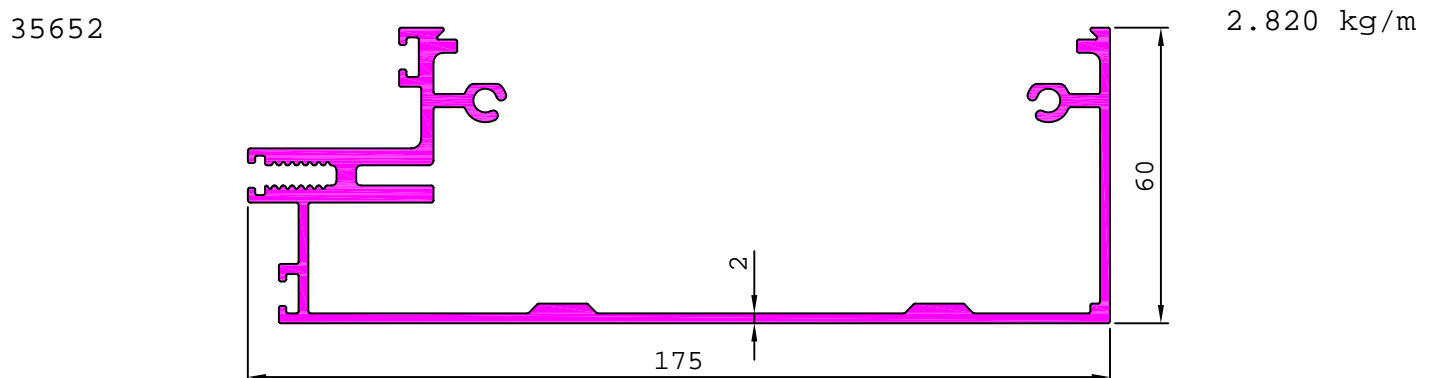
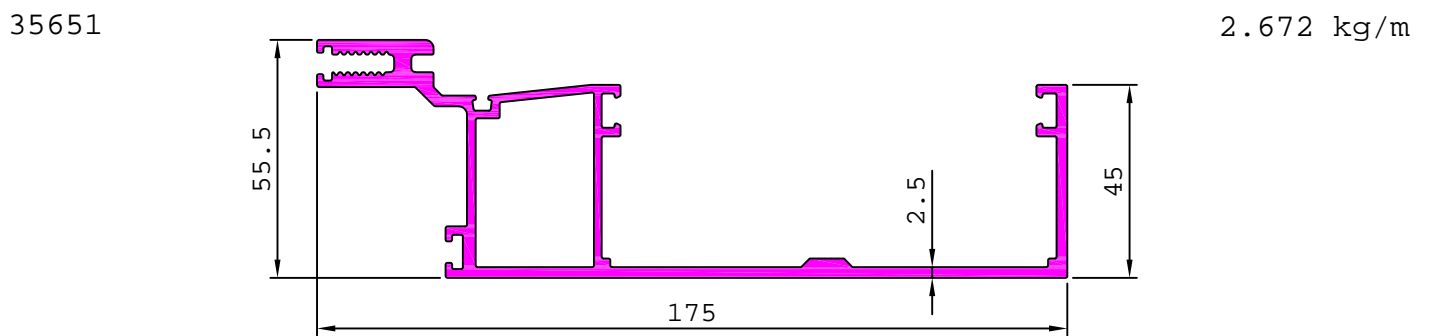
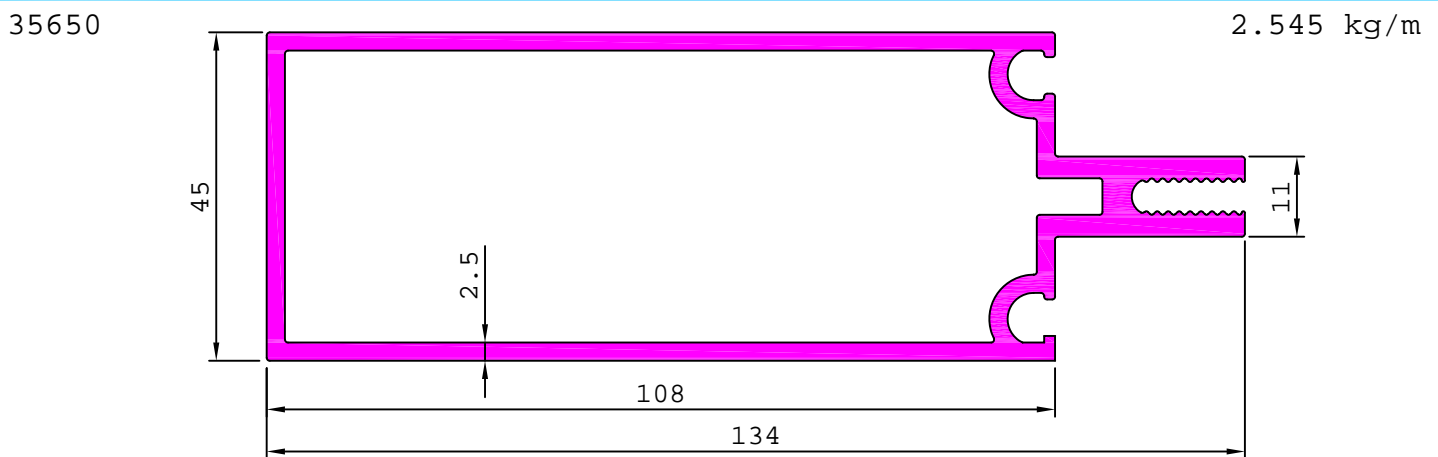
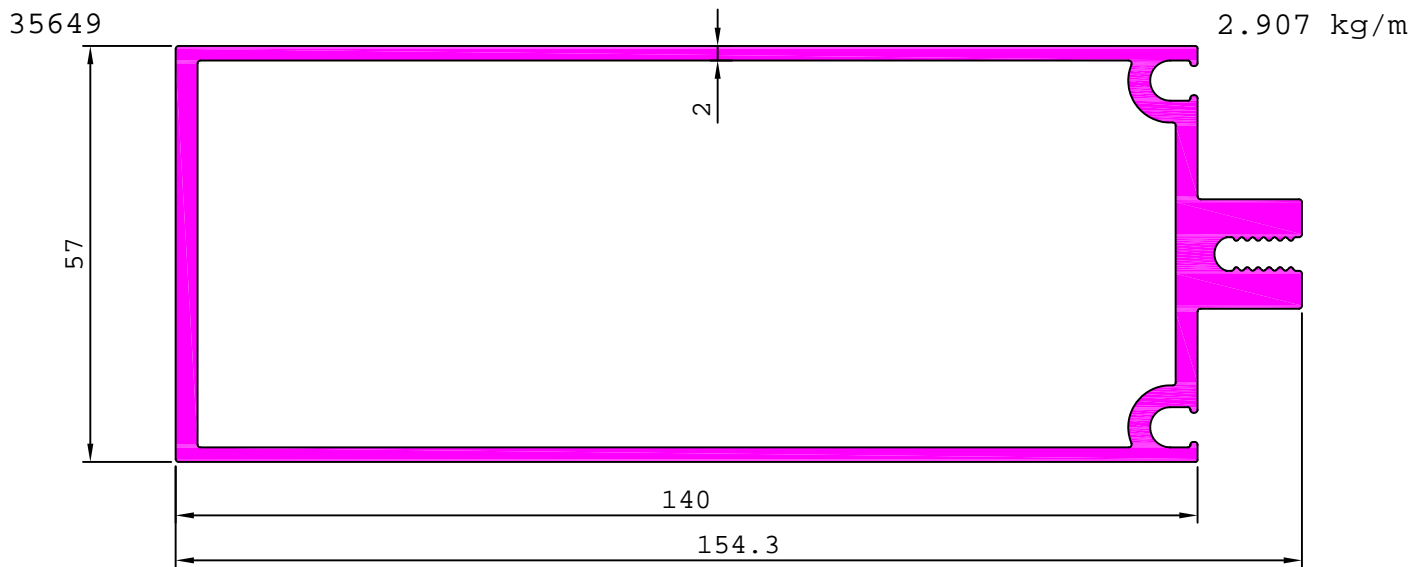

ARCHITECTURAL

CURTAIN WALL SECTION

35653

3.548 kg/m

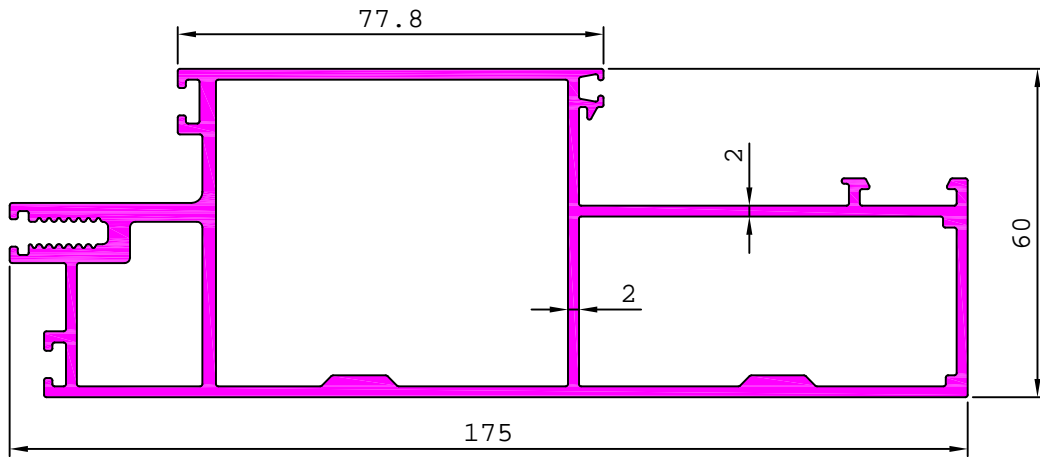

35654

2.505 kg/m

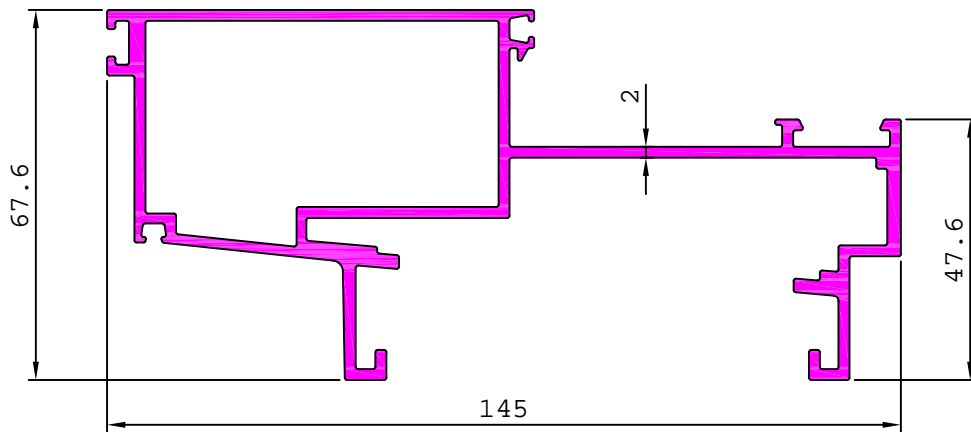

35655

3.692 kg/m

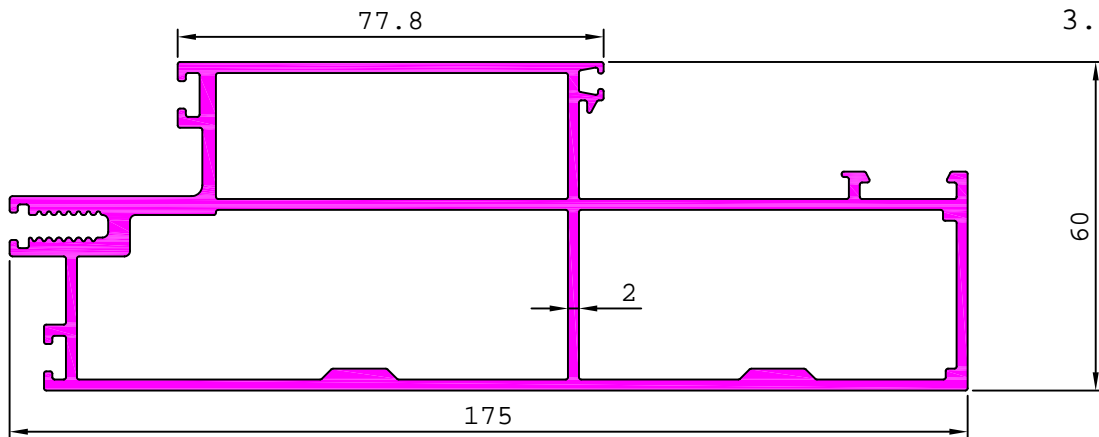

35656

2.553 kg/m

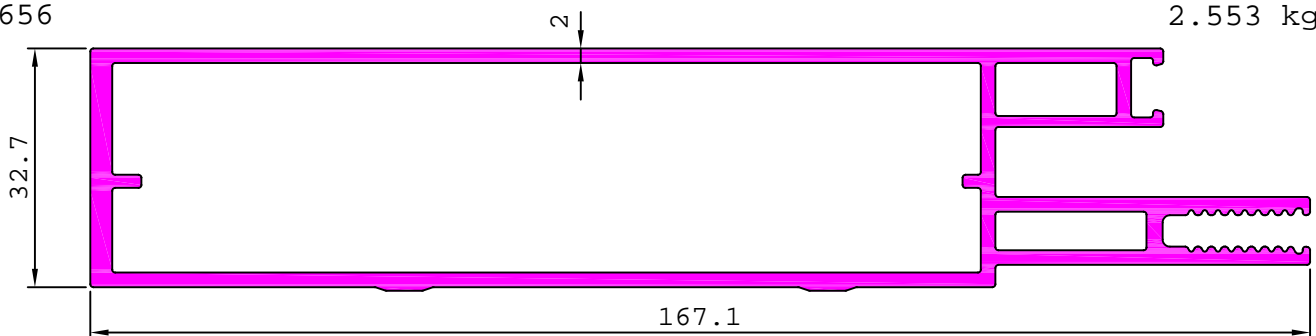

ARCHITECTURAL

CURTAIN WALL SECTION

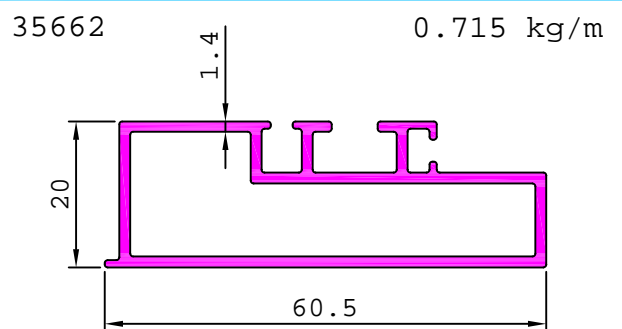
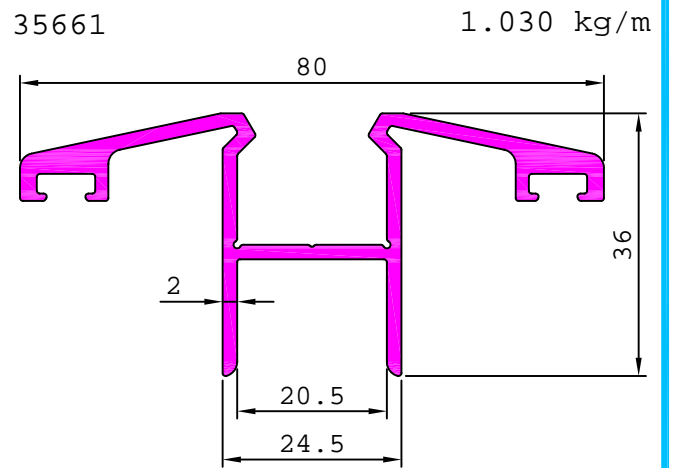
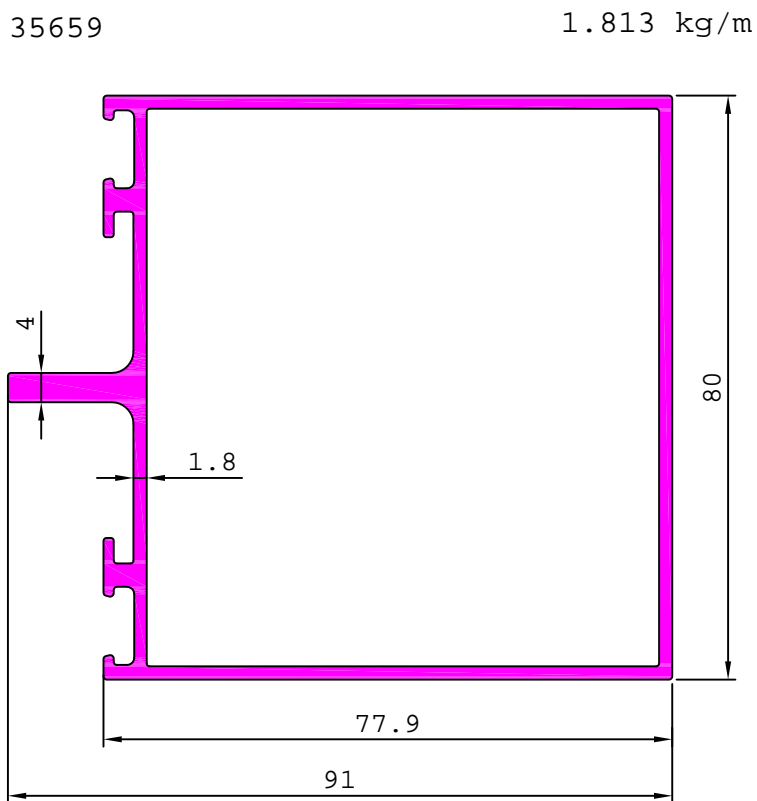
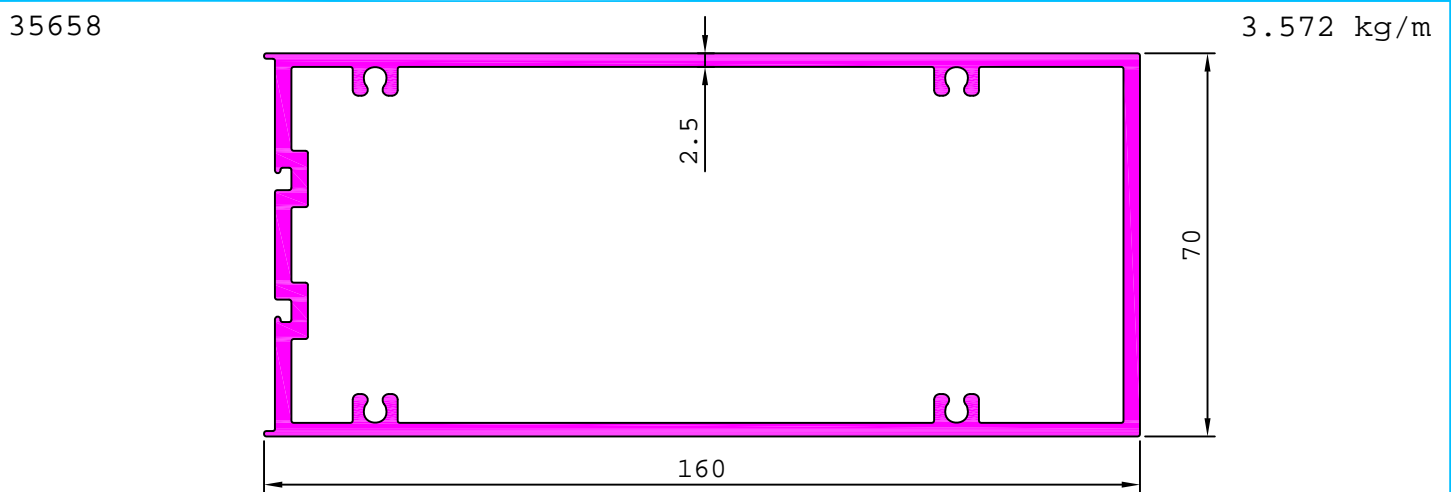
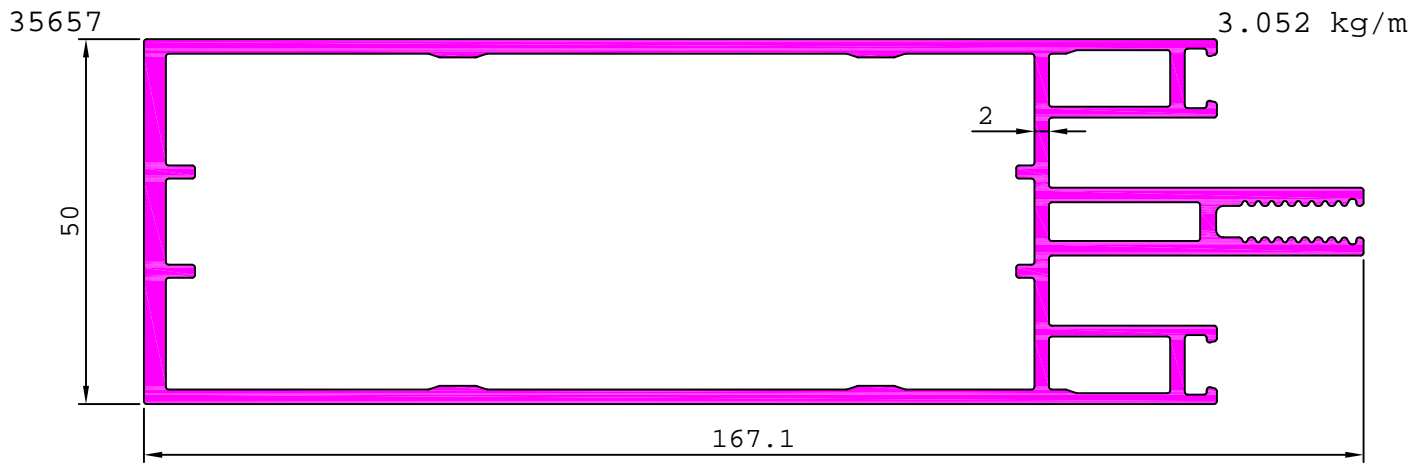

ARCHITECTURAL

CURTAIN WALL SECTION

35663

1.809 kg/m

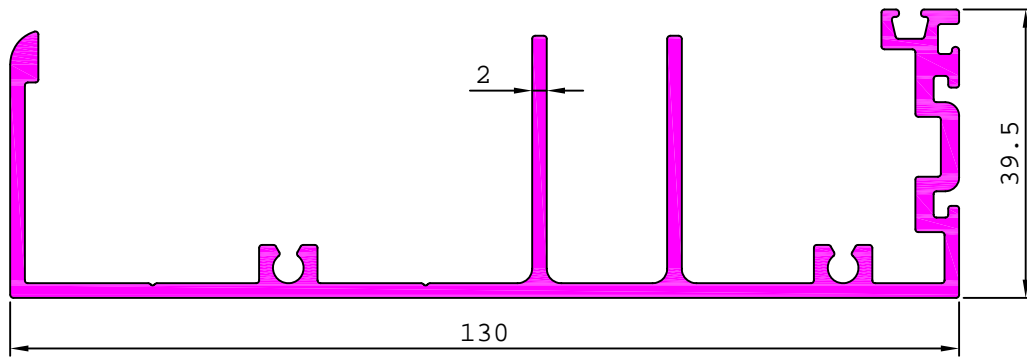

35666

0.391 kg/m

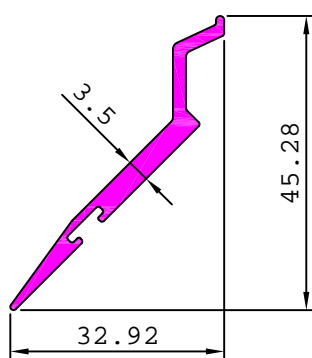

35664

0.365 kg/m

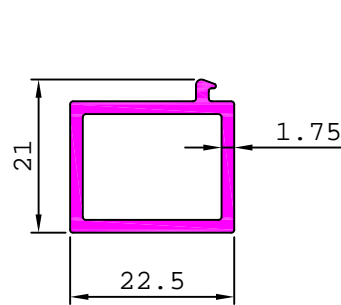

35665

0.605 kg/m

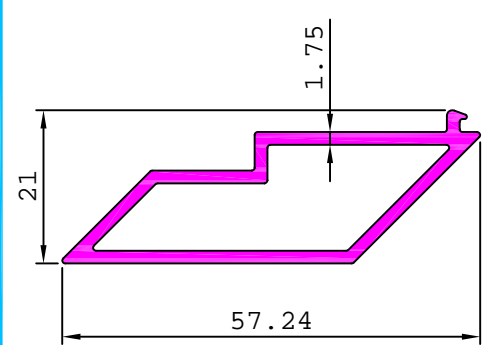

35667

5.721 kg/m

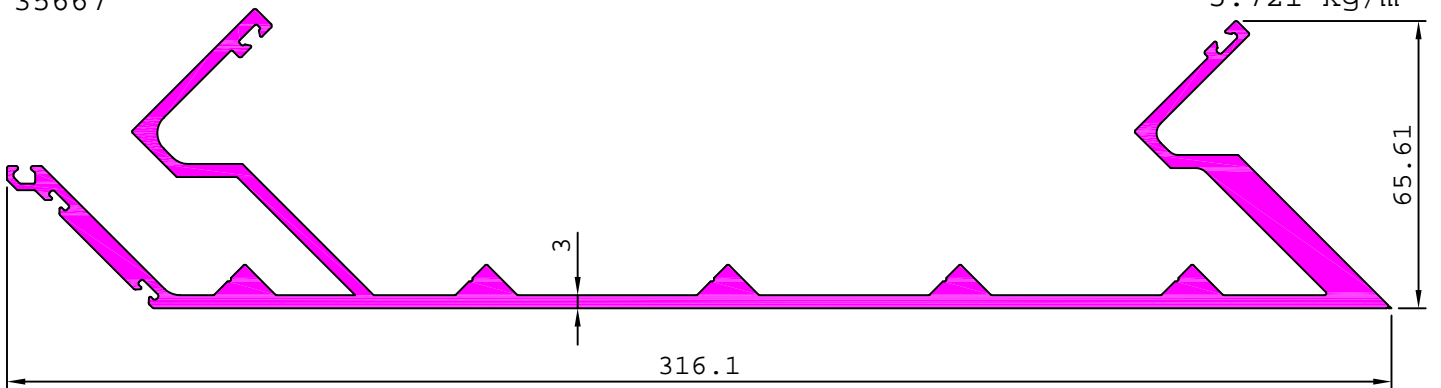

35669

2.972 kg/m

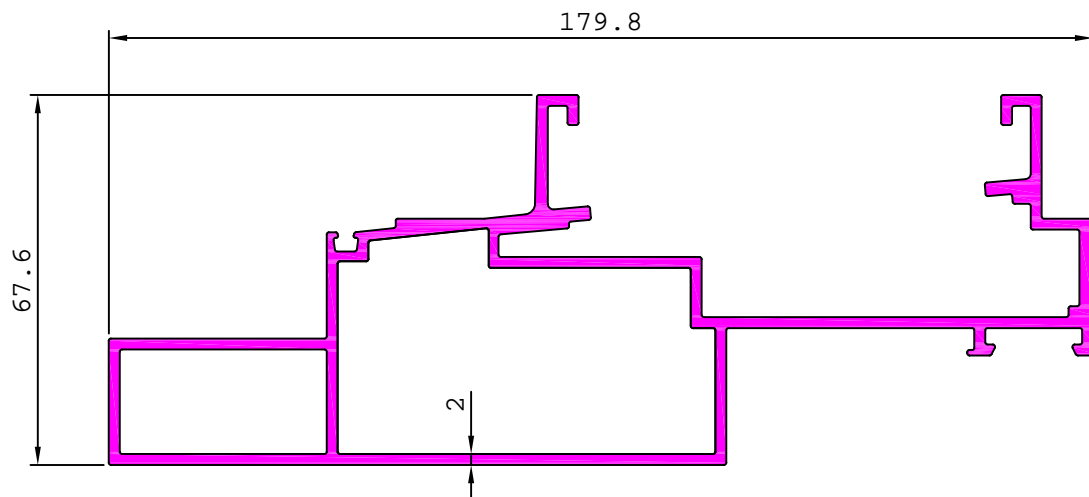

ARCHITECTURAL

CURTAIN WALL SECTION

35668

4.920 kg/m

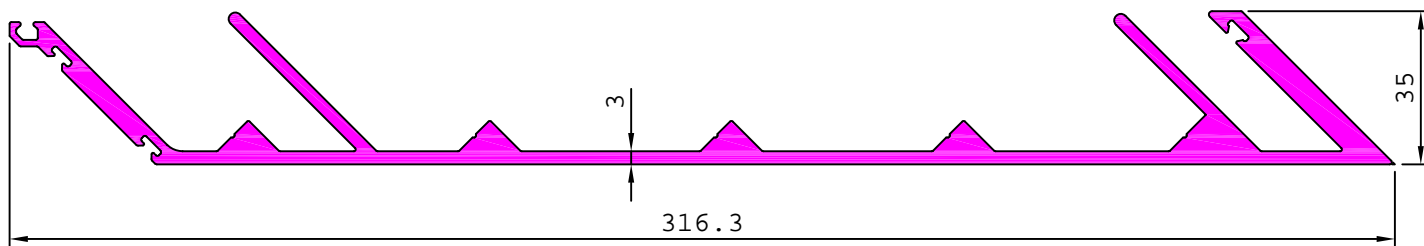

35670

4.334 kg/m

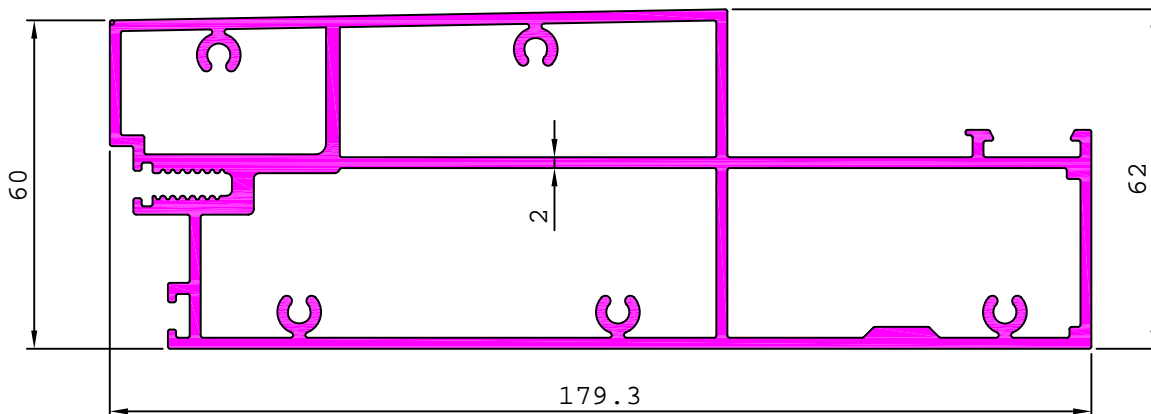

35671

1.035 kg/m

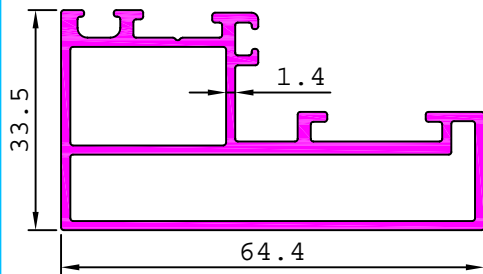

35674

0.882 kg/m

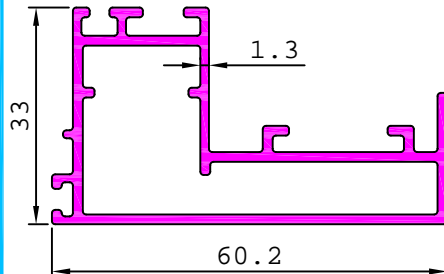

35675

0.659 kg/m

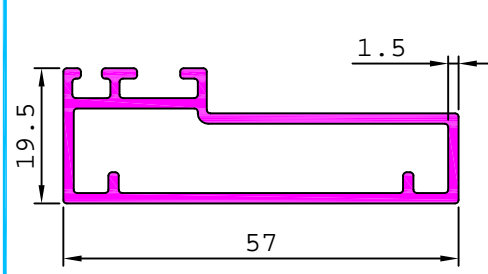

35672

0.984 kg/m

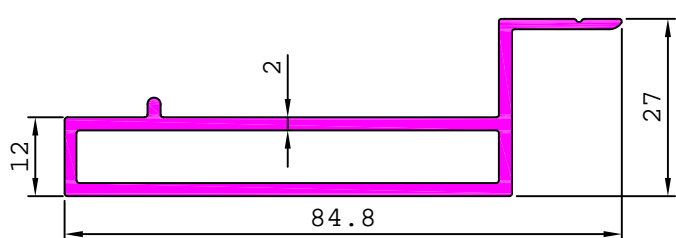

35673

1.286 kg/m

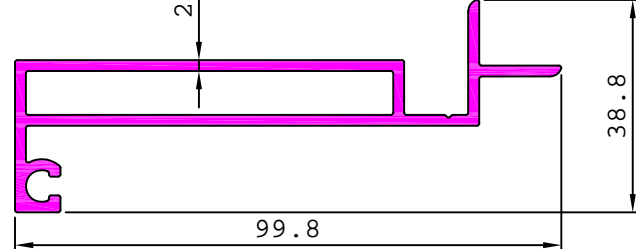

35677

4.405 kg/m

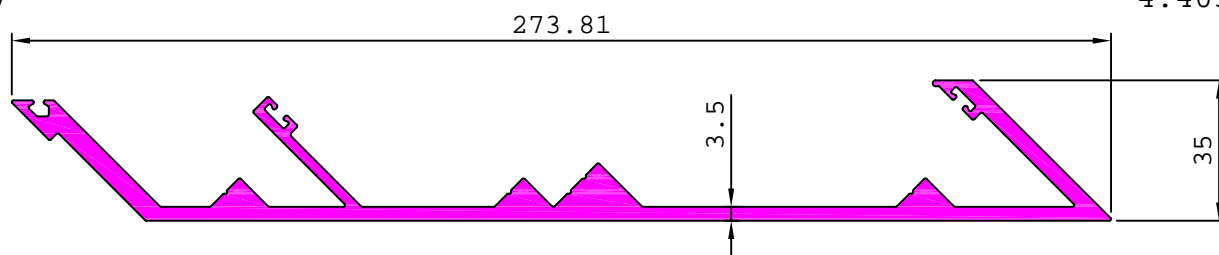

ARCHITECTURAL

CURTAIN WALL SECTION

35676

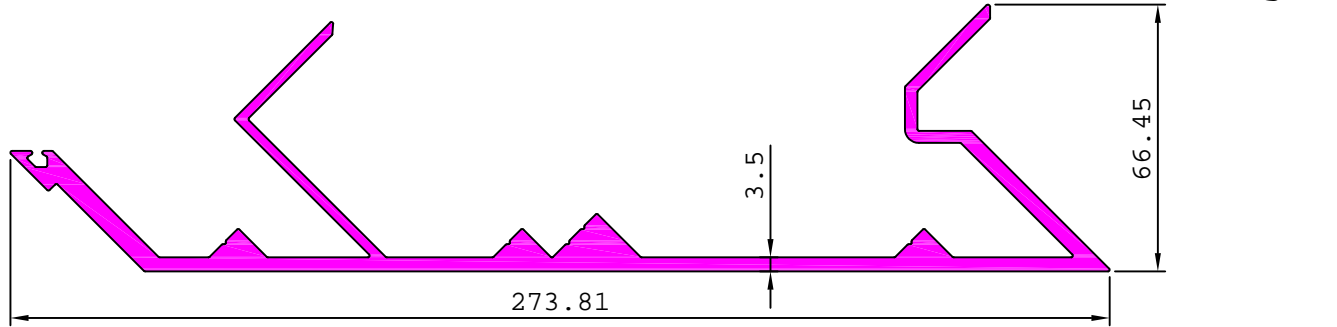

35678

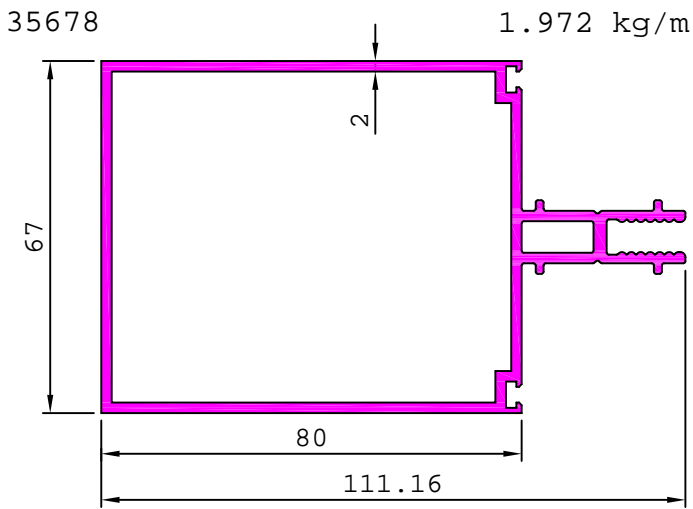

35679

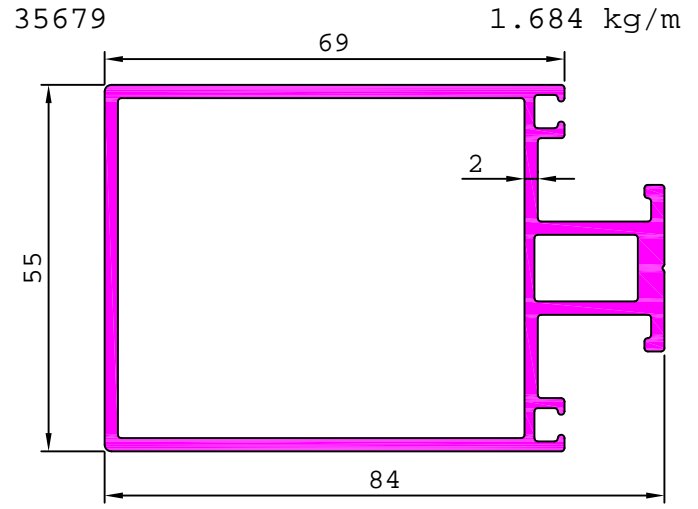

35680

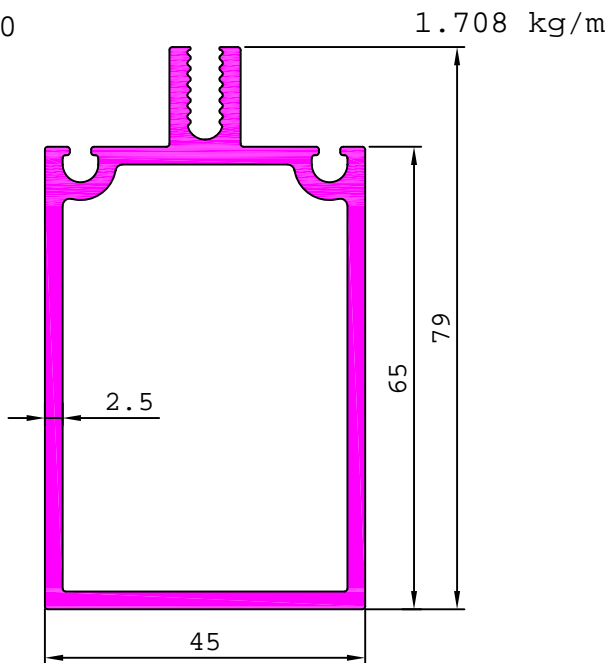

35686

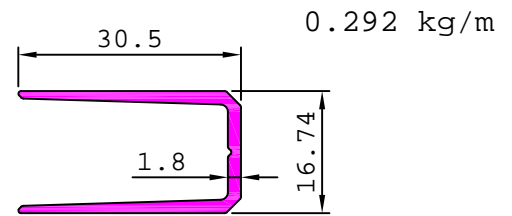

35687

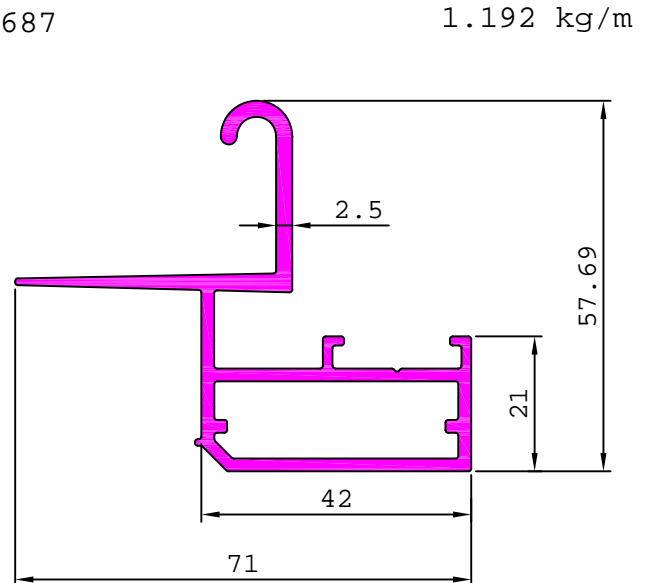

35683

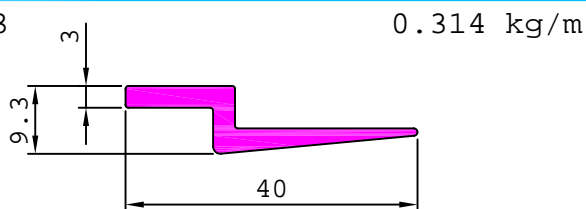

ARCHITECTURAL

CURTAIN WALL SECTION

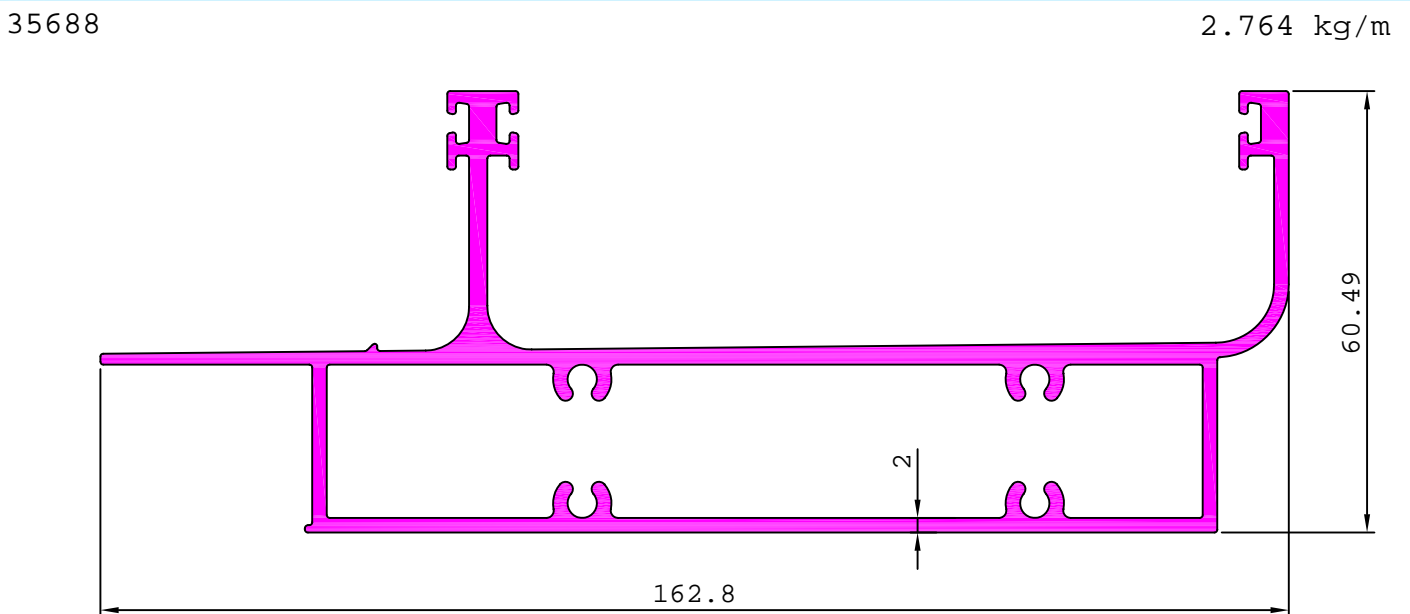
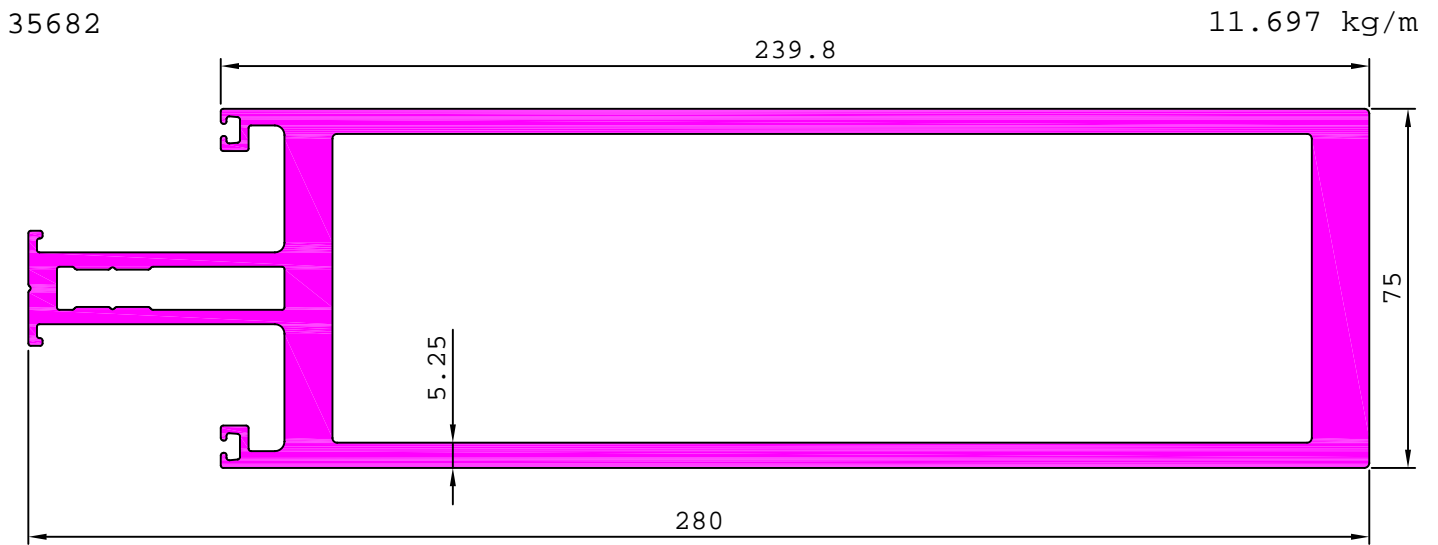
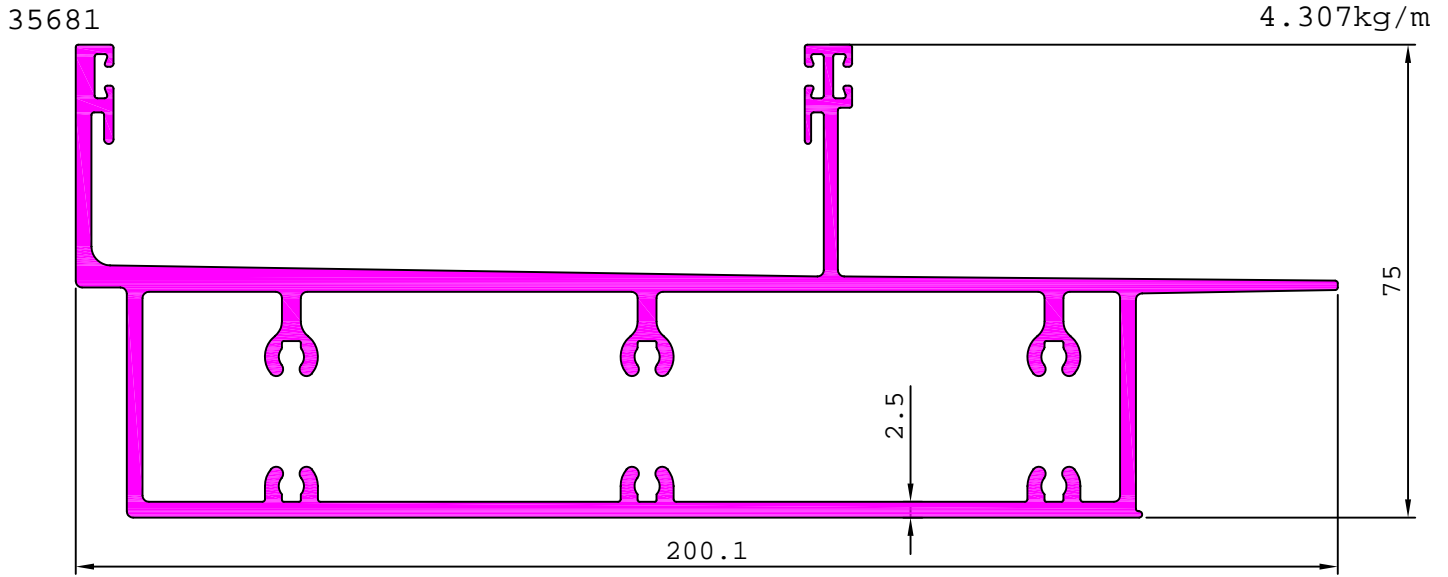

ARCHITECTURAL

CURTAIN WALL SECTION

35689

5.287kg/m

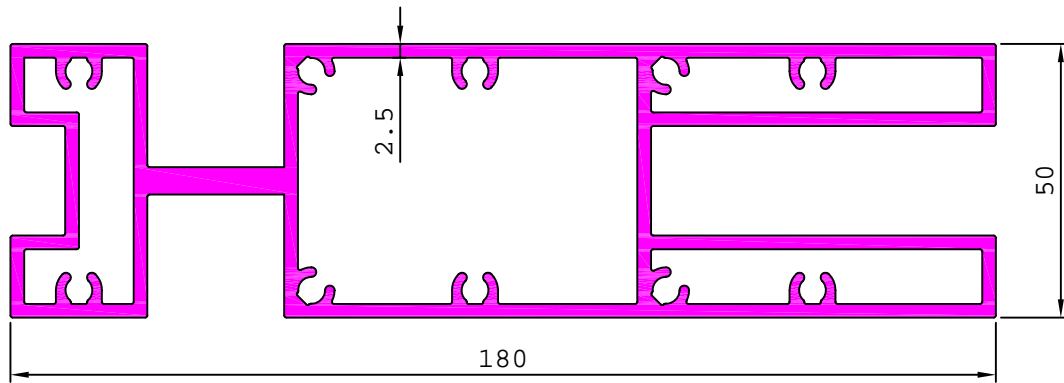

35691

3.257 kg/m

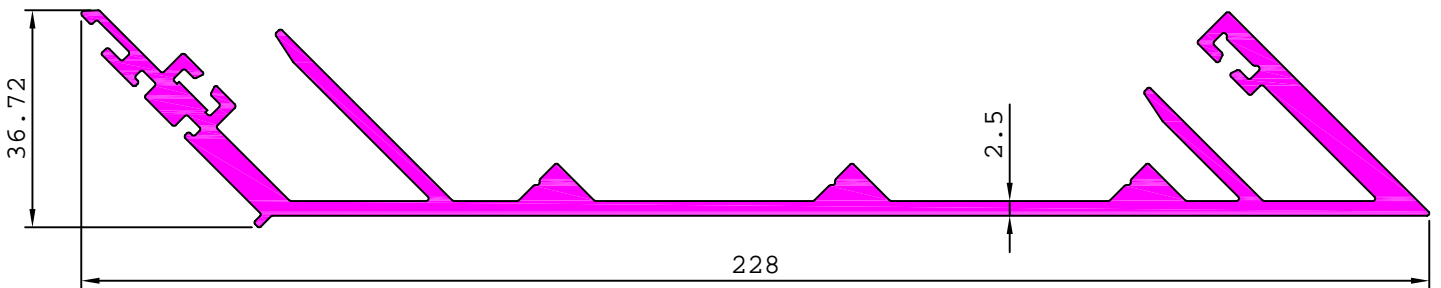

35692

4.545 kg/m

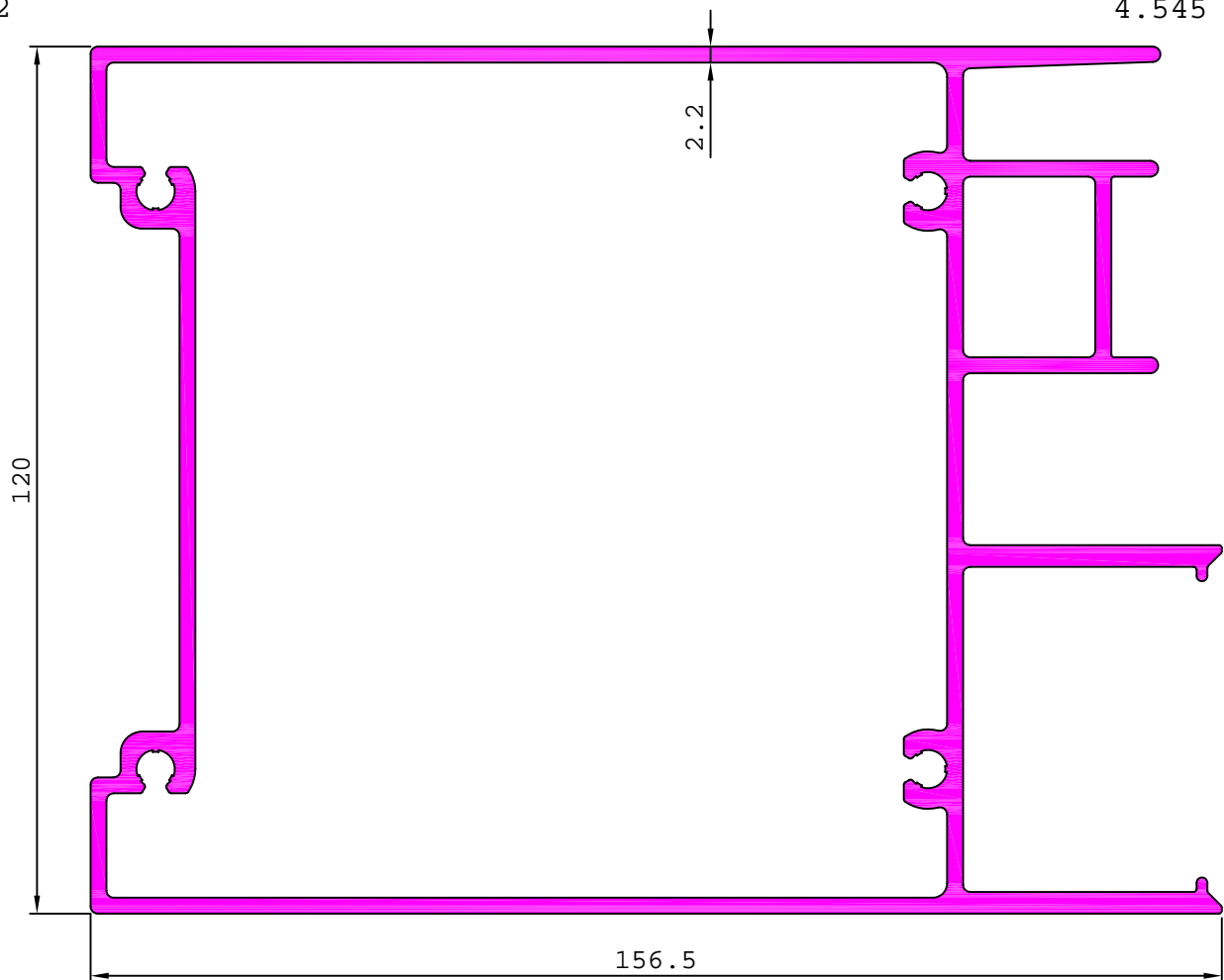

ARCHITECTURAL

CURTAIN WALL SECTION

35693

0.563 kg/m

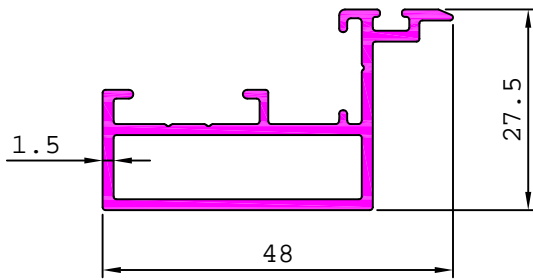

35705

0.541 kg/m

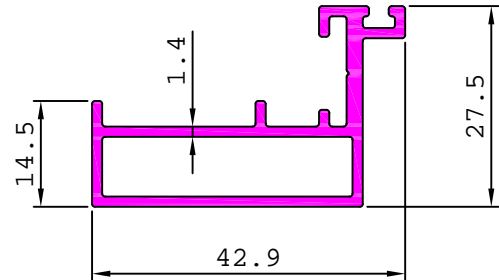

35694

3.606 kg/m

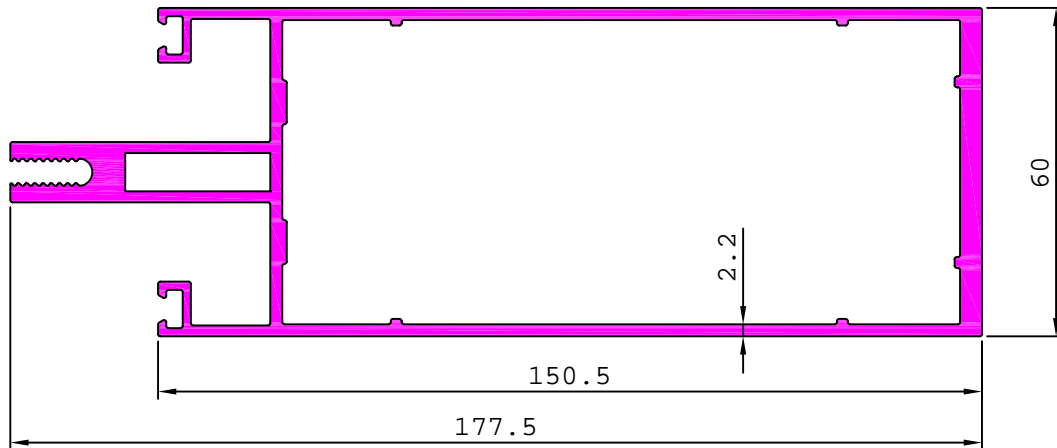

35695

1.975 kg/m

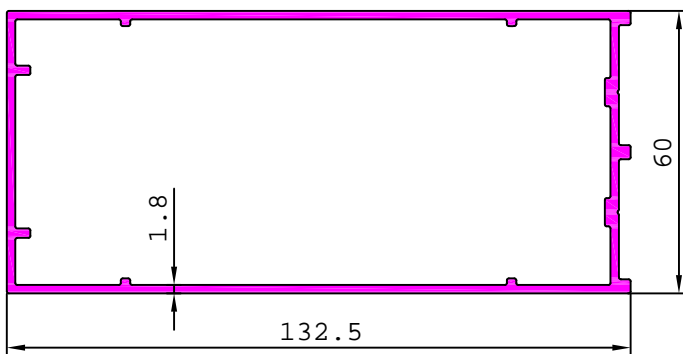

35696

1.394 kg/m

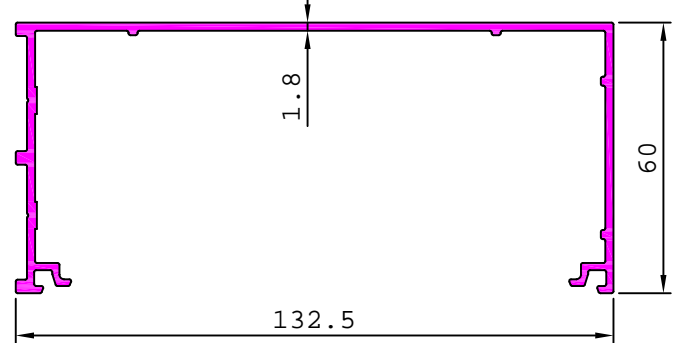

35697

0.669 kg/m

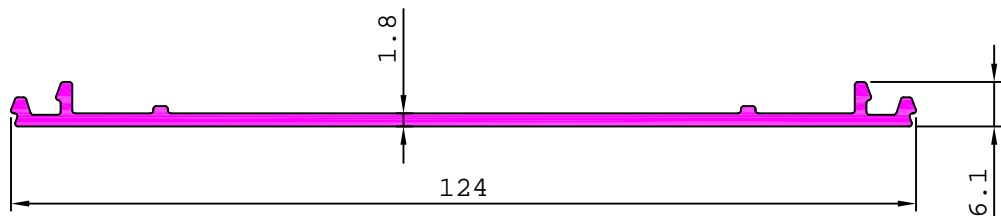

35698

0.280 kg/m

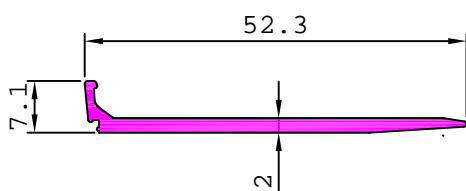

35699

0.237 kg/m

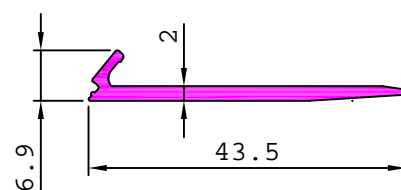

ARCHITECTURAL

CURTAIN WALL SECTION

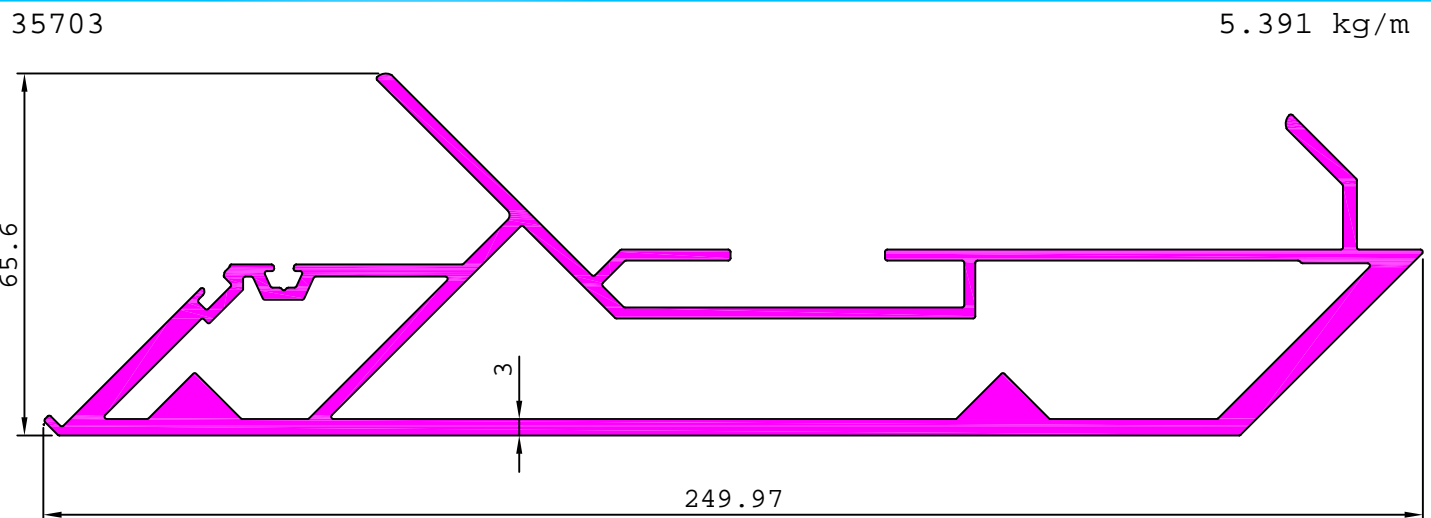
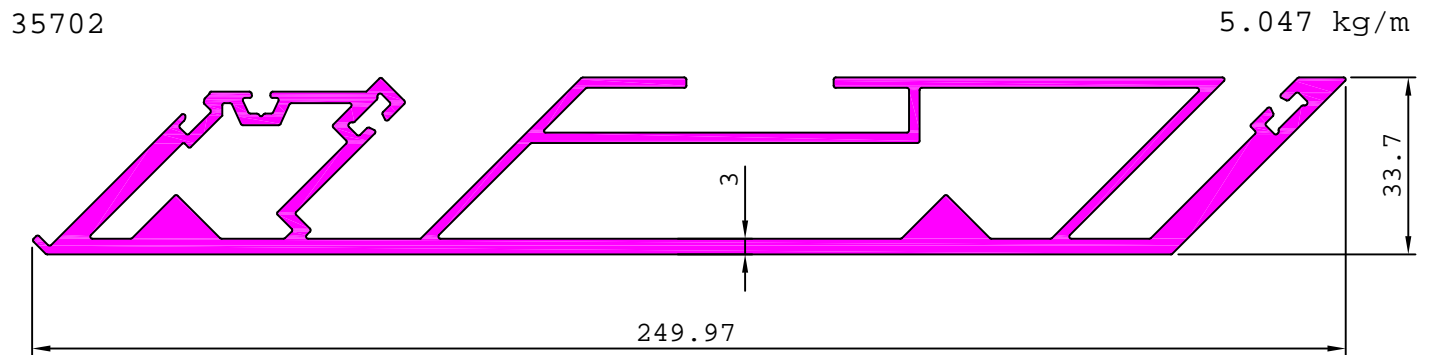
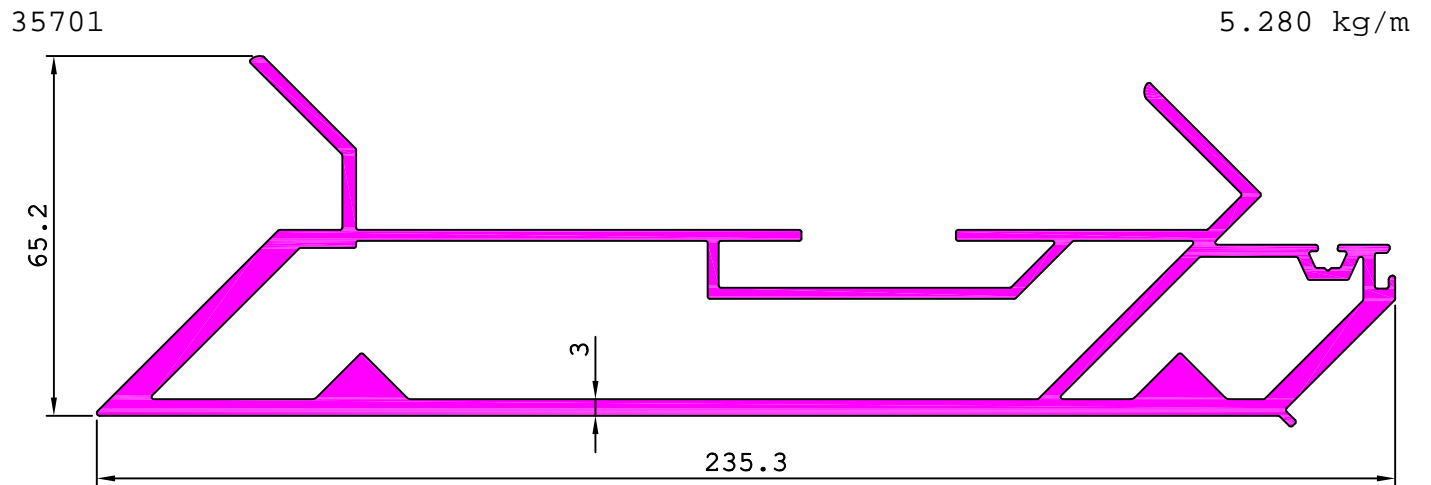
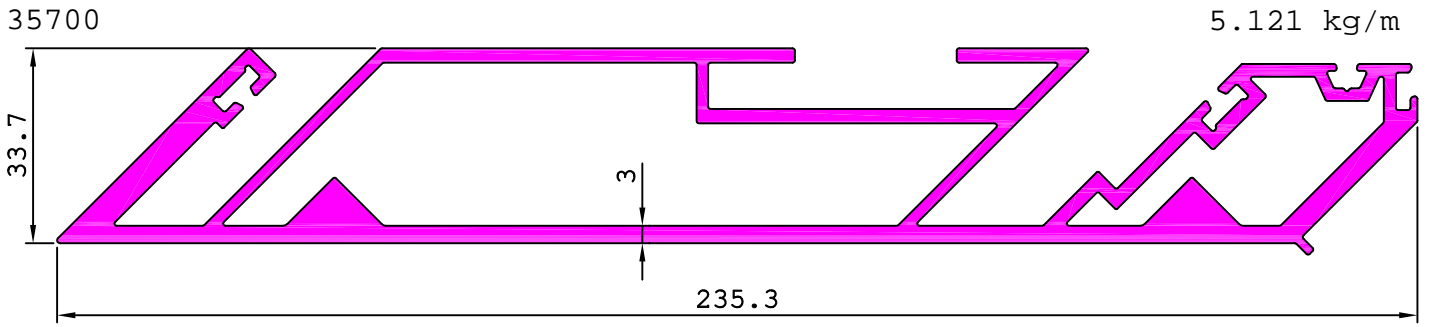

ARCHITECTURAL

CURTAIN WALL SECTION

35706

0.757 kg/m

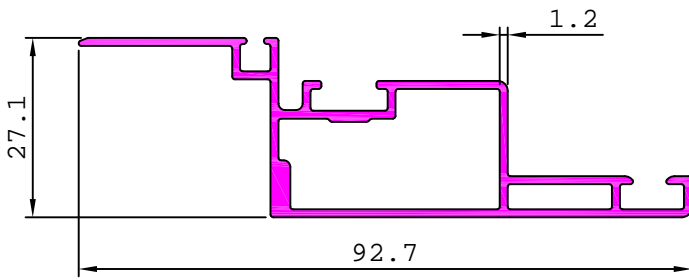

35714

1.736 kg/m

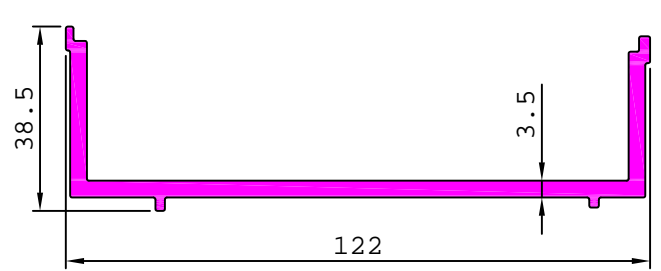

35707

2.862 kg/m

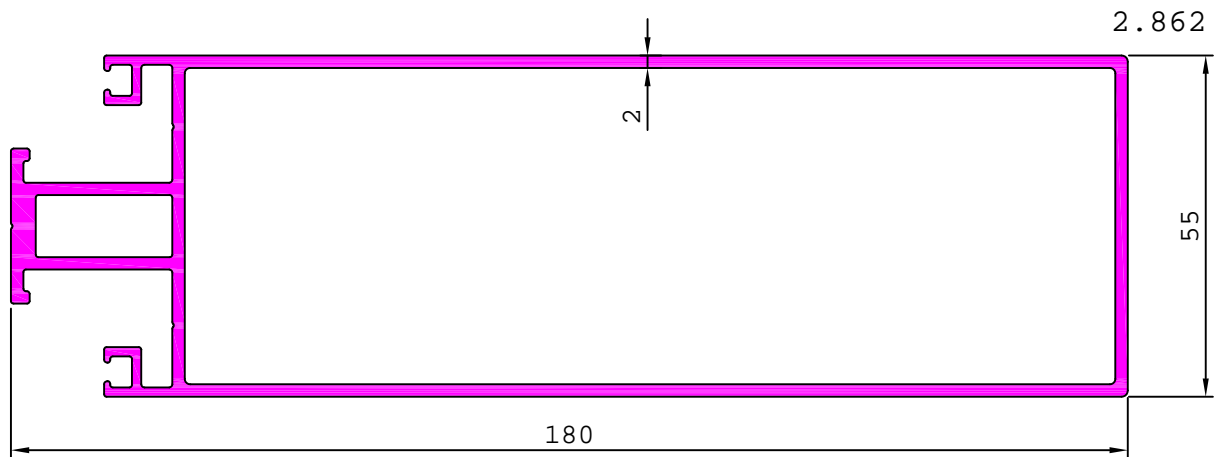

35709

2.876 kg/m

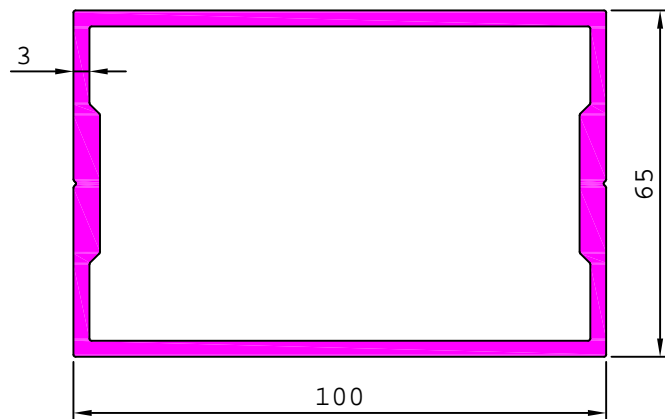

35719

0.792 kg/m

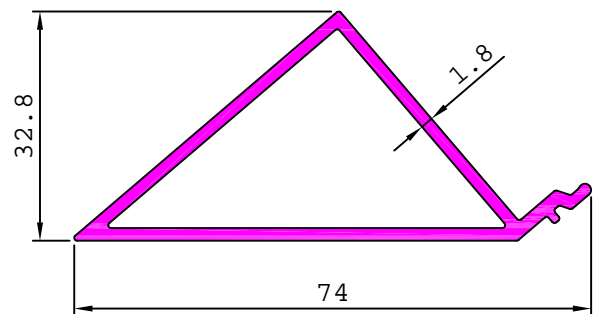

35717

4.972 kg/m

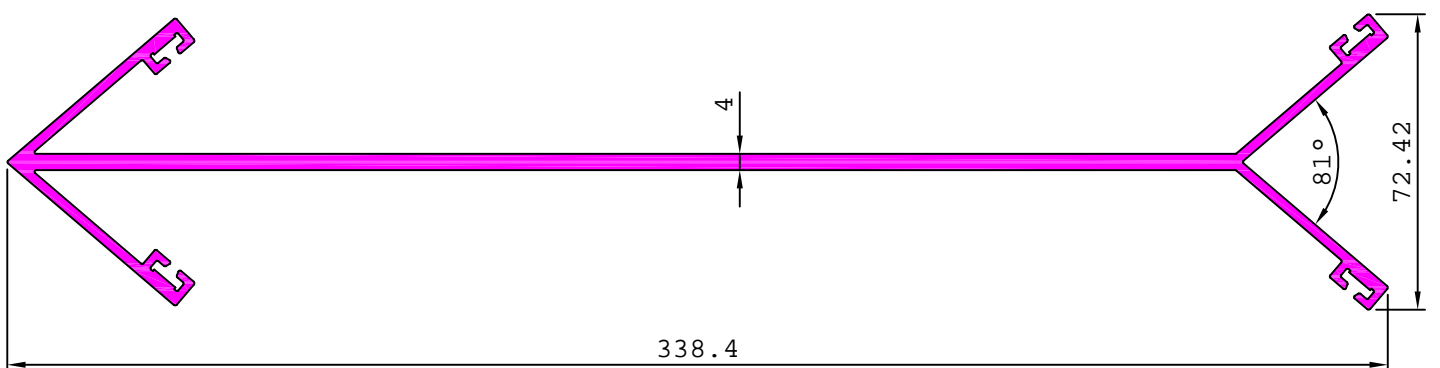

ARCHITECTURAL

CURTAIN WALL SECTION

35710 0.360 kg/m

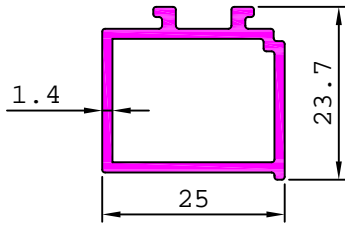

35711 0.330 kg/m

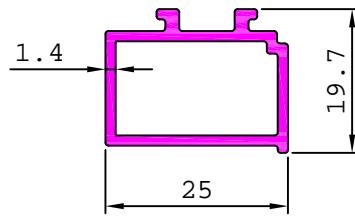

35712 0.475 kg/m

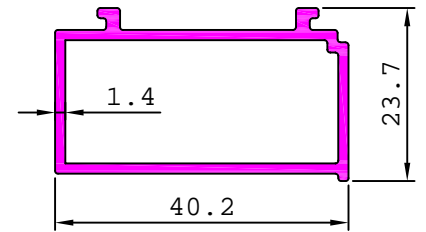

35713

3.072 kg/m

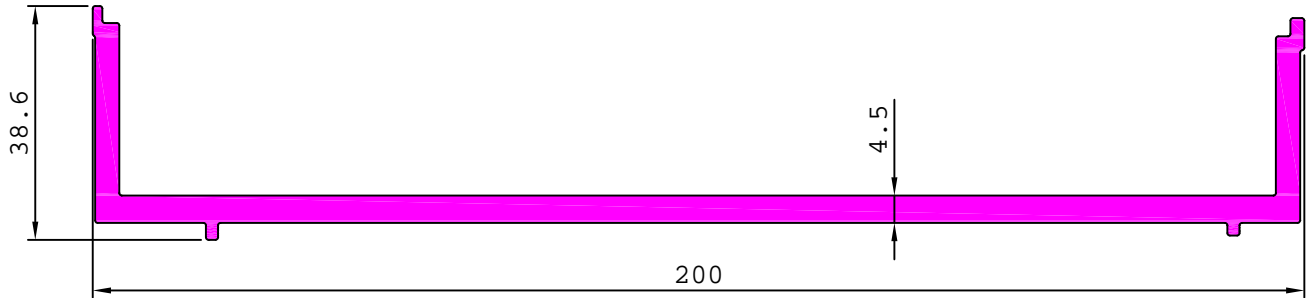

35715

4.375 kg/m

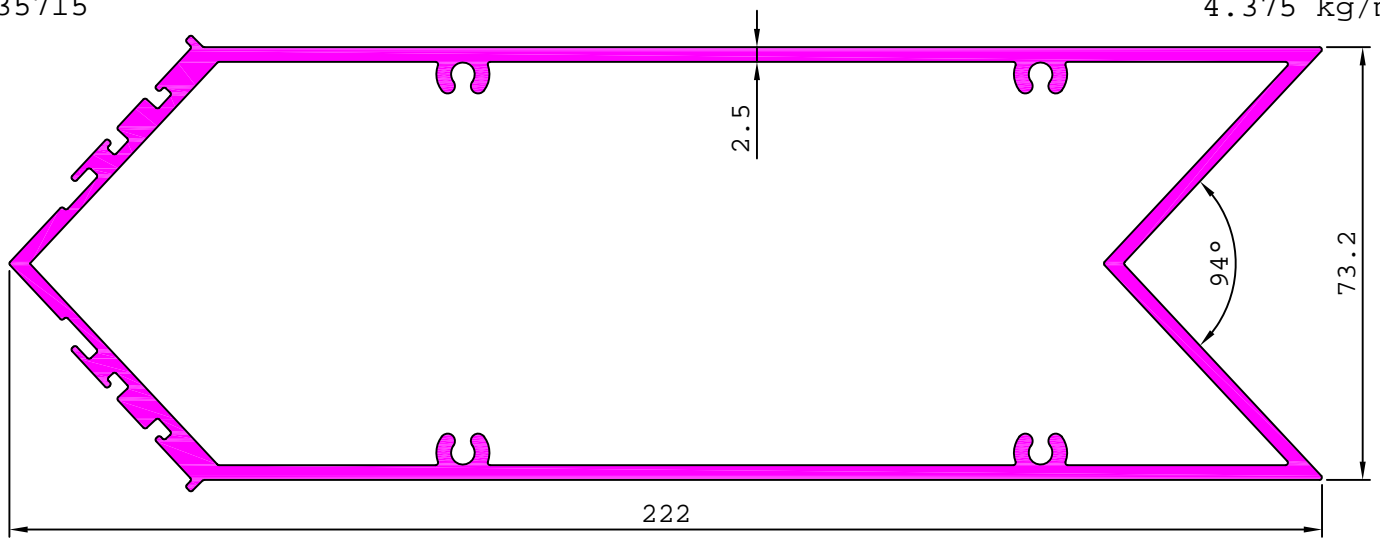

35720

5.033 kg/m

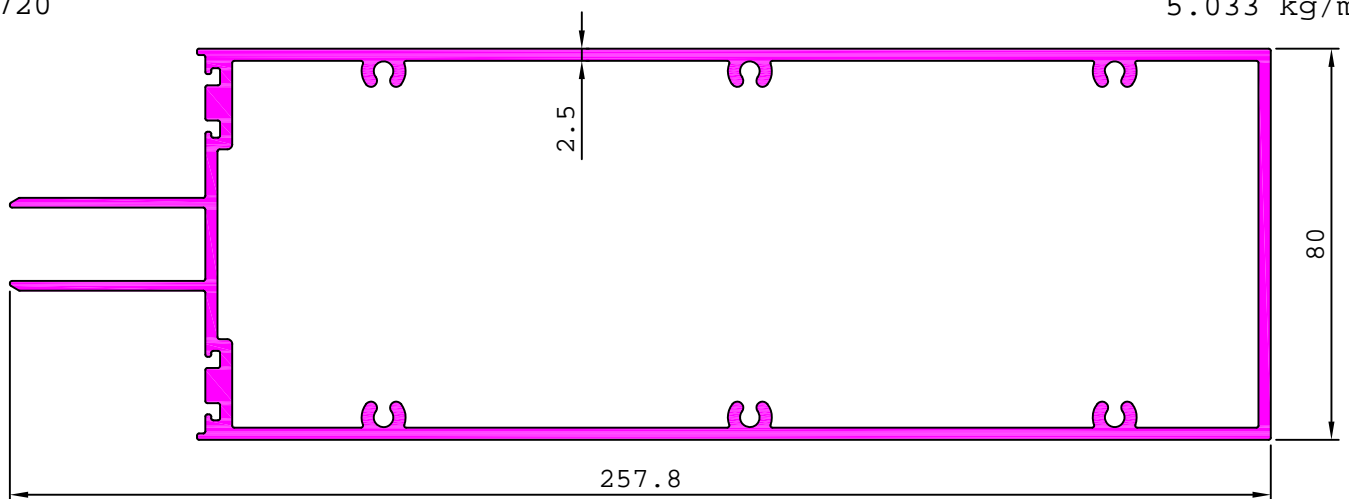

ARCHITECTURAL

CURTAIN WALL SECTION

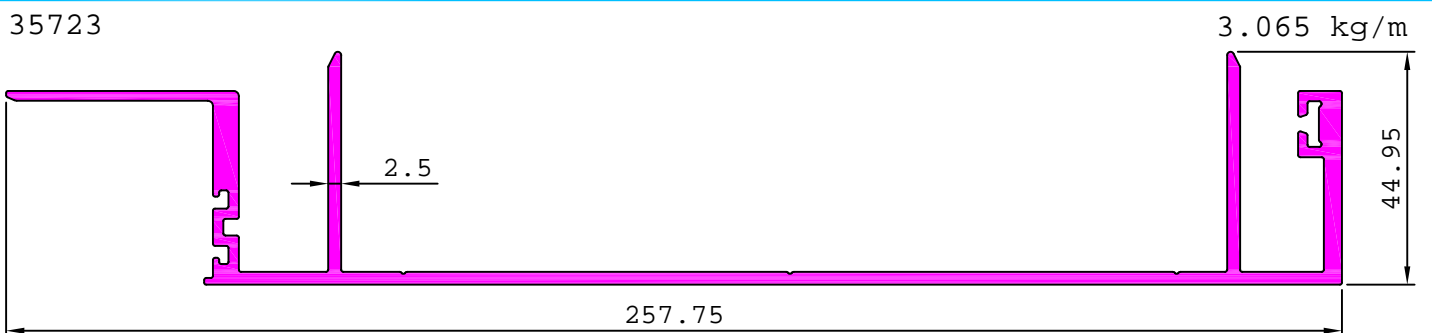
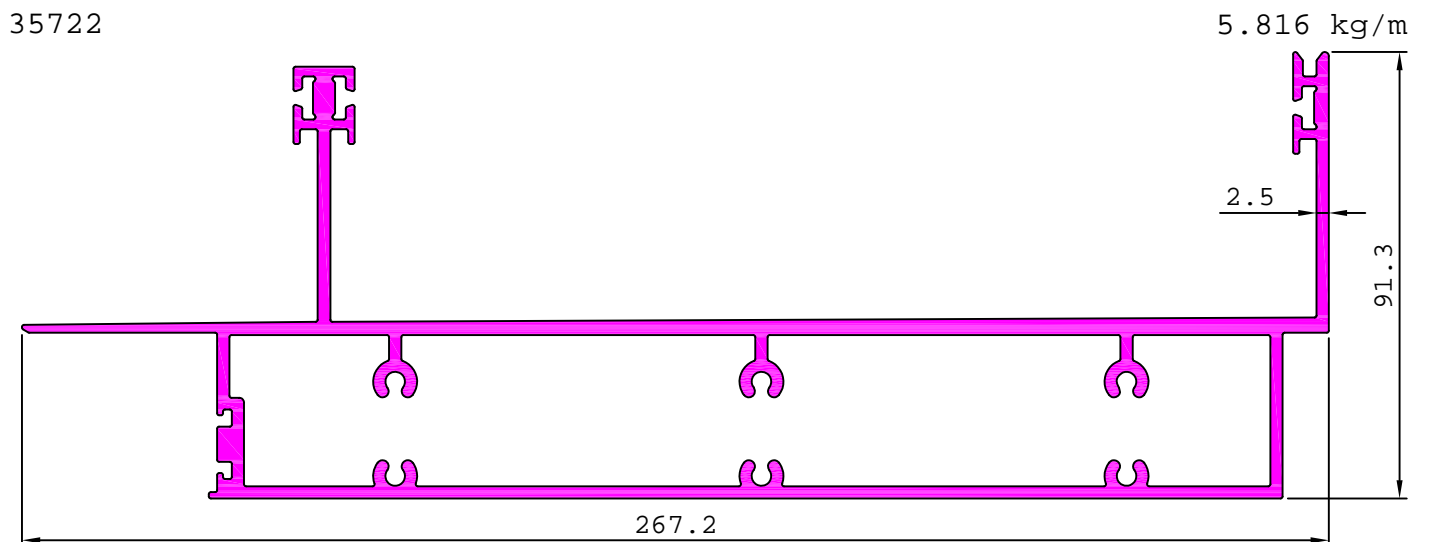
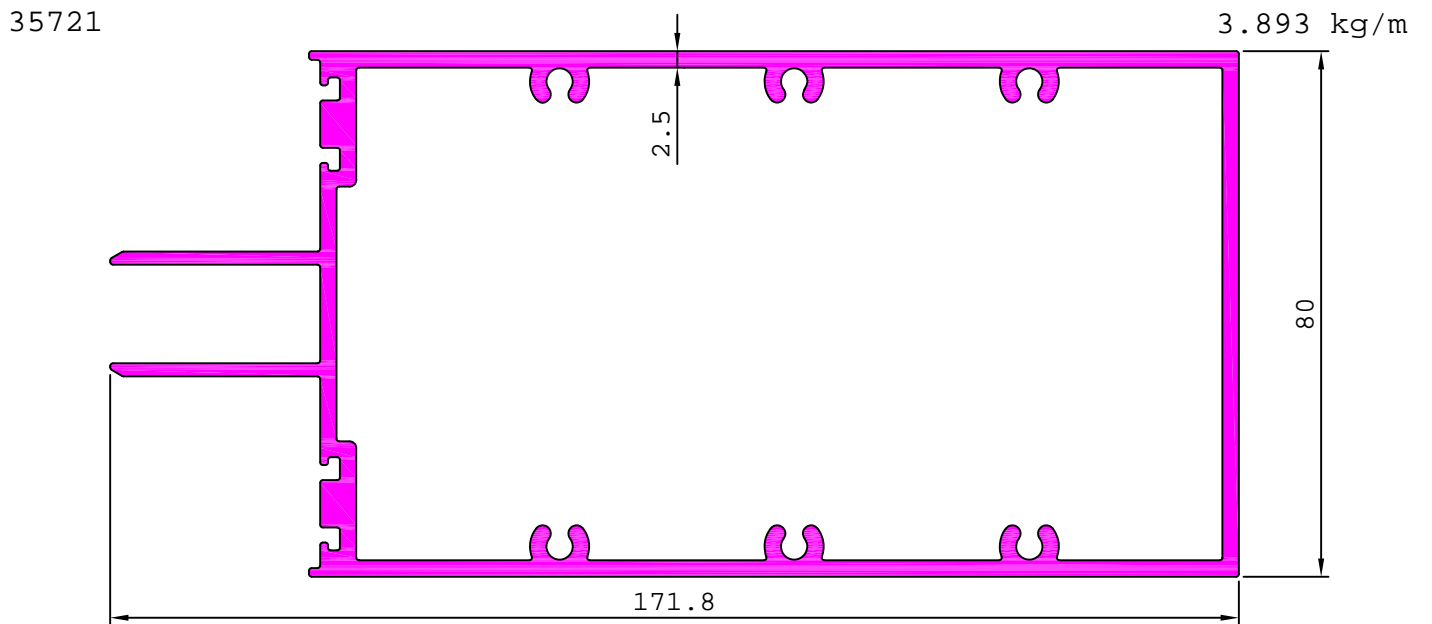
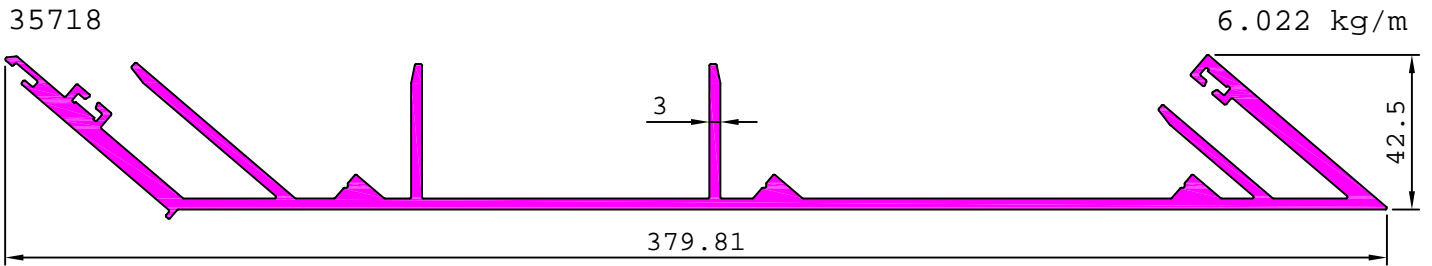

ARCHITECTURAL

CURTAIN WALL SECTION

35724

2.409 kg/m

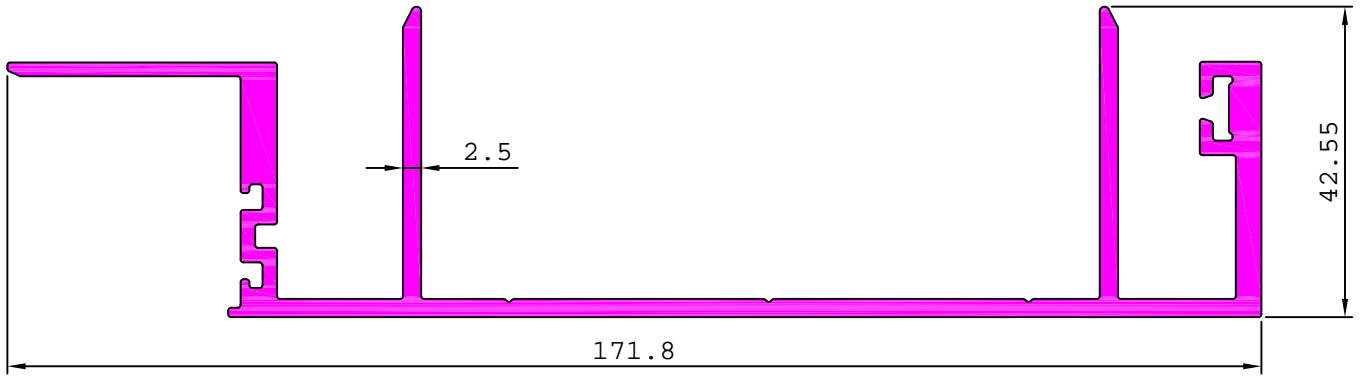

35726

4.923 kg/m

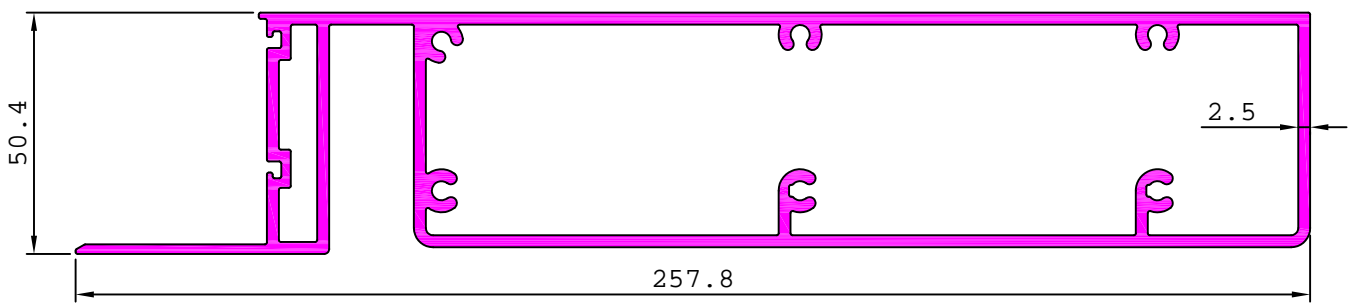

35725

4.370 kg/m

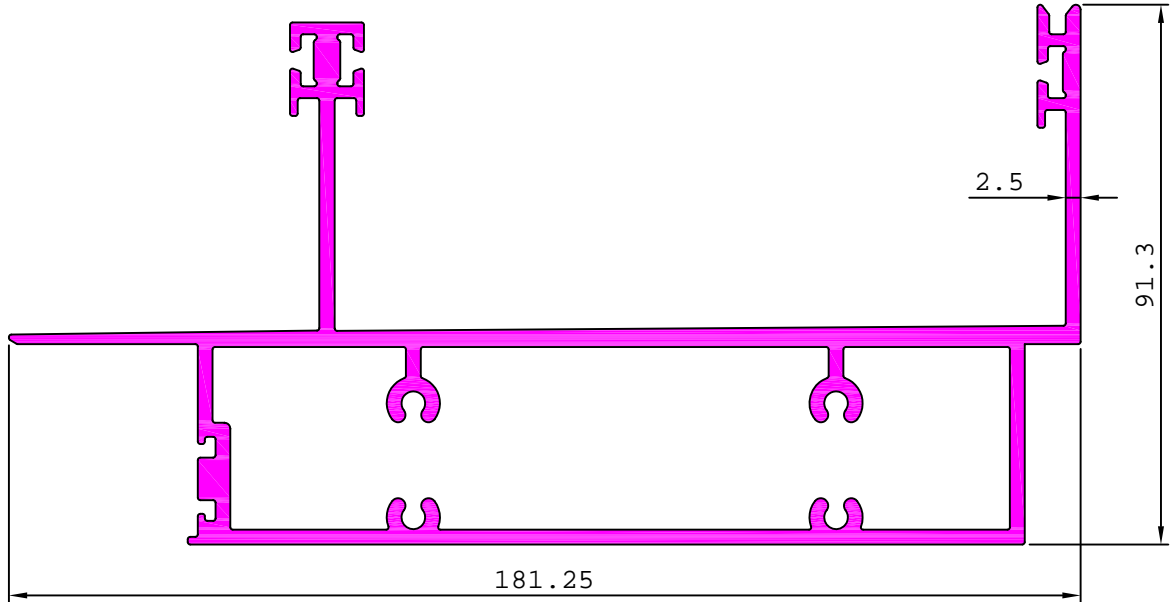

35716

0.564 kg/m

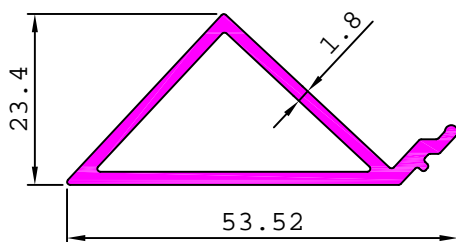

35730

0.445 kg/m

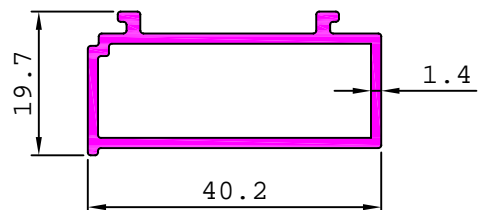

ARCHITECTURAL

CURTAIN WALL SECTION

35727

3.600 kg/m

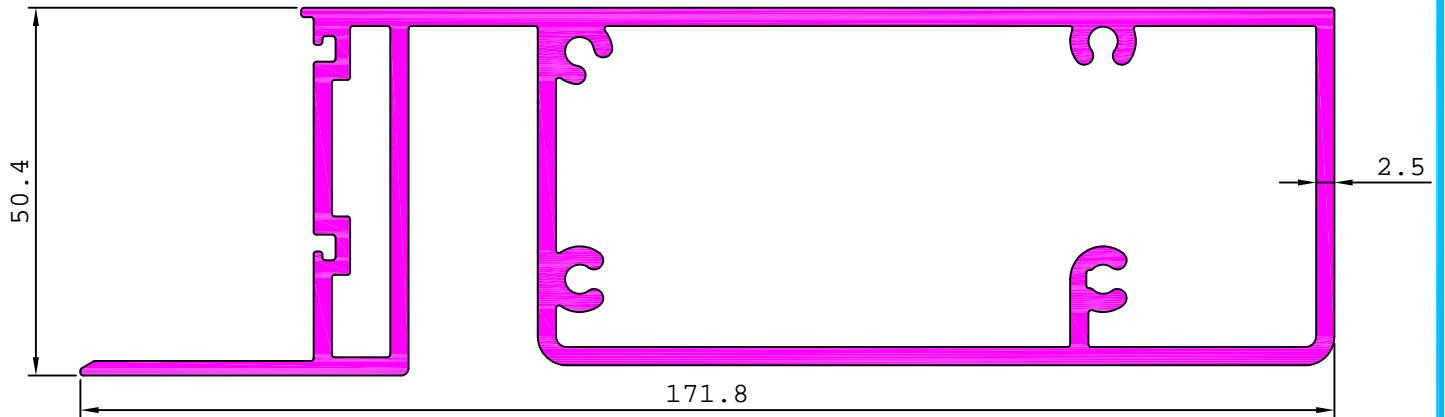

35728

3.385 kg/m

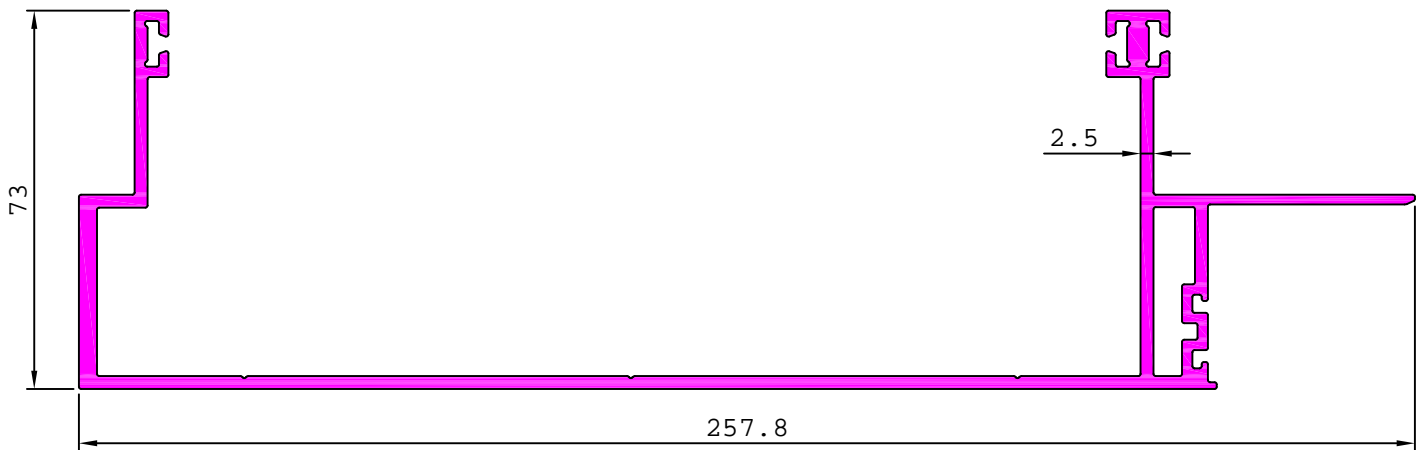

35732

3.945 kg/m

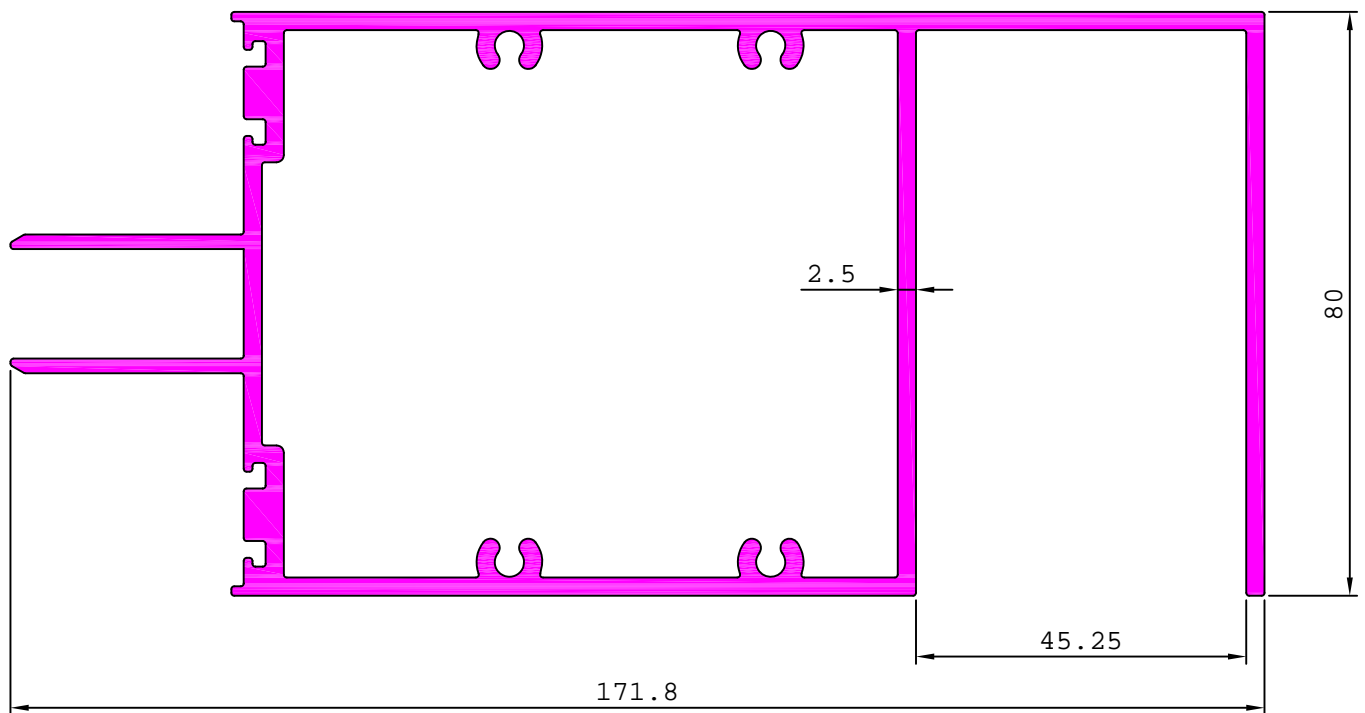

ARCHITECTURAL

CURTAIN WALL SECTION

35731

1.025 kg/m

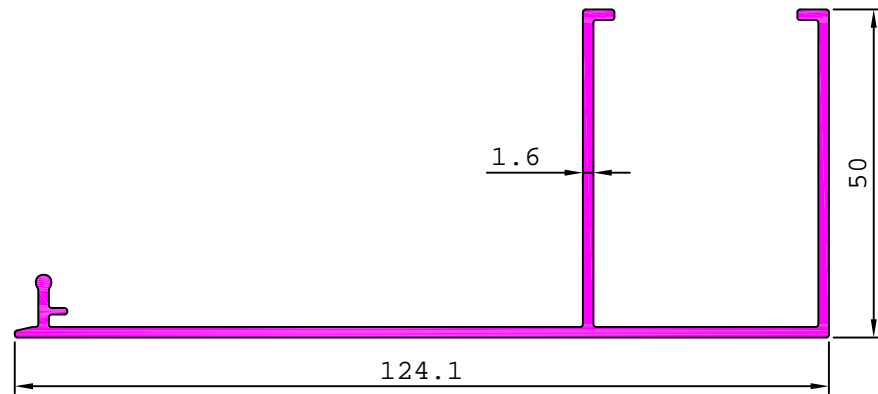

35736

0.732 kg/m

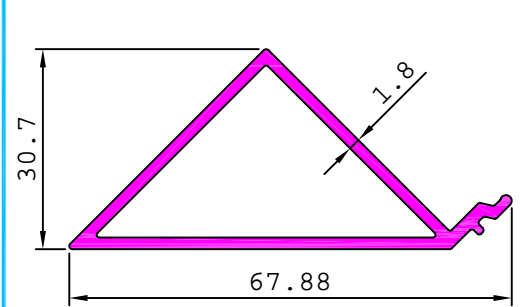

35729

2.760 kg/m

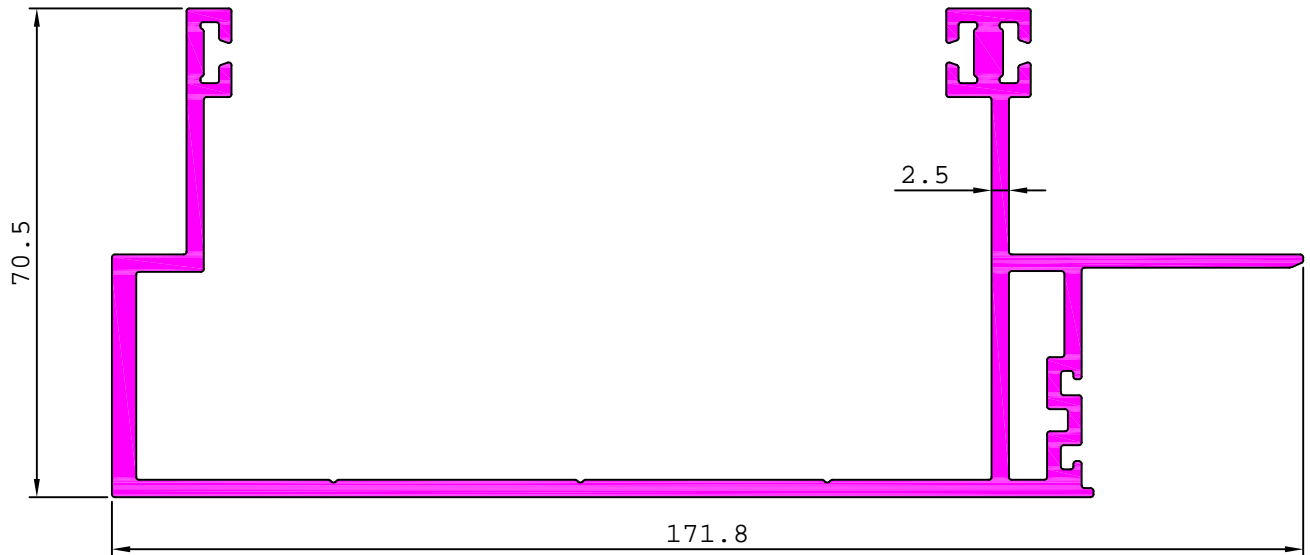

35738

5.501 kg/m

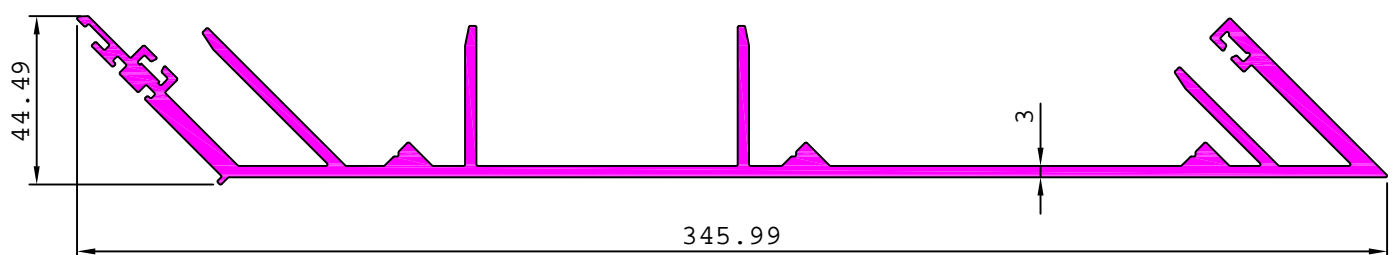

35739

5.046 kg/m

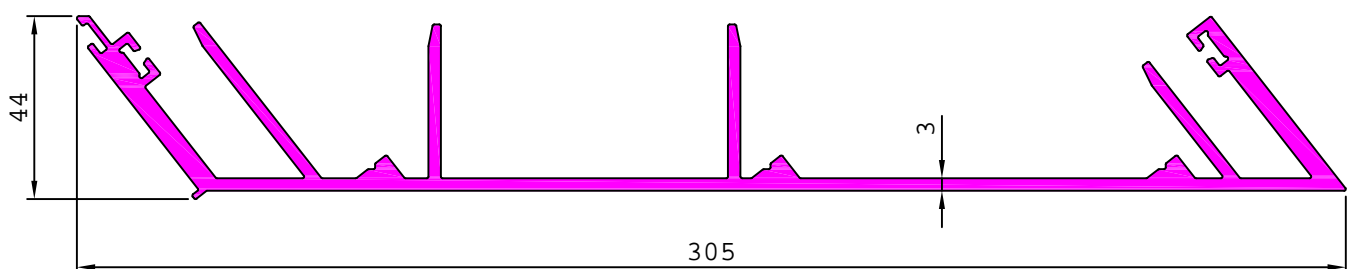

ARCHITECTURAL

CURTAIN WALL SECTION

35733

4.234 kg/m

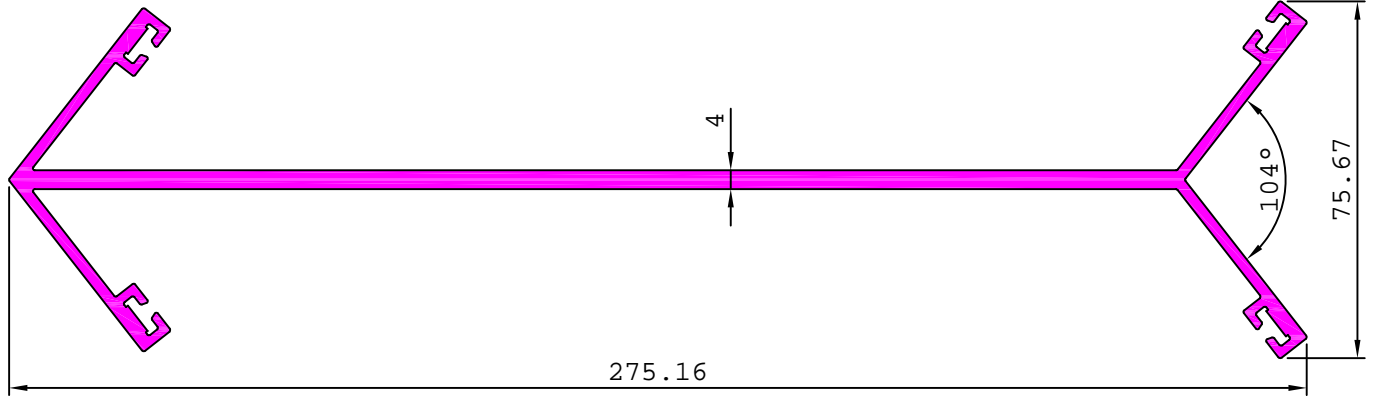

35734

3.332 kg/m

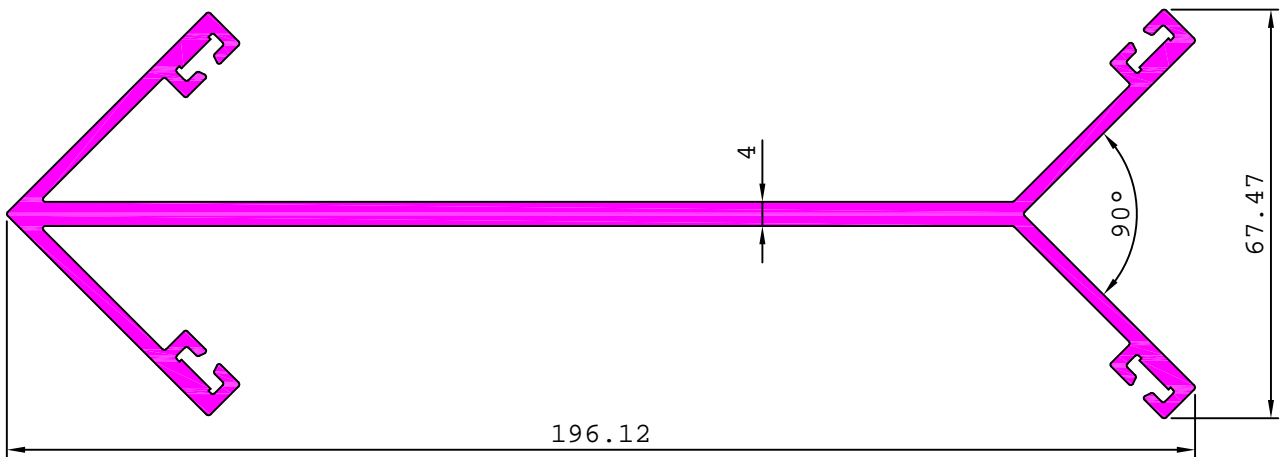

35735

4.659 kg/m

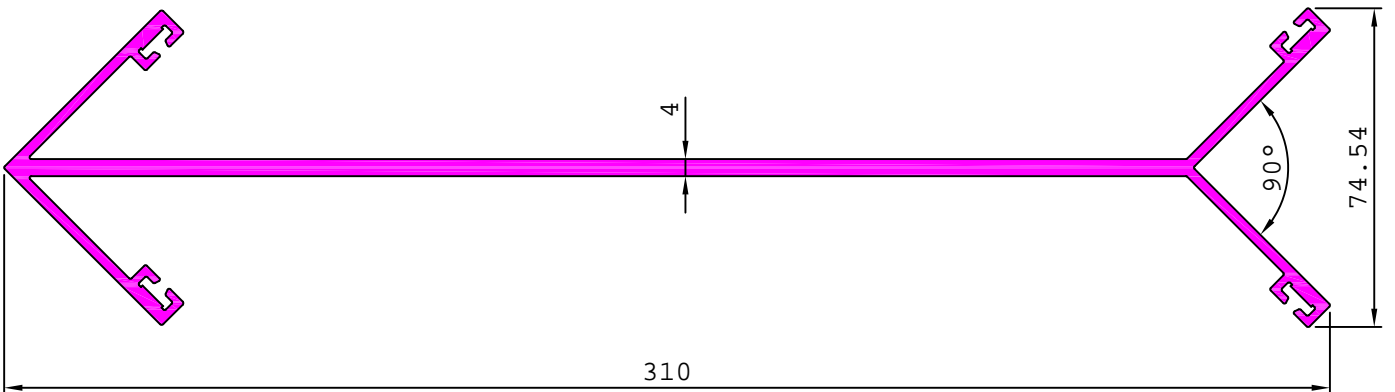

35737

4.252 kg/m

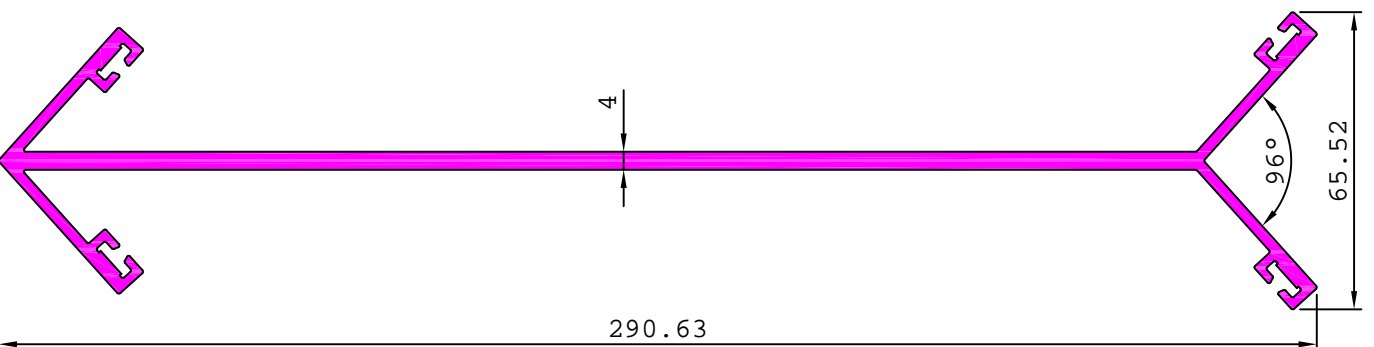

ARCHITECTURAL

CURTAIN WALL SECTION

35741 0.648 kg/m

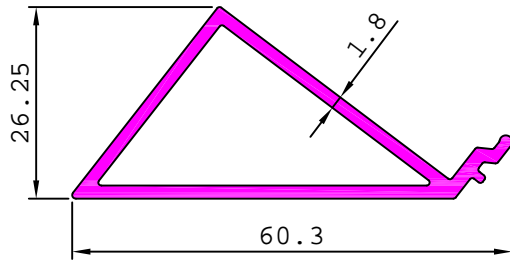

35740 0.599 kg/m

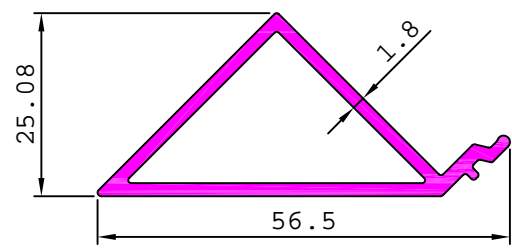

35744 0.441 kg/m

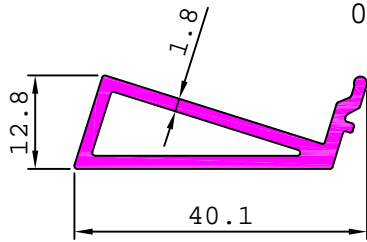

35745 0.416 kg/m

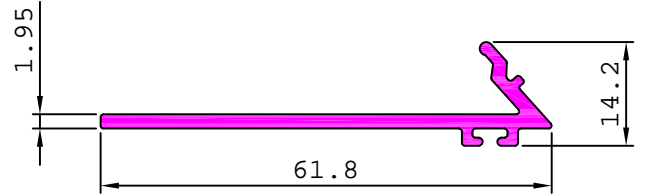

35746 5.424 kg/m

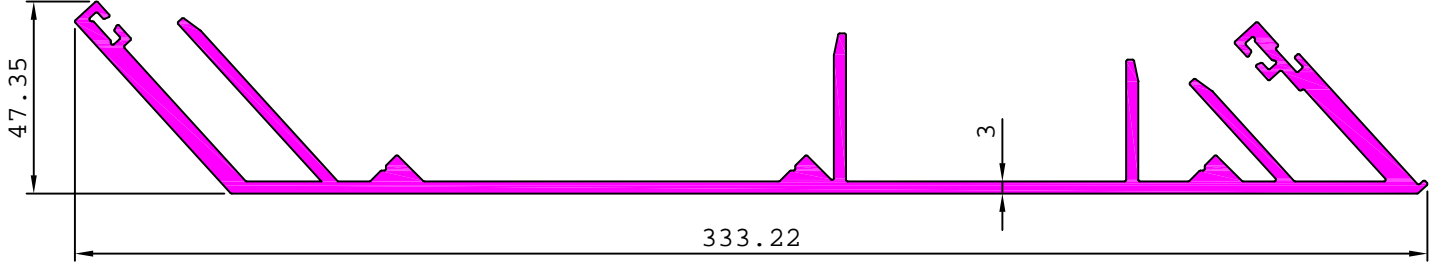

35742 4.355 kg/m

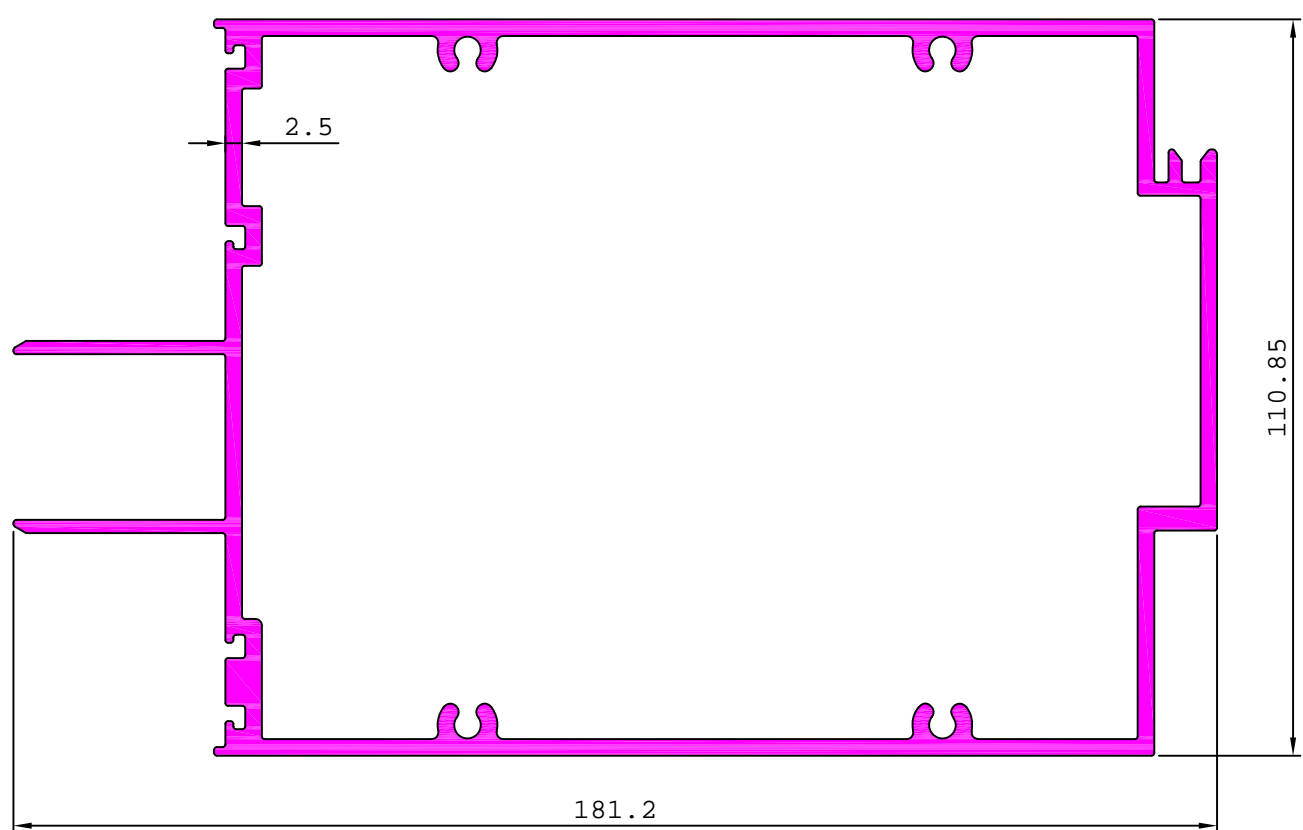

ARCHITECTURAL

CURTAIN WALL SECTION

35743

3.839 kg/m

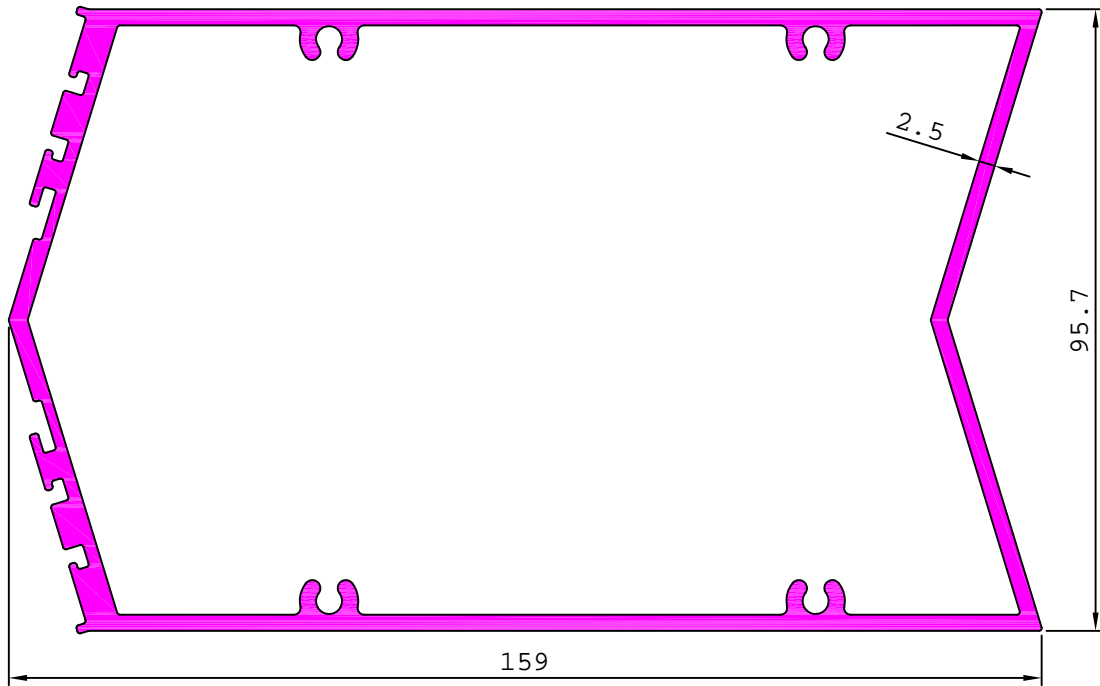

35747

3.157 kg/m

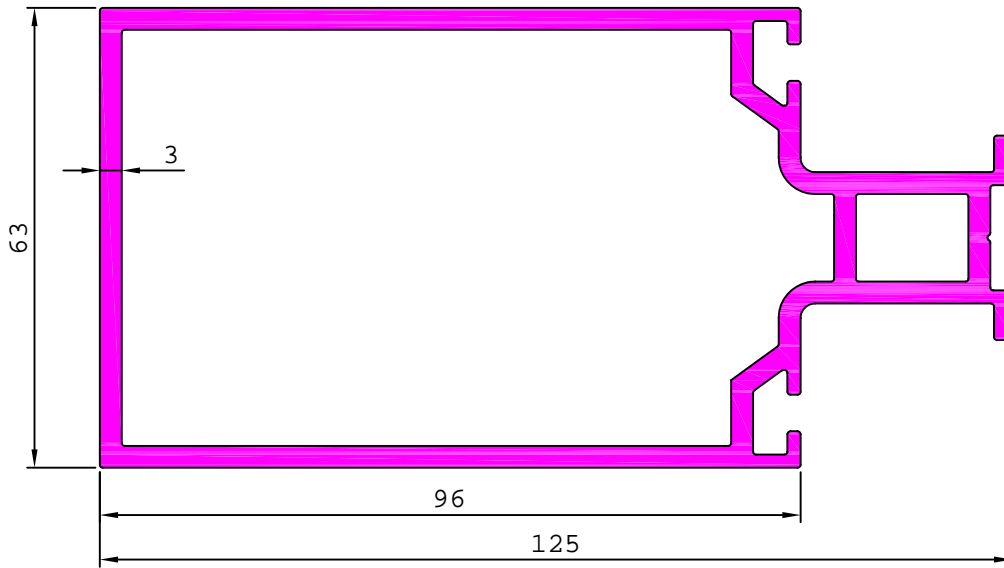

35751

3.537 kg/m

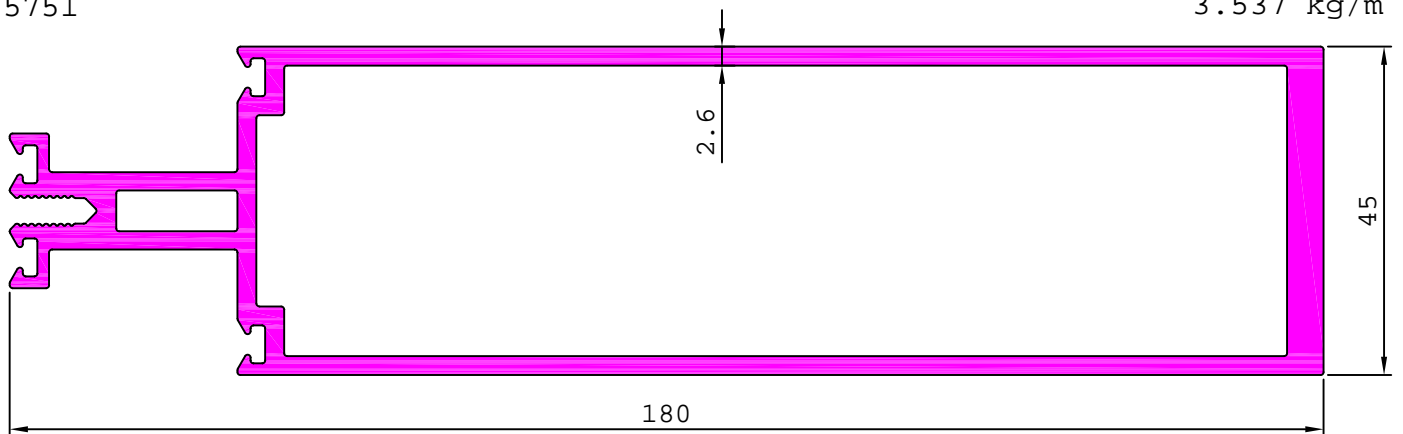

ARCHITECTURAL

CURTAIN WALL SECTION

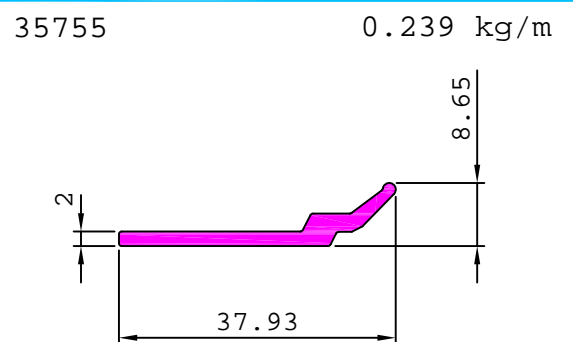
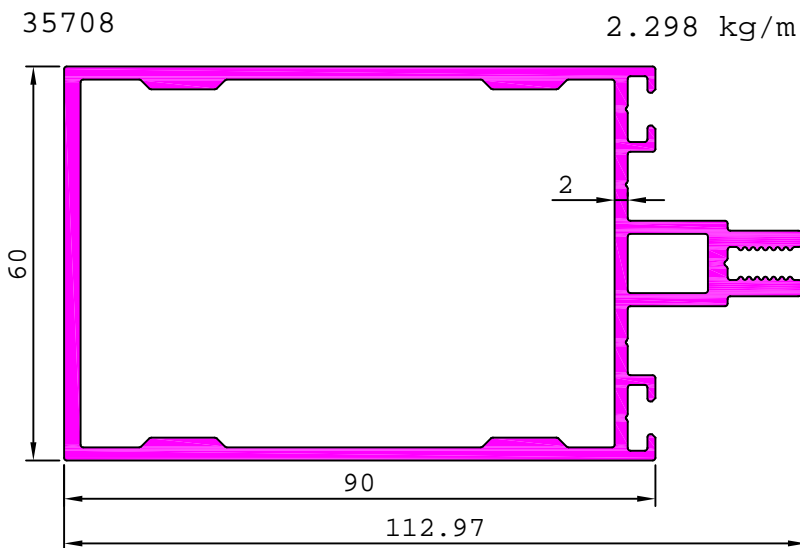
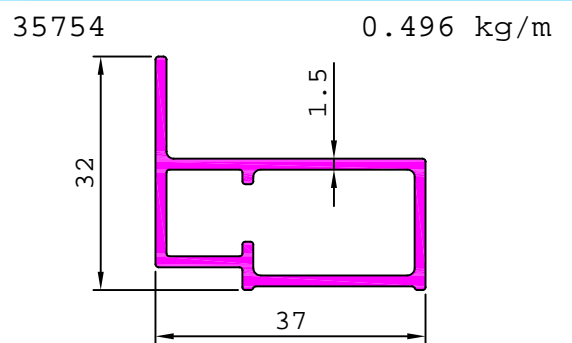
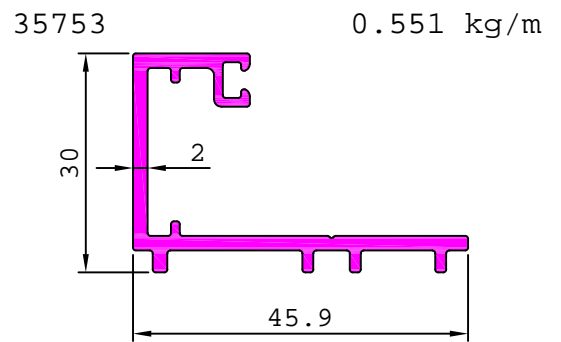
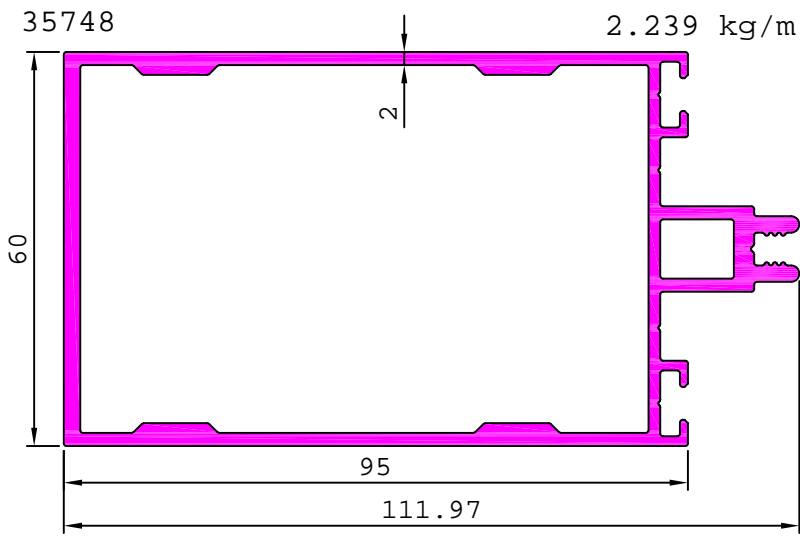
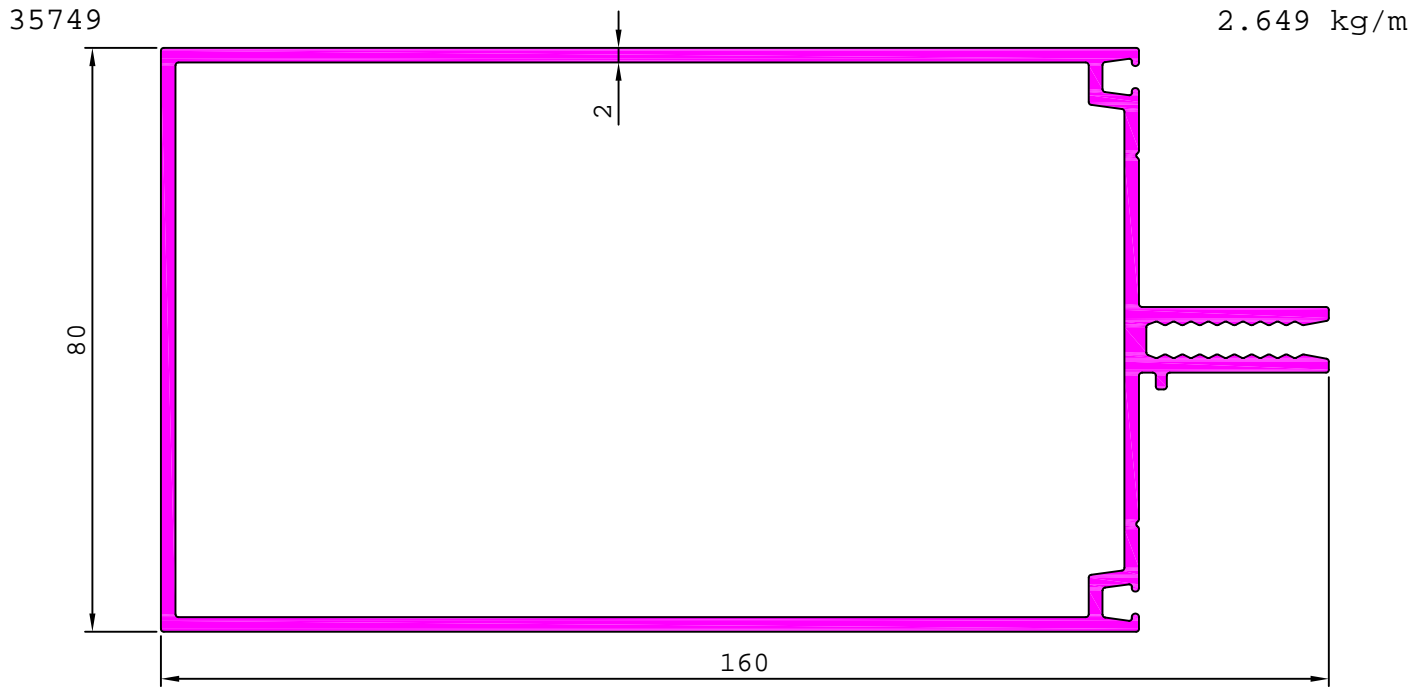

ARCHITECTURAL

CURTAIN WALL SECTION

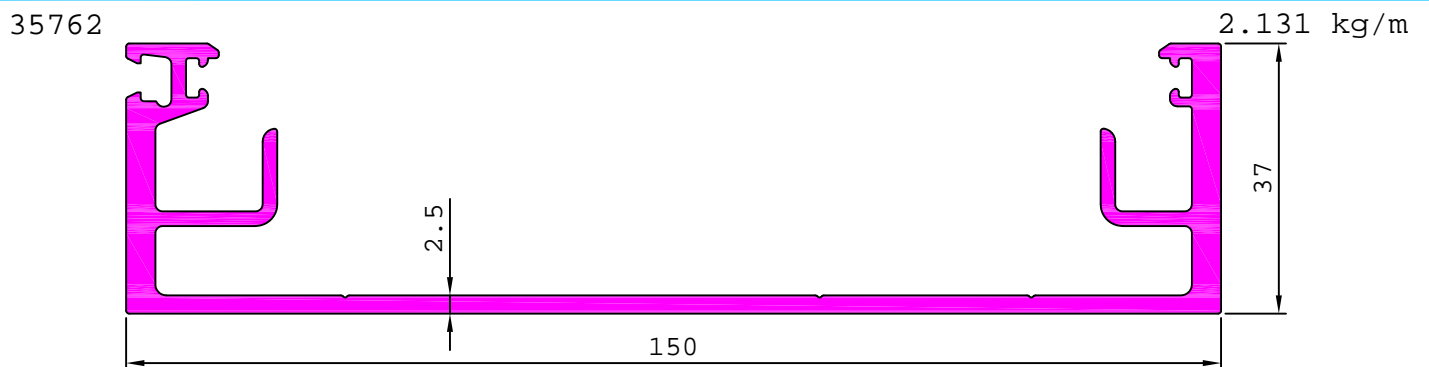
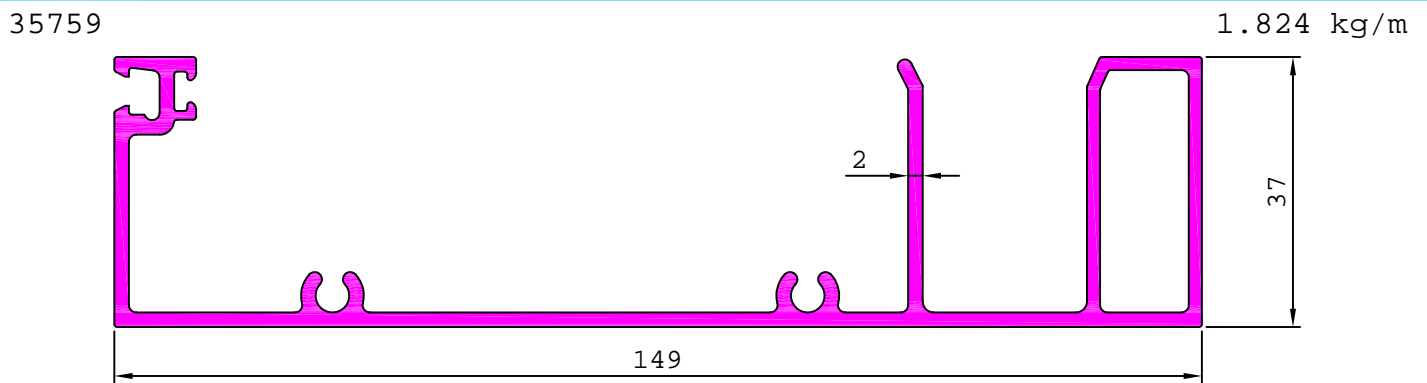
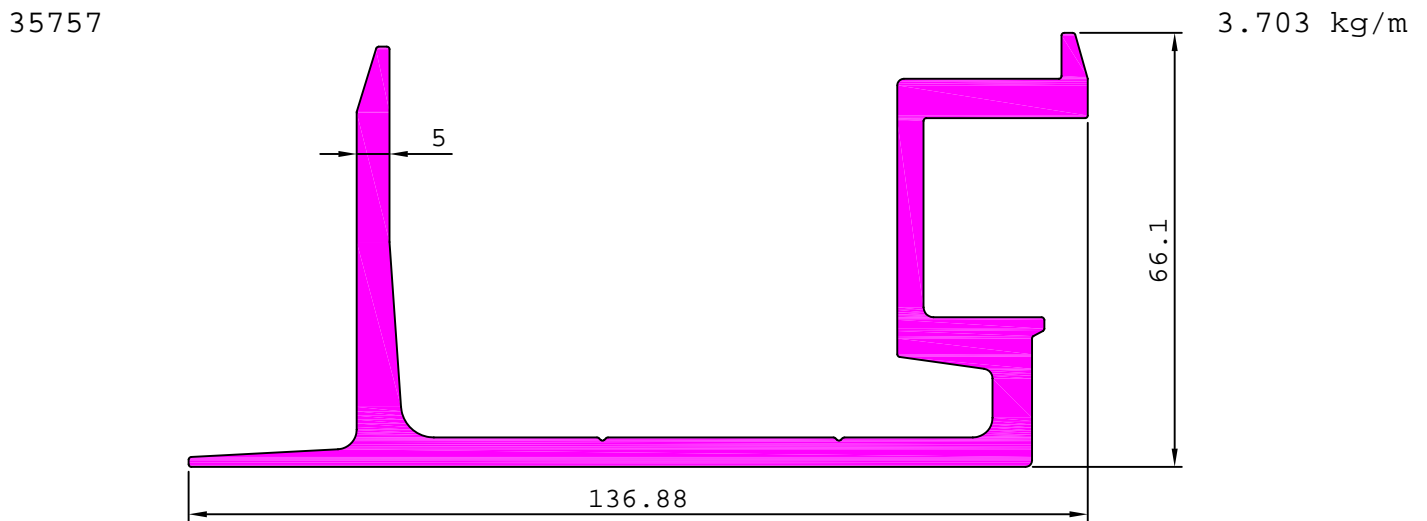
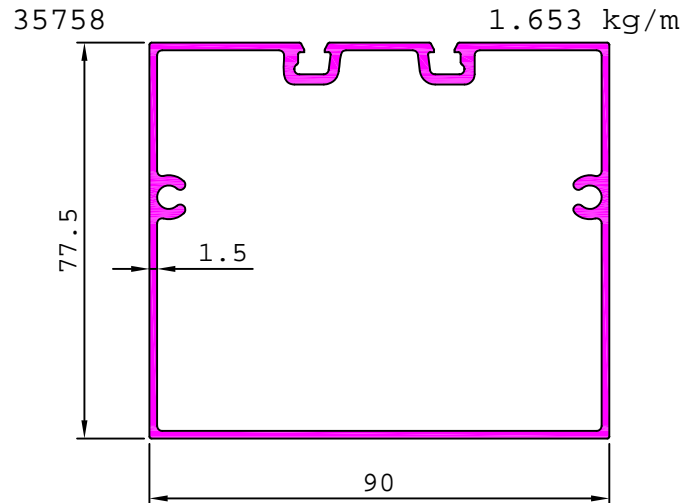
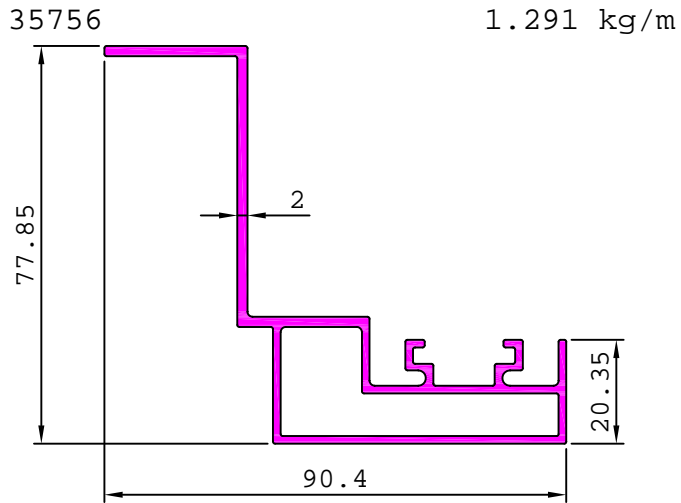

ARCHITECTURAL

CURTAIN WALL SECTION

35760 2.128 kg/m

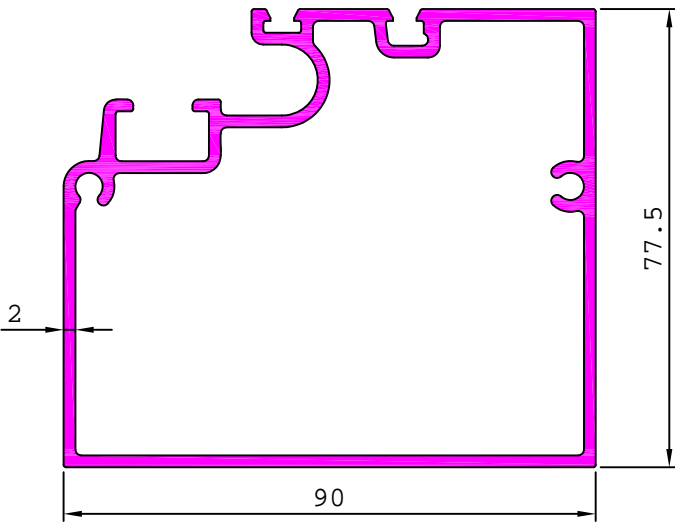

35766 1.042 kg/m

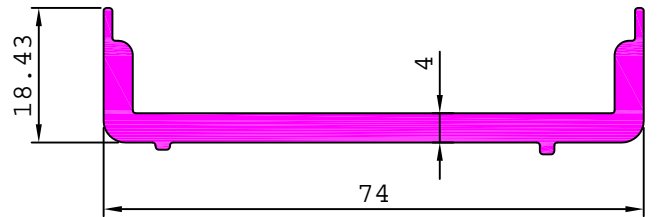

35767 0.802 kg/m

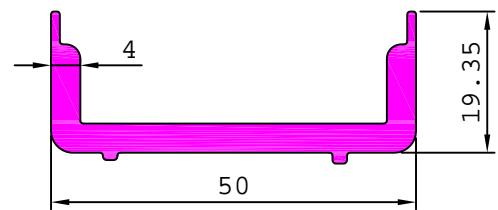

35761 2.411 kg/m

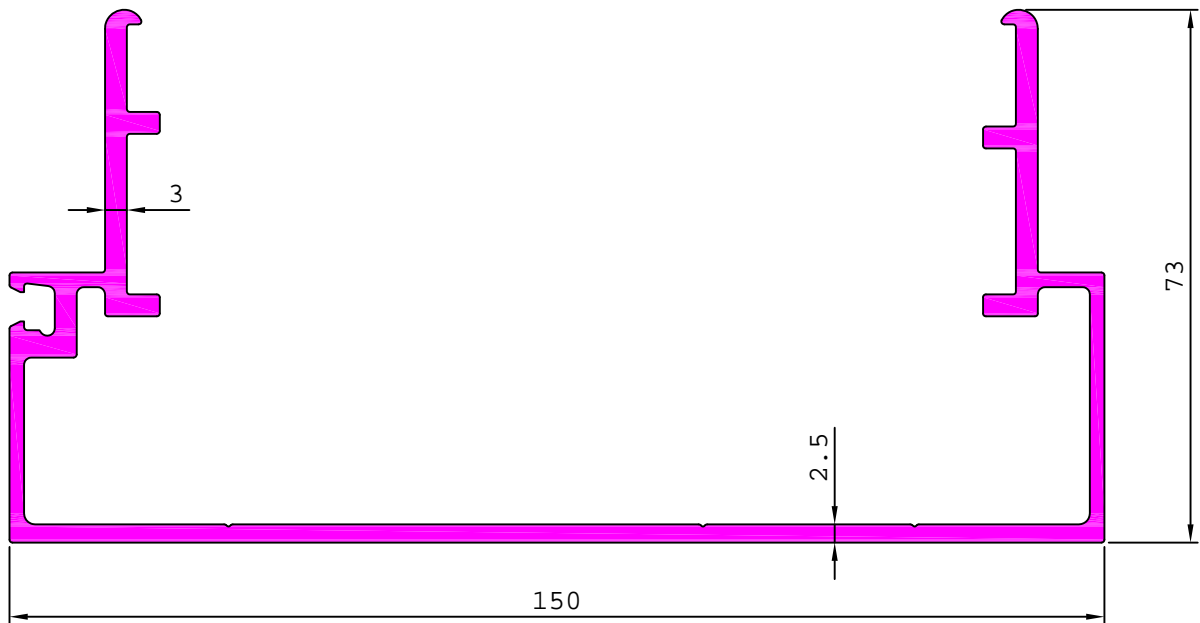

35764 3.054 kg/m

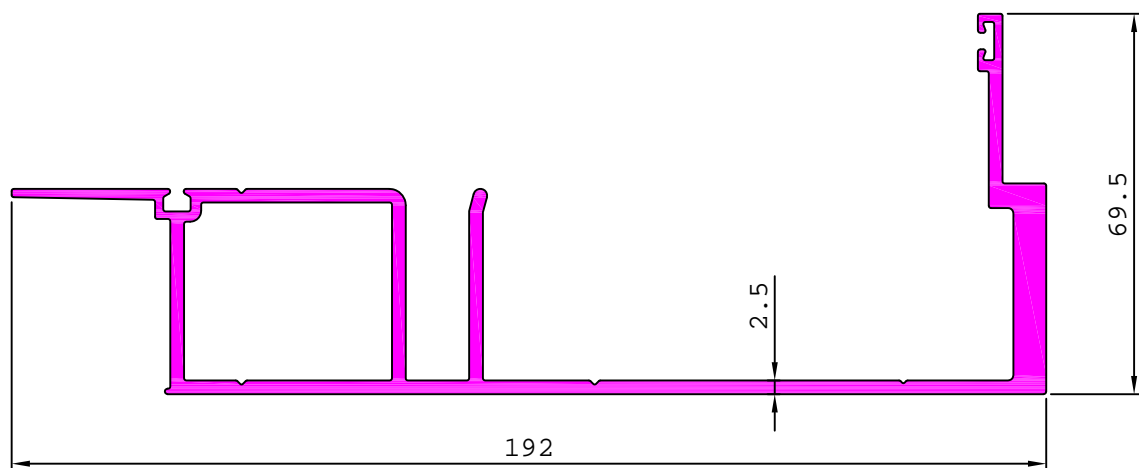

ARCHITECTURAL

CURTAIN WALL SECTION

35763

2.427 kg/m

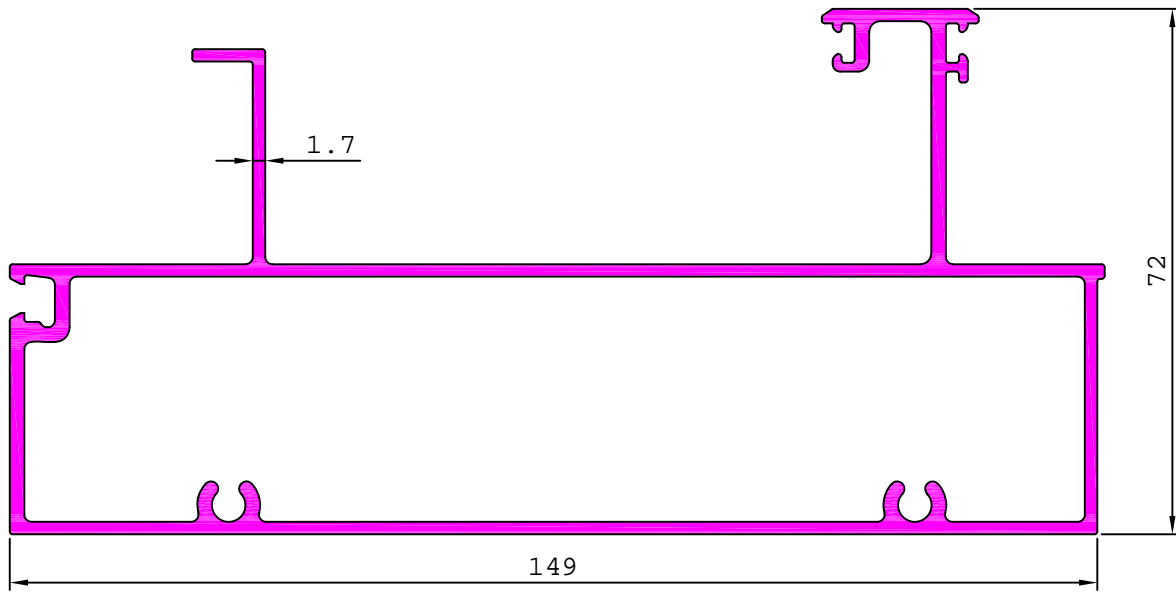

35765

4.118 kg/m

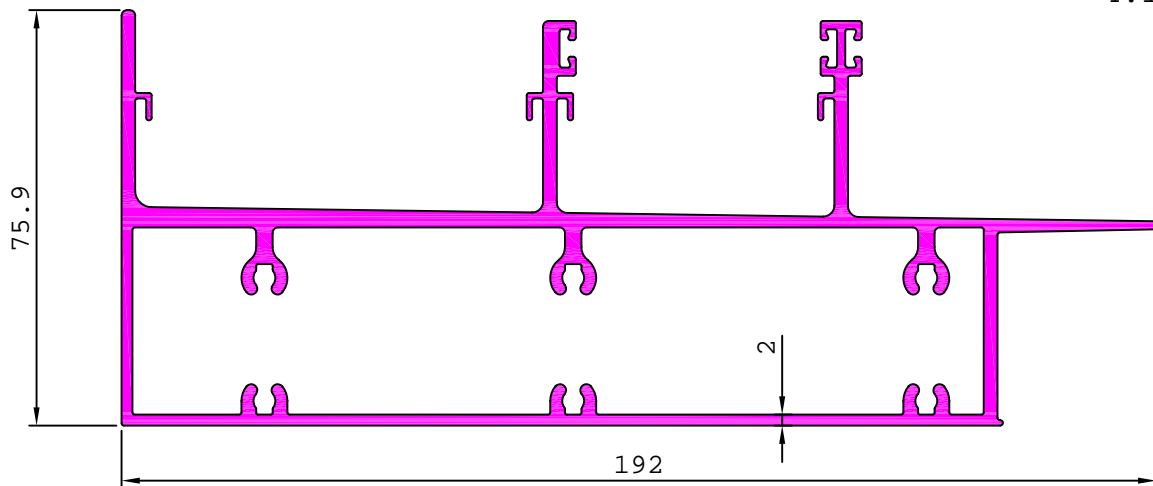

35770

3.659 kg/m

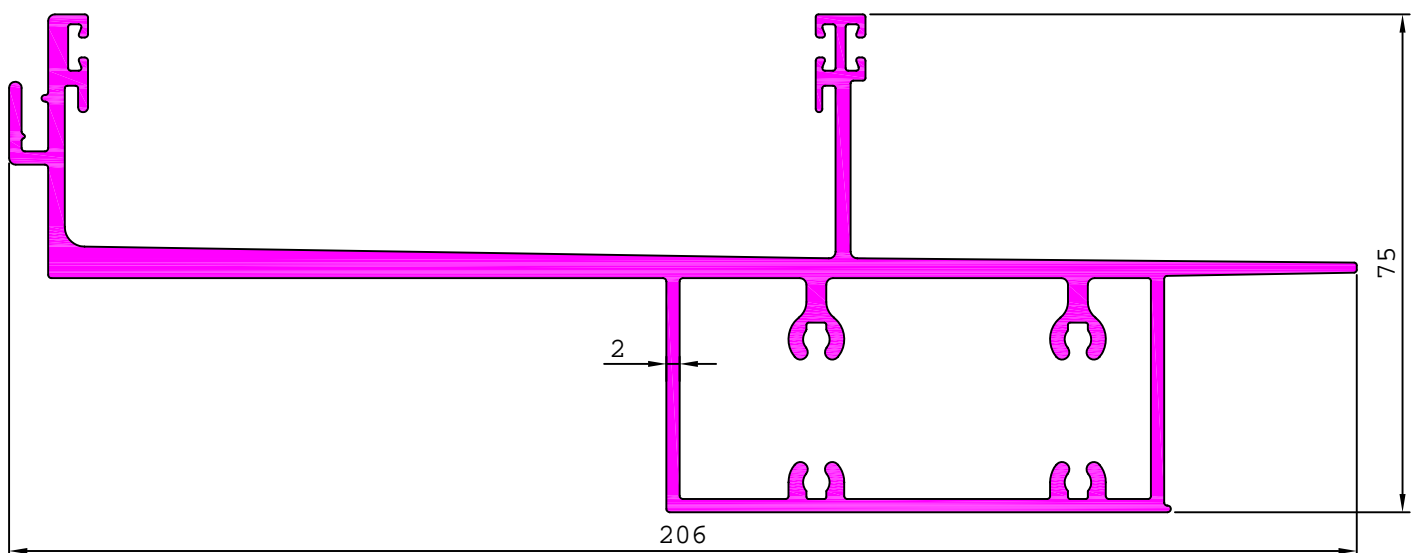

MATCHING SECTION No. 35770

ARCHITECTURAL

CURTAIN WALL SECTION

35768

3.270 kg/m

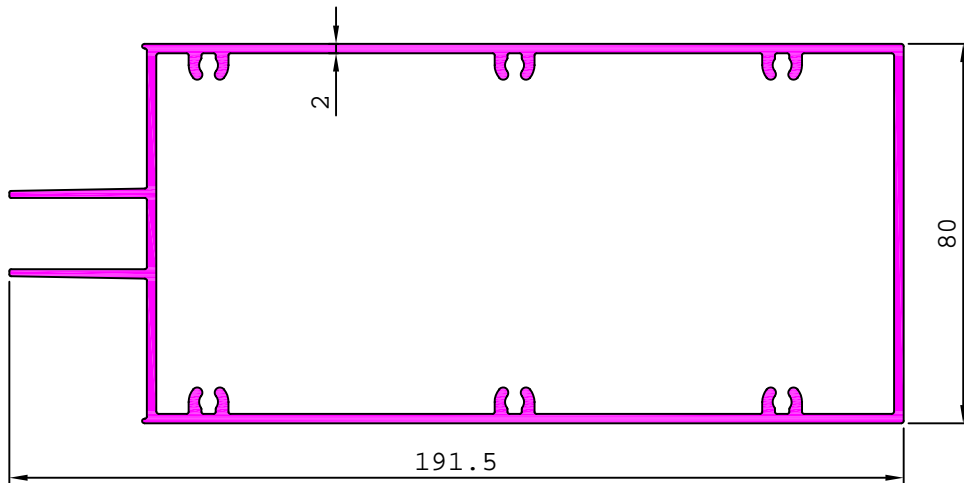

35769

3.035 kg/m

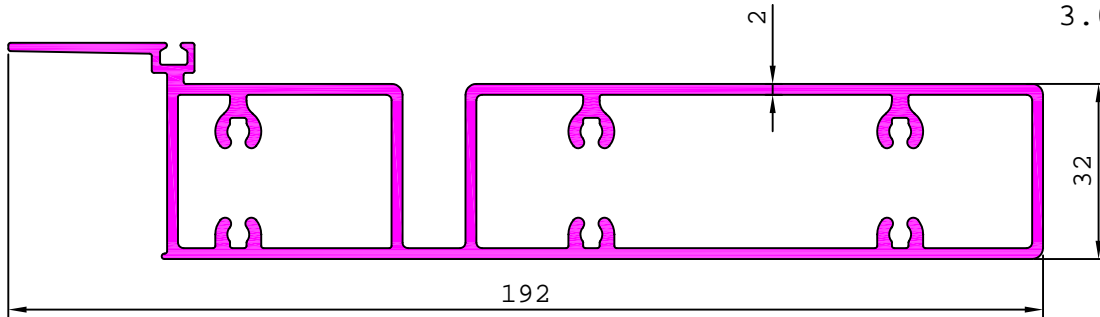

35771

1.840 kg/m

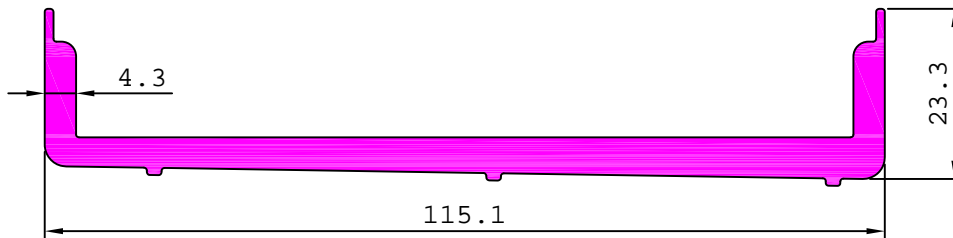

MATCHING SECTION No. 35770

35772

1.970 kg/m

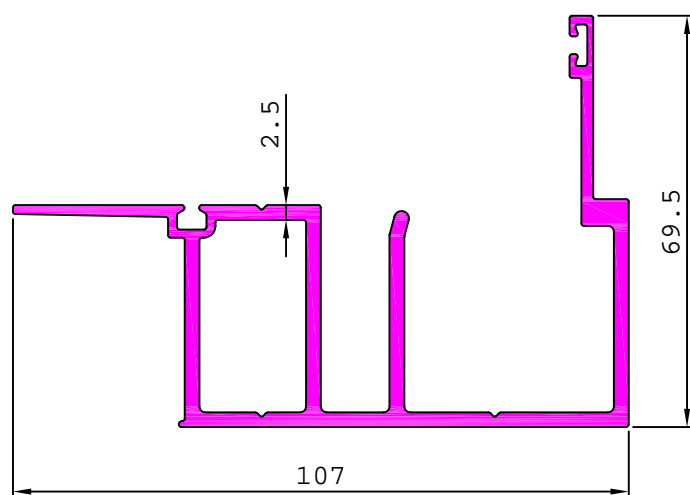

35773

2.071 kg/m

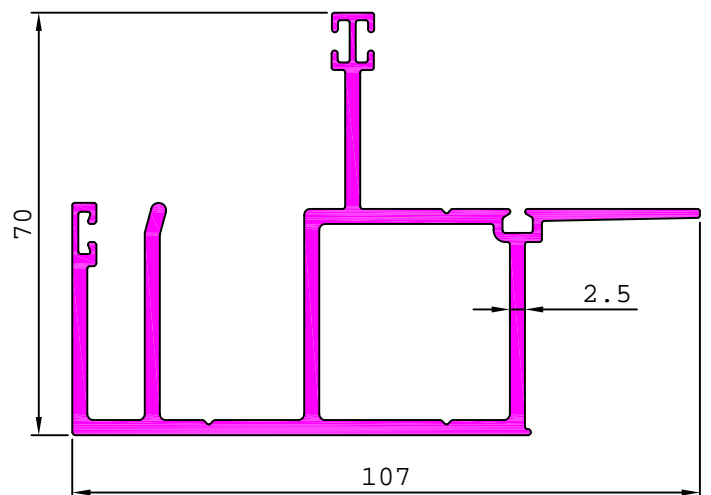

ARCHITECTURAL

CURTAIN WALL SECTION

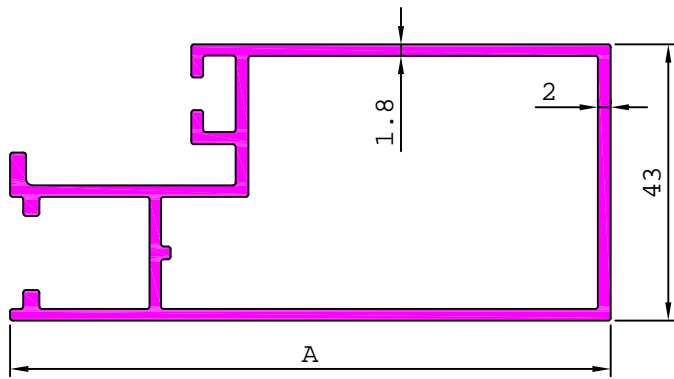
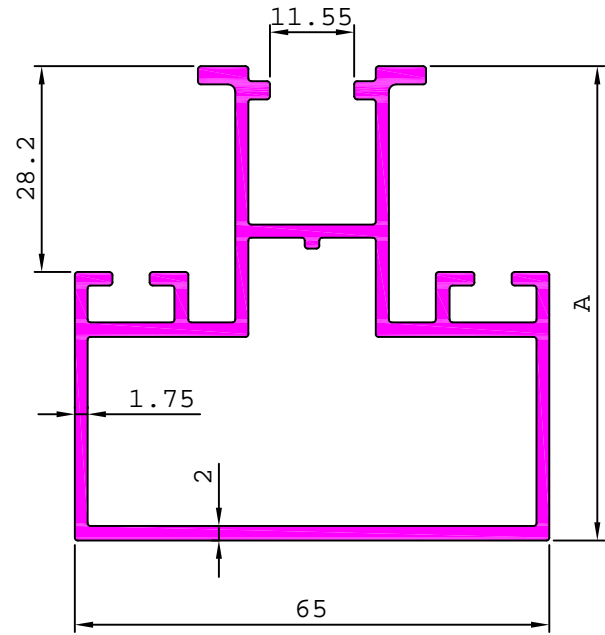
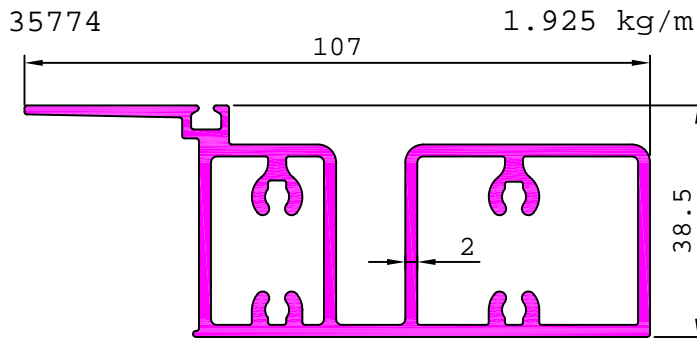

SL. No.	Section No.	A	Weight kg/m
1	35779	93.50	1.510
2	35846	120.00	1.767

SL. No.	Section No.	A	Weight kg/m
1	35778	65.00	1.600
2	35845	93.50	1.870
3	35844	120.00	2.120
4	35777	150.00	2.403

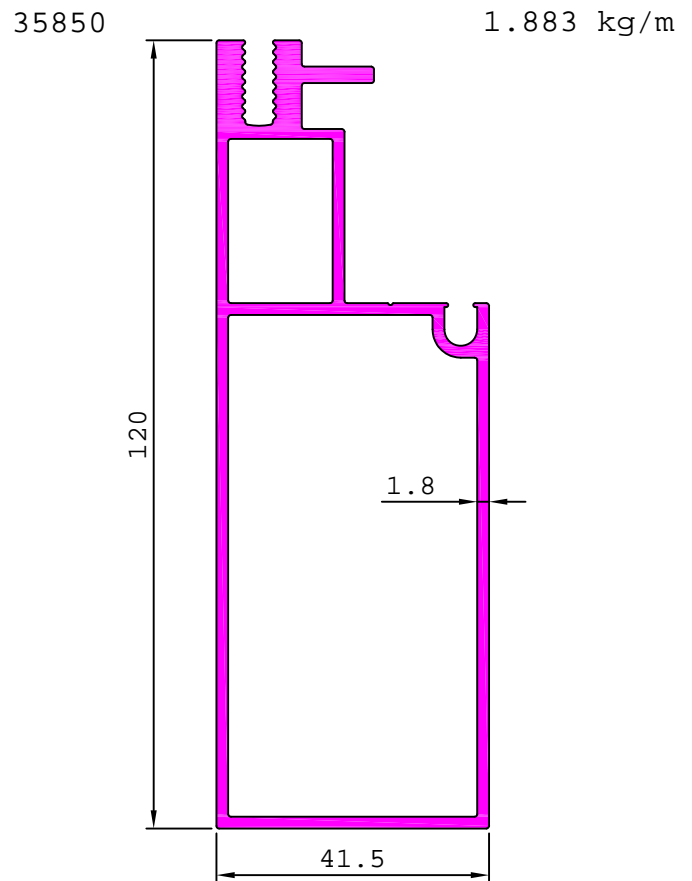
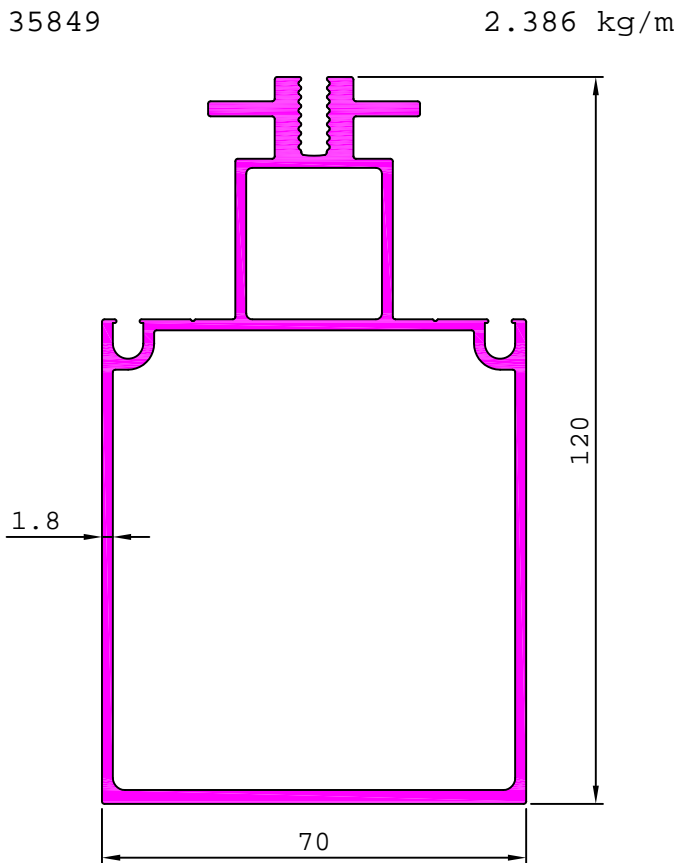

ARCHITECTURAL

CURTAIN WALL SECTION

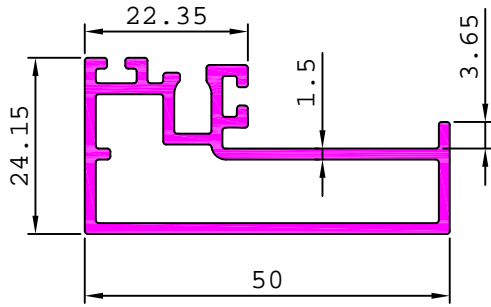

SL. No.	Section No.	A	Weight kg/m
1	35780	24.15	0.703
2	35847	31.65	0.774

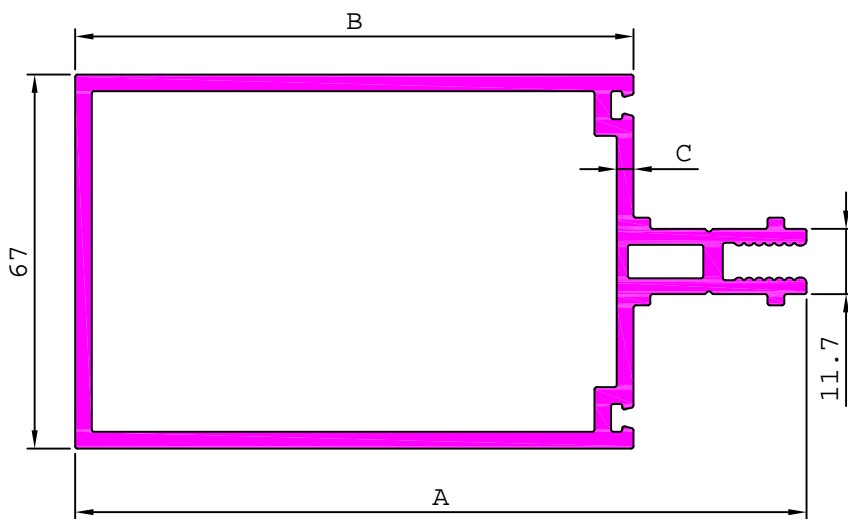
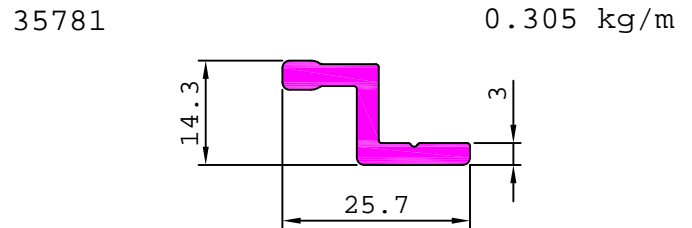
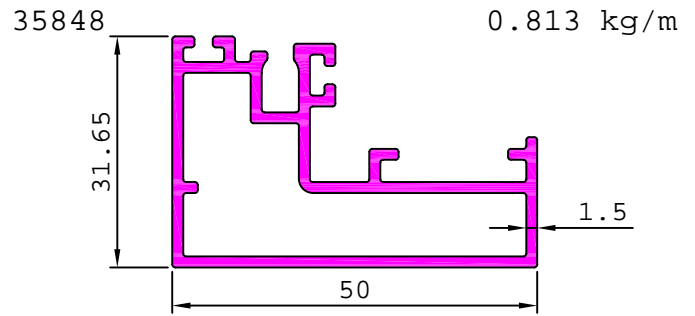

SL. No.	Section No.	A	B	C	Weight kg/m
1	35855	131.00	100.00	3.00	3.266
2	35854	166.00	135.00	5.00	5.863
3	35924	166.00	135.00	3.00	3.854

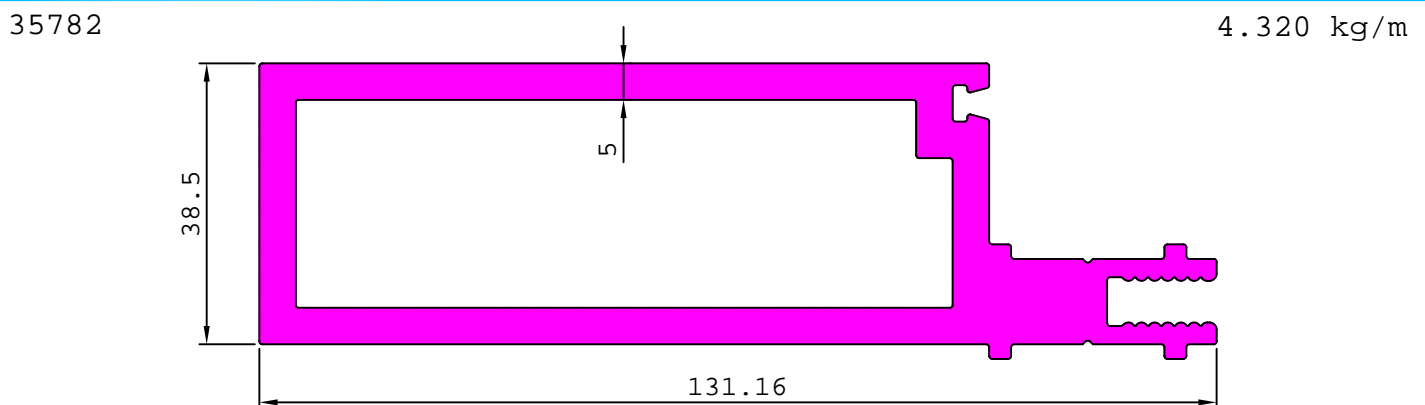
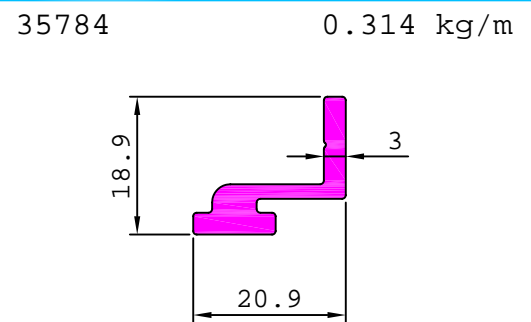
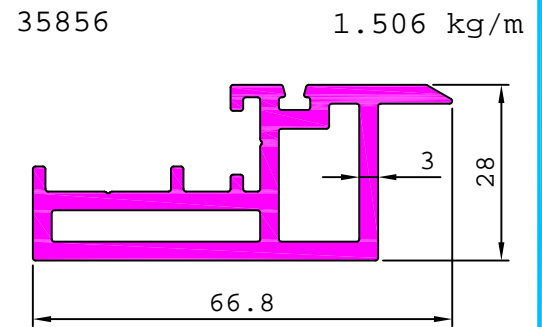

ARCHITECTURAL

CURTAIN WALL SECTION

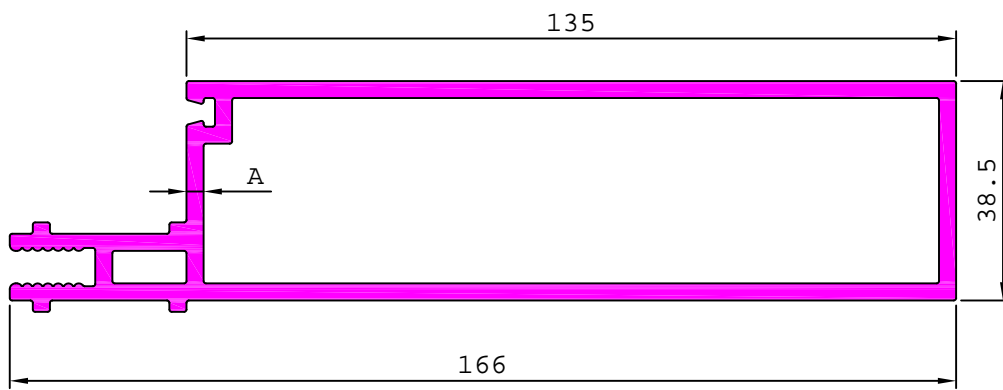

SL. No.	Section No.	A	Weight kg/m
1	35901	3.00	3.361
2	35857	5.00	5.062

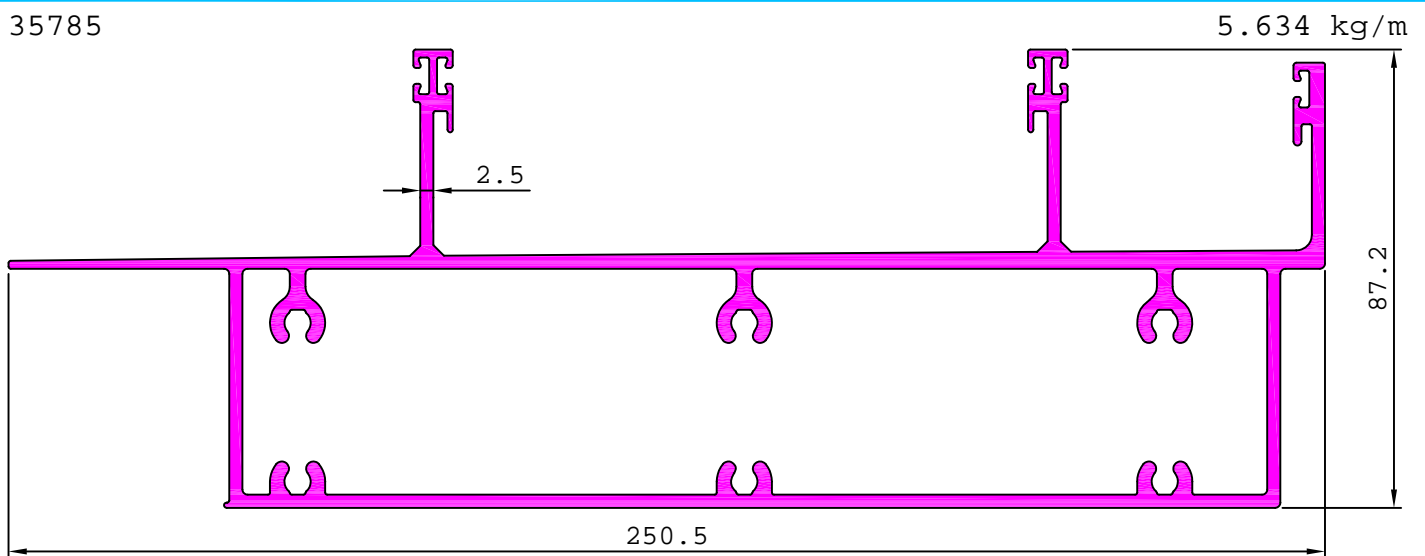
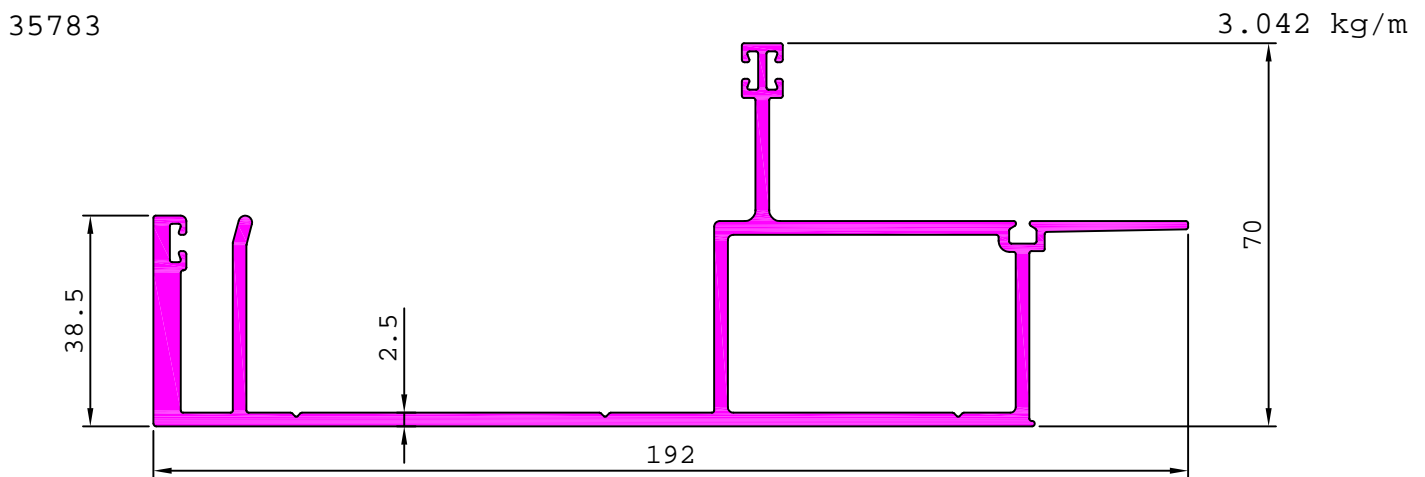
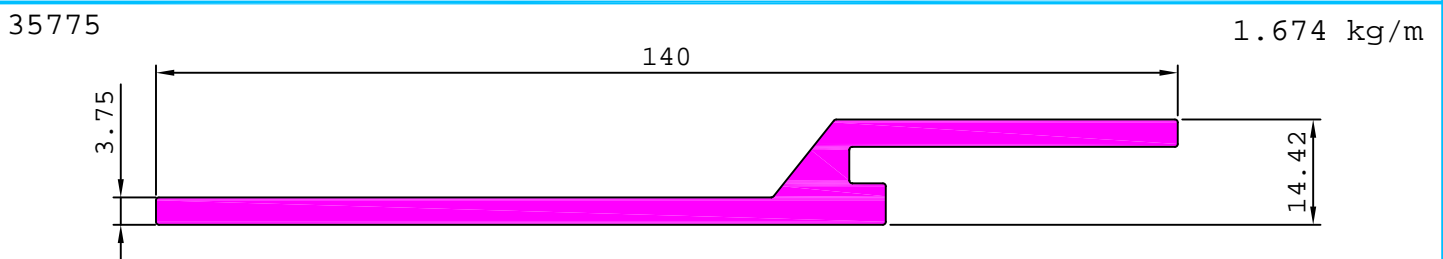

ARCHITECTURAL

CURTAIN WALL SECTION

35790

0.714 kg/m

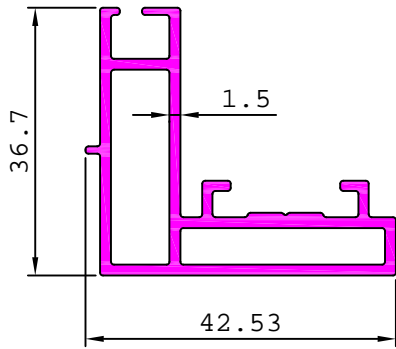

35791

0.478 kg/m

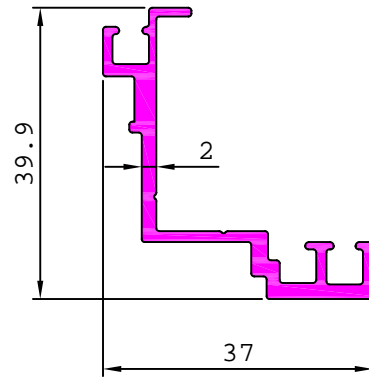

35786

4.246 kg/m

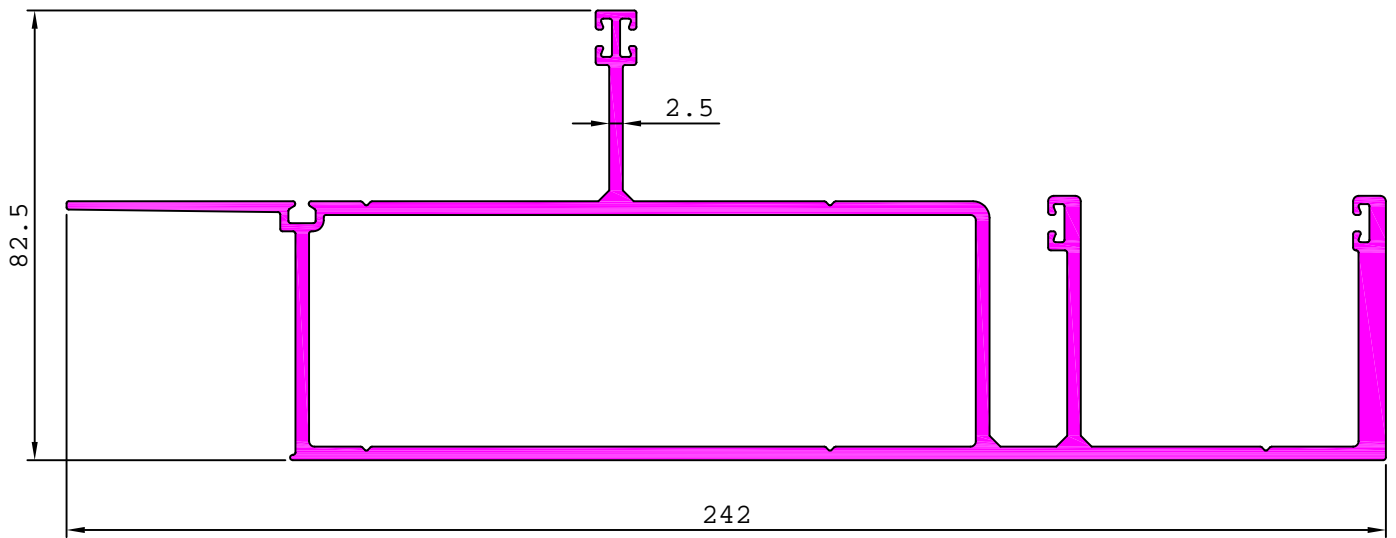

35787

4.862 kg/m

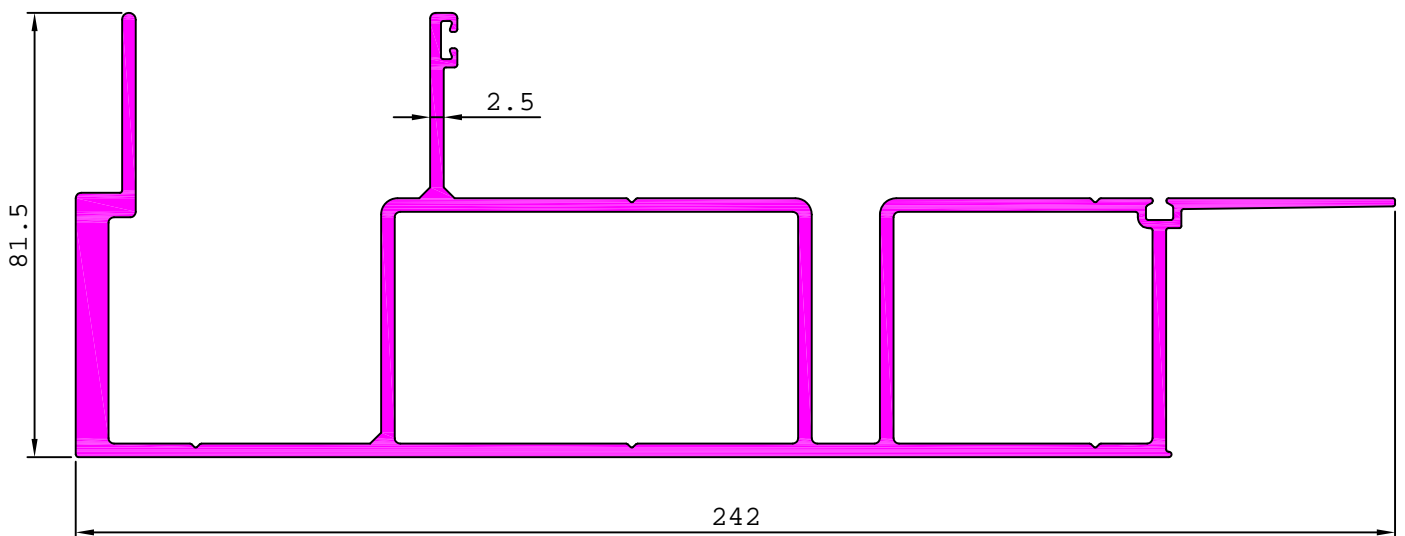

ARCHITECTURAL

CURTAIN WALL SECTION

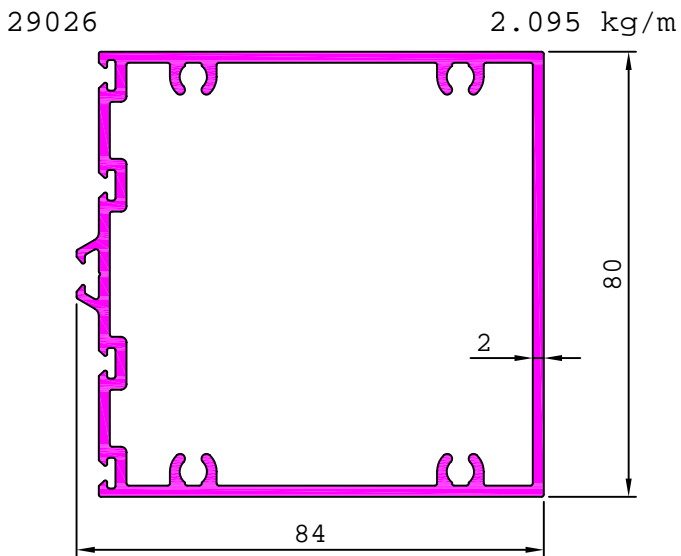
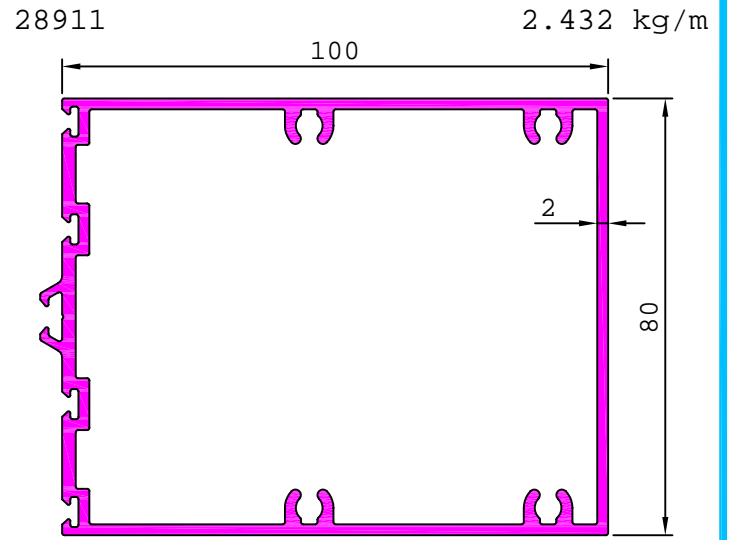
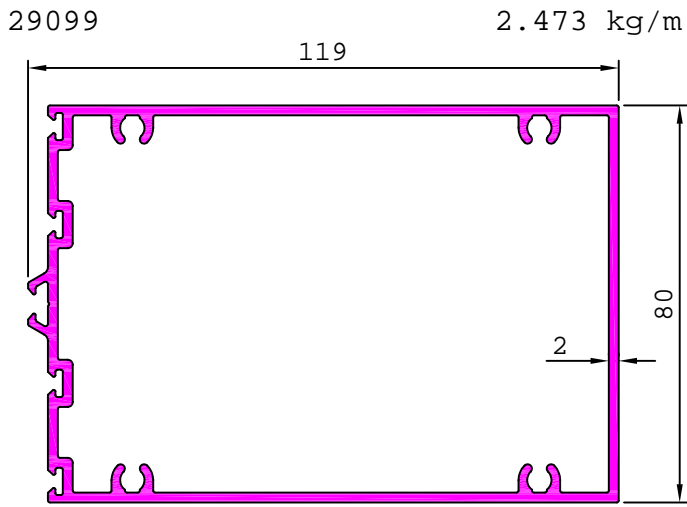

ARCHITECTURAL

CURTAIN WALL SECTION

35788

5.113 kg/m

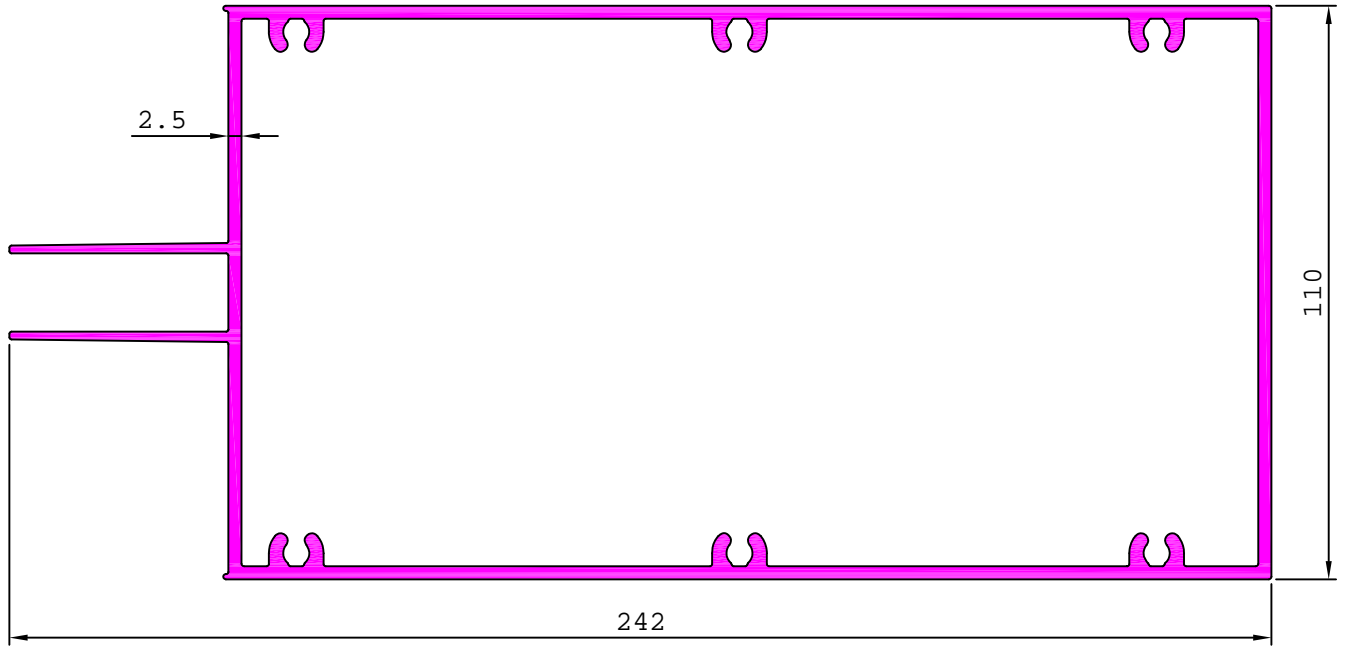

35789

6.328 kg/m

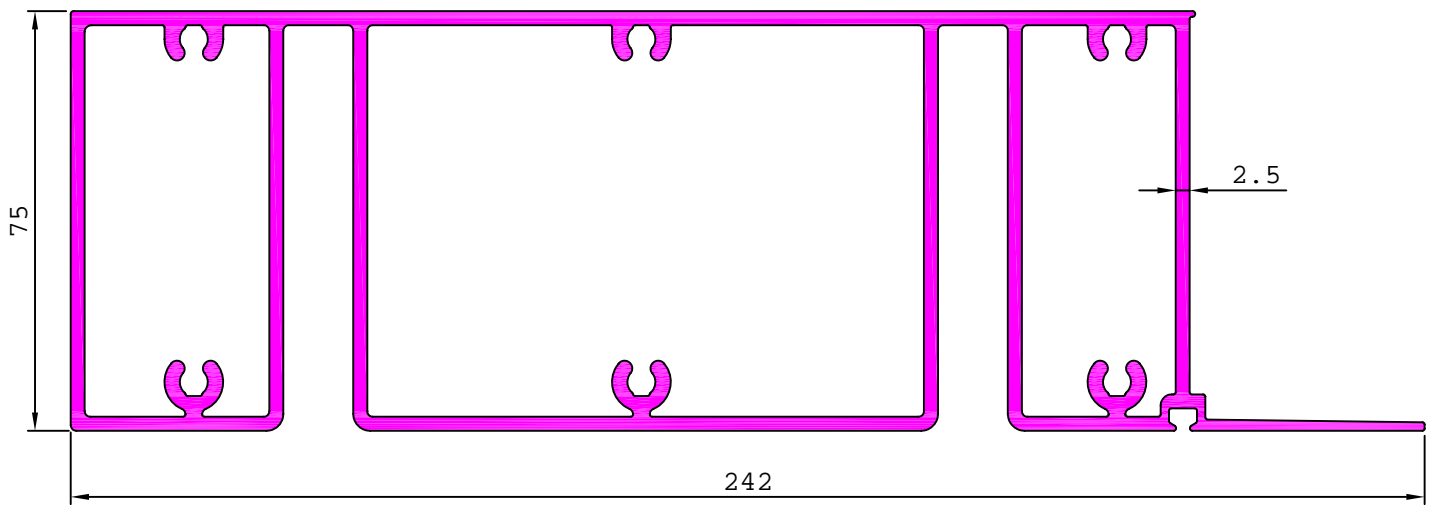

35793

3.308 kg/m

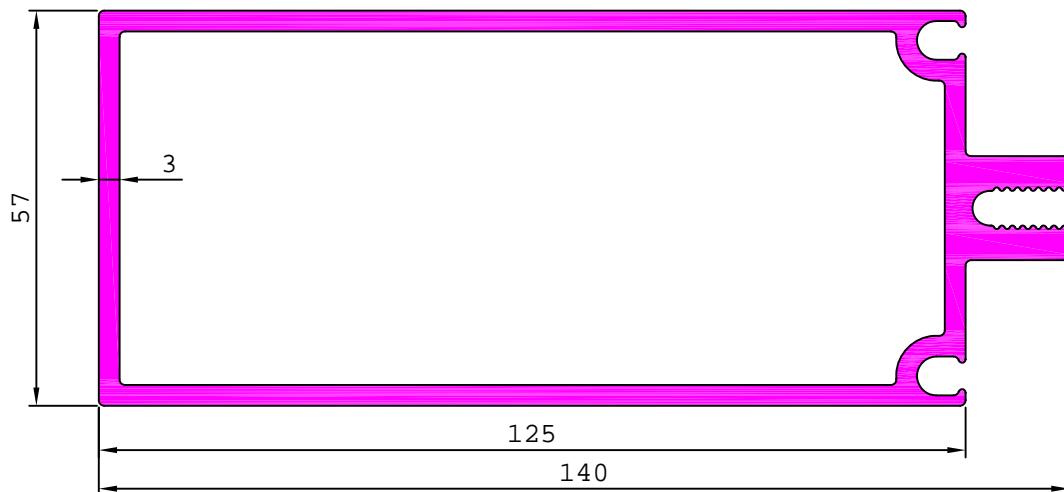

ARCHITECTURAL

CURTAIN WALL SECTION

35792

0.487 kg/m

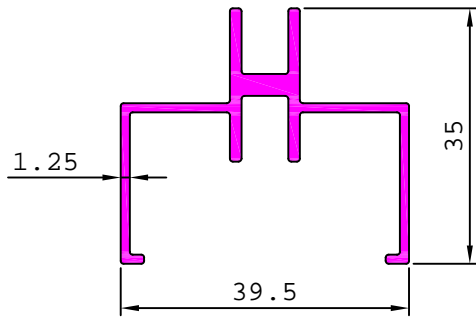

35795

1.742 kg/m

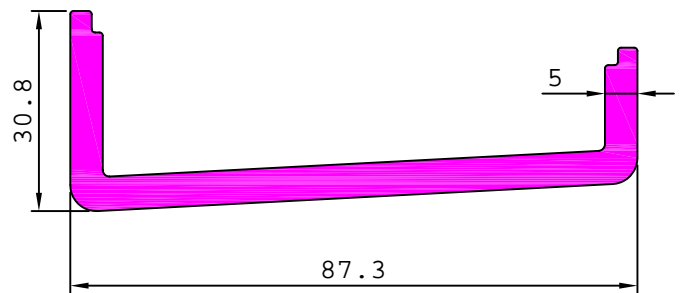

MATCHING WITH 35796

35796

2.068 kg/m

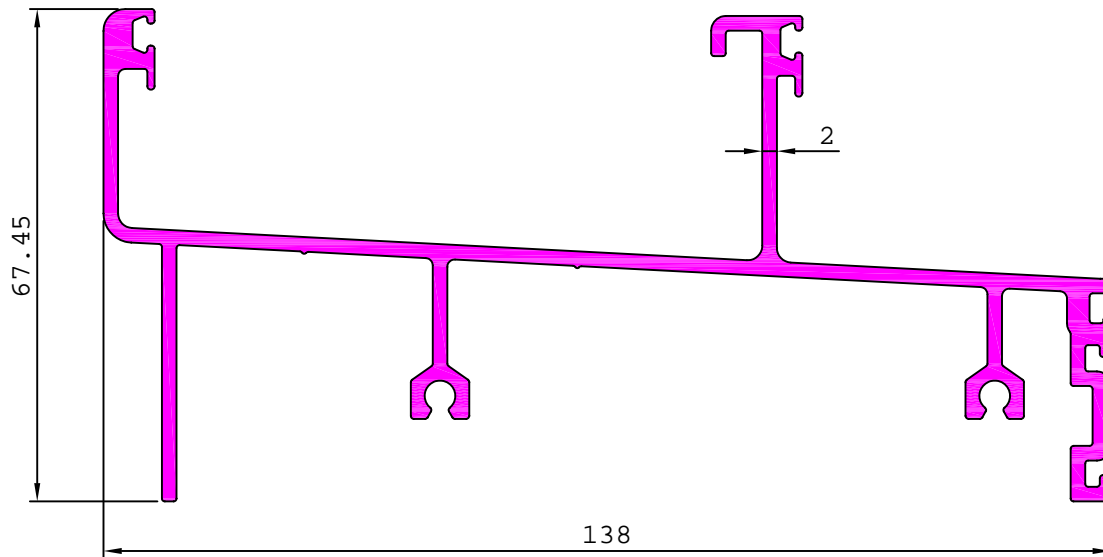

MATCHING WITH 35795

35794

3.764 kg/m

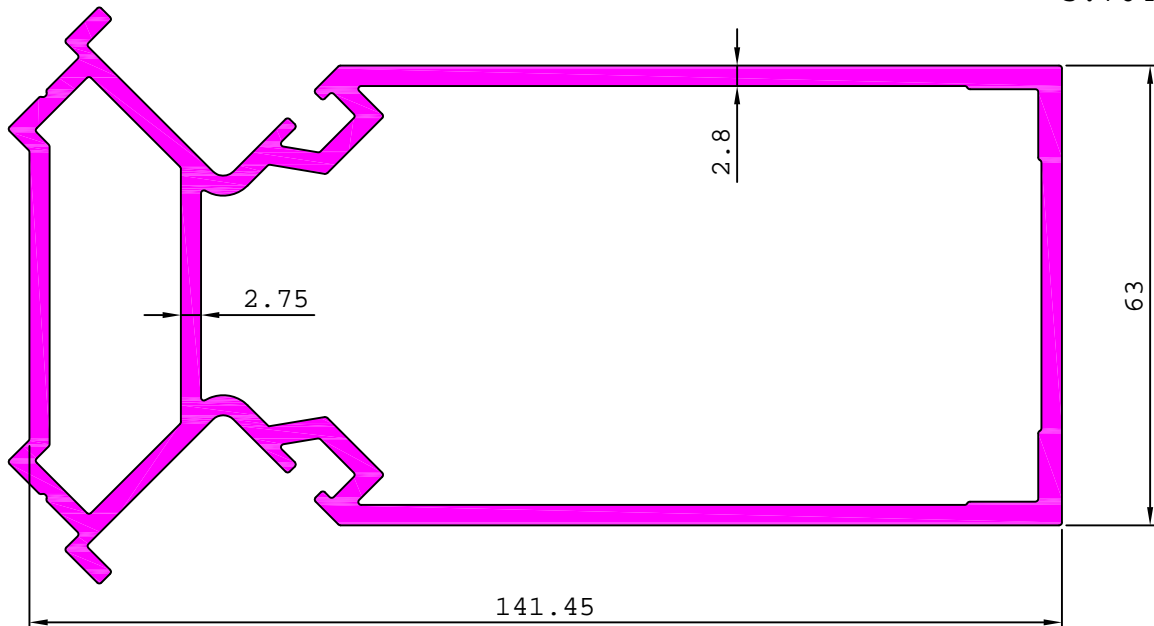

ARCHITECTURAL

CURTAIN WALL SECTION

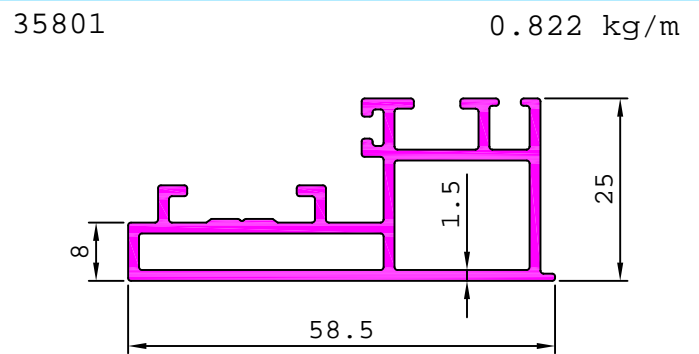
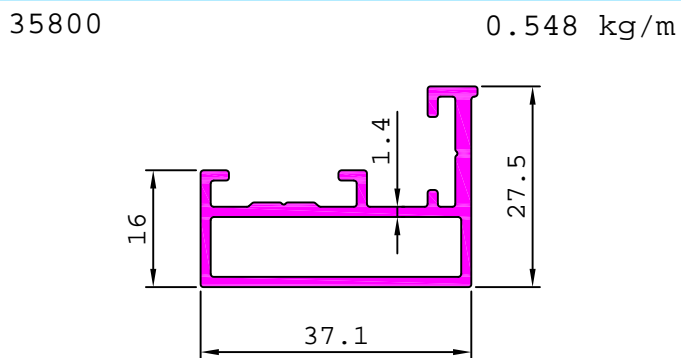
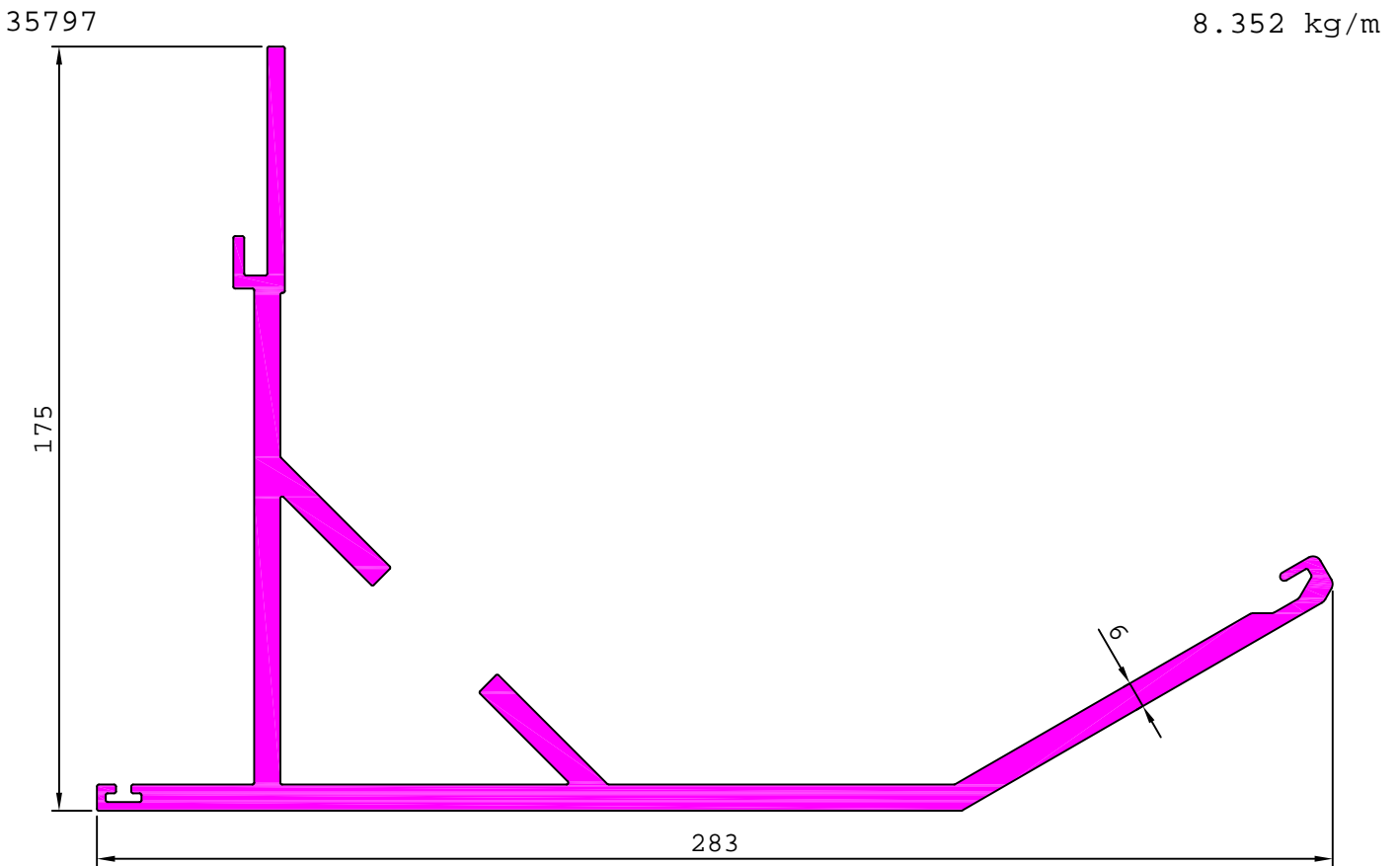
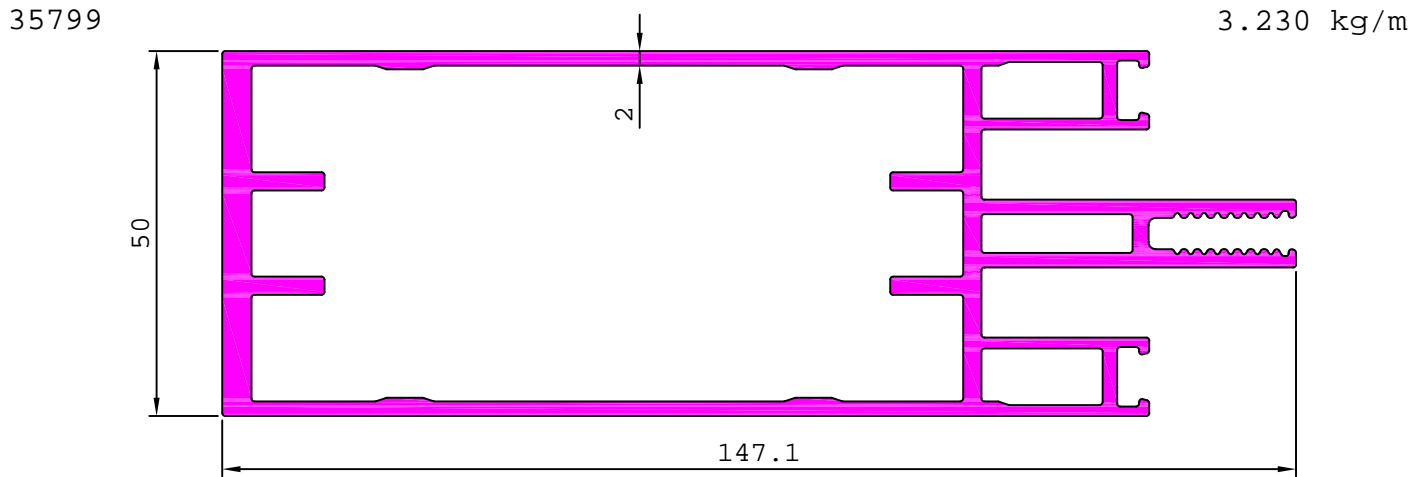

ARCHITECTURAL

CURTAIN WALL SECTION

35798 1.889 kg/m

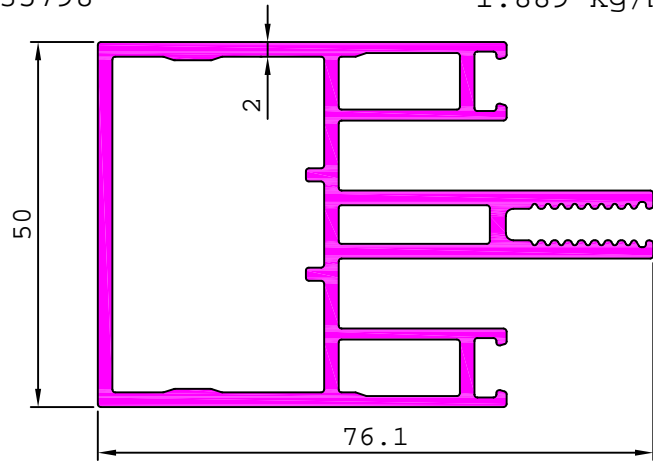

35802 2.421 kg/m

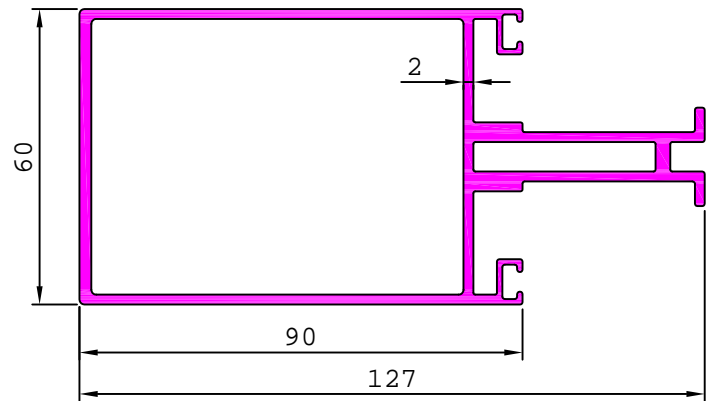

35804 1.011 kg/m

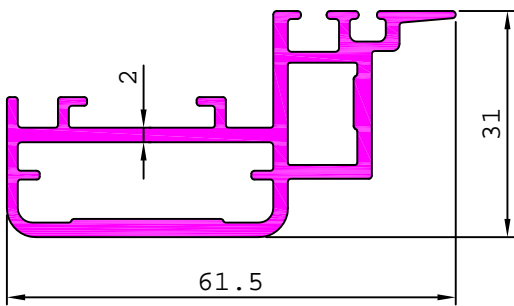

35805 3.093 kg/m

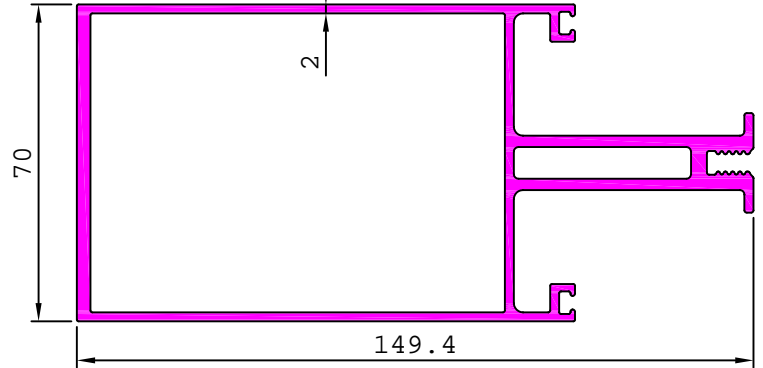

35808 2.667 kg/m

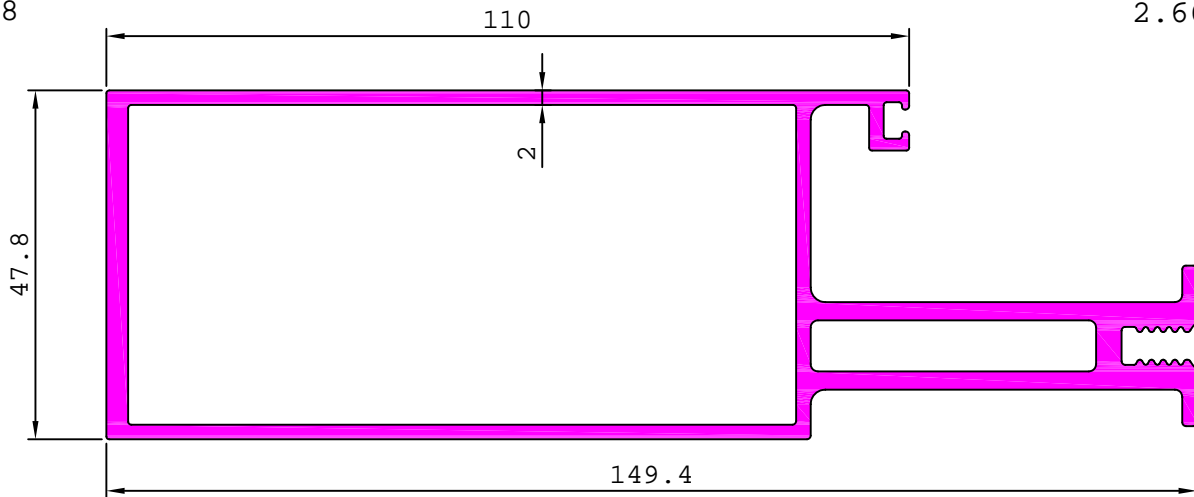

35809 0.358 kg/m

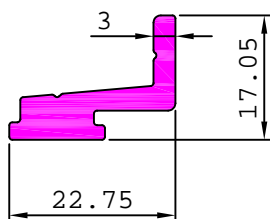

35909 0.179 kg/m

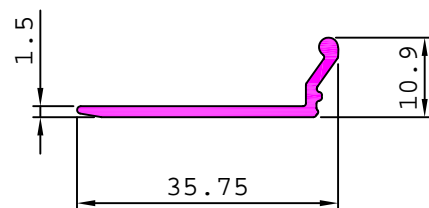

ARCHITECTURAL

CURTAIN WALL SECTION

35806 2.370 kg/m

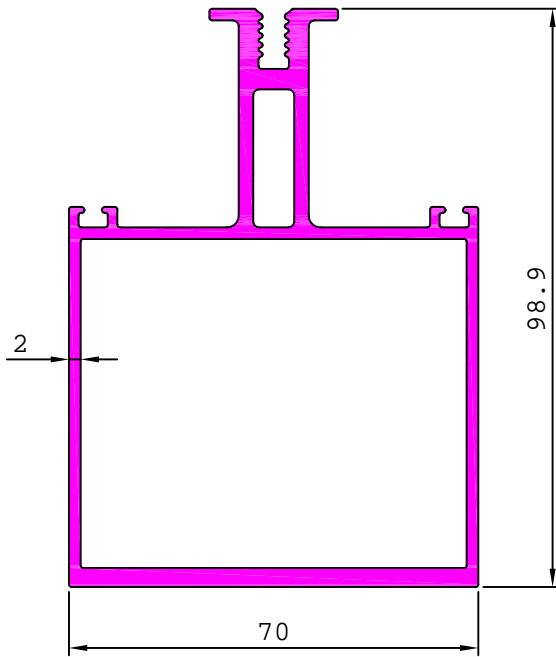

35807 1.985 kg/m

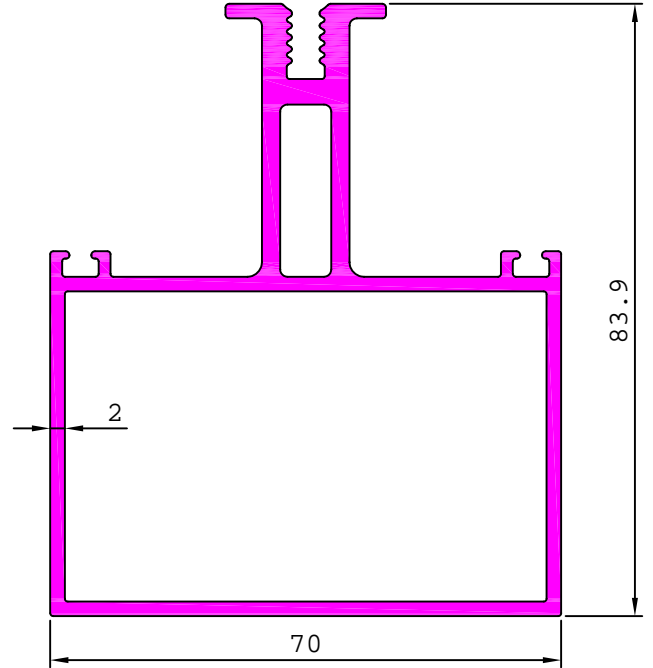

35813 1.034 kg/m

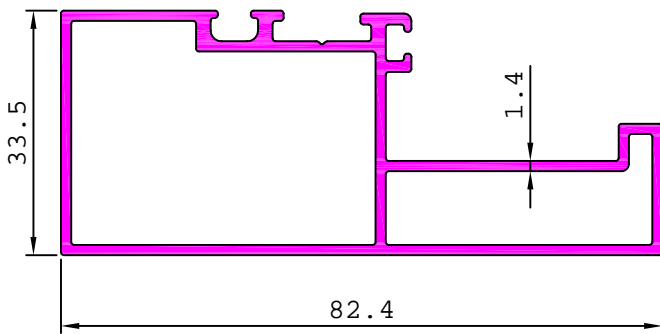

35816 0.271 kg/m

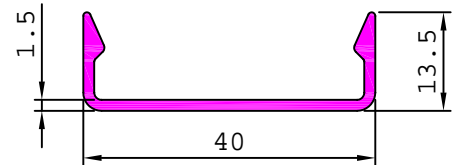

35817 0.449 kg/m

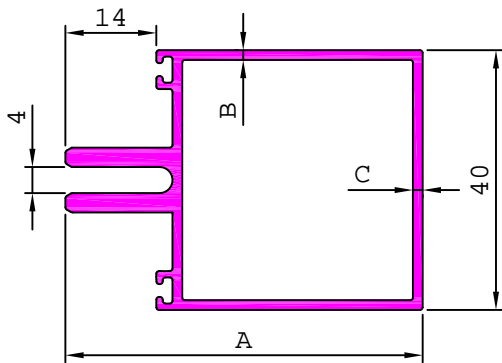
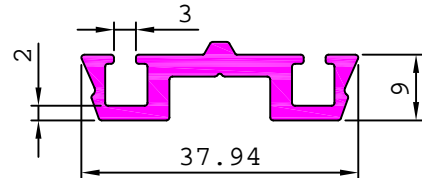

SL. No.	Section No.	A	B	C	Weight kg/m
1	35814	55.00	1.50	1.50	0.918
2	35815	95.00	1.60	1.80	1.343

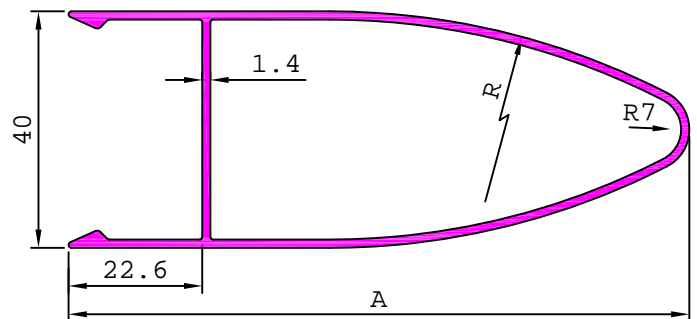

SL. No.	Section No.	A	R	Weight kg/m
1	35810	125.00	150.00	1.143
2	35811	105.00	125.00	0.994
3	35812	80.00	75.00	0.810

MATCHING WITH 35817

ARCHITECTURAL

CURTAIN WALL SECTION

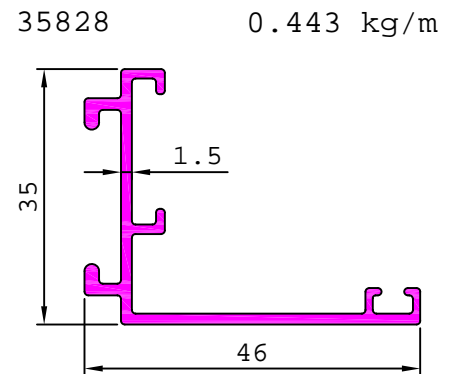
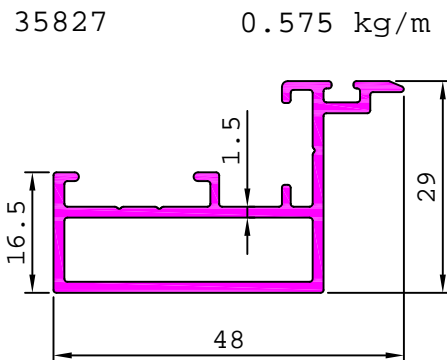
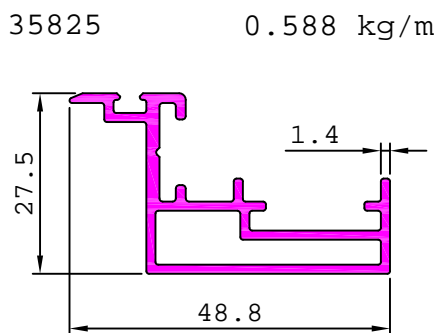
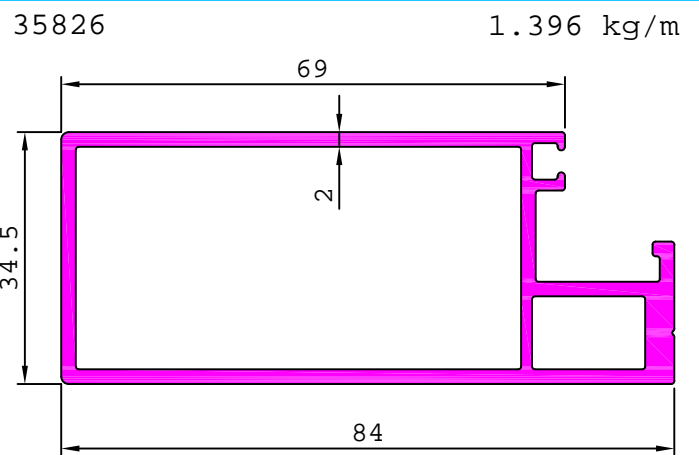
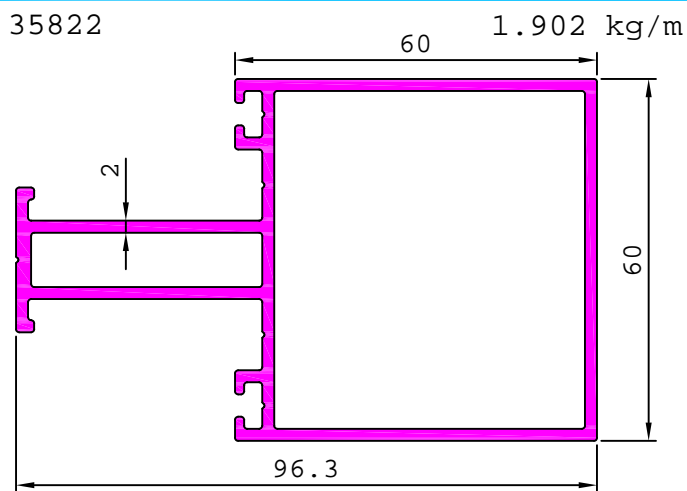
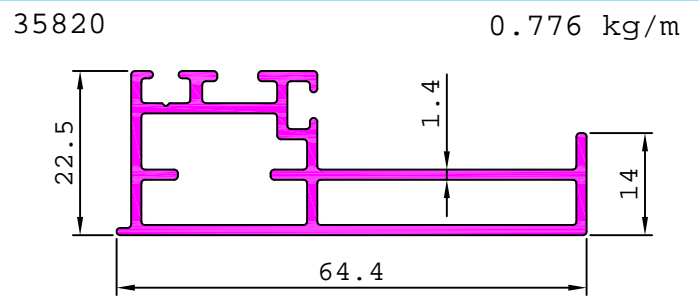
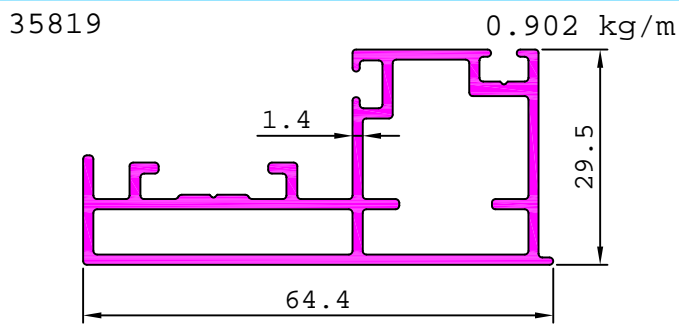
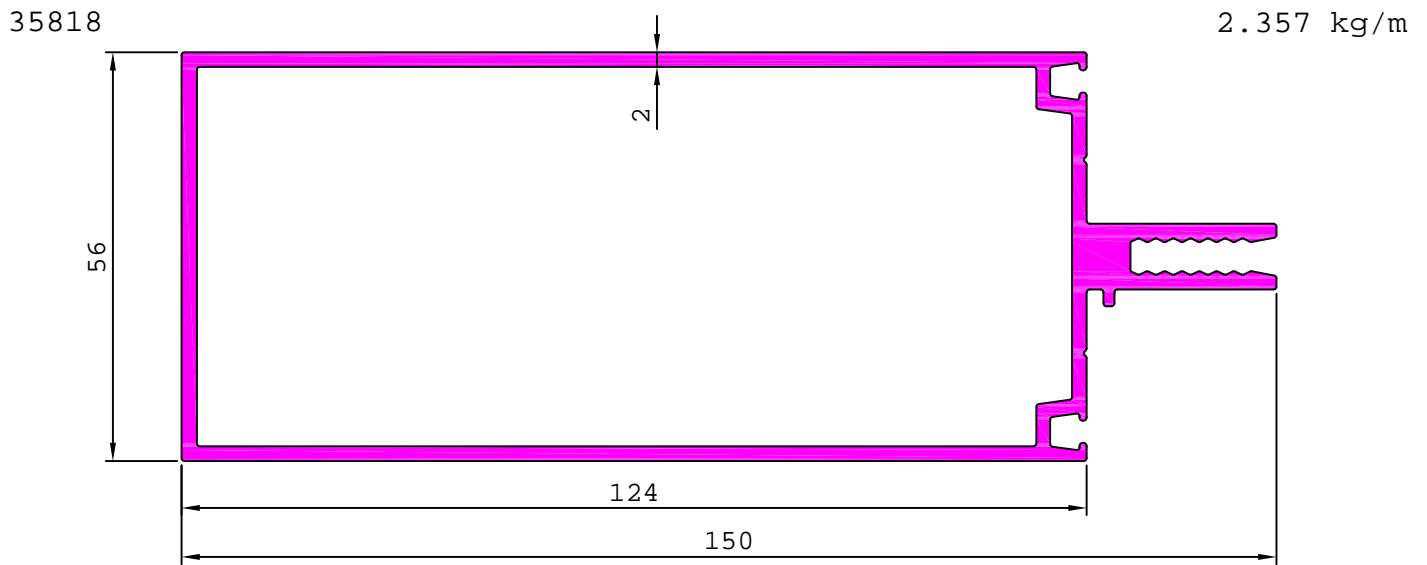

ARCHITECTURAL

CURTAIN WALL SECTION

35823

2.990 kg/m

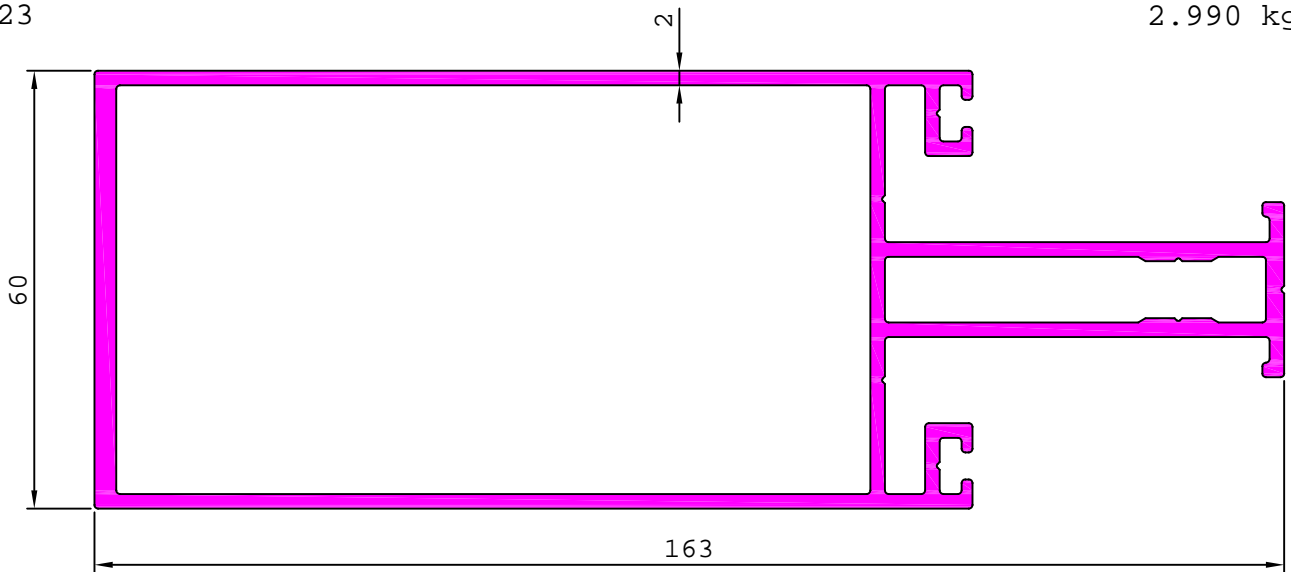

35824

2.244 kg/m

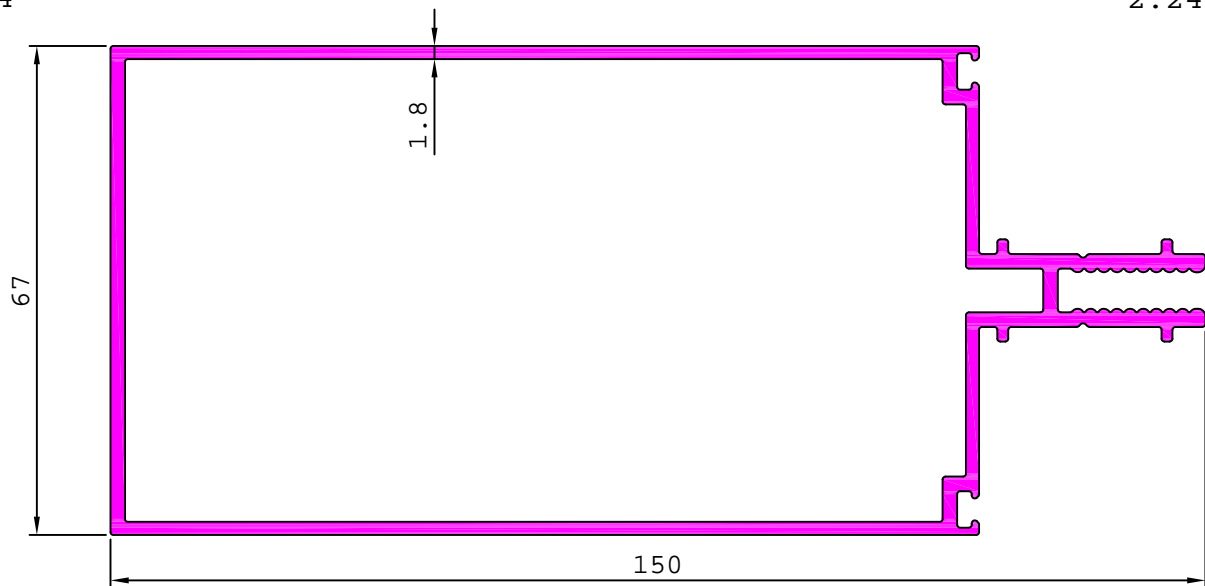

35830

2.127 kg/m

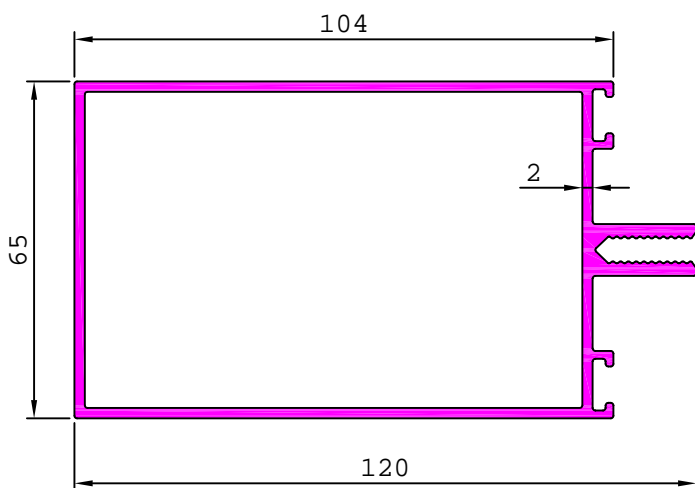

35831

2.083 kg/m

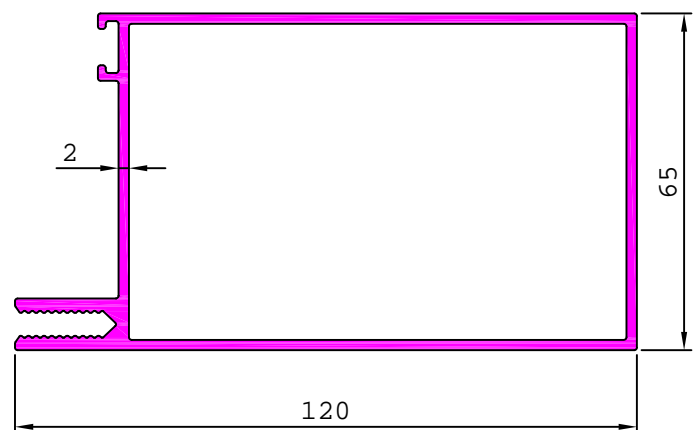

ARCHITECTURAL

CURTAIN WALL SECTION

35829 0.583 kg/m

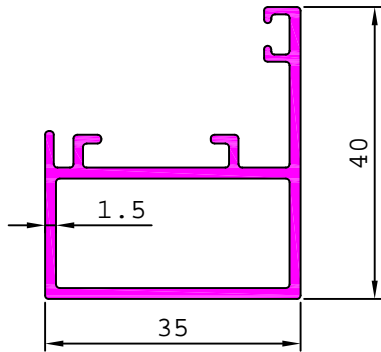

35832 0.207 kg/m

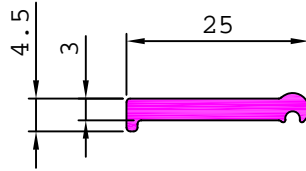

35833 0.112 kg/m

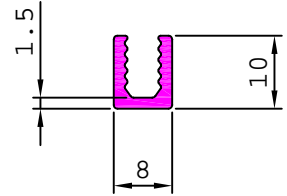

35834 4.416 kg/m

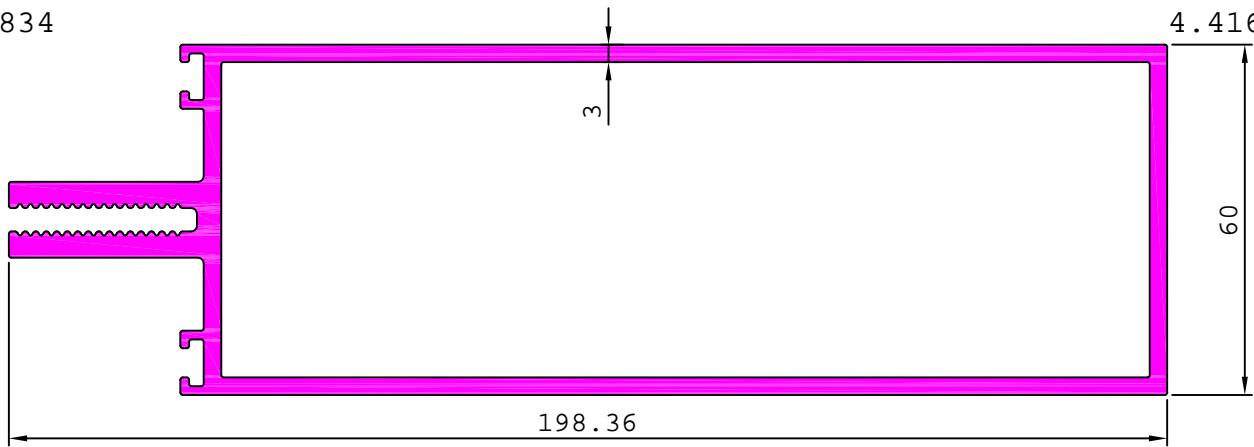

35835 2.798 kg/m

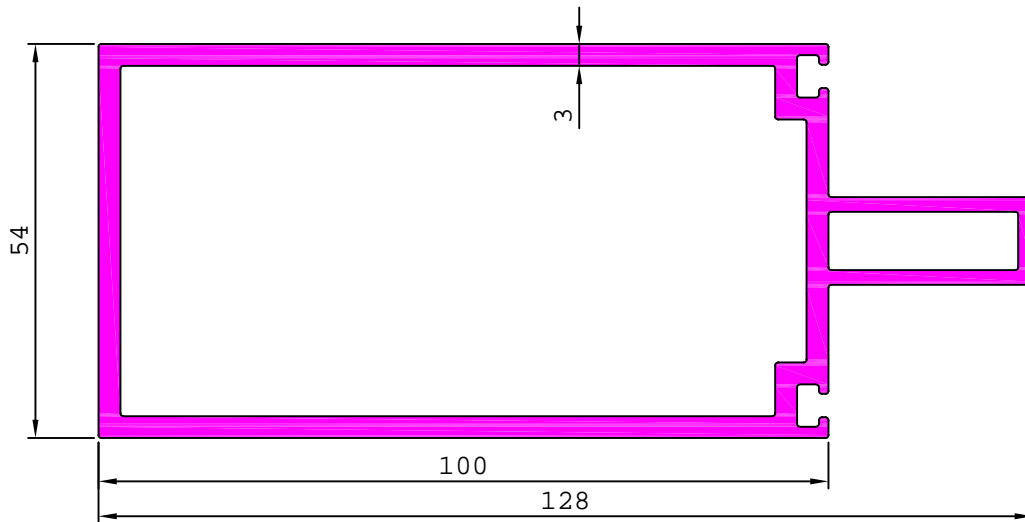

35836 1.850 kg/m

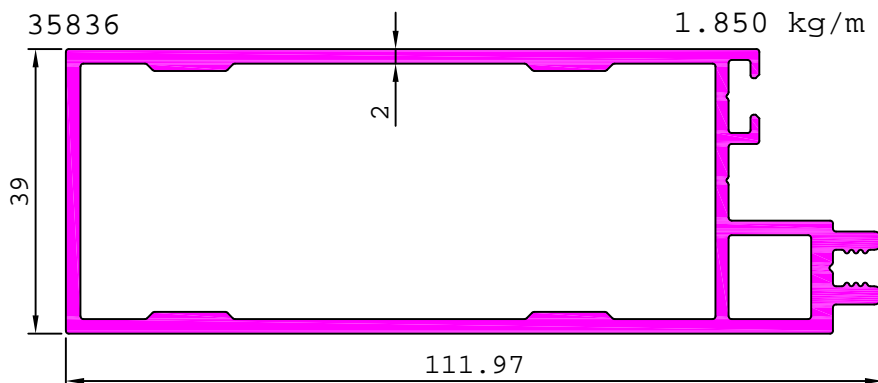

35837 0.756 kg/m

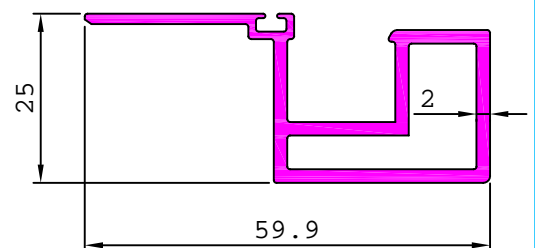

ARCHITECTURAL

CURTAIN WALL SECTION

35838

1.500 kg/m

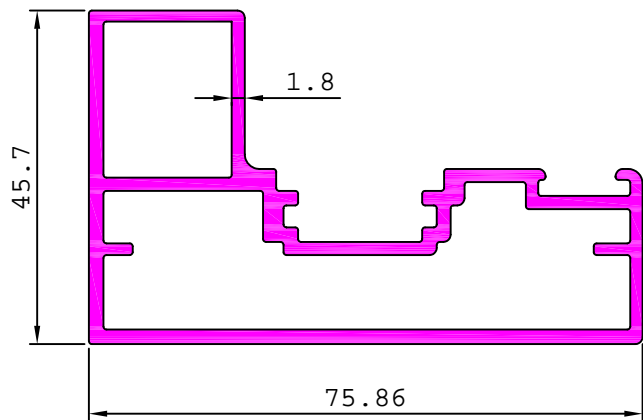

35839

1.434 kg/m

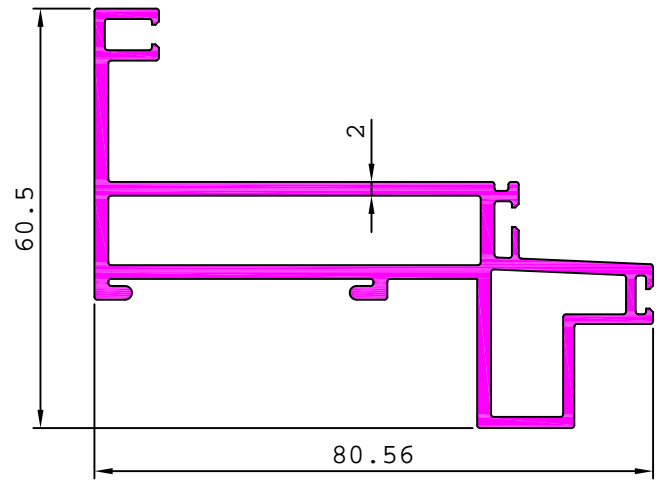

35840

5.151 kg/m

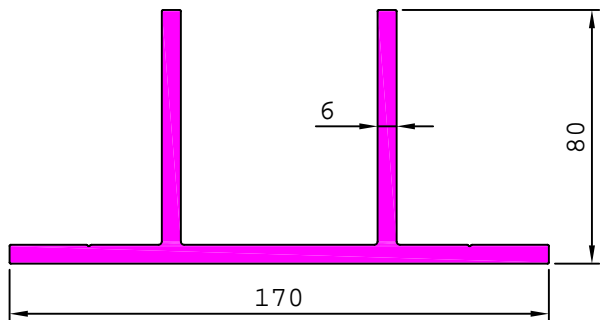

35841

0.433 kg/m

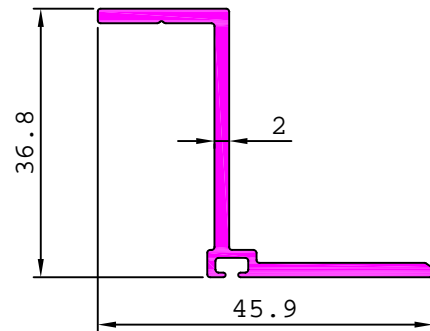

35842

0.931 kg/m

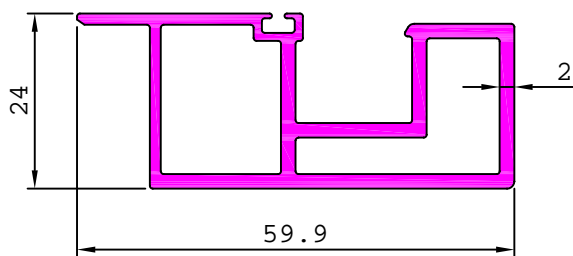

35843

3.486 kg/m

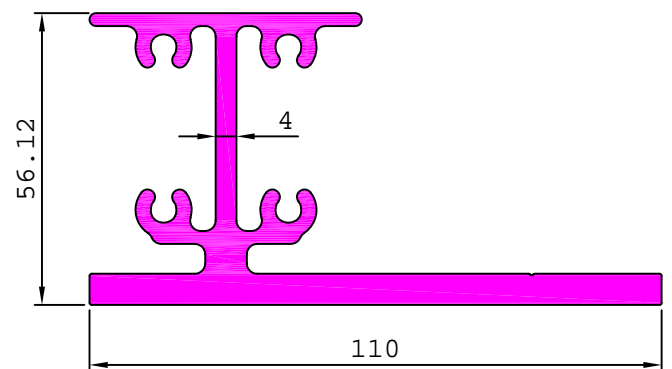

35852

5.641 kg/m

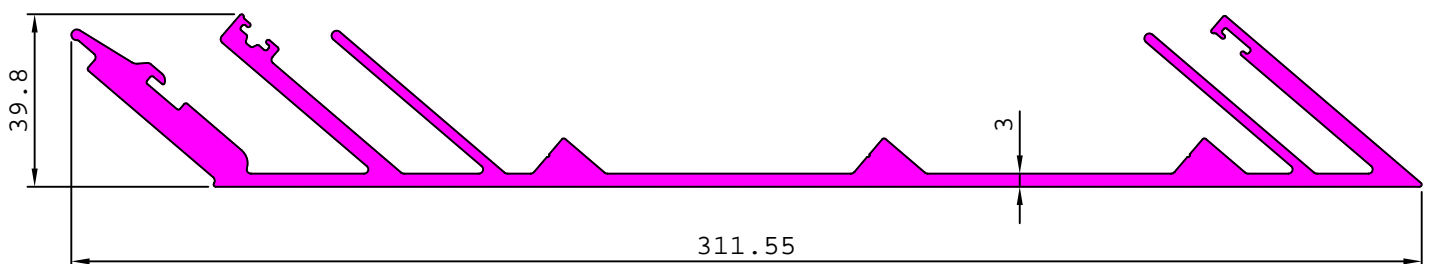

ARCHITECTURAL

CURTAIN WALL SECTION

35851

6.946 kg/m

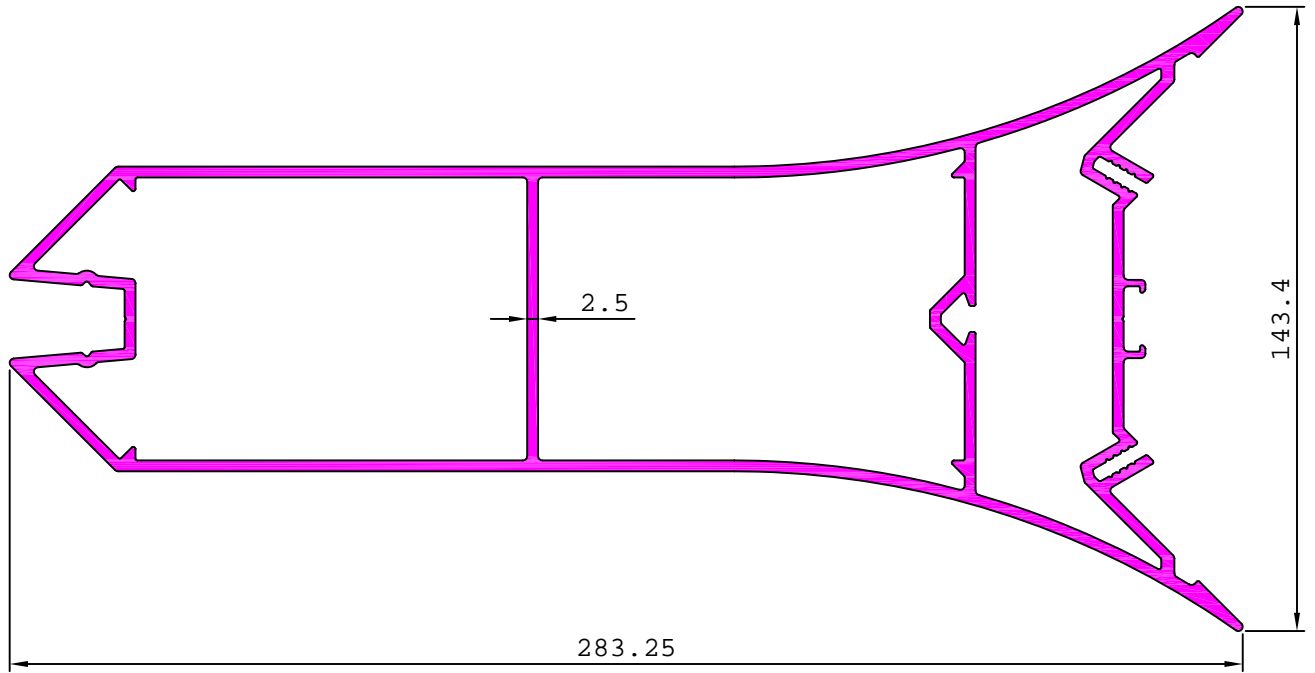

35853

3.949 kg/m

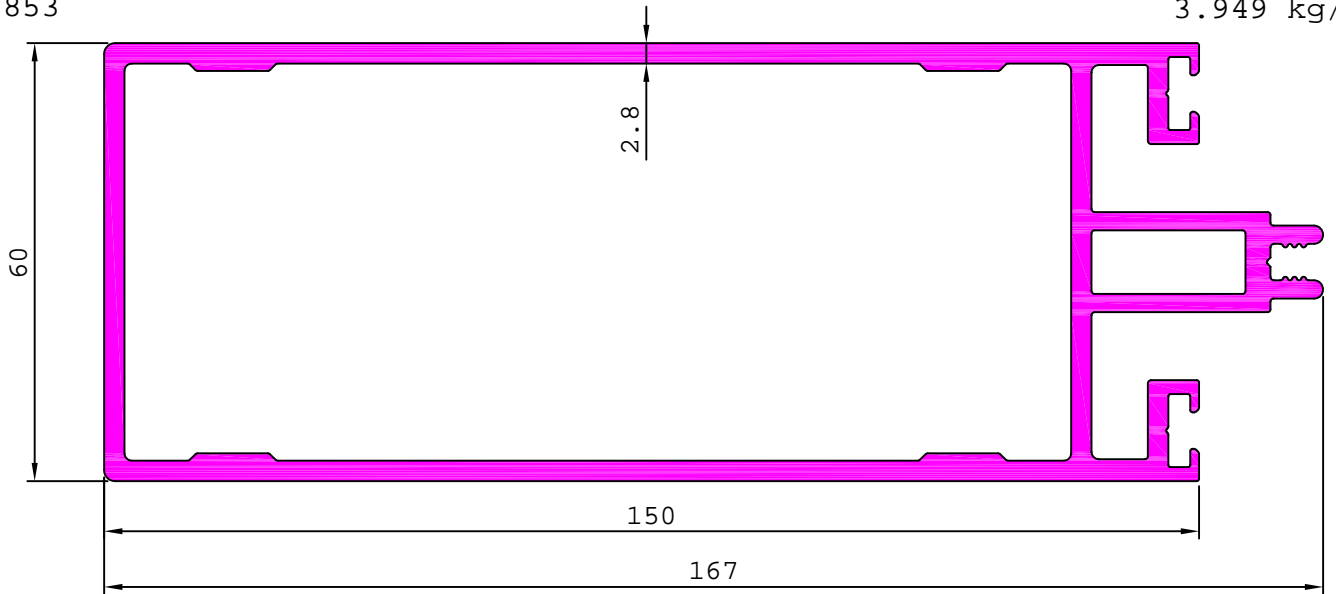

35858

0.553 kg/m

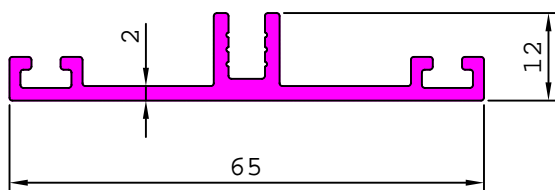

35860

0.834 kg/m

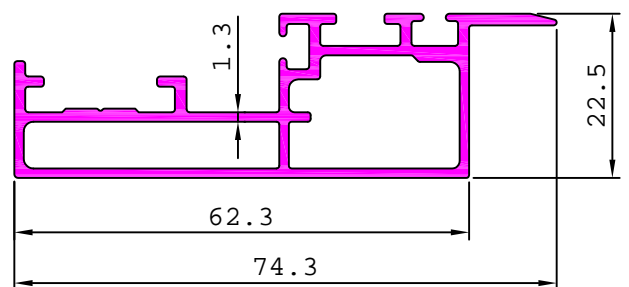

ARCHITECTURAL

CURTAIN WALL SECTION

35859

4.041 kg/m

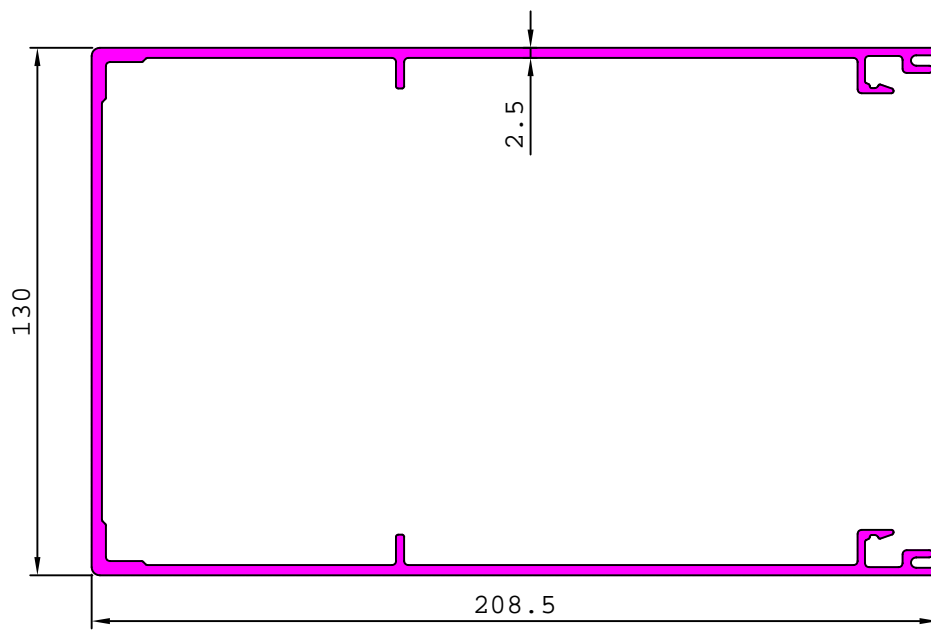

35865

0.350 kg/m

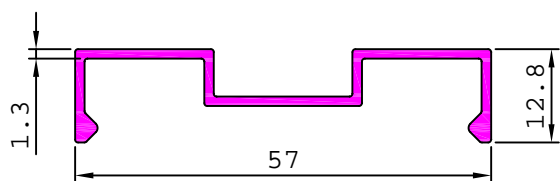

35874

0.818 kg/m

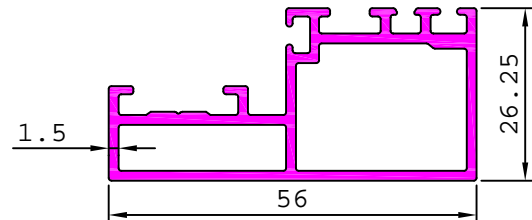

35867

3.709 kg/m

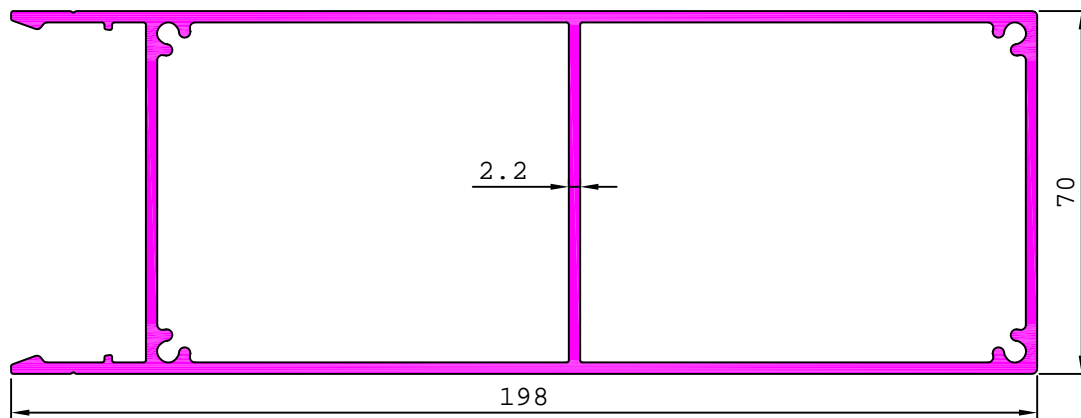

35868

3.708 kg/m

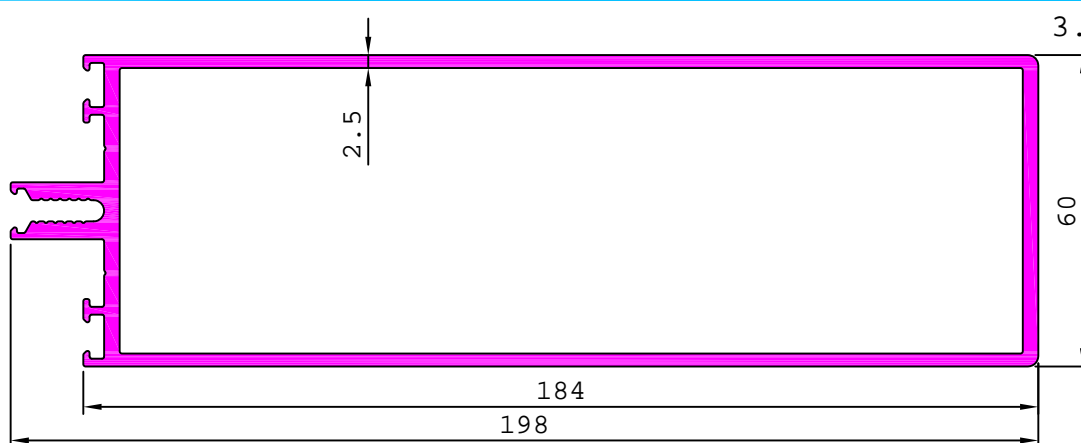

ARCHITECTURAL

CURTAIN WALL SECTION

35870

2.756 kg/m

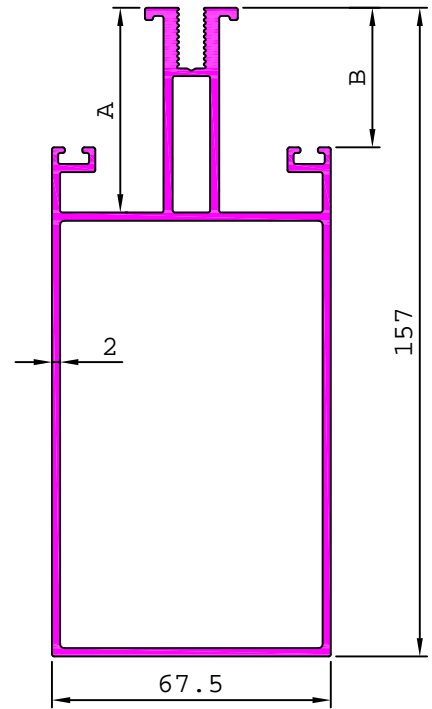
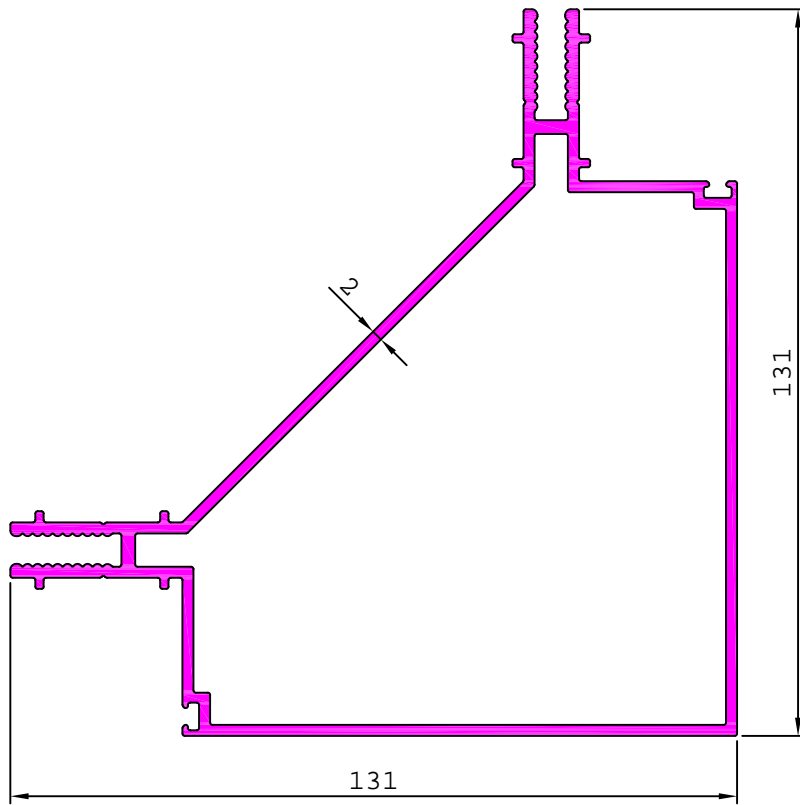

SL. No.	Section No.	A	B	Weight kg/m
1	35872	49.55	33.80	2.952
2	35873	31.30	27.30	2.698

35869

0.648 kg/m

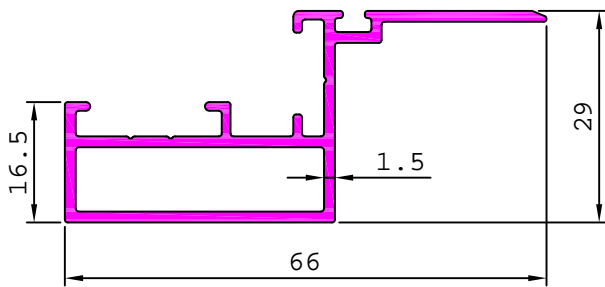

35877

0.969 kg/m

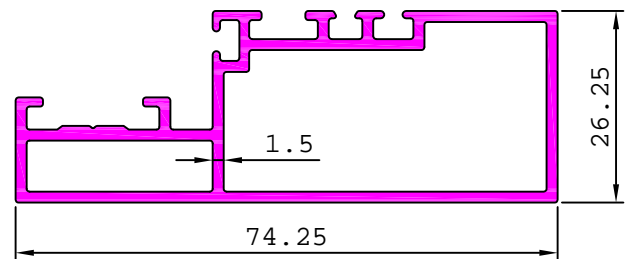

35875

2.594 kg/m

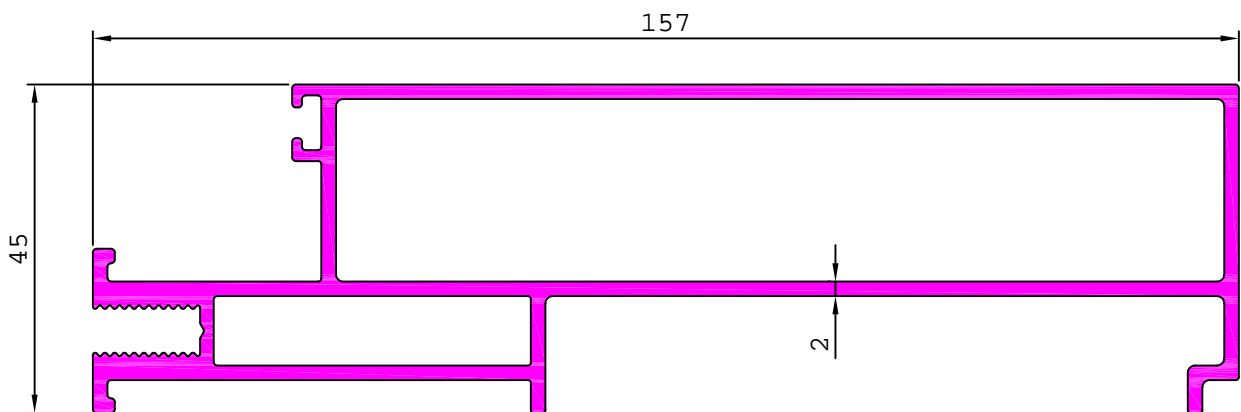

ARCHITECTURAL

CURTAIN WALL SECTION

35876

2.621 kg/m

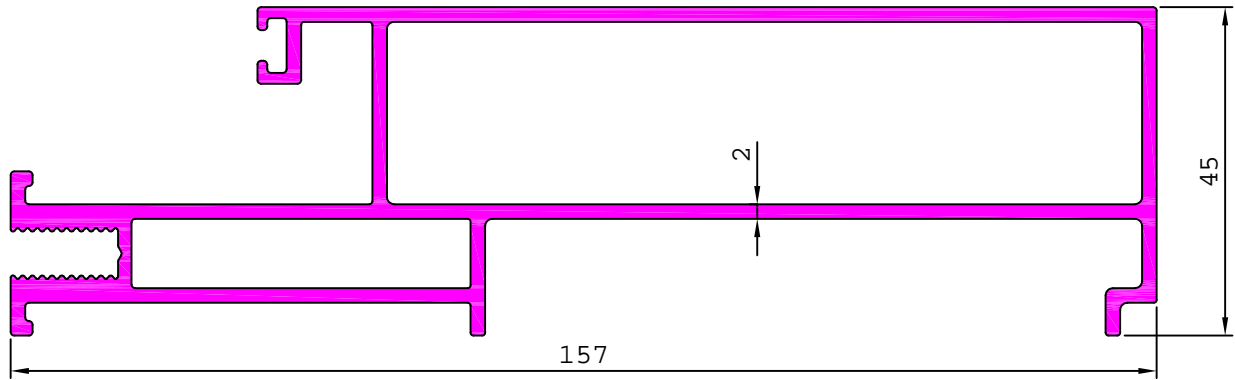

35880

1.438 kg/m

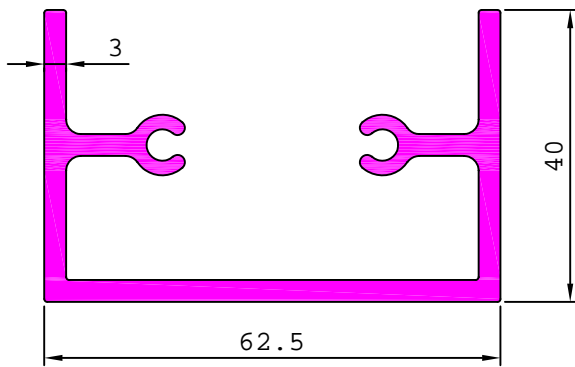

35883

5.786 kg/m

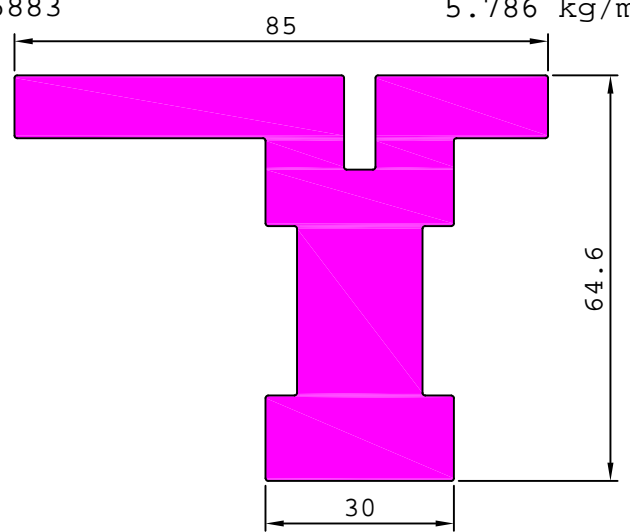

35885

0.221 kg/m

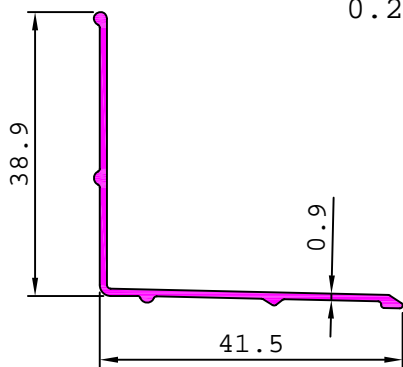

35886

0.811 kg/m

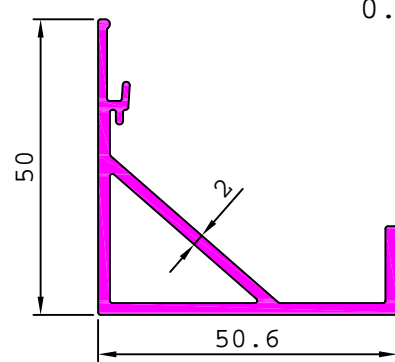

35887

3.657 kg/m

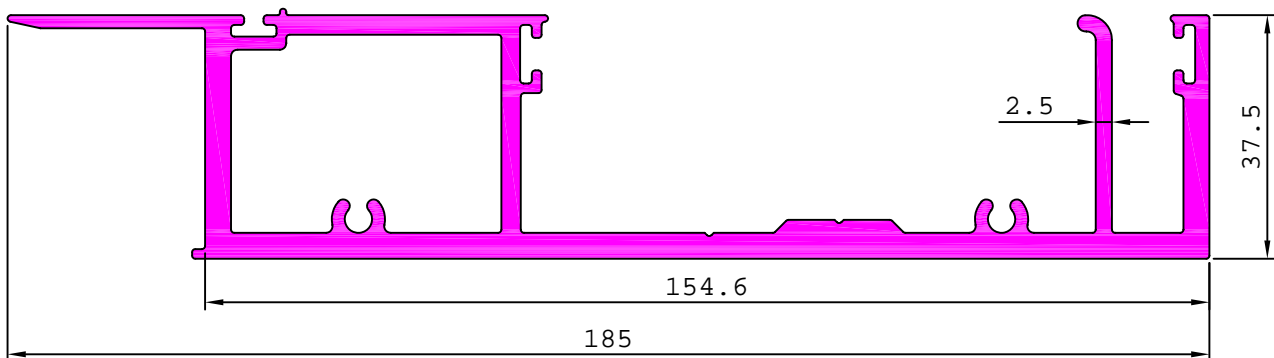

ARCHITECTURAL

CURTAIN WALL SECTION

35888

2.531 kg/m

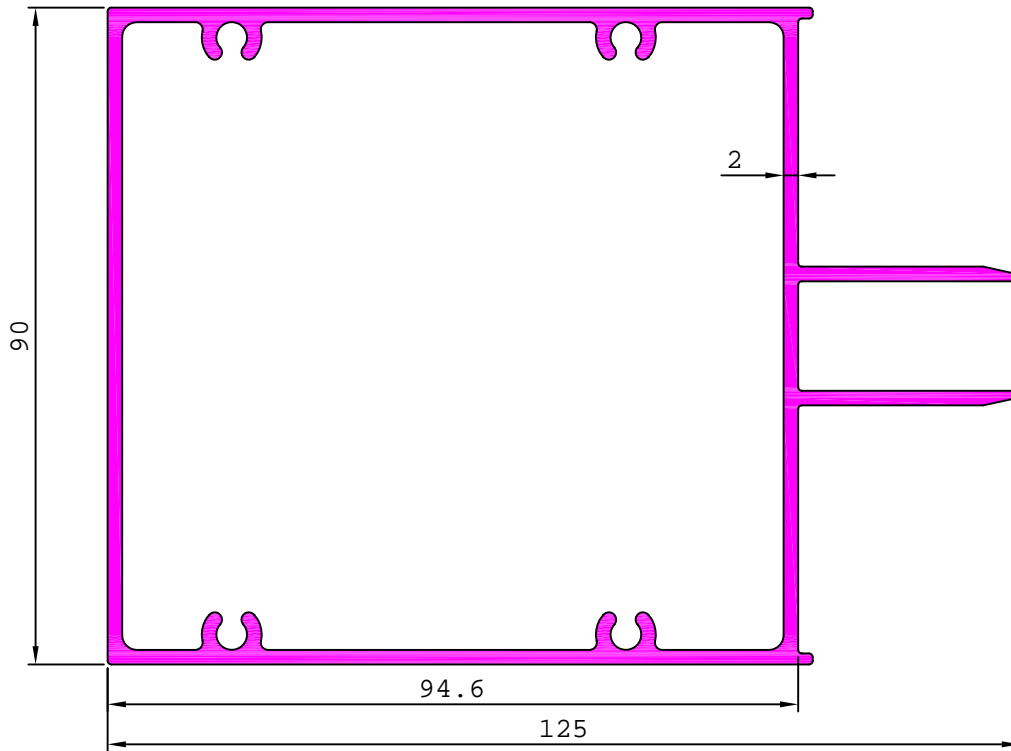

35889

3.553 kg/m

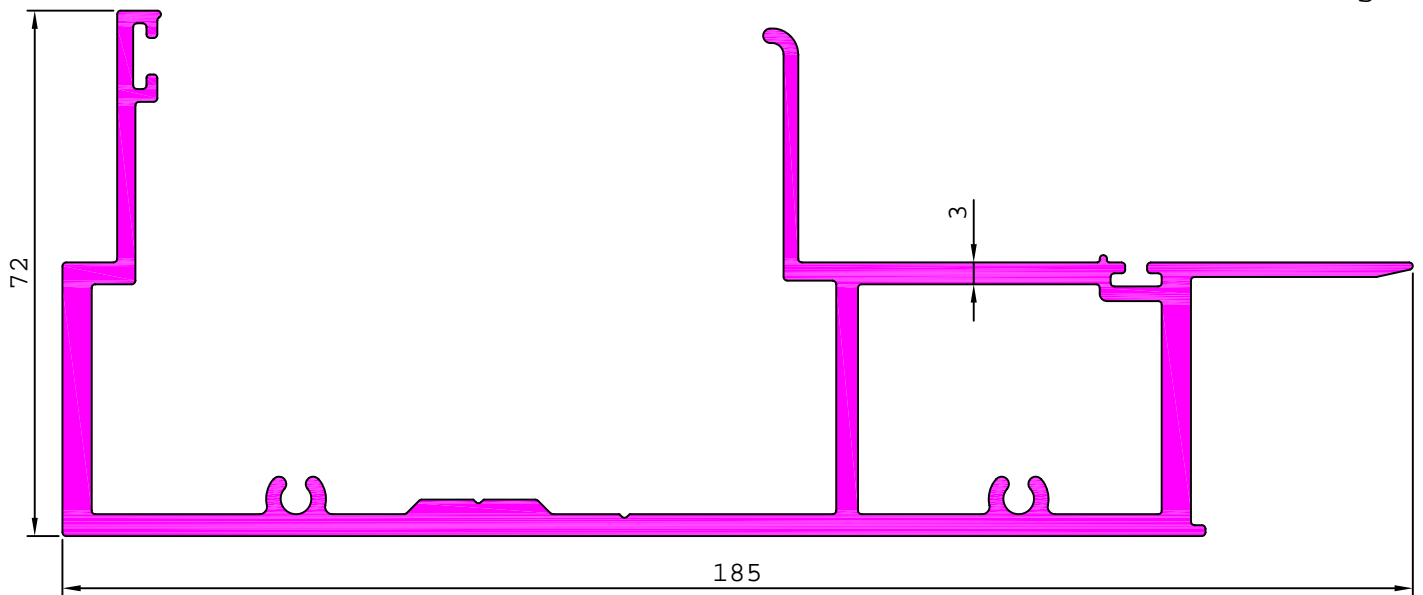

35890

1.605 kg/m

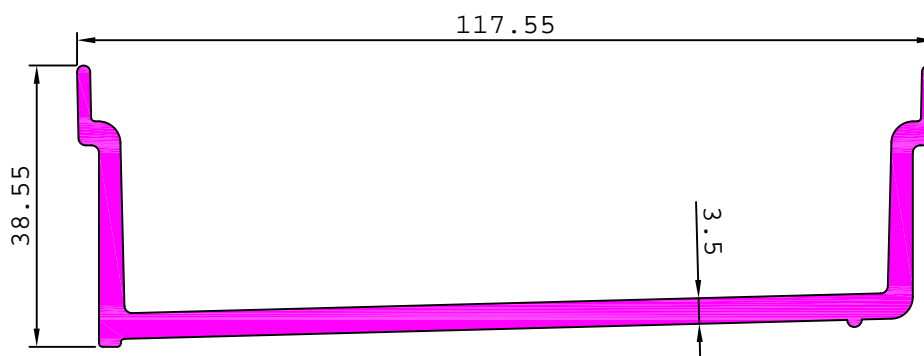

ARCHITECTURAL

CURTAIN WALL SECTION

35891

2.581 kg/m

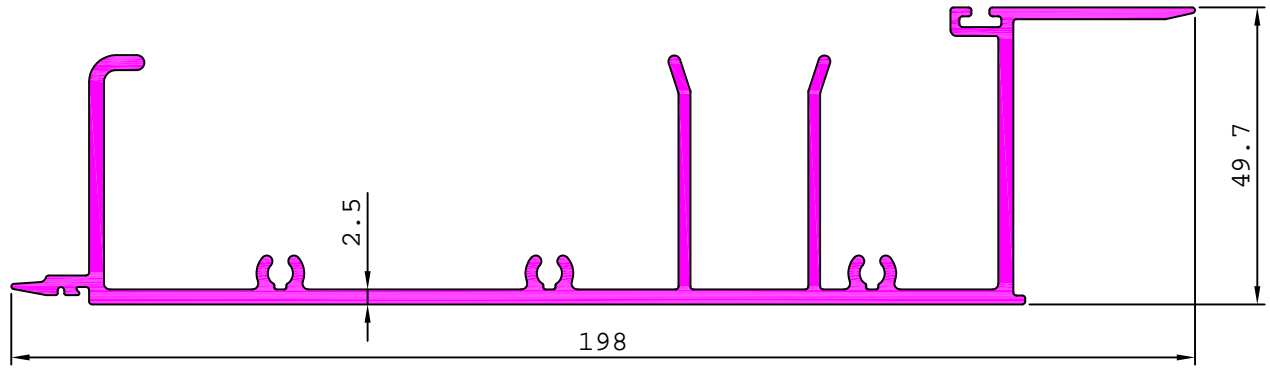

35892

4.674 kg/m

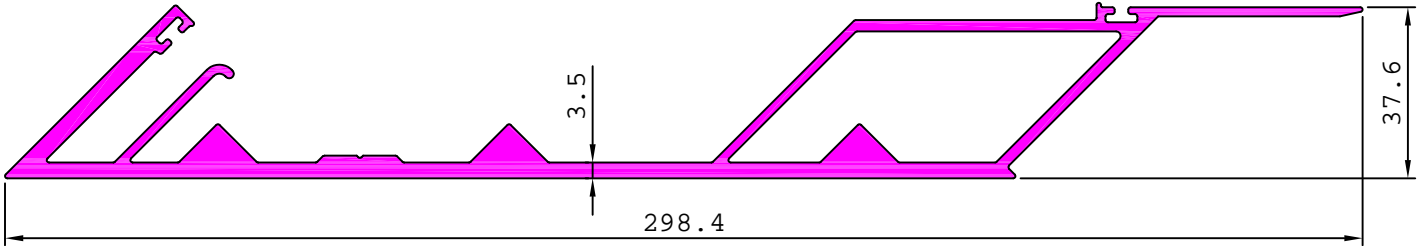

35893

4.210 kg/m

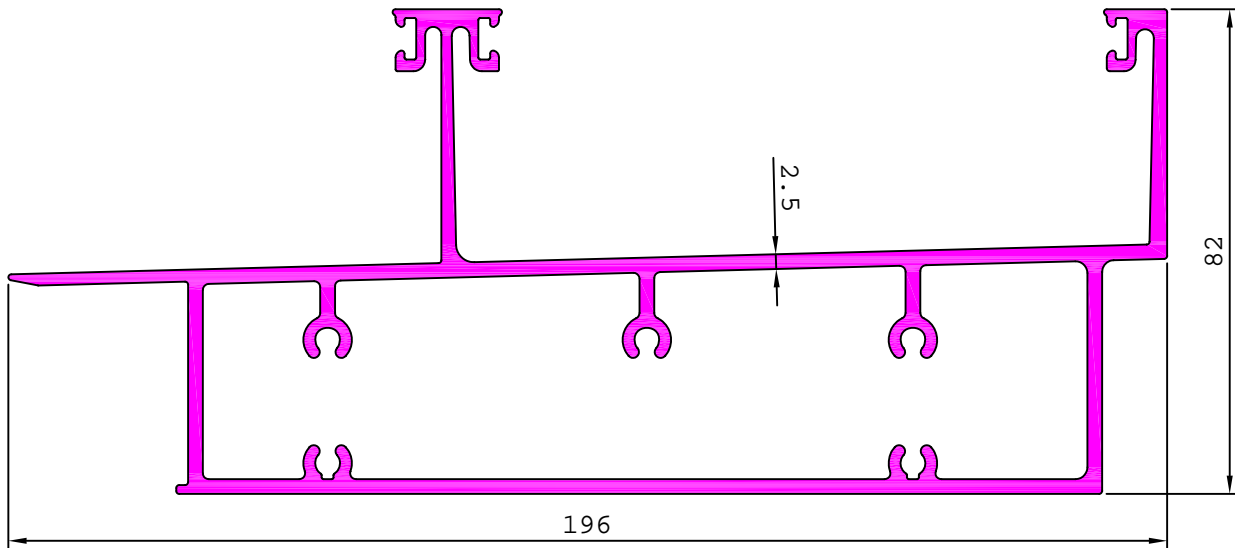

35894

5.124 kg/m

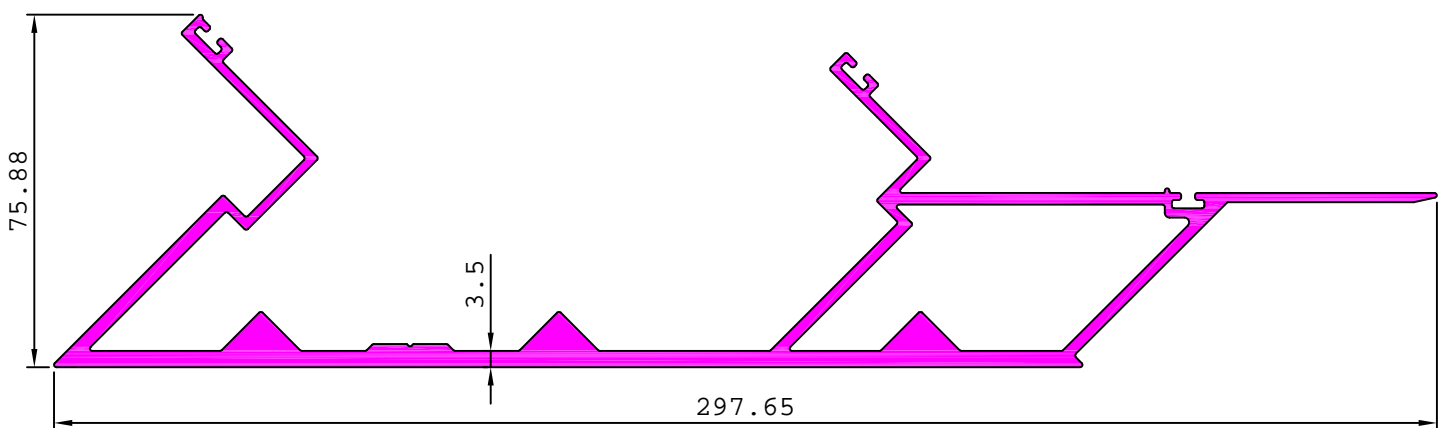

ARCHITECTURAL

CURTAIN WALL SECTION

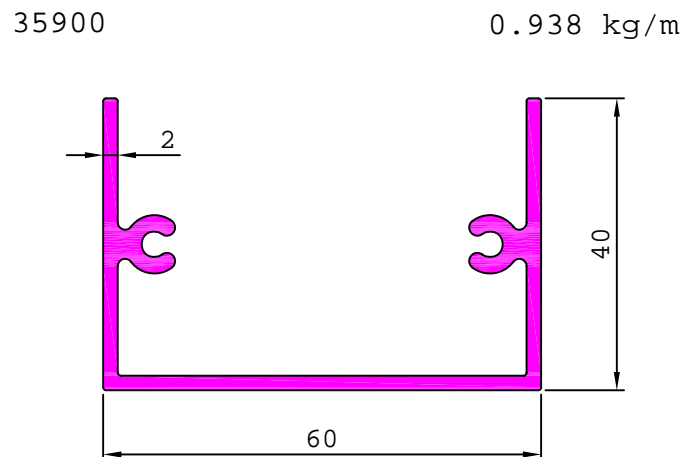
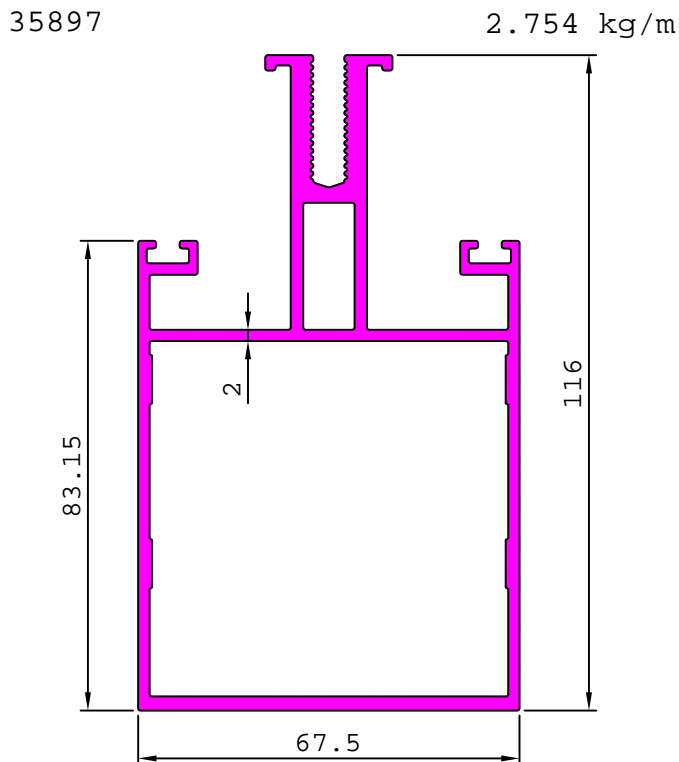
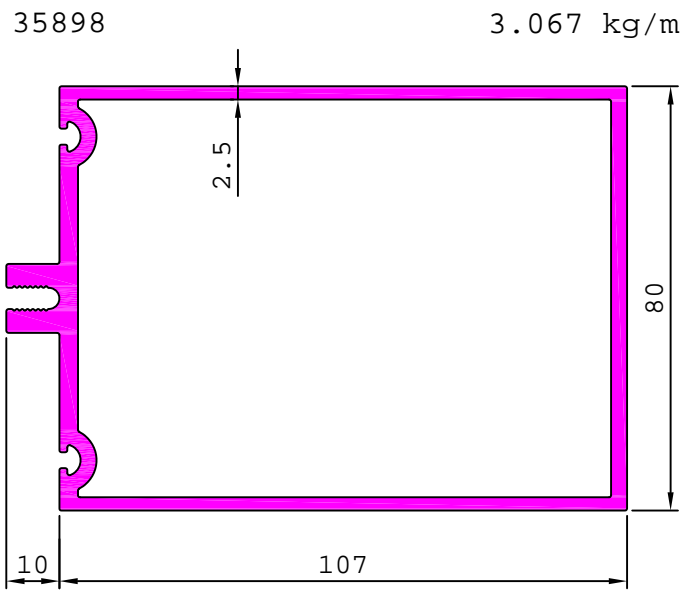
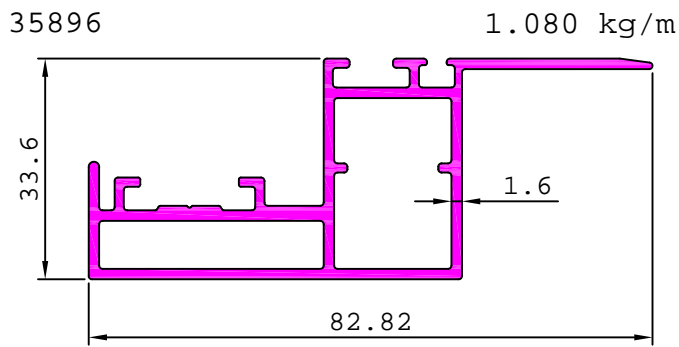
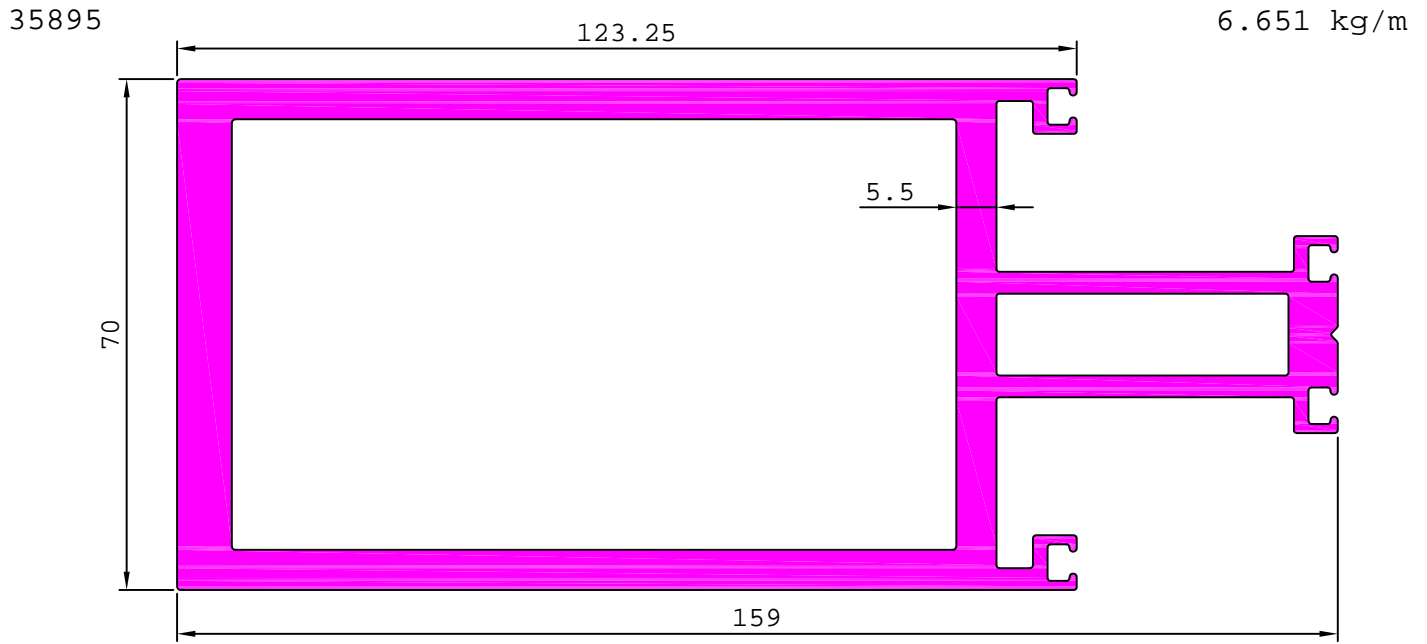

ARCHITECTURAL

CURTAIN WALL SECTION

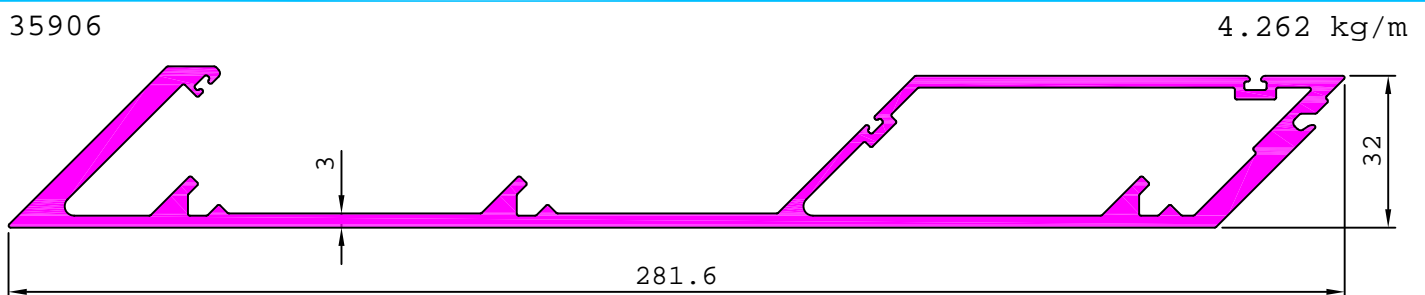
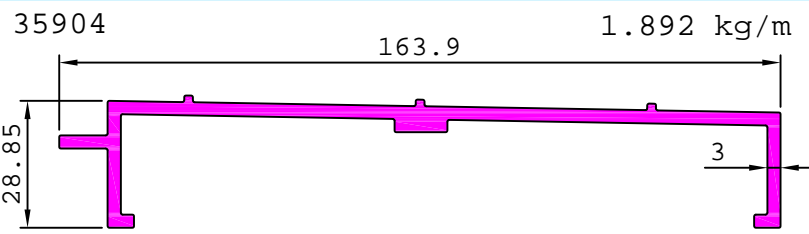
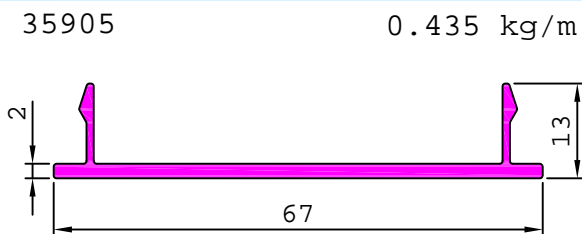
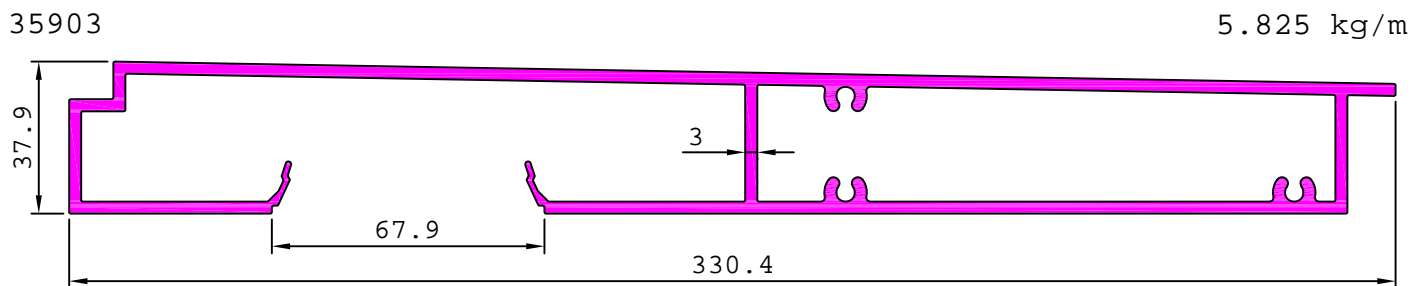
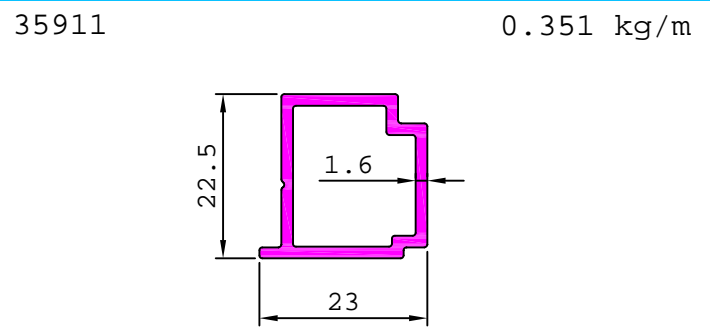
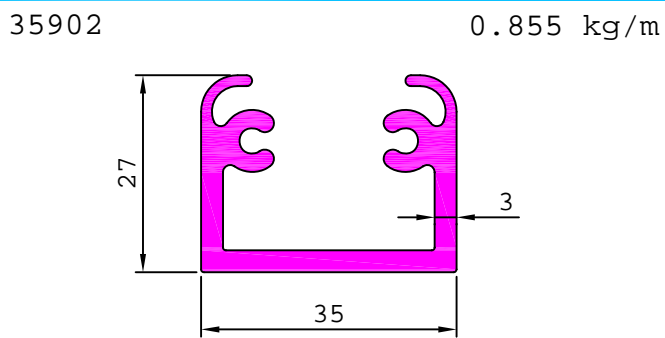
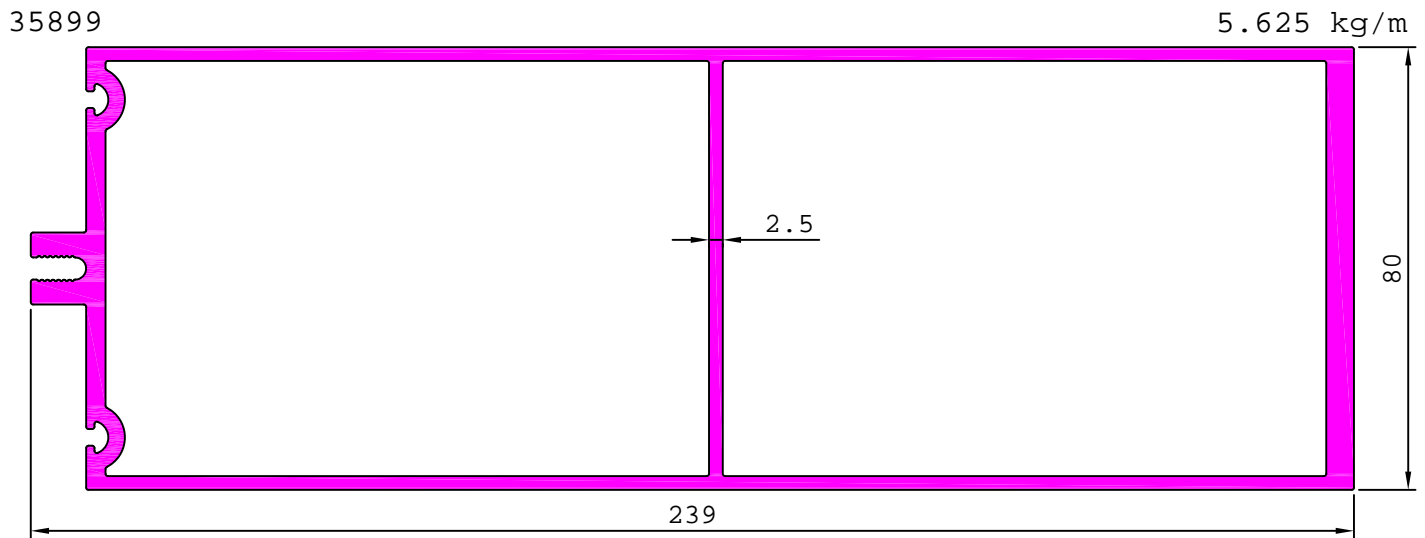

ARCHITECTURAL

CURTAIN WALL SECTION

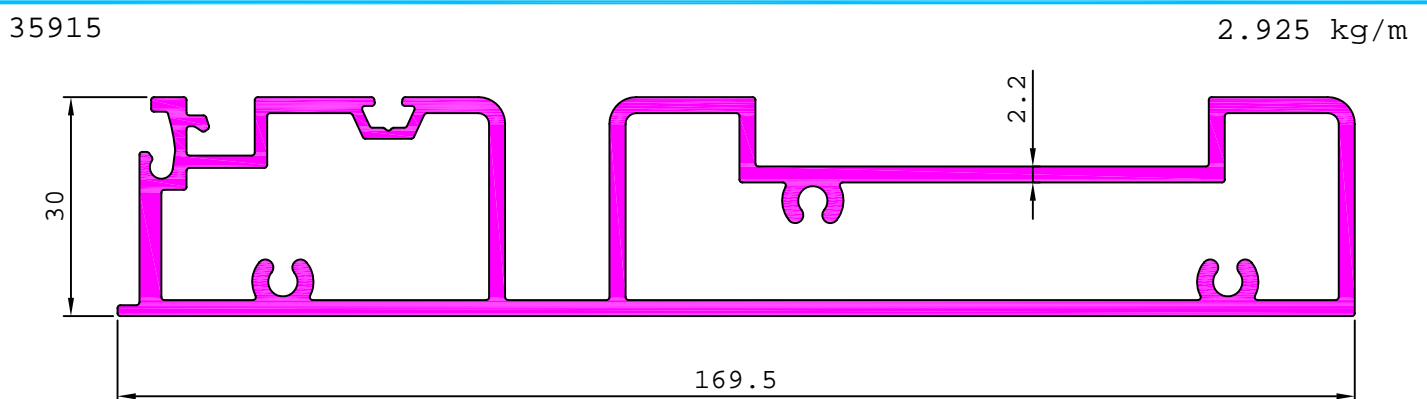
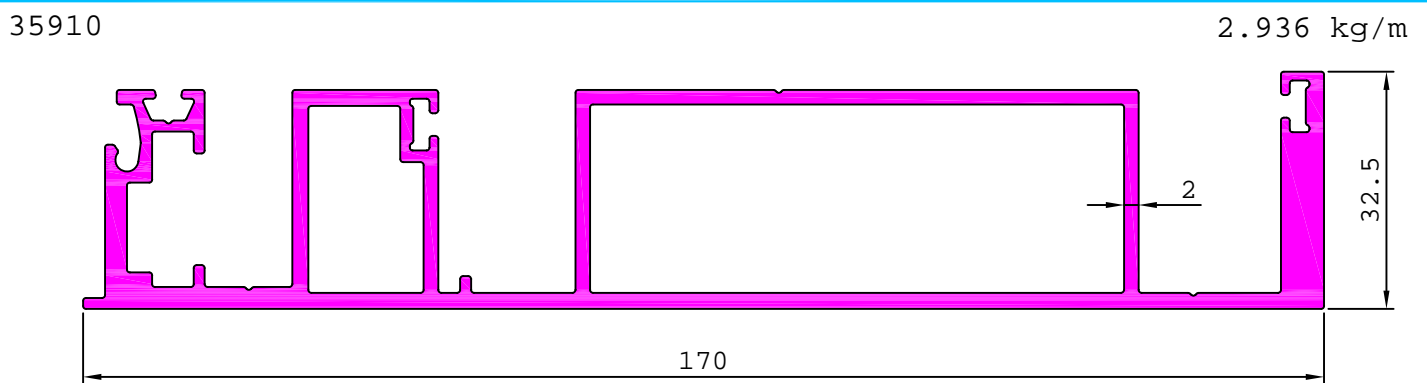
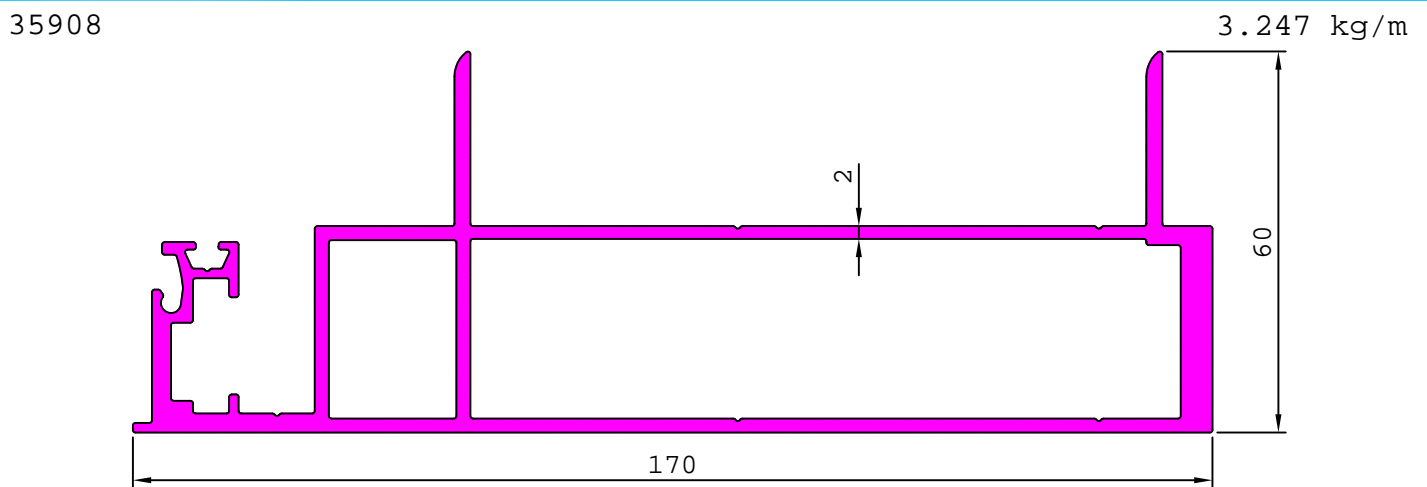
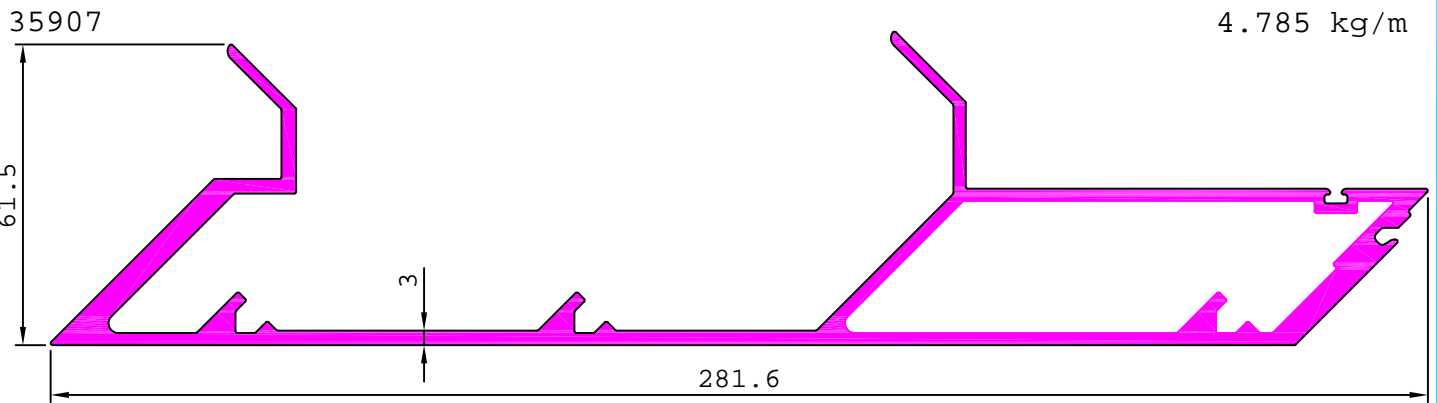

ARCHITECTURAL

CURTAIN WALL SECTION

35912

3.870 kg/m

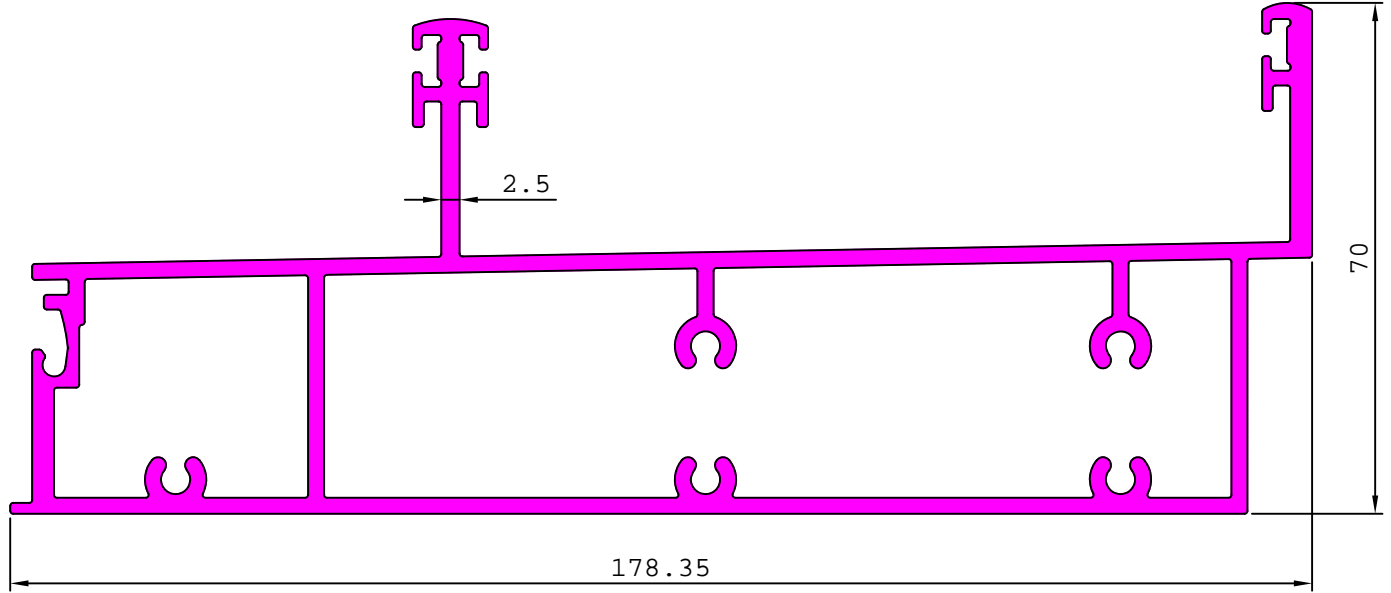

35913

1.491 kg/m

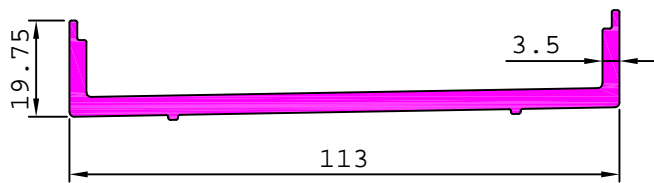

35914

0.372 kg/m

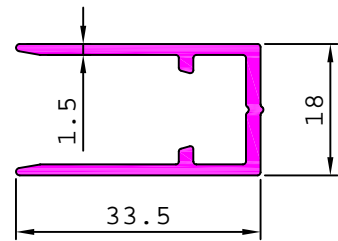

35916

2.379 kg/m

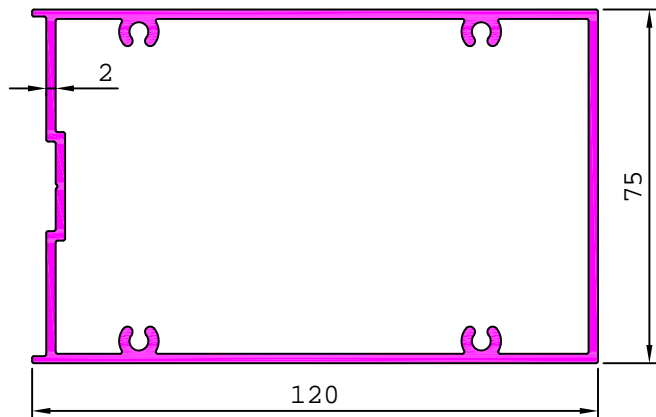

35918

1.202 kg/m

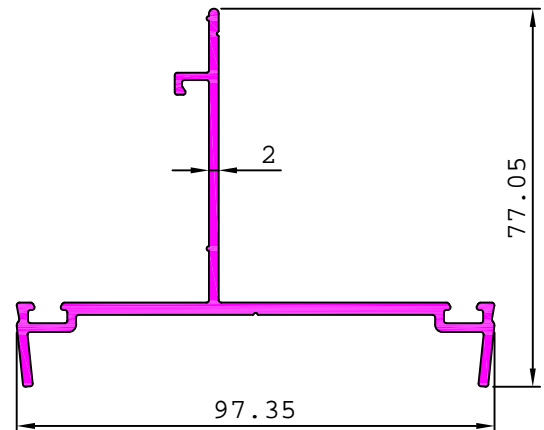

35919

0.835 kg/m

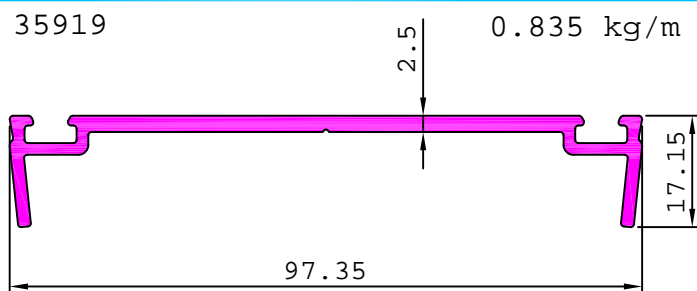

35922

3.331 kg/m

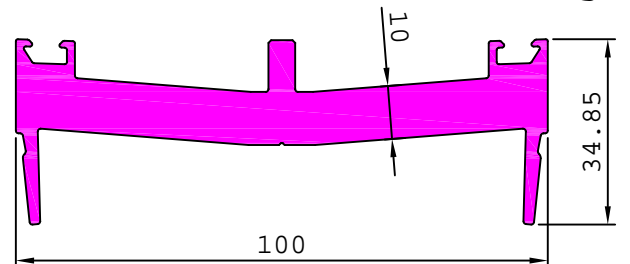

ARCHITECTURAL

CURTAIN WALL SECTION

35917

1.742 kg/m

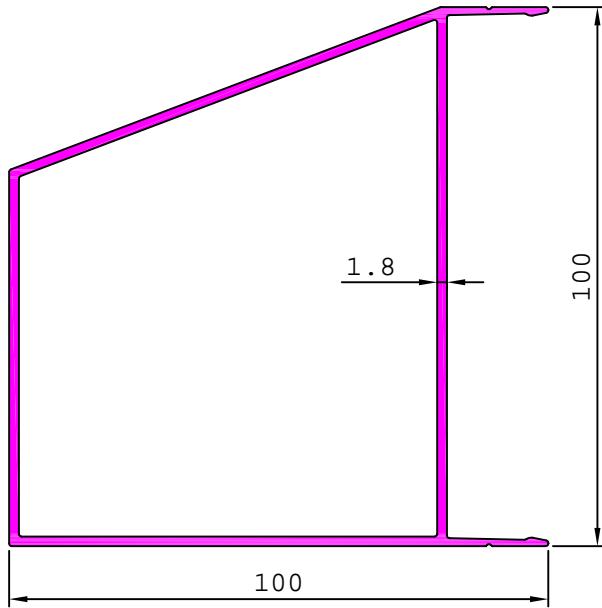

35921

1.093 kg/m

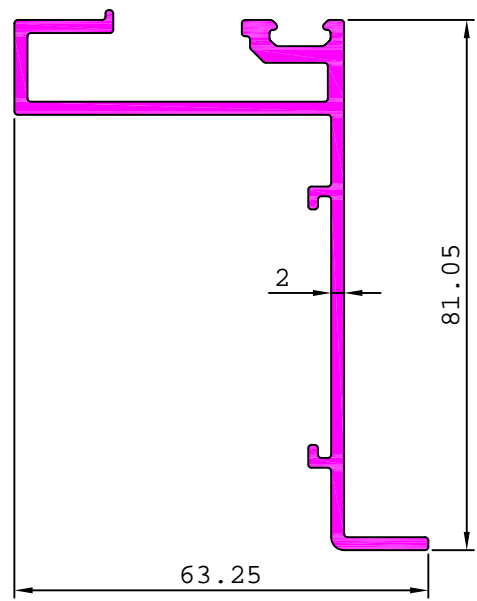

35923

6.941 kg/m

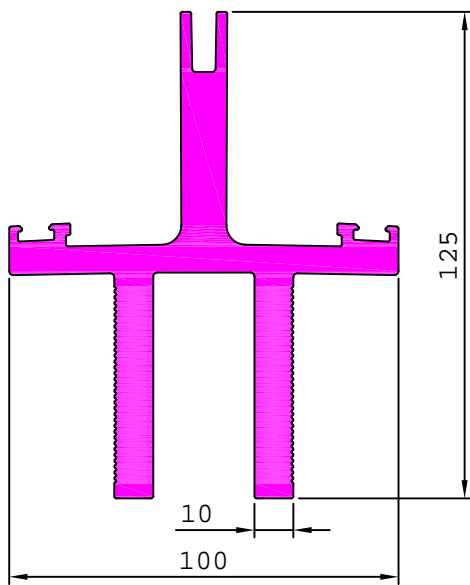

35925

0.616 kg/m

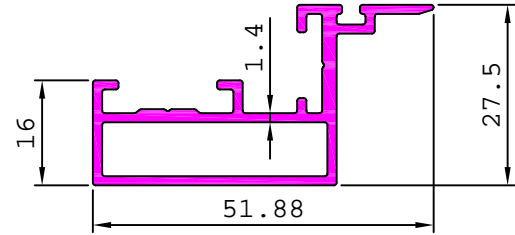

35926

1.027 kg/m

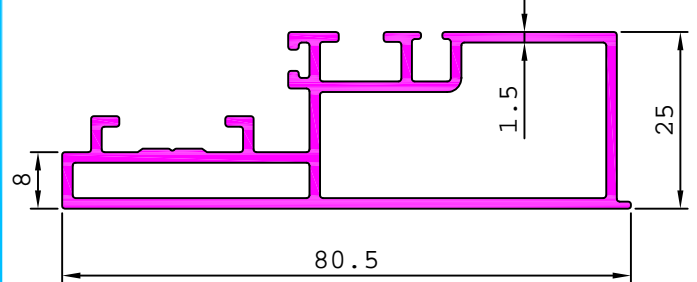

35924

135

3.854 kg/m

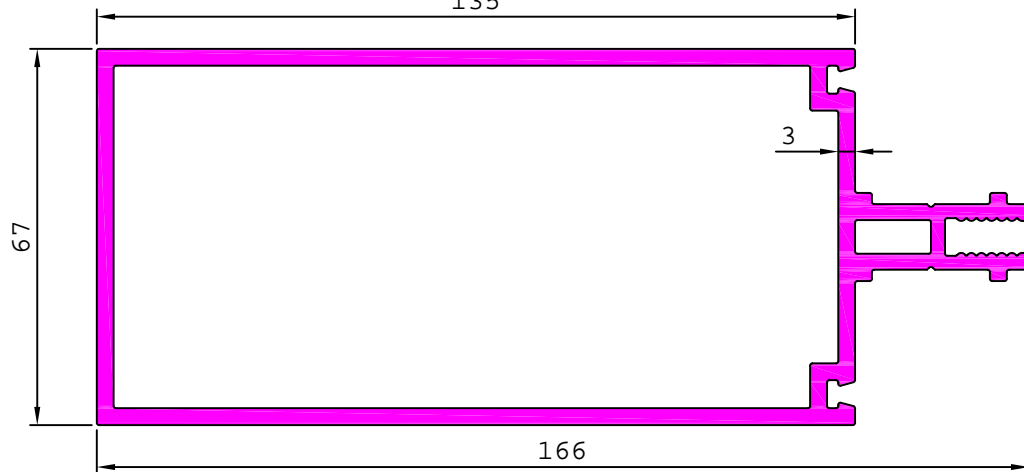

ARCHITECTURAL

CURTAIN WALL SECTION

35927

3.539 kg/m

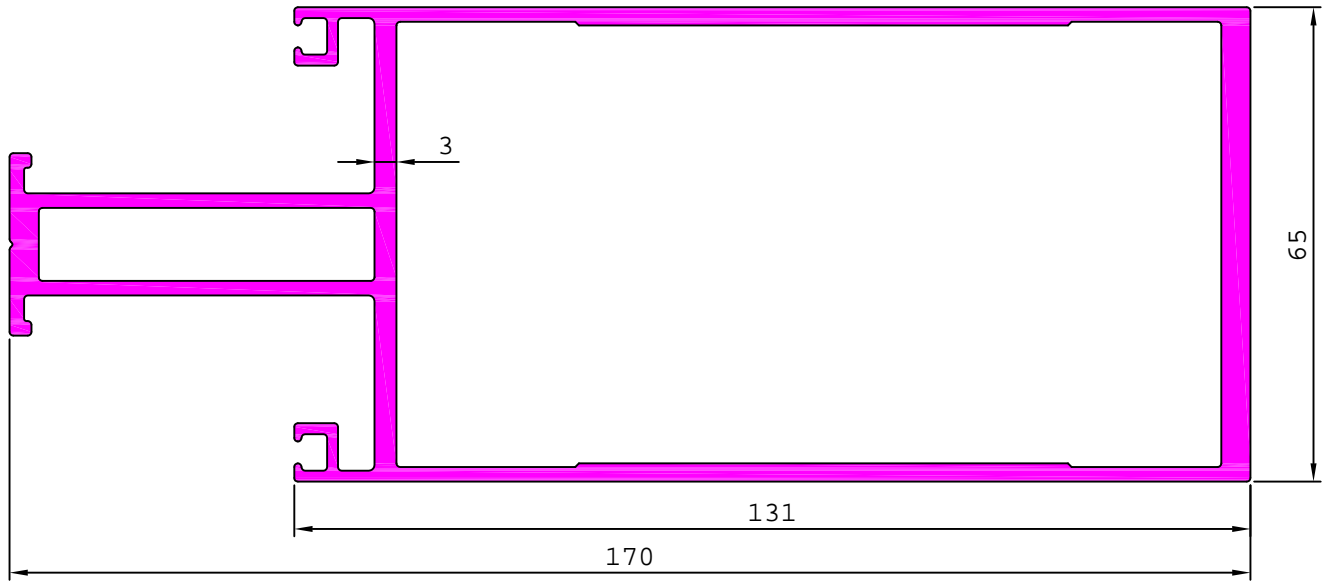

35928

2.399 kg/m

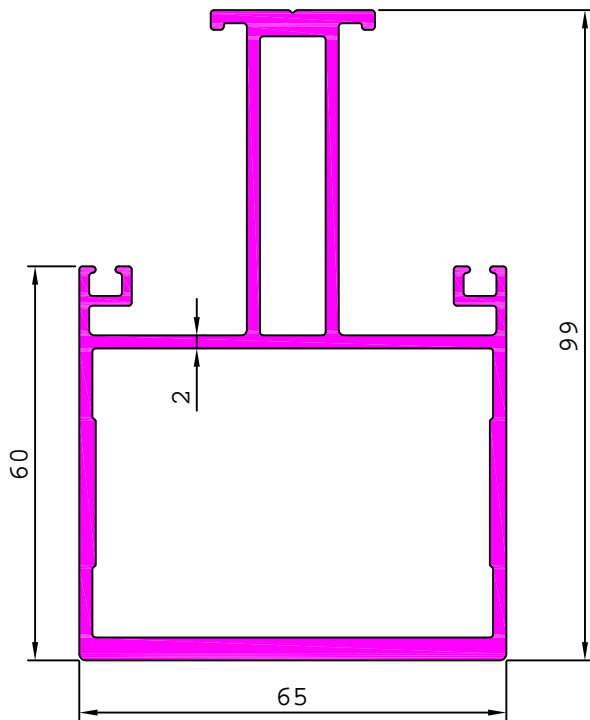

35929

1.968 kg/m

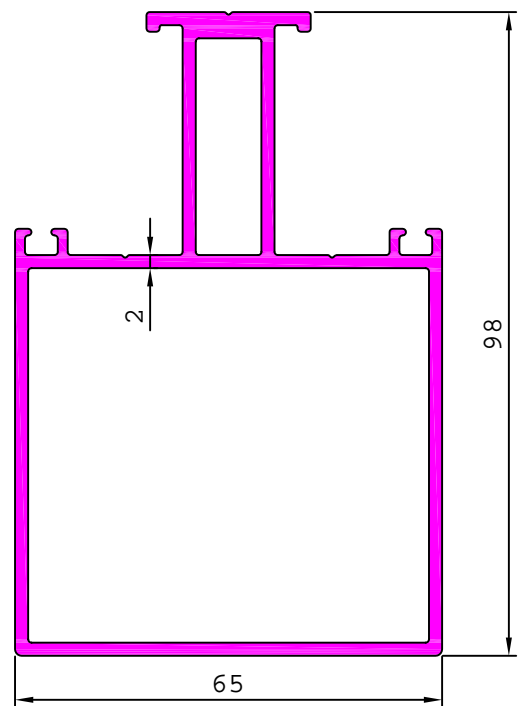

35930

1.646 kg/m

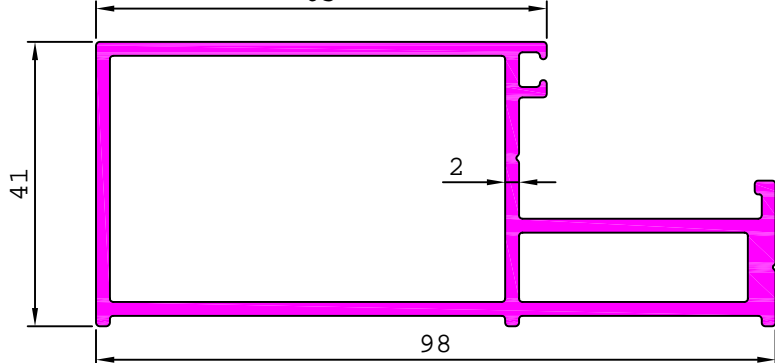

35931

0.755 kg/m

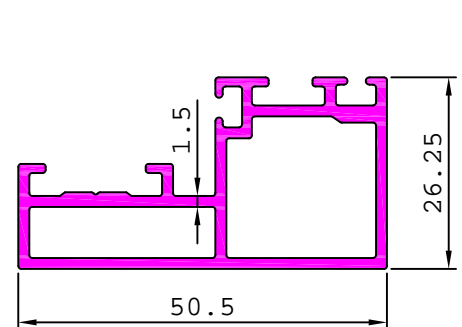

ARCHITECTURAL

CURTAIN WALL SECTION

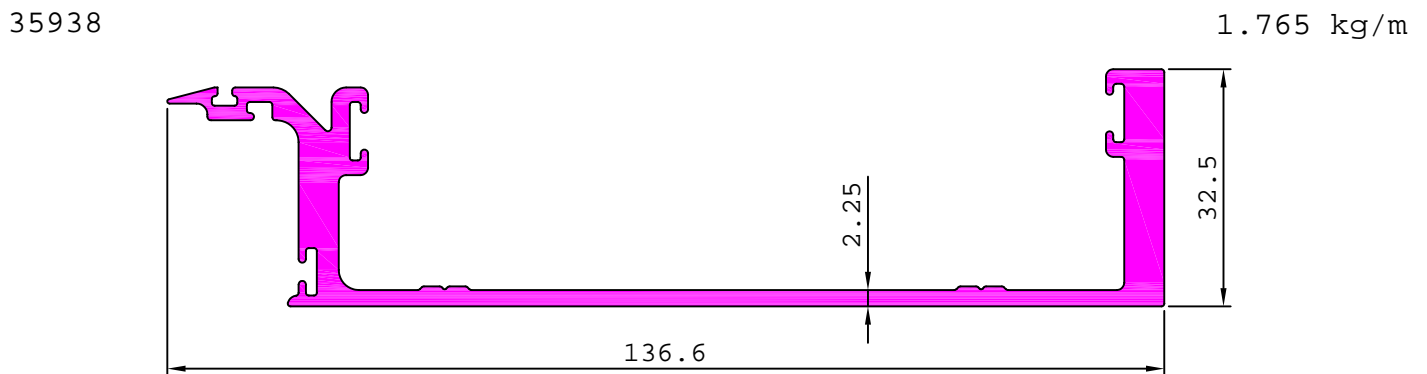
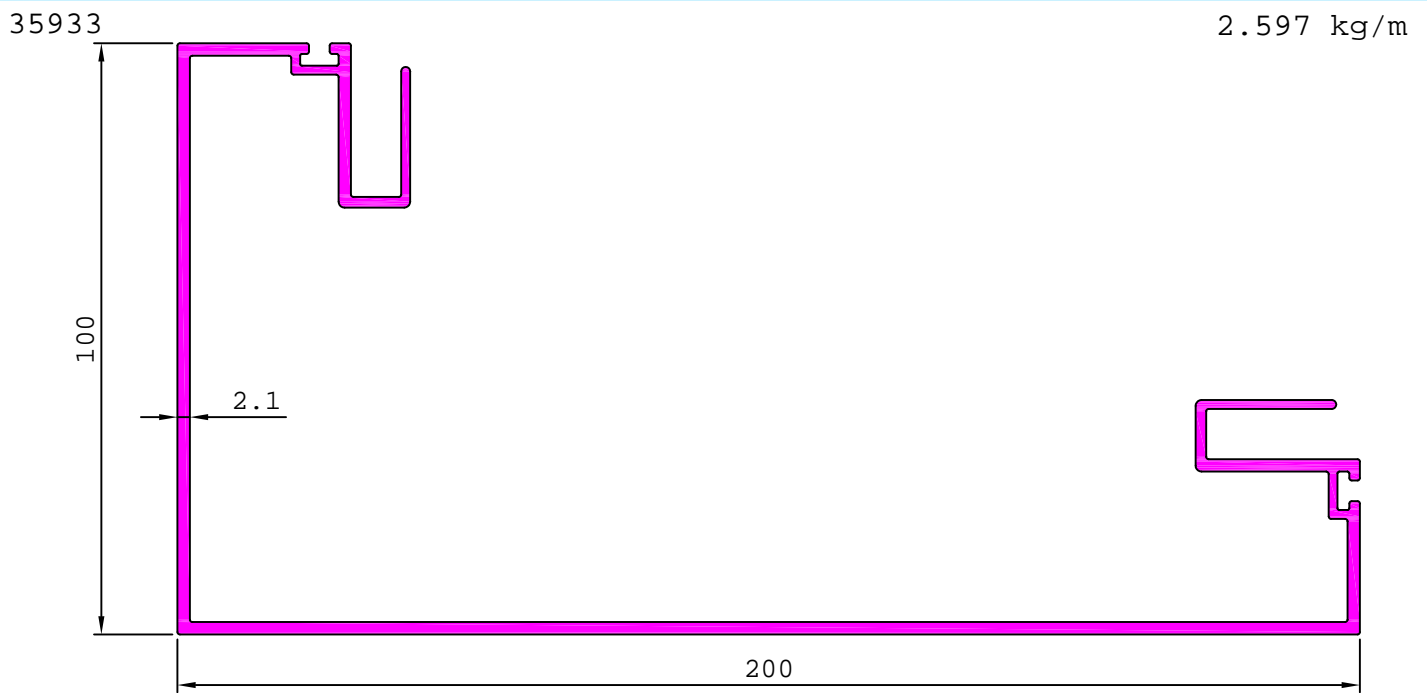
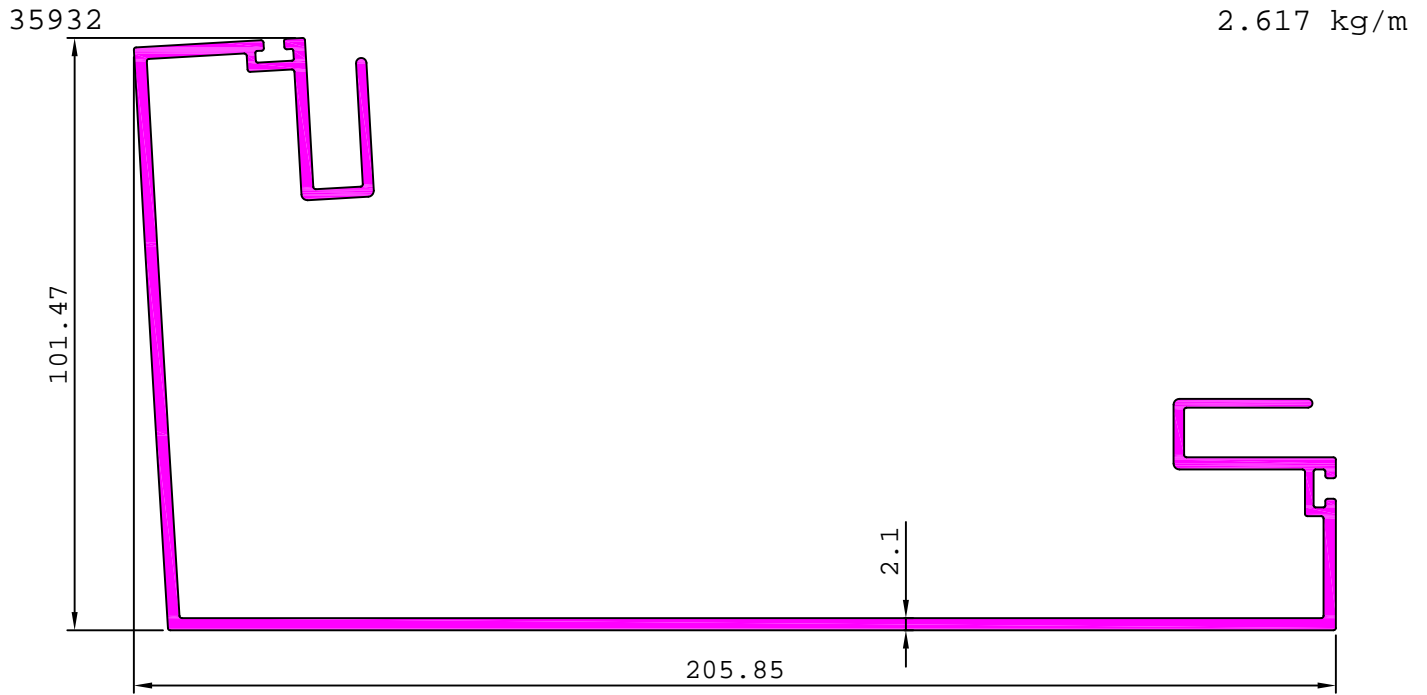

ARCHITECTURAL

CURTAIN WALL SECTION

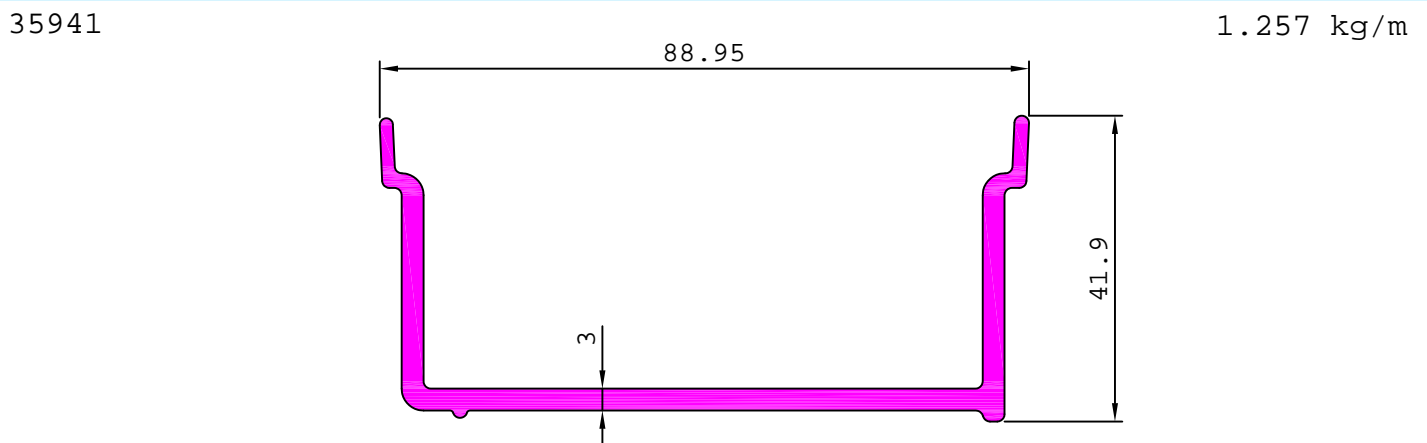
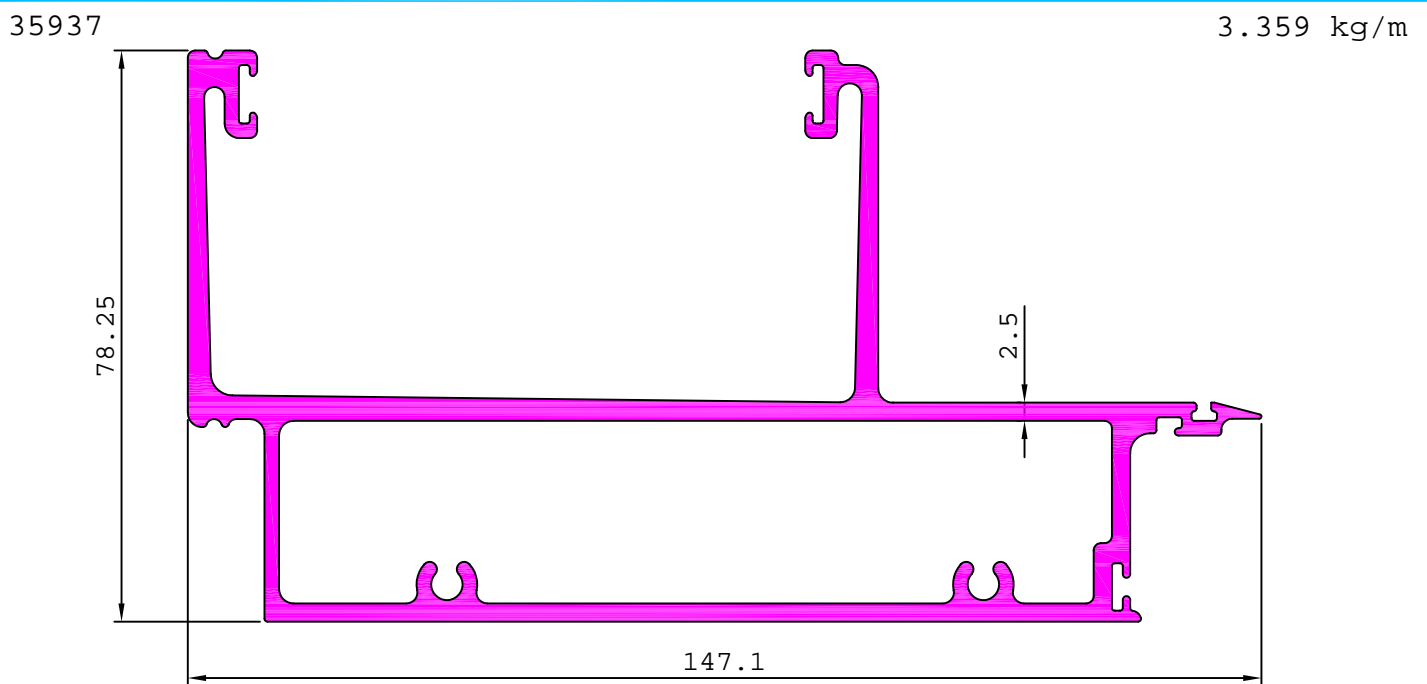
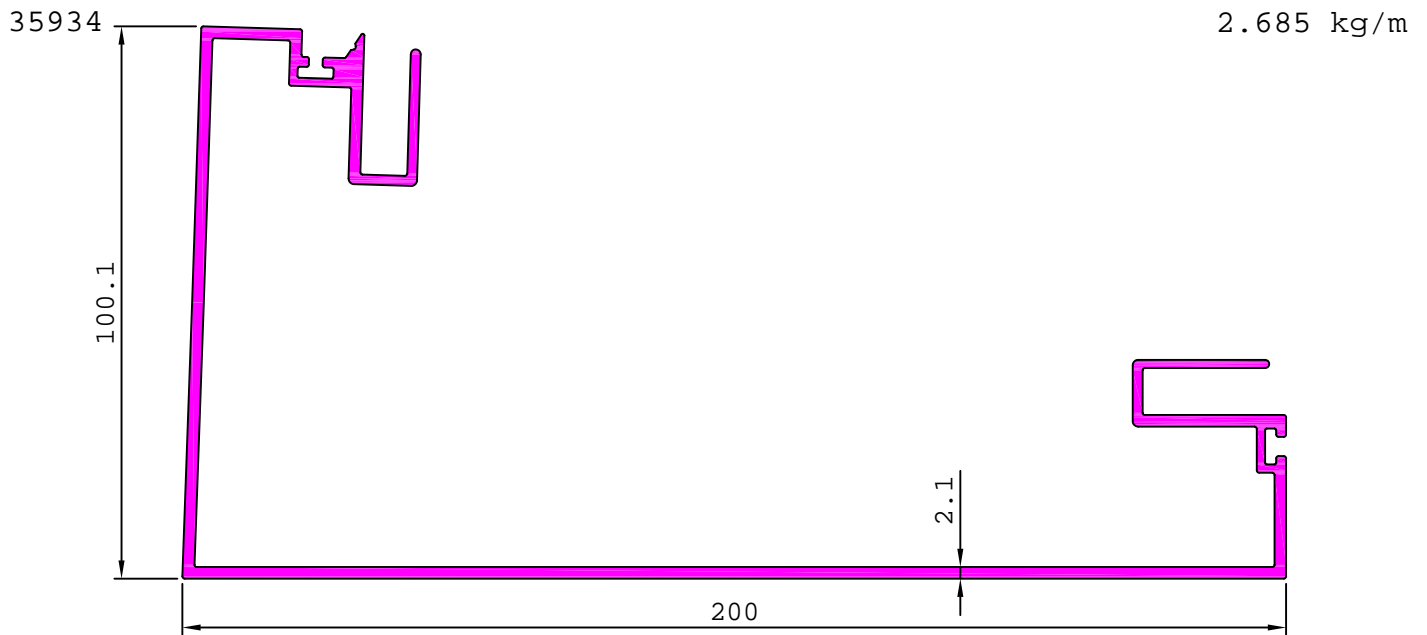

ARCHITECTURAL

CURTAIN WALL SECTION

35939

2.866 kg/m

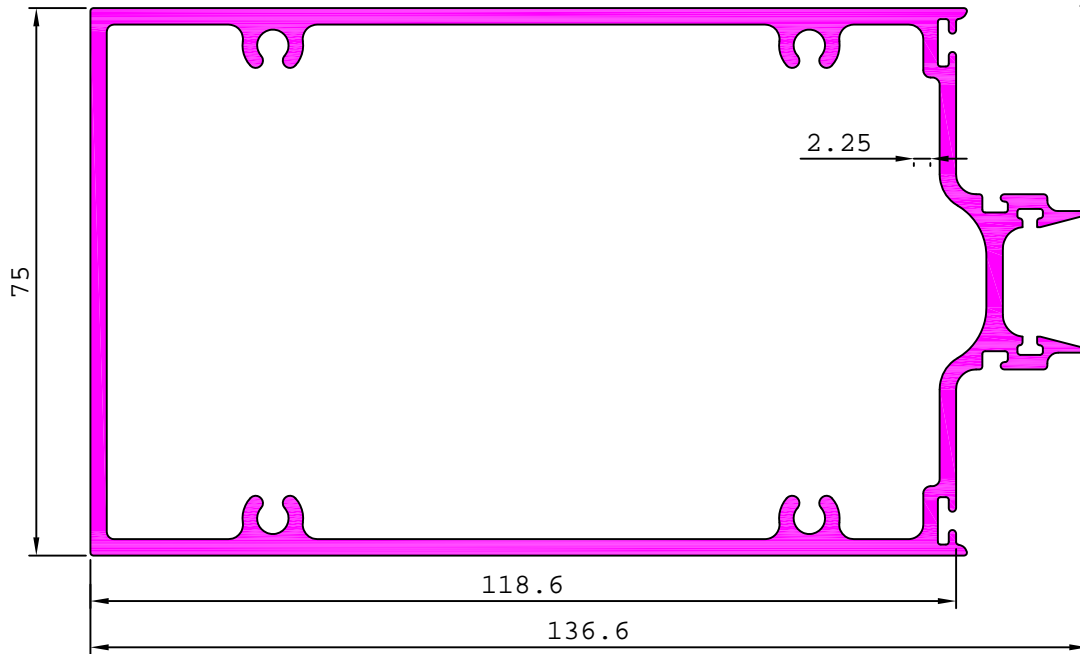

35940

2.161 kg/m

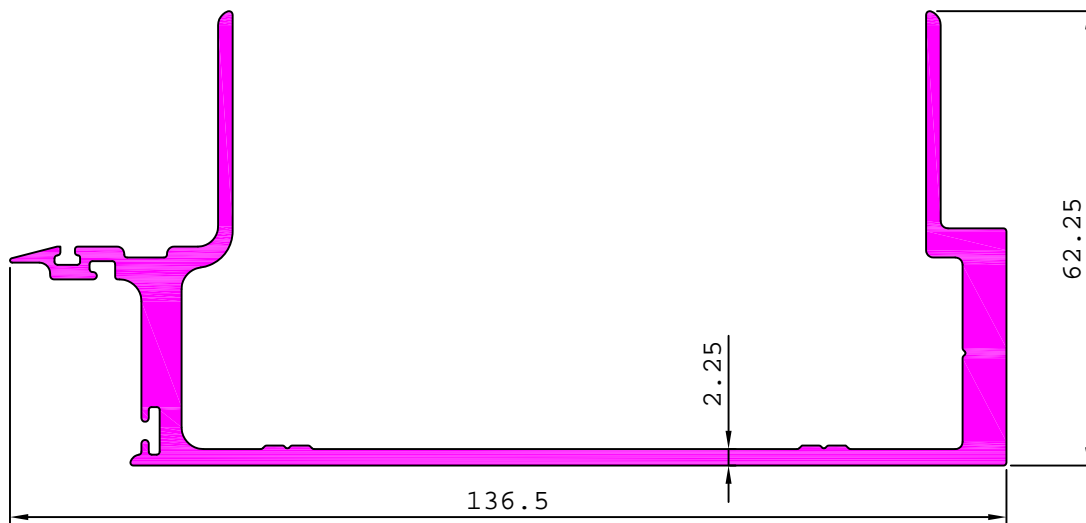

35942

2.103 kg/m

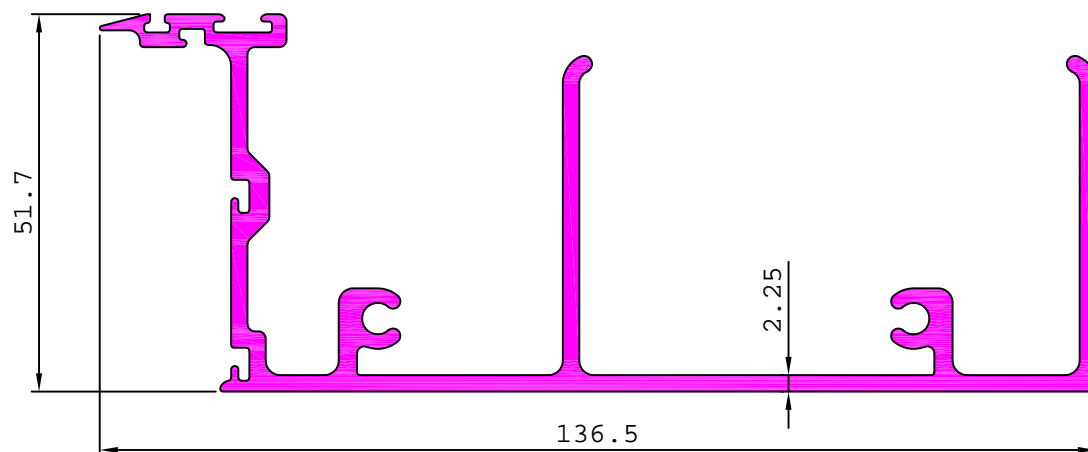

ARCHITECTURAL

CURTAIN WALL SECTION

35943

3.205 kg/m

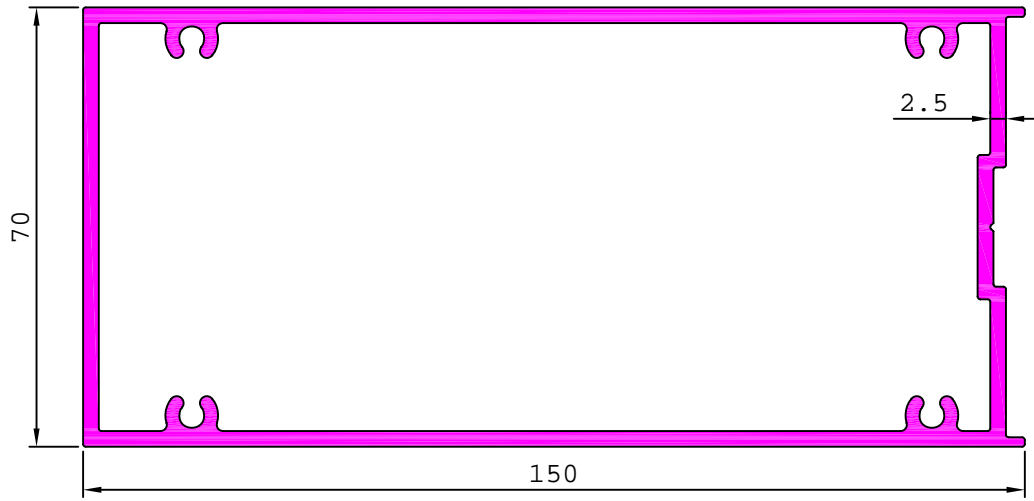

35944

2.717 kg/m

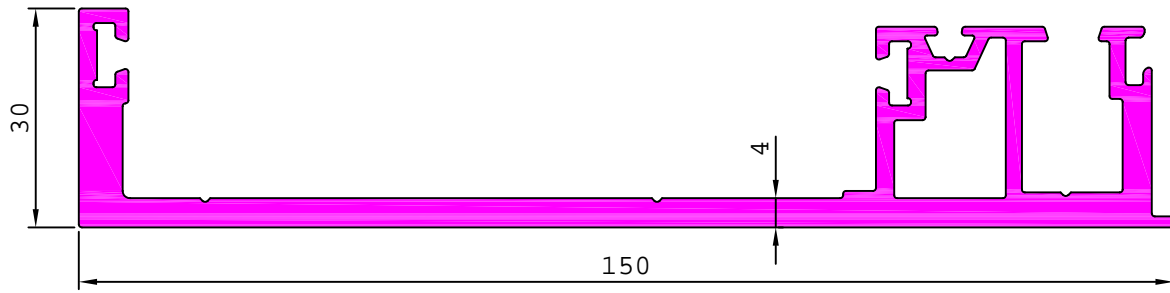

35945

3.693 kg/m

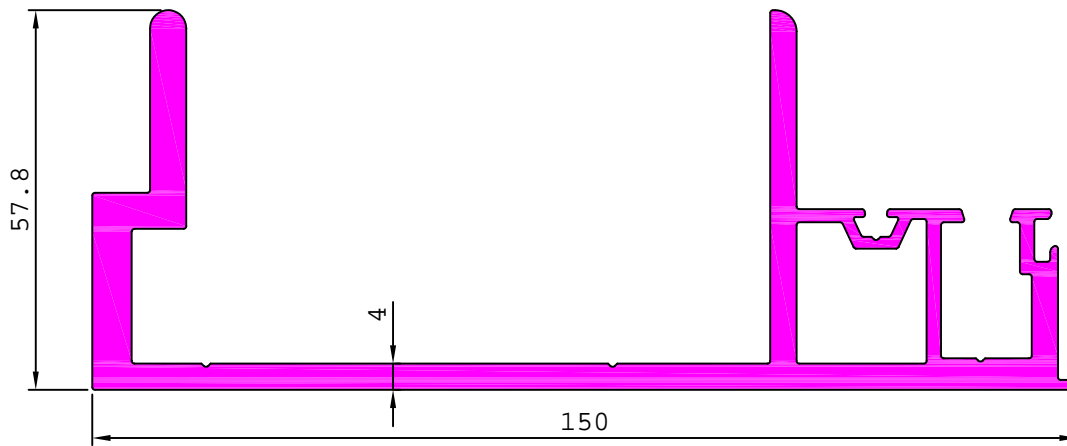

35946

2.478 kg/m

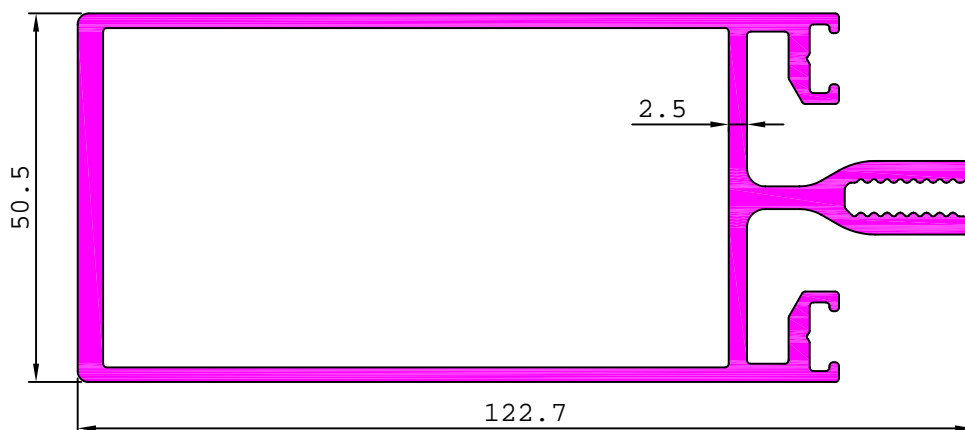

ARCHITECTURAL

CURTAIN WALL SECTION

21391 0.906 kg/m

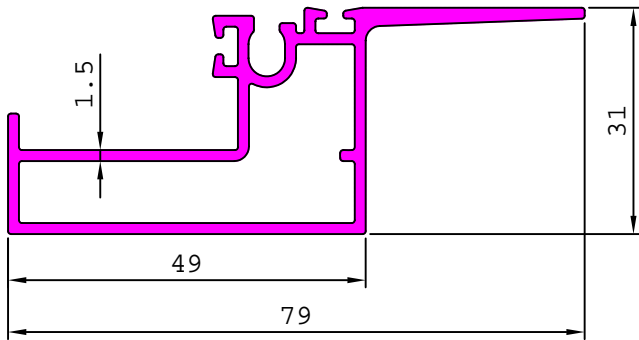

21392 0.955 kg/m

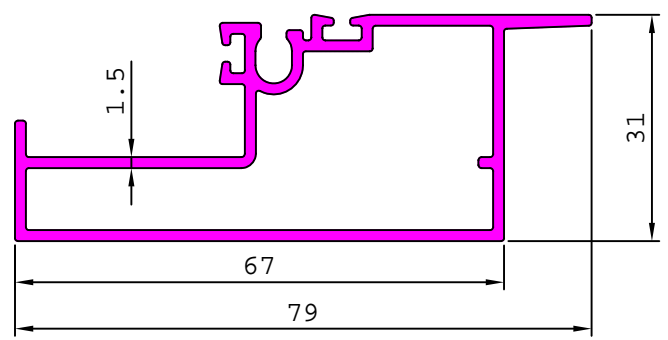

21471 0.957 kg/m

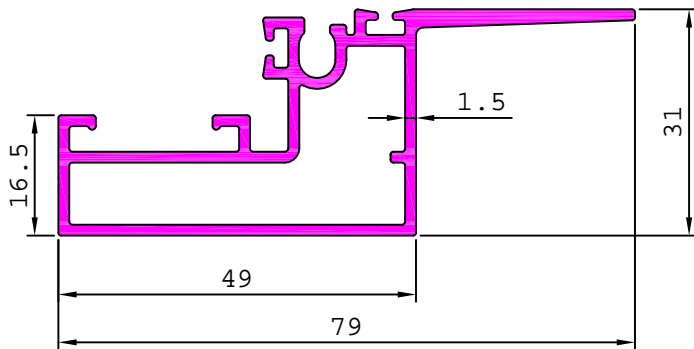

S4527 0.921 kg/m

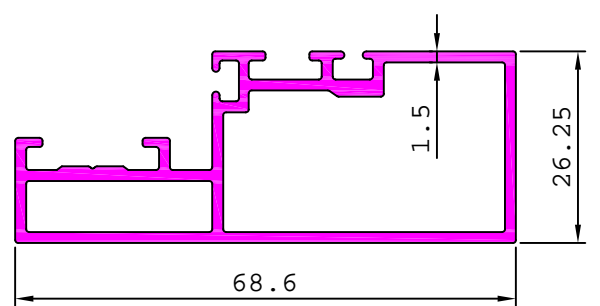

S4235 5.500 kg/m

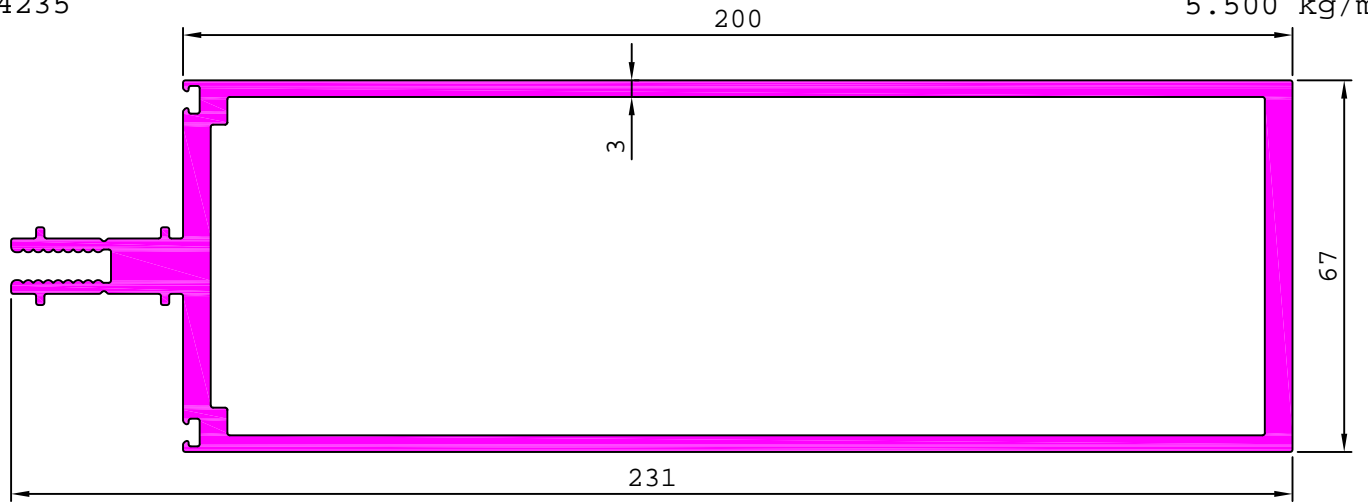

S4452 3.560 kg/m

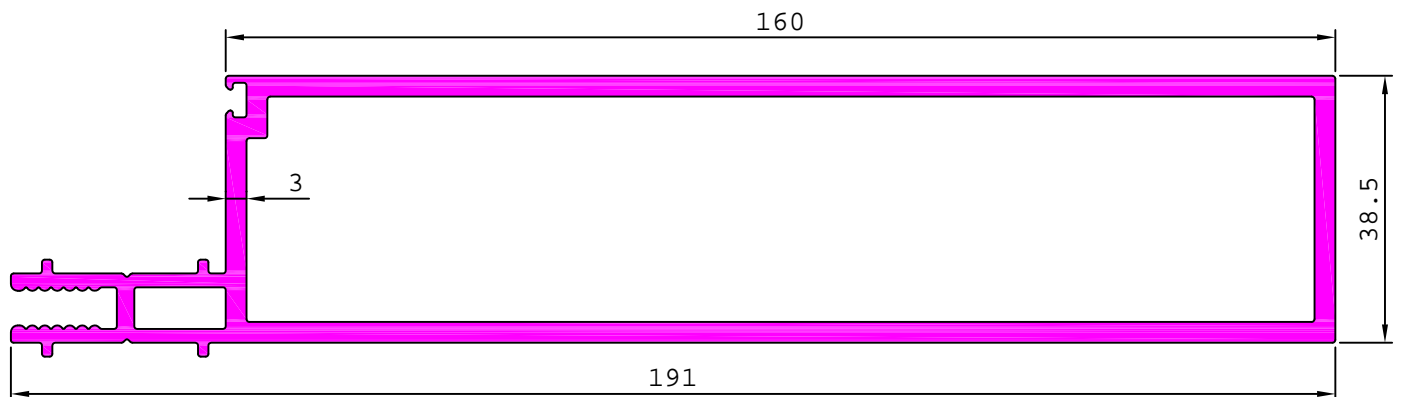

ARCHITECTURAL

CURTAIN WALL SECTION

S3841

6.043 kg/m

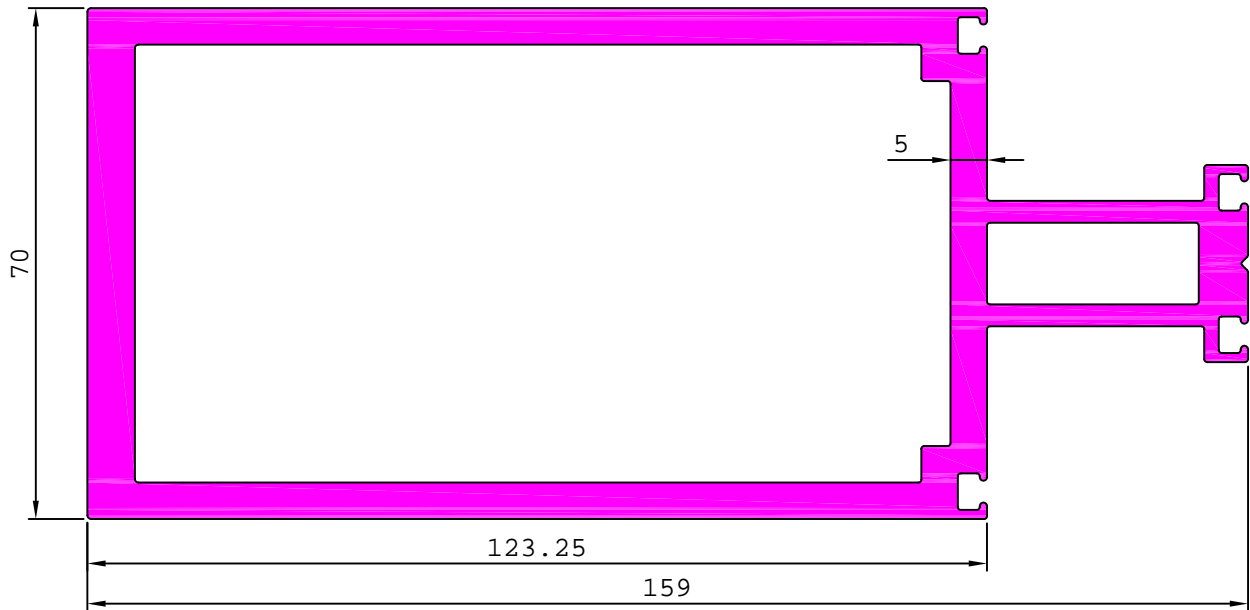

S4236

6.570 kg/m



S4451

4.365 kg/m

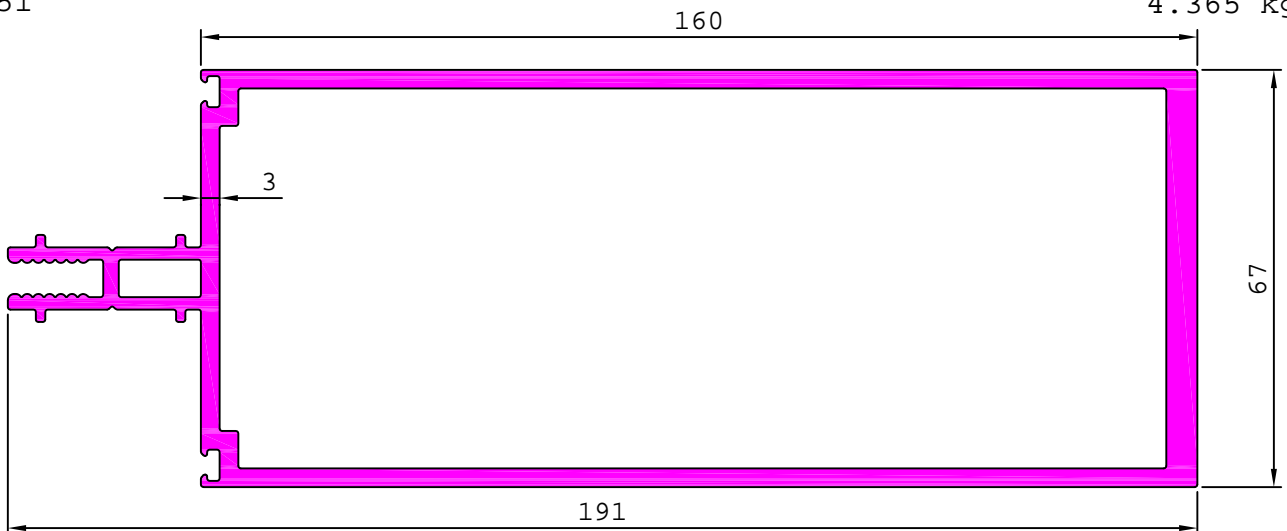

ARCHITECTURAL

CURTAIN WALL SECTION

S4505

3.654 kg/m

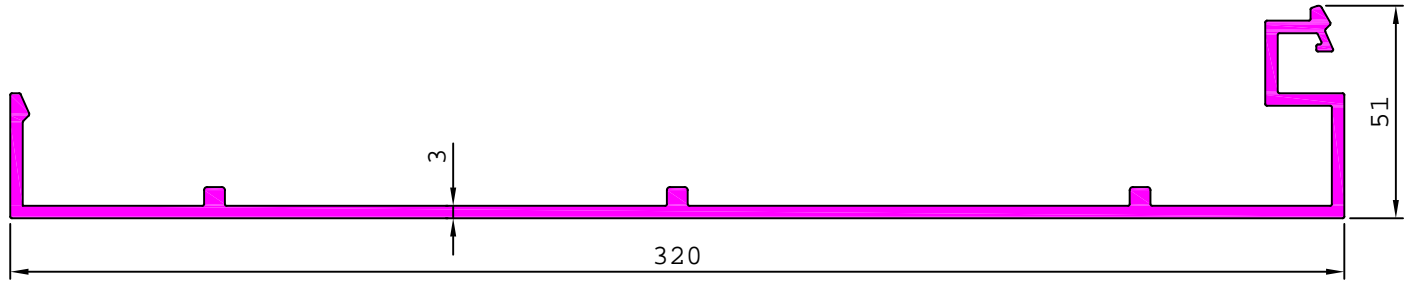

S4506

2.515 kg/m

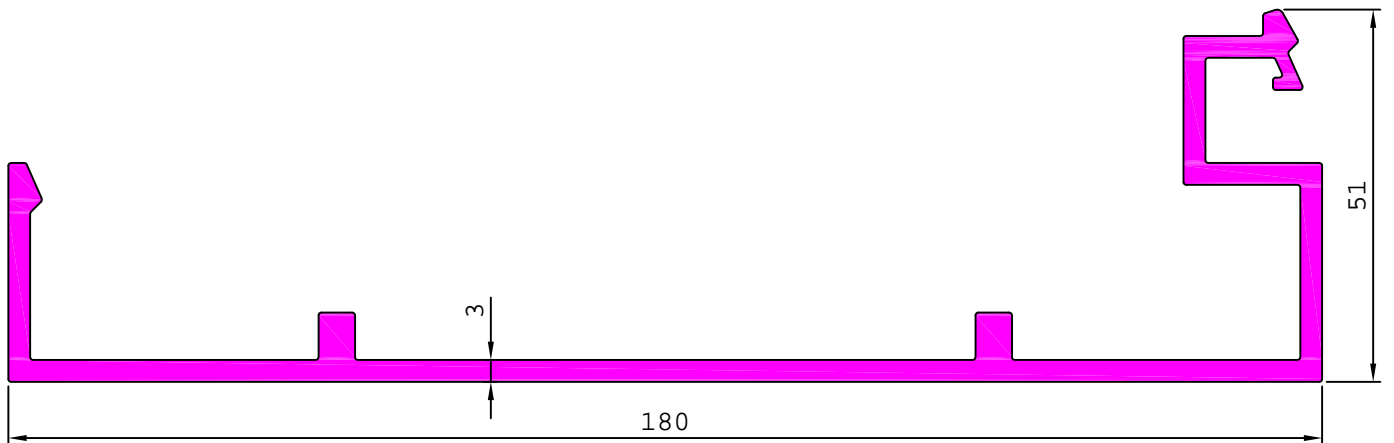

S4529

1.813 kg/m

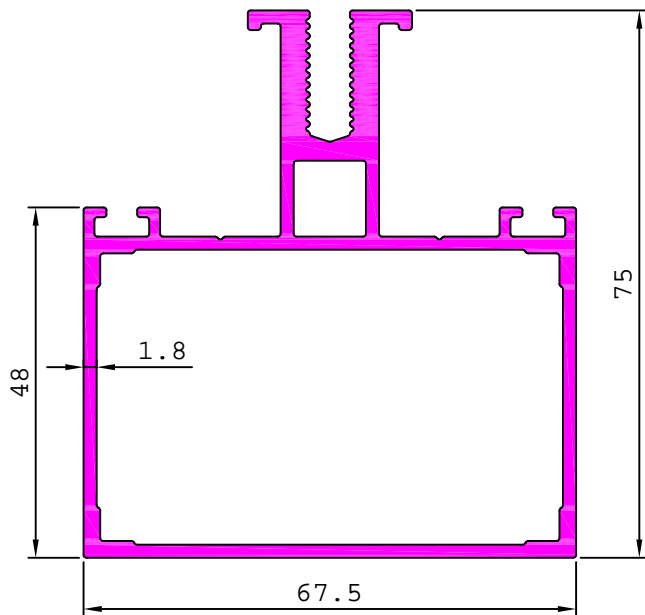

S4562

1.875 kg/m

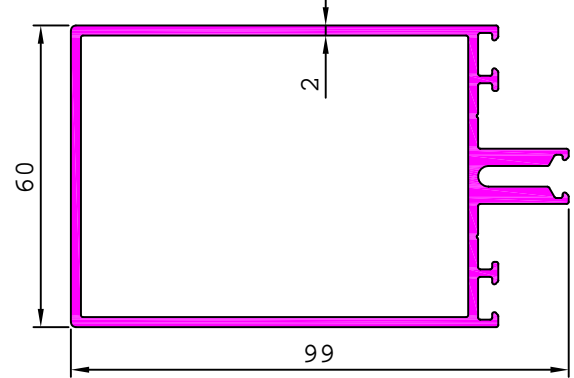

S4603

1.133 kg/m

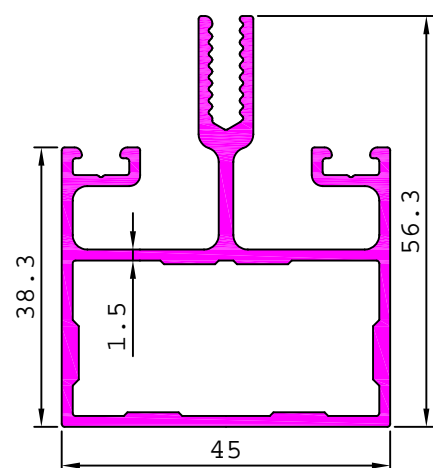

S4604

0.822 kg/m

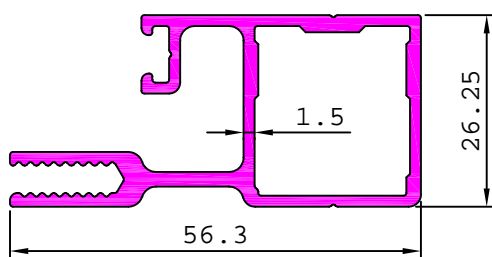

ARCHITECTURAL

CURTAIN WALL SECTION

S4537

9.413 kg/m

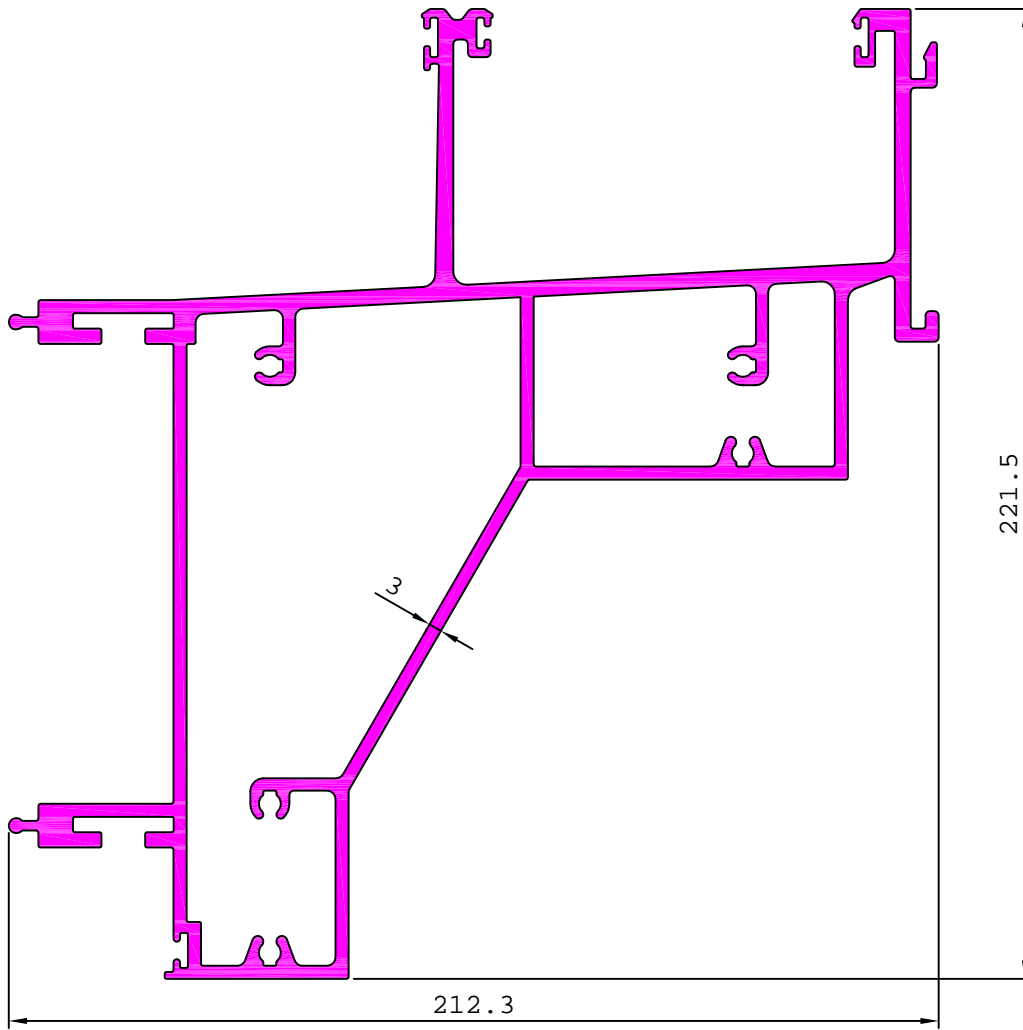

S4645

2.529 kg/m

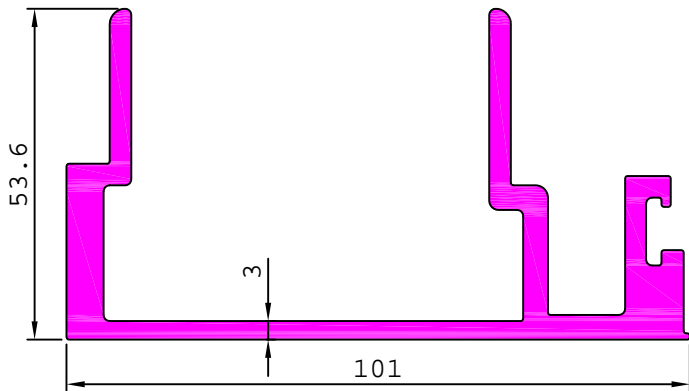

S4646

1.879 kg/m

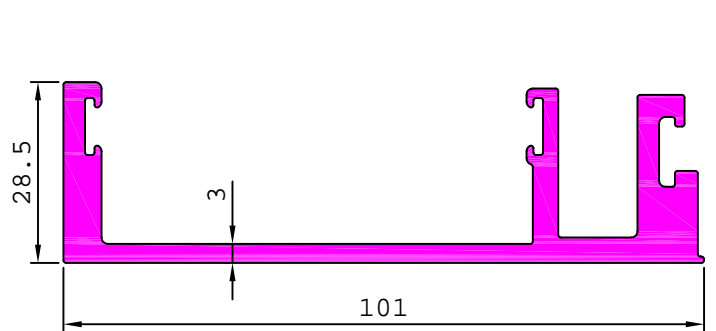

S4647

0.509 kg/m

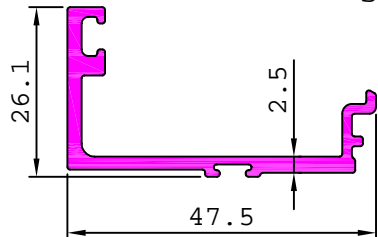

S4650

0.301 kg/m

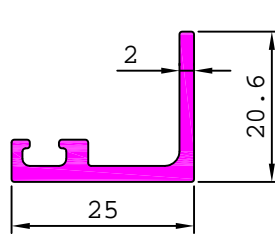

S4651

0.294 kg/m

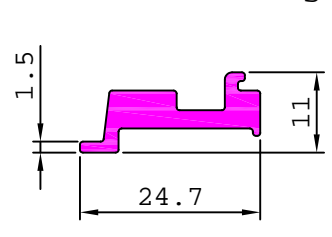

ARCHITECTURAL

CURTAIN WALL SECTION

S4648

2.755 kg/m

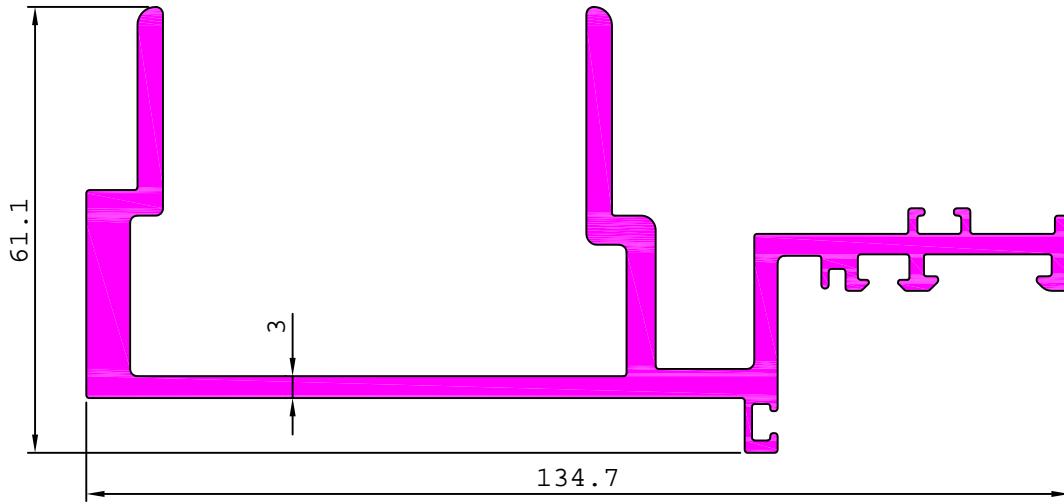

S4649

2.104 kg/m

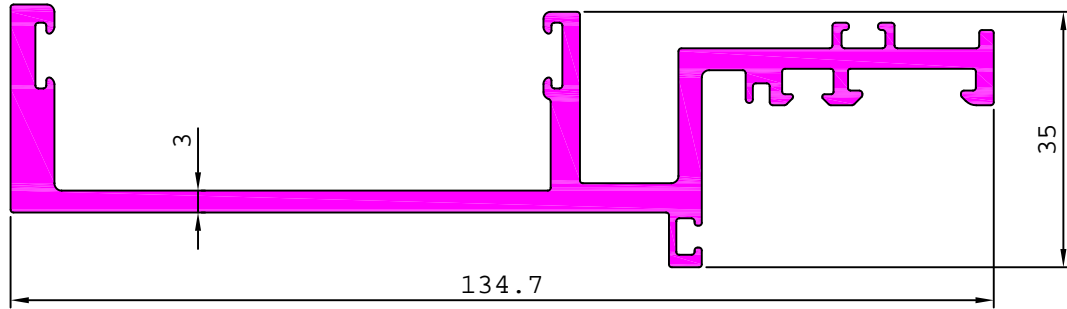

S4652

0.280 kg/m

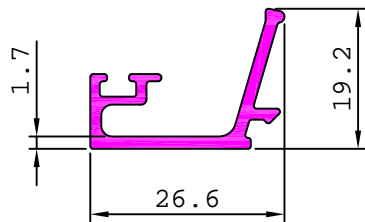

S4657

0.900 kg/m

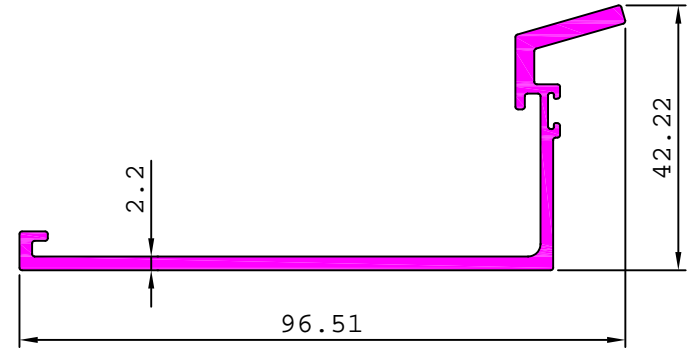

S4654

2.148 kg/m

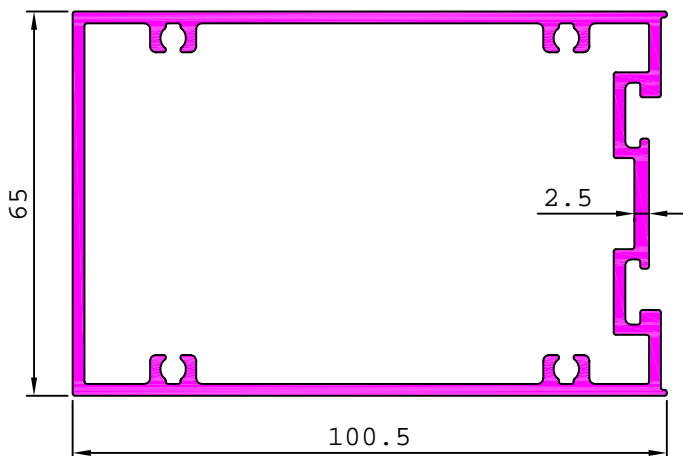

S4658

1.844 kg/m

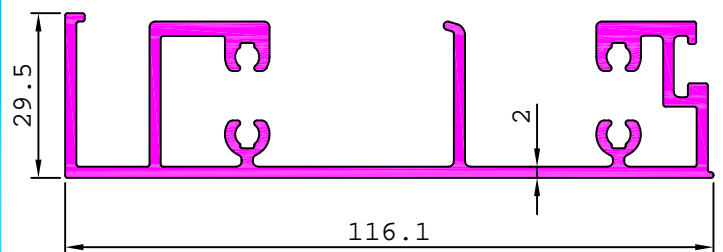

ARCHITECTURAL

CURTAIN WALL SECTION

S4655

3.574 kg/m

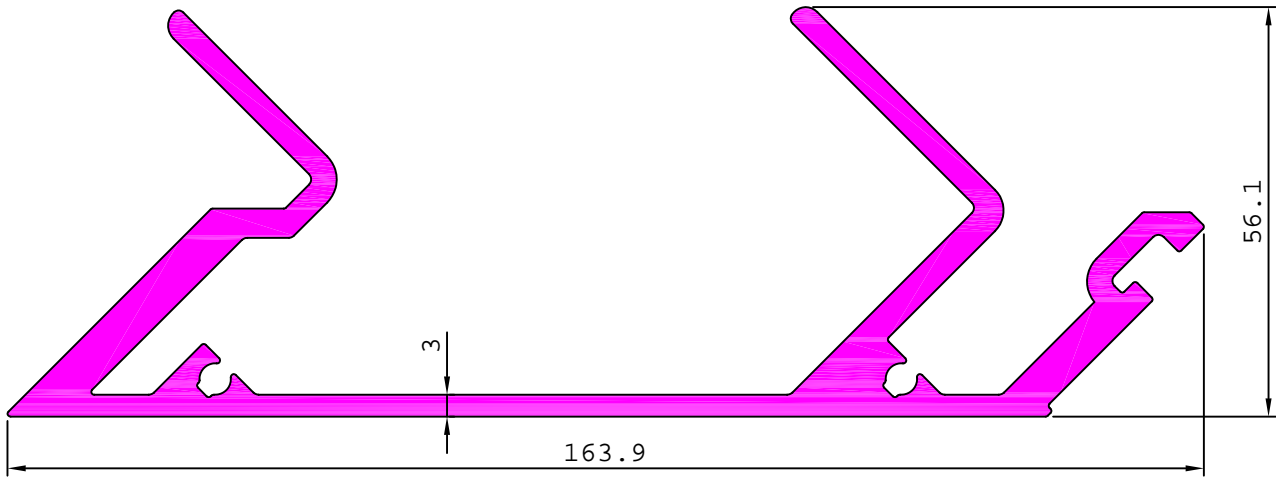

S4660

2.661 kg/m

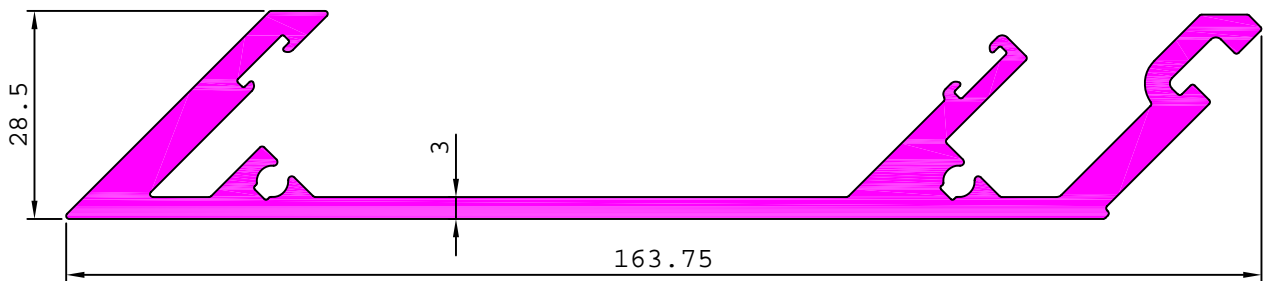

S4659

2.722 kg/m

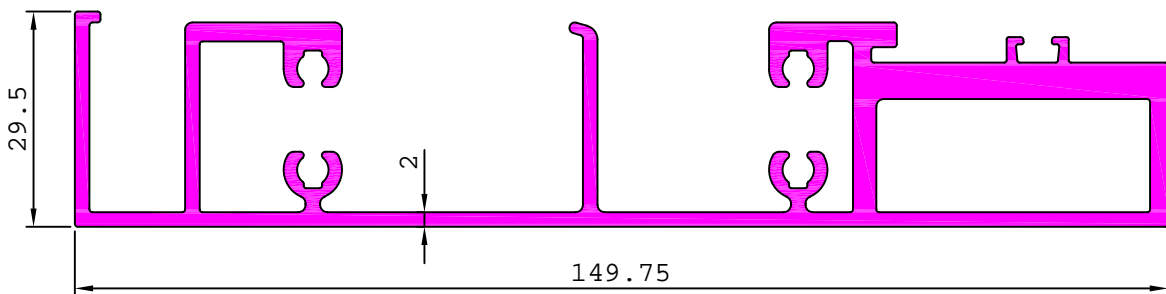

S4661

2.901 kg/m

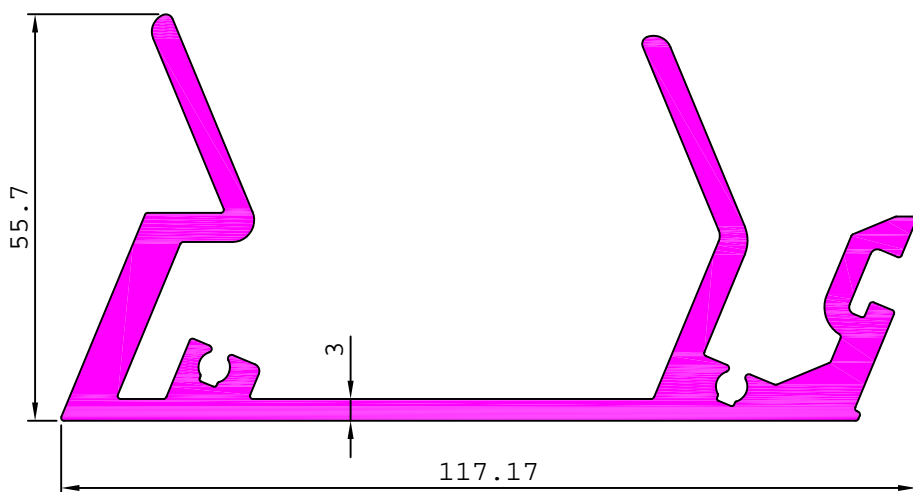

S4667

0.646 kg/m

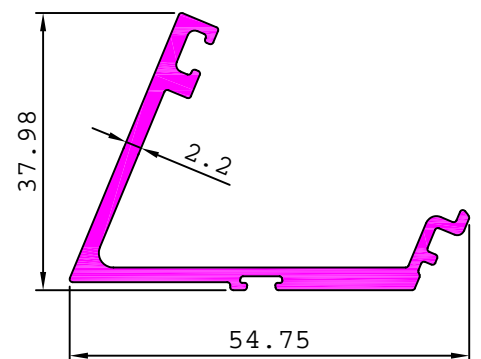

ARCHITECTURAL

CURTAIN WALL SECTION

S4662

2.647 kg/m

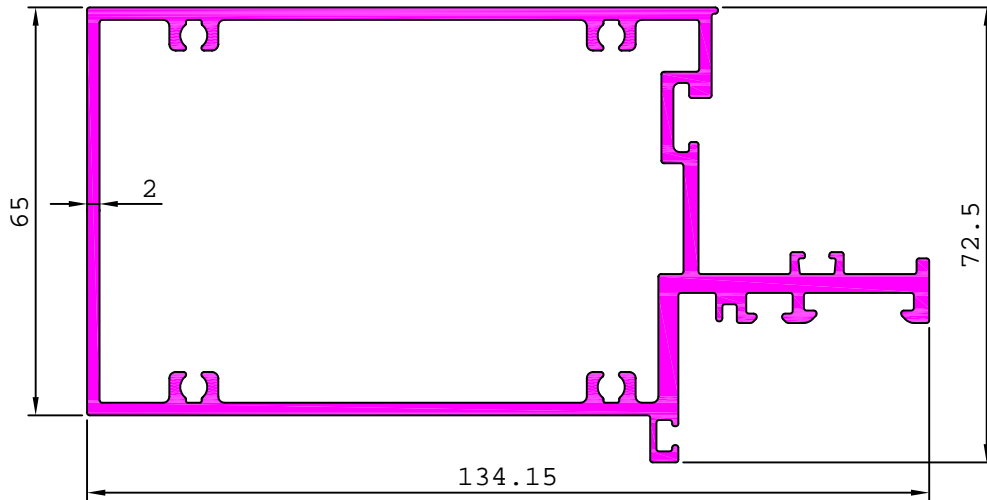

S4663

2.180 kg/m

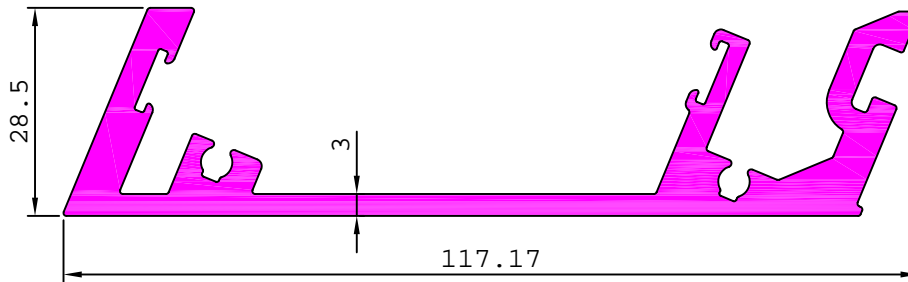

S4664

2.630 kg/m

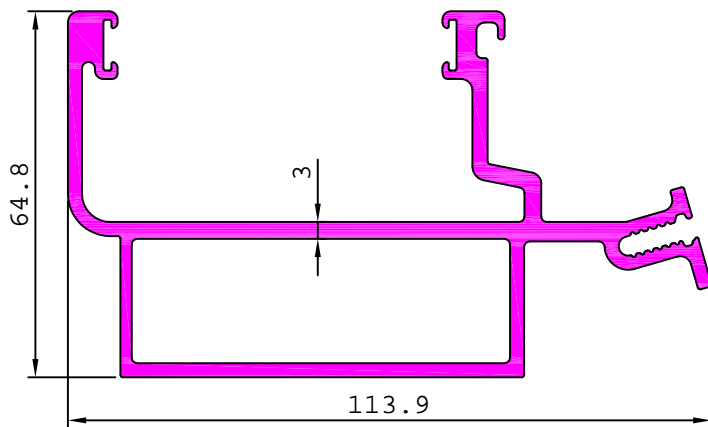

S4665

0.795 kg/m

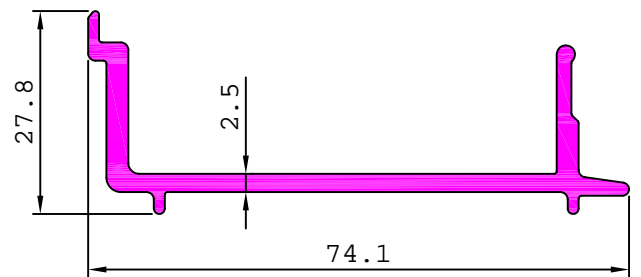

S4666

0.804 kg/m

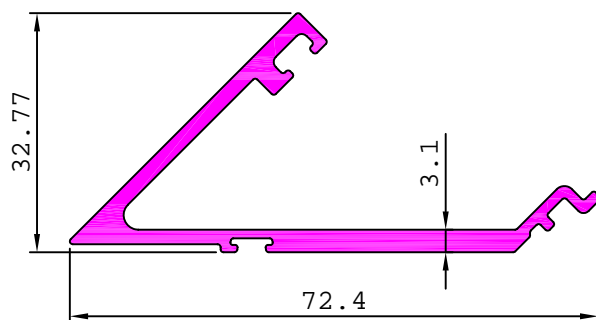

S4675

2.142 kg/m

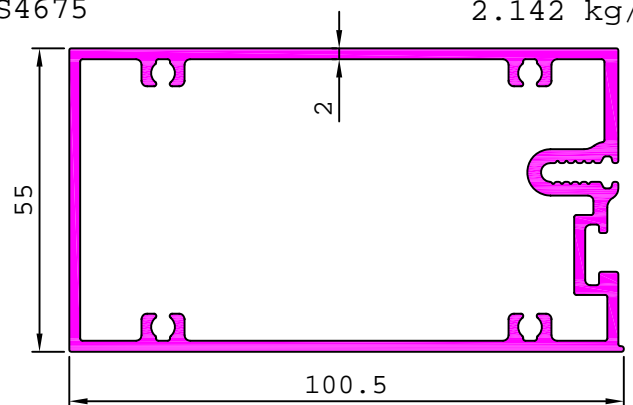

ARCHITECTURAL

CURTAIN WALL SECTION

S4756

3.593 kg/m

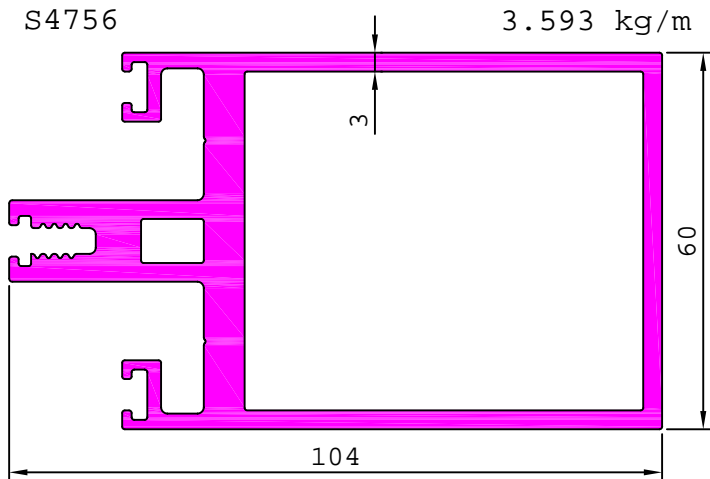

S4794

0.546 kg/m

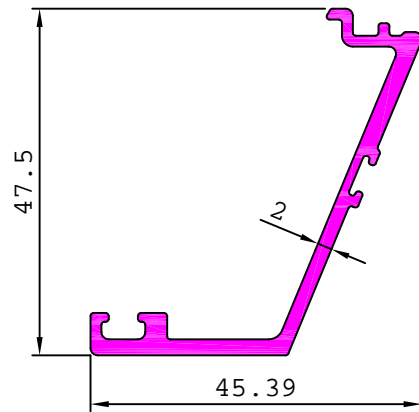

S4790

2.203 kg/m

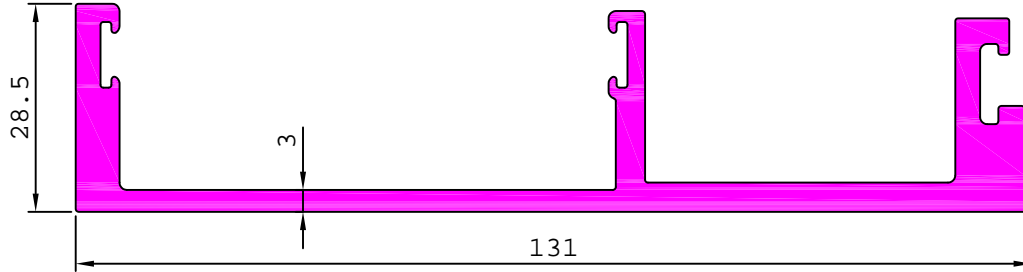

S4789

2.853 kg/m

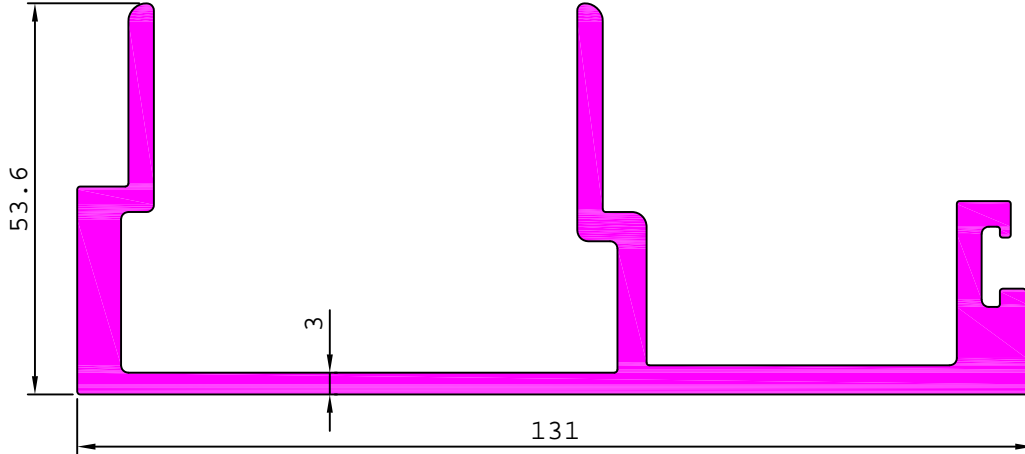

S4791

3.079 kg/m

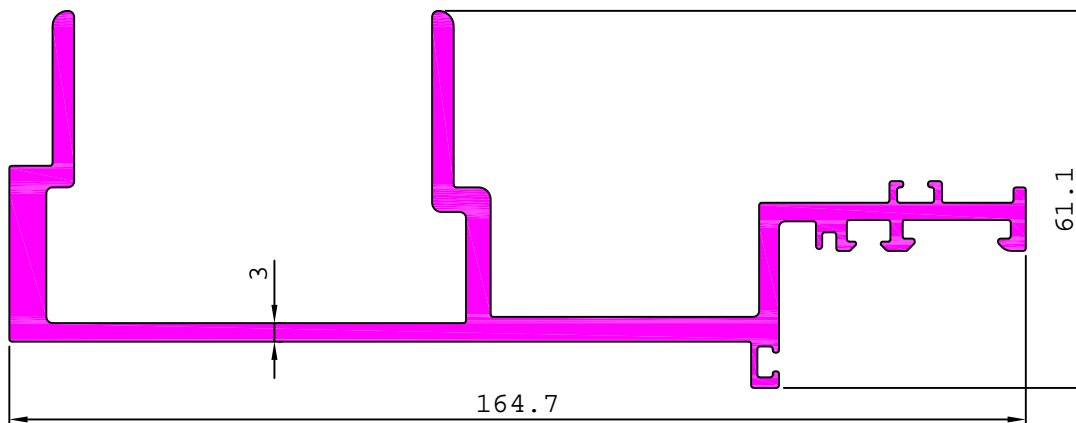

ARCHITECTURAL

CURTAIN WALL SECTION

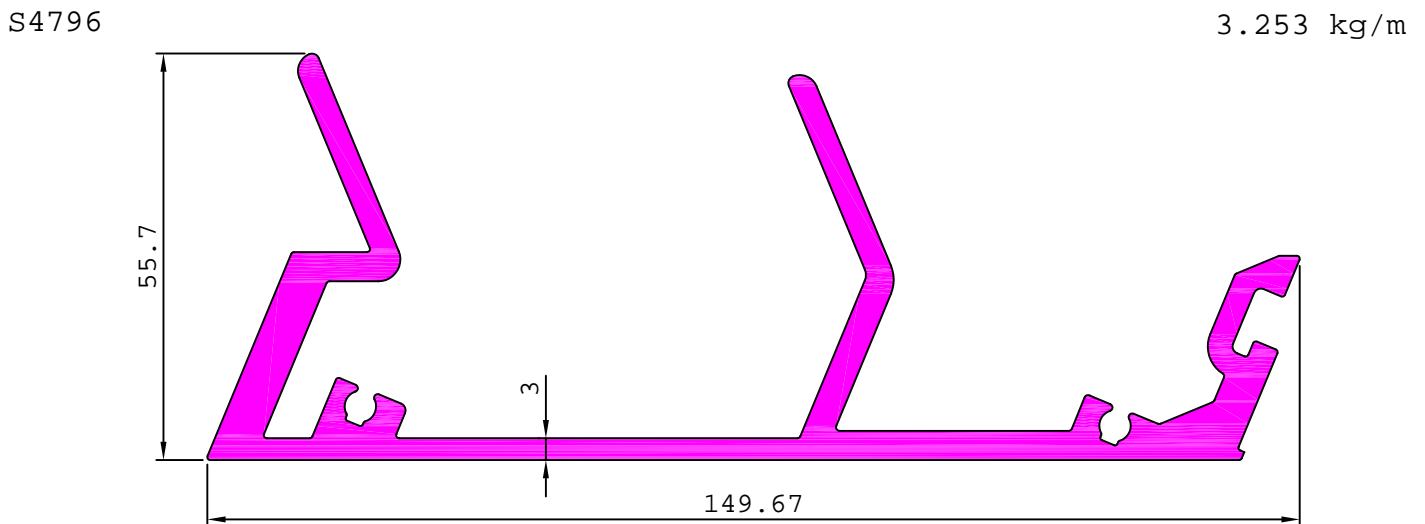
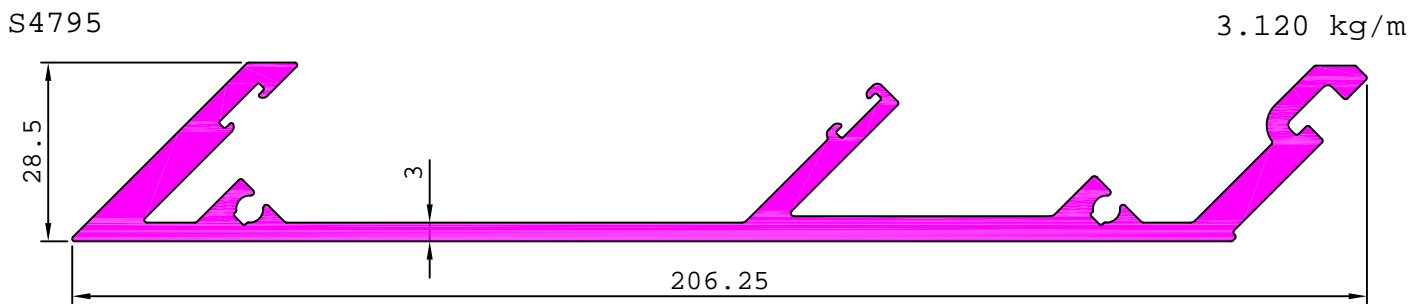
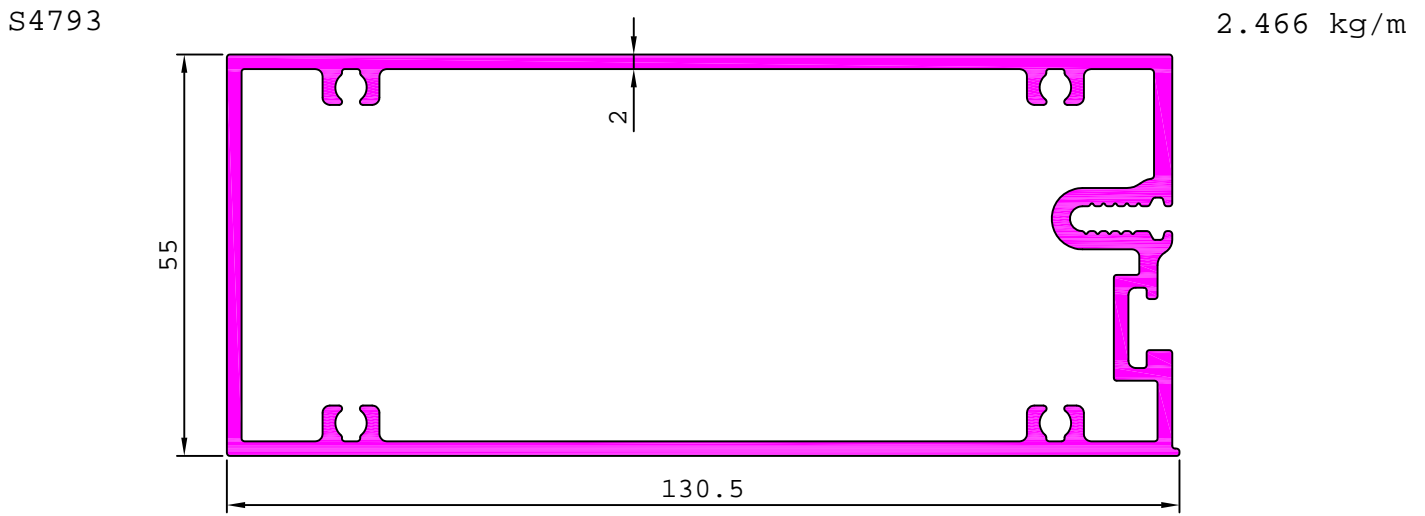
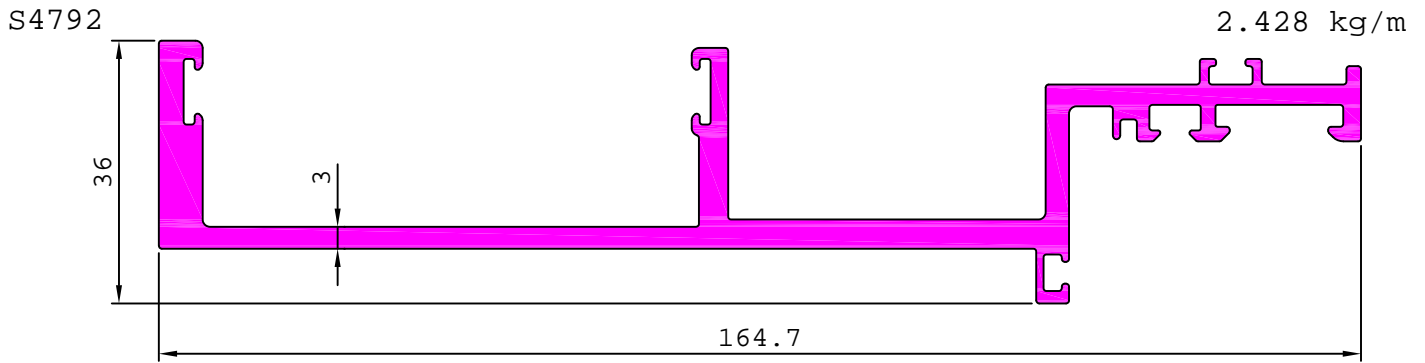

ARCHITECTURAL

CURTAIN WALL SECTION

S4797

2.884 kg/m

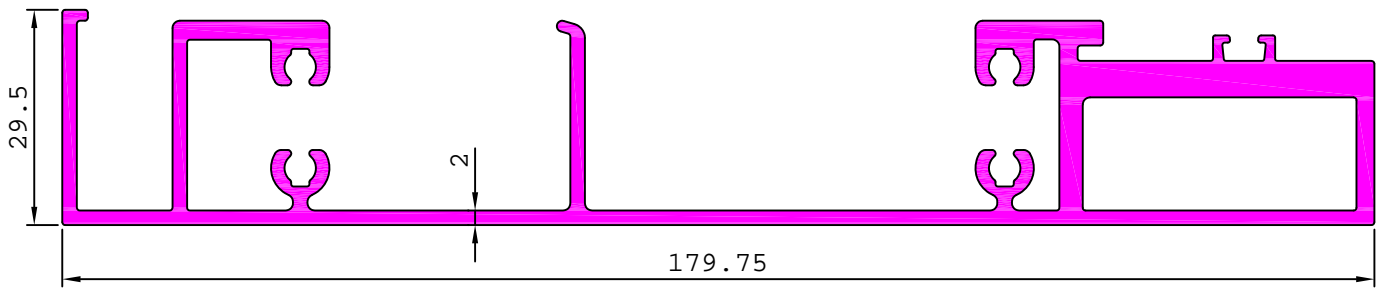

S4798

4.030 kg/m

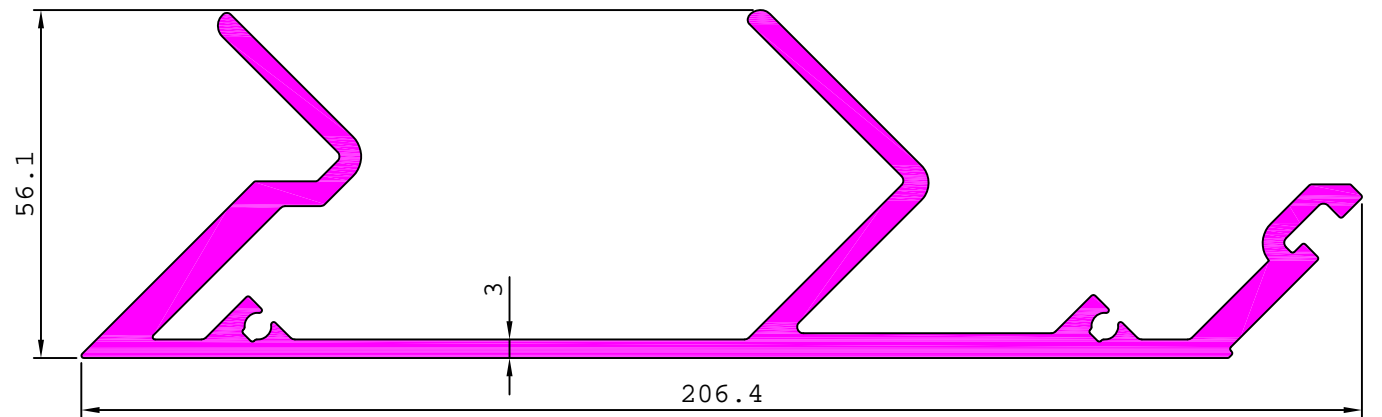

S4799

2.531 kg/m

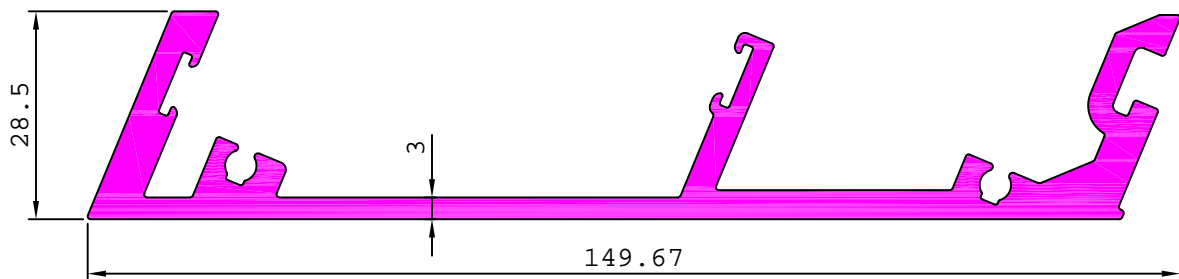

S4800

3.209 kg/m

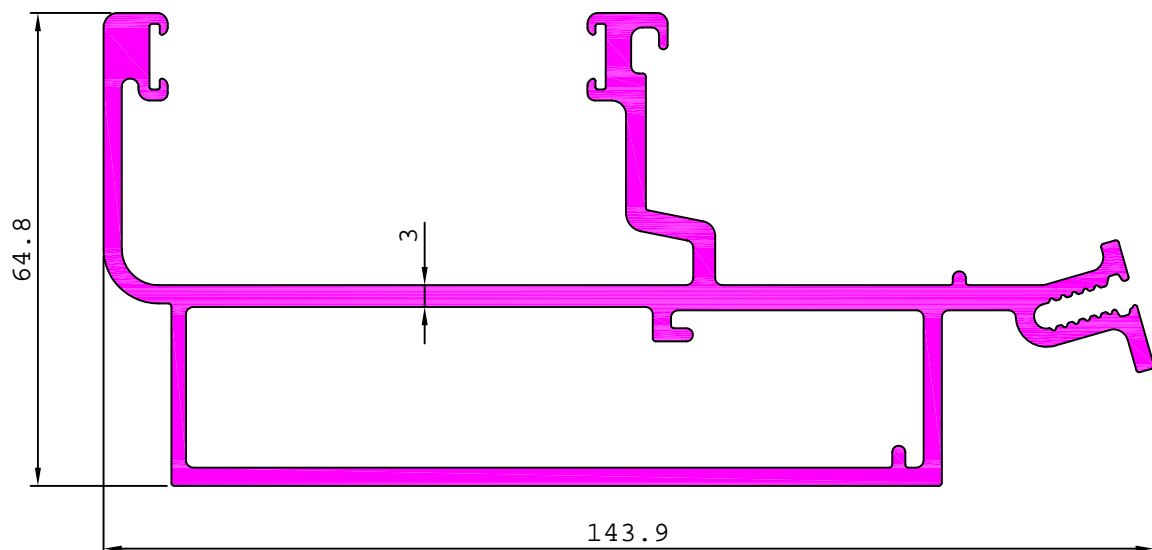

ARCHITECTURAL

CURTAIN WALL SECTION

S4801

2.006 kg/m

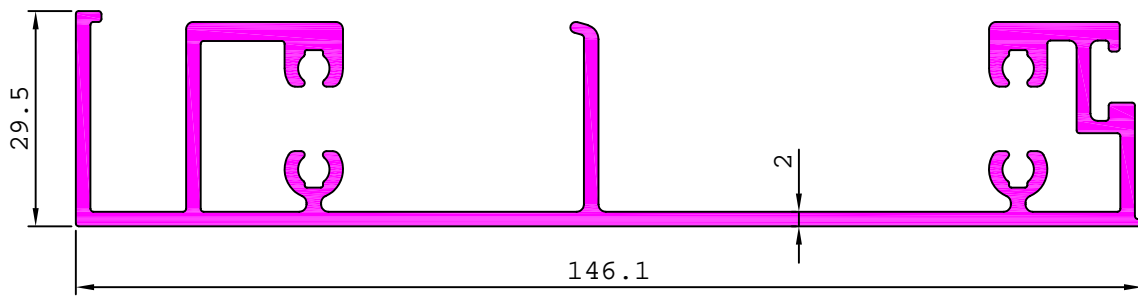

S4802

2.697 kg/m

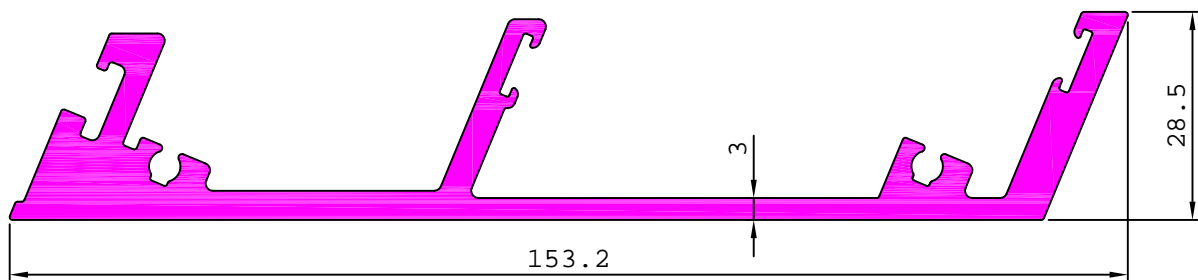

S4803

3.381 kg/m

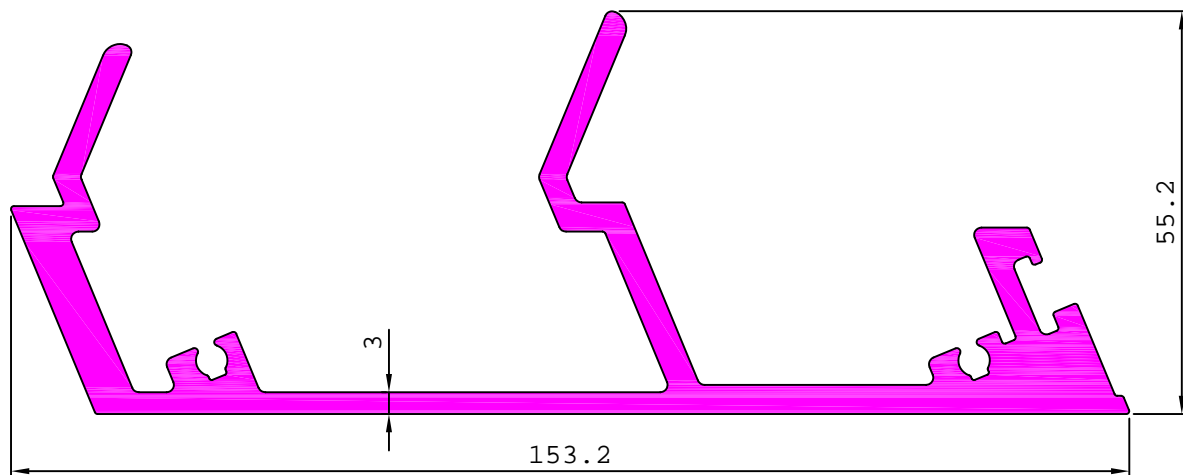

S4851

4.299 kg/m

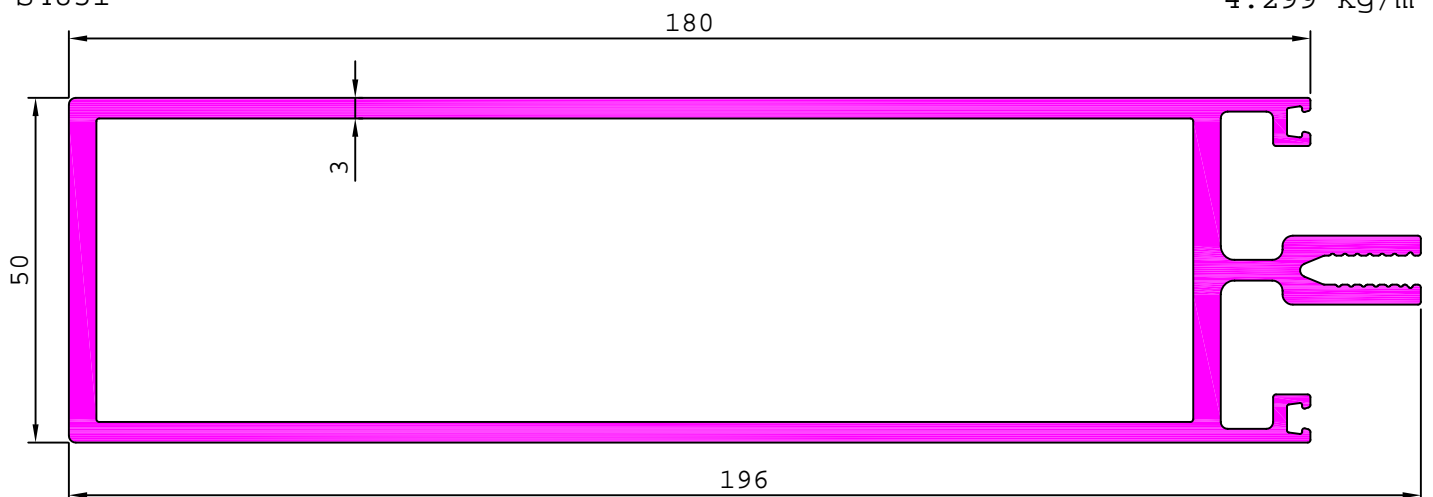

ARCHITECTURAL

CURTAIN WALL SECTION

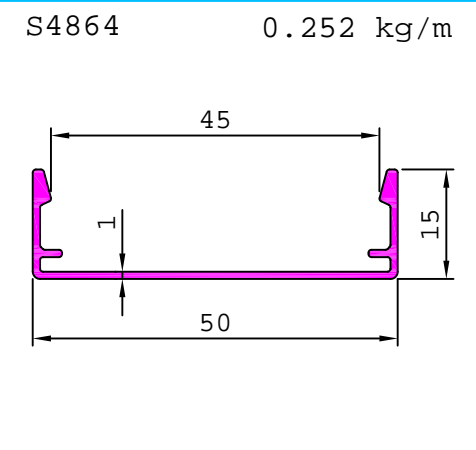
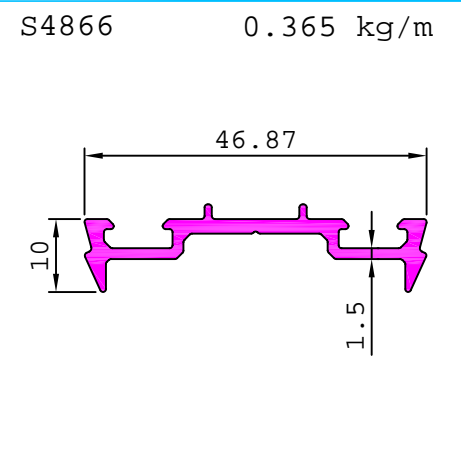
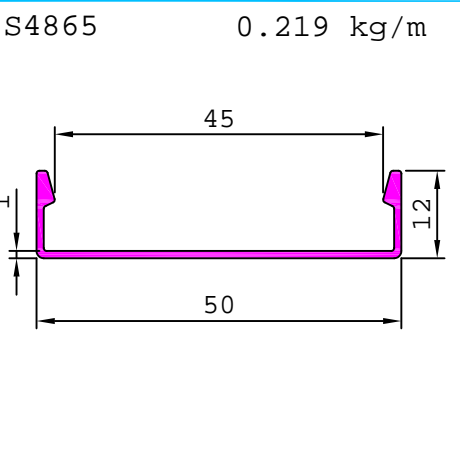
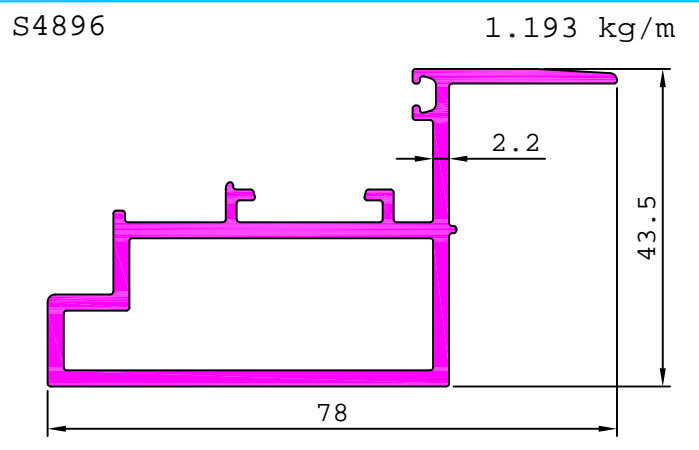
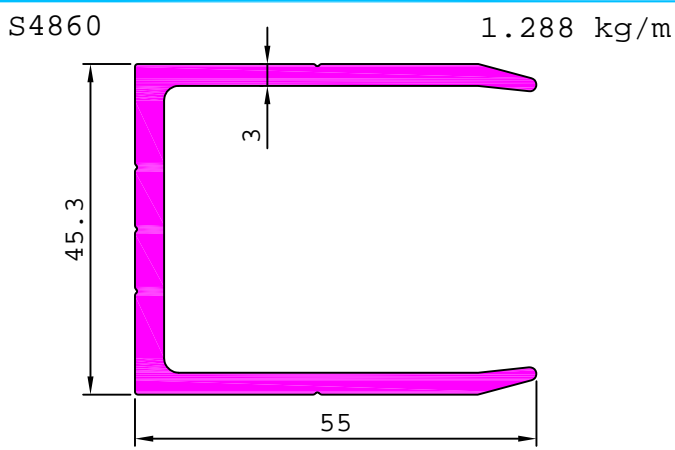
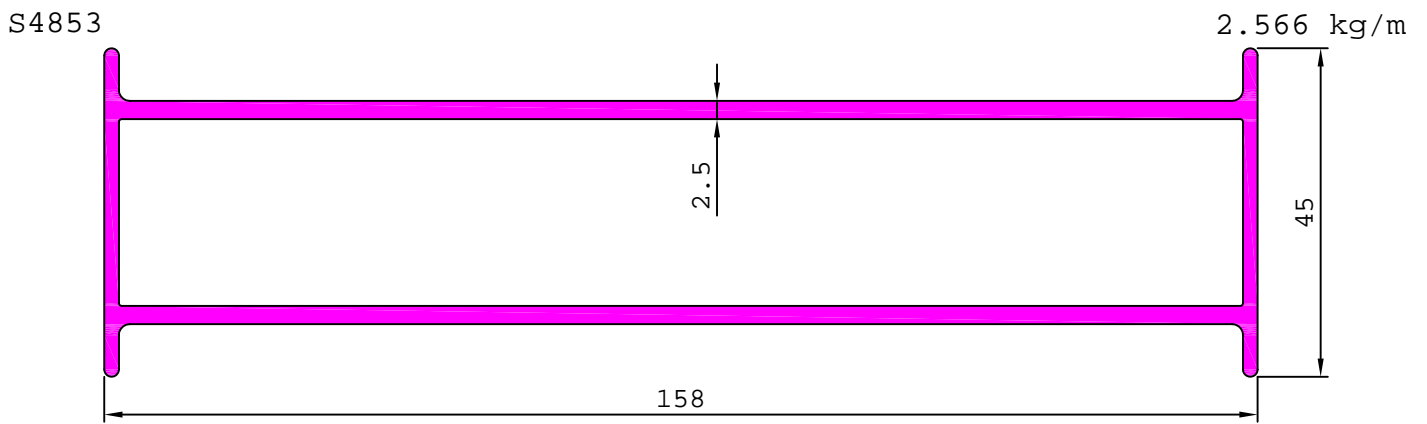
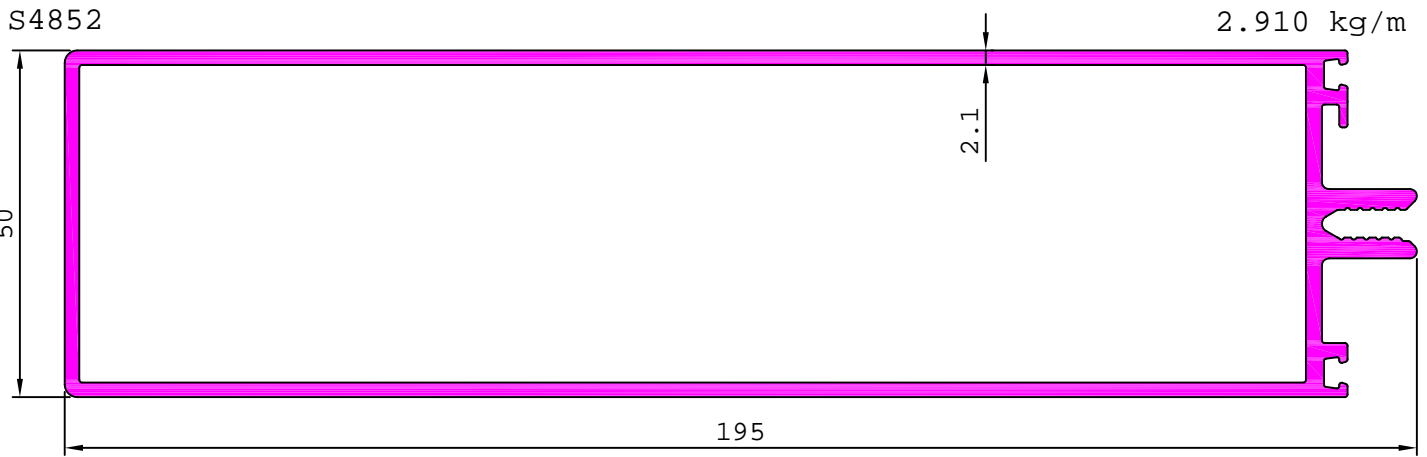

ARCHITECTURAL

CURTAIN WALL SECTION

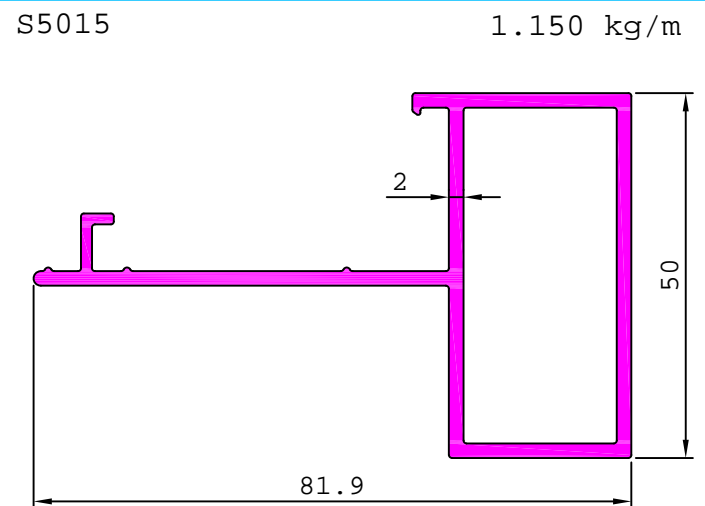
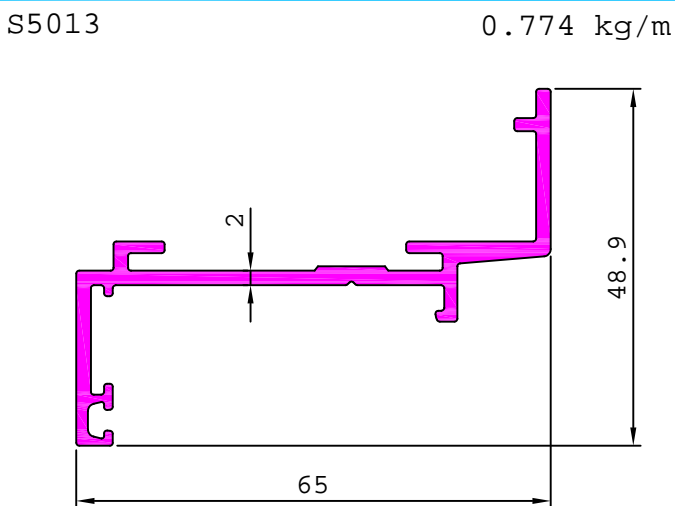
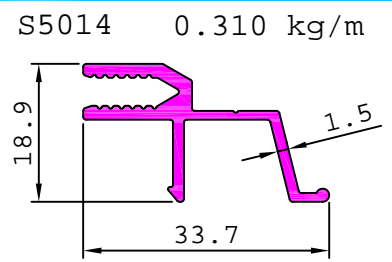
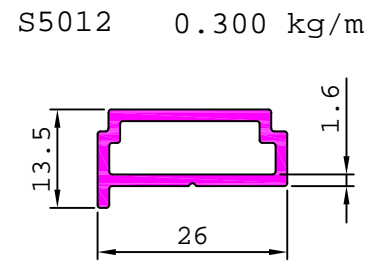
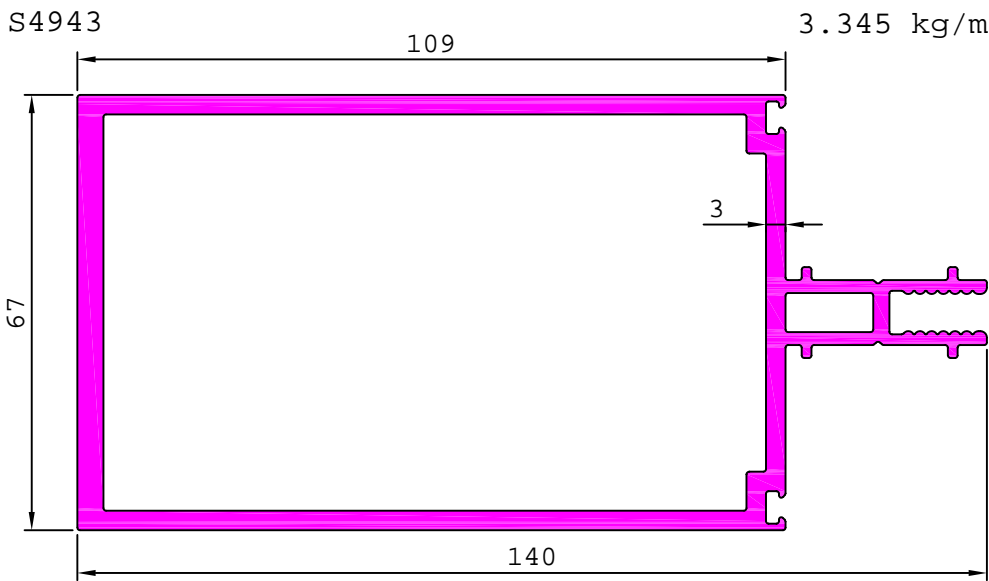
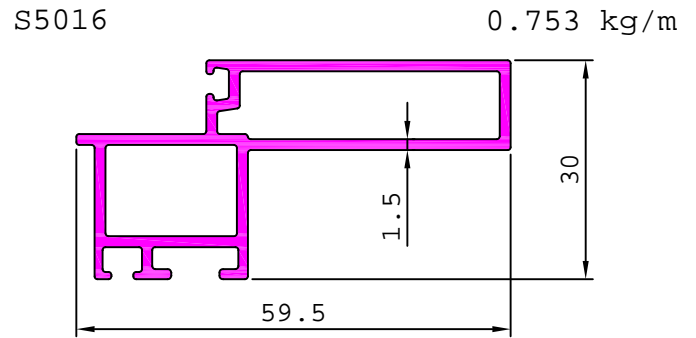
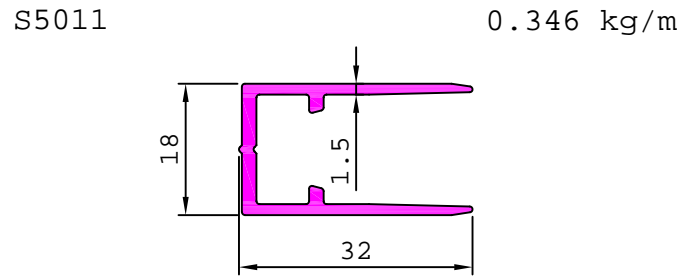
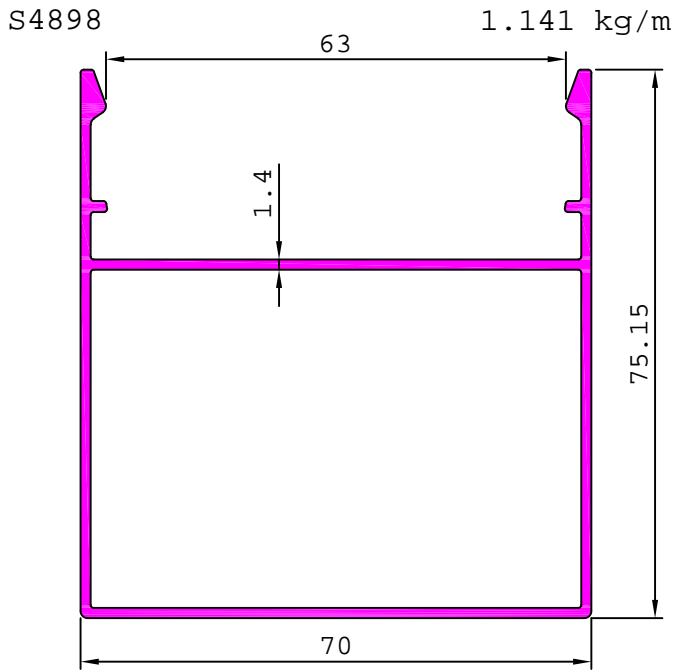

ARCHITECTURAL

CURTAIN WALL SECTION

S5017

1.262 kg/m

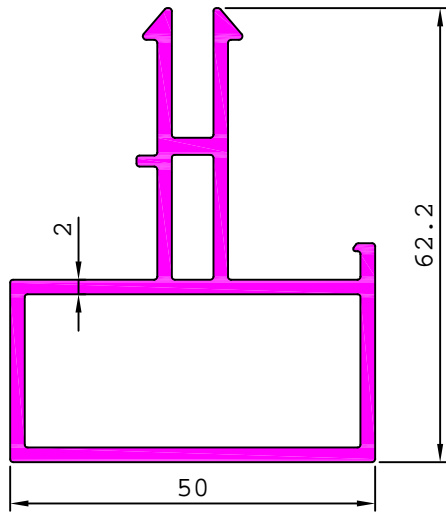

S5019

1.357 kg/m

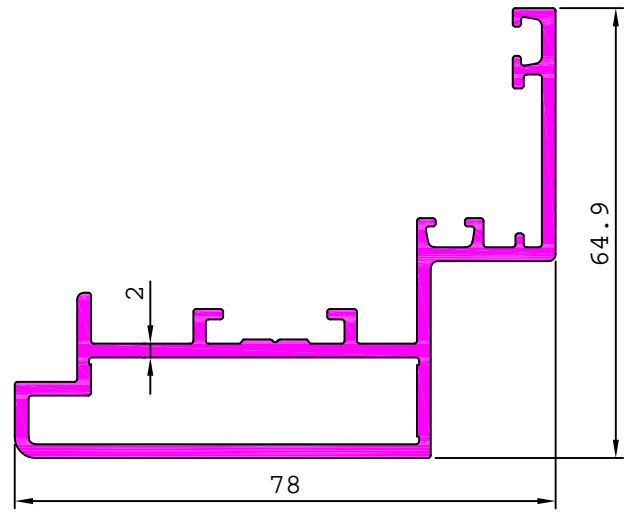

S5020

2.779 kg/m

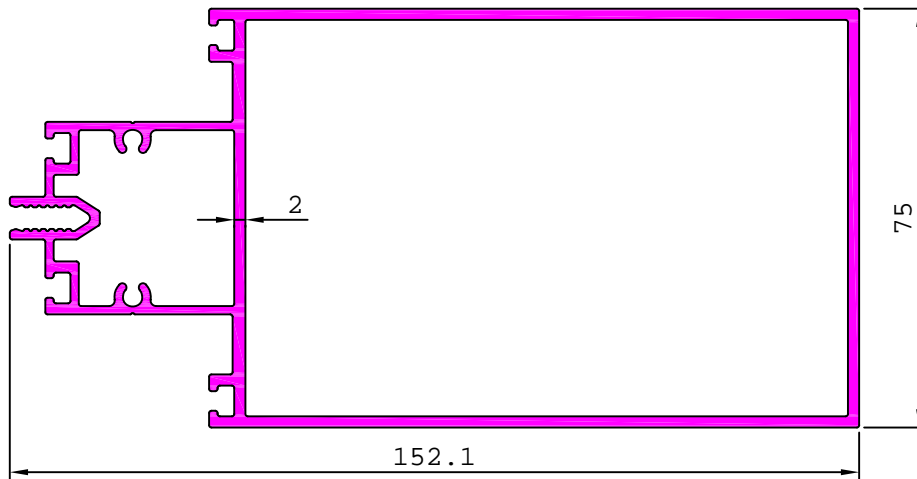

S5023

3.548 kg/m

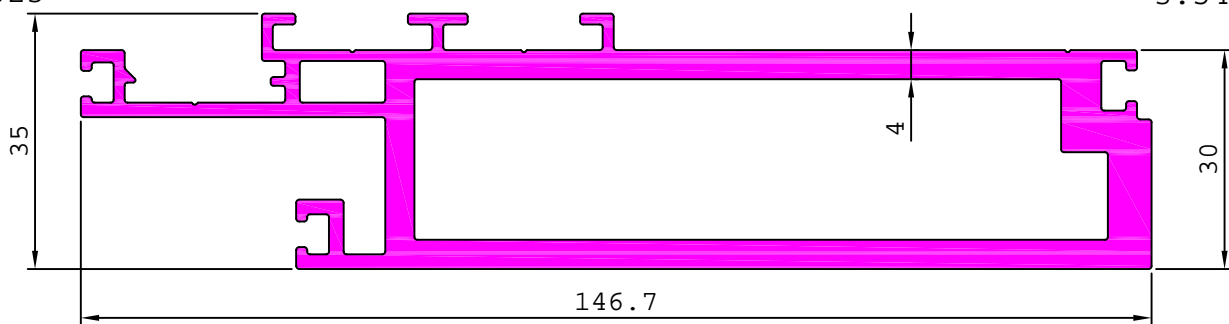

S5024

2.603 kg/m

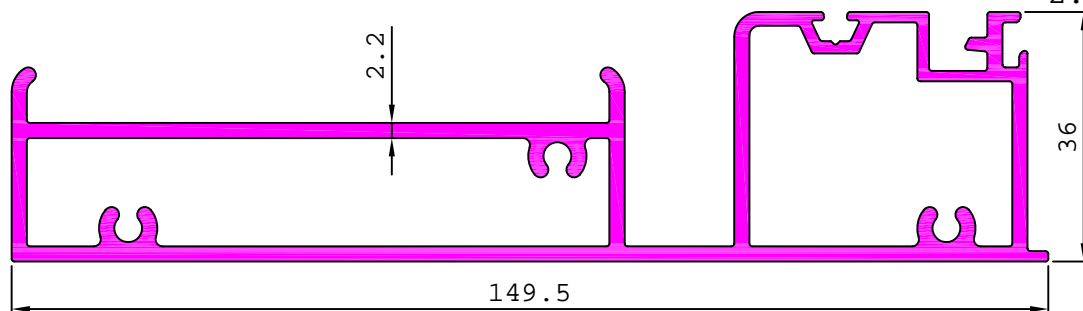

ARCHITECTURAL

CURTAIN WALL SECTION

S5026 0.133 kg/m

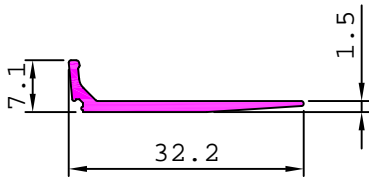

S5027 1.406 kg/m

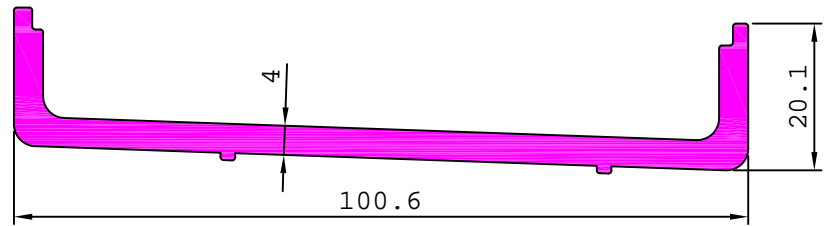

S5028 3.375 kg/m

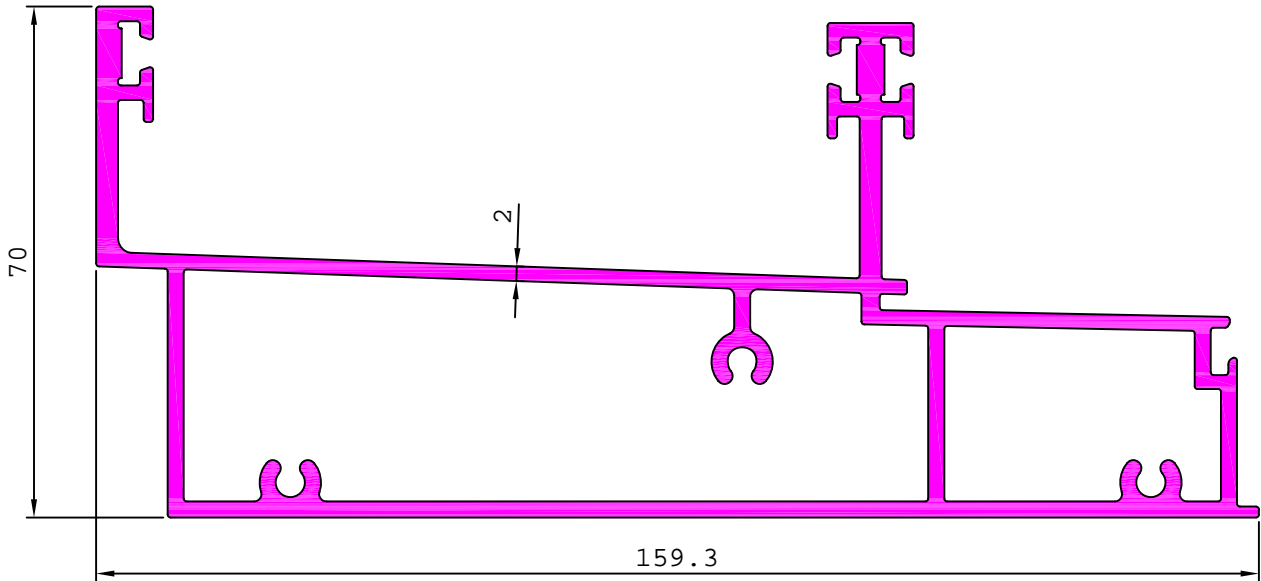

S5038 2.999 kg/m

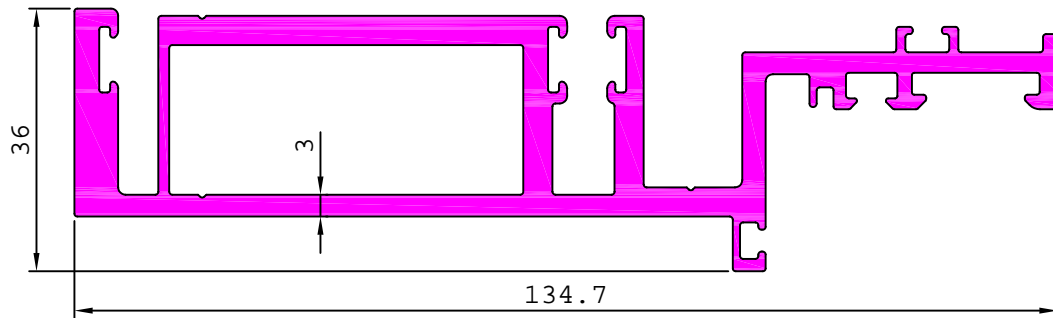

S5040 3.673 kg/m

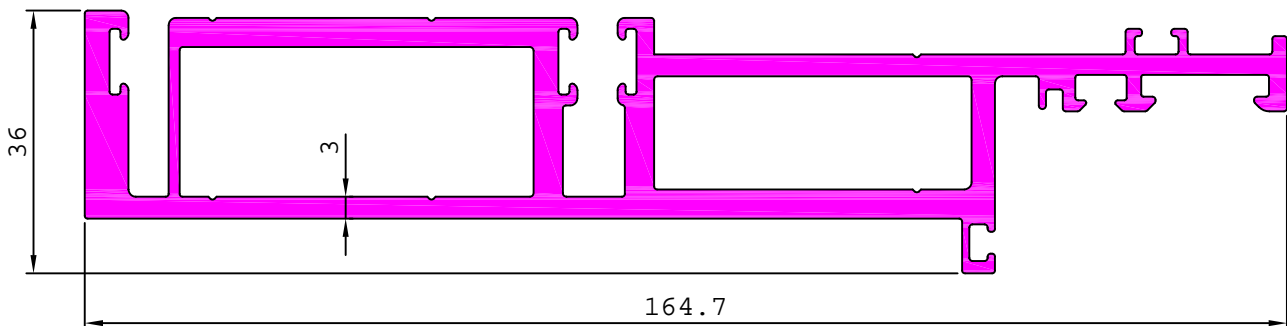

ARCHITECTURAL

CURTAIN WALL SECTION

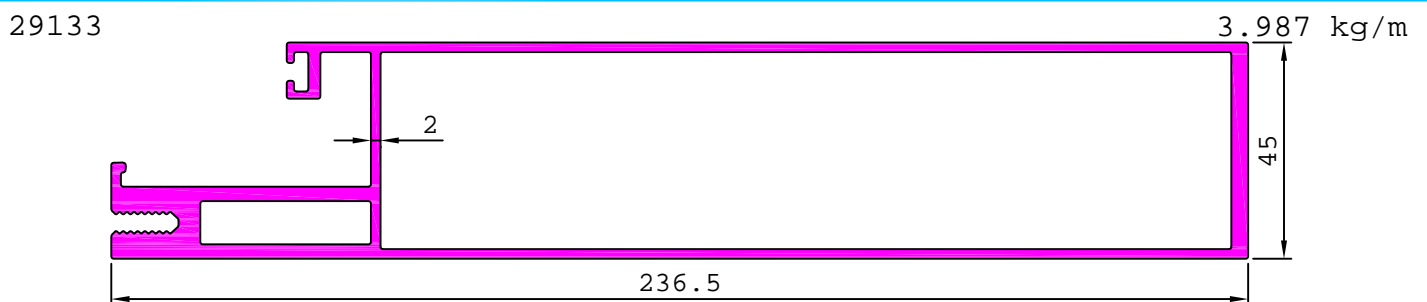
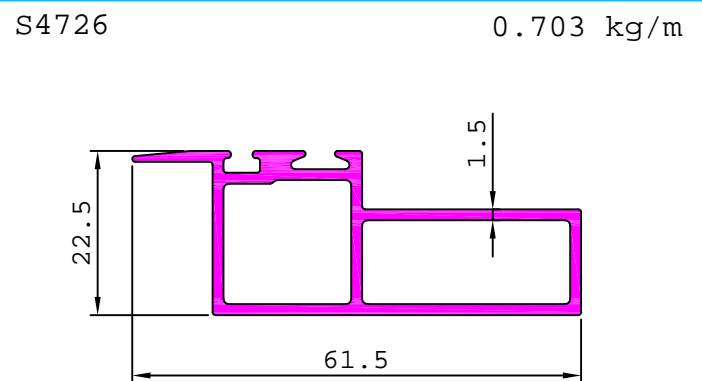
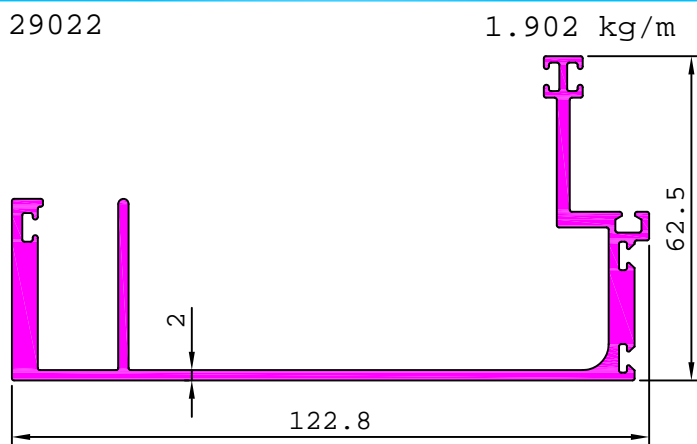
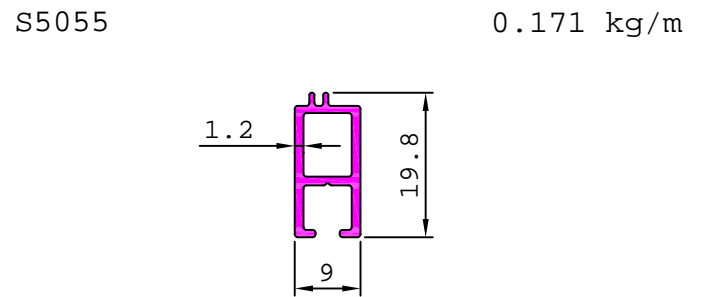
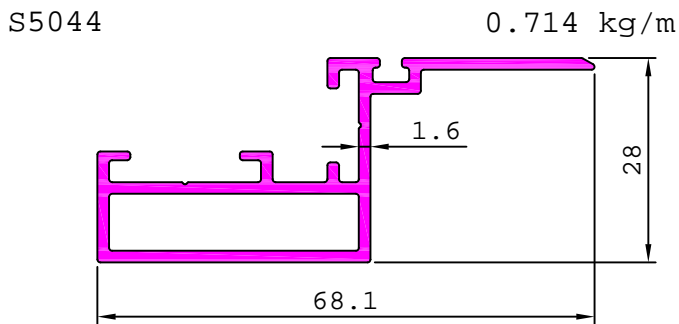
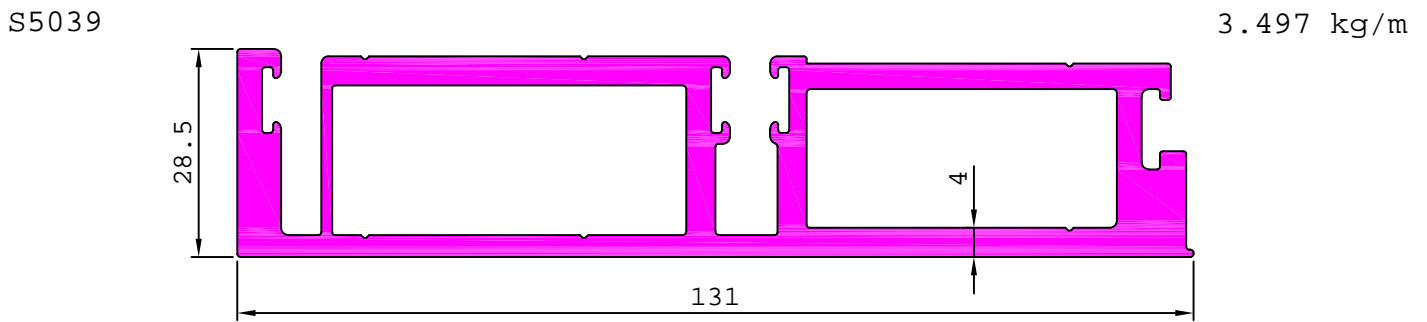
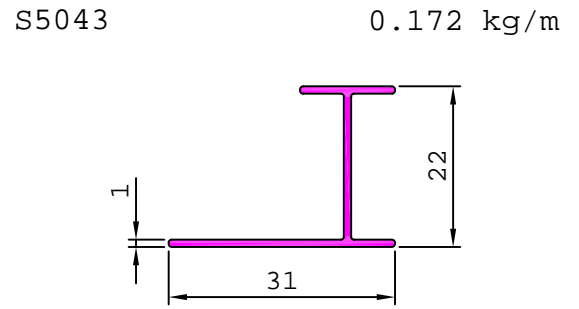
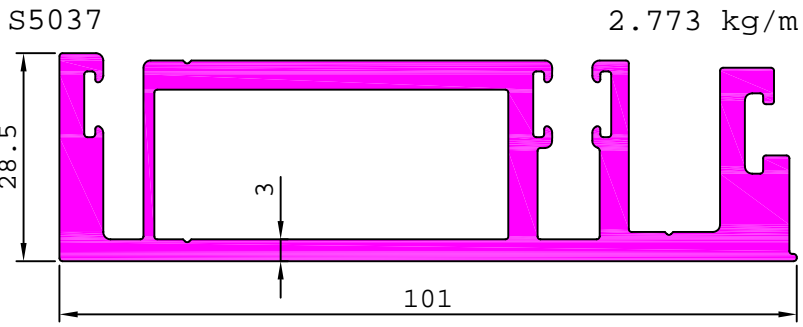

ARCHITECTURAL

CURTAIN WALL SECTION

35949

0.848 kg/m

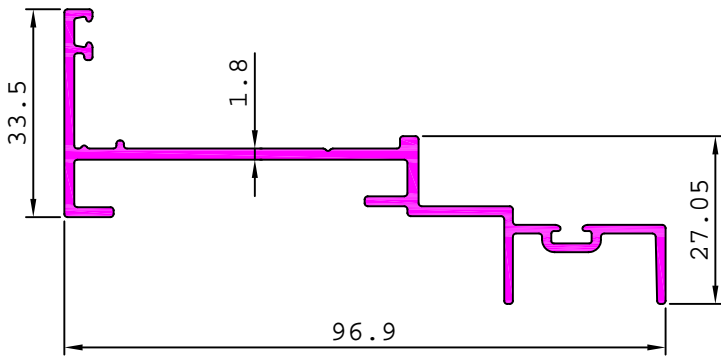

S5127

0.905 kg/m

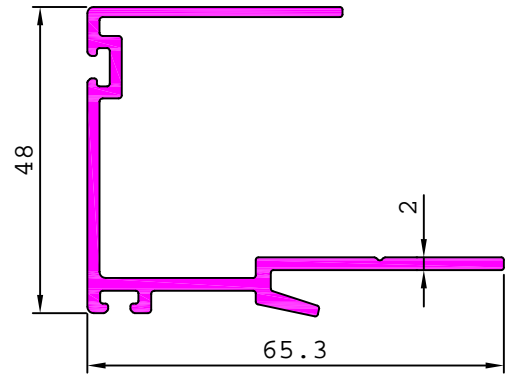

35950

0.956 kg/m

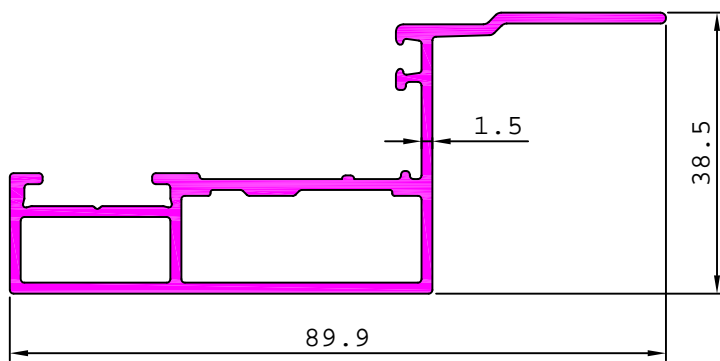

S5130

1.298 kg/m

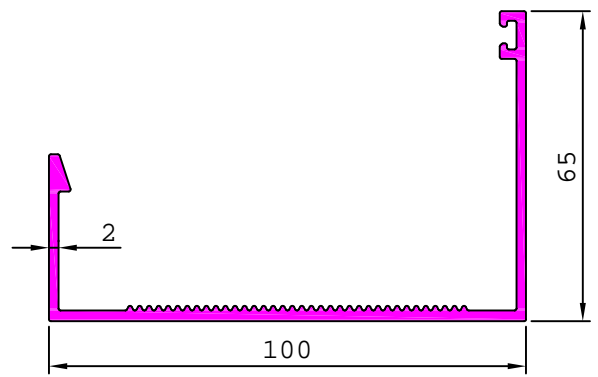

S5128

0.339 kg/m

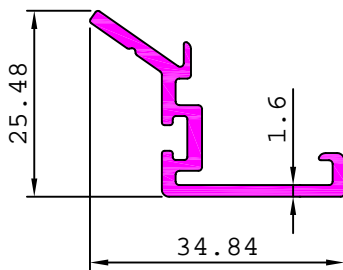

S5129

0.279 kg/m

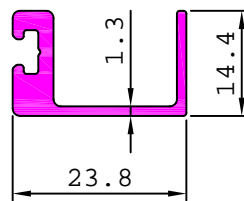

S5136

0.275 kg/m

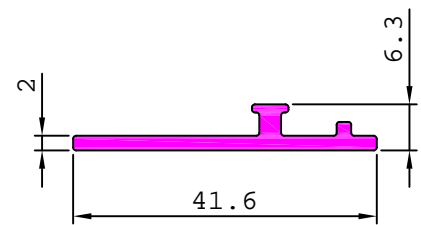

S5131

2.219 kg/m

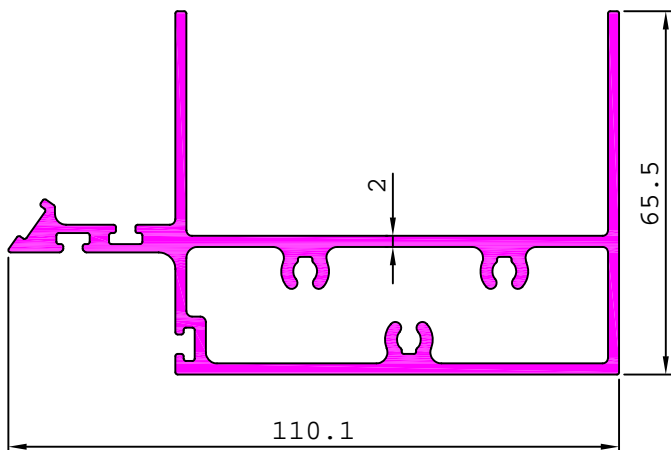

S5134

2.279 kg/m

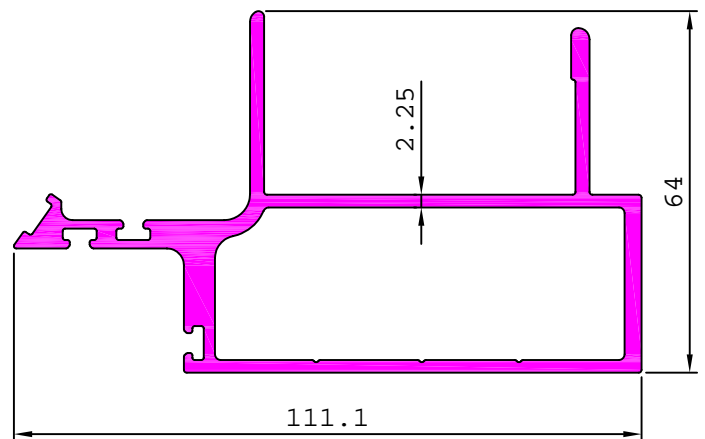

ARCHITECTURAL

CURTAIN WALL SECTION

S5133

1.434 kg/m

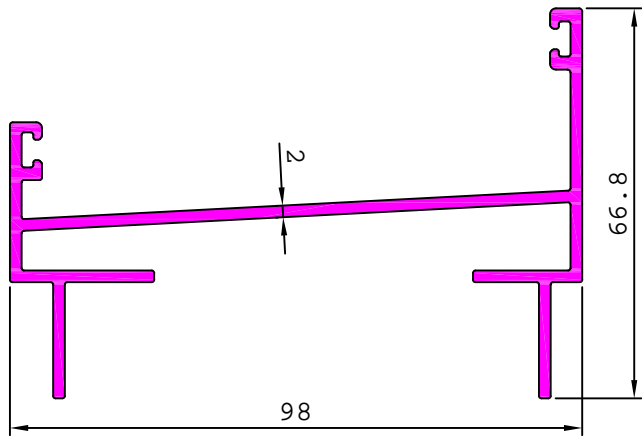

S5132

2.145 kg/m

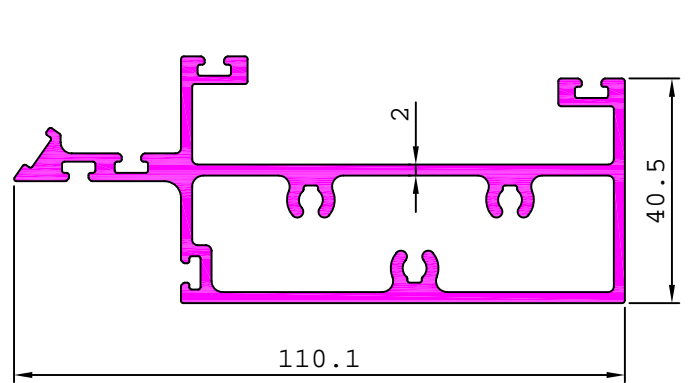

S5135

2.151 kg/m

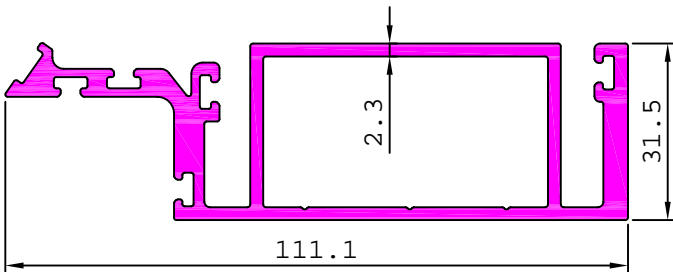

S5174

0.838 kg/m

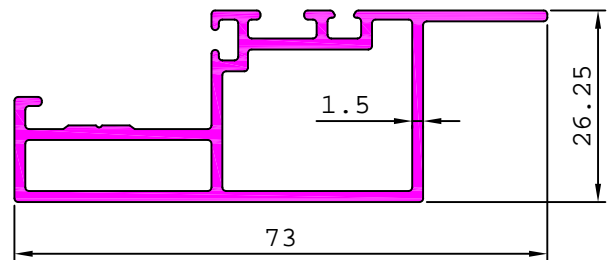

S5217

3.382 kg/m

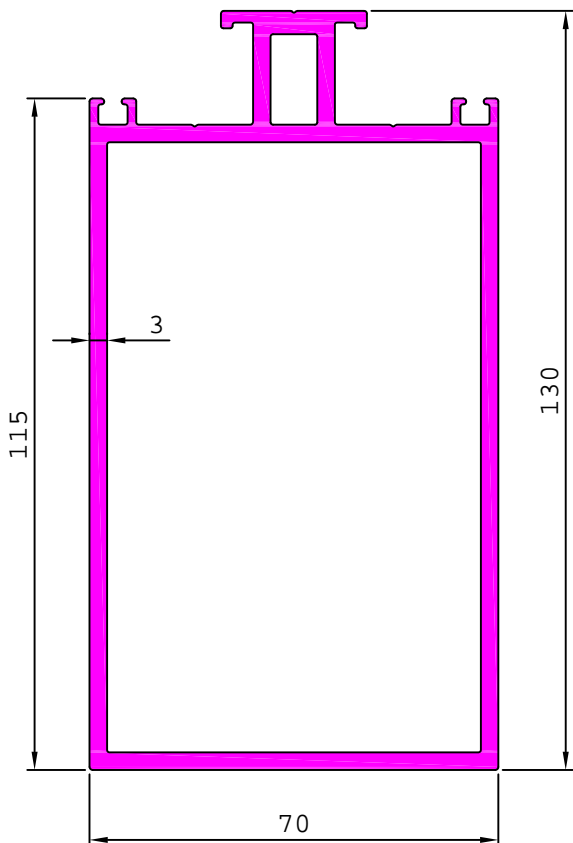

S5220

0.492 kg/m

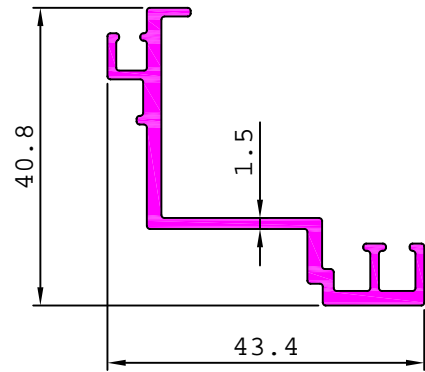

S5221

0.770 kg/m

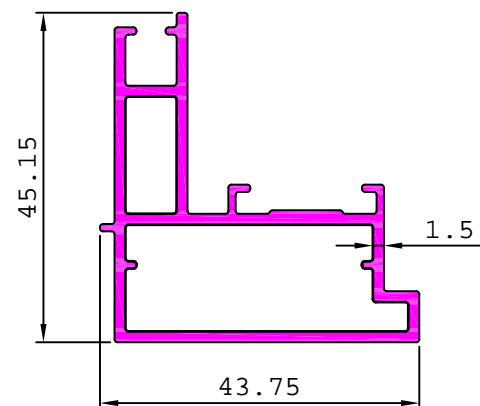

ARCHITECTURAL

CURTAIN WALL SECTION

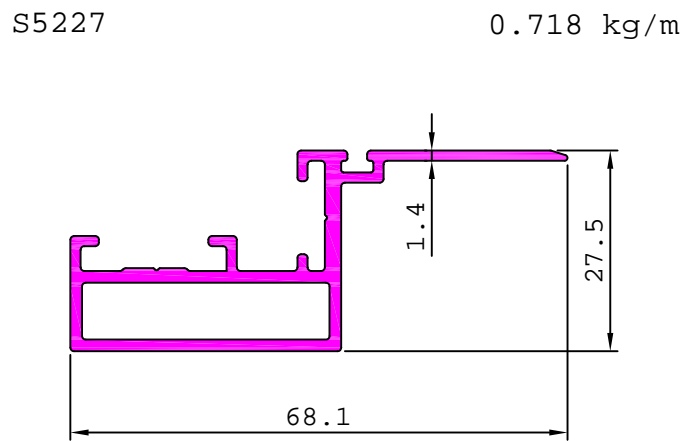
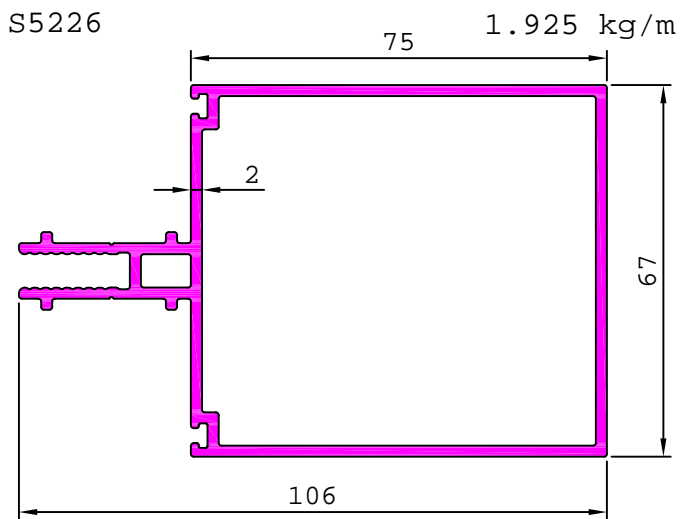
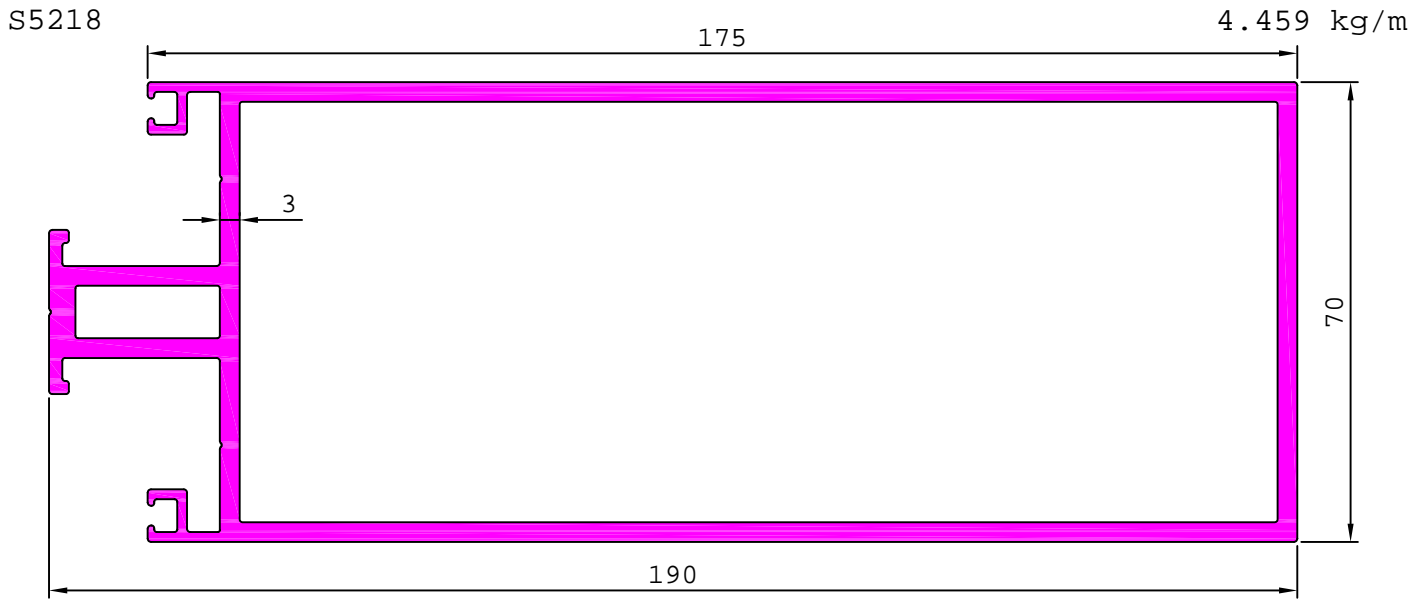

ARCHITECTURAL

CURTAIN WALL SECTION

35598

0.886 kg/m

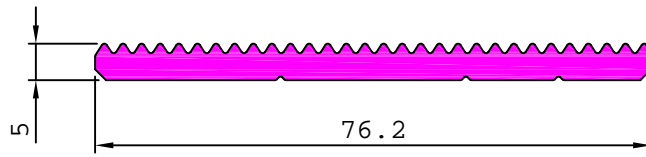

35616

0.647 kg/m

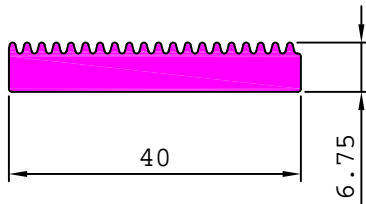

35617

0.384 kg/m

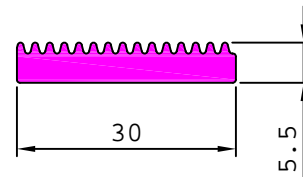

35881

3.300 kg/m

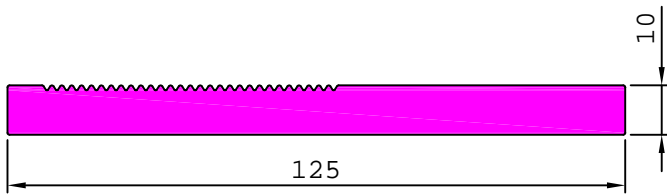

35882

0.477 kg/m

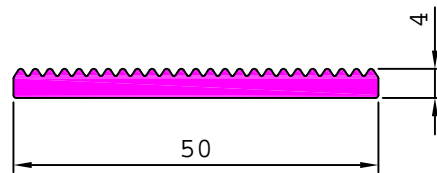

35920

0.467 kg/m

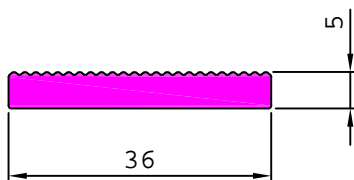

ARCHITECTURAL

CURTAIN WALL SECTION

29230

8.278 kg/m

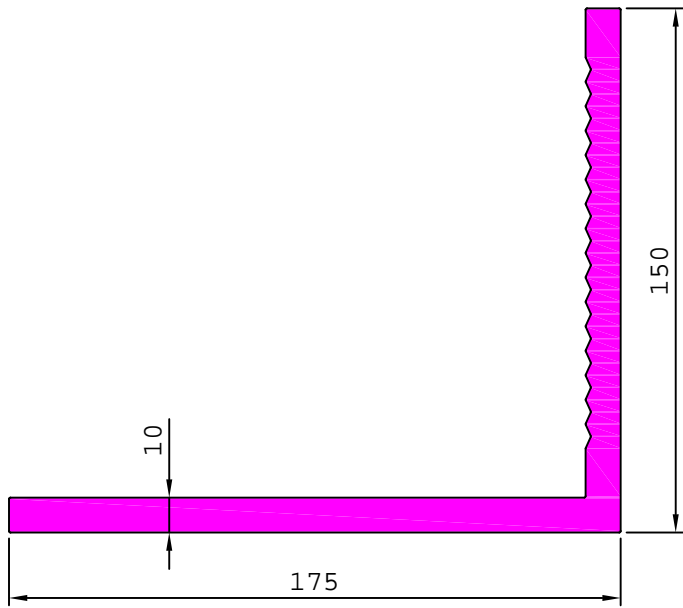

35821

1.201 kg/m

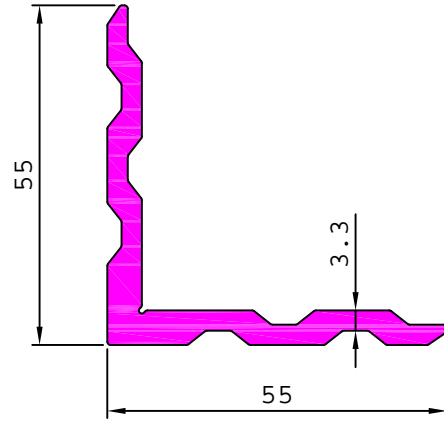

35606

3.942 kg/m

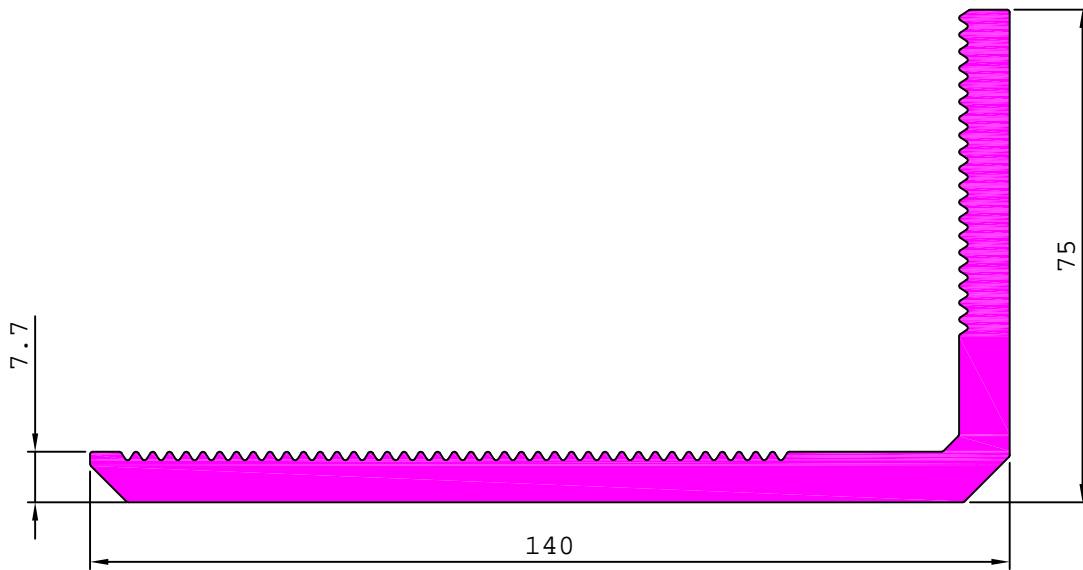

35614

4.284 kg/m

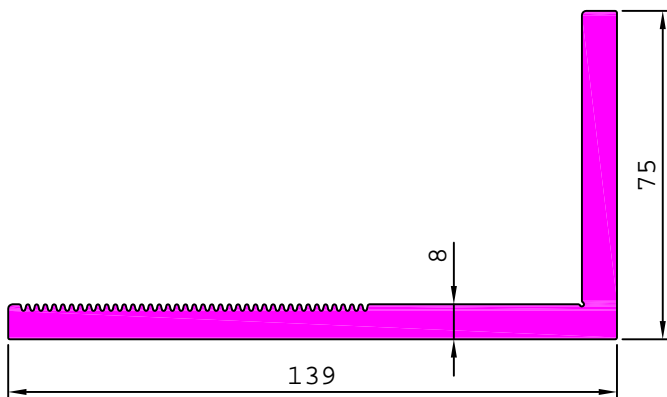

35615

3.992 kg/m

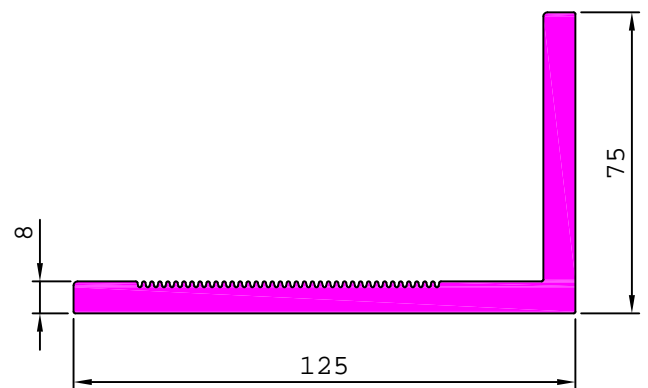

ARCHITECTURAL

CURTAIN WALL SECTION

35863

15.131 kg/m

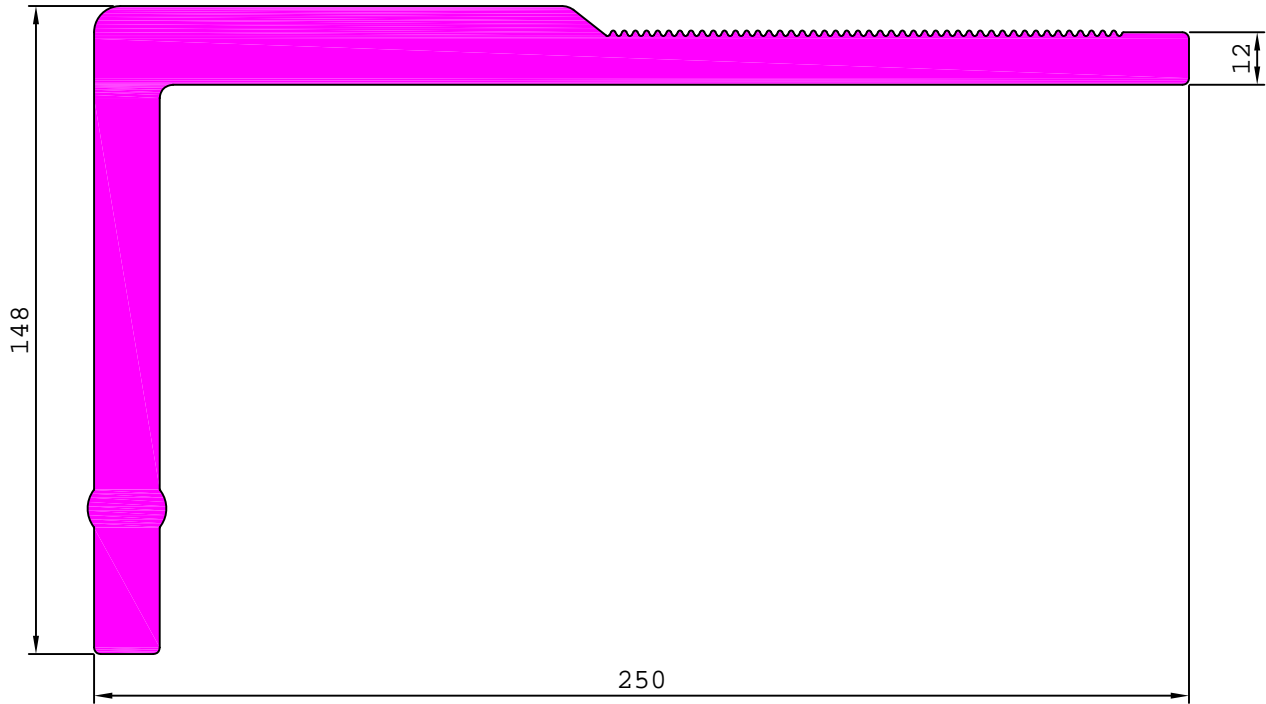

35864

18.108 kg/m

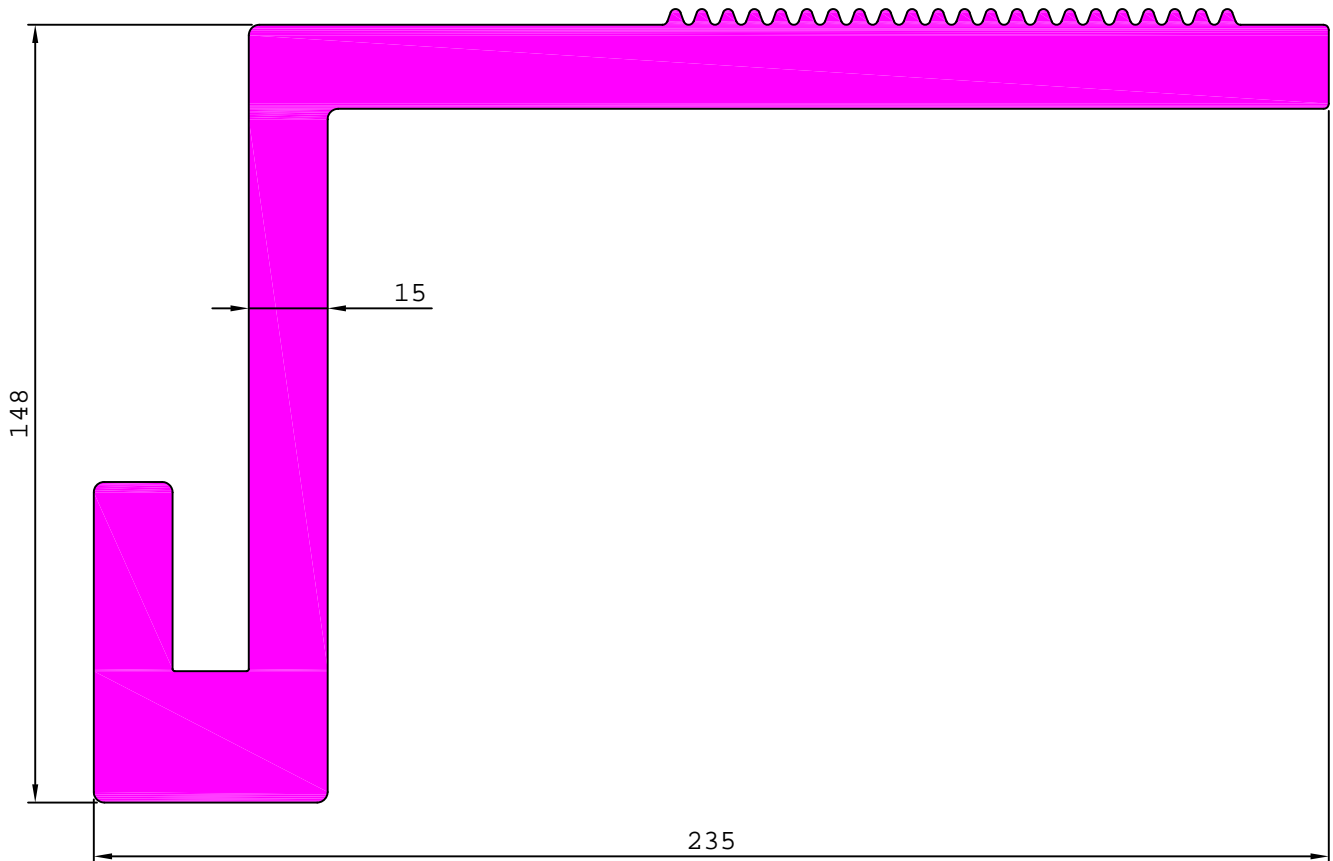

ARCHITECTURAL

CURTAIN WALL SECTION

35866

12.957 kg/m

194.25

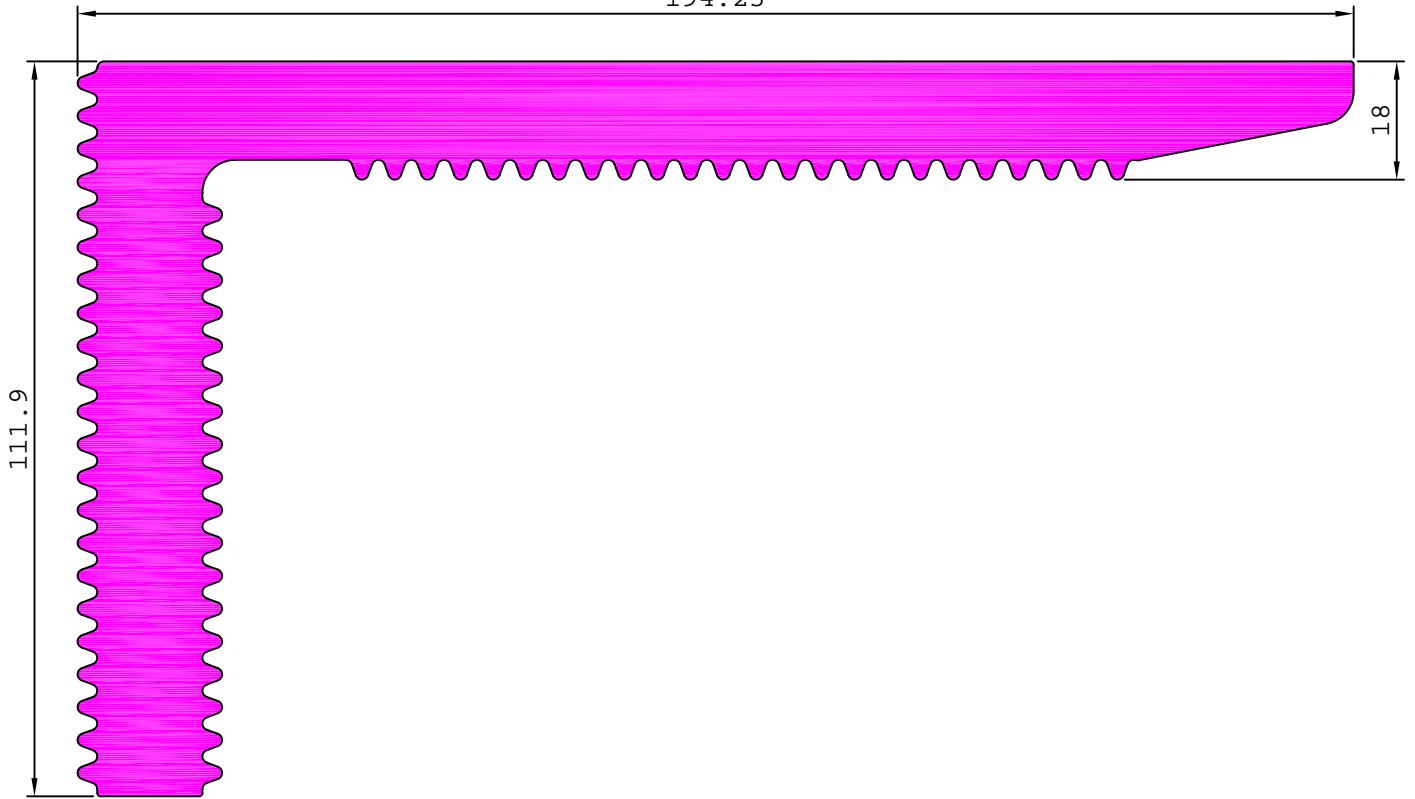

27995

24.039 kg/m

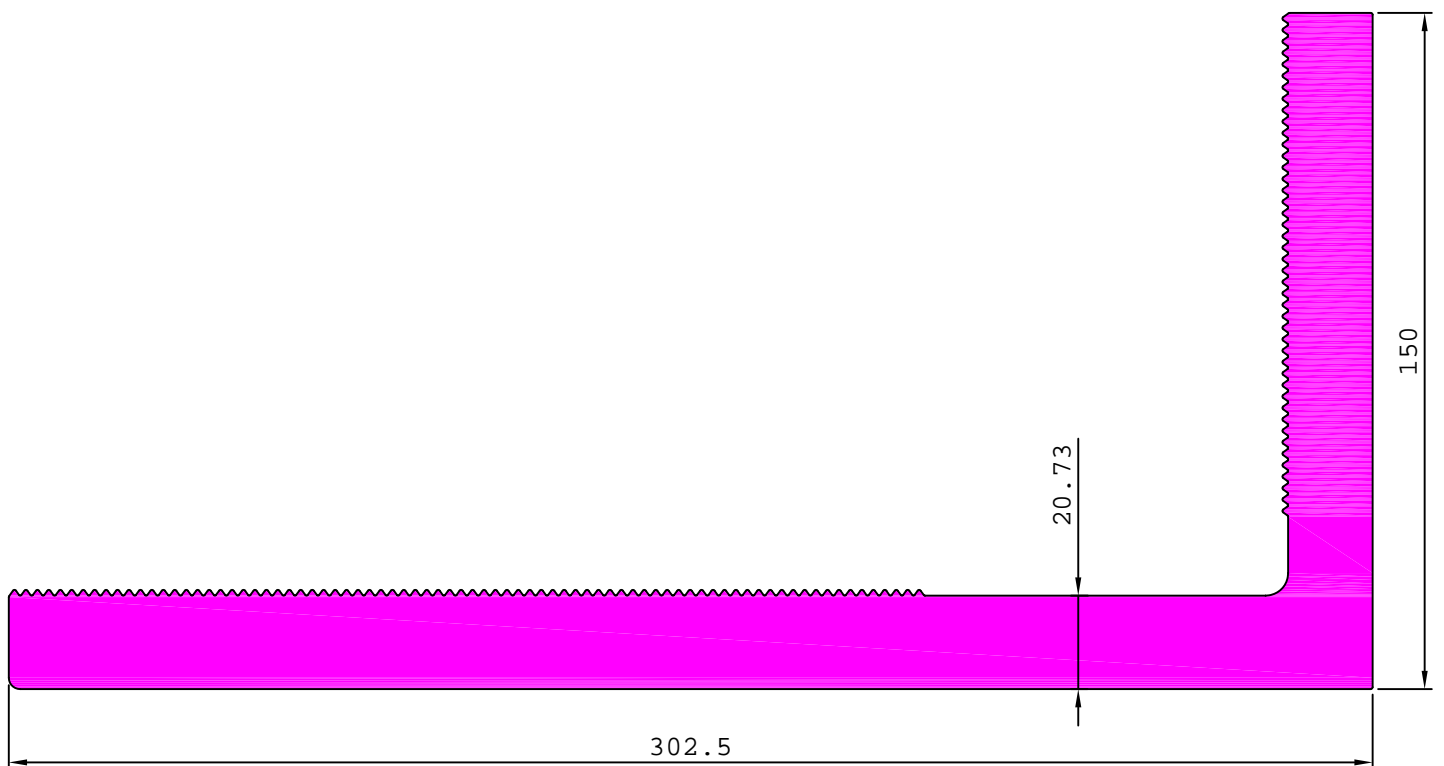

ARCHITECTURAL

CURTAIN WALL SECTION

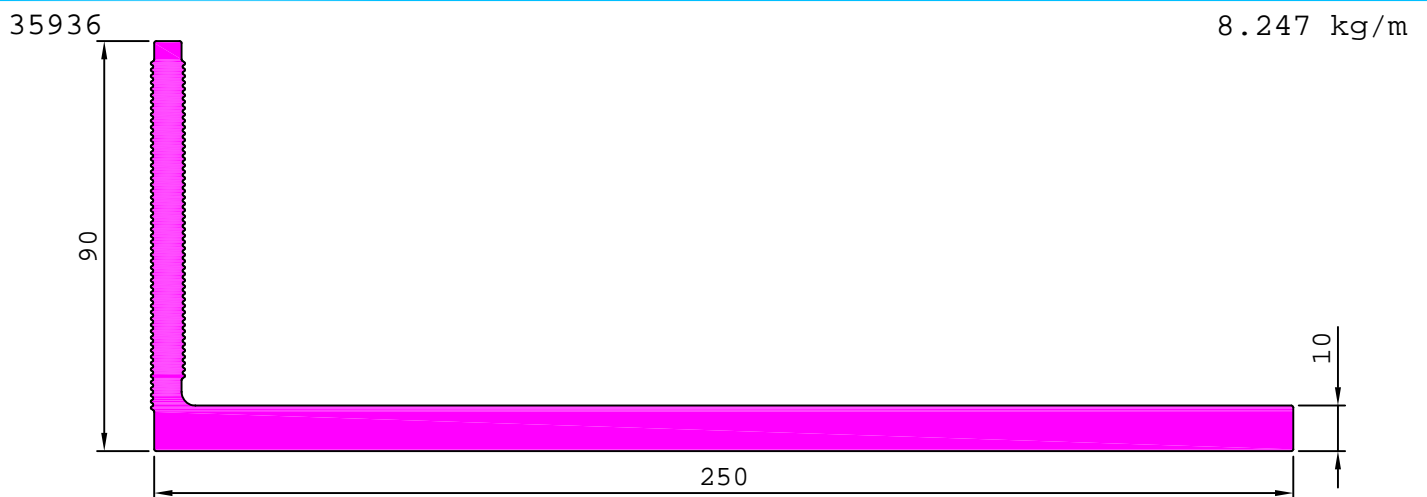
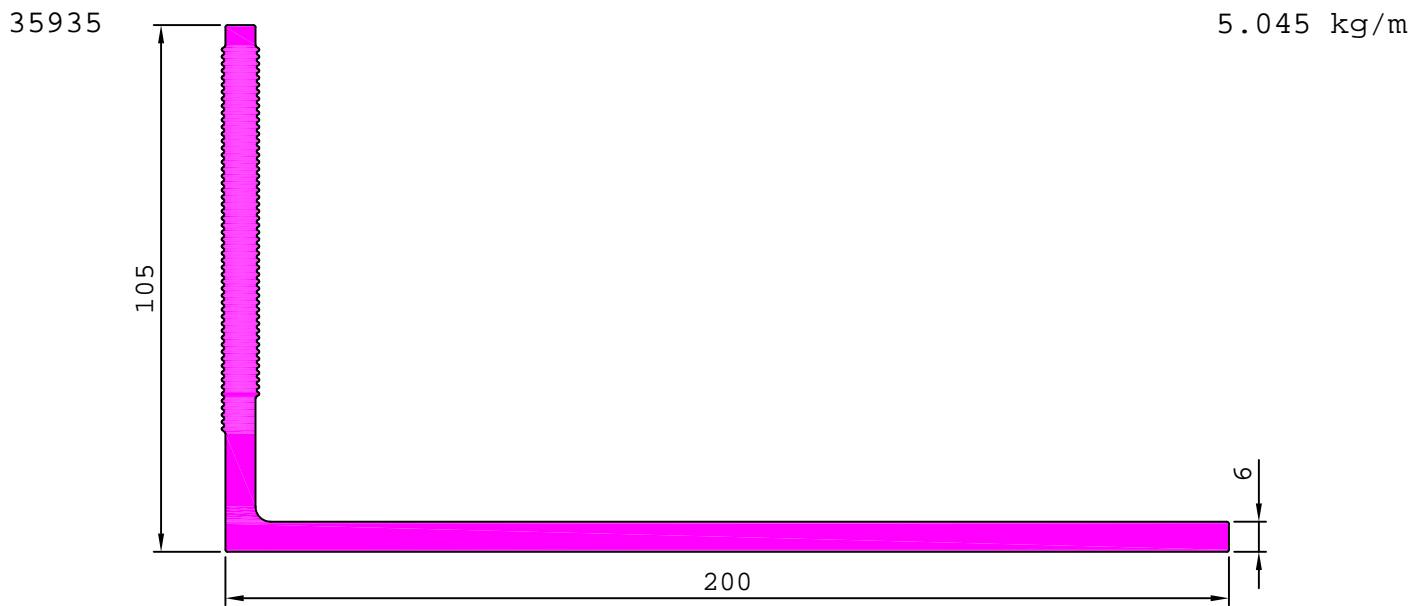
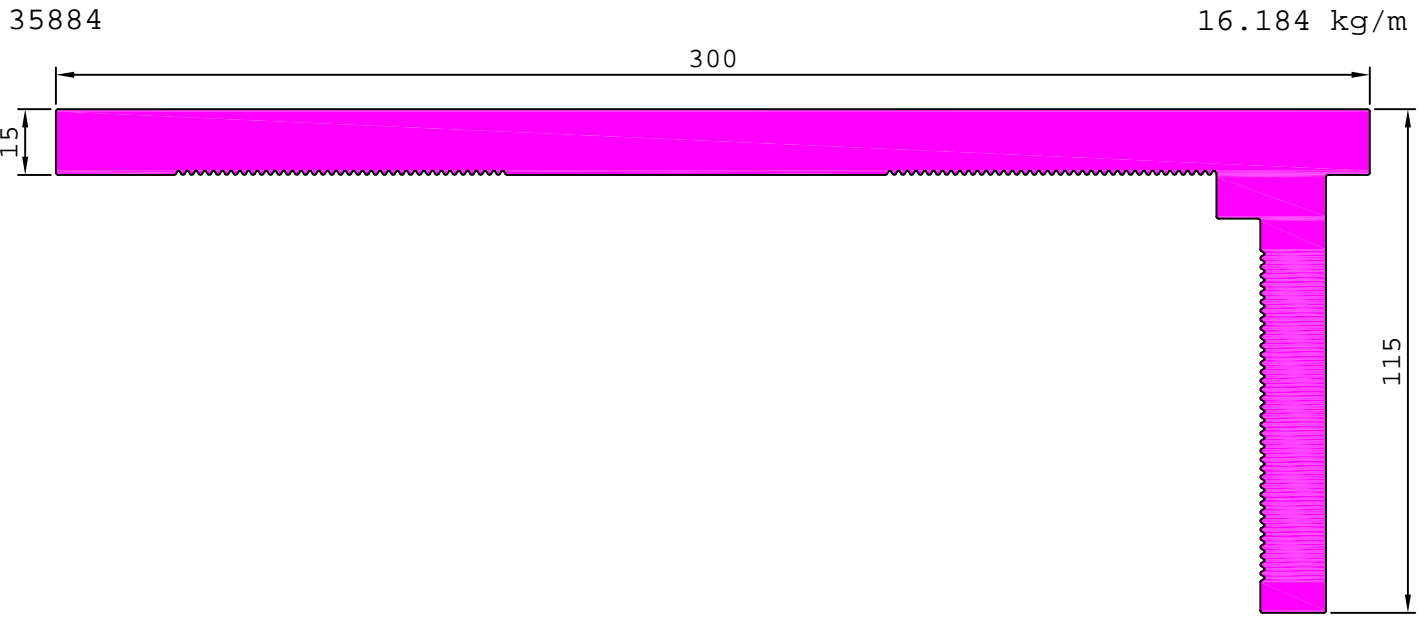

ARCHITECTURAL

CURTAIN WALL SECTION

29551

11.133 kg/m

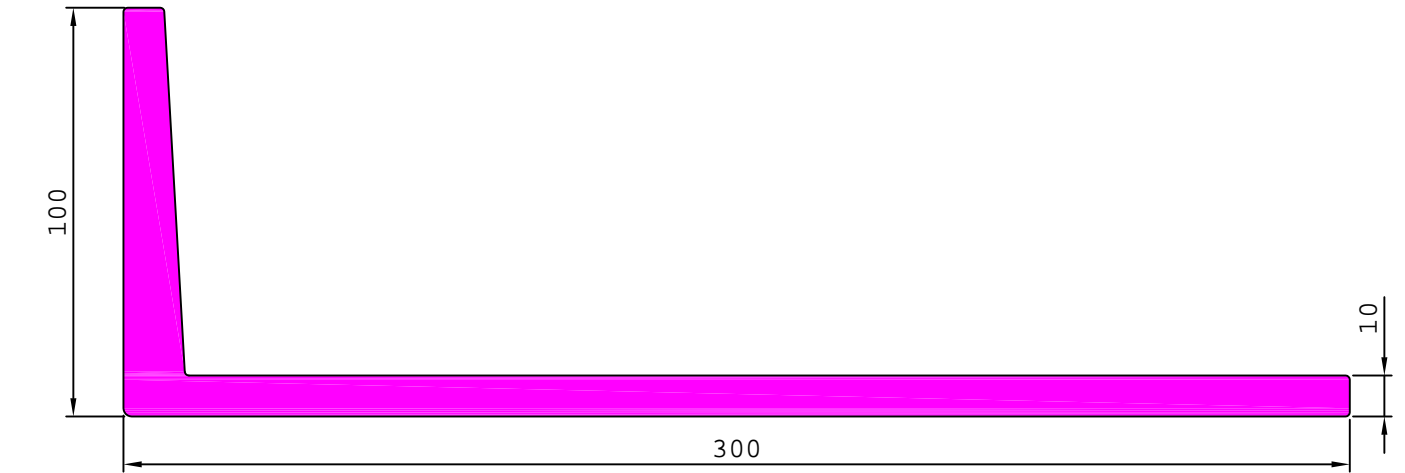

S5025

12.277 kg/m

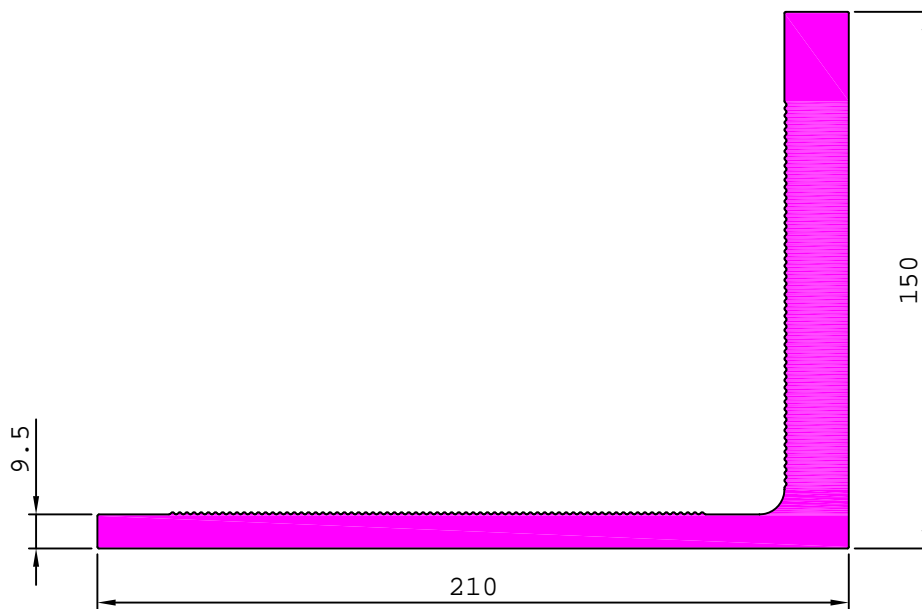

S4955

4.860 kg/m

22912

2.504 kg/m

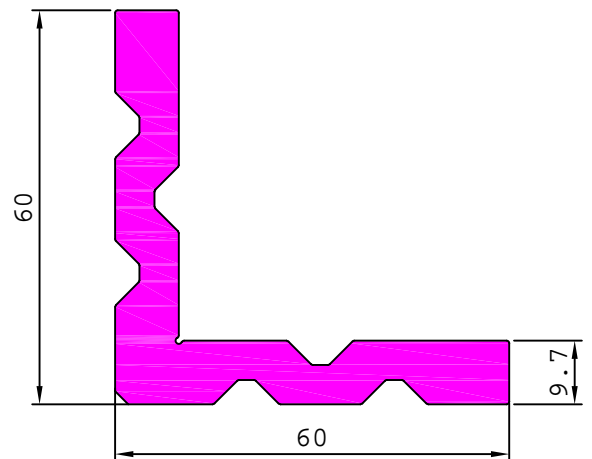
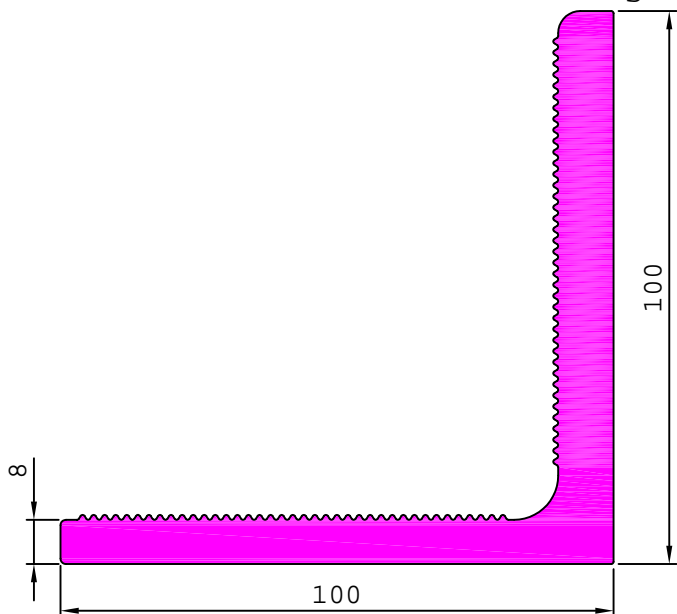

ARCHITECTURAL

CURTAIN WALL SECTION

35561

19.995 kg/m

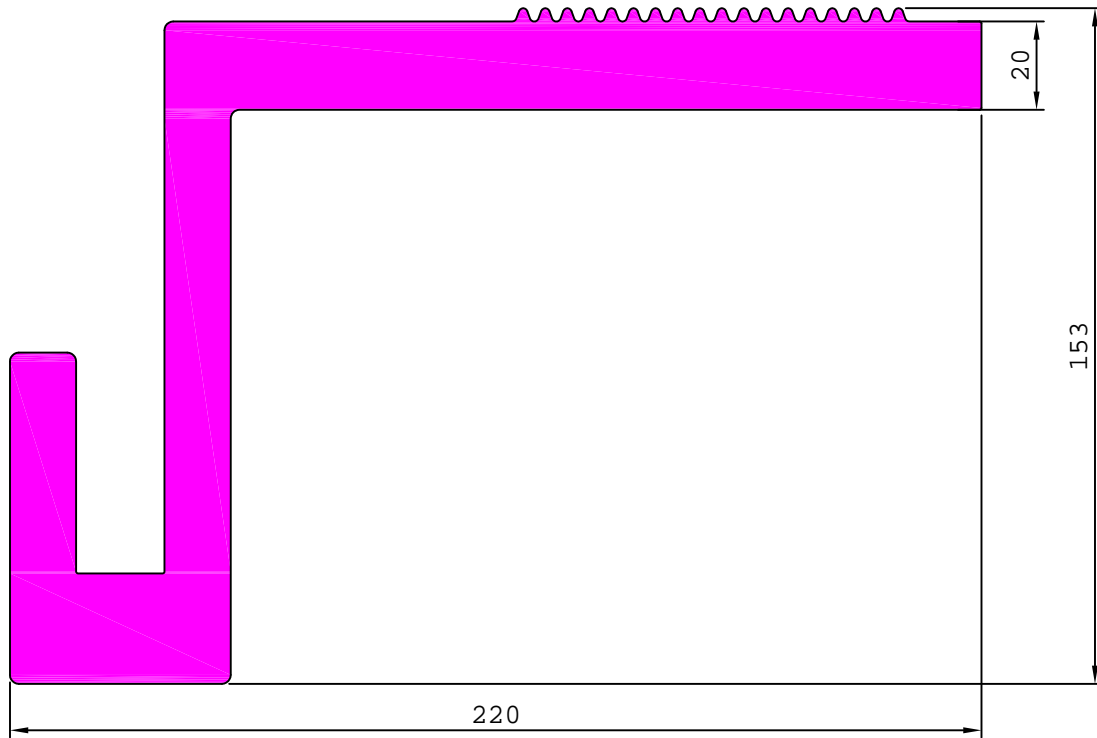

ARCHITECTURAL

CURTAIN WALL SECTION

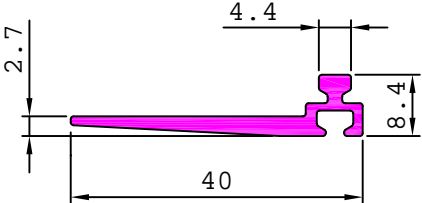
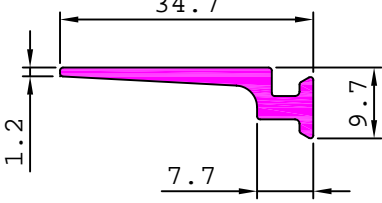
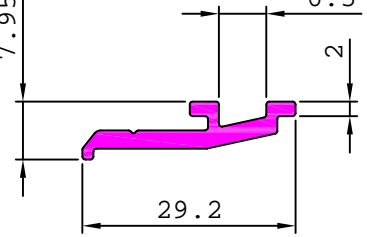
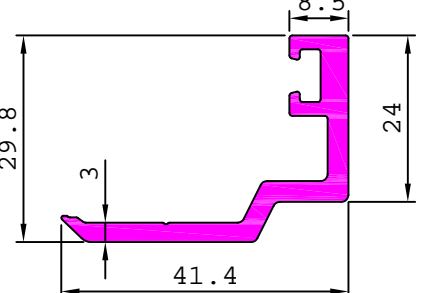
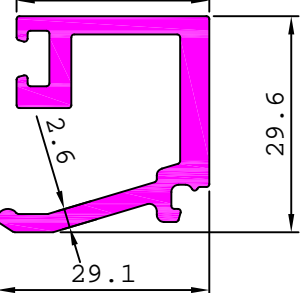
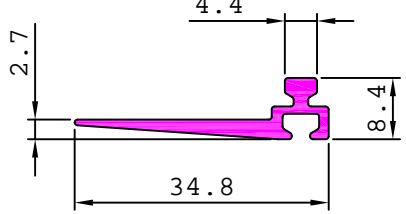
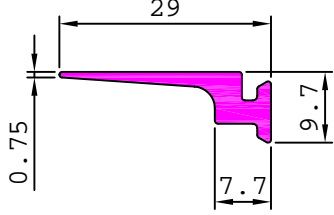
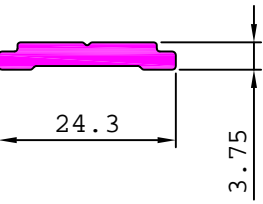
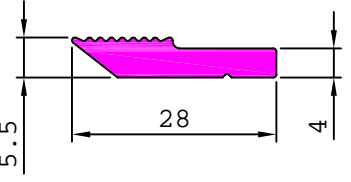
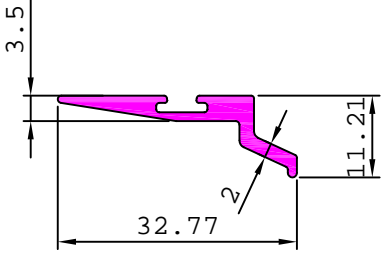
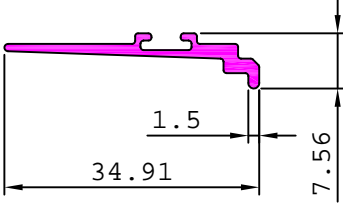
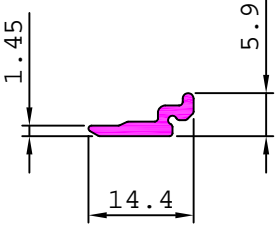
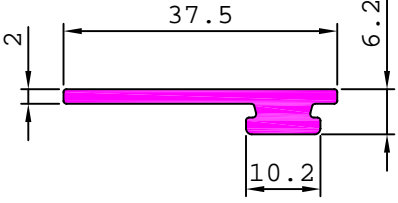
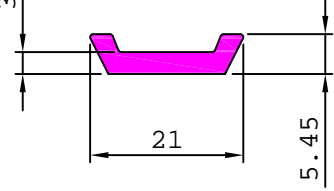
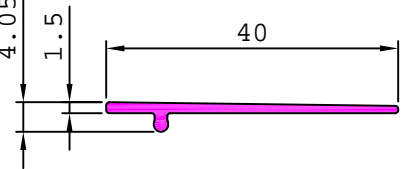
<p>29038 0.268 kg/m</p> 	<p>29039 0.255 kg/m</p> 	<p>29073 0.230 kg/m</p> 
<p>29082 0.601 kg/m</p> 	<p>29083 0.738 kg/m</p> 	<p>29103 0.215 kg/m</p> 
<p>29104 0.218 kg/m</p> 	<p>29295 0.207 kg/m</p> 	<p>29284 0.308 kg/m</p> 
<p>35560 0.220 kg/m</p> 	<p>35589 0.164 kg/m</p> 	<p>35644 0.083 kg/m</p> 
<p>35660 0.304 kg/m</p> 	<p>35684 0.183 kg/m</p> 	<p>35685 0.147 kg/m</p> 

ARCHITECTURAL

CURTAIN WALL SECTION

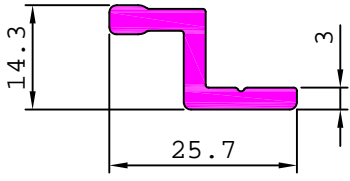
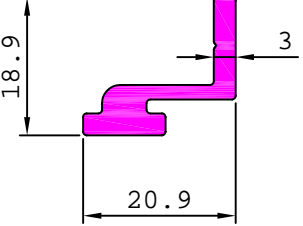
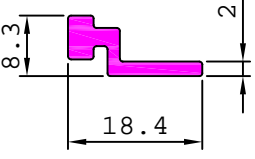
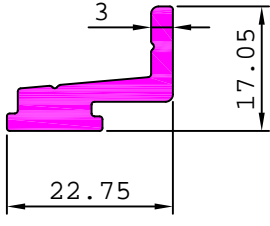
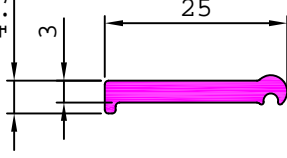
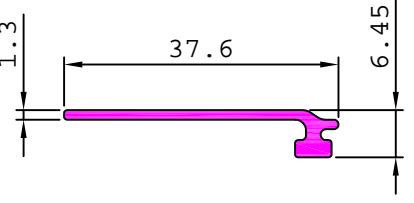
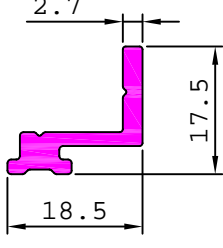
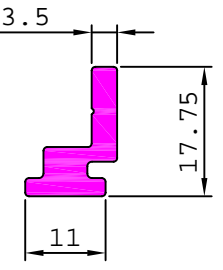
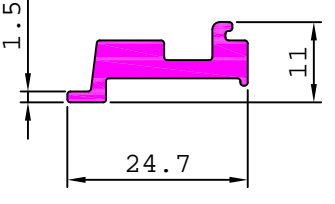
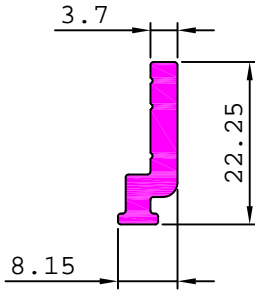
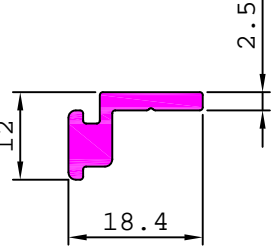
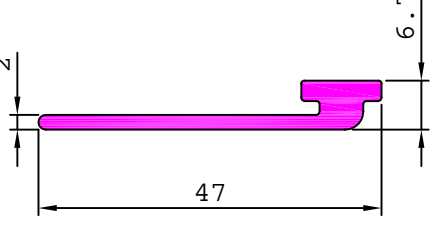
<p>35781 0.305 kg/m</p> 	<p>35784 0.314 kg/m</p> 	<p>35803 0.160 kg/m</p> 
<p>35809 0.358 kg/m</p> 	<p>35832 0.207 kg/m</p> 	<p>35878 0.177 kg/m</p>  <p>MATCHING SECTION No. 35874</p>
<p>35879 0.238 kg/m</p> 	<p>S3838 0.268 kg/m</p> 	<p>S4651 0.294 kg/m</p> 
<p>S5052 0.252 kg/m</p> 	<p>S5054 0.216 kg/m</p> 	<p>S5219 0.349 kg/m</p> 

ARCHITECTURAL

FOOT STEP

22895

0.315 kg/m

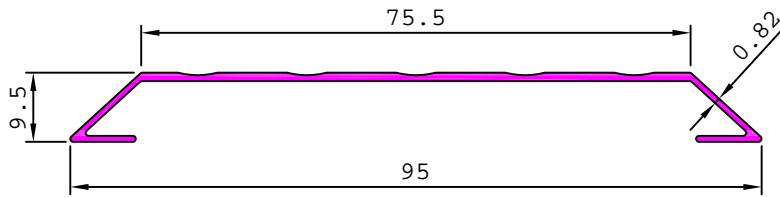

22861

1.588 kg/m

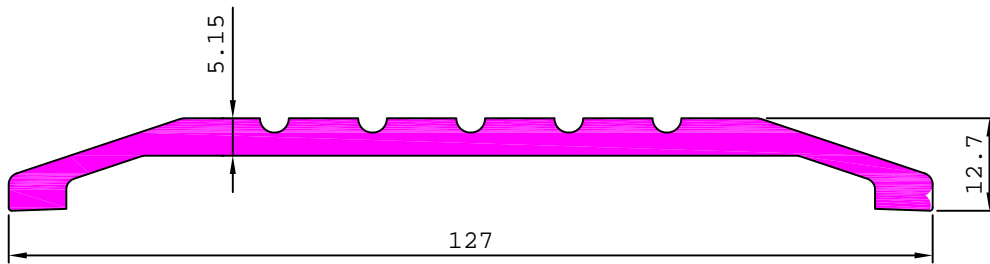

22862

1.926 kg/m

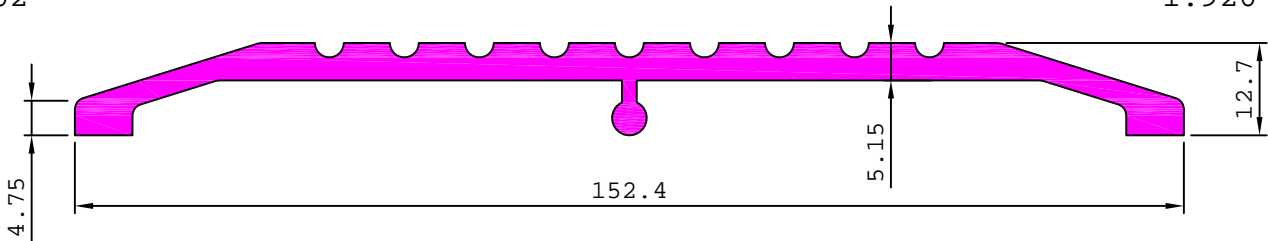

22880

2.085 kg/m

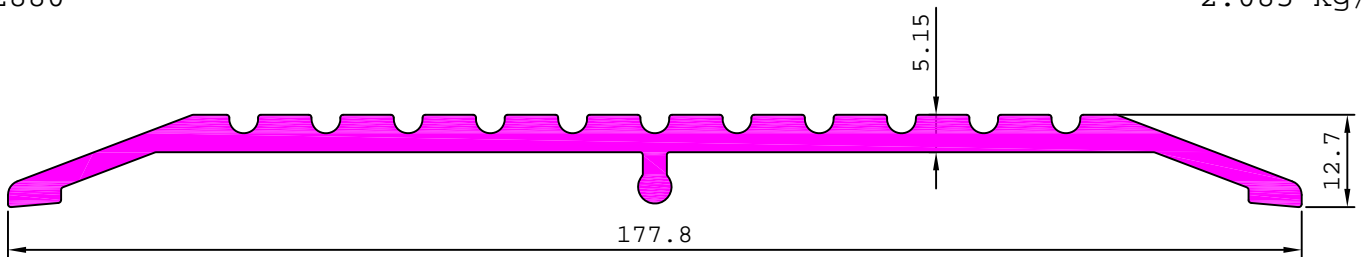

22881

2.430 kg/m

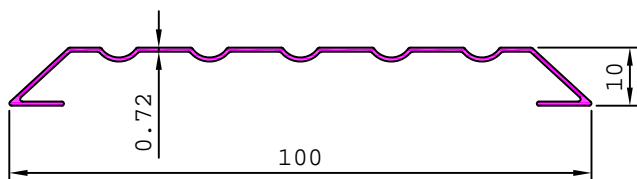
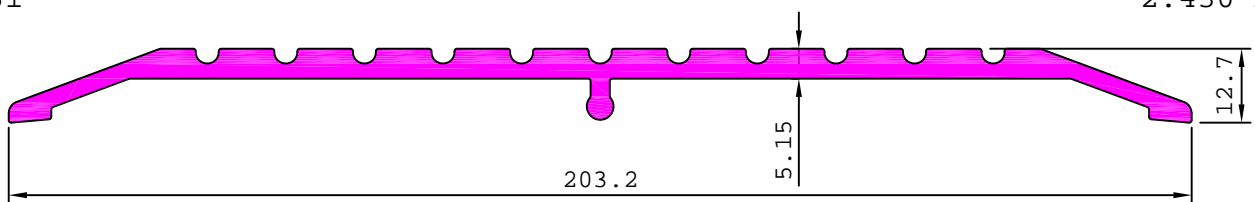

SL. No.	Section No.	A	Weight kg/m
1	22937	0.56	0.199
2	22899	0.72	0.253

22907

1.268 kg/m

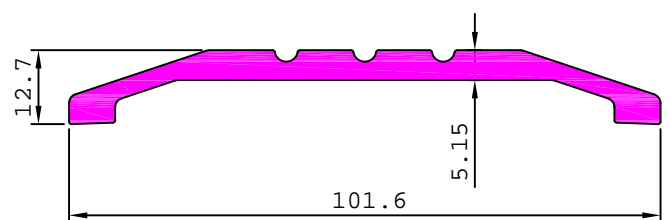

ARCHITECTURAL

MISCELLANEOUS

22934 0.064 kg/m

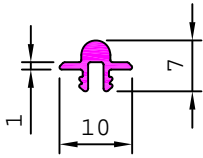

22940 0.081 kg/m

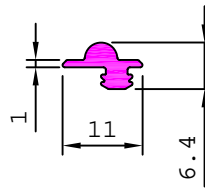

29058 0.095 kg/m

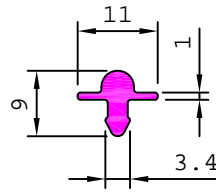

29416 0.135 kg/m

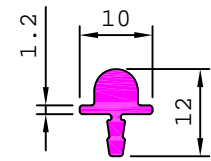

22986 0.081 kg/m

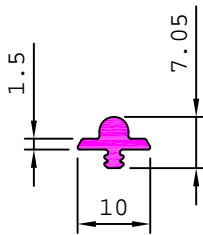

38504 0.050 kg/m

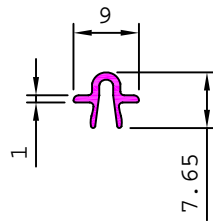

29436 0.081 kg/m

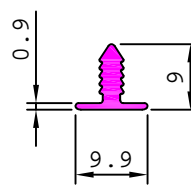

38519 0.127 kg/m

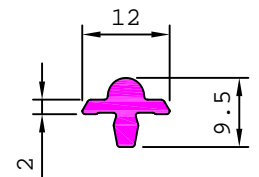

S4997 0.127 kg/m

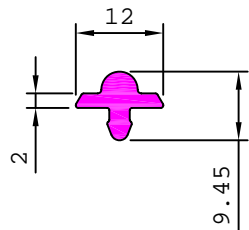

22960 0.026 kg/m

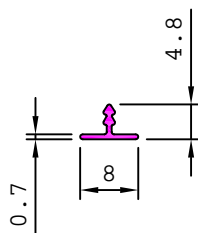

22961 0.023 kg/m

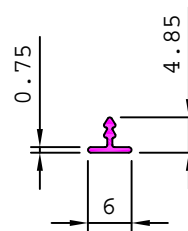

22962 0.035 kg/m

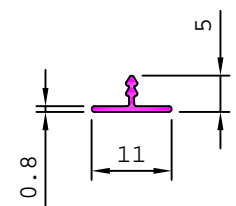

29594 0.025 kg/m

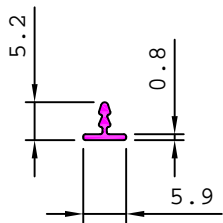

ARCHITECTURAL

MISCELLANEOUS

22851 0.339 kg/m

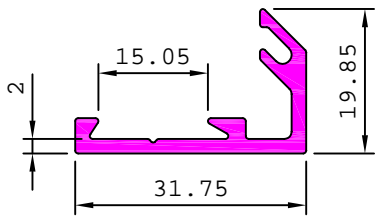

22856 0.165 kg/m

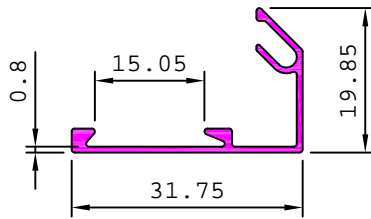

22857 0.287 kg/m

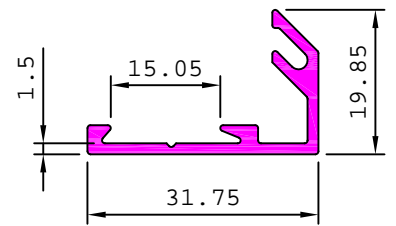

22858 0.219 kg/m

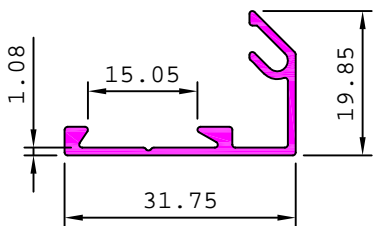

22866 1.020 kg/m

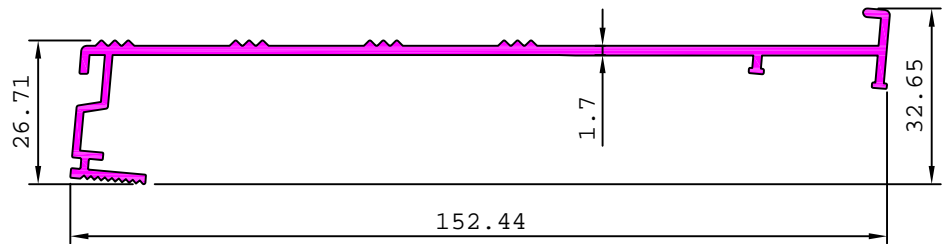

22852

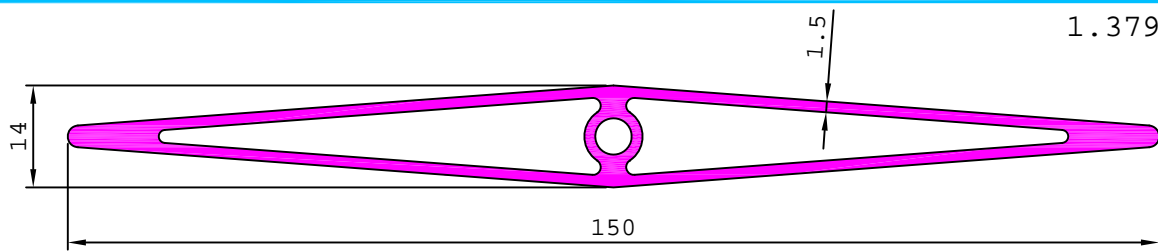

1.379 kg/m

22867 0.655 kg/m

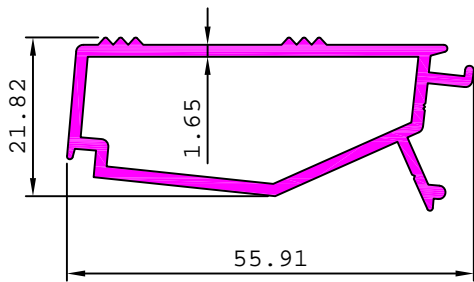

22876 0.659 kg/m

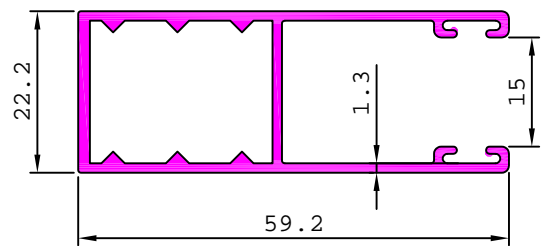

22869 0.574 kg/m

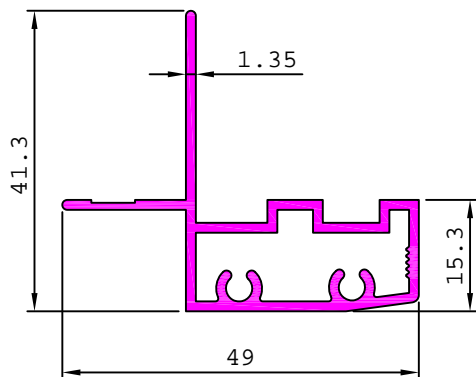

22877 0.481 kg/m

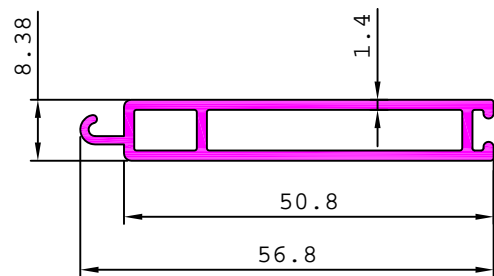

ARCHITECTURAL

MISCELLANEOUS

22873

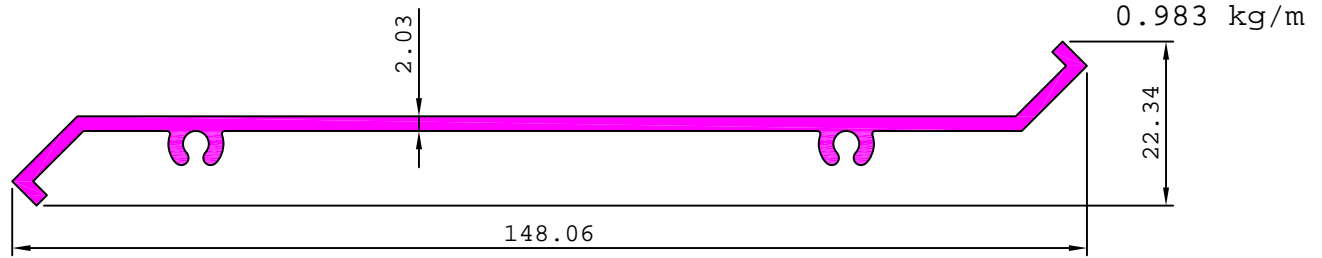

22885

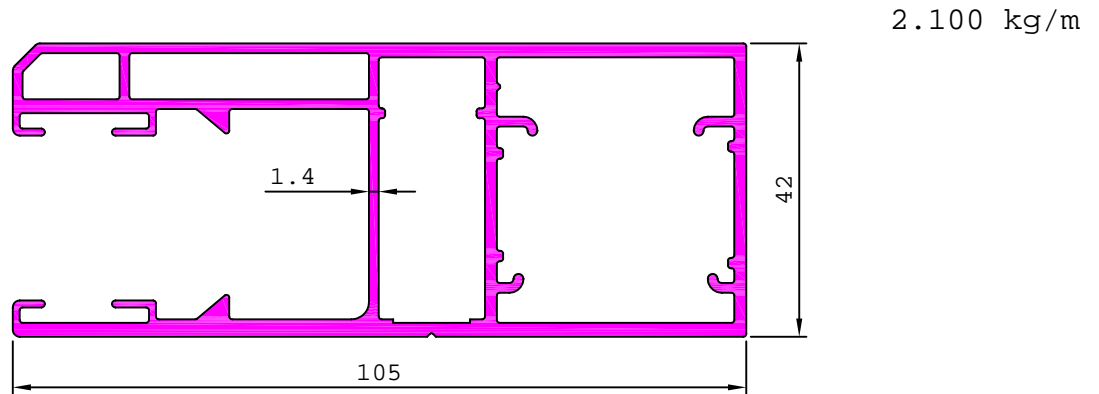

22892

0.480 kg/m

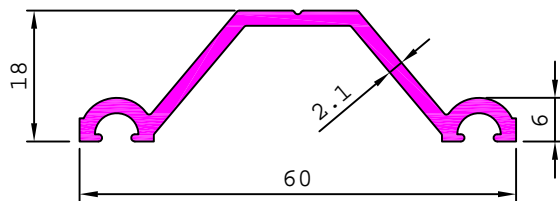

22893

0.900 kg/m

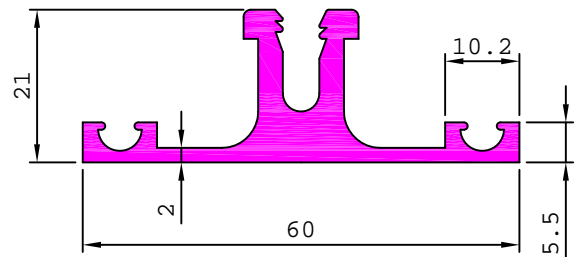

22894

0.727 kg/m

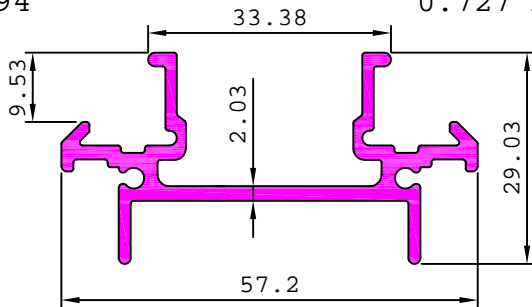

22897

2.216 kg/m

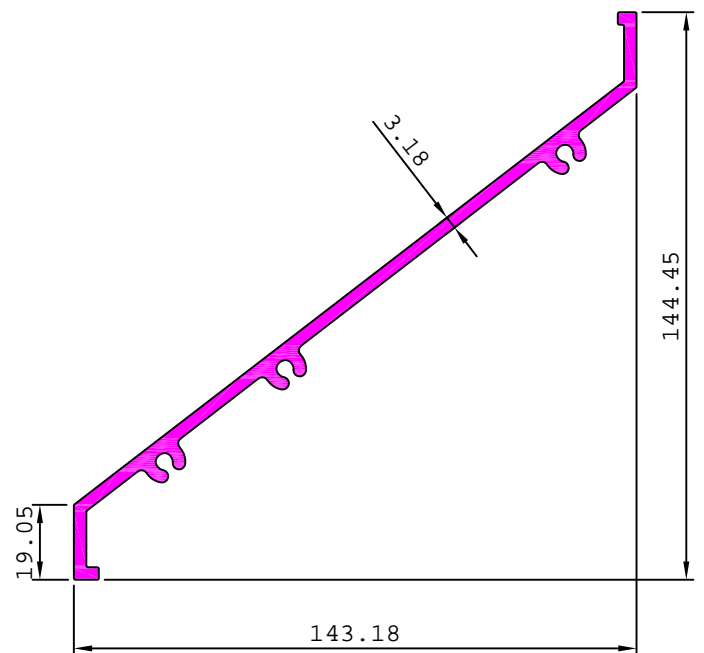

22900

0.894 kg/m

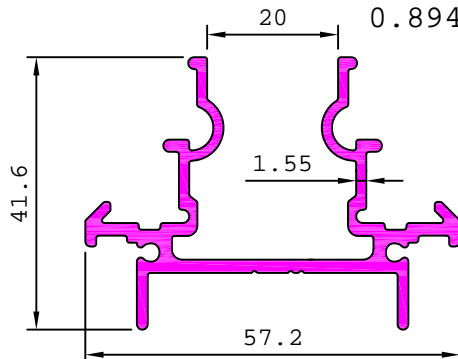

ARCHITECTURAL

MISCELLANEOUS

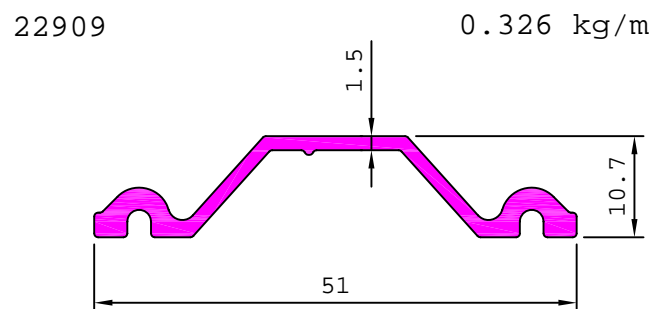
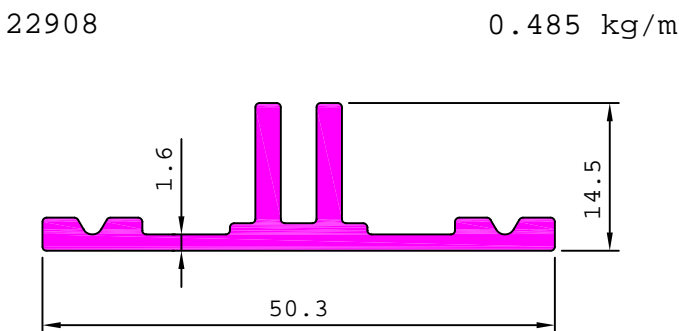
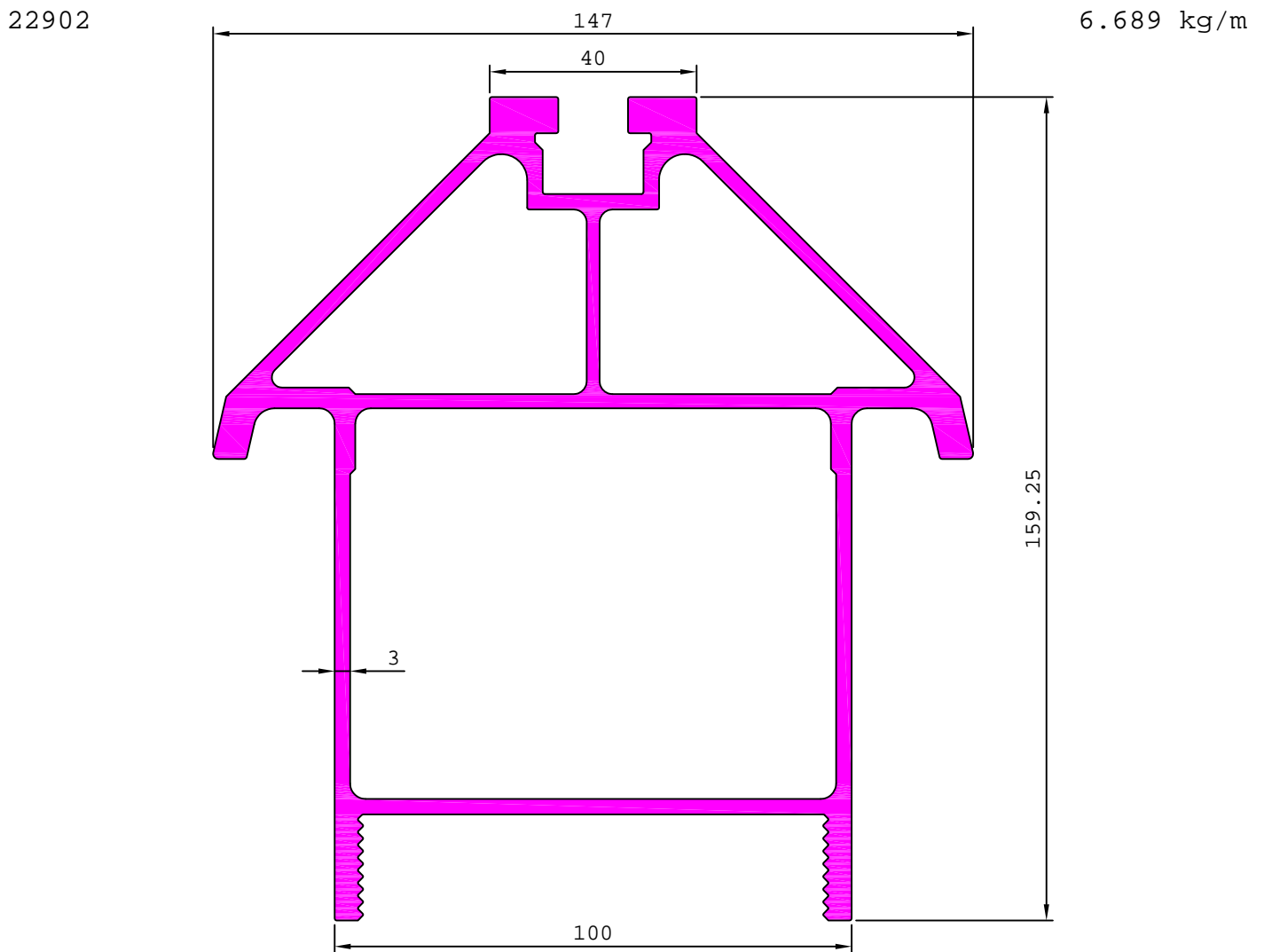
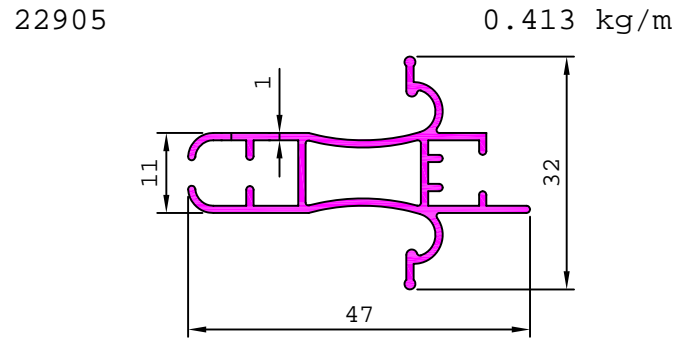
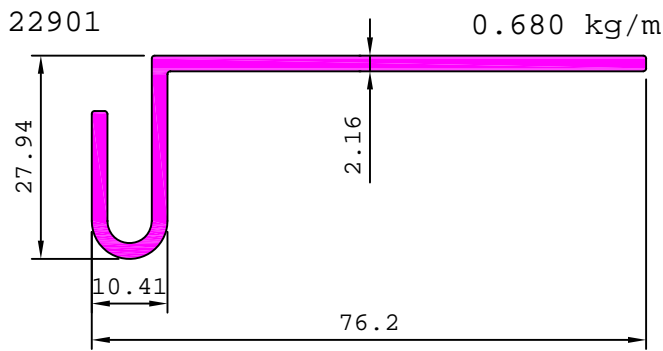

ARCHITECTURAL

MISCELLANEOUS

22910

1.137 kg/m

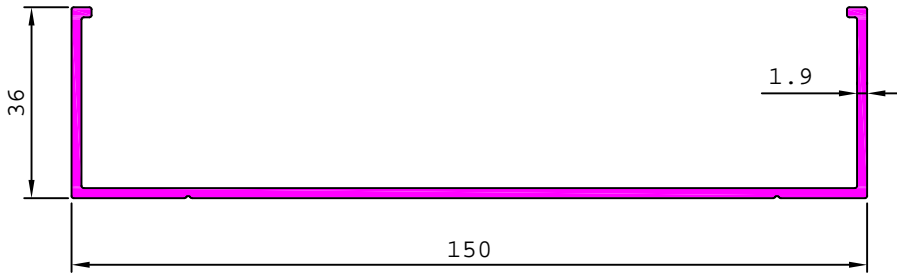

22915

0.579 kg/m

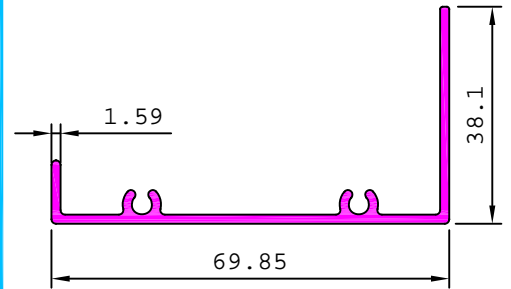

22911

2.805 kg/m

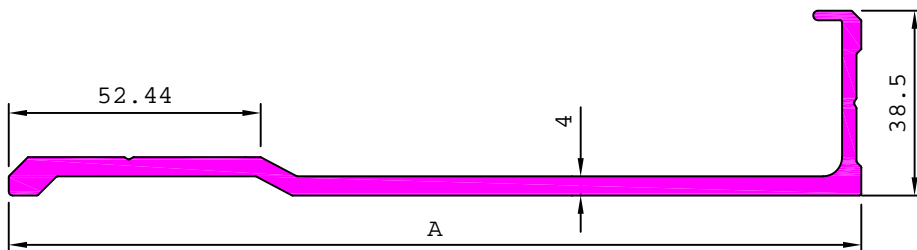
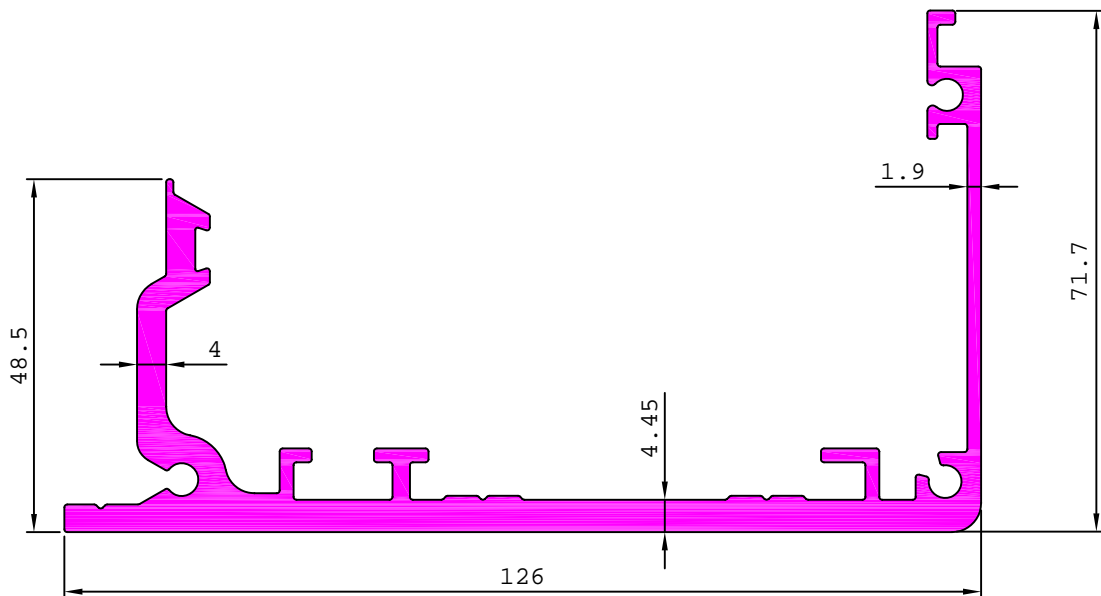

SL. No.	Section No.	A	Weight kg/m
1	22927	140.00	1.929
2	22928	165.00	2.199
3	22913	177.50	2.334

22917

5.569 kg/m

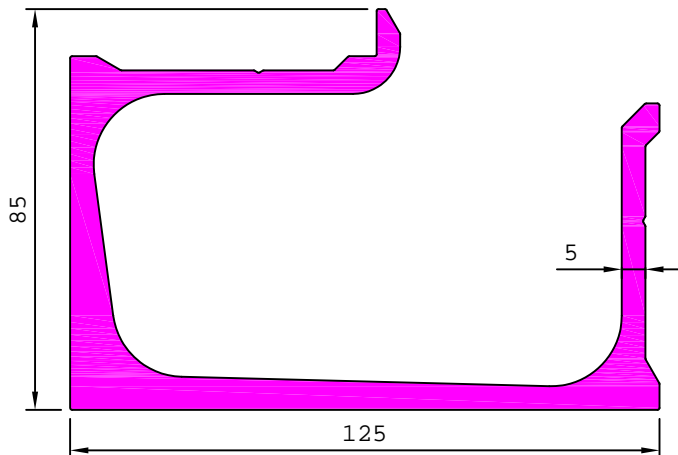

22918

5.357 kg/m

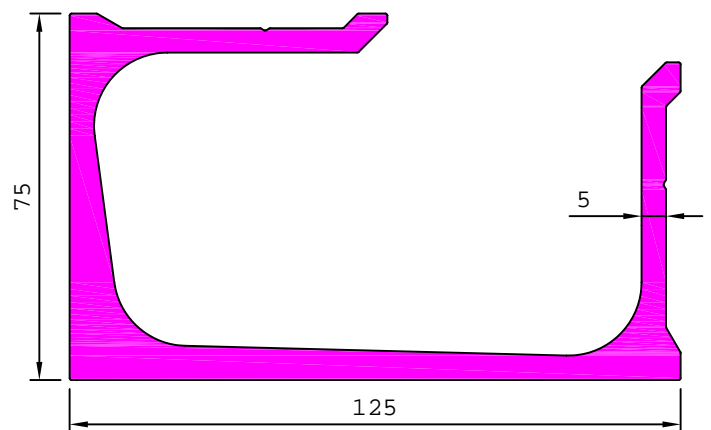

ARCHITECTURAL

MISCELLANEOUS

22916

0.808 kg/m

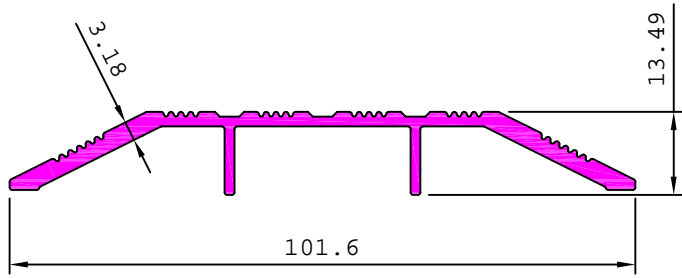

22920

1.369 kg/m

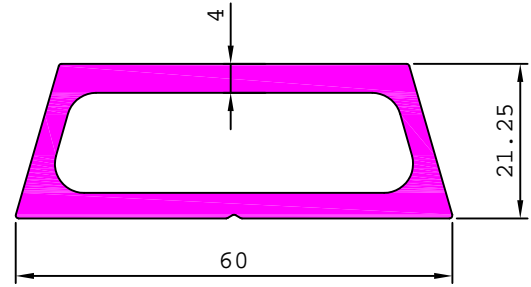

22919

2.966 kg/m

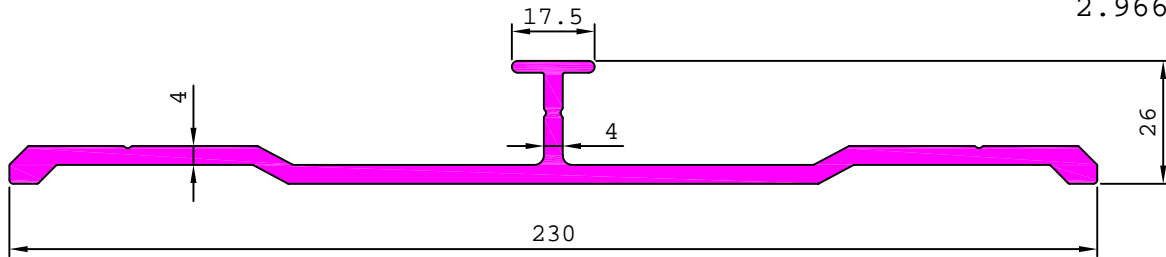

22922

0.555 kg/m

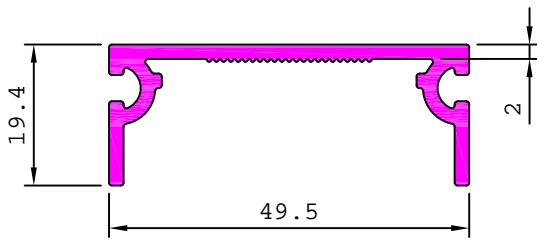

22921

0.971 kg/m

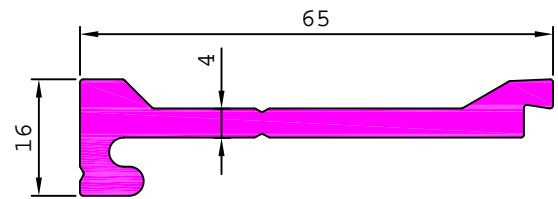

22923

0.724 kg/m

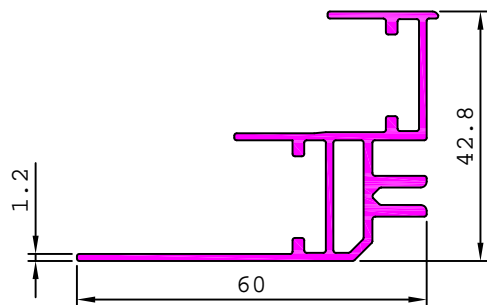

22926

1.493 kg/m

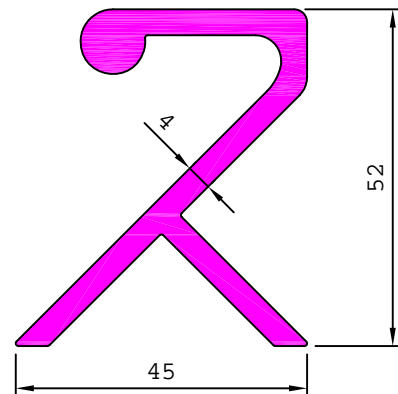

22924

2.277 kg/m

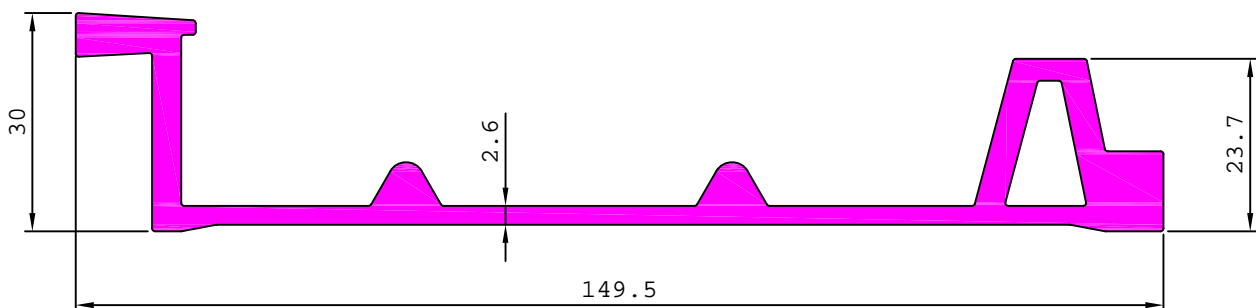

ARCHITECTURAL

MISCELLANEOUS

22925

2.510 kg/m

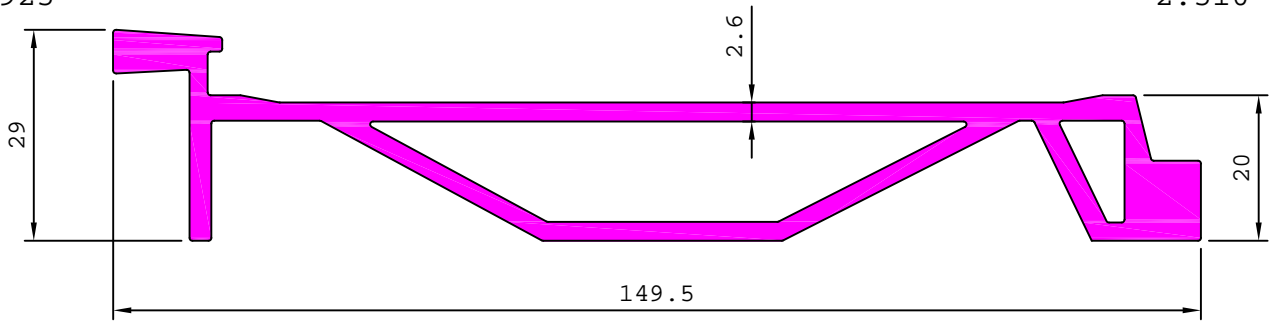

22929

1.203 kg/m

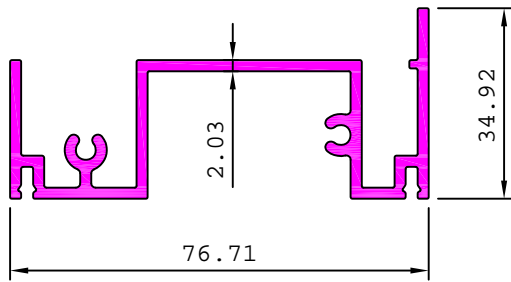

22935

0.491 kg/m

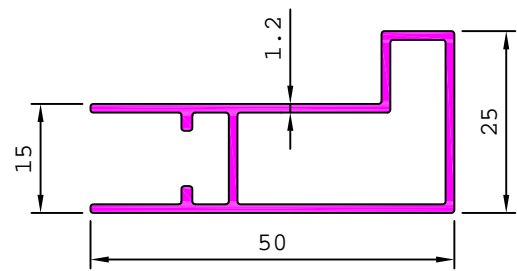

22930

1.233 kg/m

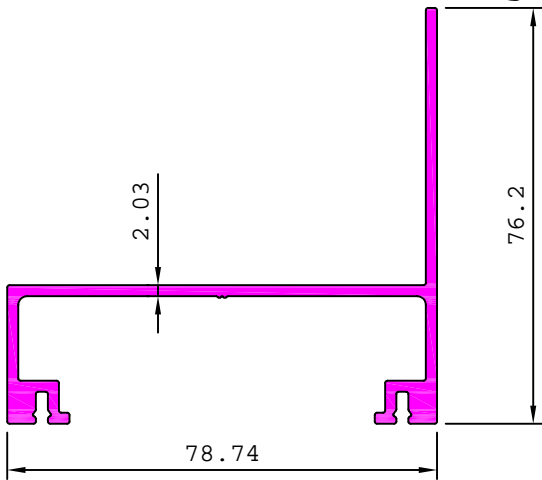

22932

0.653 kg/m

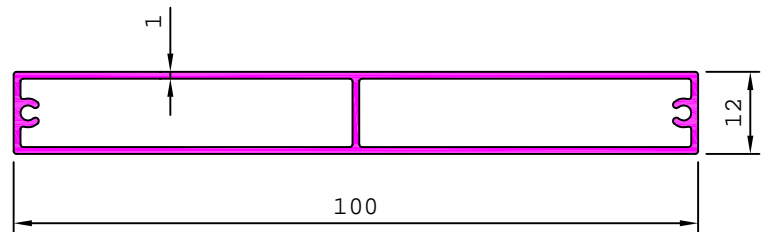

22931

1.596 kg/m

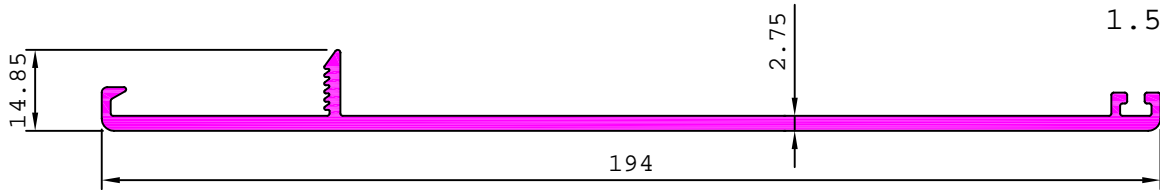

22938

1.146 kg/m

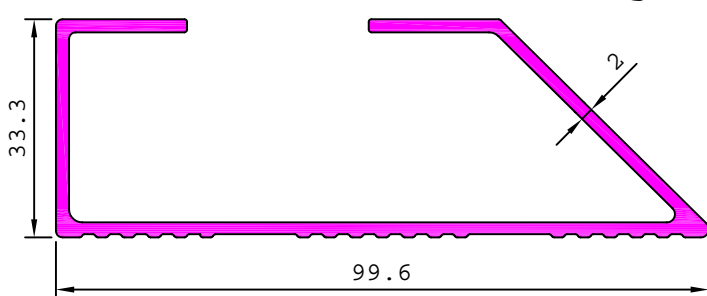

22939

1.294 kg/m

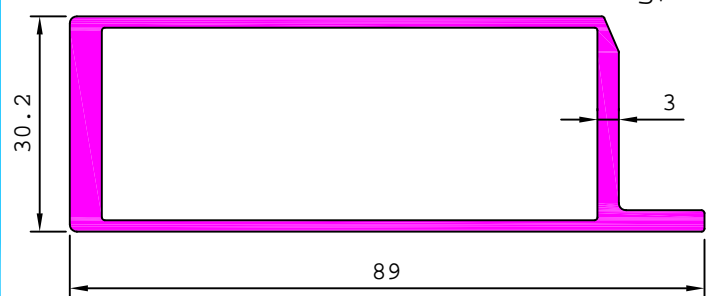

ARCHITECTURAL

MISCELLANEOUS

22933

2.220 kg/m

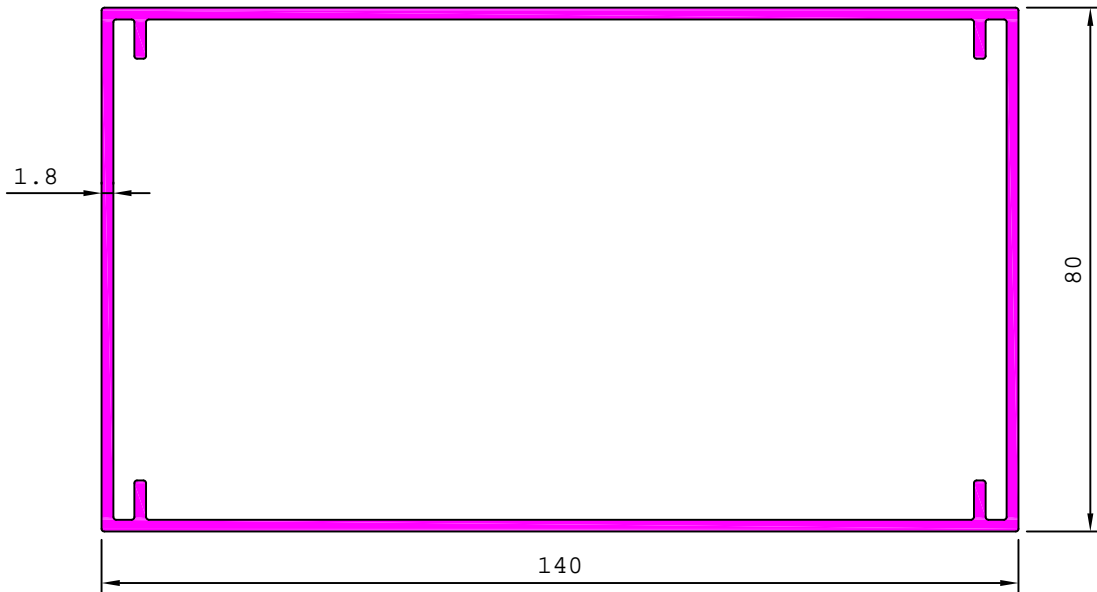

22941

0.939 kg/m

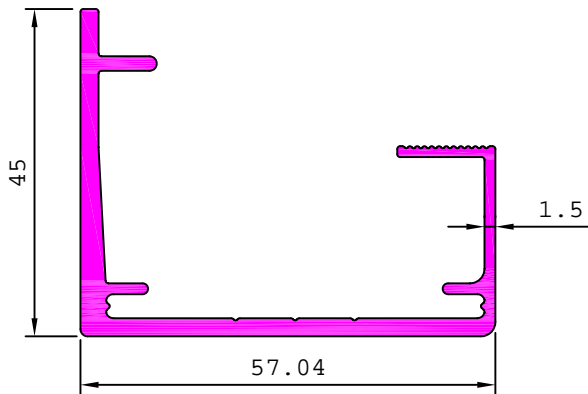

22942

1.084 kg/m

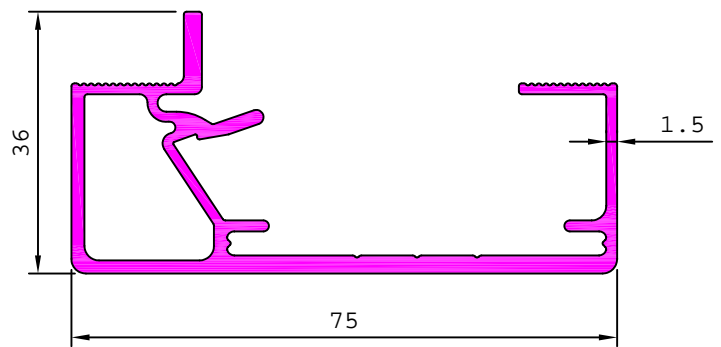

22944

0.329 kg/m

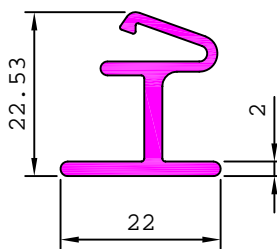

22948

0.884 kg/m

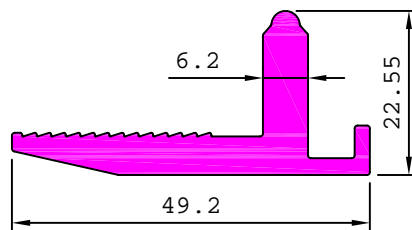

22949

0.601 kg/m

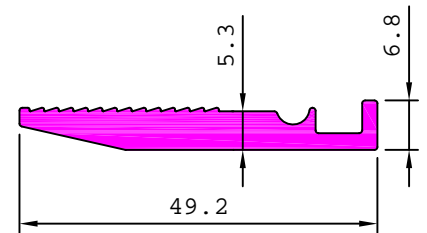

22952

1.715 kg/m

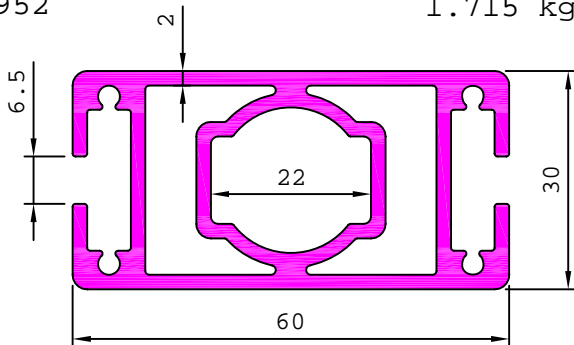

22953

1.446 kg/m

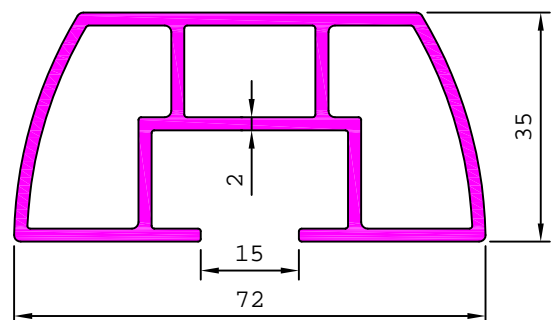

ARCHITECTURAL

MISCELLANEOUS

22946

1.889 kg/m

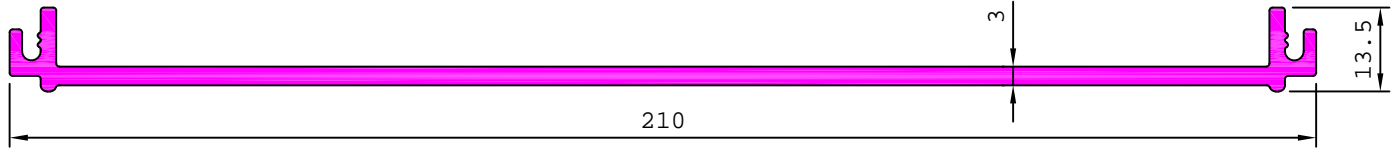

22950

1.971 kg/m

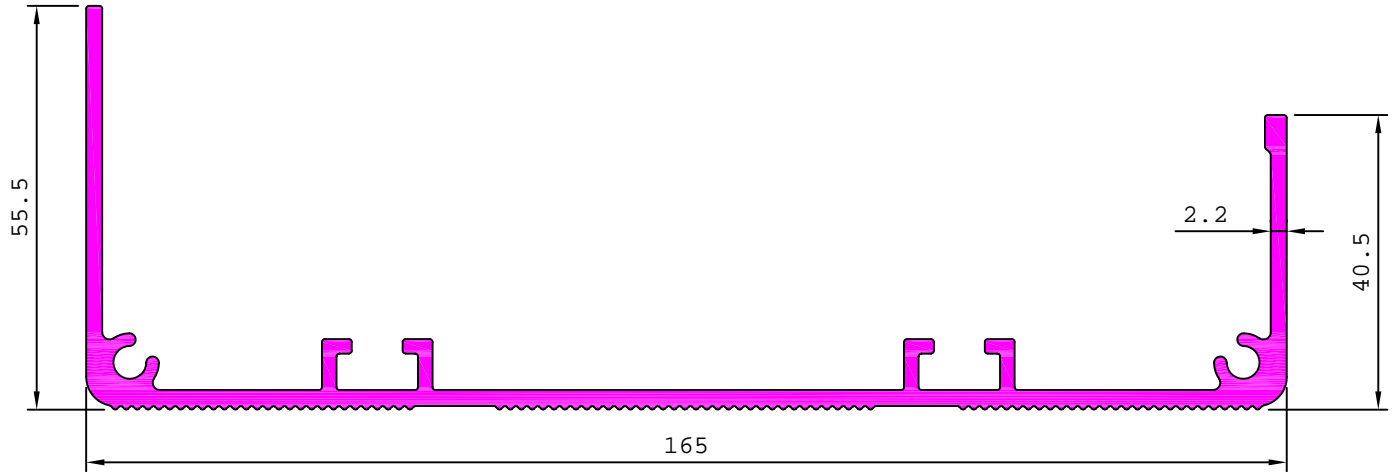

22959 0.470 kg/m

22963

1.662 kg/m

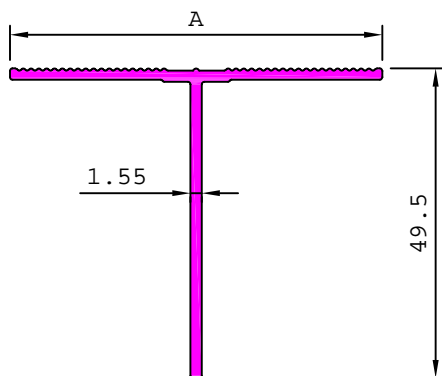
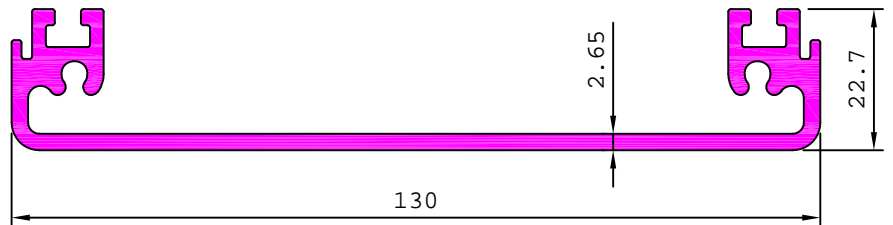
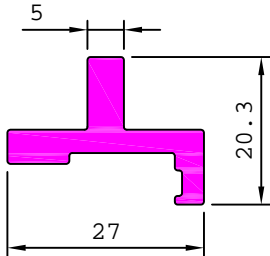

SL. No.	Section No.	A	Weight kg/m
1	22965	59.50	0.498
2	22966	119.50	0.761
3	22978	79.50	0.586
4	22977	99.50	0.674

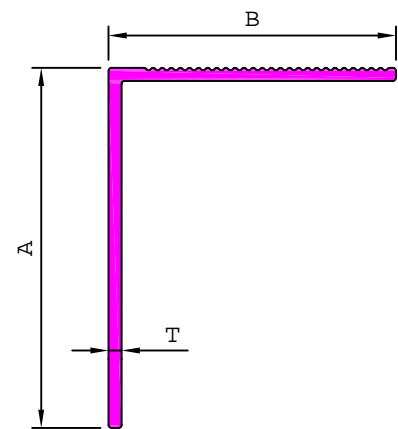

SL. No.	Section No.	A	B	T	Weight kg/m
1	23419	19.50	39.50	1.20	0.173
2	22964	49.50	39.50	1.80	0.407
3	22975	59.50	49.50	1.20	0.328

ARCHITECTURAL

MISCELLANEOUS

22967

0.845 kg/m

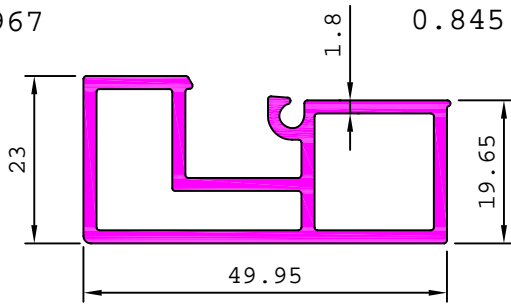

22970

3.232 kg/m

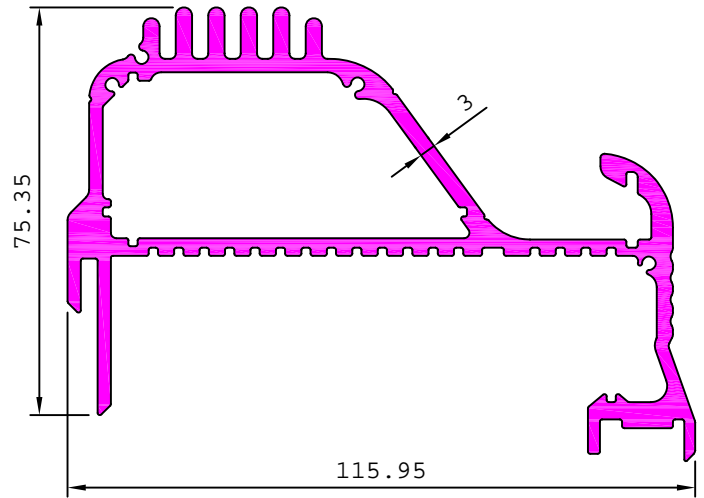

22968

0.597 kg/m

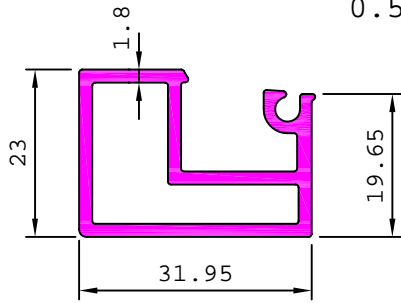

22969

0.171 kg/m

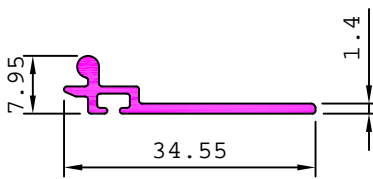

22974

0.609 kg/m

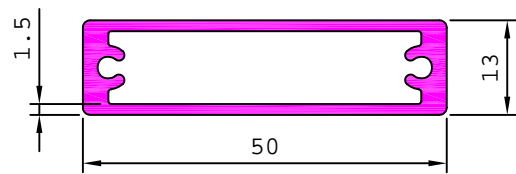

22971

0.133 kg/m

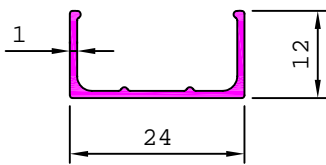

22972

0.119 kg/m

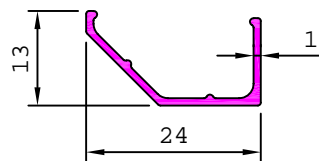

22976

0.225 kg/m

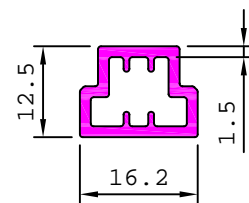

22979

0.180 kg/m

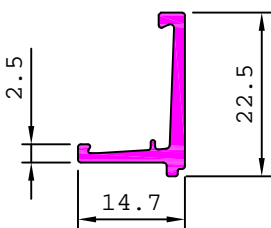

22980

0.383 kg/m

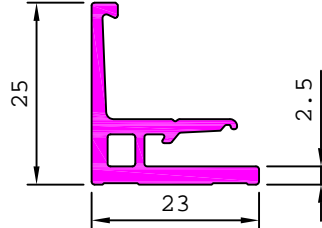

22982

0.335 kg/m

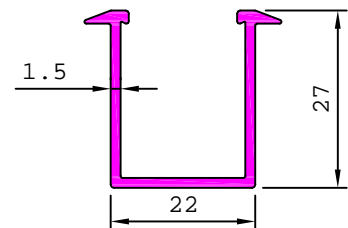

22984

0.487 kg/m

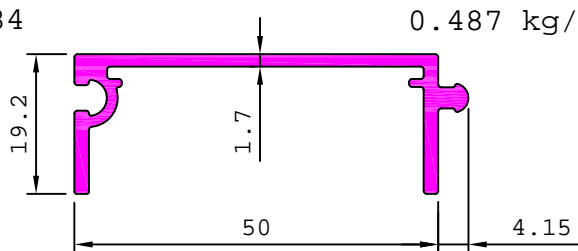

22985

0.307 kg/m

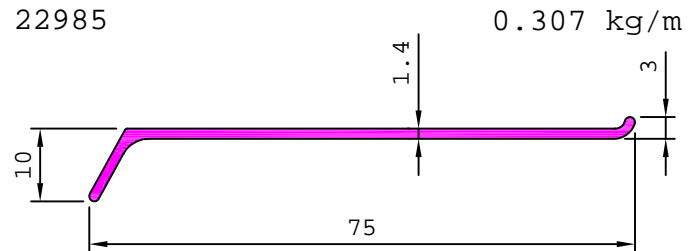

ARCHITECTURAL

MISCELLANEOUS

15200 0.873 kg/m

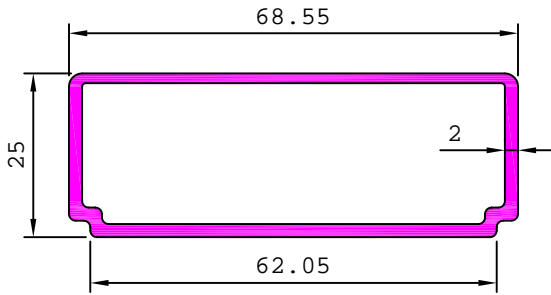

15201 0.578 kg/m

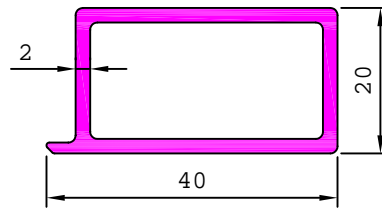

15231 0.300 kg/m

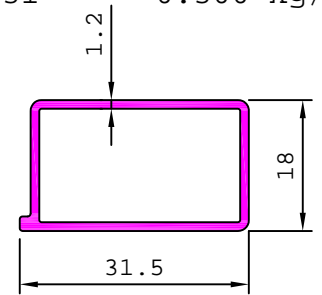

22973 0.447 kg/m

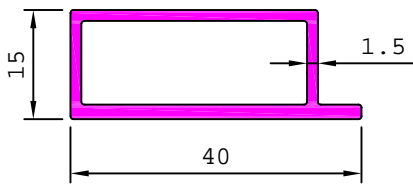

22987 0.192 kg/m

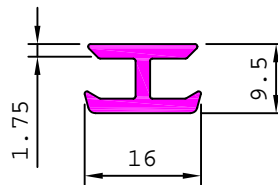

22988 0.116 kg/m

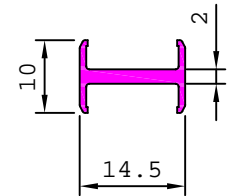

22981 1.069 kg/m

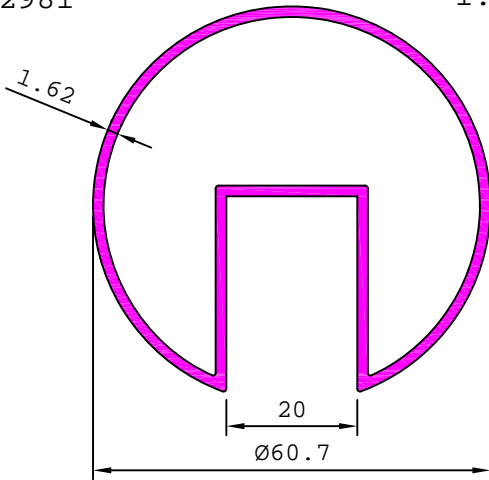

22991 0.996 kg/m

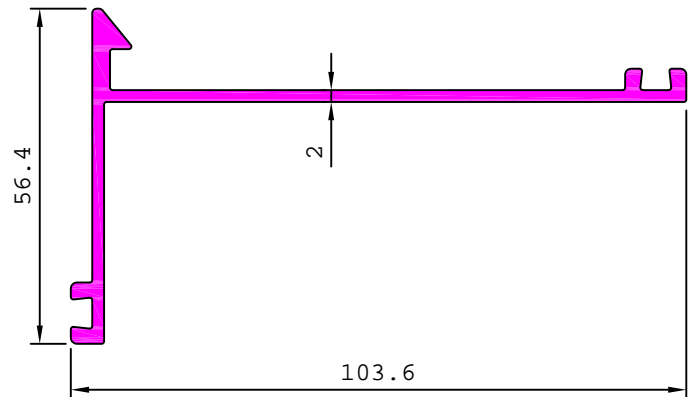

22983 8.217 kg/m

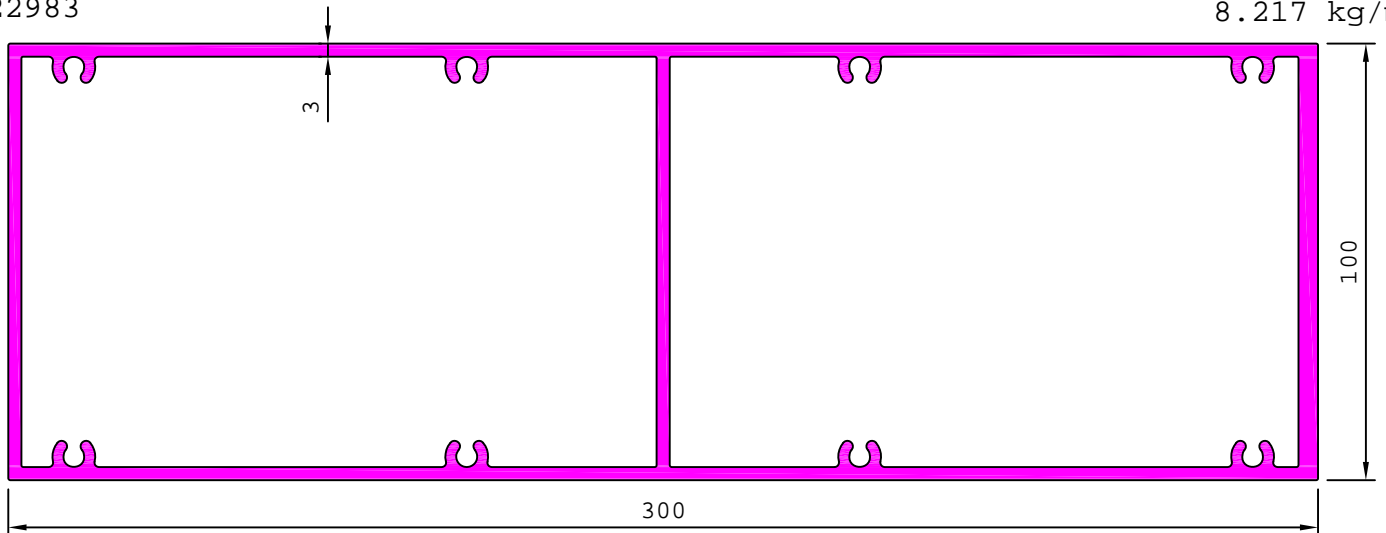

ARCHITECTURAL

MISCELLANEOUS

22989

1.004 kg/m

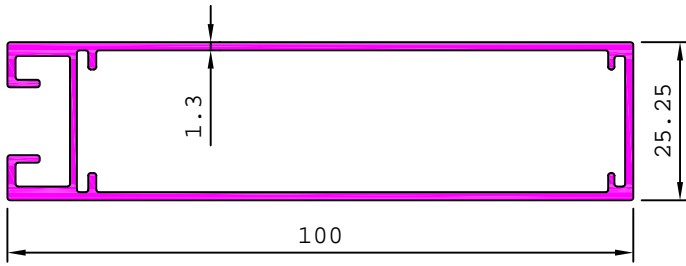

22992

0.260 kg/m

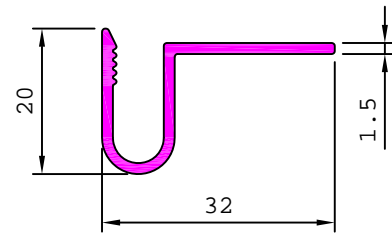

22990

1.041 kg/m

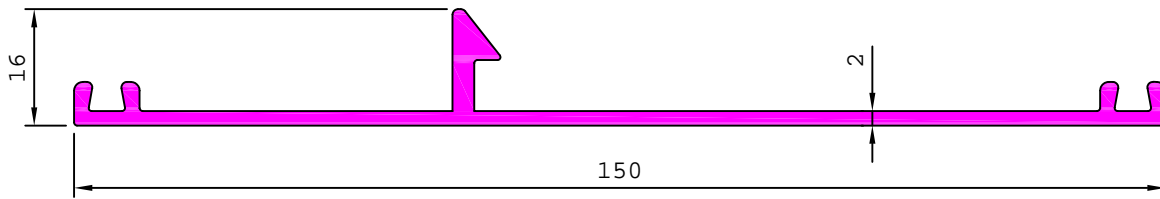

22993

0.340 kg/m

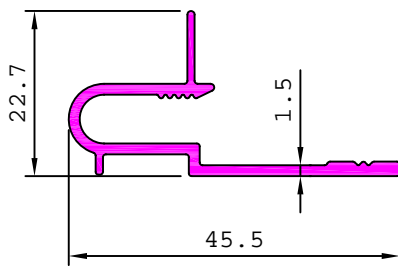

22994

0.386 kg/m

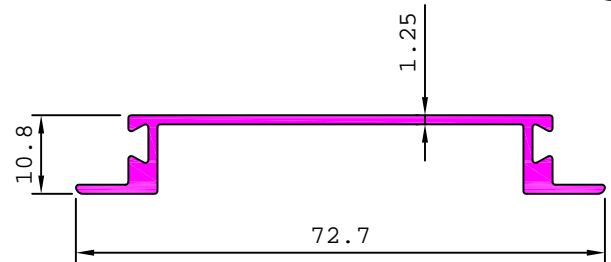

22995

1.235 kg/m

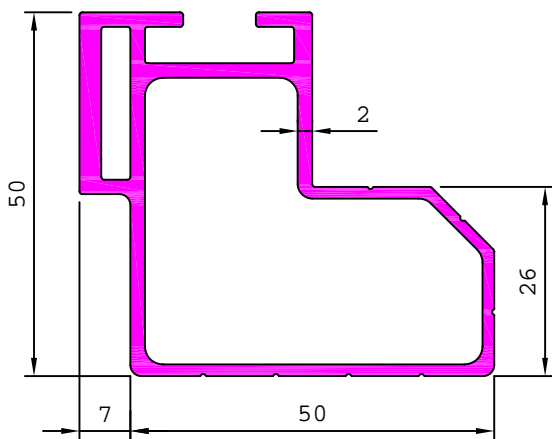

25179

1.124 kg/m

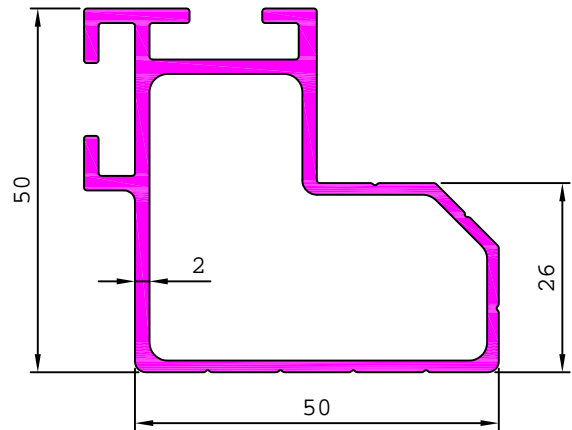

22996

1.726 kg/m

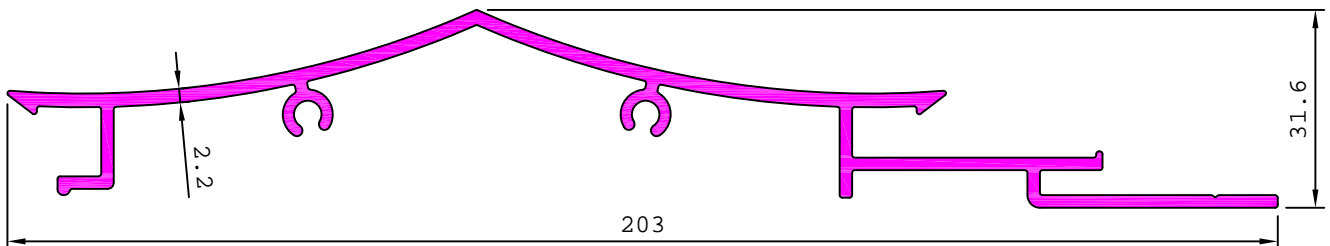

ARCHITECTURAL

MISCELLANEOUS

22997 0.255 kg/m

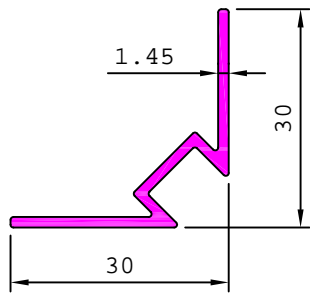

23000 0.161 kg/m

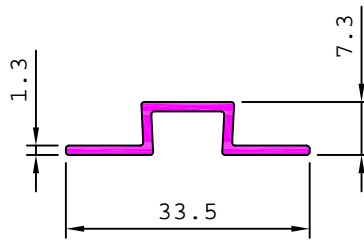

38506 0.228 kg/m

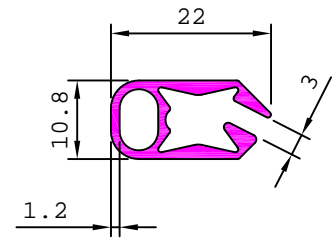

22998 0.381 kg/m

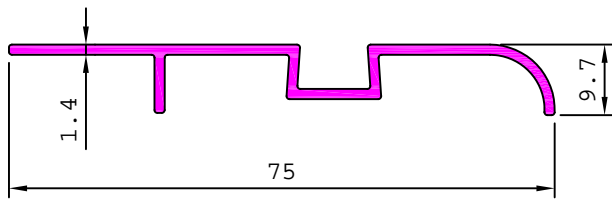

38502 0.399 kg/m

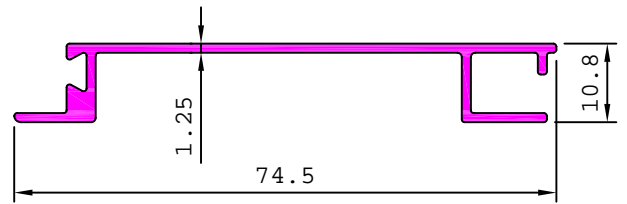

38501 1.017 kg/m

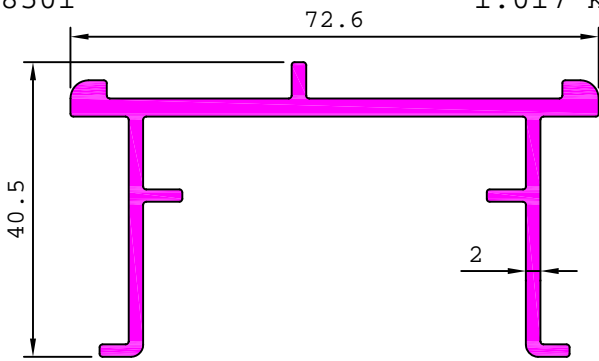

22999 1.117 kg/m

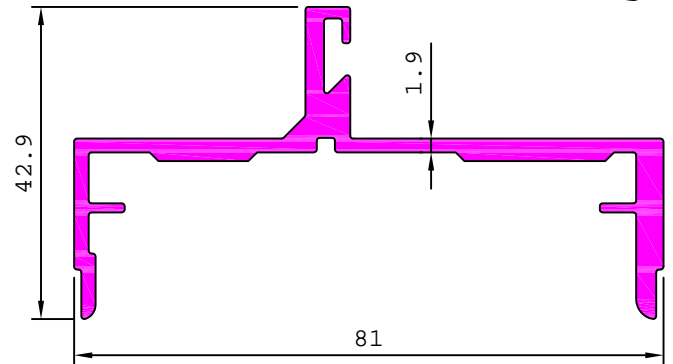

38503 0.896 kg/m

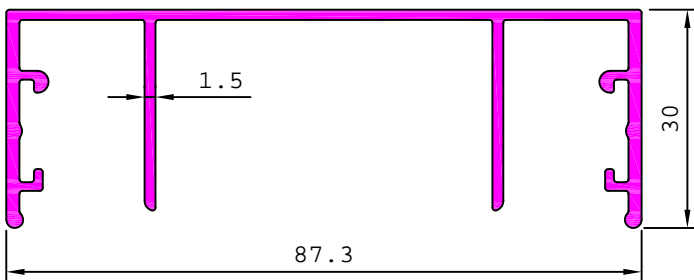

38505 0.517 kg/m

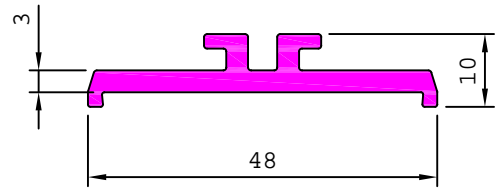

38507 0.429 kg/m

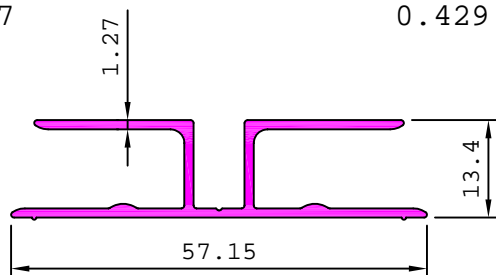

38508 0.347 kg/m

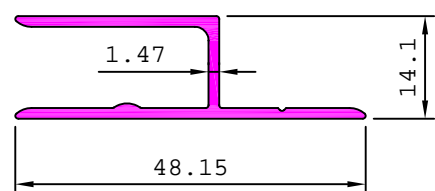

ARCHITECTURAL

MISCELLANEOUS

38509

2.311 kg/m

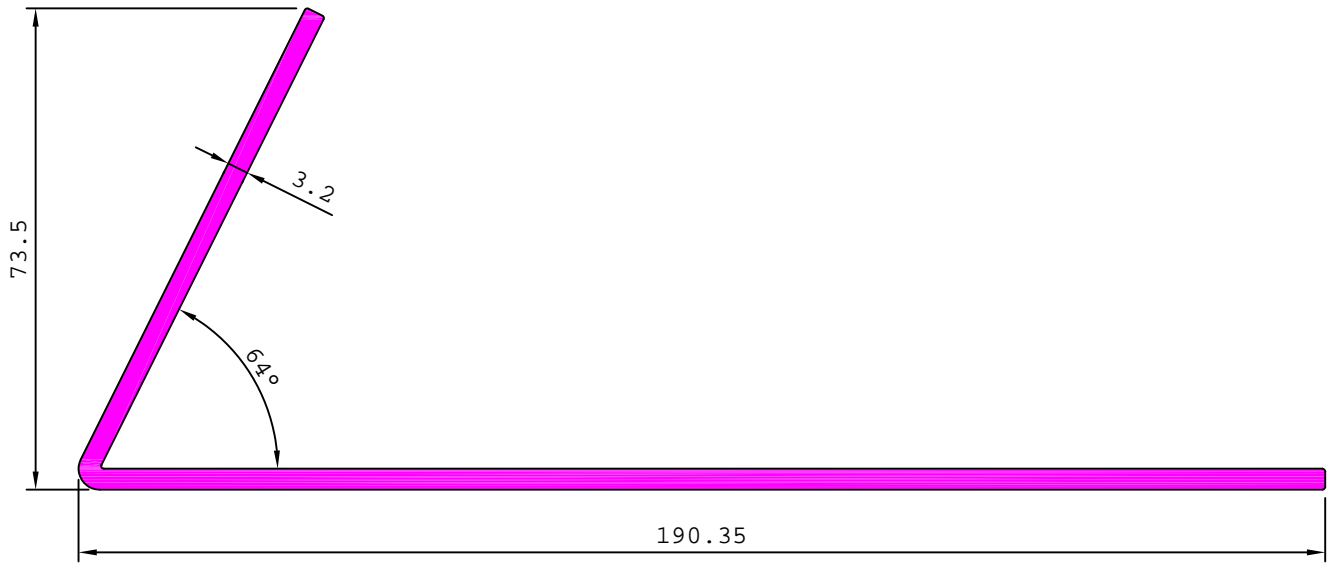

38510

0.614 kg/m

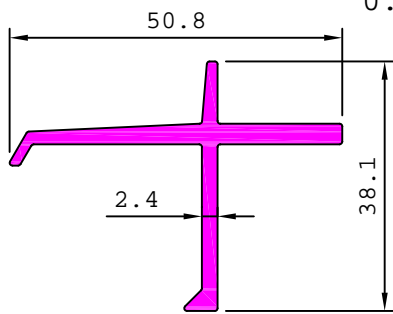

38511

0.827 kg/m

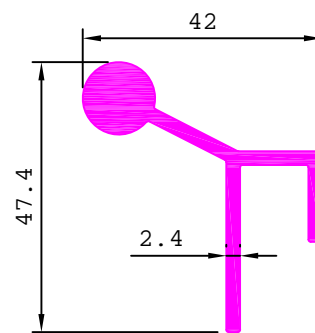

38512

0.611 kg/m

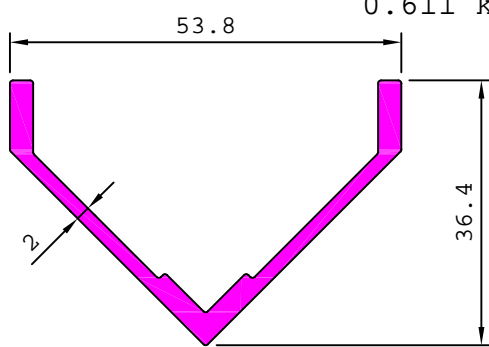

38513

2.092 kg/m

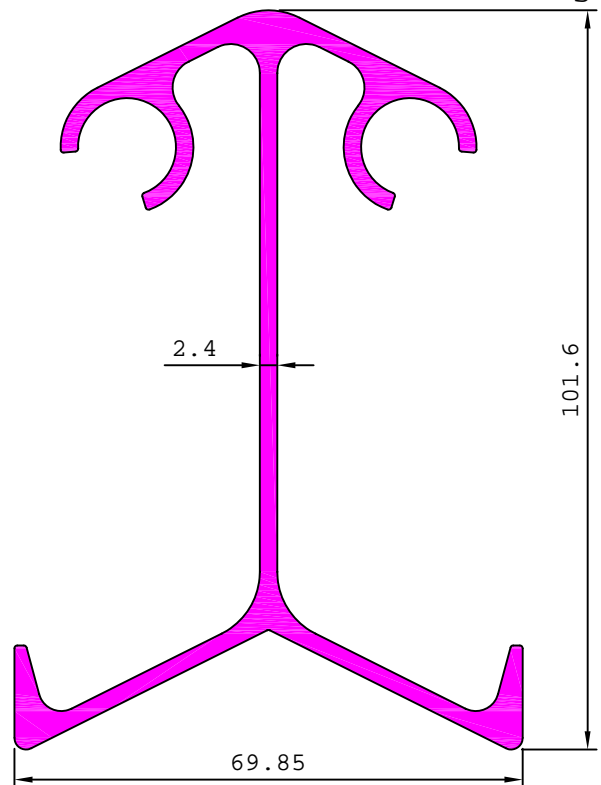

38515

0.634 kg/m

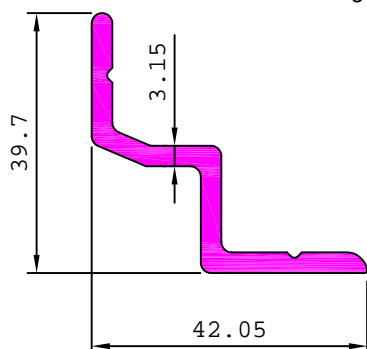

ARCHITECTURAL

MISCELLANEOUS

38514 0.922 kg/m

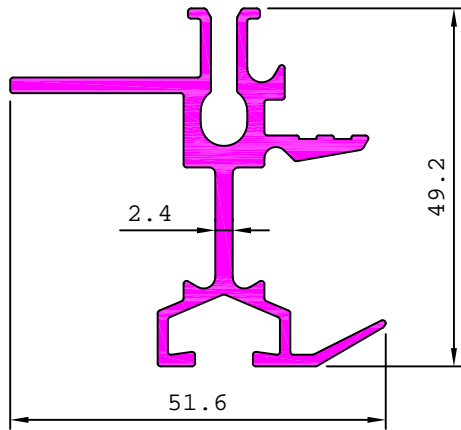

38518 0.933 kg/m

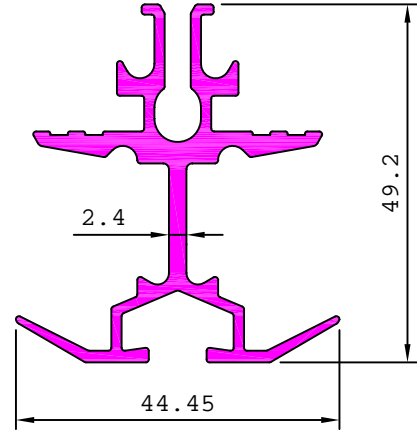

38516 0.428 kg/m

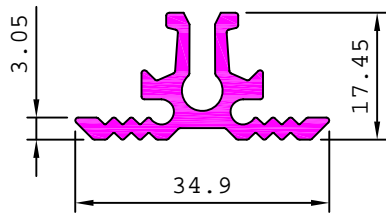

38520 0.115 kg/m

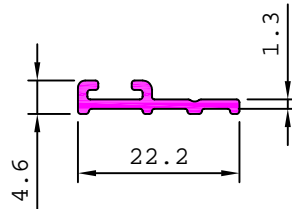

38522 0.359 kg/m

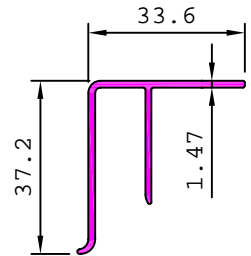

38517 0.659 kg/m

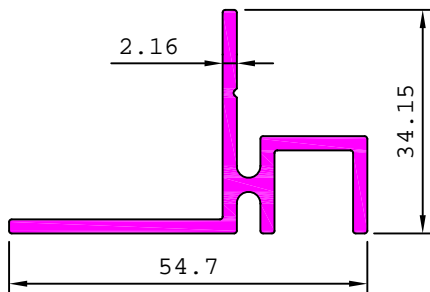

38523 0.198 kg/m

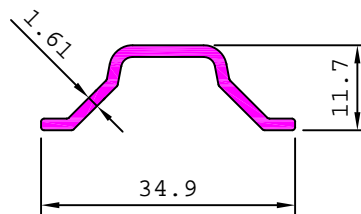

38524 0.282 kg/m

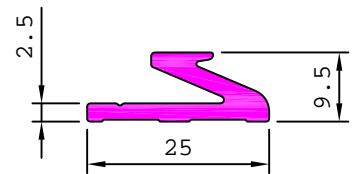

38525 0.789 kg/m

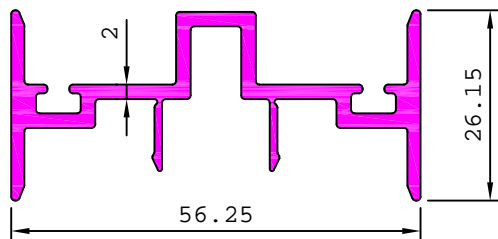

38526 0.472 kg/m

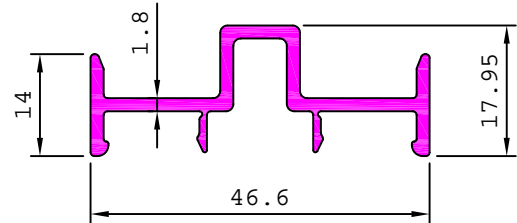

38527 0.728 kg/m

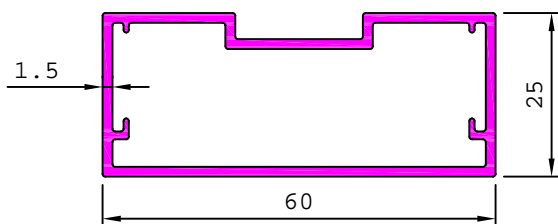

38529 0.202 kg/m

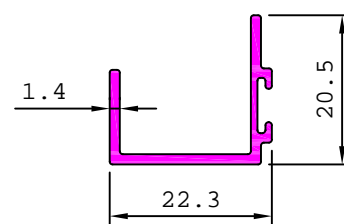

ARCHITECTURAL

MISCELLANEOUS

38528

0.747 kg/m

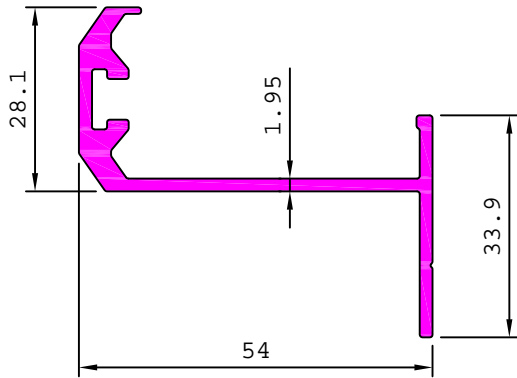

38530

0.365 kg/m

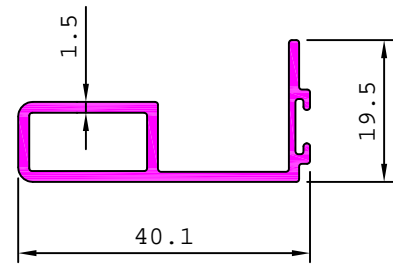

38531

0.179 kg/m

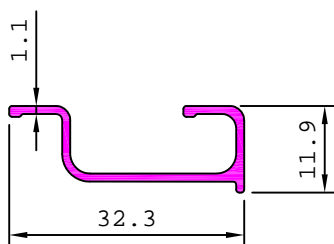

29559

0.733 kg/m

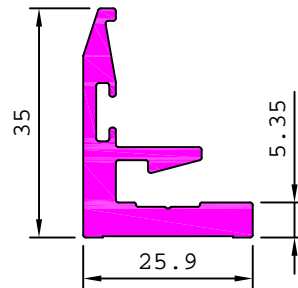

29560

0.381 kg/m

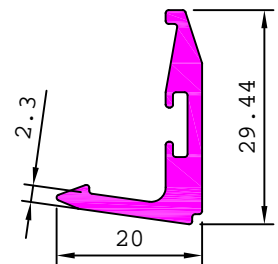

S4257

0.158 kg/m

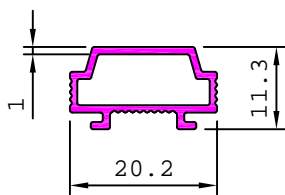

29117

0.287 kg/m

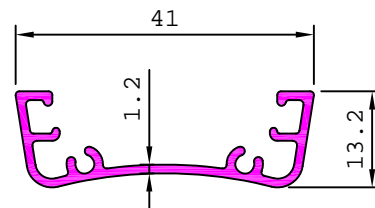

38532

0.230 kg/m

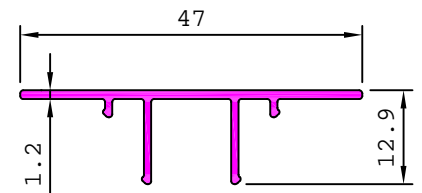

29611

0.445 kg/m

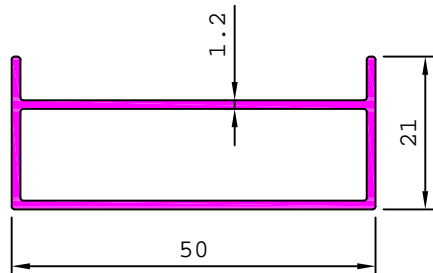

29613

0.588 kg/m

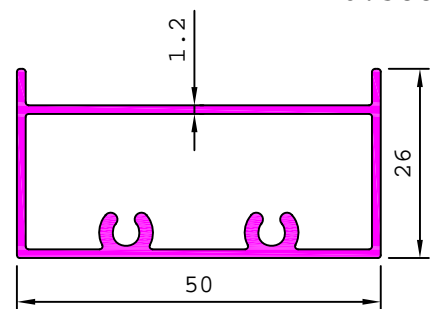

29415

1.106 kg/m

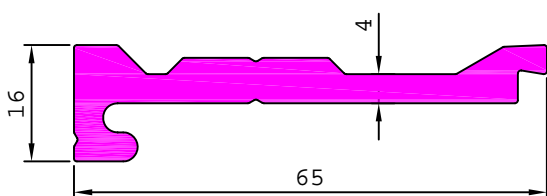

27956

1.354 kg/m

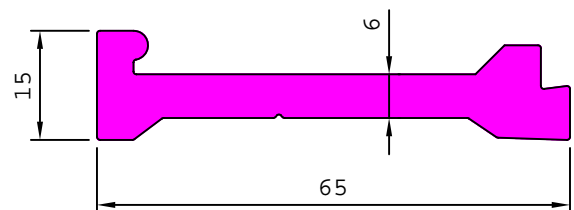

ARCHITECTURAL

MISCELLANEOUS

29446

2.286 kg/m

29360

1.054 kg/m

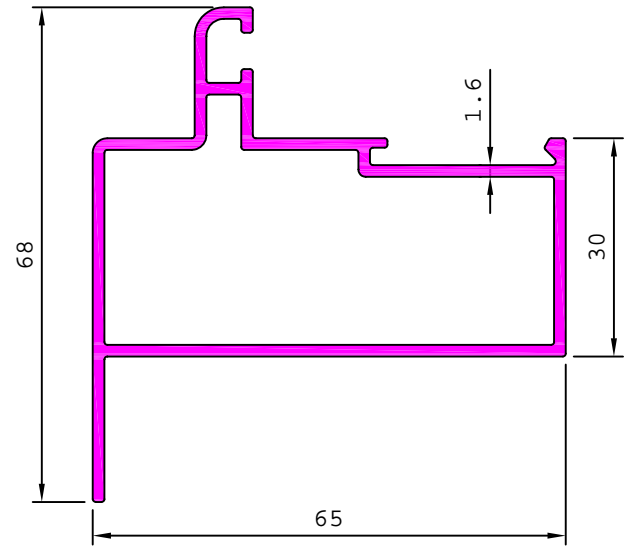
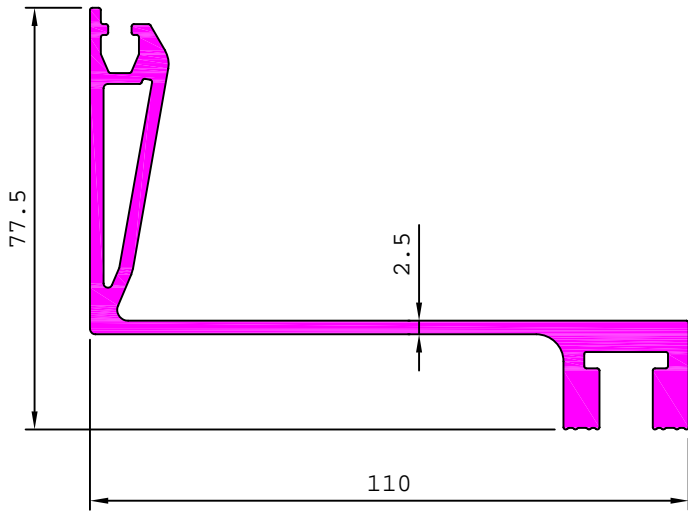

29545

0.656 kg/m

29546

0.638 kg/m

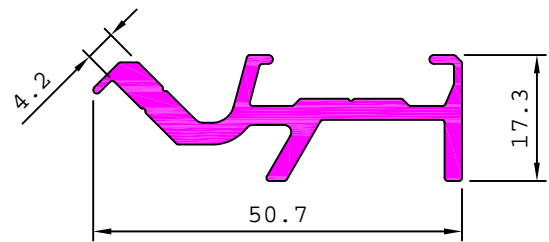
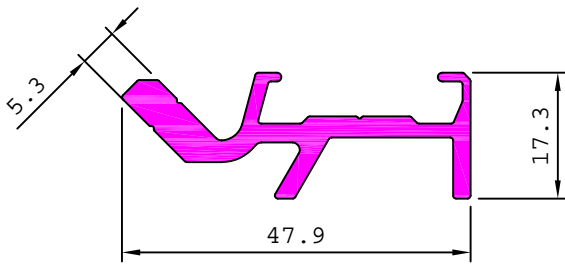

35690

3.771 kg/m

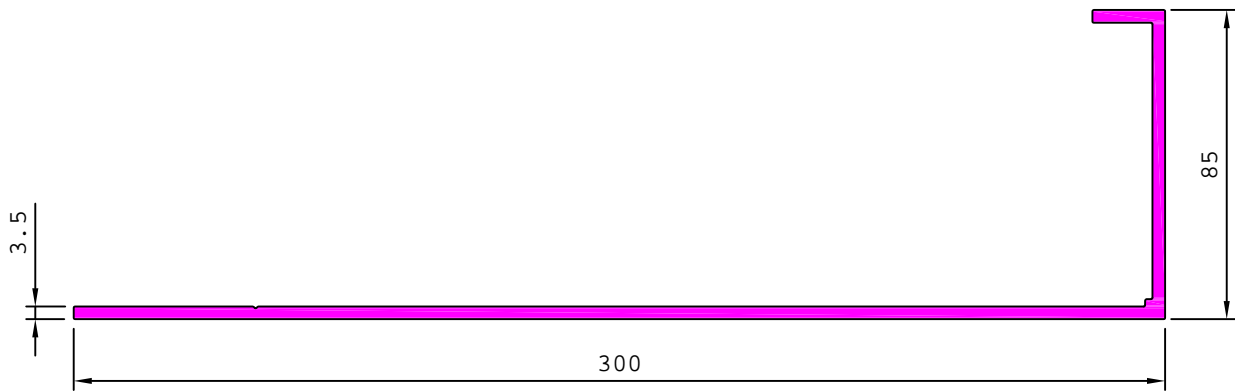

35776

2.216 kg/m

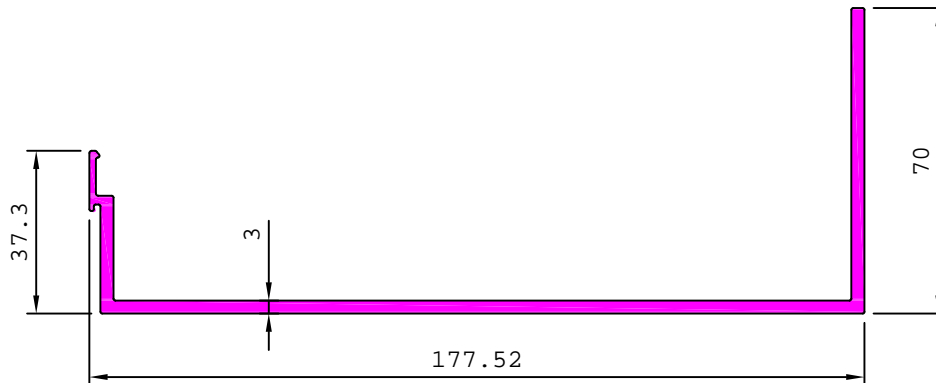

ARCHITECTURAL

MISCELLANEOUS

34571

1.308 kg/m

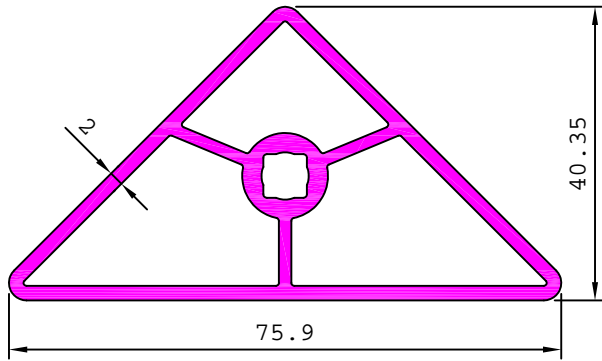

S4357

0.932 kg/m

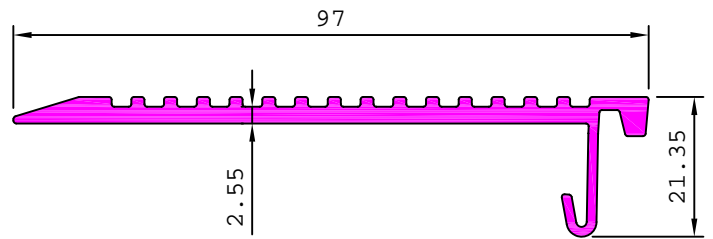

S4269

0.177 kg/m

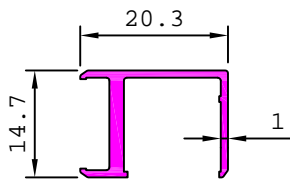

S4270

0.204 kg/m

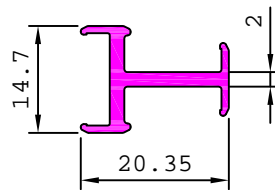

S4271

0.141 kg/m

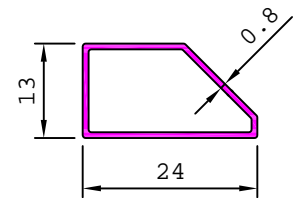

S4349

0.352 kg/m

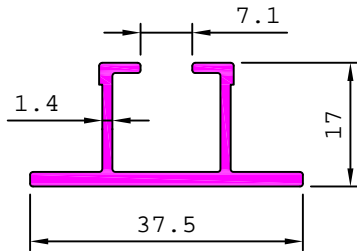

S4356

1.632 kg/m

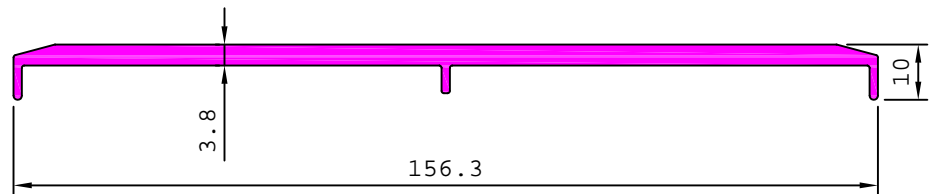

S4358

0.816 kg/m

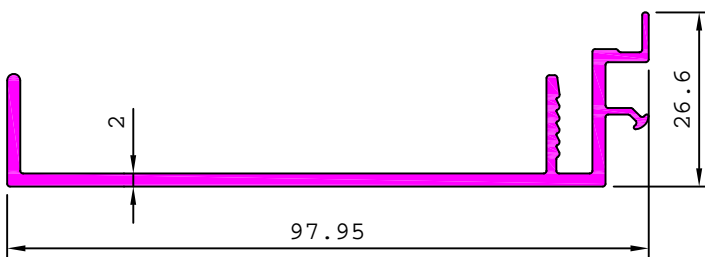

S4397

2.052 kg/m

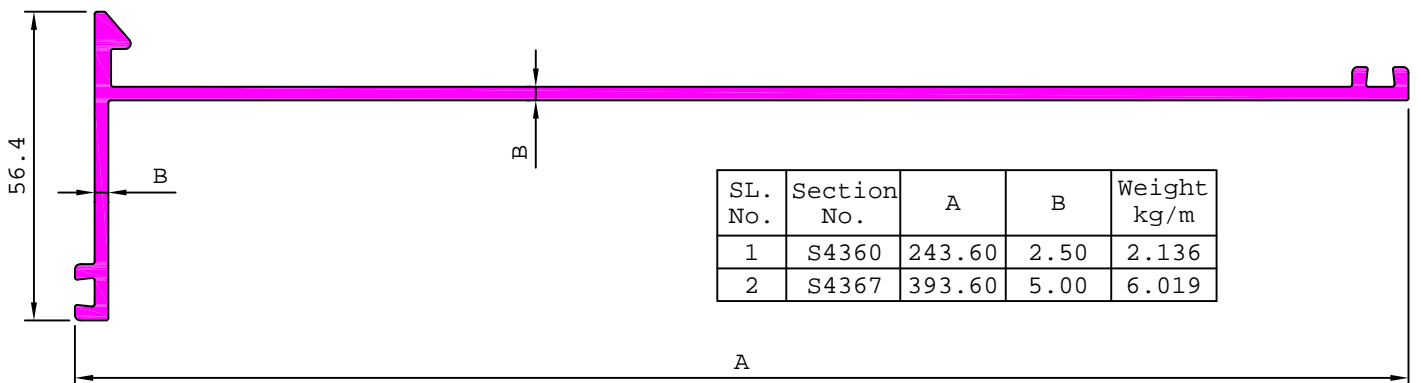
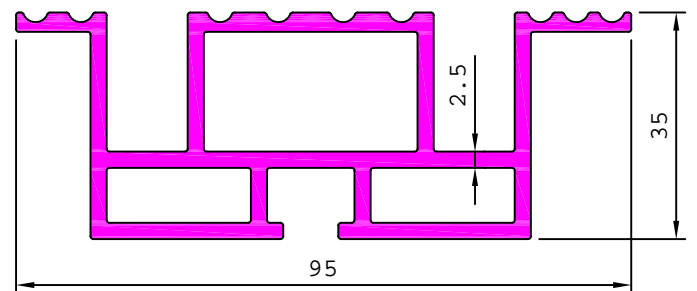

SL. No.	Section No.	A	B	Weight kg/m
1	S4360	243.60	2.50	2.136
2	S4367	393.60	5.00	6.019

ARCHITECTURAL

MISCELLANEOUS

S4359

4.652 kg/m

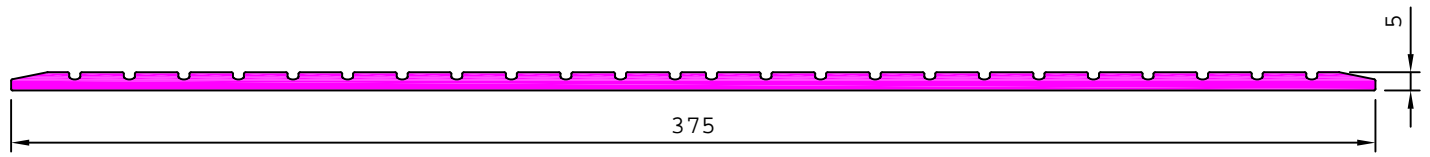

S4368

2.658 kg/m

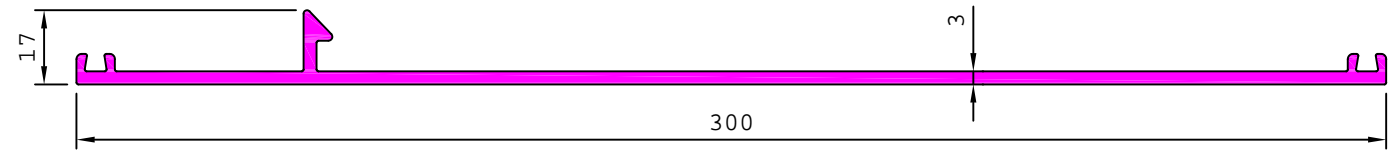

S4424

1.085 kg/m

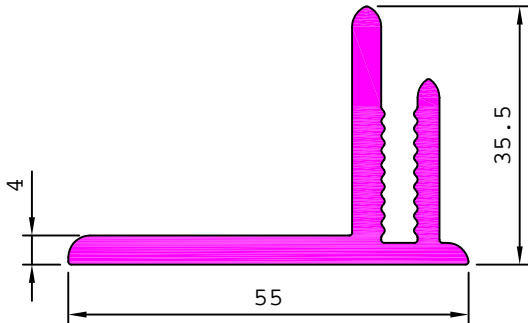

S4425

0.713 kg/m

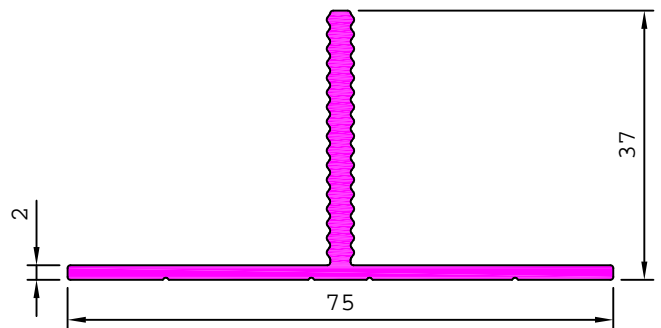

S4484

0.526 kg/m

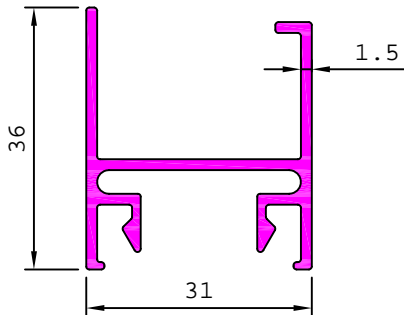

S4485

0.181 kg/m

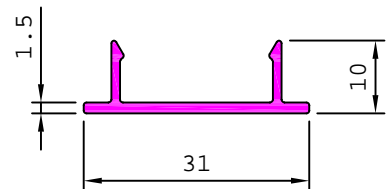

S4490

1.452 kg/m

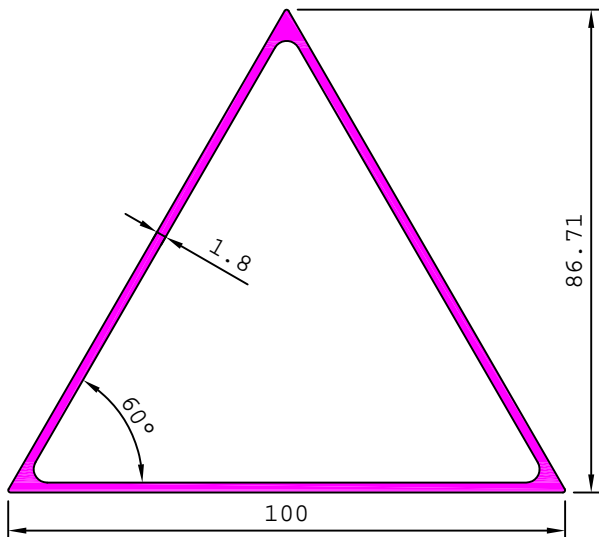

S4524

0.052 kg/m

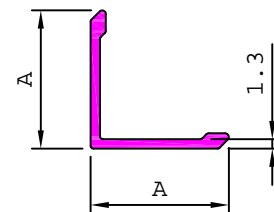
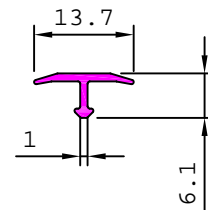

SL. No.	Section No.	A	Weight kg/m
1	S4525	19.00	0.138
2	S4526	24.00	0.173

ARCHITECTURAL

MISCELLANEOUS

S4598

0.527 kg/m

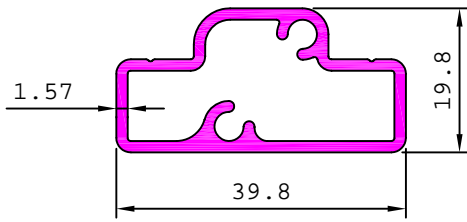

S4635

0.989 kg/m

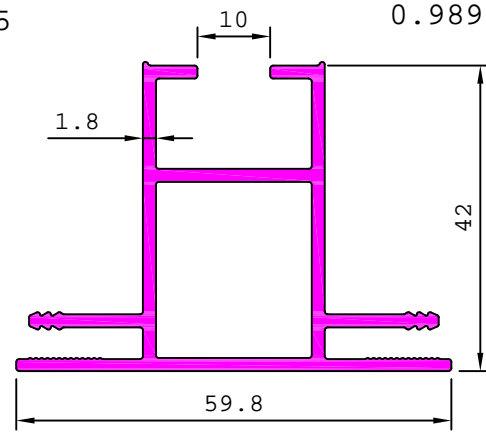

S4670

0.309 kg/m

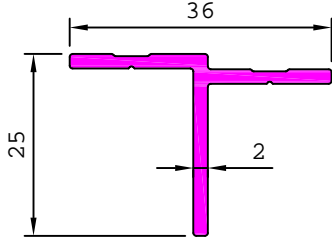

S4678

0.208 kg/m

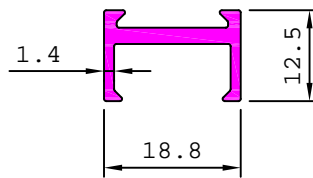

S4698

0.156 kg/m

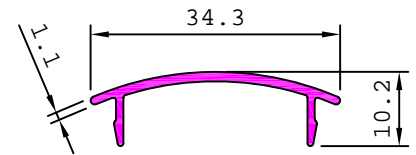

S4697

8.989 kg/m

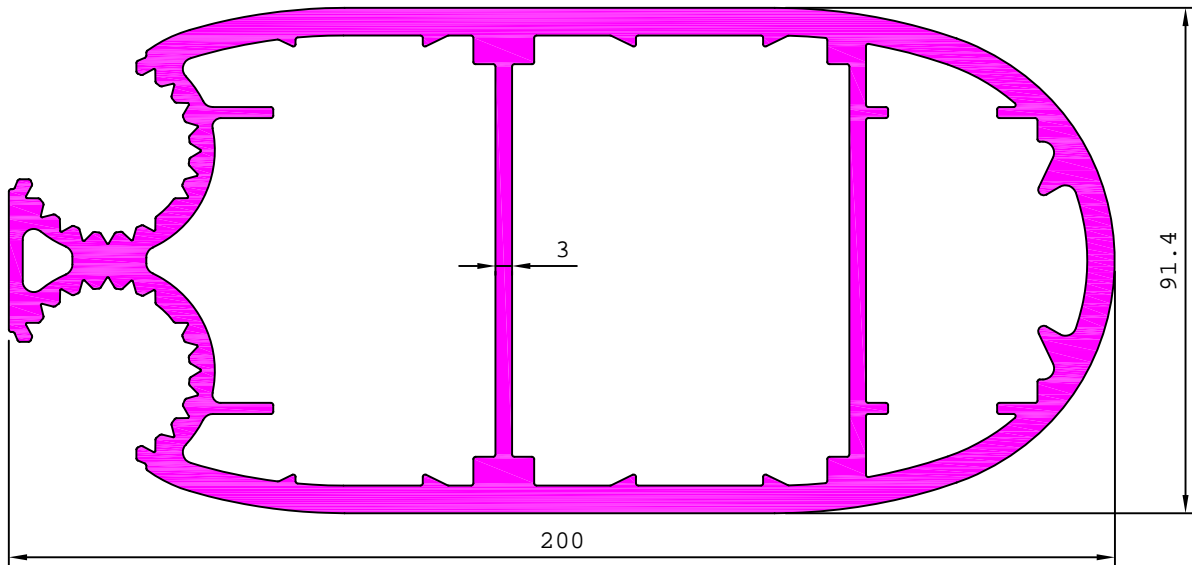

S4714

2.209 kg/m

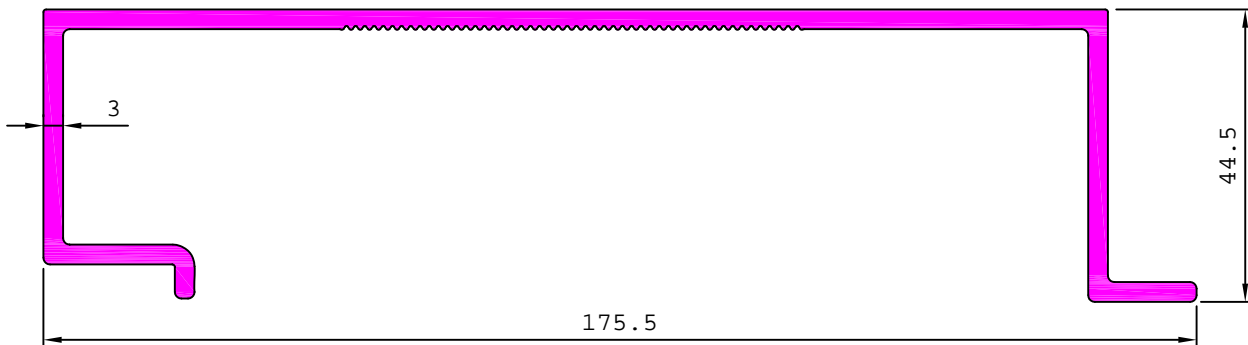

ARCHITECTURAL

MISCELLANEOUS

S4715

3.726 kg/m

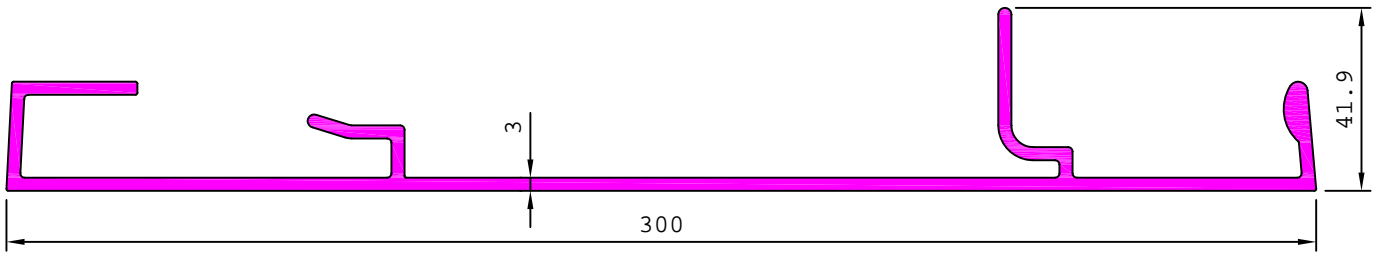

S4743

0.768 kg/m

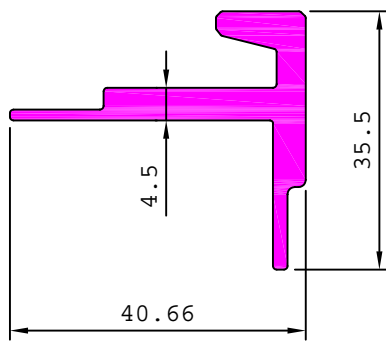

S4744

0.913 kg/m

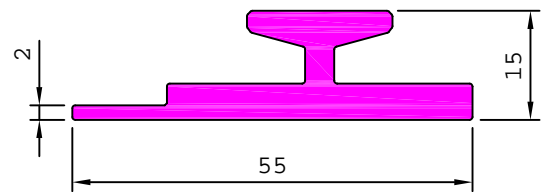

S4808

0.361 kg/m

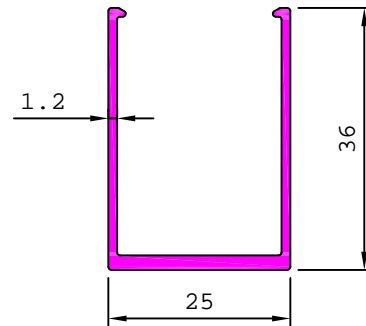

S4809

0.091 kg/m

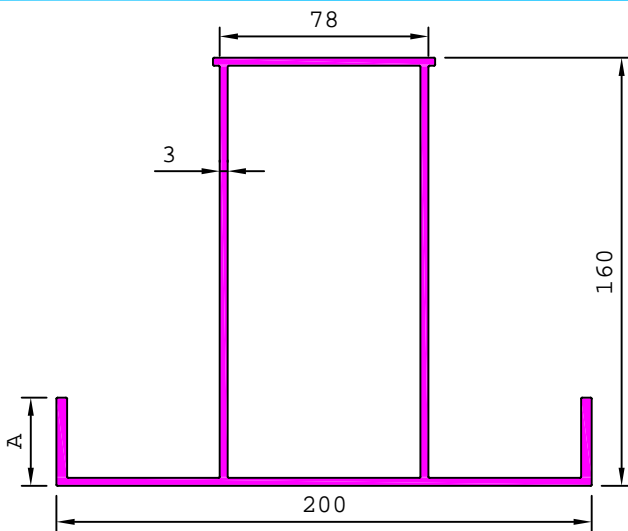
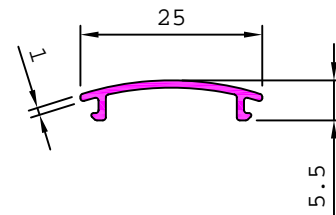

SL. No.	Section No.	A	Weight kg/m
1	S4773	35.00	5.435
2	S4774	45.00	5.921

S4878

0.920 kg/m

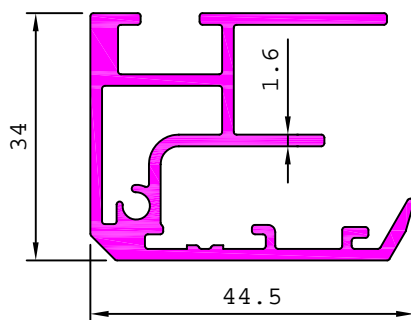

29442

0.807 kg/m

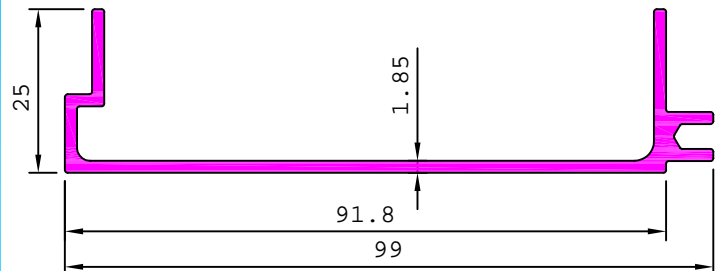

ARCHITECTURAL

MISCELLANEOUS

S4893

1.667 kg/m

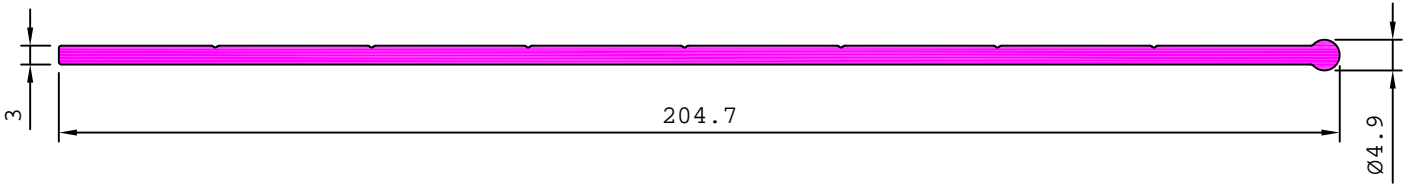

S4978

0.527 kg/m

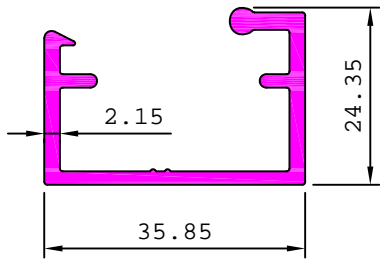

S4979

0.703 kg/m

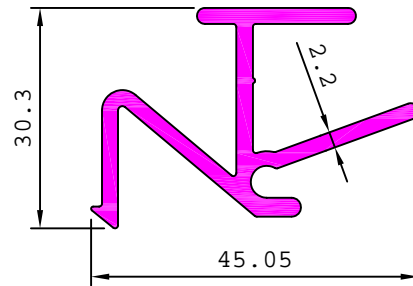

S4974

0.131 kg/m

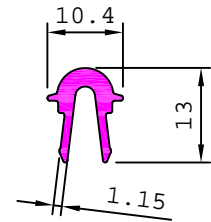

S4986

1.199 kg/m

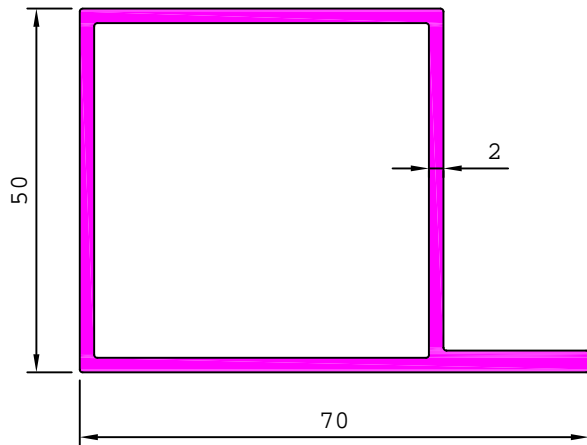

S4987

0.680 kg/m

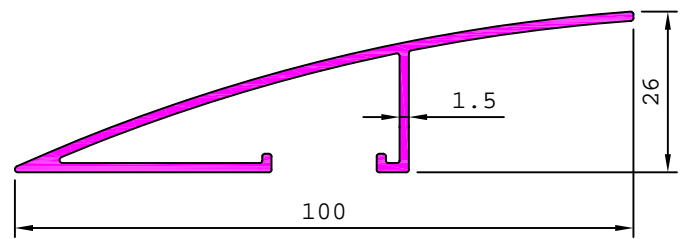

S5036

5.731 kg/m

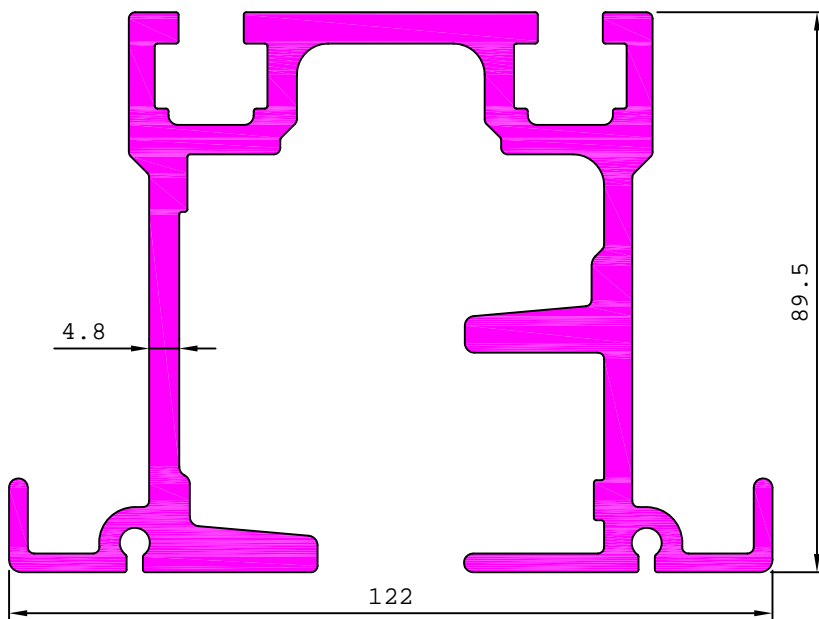

S5057

0.759 kg/m

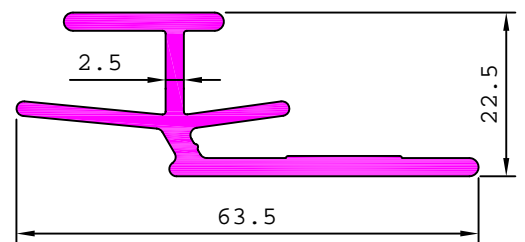

S5079

0.490 kg/m

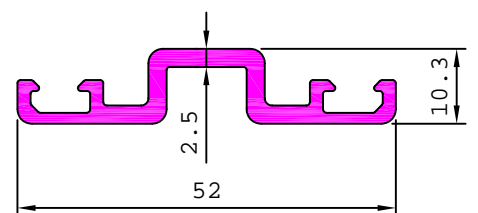

ARCHITECTURAL

MISCELLANEOUS

27955

1.484 kg/m

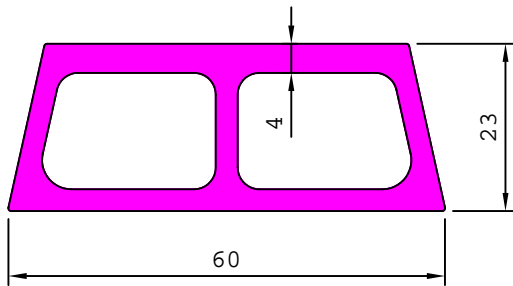

27957

1.335 kg/m

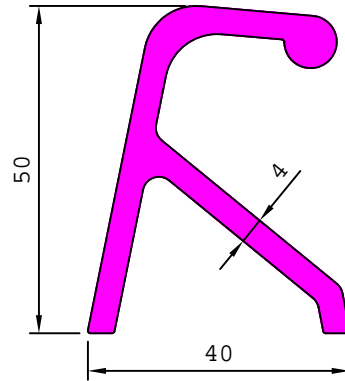

27961

3.183 kg/m

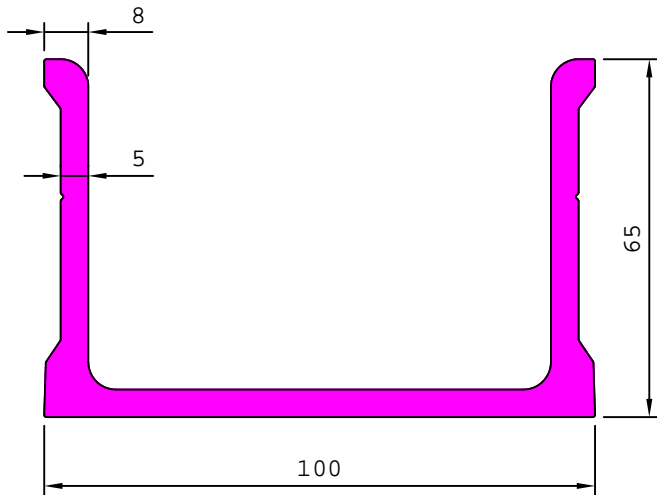

27962

3.521 kg/m

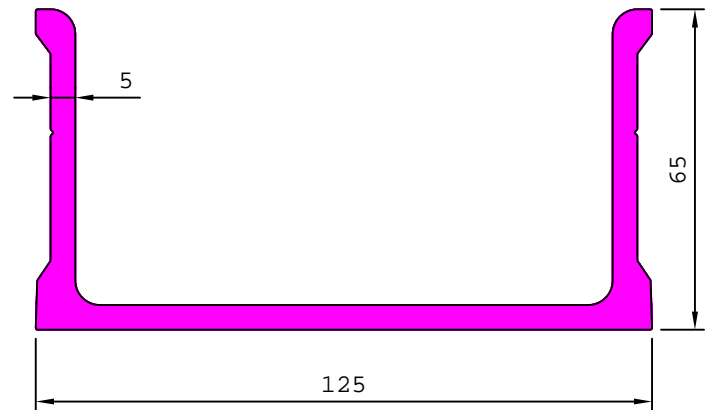

27963

6.412 kg/m

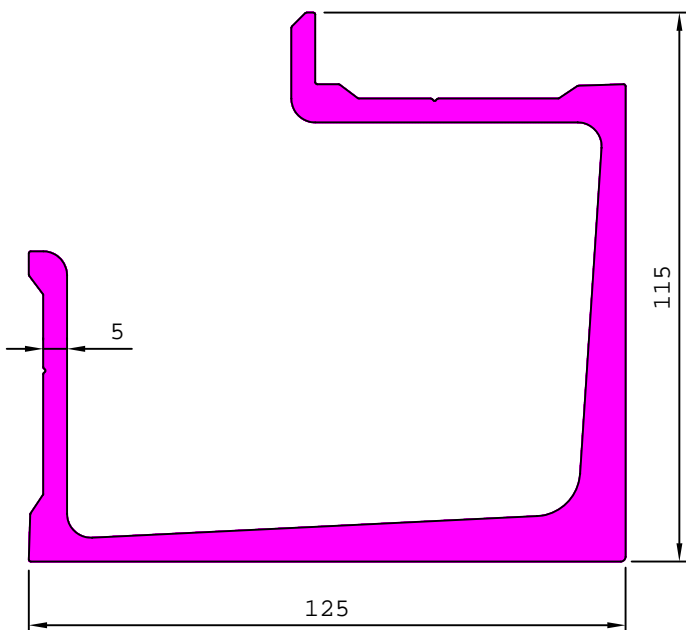

27964

5.624 kg/m

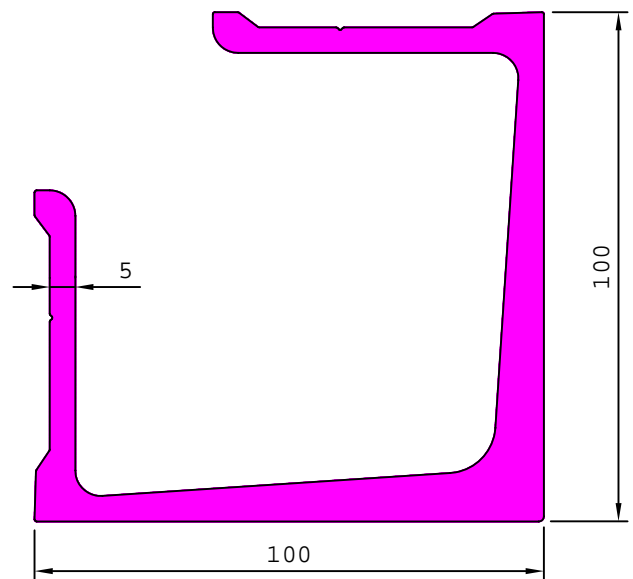

ARCHITECTURAL

MISCELLANEOUS

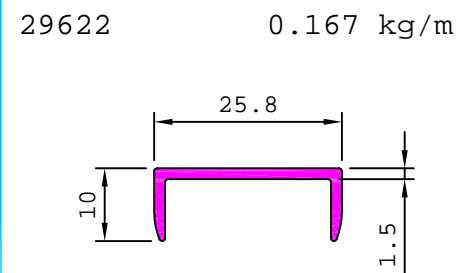
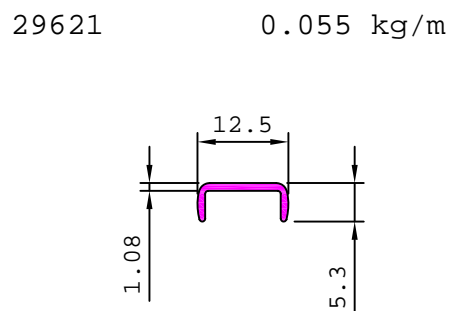
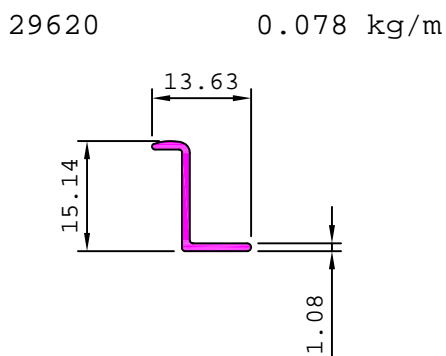
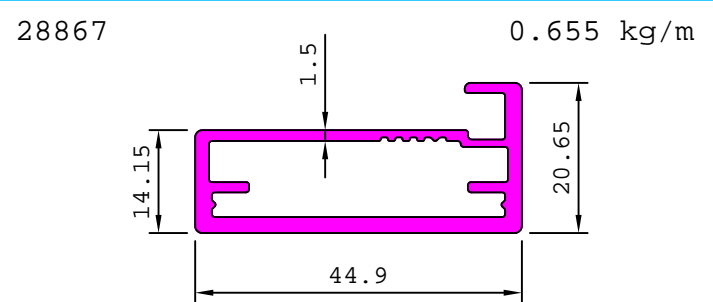
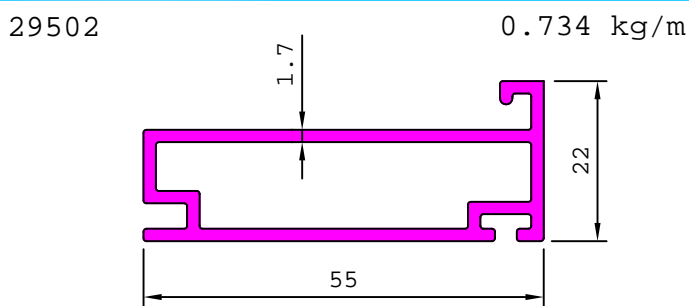
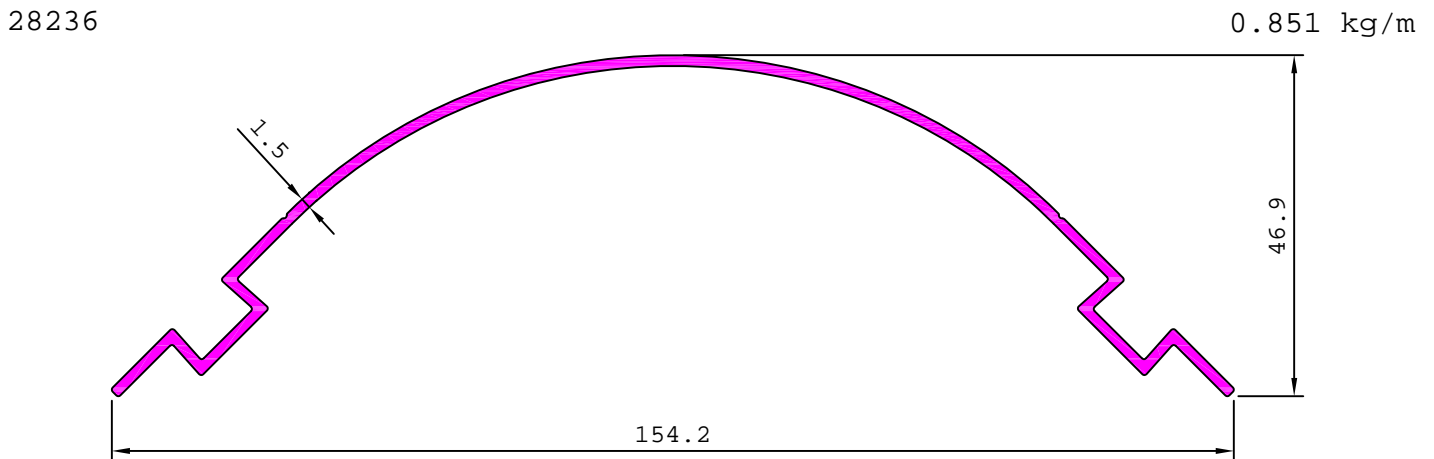
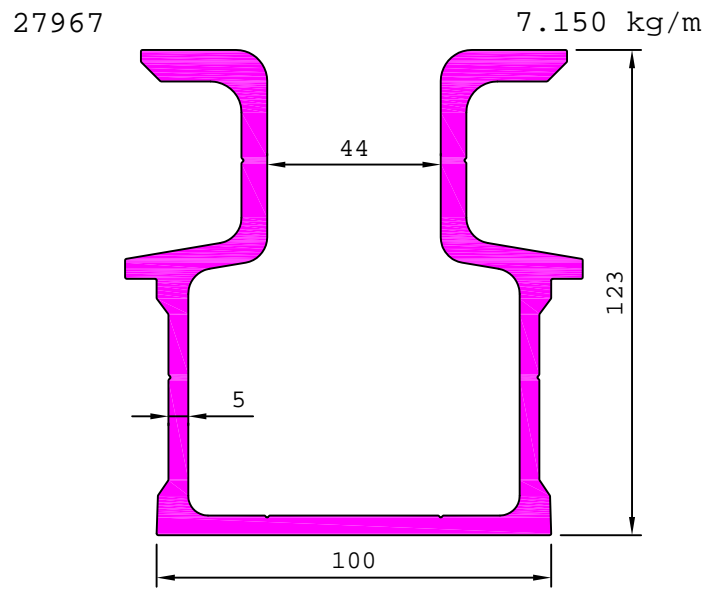
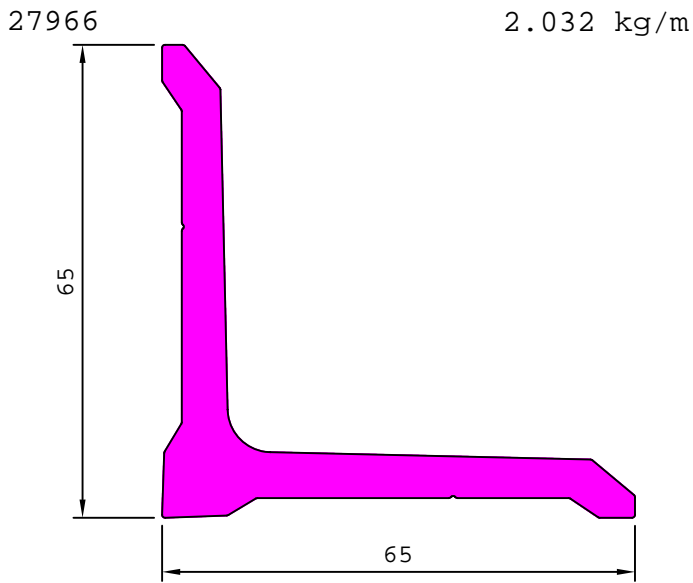

ARCHITECTURAL

MISCELLANEOUS

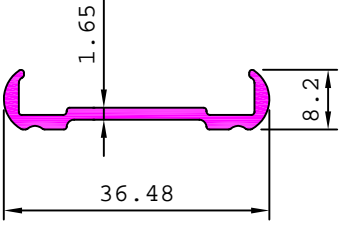
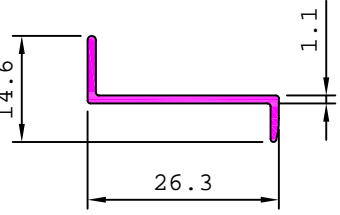
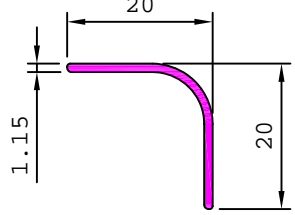
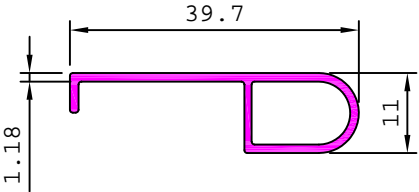
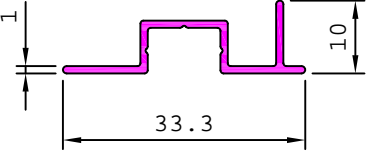
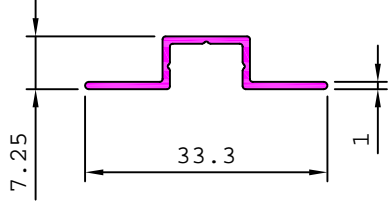
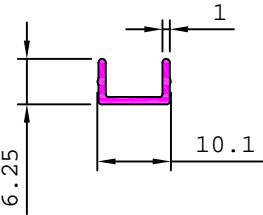
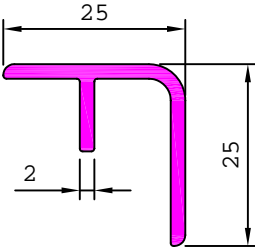
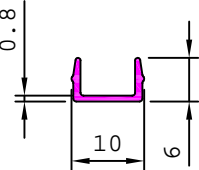
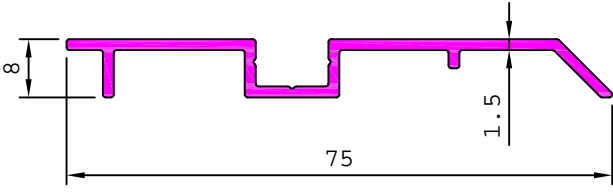
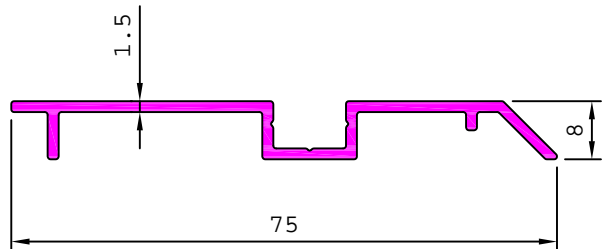
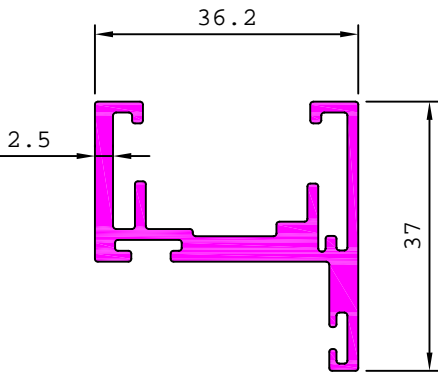
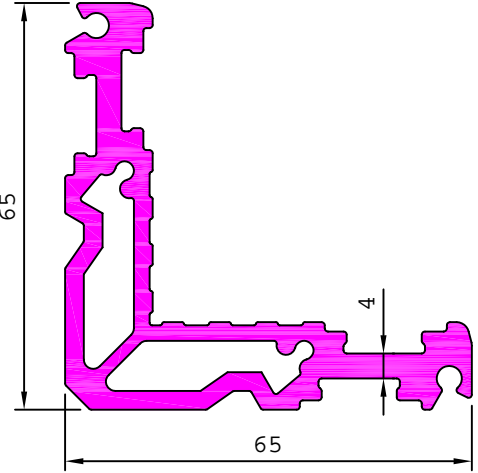
<p>29623 0.218 kg/m</p> 	<p>29624 0.118 kg/m</p> 	<p>29625 0.110 kg/m</p> 
<p>29626 0.228 kg/m</p> 	<p>29627 0.146 kg/m</p> 	<p>29628 0.122 kg/m</p> 
<p>29629 0.055 kg/m</p> 	<p>29630 0.301 kg/m</p> 	<p>29632 0.047 kg/m</p> 
<p>29631 0.401 kg/m</p> 	<p>29635 0.401 kg/m</p> 	
<p>29633 0.753 kg/m</p> 	<p>S4332 2.198 kg/m</p> 	

ARCHITECTURAL

MISCELLANEOUS

S4341 1.034 kg/m

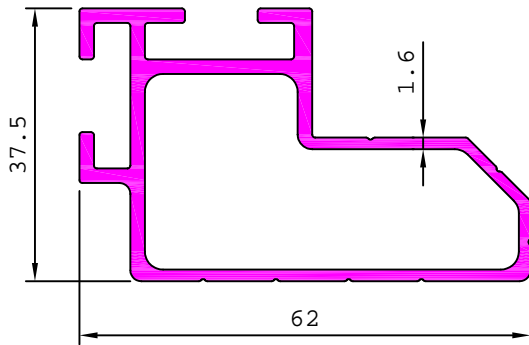

S4771 0.877 kg/m

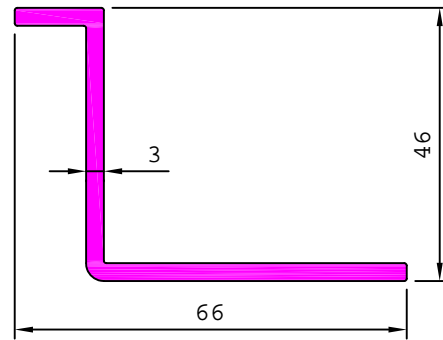

S5091 0.920 kg/m

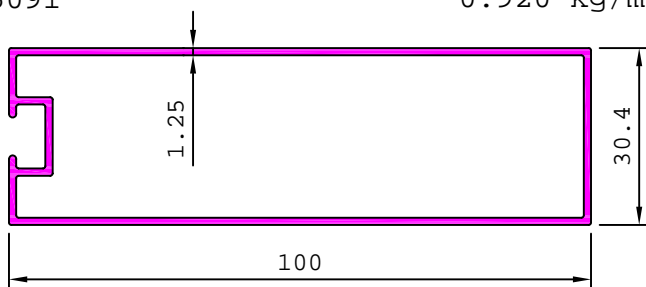

S5100 0.086 kg/m

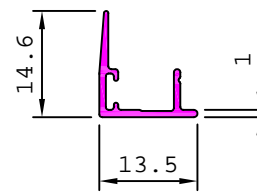

S5102 0.655 kg/m

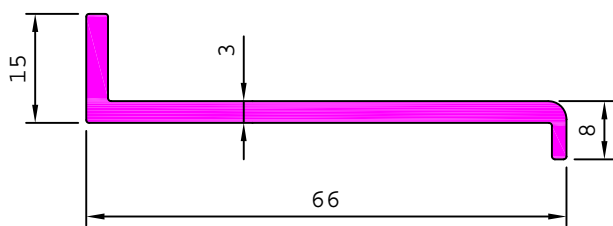

S5103 0.680 kg/m

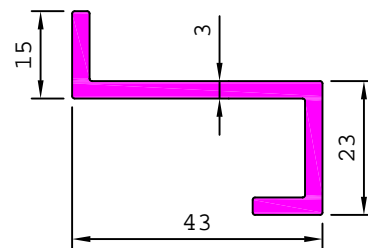

S5106 0.143 kg/m

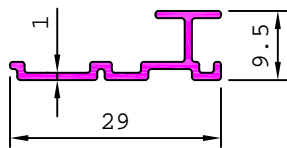

S5120 1.076 kg/m

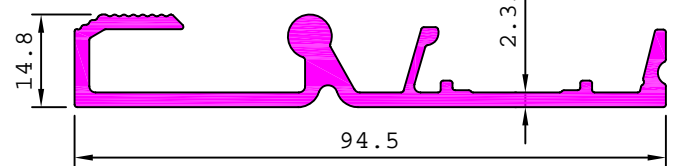

S5118 2.461 kg/m

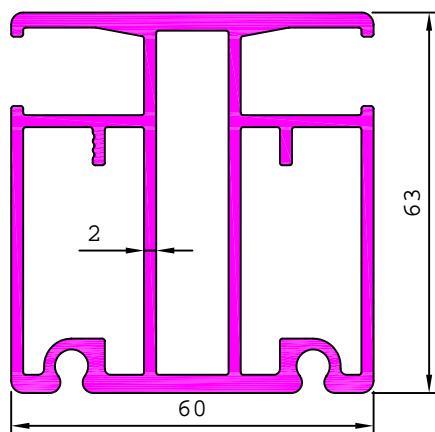

S5119 2.439 kg/m

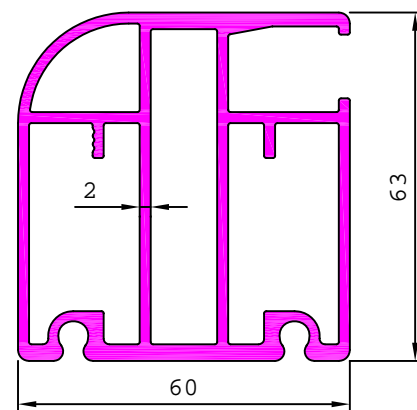

ARCHITECTURAL

MISCELLANEOUS

S5121

1.323 kg/m

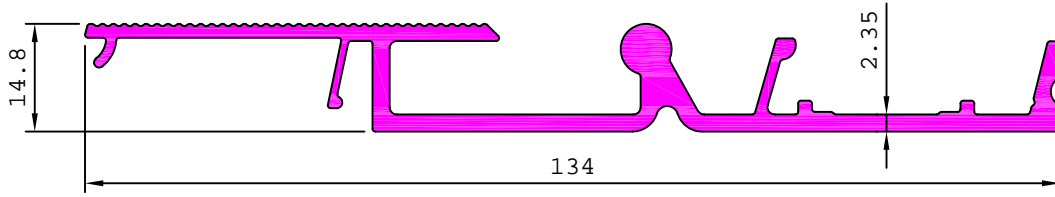

S5124

0.425 kg/m

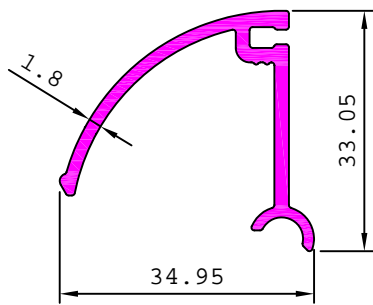

S5122

3.795 kg/m

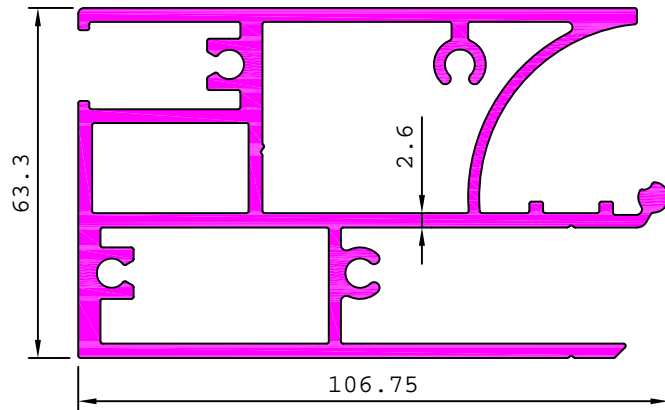

S5137

1.114 kg/m

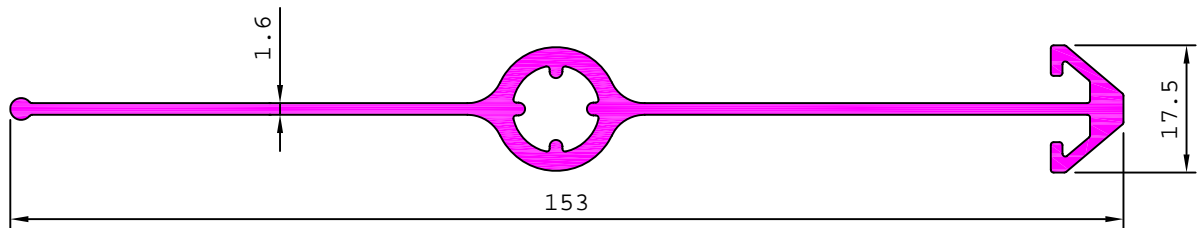

S5194

0.577 kg/m

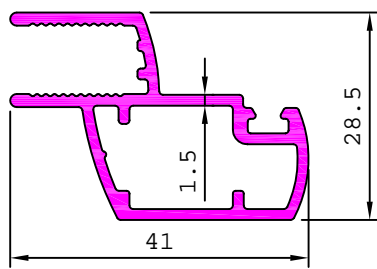

S5195

0.758 kg/m

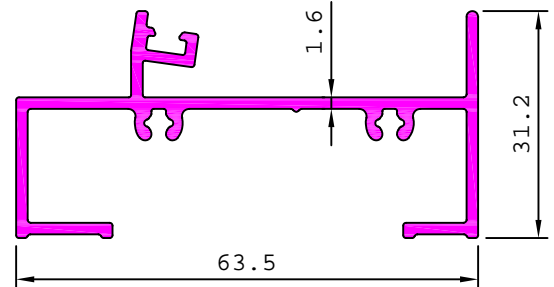

S5196

0.873 kg/m

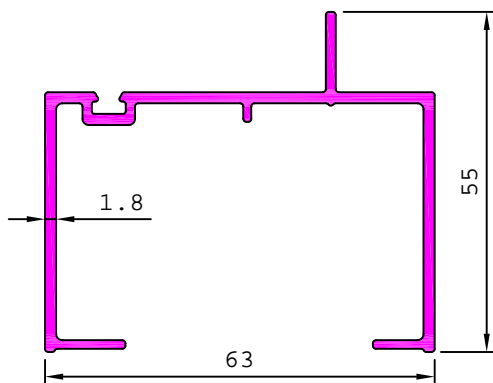

S5197

1.075 kg/m

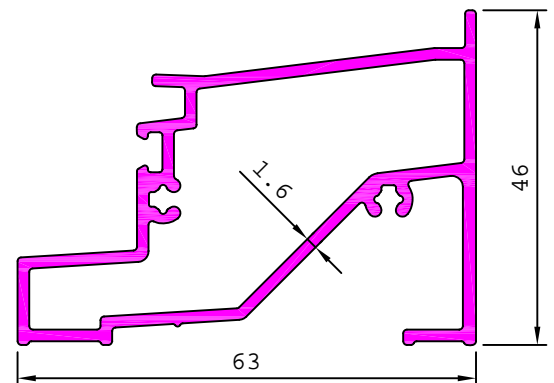

ARCHITECTURAL

MISCELLANEOUS

S5198

1.108 kg/m

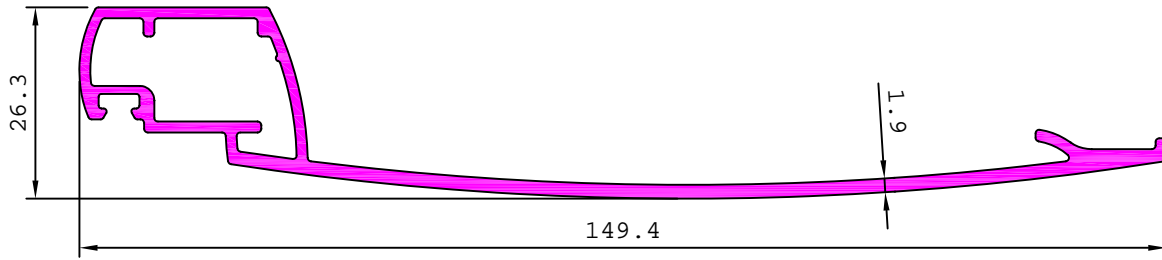

S5207

0.866 kg/m

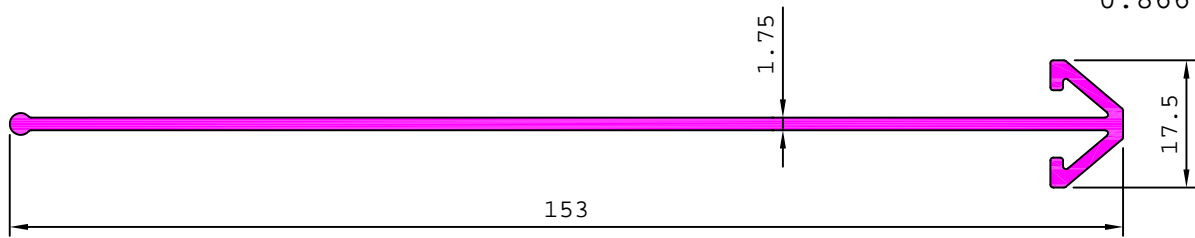

S5199

0.286 kg/m

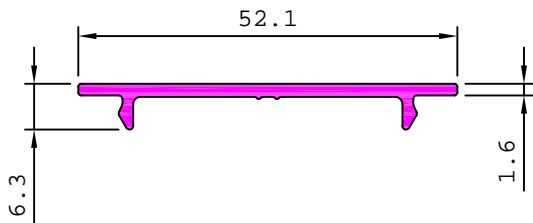

ARCHITECTURAL

MISCELLANEOUS

22951

0.828 kg/m

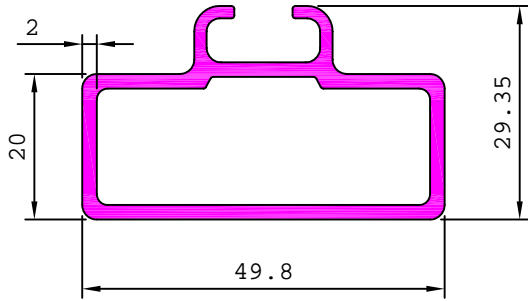

22958

3.145 kg/m

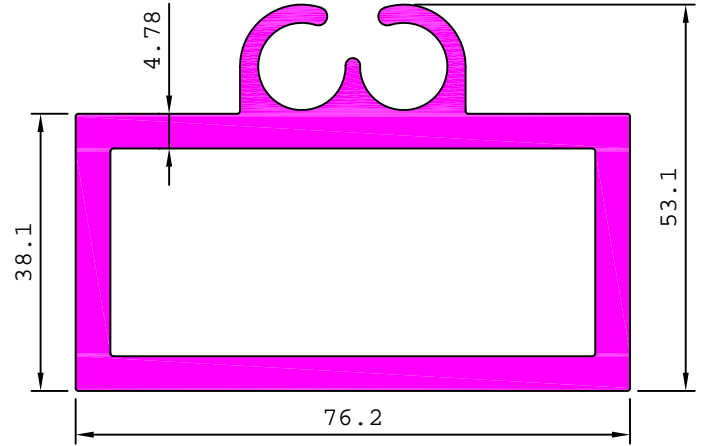

S5059

2.702 kg/m

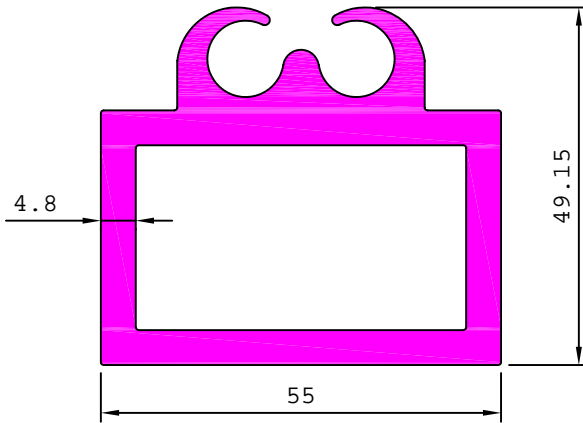

ARCHITECTURAL

MISCELLANEOUS

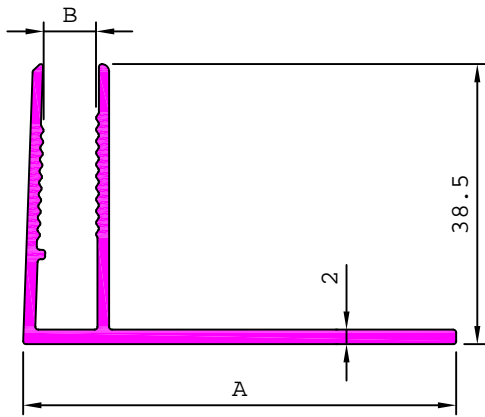

SL. No.	Section No.	A	B	Weight kg/m
1	28992	59.50	7.19	0.630
2	28994	63.50	11.19	0.651
3	28993	67.50	15.02	0.678

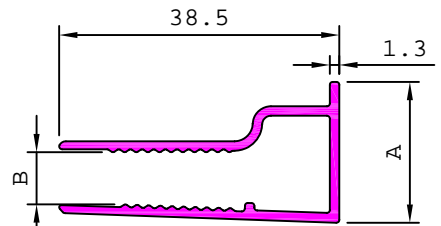

SL. No.	Section No.	A	B	Weight kg/m
1	28983	19.35	7.19	0.332
2	28984	23.35	11.02	0.351

28914 0.423 kg/m

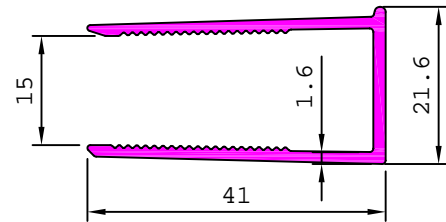

28972 0.365 kg/m

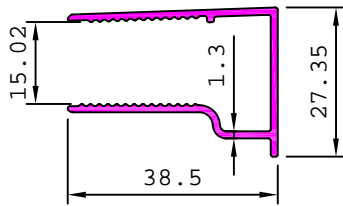

22955 0.753 kg/m

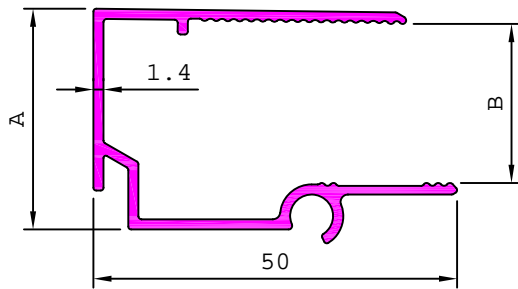
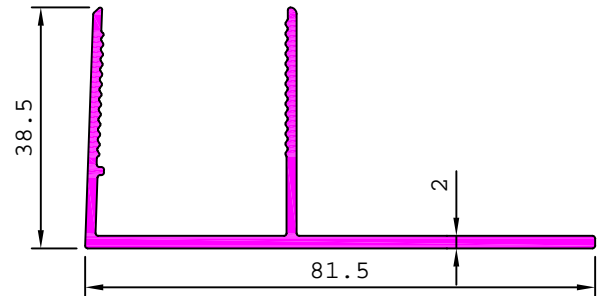

SL. No.	Section No.	A	B	Weight kg/m
1	S4892	24.35	15.85	0.484
2	22947	30.35	21.85	0.507

22956 0.710 kg/m

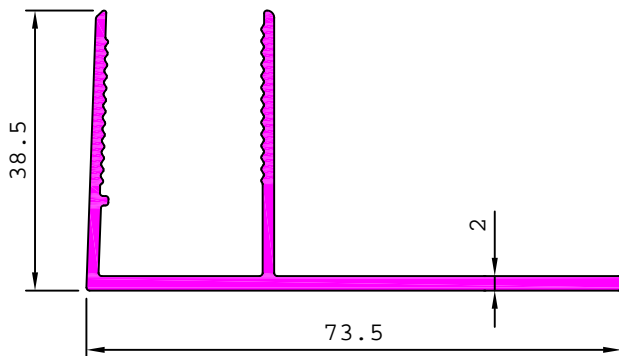

22957 0.523 kg/m

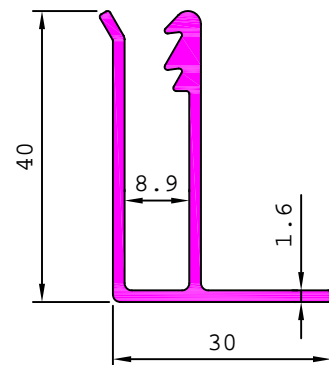

ARCHITECTURAL

MISCELLANEOUS

29595

0.405 kg/m

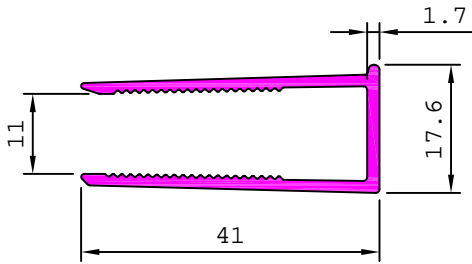

29596

0.386 kg/m

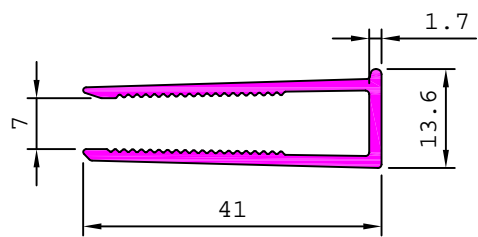

29372

0.473 kg/m

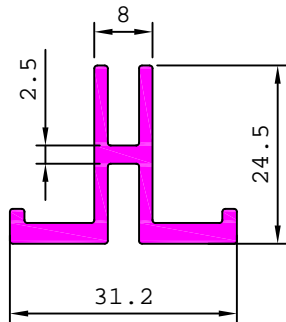

38533

0.437 kg/m

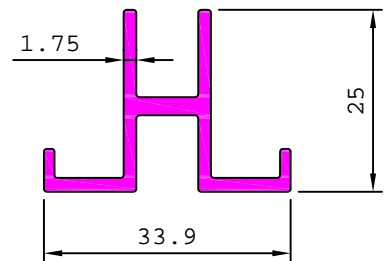

29239

0.376 kg/m

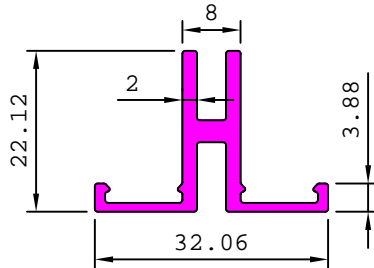

29240

0.323 kg/m

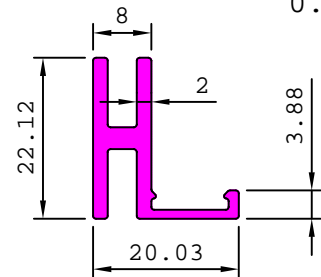

29514

0.478 kg/m

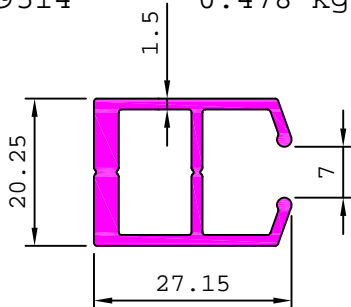

22954

0.631 kg/m

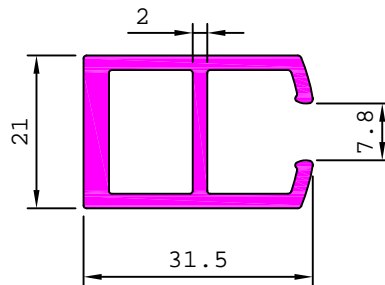

S5092

0.332 kg/m

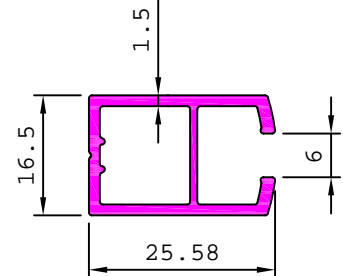

MOULDING & TRANSPORT

HALF ROUNDS, BELT MOUDINGS & WATER CHANNELS

HALF ROUNDS - RADIUSED

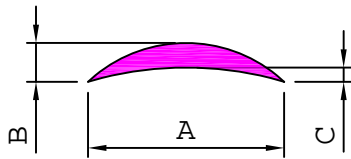

SL. No.	Section No.	A	B	C	Weight kg/m
1	23009	17.65	3.15	1.65	0.058
2	23005	19.00	4.80	0.90	0.152
3	23001	19.05	3.18	0.90	0.091
4	23002	24.00	3.18	1.16	0.099
5	23006	24.70	4.78	0.78	0.193
6	23010	25.00	4.80	0.90	0.194
7	23008	25.00	5.20	2.85	0.127
8	23007	25.15	4.60	1.70	0.150
9	23003	25.40	3.80	1.55	0.121

BELT MOULDINGS

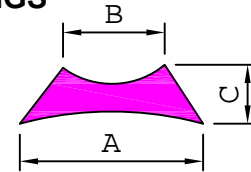

SL. No.	Section No.	A	B	C	Weight kg/m
1	23104	22.00	15.56	3.00	0.088
2	23106	22.50	13.00	2.70	0.055
3	23105	24.20	14.00	3.00	0.079
4	23101	25.15	12.70	3.80	0.114

WATER CHANNELS

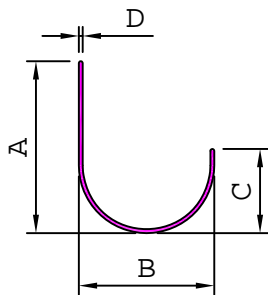

SL. No.	Section No.	A	B	C	D	Weight kg/m
1	23507	23.50	18.50	11.50	0.52	0.063
2	23505	23.50	18.50	11.50	0.65	0.078
3	23510	23.50	18.50	11.50	0.71	0.085
4	23508	25.00	11.50	14.00	0.71	0.085
5	23506	25.40	12.00	12.70	1.06	0.124
6	23501	25.40	12.70	11.43	1.40	0.157
7	23502	25.40	19.05	12.70	0.75	0.098
8	23503	25.40	19.05	12.70	1.68	0.210
9	23509	25.50	12.90	13.60	1.45	0.173

POULTRY CHANNELS

23202

0.303 kg/m

23204

0.714 kg/m

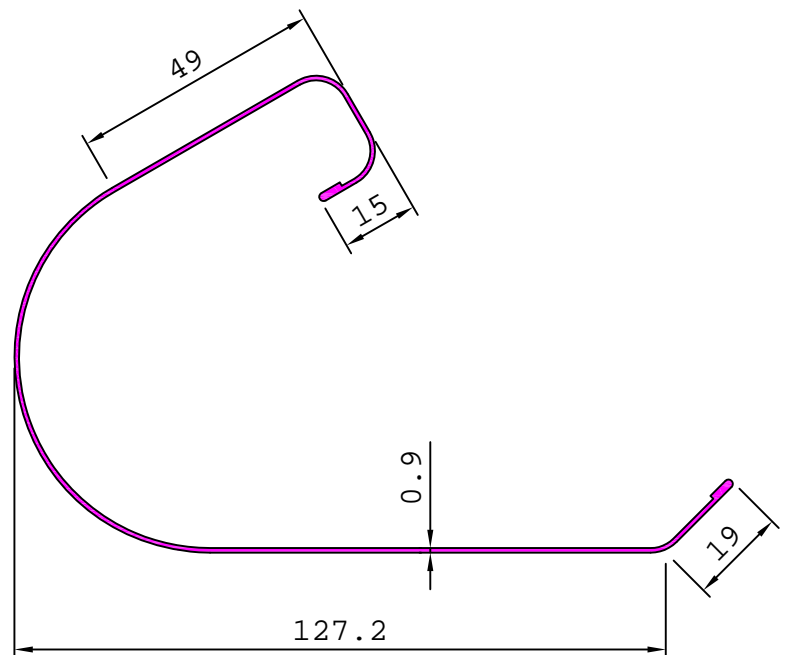
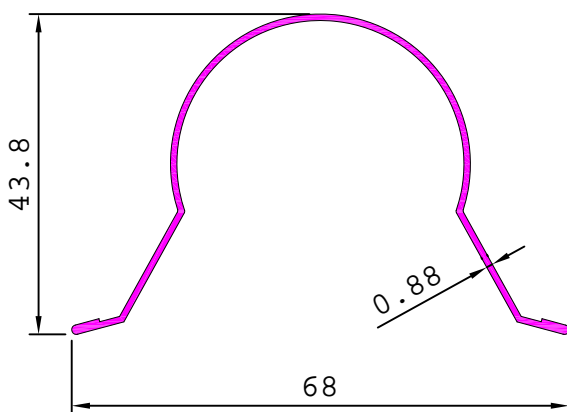

MOULDING & TRANSPORT

WATER CHANNELS SPECIAL

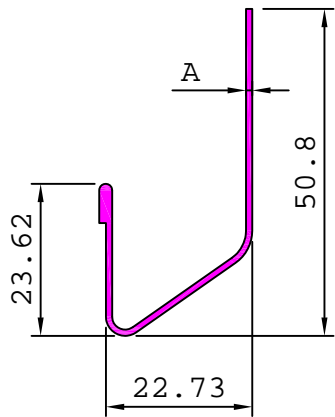

SL. No.	Section No.	A	Weight kg/m
1	23160	0.76	0.191
2	23153	0.97	0.238
3	23152	1.42	0.350

23156

0.273 kg/m

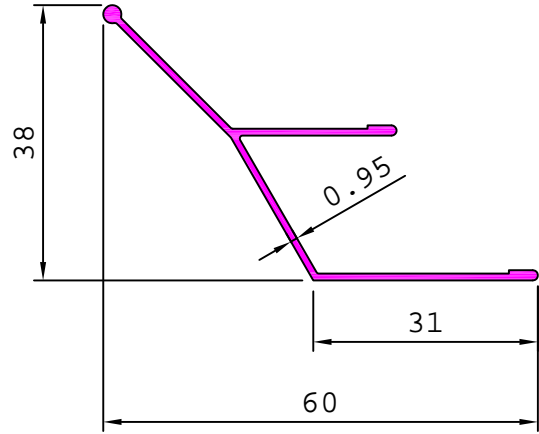

23155

0.130 kg/m

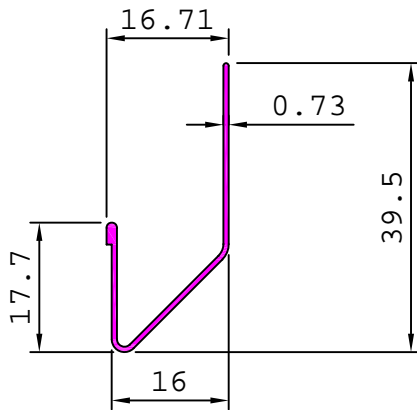

23161

0.423 kg/m

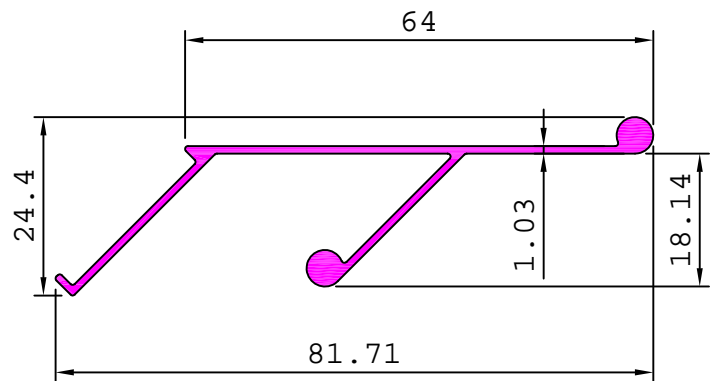

23158

0.068 kg/m

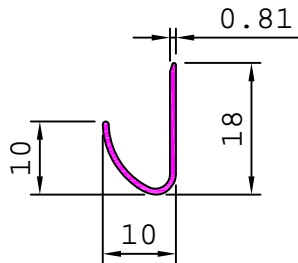

23159

0.189 kg/m

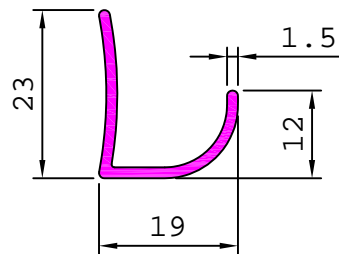

MOULDING & TRANSPORT

FLUTED STRIPS & FLUTED ANGLES - TRIANGULAR

23301 0.197 kg/m

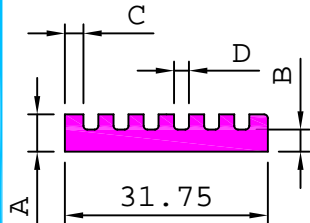
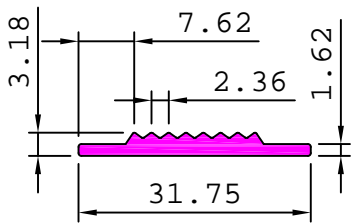

SL. No.	Section No.	A	B	C	D	Weight kg/m
1	23309	2.00	1.00	2.51	2.43	0.132
2	23303	2.35	1.20	2.45	2.44	0.156
3	23304	4.16	2.08	2.45	2.44	0.275

23306

0.119 kg/m

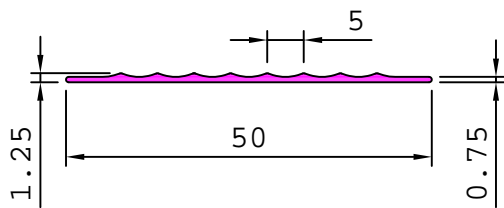

23313

0.085 kg/m

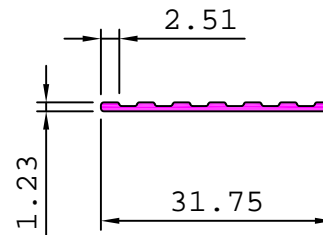

23311

1.090 kg/m

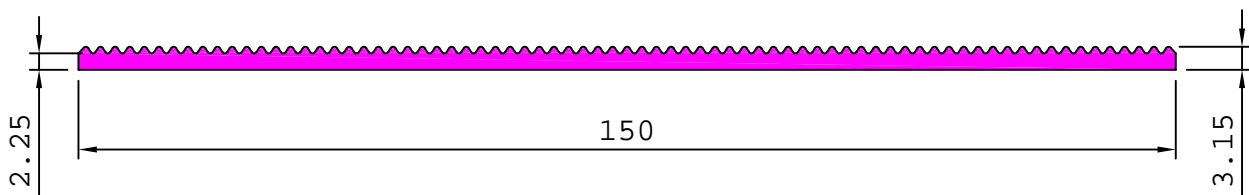

23312

0.219 kg/m

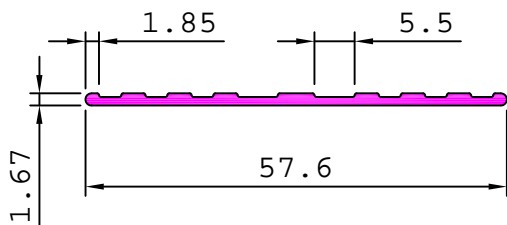

23314

0.044 kg/m

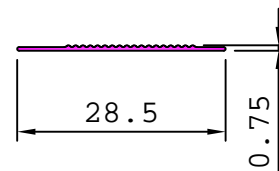

FLUTED ANGLES - TRIANGULAR

FLUTED ANGLES

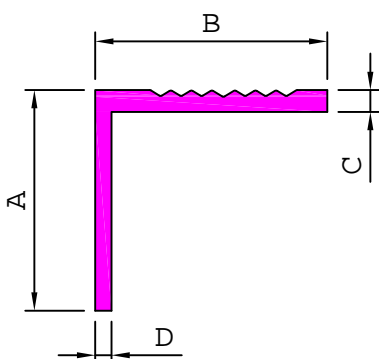

SL. No.	Section No.	A	B	C	D	Weight kg/m
1	23410	9.00	15.00	0.85	0.55	0.042
2	23415	10.60	10.60	0.50	0.35	0.022
3	23408	10.60	10.60	0.63	0.43	0.027
4	23401	12.20	12.20	0.85	0.50	0.040
5	23414	14.00	14.00	0.31	0.50	0.028
6	23409	14.50	14.50	0.58	0.45	0.036
7	23416	17.00	17.00	0.58	0.35	0.038
8	23411	17.00	17.00	0.76	0.46	0.049
9	23417	19.05	19.05	0.65	0.42	0.049
10	23402	19.05	19.05	0.90	0.55	0.067
11	23413	20.00	20.00	0.85	0.55	0.068
12	23418	22.22	22.22	0.70	0.52	0.067
13	23403	22.22	22.22	1.00	0.66	0.090
14	23404	25.40	25.40	1.15	0.80	0.121

MOULDING & TRANSPORT

DECORATIVE BEADINGS

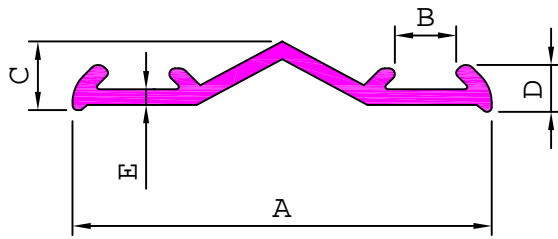
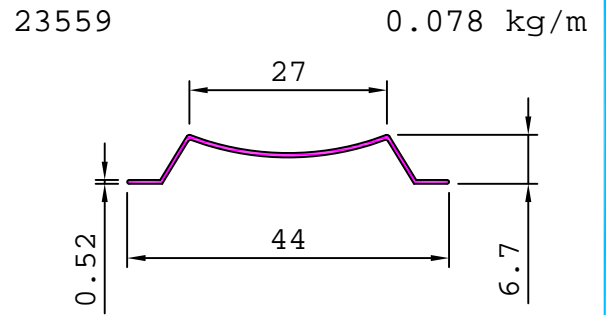
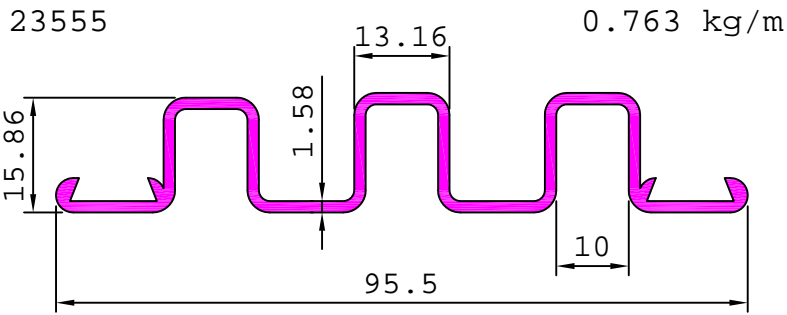

SL. No.	Section No.	A	B	C	D	E	Weight kg/m
1	23592	55.50	11.50	5.70	4.50	0.54	0.109
2	23568	55.50	11.50	5.70	4.50	0.68	0.137
3	23564	62.00	11.00	7.00	4.50	0.60	0.137

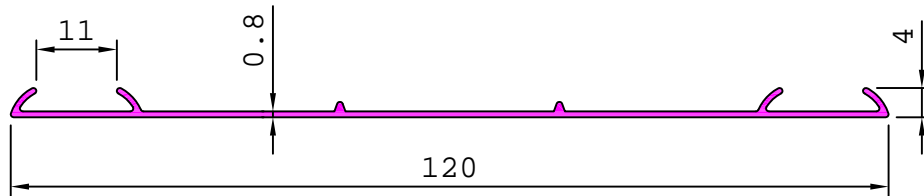

SL. No.	Section No.	A	Weight kg/m
1	23561	0.65	0.249
2	23573	0.80	0.304

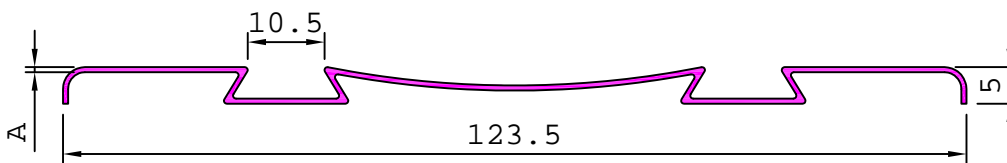
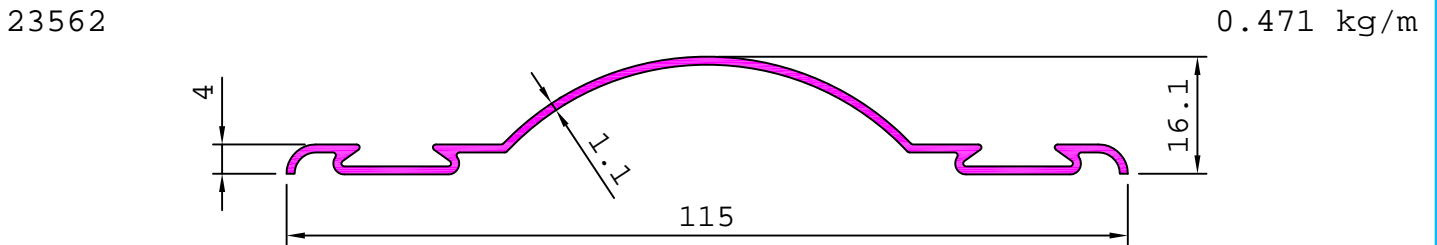

SL. No.	Section No.	A	Weight kg/m
1	23567	0.68	0.287
2	23572	0.74	0.322

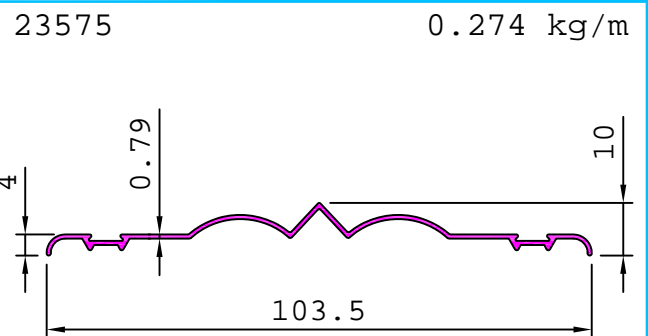
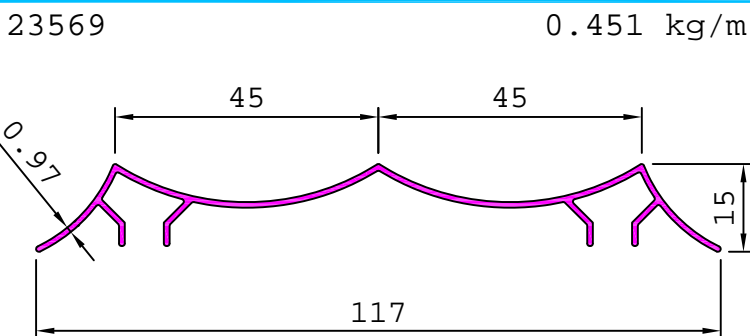

MOULDING & TRANSPORT

DECORATIVE BEADINGS

23563 0.220 kg/m

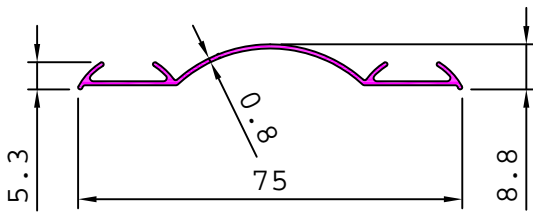

23579 0.133 kg/m

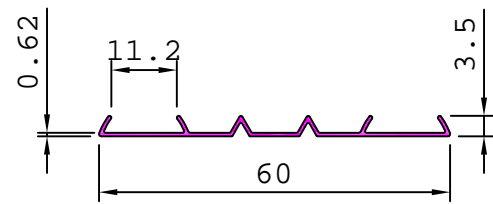

23571 0.273 kg/m

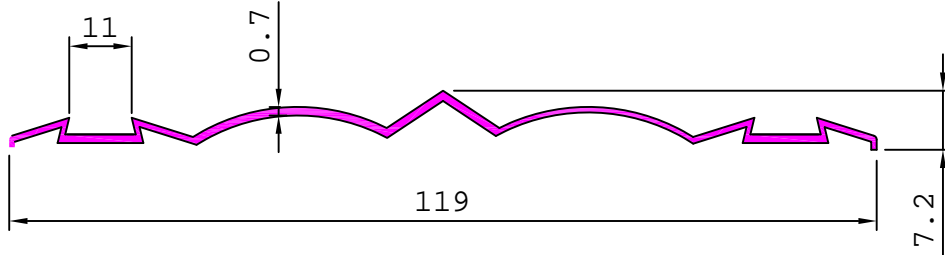

23580 0.845 kg/m

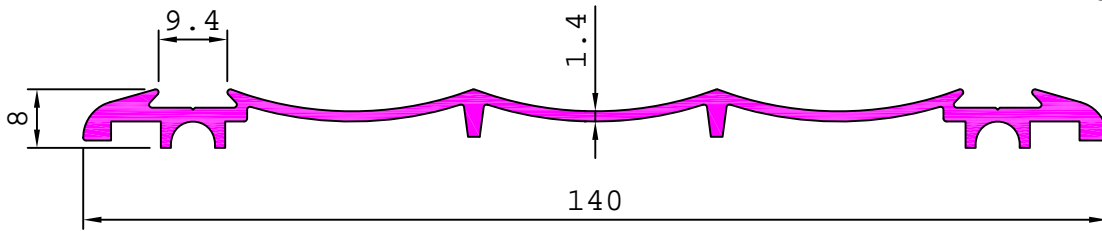

23581 0.258 kg/m

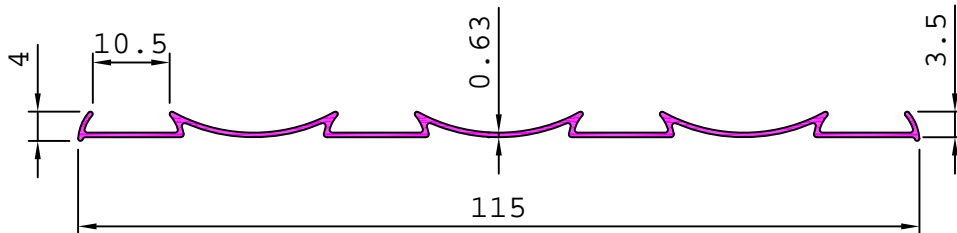

23582 0.699 kg/m

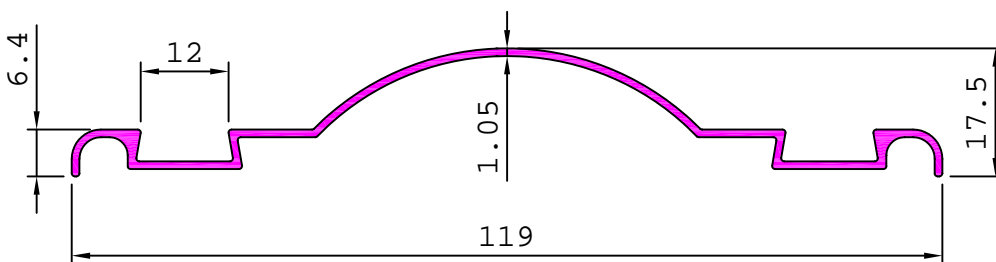
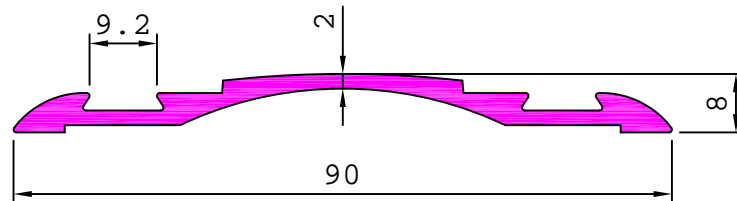

SL. No.	Section No.	A	Weight kg/m
1	23593	0.85	0.356
2	23588	1.05	0.447

MOULDING & TRANSPORT

DECORATIVE BEADINGS & SHOW BEADINGS

23583

0.215 kg/m

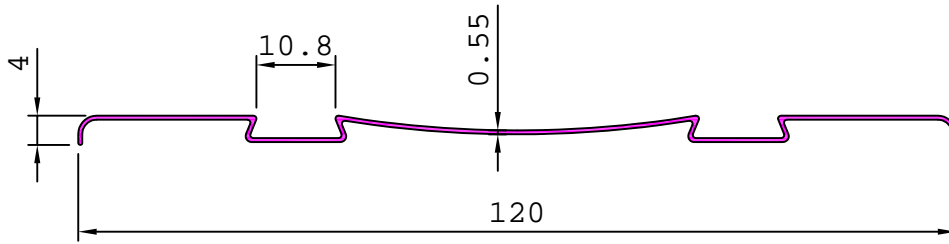

23589

0.436 kg/m

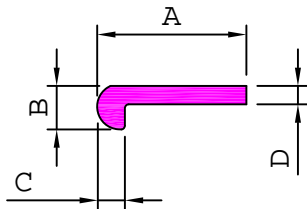
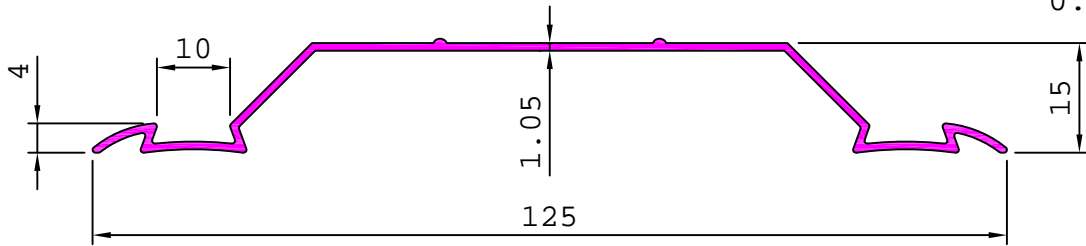

SL. No.	Section No.	A	B	C	D	Weight kg/m
1	23772	12.00	3.00	1.50	0.68	0.029
2	23765	16.20	3.80	1.60	0.80	0.043
3	23769	18.00	3.00	1.50	0.74	0.042

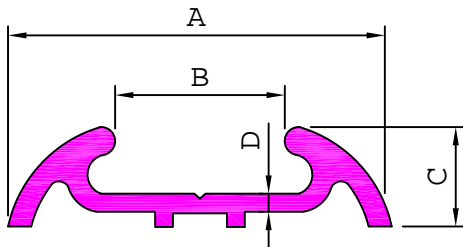

SL. No.	Section No.	A	B	C	D	Weight kg/m
1	23770	49.00	24.00	10.00	0.95	0.200
2	23778	50.00	24.00	13.50	1.40	0.342
3	23760	53.20	23.50	14.50	2.50	0.672

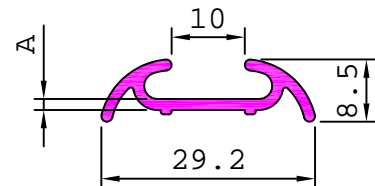

SL. No.	Section No.	D	Weight kg/m
1	23818	0.63	0.093
2	23776	0.79	0.116
3	23794	1.06	0.150
4	23795	1.50	0.205

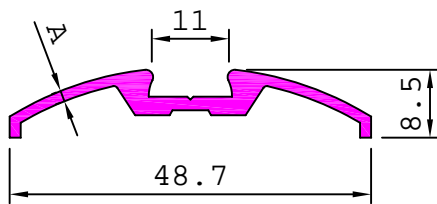

SL. No.	Section No.	A	Weight kg/m
1	23781	0.65	0.144
2	23793	1.25	0.232

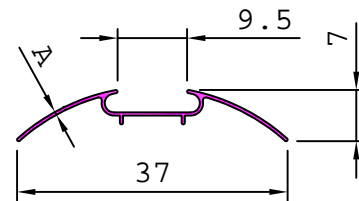

SL. No.	Section No.	A	Weight kg/m
1	23780	0.44	0.061
2	23817	0.39	0.054

MOULDING & TRANSPORT

SHOW BEADINGS

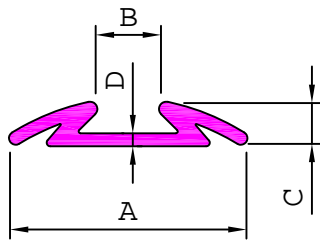

SL. No.	Section No.	A	B	C	D	Weight kg/m
1	23796	22.00	10.00	3.50	0.45	0.042
2	23767	23.00	10.00	4.30	0.56	0.054
3	23790	26.00	10.00	3.50	0.40	0.039
4	23761	27.50	10.00	4.00	0.60	0.053
5	23806	29.20	10.00	5.00	1.40	0.167
6	23808	30.00	10.00	5.00	1.50	0.197
7	23807	30.00	10.00	5.25	0.90	0.121
8	23800	31.75	9.75	4.00	0.50	0.060
9	23768	31.75	9.75	5.00	0.58	0.077
10	23751	31.75	9.75	5.00	1.10	0.136

23809 0.269 kg/m

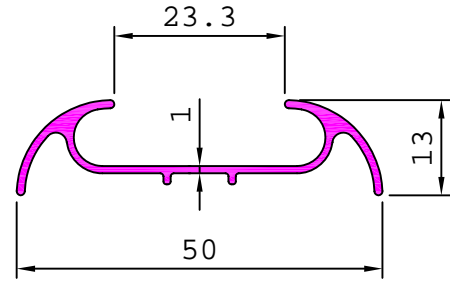

23810 0.288 kg/m

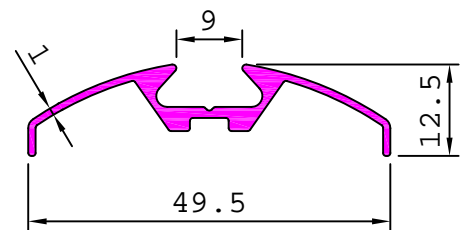

23759 0.049 kg/m

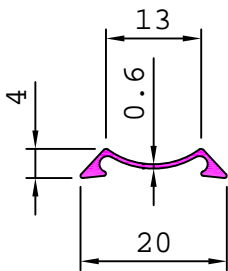

23775 0.049 kg/m

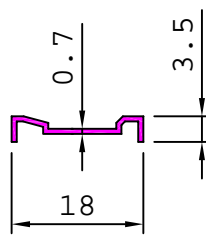

23798 0.184 kg/m

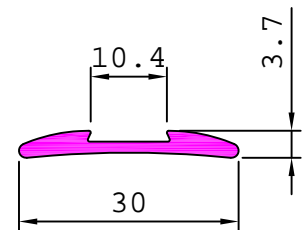

23797 0.368 kg/m

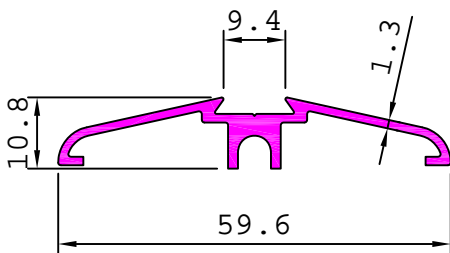

23799 0.188 kg/m

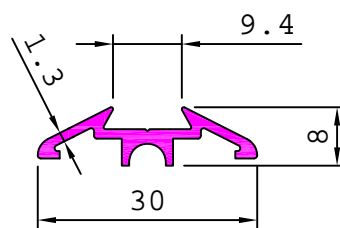

23805 0.099 kg/m

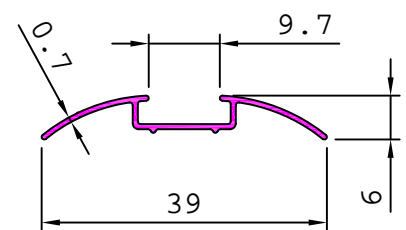

23811 0.042 kg/m

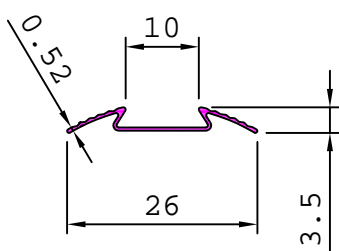

23812 0.349 kg/m

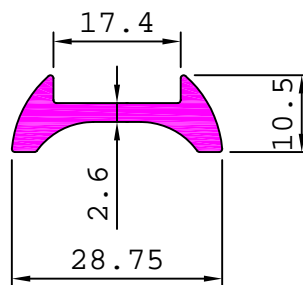

S4827 0.056 kg/m

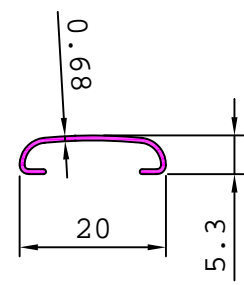

MOULDING & TRANSPORT

SHOW BEADINGS

S4828 0.065 kg/m

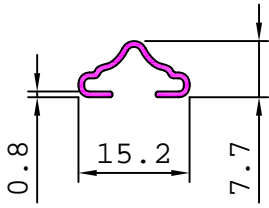

S4829 0.062 kg/m

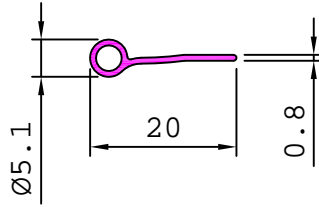

S4464 0.022 kg/m

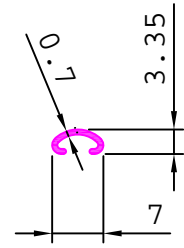

MOULDING & TRANSPORT

DOUBLE GLASS CHANNELS

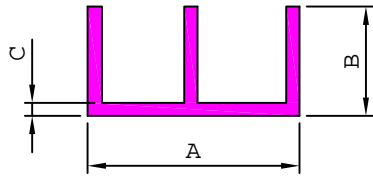

24004

0.236 kg/m

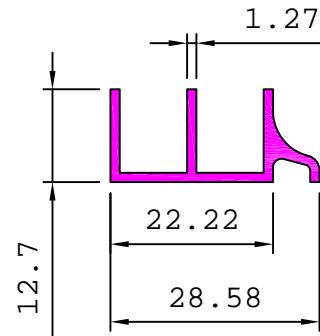

24048

0.168 kg/m

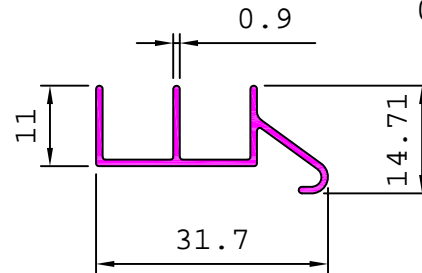

SL. No.	Section No.	A	B	C	Weight kg/m
1	24057	15.00	7.50	0.36	0.035
2	24053	15.00	7.50	0.45	0.044
3	24047	16.00	8.00	0.44	0.045
4	24054	16.00	10.00	0.47	0.057
5	24036	17.00	9.50	0.42	0.050
6	24045	17.00	10.00	0.54	0.067
7	24016	17.00	10.00	0.65	0.079
8	24037	17.70	12.00	0.51	0.072
9	24049	18.00	9.50	0.45	0.055
10	24013	18.00	11.00	0.65	0.086
11	24006	18.00	11.00	1.22	0.156
12	24014	18.00	12.50	0.65	0.094
13	24021	19.00	12.50	0.75	0.110
14	24022	19.00	12.50	0.90	0.130
15	24023	19.00	12.50	1.10	0.158
16	24024	20.50	11.50	0.95	0.134
17	24038	21.50	10.50	0.39	0.054
18	24017	22.00	10.00	0.82	0.109
19	24018	22.00	10.00	0.93	0.124
20	24052	22.00	10.50	0.65	0.090
21	24015	22.00	11.00	0.53	0.076
22	24033	22.00	11.00	0.74	0.105
23	24034	22.00	11.00	0.92	0.130
24	24019	22.00	11.00	1.08	0.150
25	24029	22.00	11.00	1.12	0.156
26	24007	22.00	11.00	1.22	0.169
27	24008	22.00	12.50	1.22	0.184
28	24039	22.23	12.70	0.67	0.105
29	24011	22.23	12.70	0.83	0.130
30	24001	22.23	12.70	1.05	0.162
31	24055	24.00	10.00	0.57	0.080
32	24051	25.00	12.00	0.56	0.090
33	24046	25.00	12.00	0.67	0.107
34	24043	25.00	12.00	0.90	0.141
35	24042	25.00	12.50	1.30	0.205
36	24031	28.00	15.50	0.65	0.127
37	24050	28.00	15.50	0.77	0.150
38	24012	28.00	15.50	1.10	0.211
39	24056	35.00	10.00	0.60	0.102
40	24032	48.00	13.00	0.72	0.166
41	24035	48.00	13.00	0.85	0.195
42	24027	48.00	13.00	1.00	0.227

MOULDING & TRANSPORT

BUS WINDOW GUIDE FRAMES

24204 0.247 kg/m

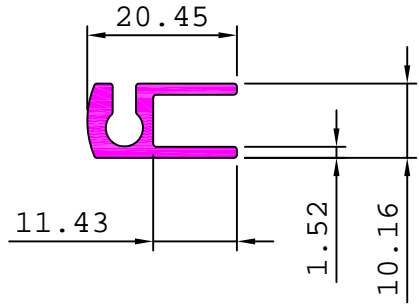

24211 0.148 kg/m

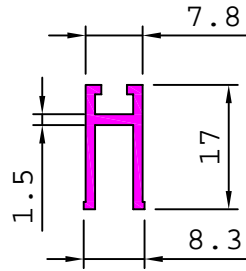

24212 0.171 kg/m

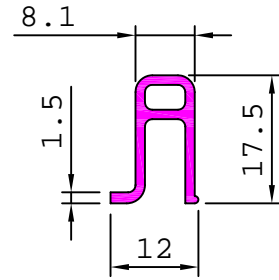

24218 0.464 kg/m

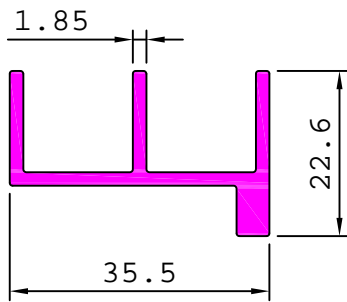

24208 0.592 kg/m

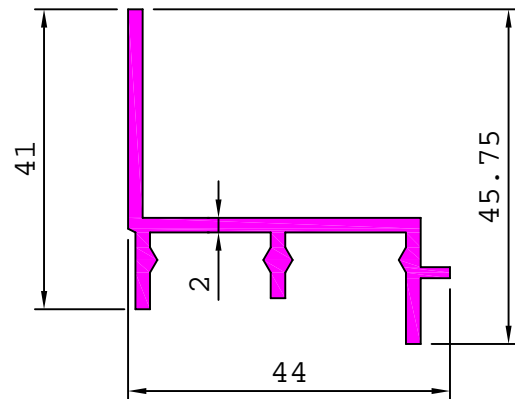

24234 0.600 kg/m

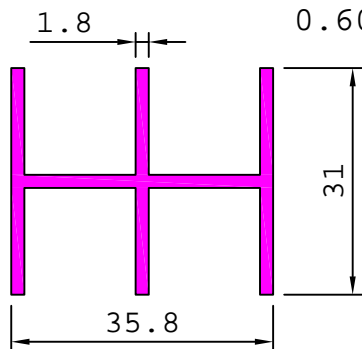

24220 0.687 kg/m

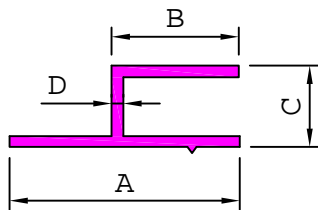
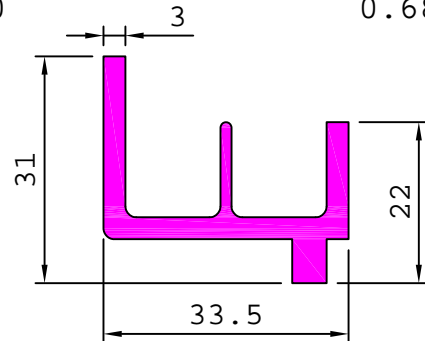

SL. No.	Section No.	A	B	C	D	Weight kg/m
1	24235	29.90	18.00	12.30	0.70	0.112
2	24213	31.00	16.50	11.00	0.84	0.130
3	24214	34.60	19.50	12.70	0.93	0.166

24219 0.243 kg/m

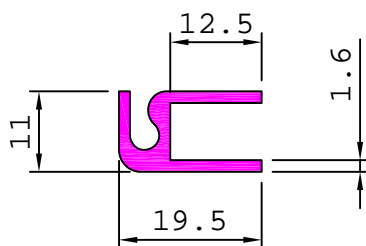

24221 0.662 kg/m

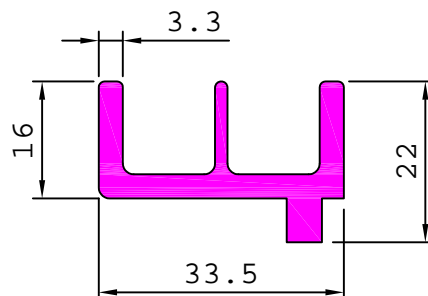

24238 0.172 kg/m

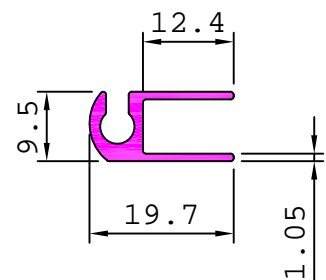

MOULDING & TRANSPORT

BUS WINDOW GUIDE FRAMES

24223 0.478 kg/m

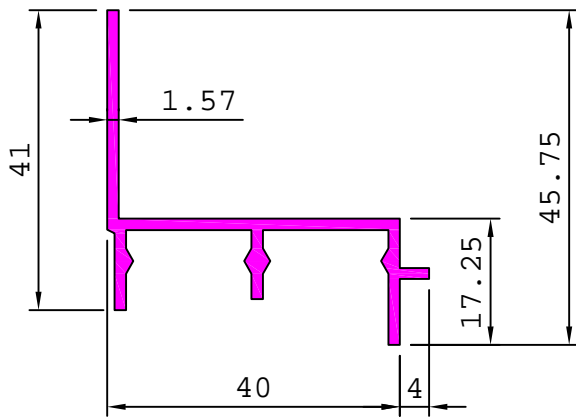

24226 0.686 kg/m

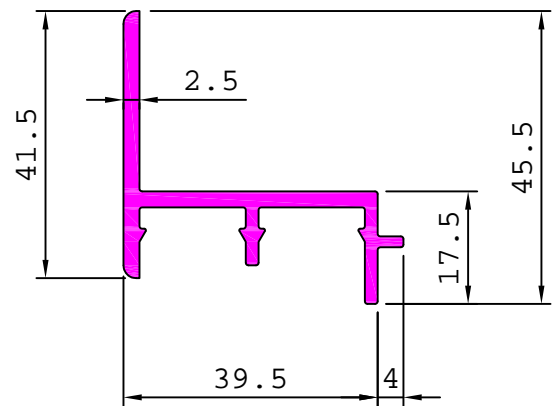

24231 0.593 kg/m

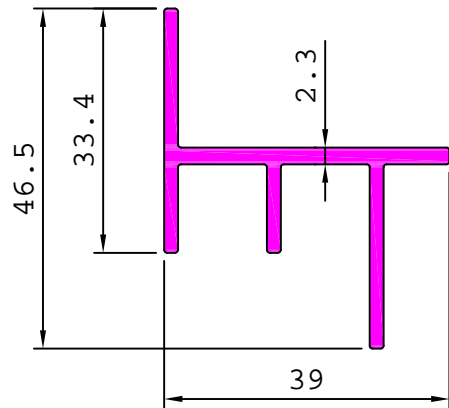

24232 0.665 kg/m

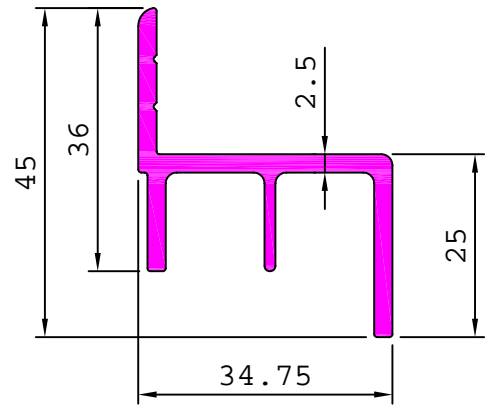

24233 0.580 kg/m

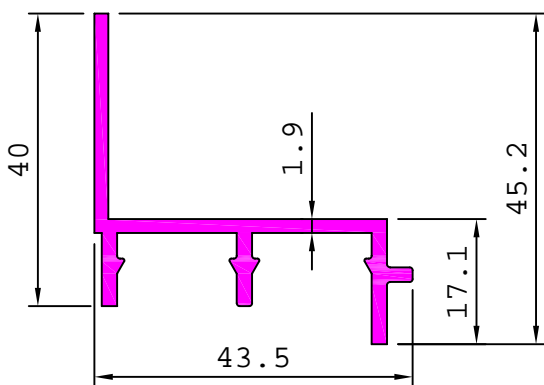

24237 0.414 kg/m

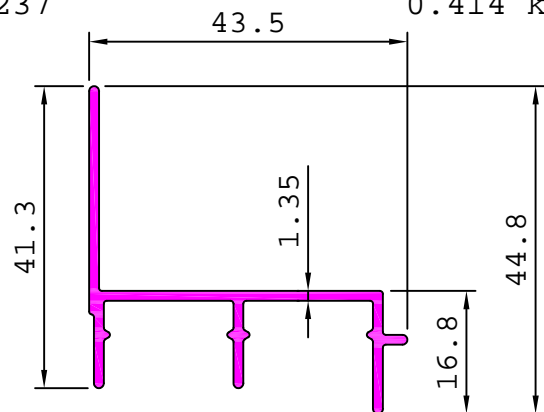

24236 0.092 kg/m

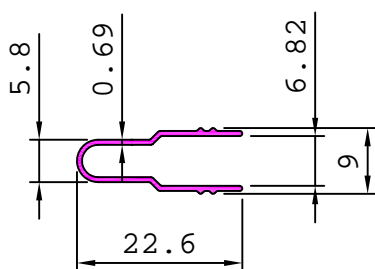

24240 0.601 kg/m

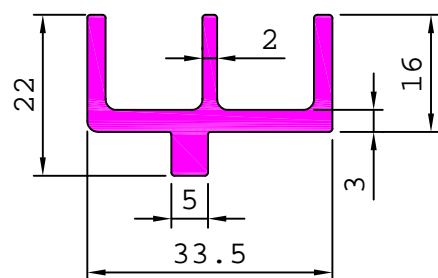

MOULDING & TRANSPORT

BUS WINDOW GUIDE FRAMES

24241

0.662 kg/m

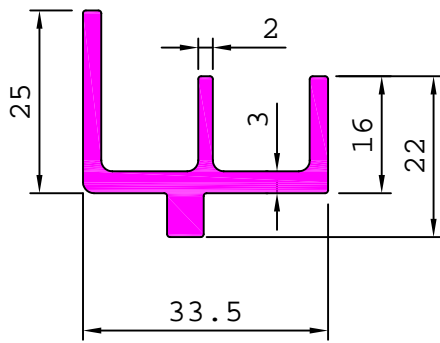

24242

0.895 kg/m

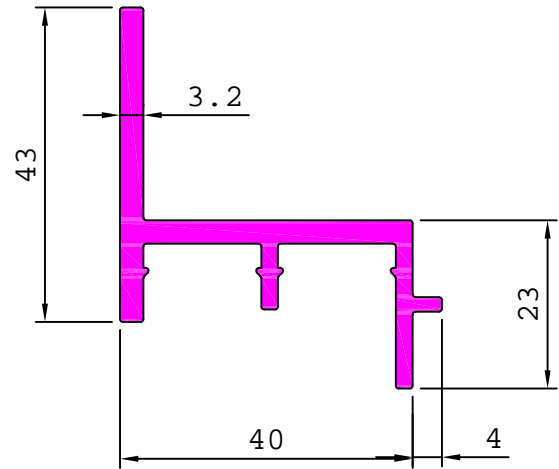

BUS WIND SHIELDS

24304

0.439 kg/m

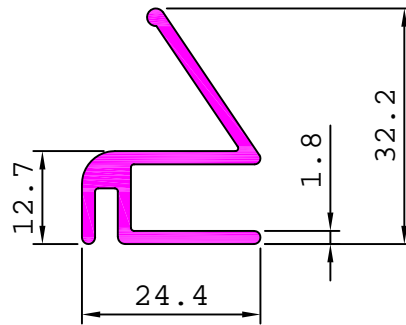

MOULDING & TRANSPORT

FOOT BOARDS & MISCELLANEOUS

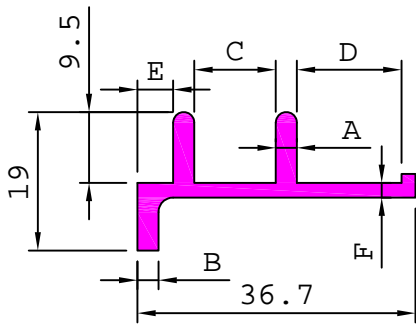

SL. No.	Section No.	A	B	C	D	E	F	Weight kg/m
1	24401	2.90	4.10	11.60	13.00	4.80	1.50	0.388
2	24413	1.60	2.40	12.60	14.10	5.70	1.10	0.248

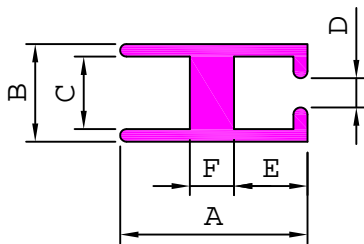

SL. No.	Section No.	A	B	C	D	E	F	Weight kg/m
1	24419	22.00	12.00	10.20	6.00	8.50	3.95	0.225
2	24416	23.60	12.60	8.25	5.40	8.60	6.30	0.434
3	24402	24.00	12.70	8.70	5.50	8.70	6.60	0.432
4	24428	24.00	12.70	9.10	5.50	9.20	5.60	0.390
5	24411	24.00	12.70	10.70	5.50	9.65	4.50	0.273
6	24454	24.00	13.00	10.40	4.30	10.30	4.50	0.316

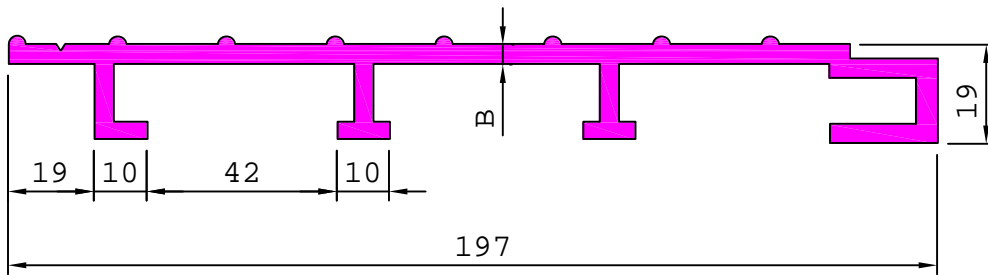

SL. No.	Section No.	B	Weight kg/m
1	24414	1.50	1.338
2	24407	1.80	1.581

MOULDING & TRANSPORT

MISCELLANEOUS

24426

0.447 kg/m

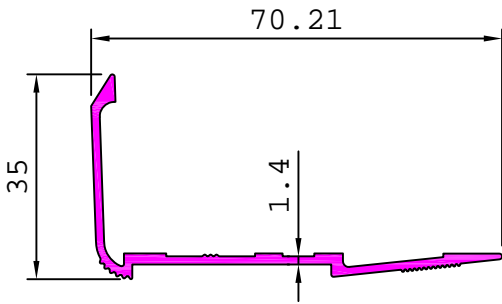

24430

0.248 kg/m

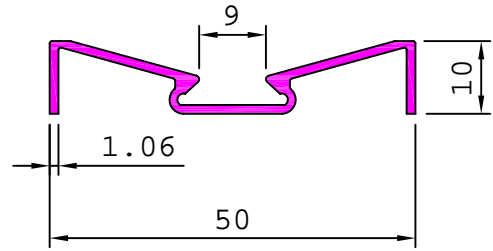

24429

0.607 kg/m

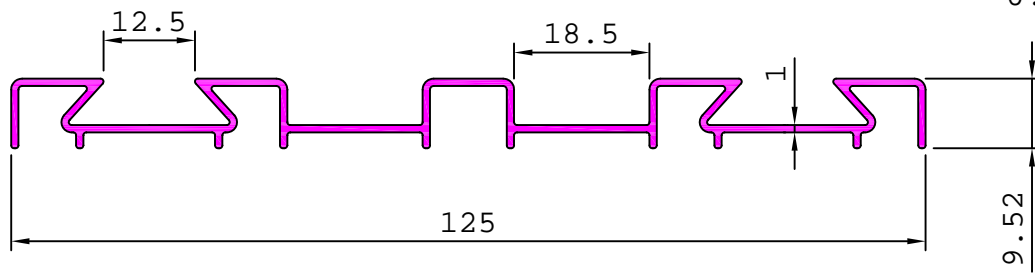

24437

1.505 kg/m

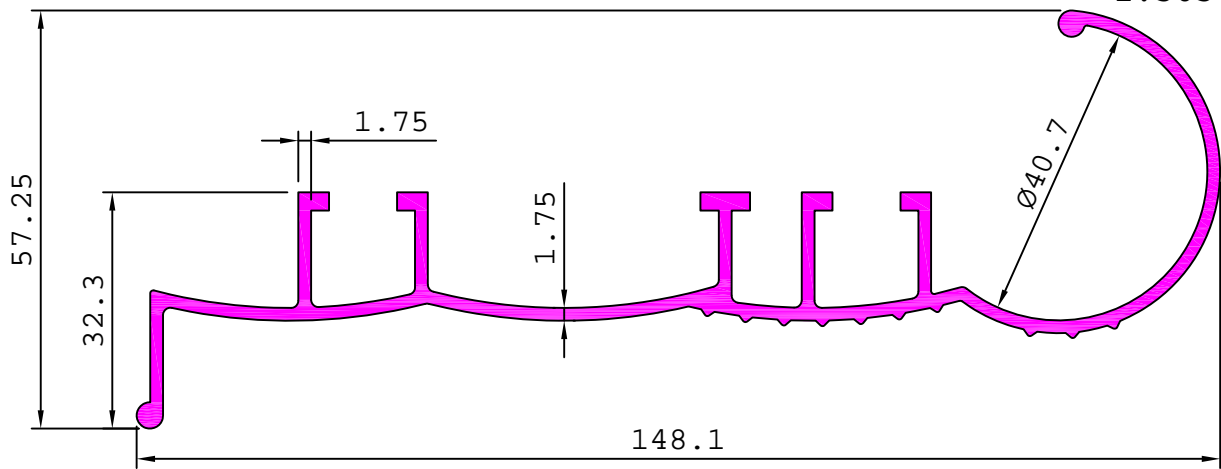

24442

0.466 kg/m

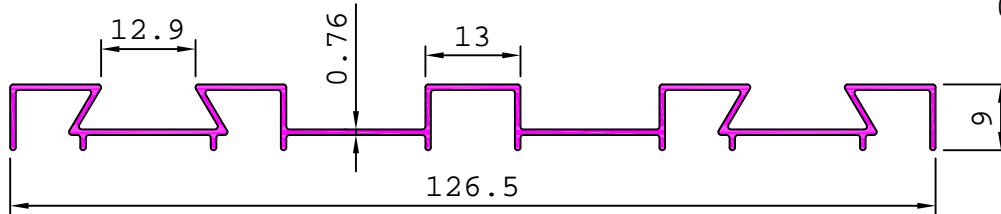

24447

1.605 kg/m

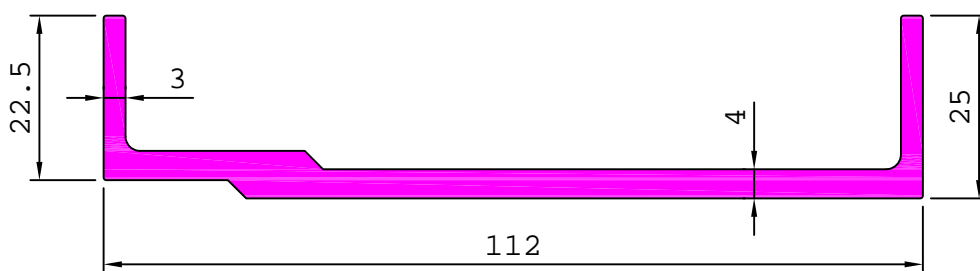

MOULDING & TRANSPORT

MISCELLANEOUS

24441 0.267 kg/m

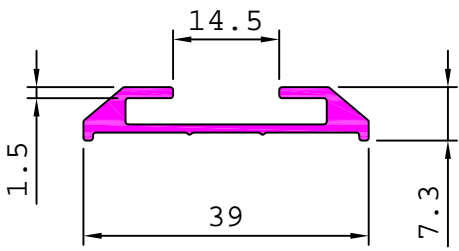

24443 1.905 kg/m

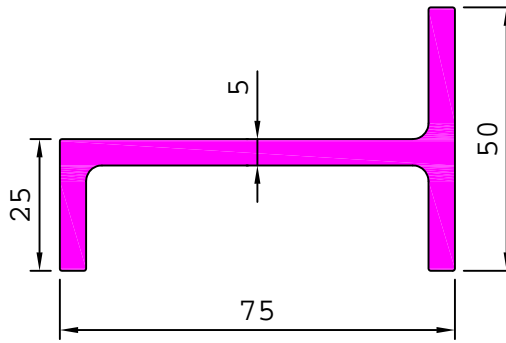

24444 1.078 kg/m

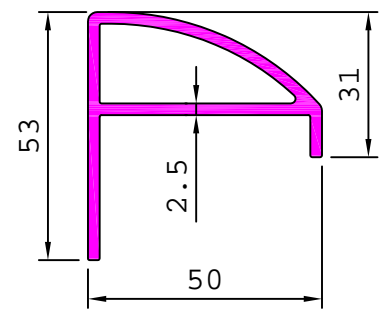

24445

2.694 kg/m

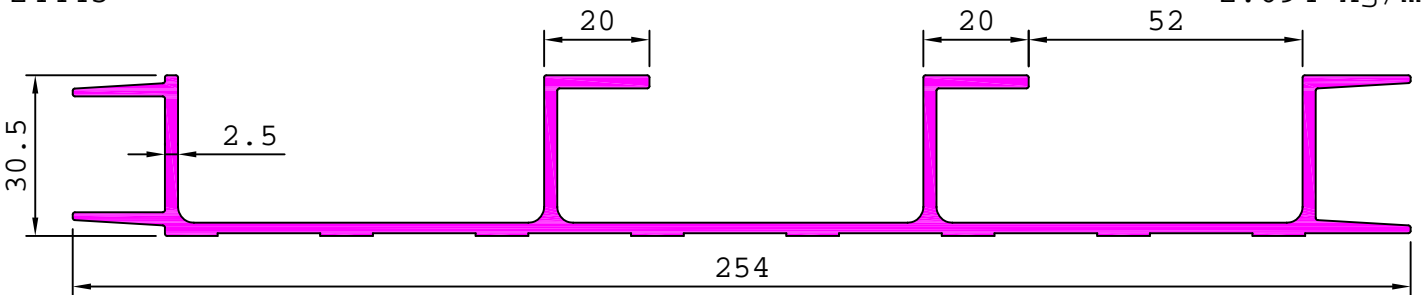

24446

2.335 kg/m

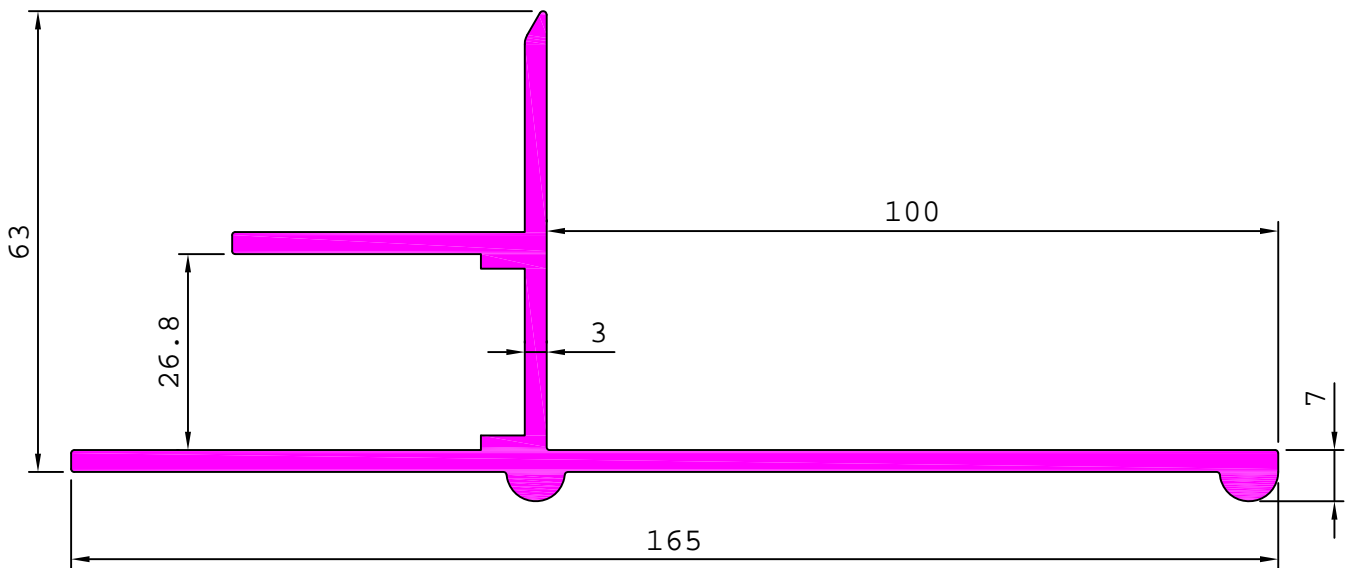

24456

0.382 kg/m

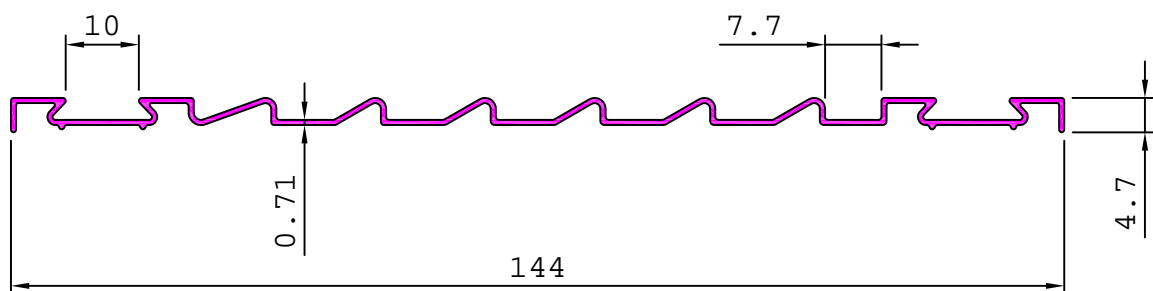

MOULDING & TRANSPORT

MISCELLANEOUS

24448

1.148 kg/m

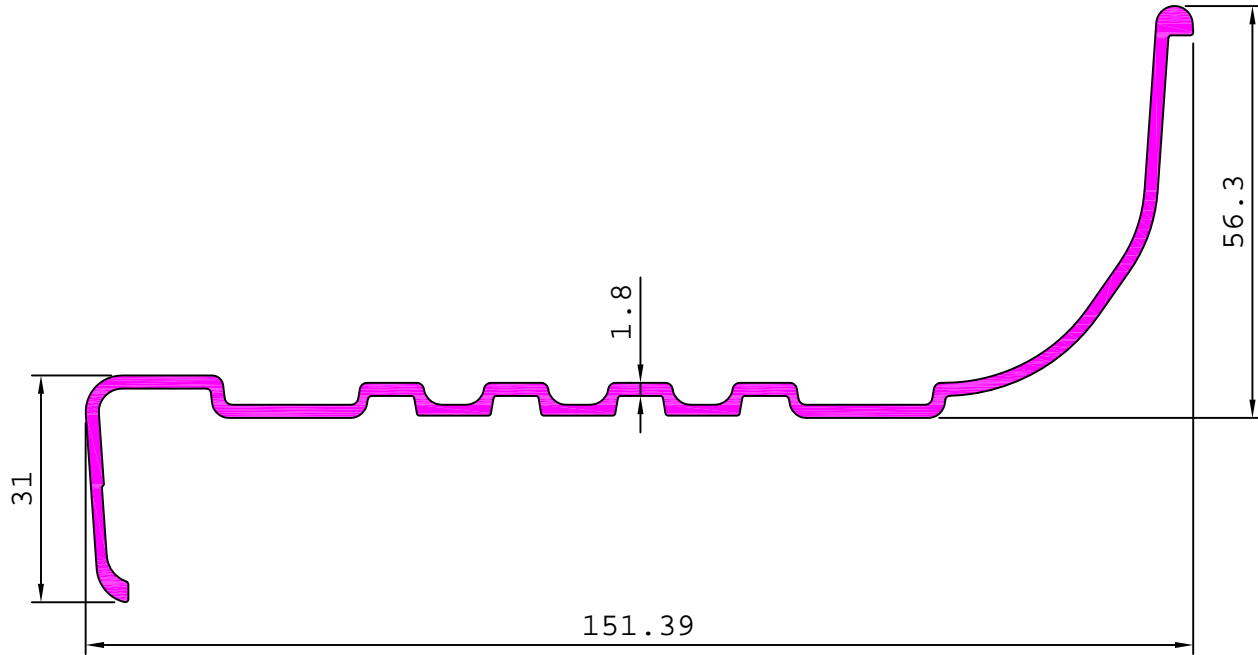

24450

1.447 kg/m

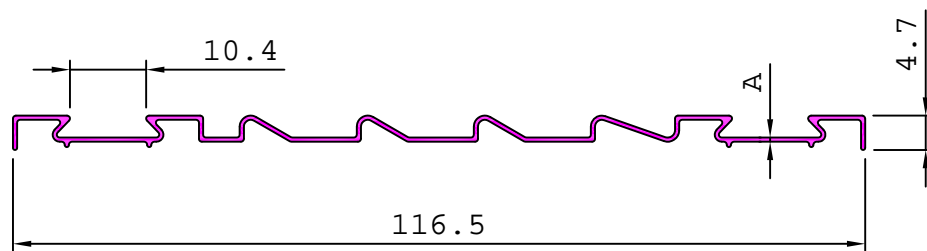
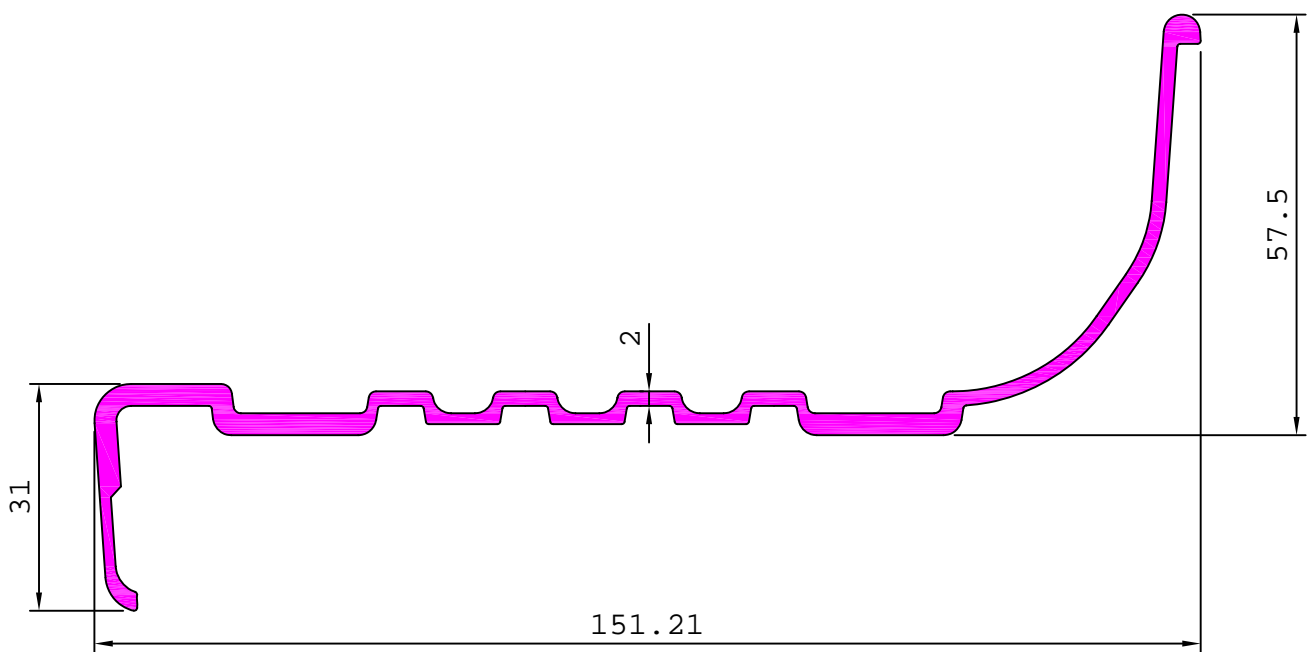

Sl. No.	Section No.	A	Weight kg/m
1	24493	0.45	0.202
2	24455	0.55	0.247

MOULDING & TRANSPORT

MISCELLANEOUS

24451 2.394 kg/m

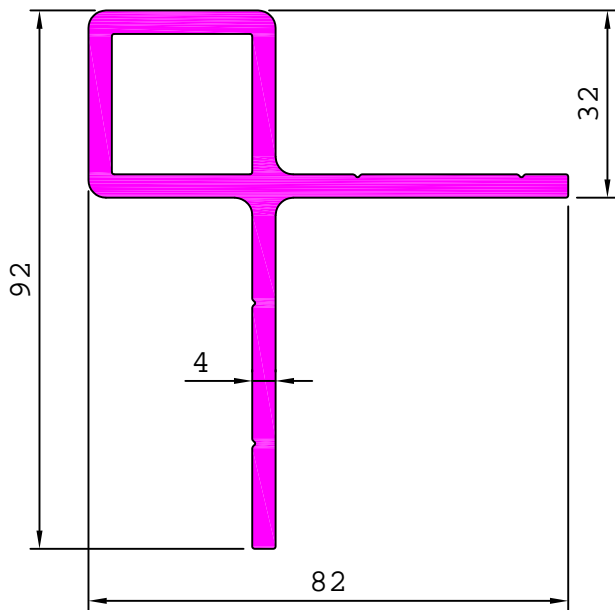

24453 0.322 kg/m

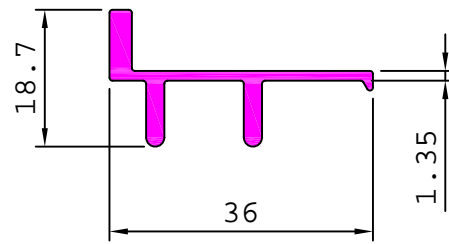

24458 0.171 kg/m

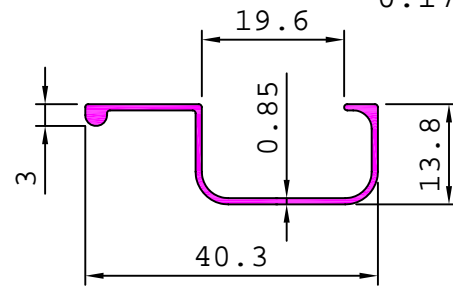

24459 1.544 kg/m

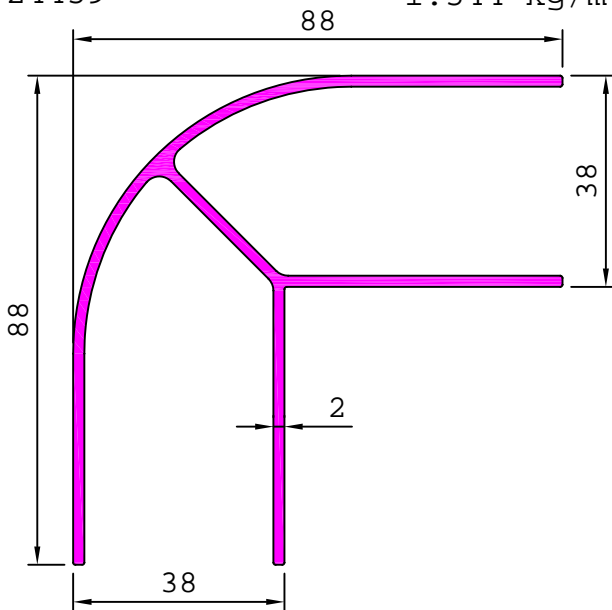

24472 1.661 kg/m

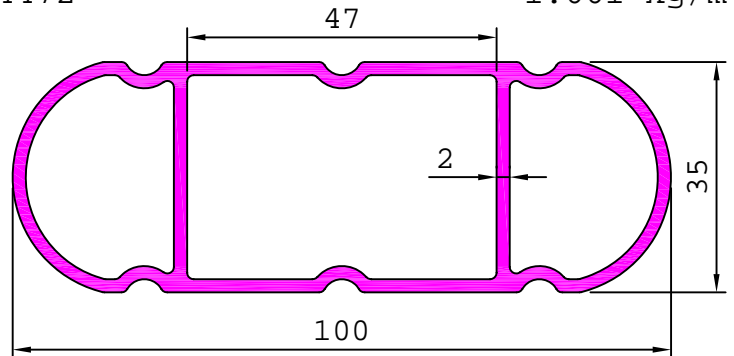

24475 0.409 kg/m

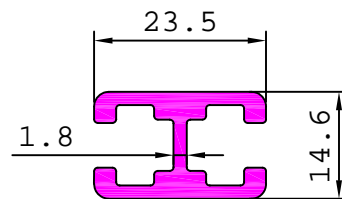

24460 1.969 kg/m

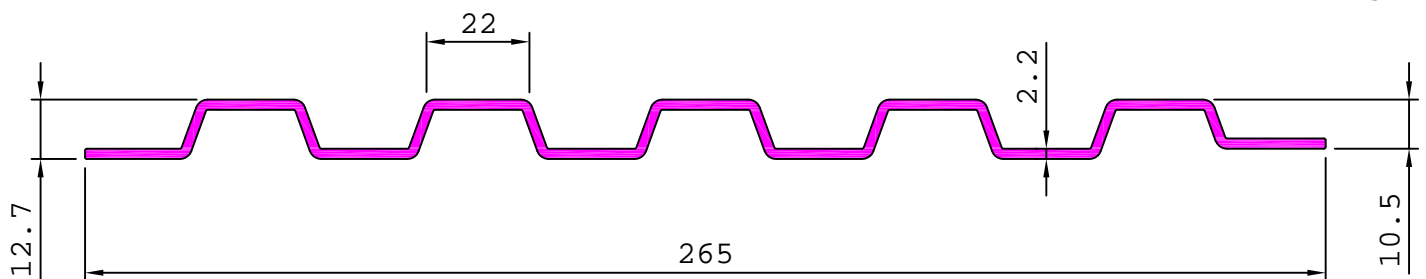

MOULDING & TRANSPORT

MISCELLANEOUS

24463

2.190 kg/m

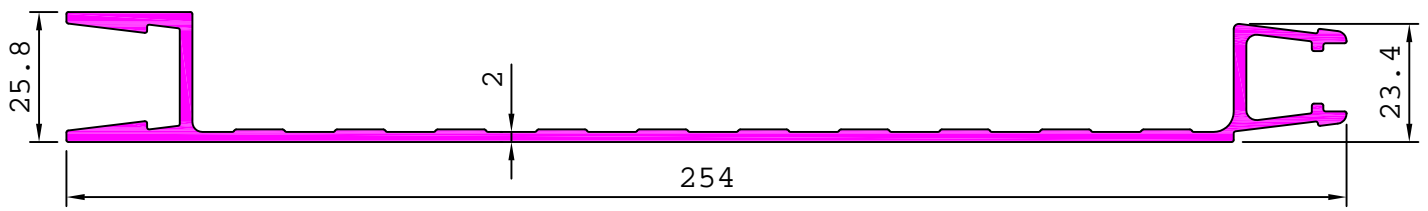

24473

2.566 kg/m

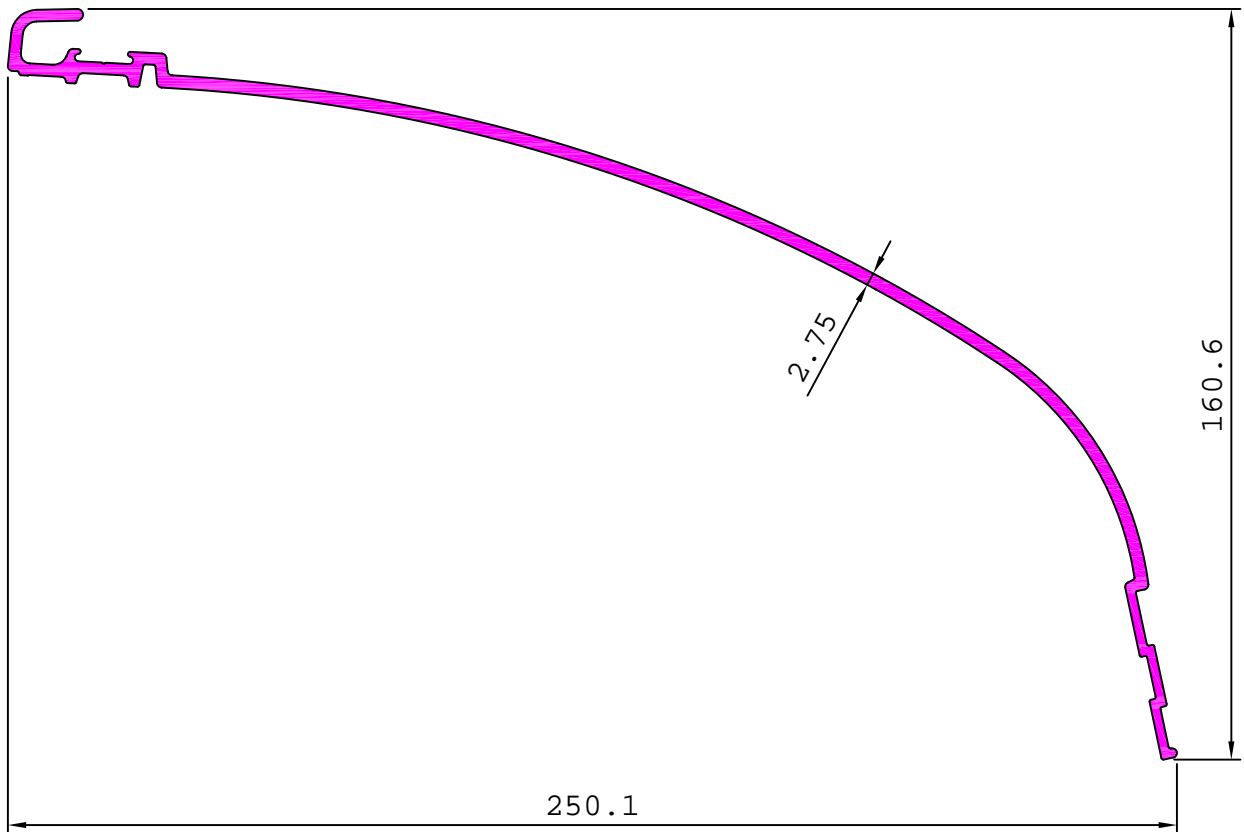

24474

1.997 kg/m

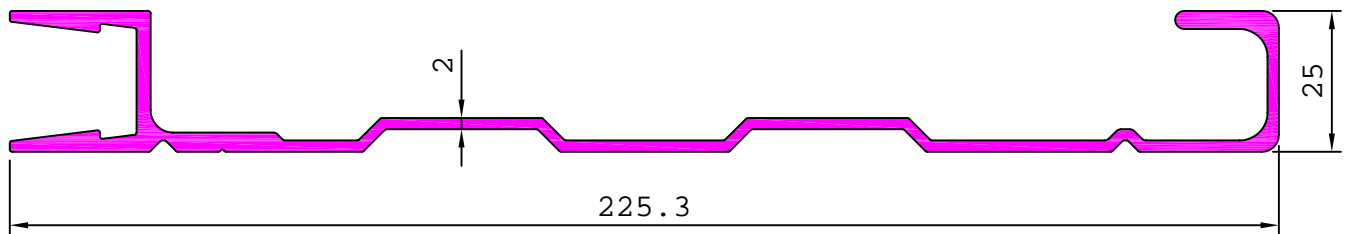

24480

0.594 kg/m

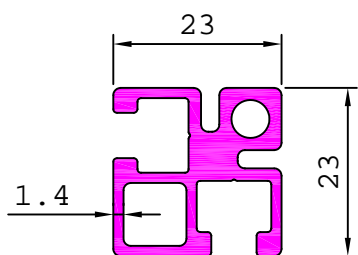

29449

0.354 kg/m

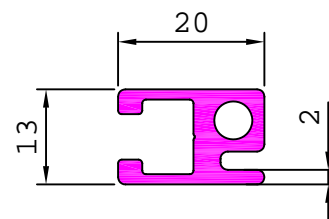

MOULDING & TRANSPORT

MISCELLANEOUS

24476 1.462 kg/m

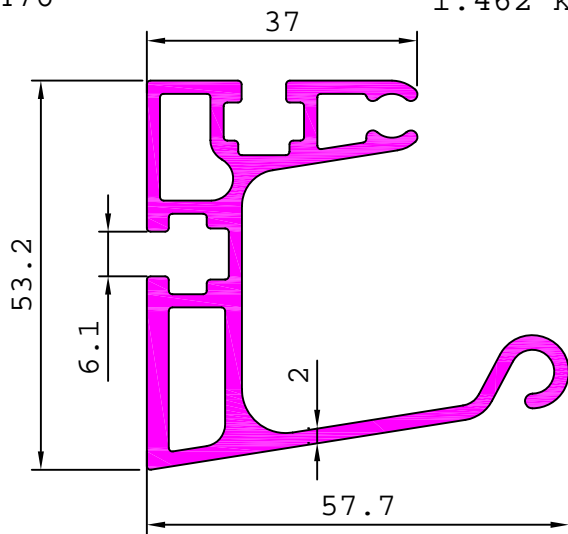

24477 1.300 kg/m

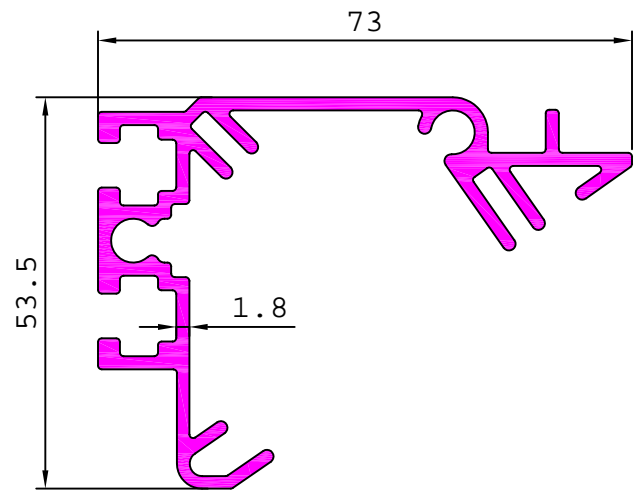

24478 3.609 kg/m

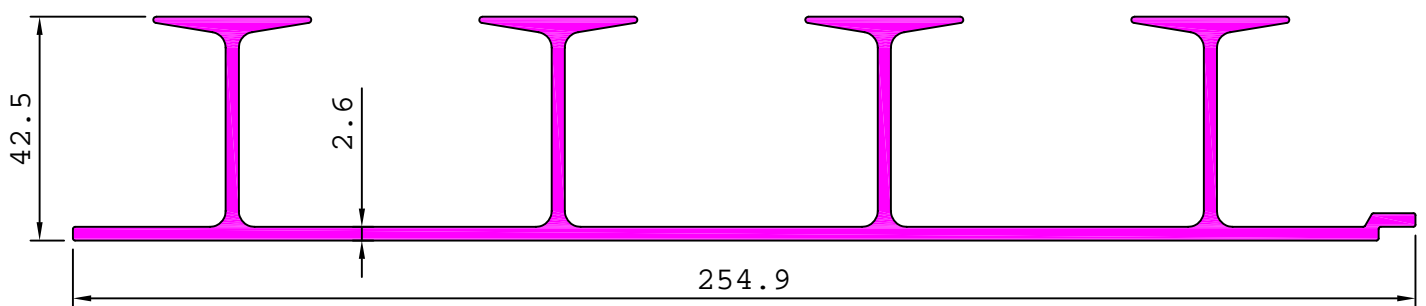

24479 1.300 kg/m

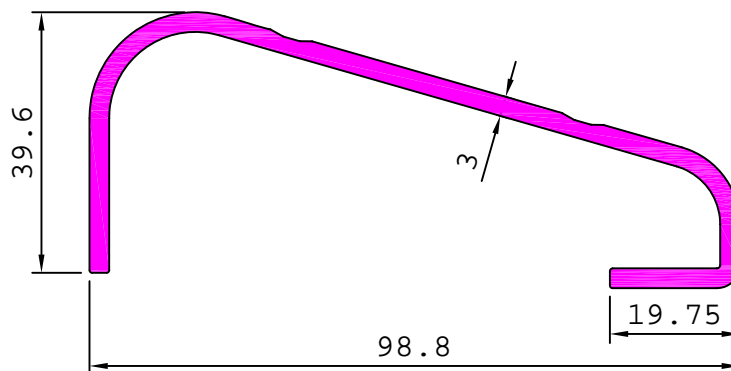

24483 0.198 kg/m

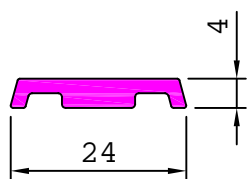

24484 0.201 kg/m

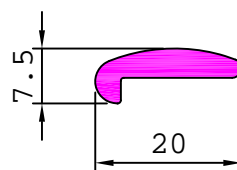

24485 0.137 kg/m

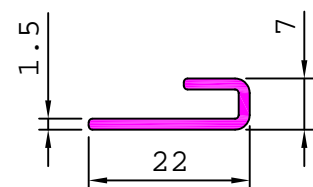

MOULDING & TRANSPORT

MISCELLANEOUS

24481

3.513 kg/m

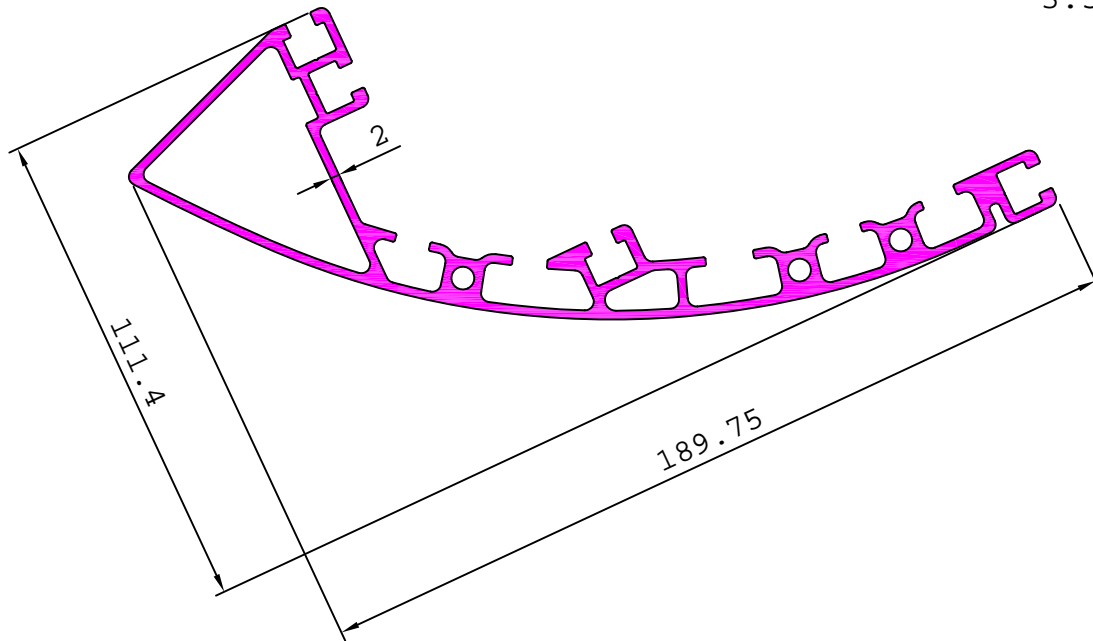

24486

1.954 kg/m

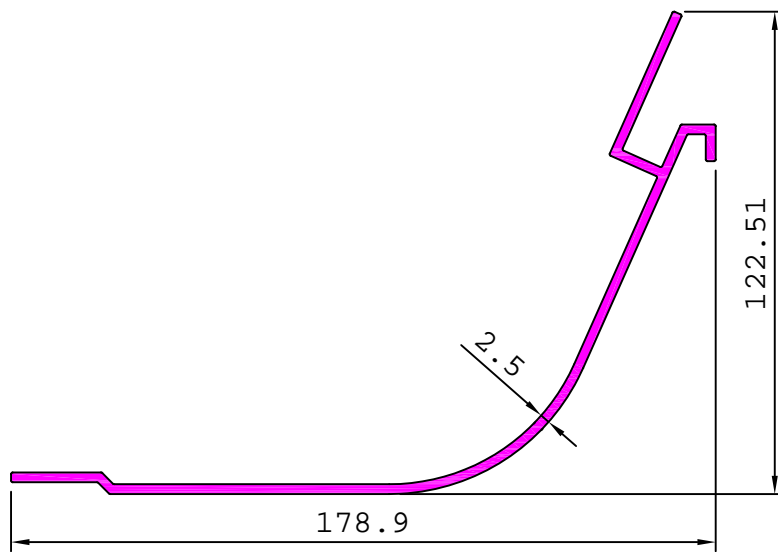

24488

1.064 kg/m

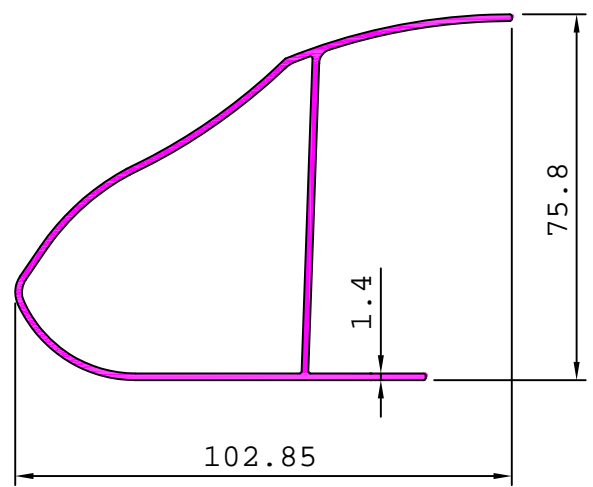

24494

1.461 kg/m

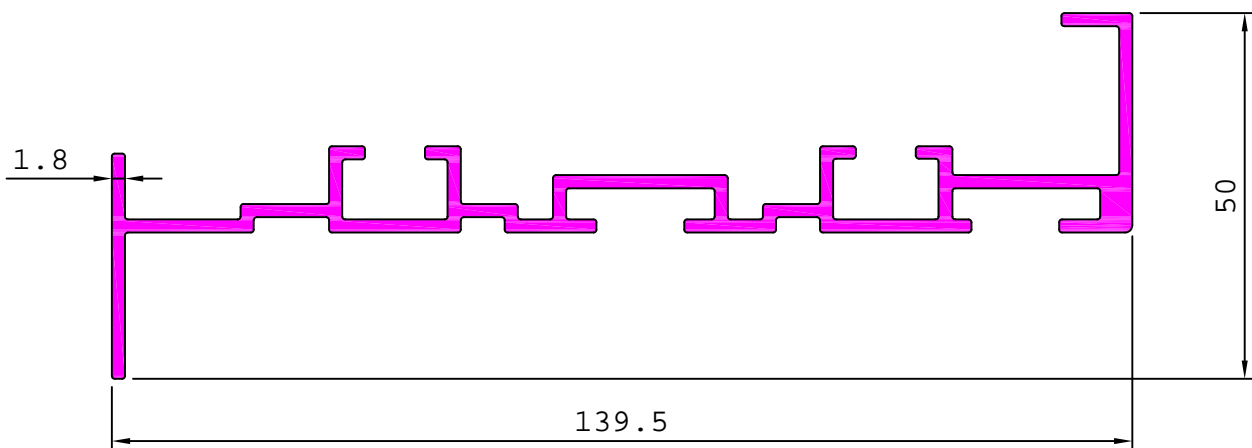

MOULDING & TRANSPORT

MISCELLANEOUS

24487 1.509 kg/m

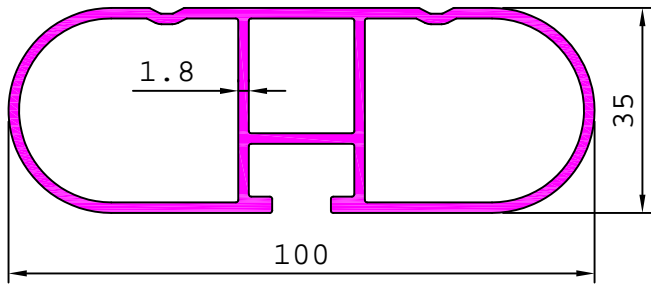

24489 1.328 kg/m

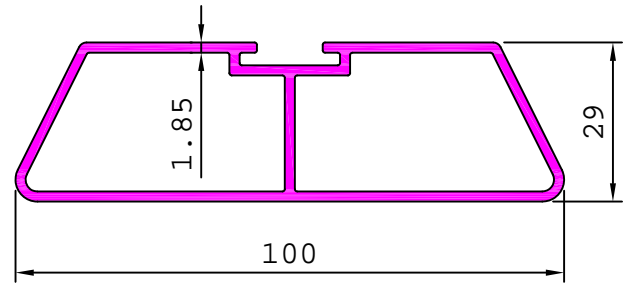

24490 1.410 kg/m

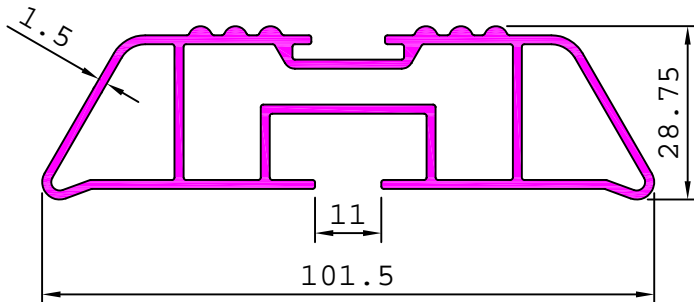

24491 0.270 kg/m

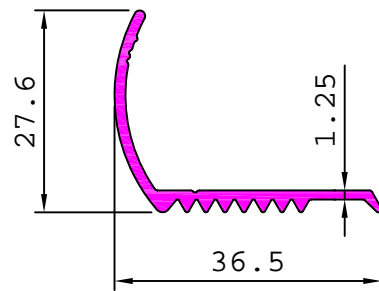

24492 1.558 kg/m

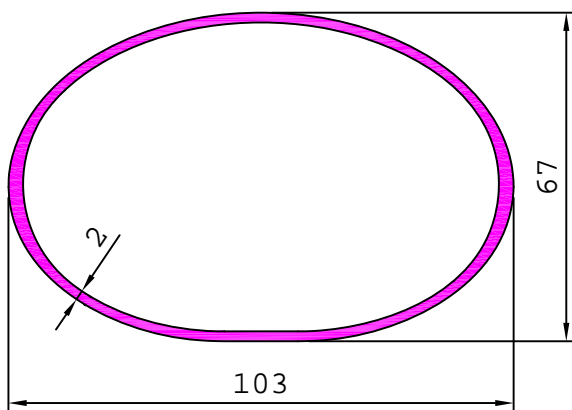

24495 0.147 kg/m

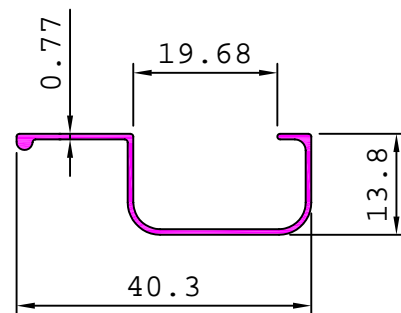

24496 1.140 kg/m

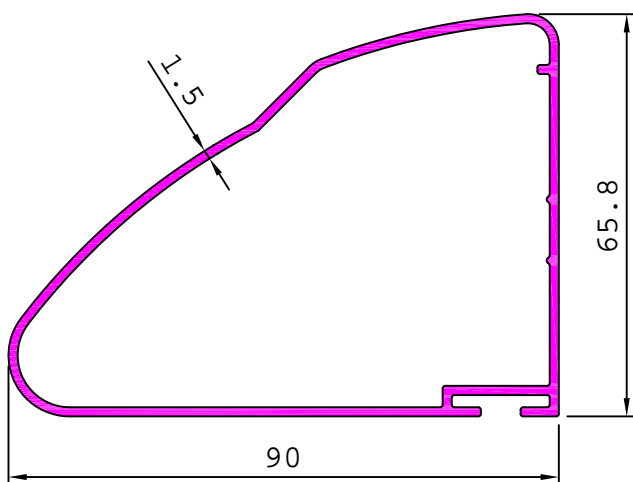

24497 0.587 kg/m

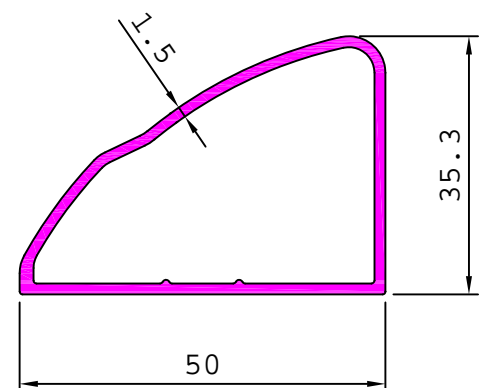

MOULDING & TRANSPORT

MISCELLANEOUS

24499

0.371 kg/m

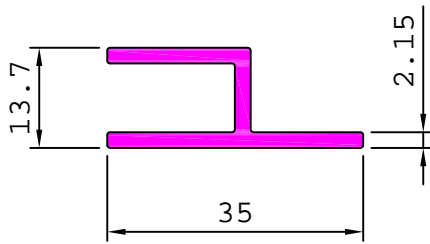

24500

1.016 kg/m

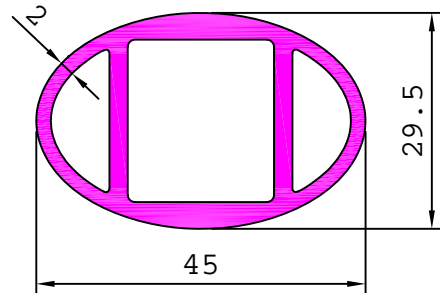

24501

0.689 kg/m

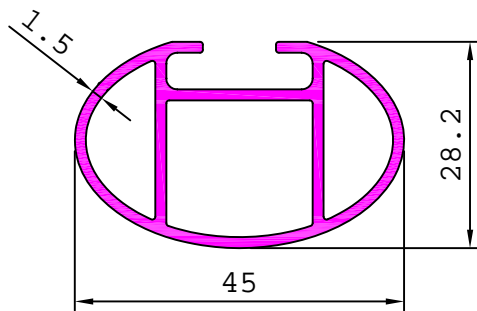

24503

1.340 kg/m

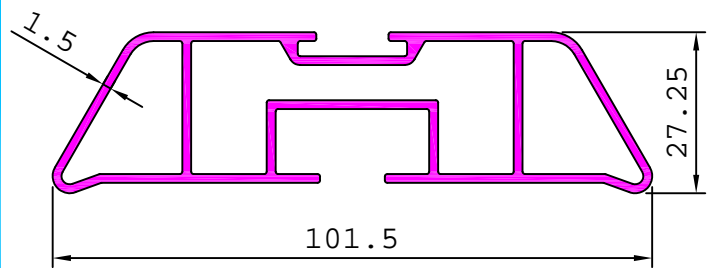

24502

1.460 kg/m

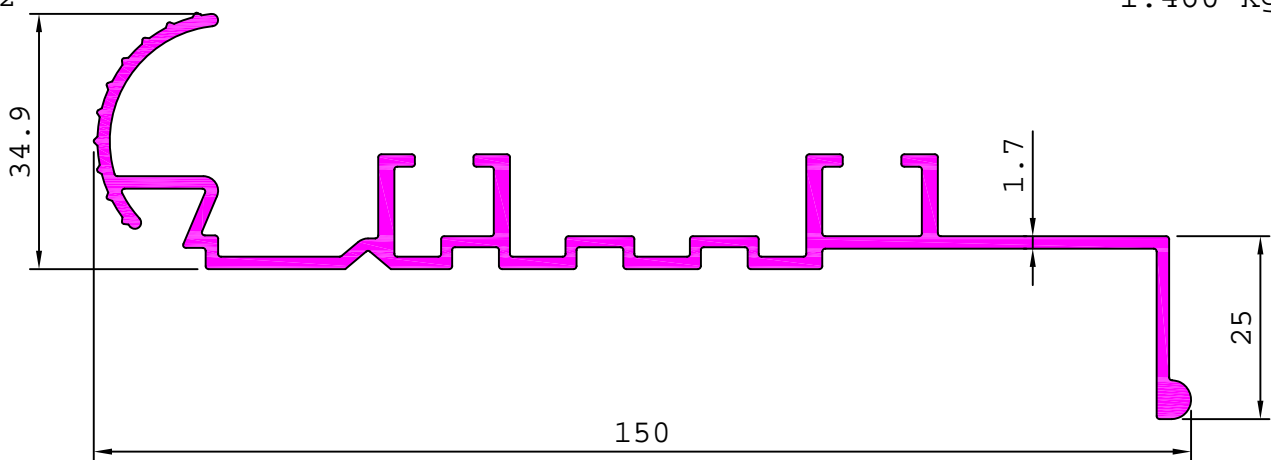

24505

0.922 kg/m

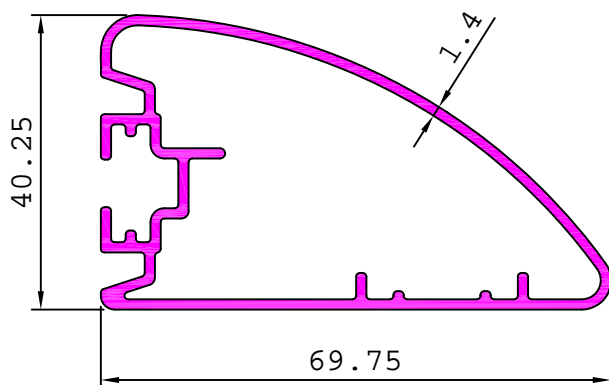

29512

1.175 kg/m

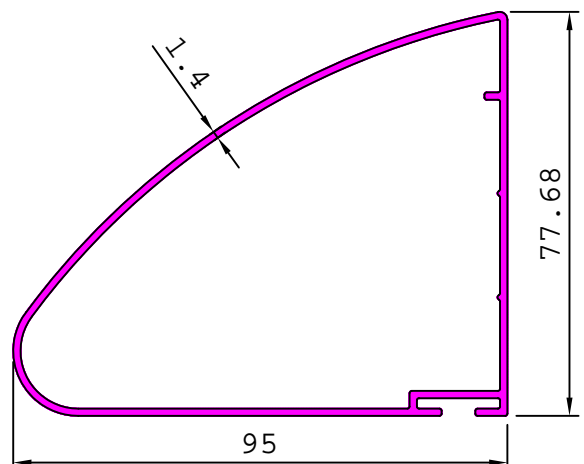

MOULDING & TRANSPORT

MISCELLANEOUS

24504

0.342 kg/m

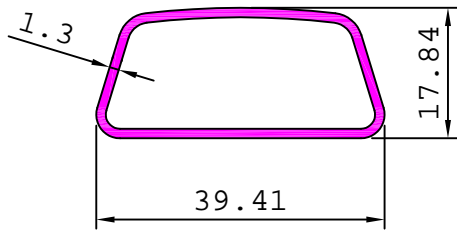

28097

3.204 kg/m

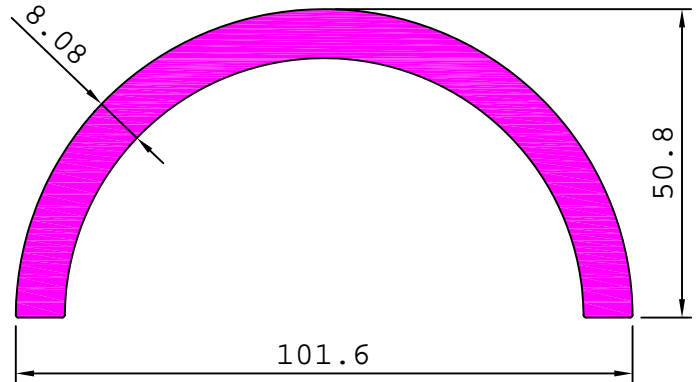

29450

0.744 kg/m

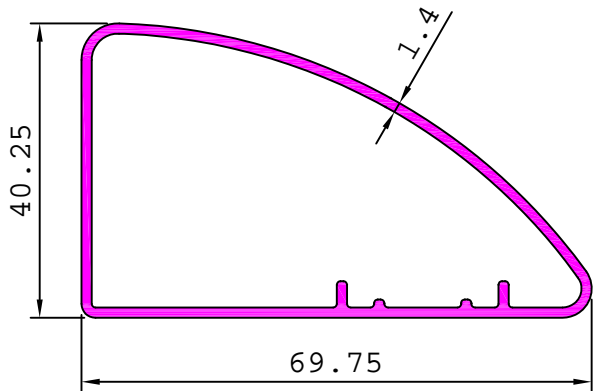

27944

1.341 kg/m

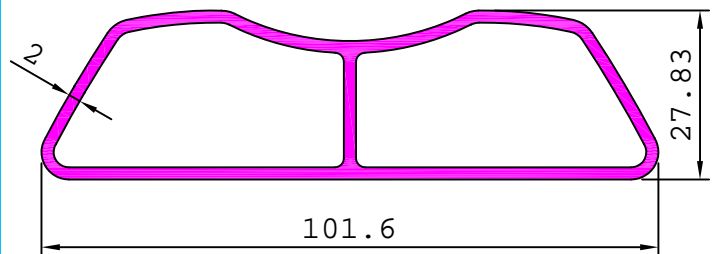

27594

1.337 kg/m

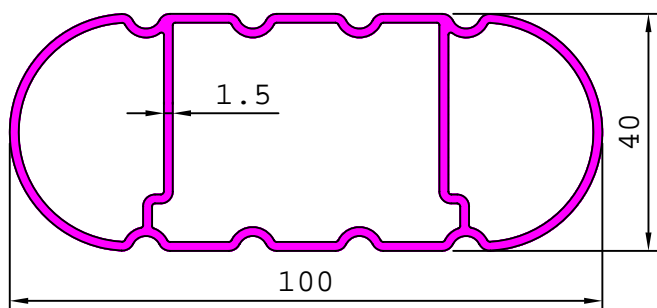

S4759

1.582 kg/m

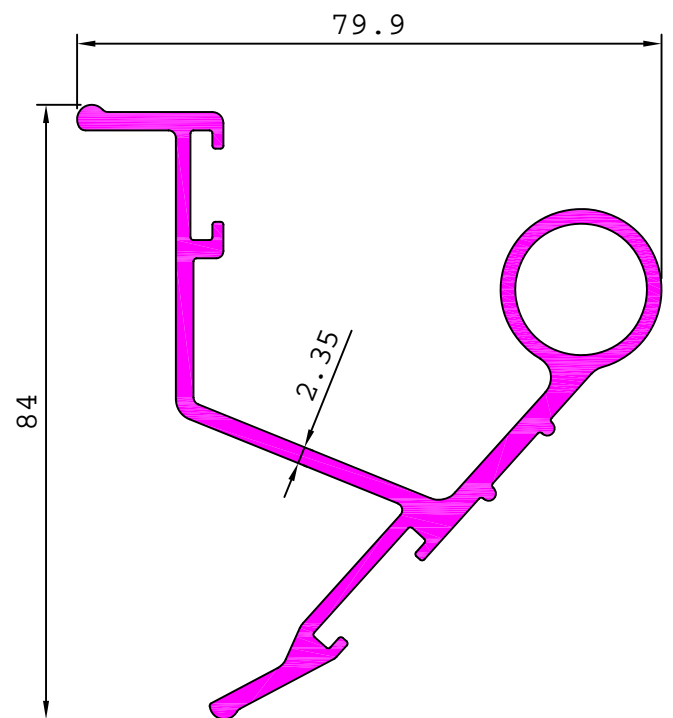

S4560

1.796 kg/m

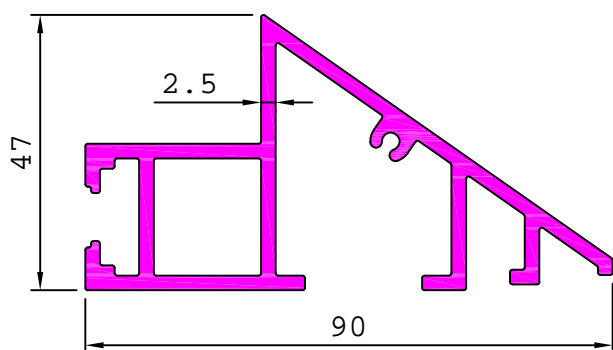

MOULDING & TRANSPORT

MISCELLANEOUS

S4758

0.410 kg/m

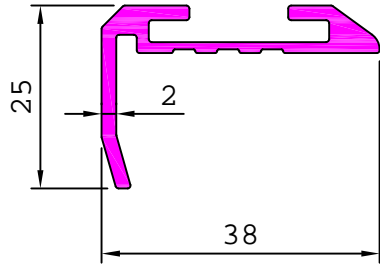

S4805

1.859 kg/m

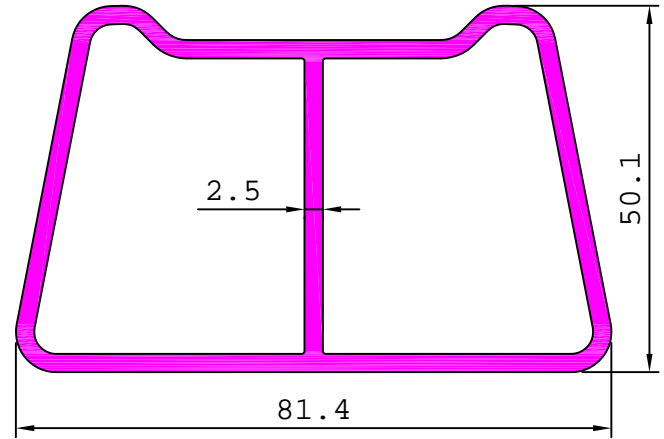

S4847

0.880 kg/m

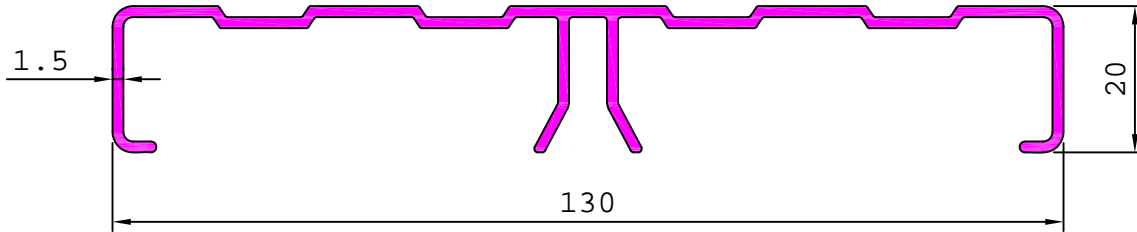

S5072

1.363 kg/m

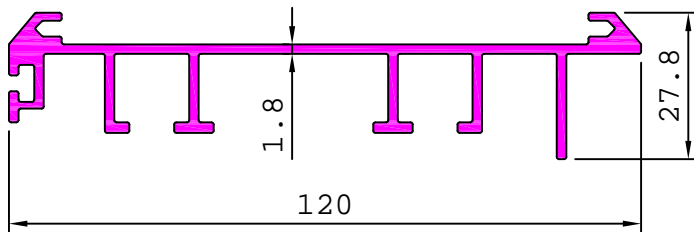

TRANSPORT

RAIL COACH

10120

1.085 kg/m

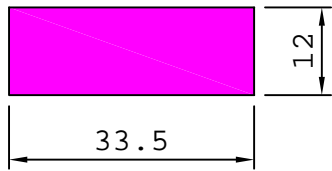

17004

0.718 kg/m

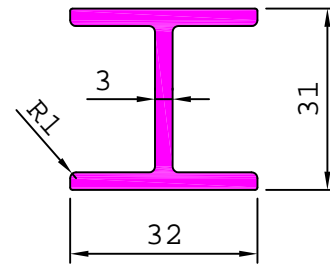

24576

0.823 kg/m

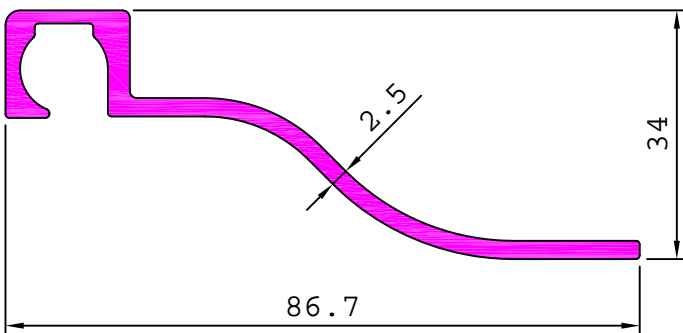

24578

1.031 kg/m

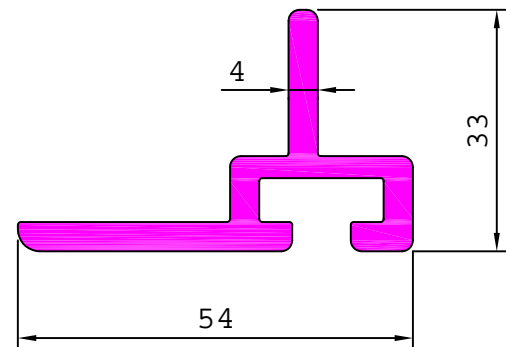

24577

2.626 kg/m

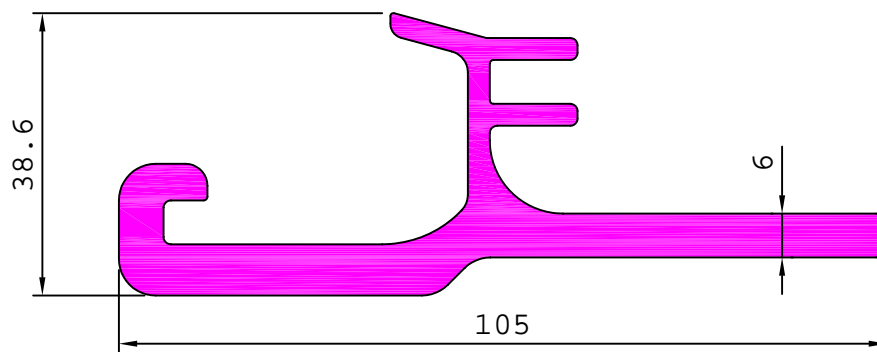

28053

17.452 kg/m

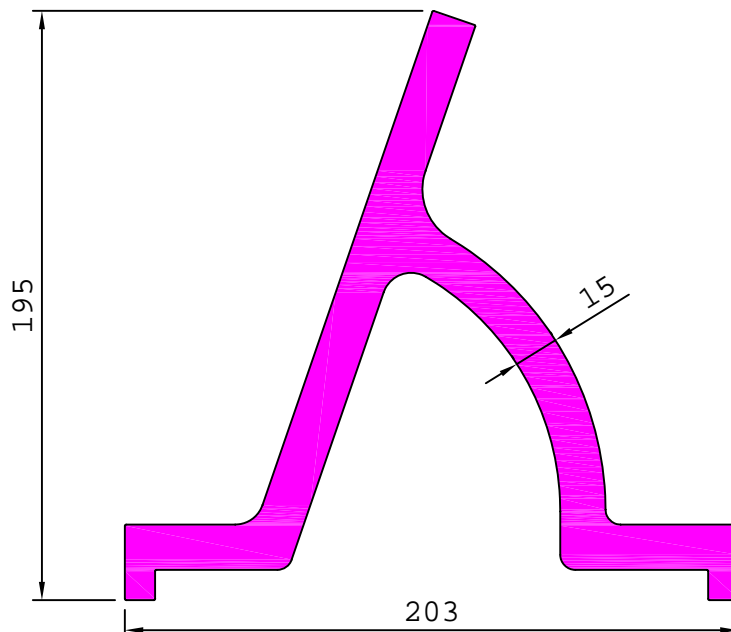

TRANSPORT

RAIL COACH

24579

3.016 kg/m

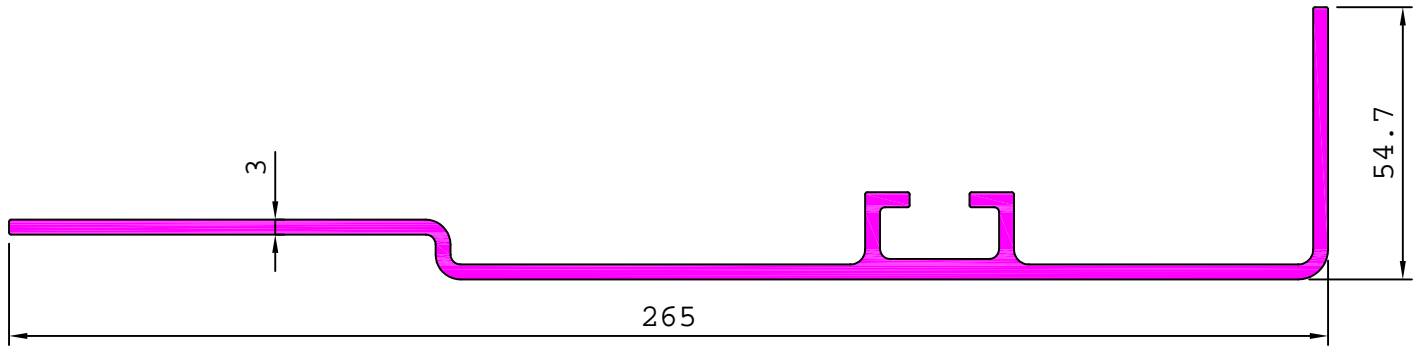

24580

4.938 kg/m

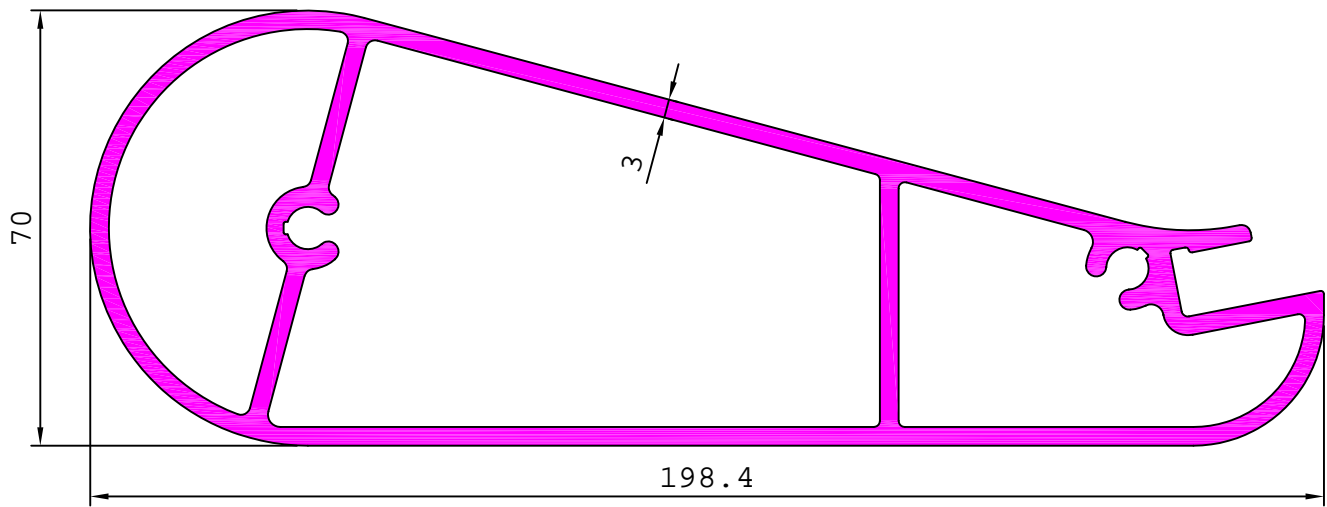

INDUSTRIAL

TELECOMMUNICATIONS

28099

1.412 kg/m

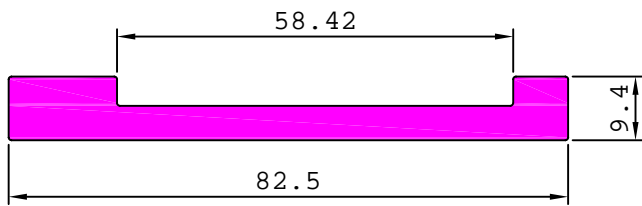

24619

1.271 kg/m

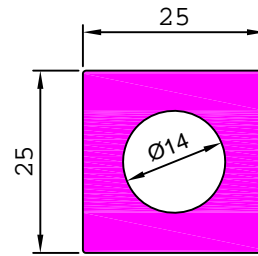

24620

0.353 kg/m

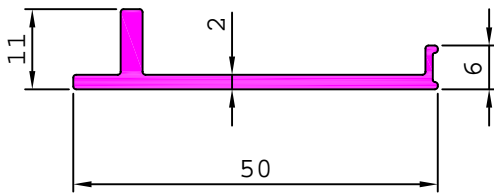

24621

0.218 kg/m

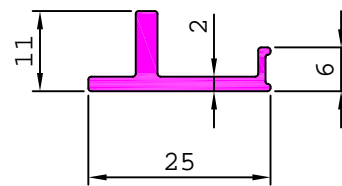

24622

2.606 kg/m

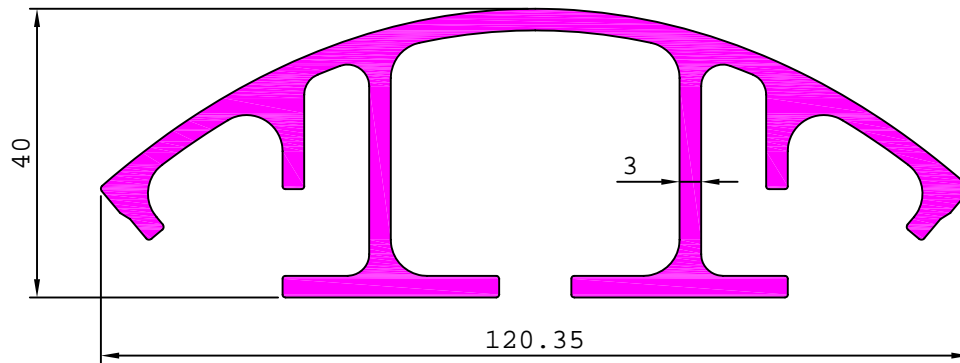

24623

0.221 kg/m

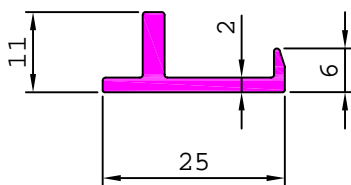

24624

0.356 kg/m

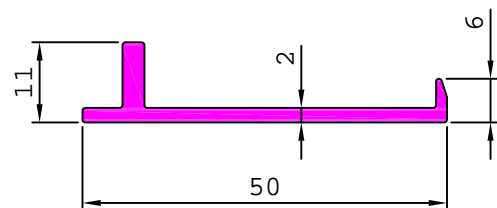

24625

0.367 kg/m

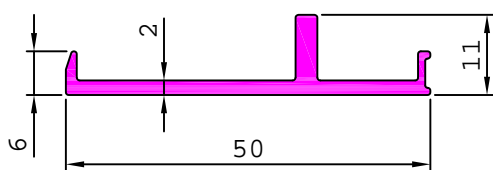

24626

0.868 kg/m

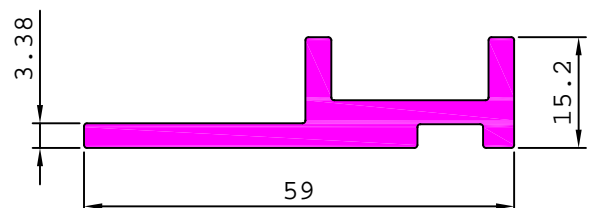

INDUSTRIAL

TELECOMMUNICATIONS

33512

2.493 kg/m

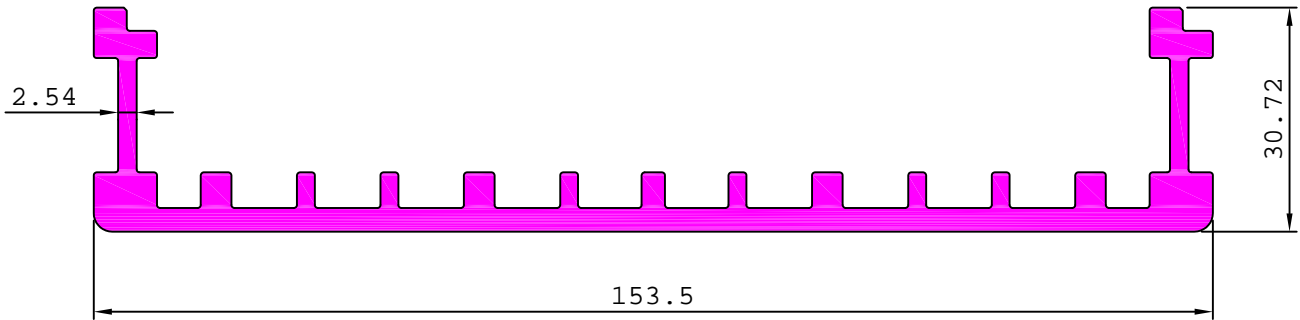

28061

1.129 kg/m

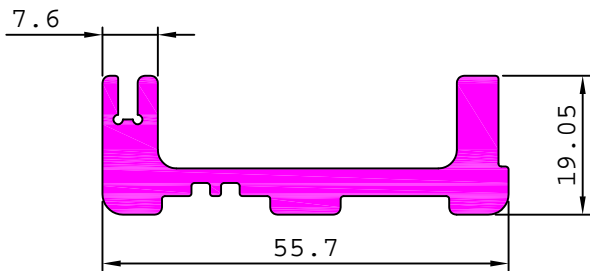

28060

0.533 kg/m

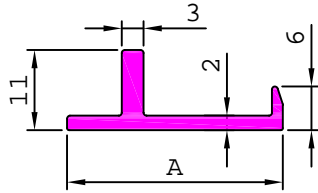
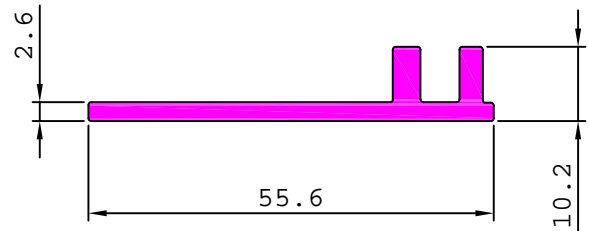

28150

5.124 kg/m

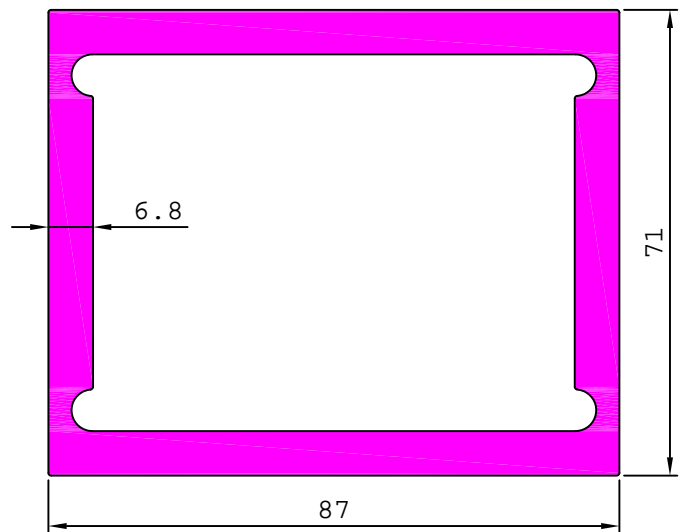

SL. No.	Section No.	A	Weight kg/m
1	27722	29.60	0.246
2	27723	59.80	0.409

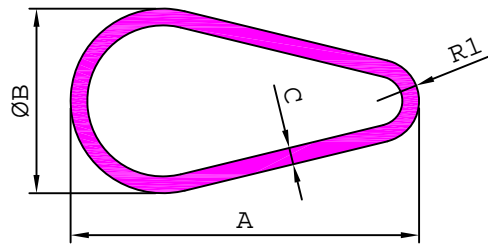
INDUSTRIAL**TEXTILE MACHINERY**

SL. No.	Section No.	A	ØB	C	R1	Weight kg/m
1	24701	38.25	27.94	1.27	8.41	0.343
2	24713	39.40	21.00	1.20	4.45	0.303

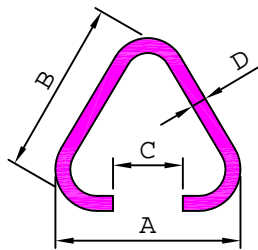

SL. No.	Section No.	A	B	C	D	Weight kg/m
1	24757	21.80	24.30	7.00	0.80	0.133
2	24715	24.80	24.80	8.00	1.10	0.192

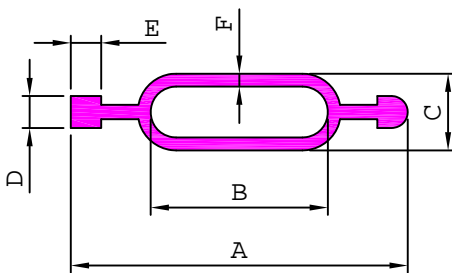

SL. No.	Section No.	A	B	C	D	E	F	Weight kg/m
1	24735	47.00	30.00	7.60	2.50	2.40	0.70	0.180
2	24732	60.00	41.00	8.40	3.50	2.65	0.85	0.287
3	24717	60.00	42.00	10.20	4.00	3.00	1.10	0.376

INDUSTRIAL

TEXTILE MACHINERY

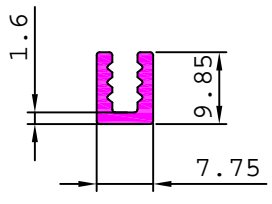
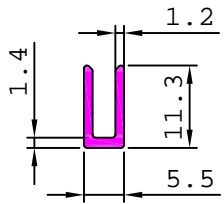
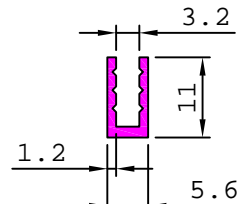
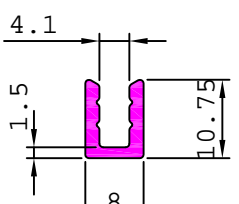
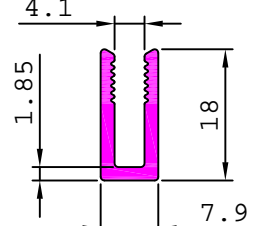
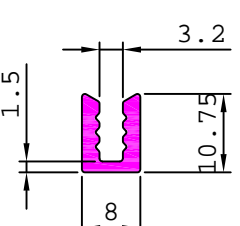
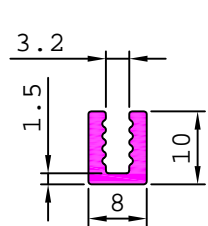
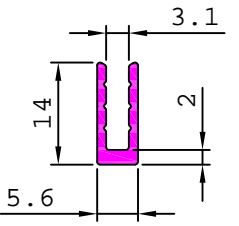
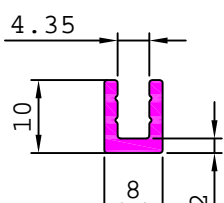
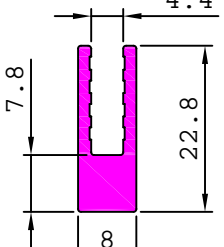
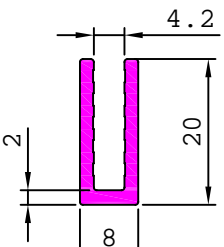
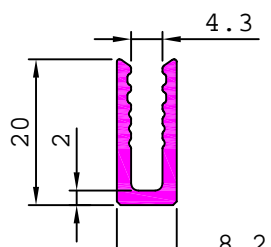
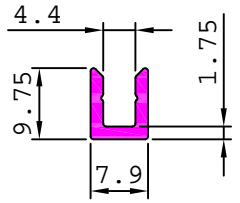
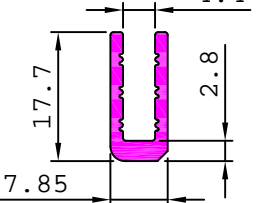
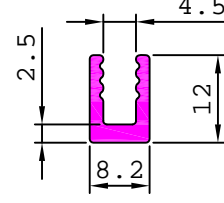
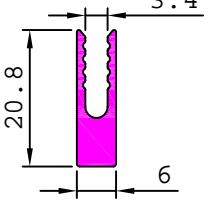
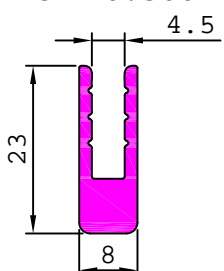
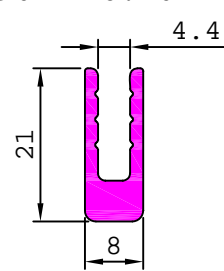
<p>17516 0.121 kg/m</p> 	<p>17525 0.084 kg/m</p> 	<p>17526 0.080 kg/m</p> 	<p>17567 0.124 kg/m</p> 
<p>17568 0.194 kg/m</p> 	<p>17577 0.140 kg/m</p> 	<p>17620 0.133 kg/m</p> 	<p>17623 0.107 kg/m</p> 
<p>17639 0.120 kg/m</p> 	<p>17674 0.306 kg/m</p> 	<p>17687 0.223 kg/m</p> 	<p>24836 0.219 kg/m</p> 
<p>24817 0.108 kg/m</p> 	<p>24818 0.186 kg/m</p> 	<p>24826 0.144 kg/m</p> 	<p>S4422 0.209 kg/m</p> 
<p>S4423 0.300 kg/m</p> 	<p>S4964 0.264 kg/m</p> 		

INDUSTRIAL

TEXTILE MACHINERY

24805

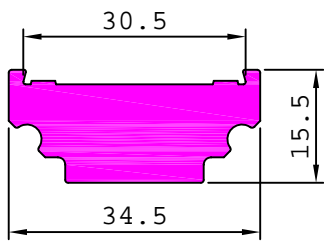

1.043 kg/m

24816

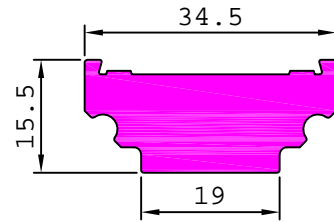

1.042 kg/m

24751

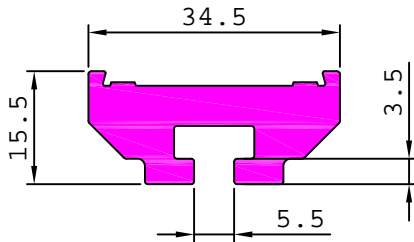

0.891 kg/m

24741

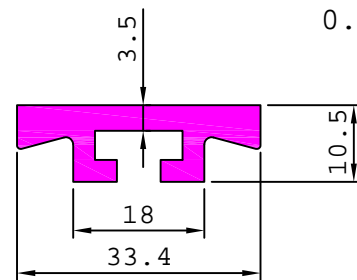

0.547 kg/m

24743

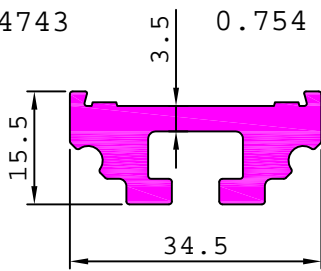

0.754 kg/m

24755

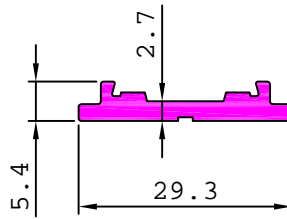

0.255 kg/m

24887

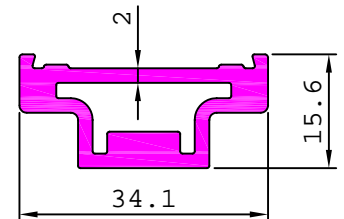

0.608 kg/m

24771

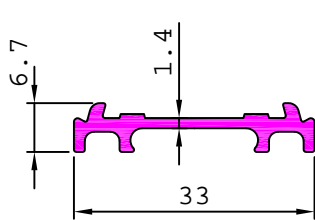

0.226 kg/m

24775

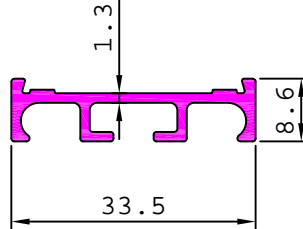

0.259 kg/m

24780

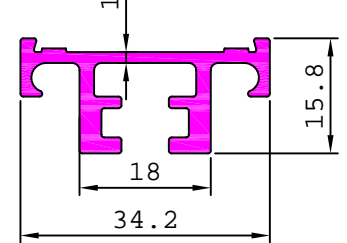

0.453 kg/m

24793

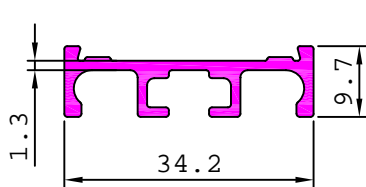

0.303 kg/m

24804

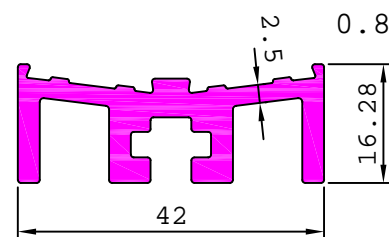

0.807 kg/m

24814

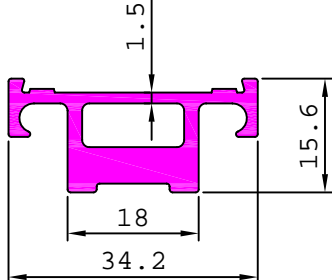

0.556 kg/m

24815

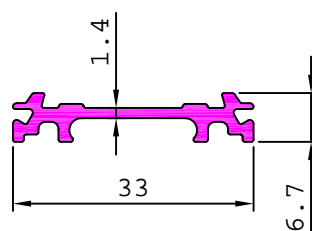

0.231 kg/m

24810

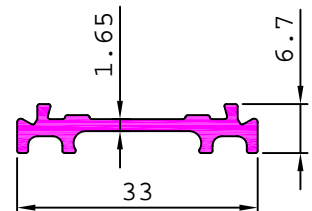

0.245 kg/m

INDUSTRIAL

TEXTILE MACHINERY

24821 0.326 kg/m

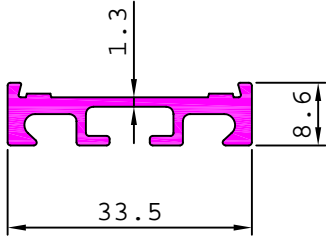

24822 0.394 kg/m

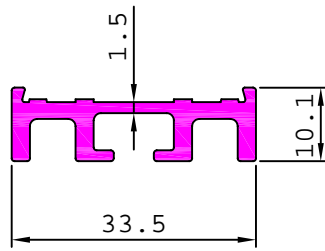

24827 0.379 kg/m

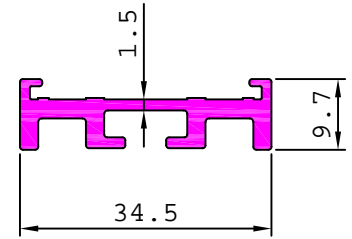

24813 0.825 kg/m

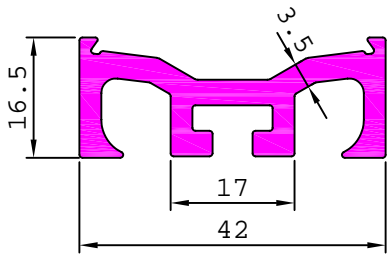

24882 0.380 kg/m

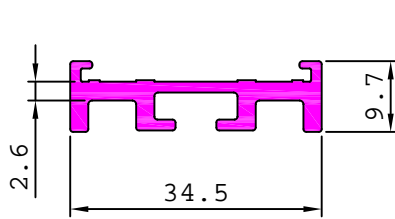

24863 0.502 kg/m

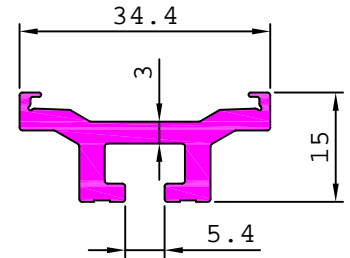

24854 0.426 kg/m

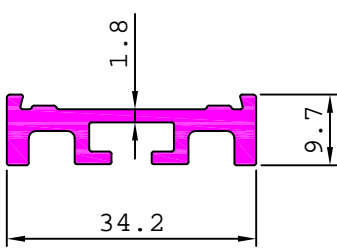

24877 0.613 kg/m

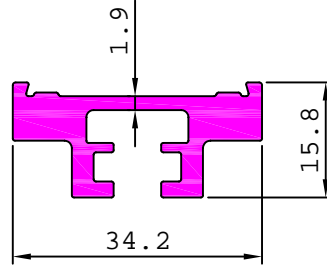

24853 0.610 kg/m

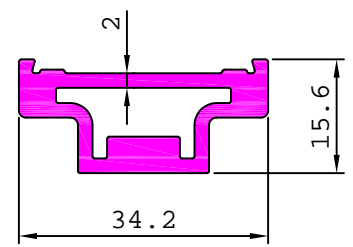

24868 0.252 kg/m

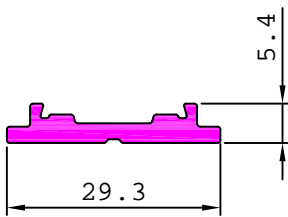

24837 0.152 kg/m

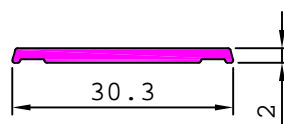

24838 0.119 kg/m

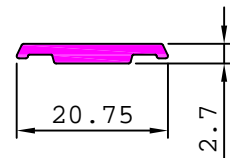

24839 0.124 kg/m

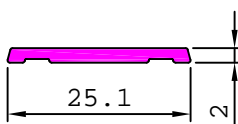

24842 0.085 kg/m

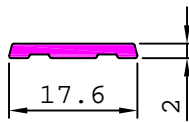

24847 0.250 kg/m

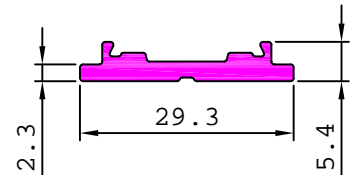

24855 0.713 kg/m

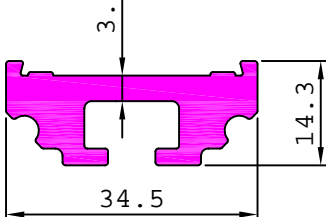

24856 0.848 kg/m

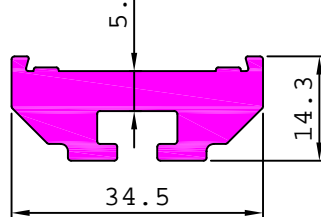

24883 0.991 kg/m

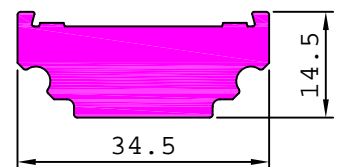

INDUSTRIAL

TEXTILE MACHINERY

S4561 0.151 kg/m

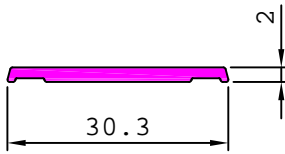

S4567 0.370 kg/m

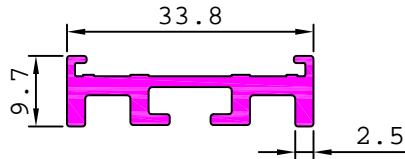

S4623 0.435 kg/m

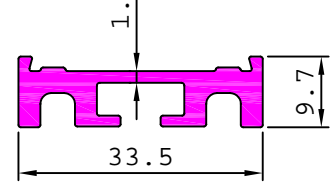

S4702 0.600 kg/m

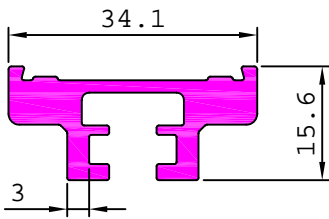

S4703 0.450 kg/m

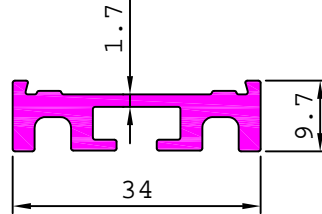

S4954 0.436 kg/m

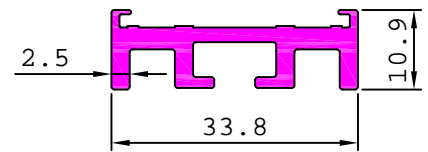

S5073 0.598 kg/m

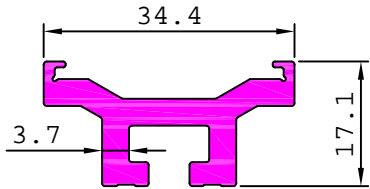

S5074 0.587 kg/m

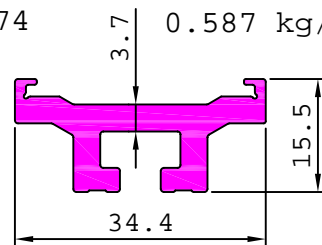

INDUSTRIAL

TEXTILE MACHINERY

24832 3.799 kg/m

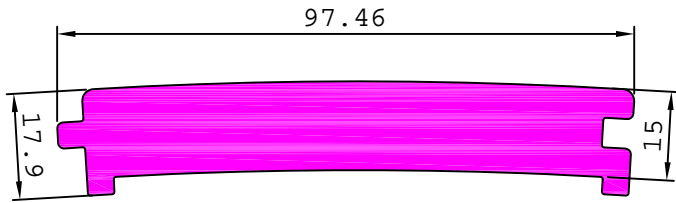

24850 3.242 kg/m

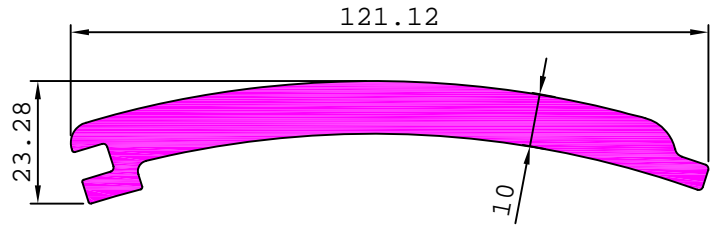

24858 1.847 kg/m

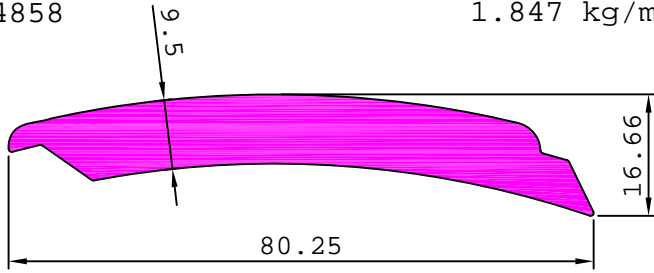

24859 1.908 kg/m

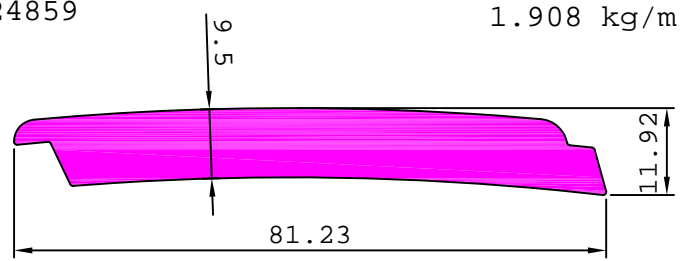

24857 2.354 kg/m

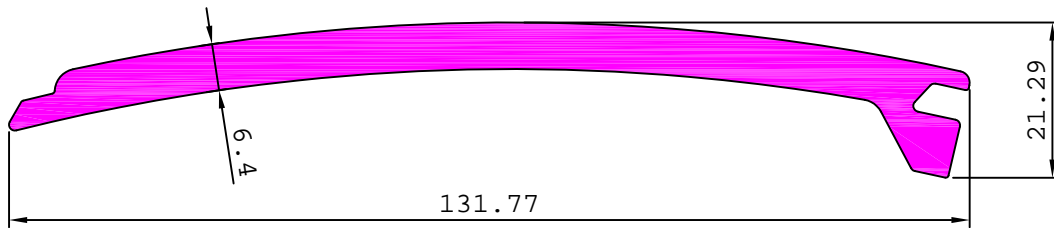

24866 0.933 kg/m

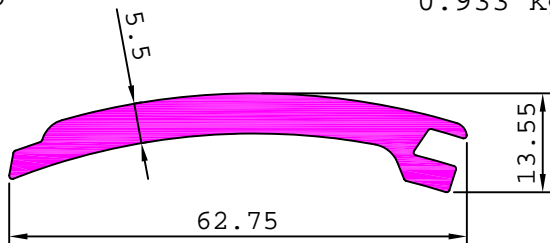

24865 2.448 kg/m

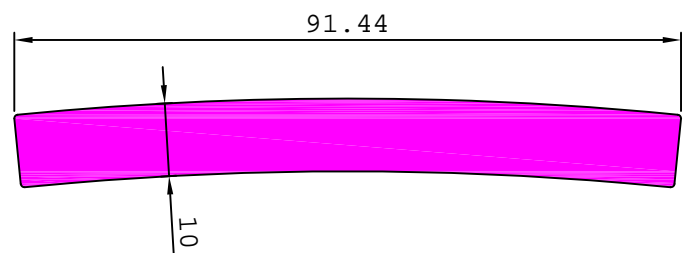

24852 2.248 kg/m

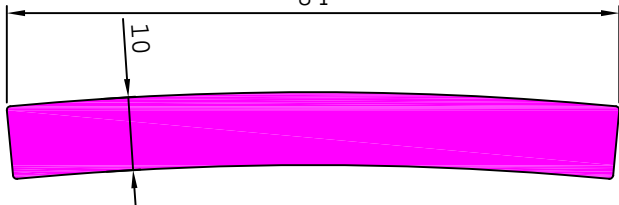

24869 1.390 kg/m

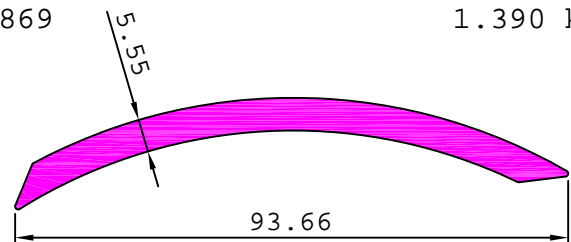

24871 1.764 kg/m

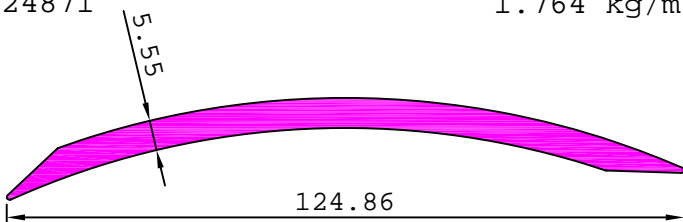

24872 1.769 kg/m

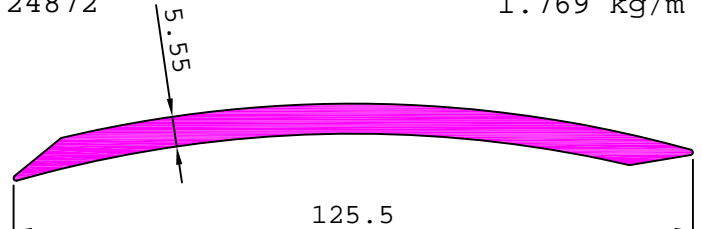

INDUSTRIAL

TEXTILE MACHINERY

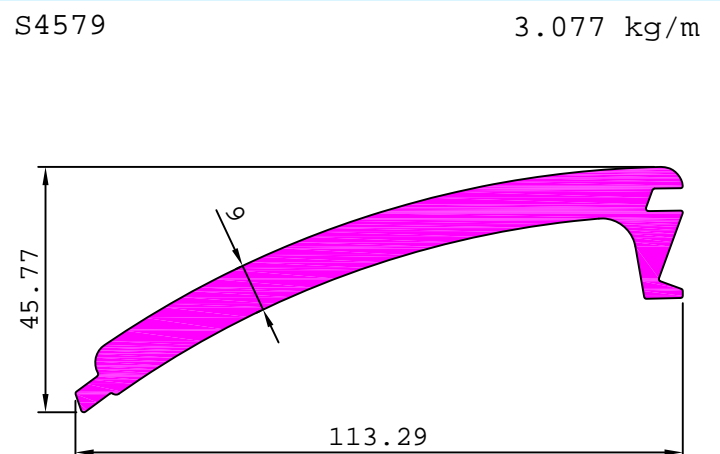
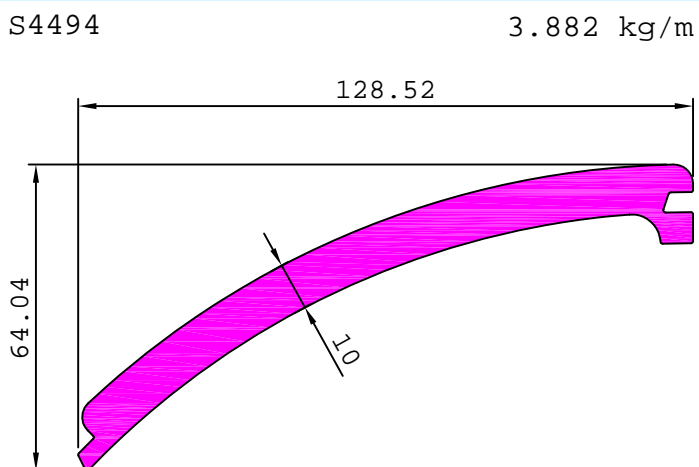
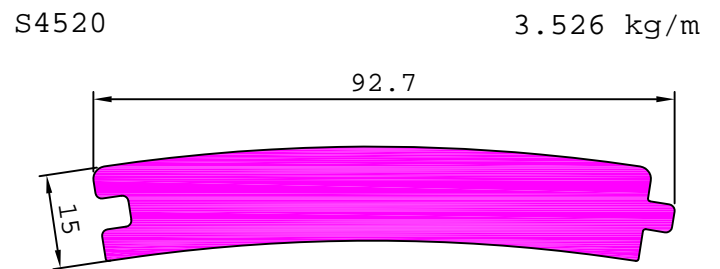
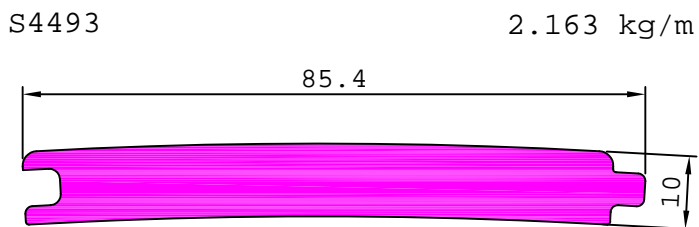
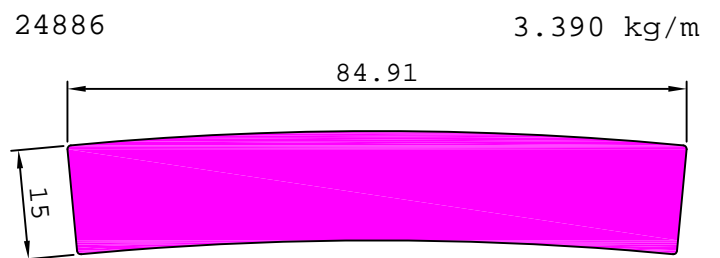
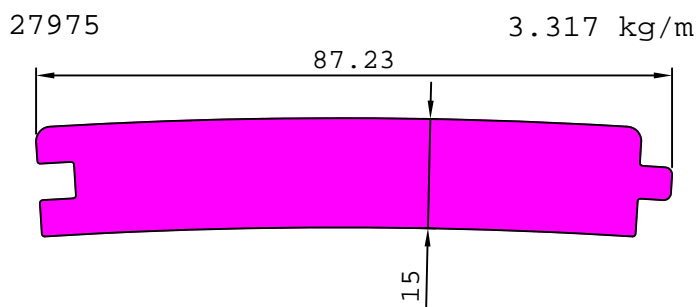
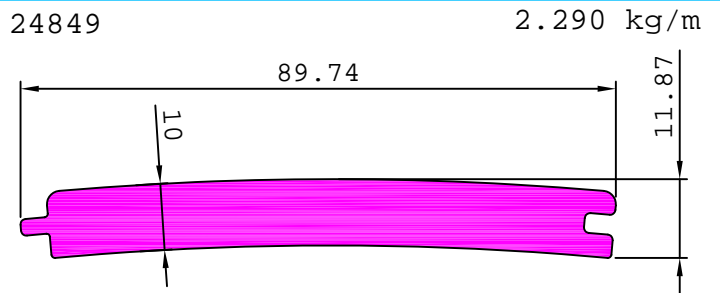
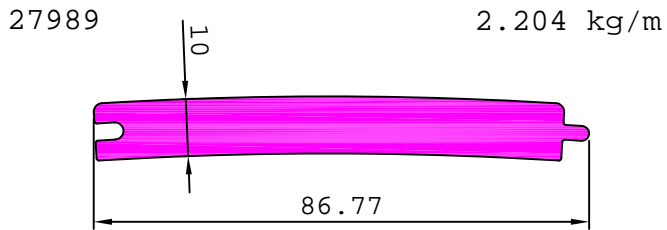
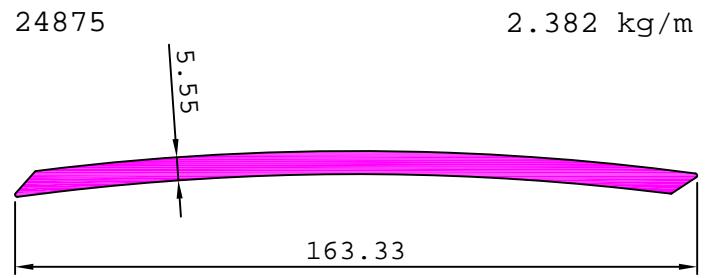
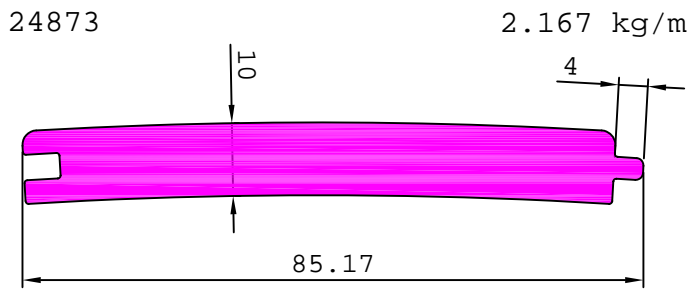

INDUSTRIAL

TEXTILE MACHINERY

S4784

2.207 kg/m

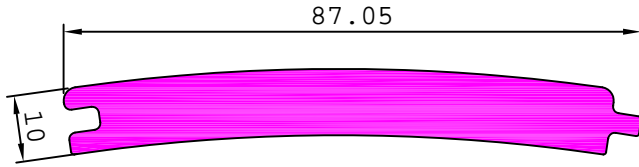

S4938

5.893 kg/m

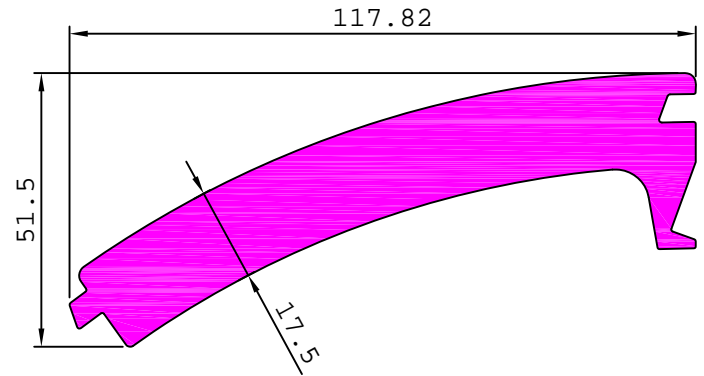

S4274

3.471 kg/m

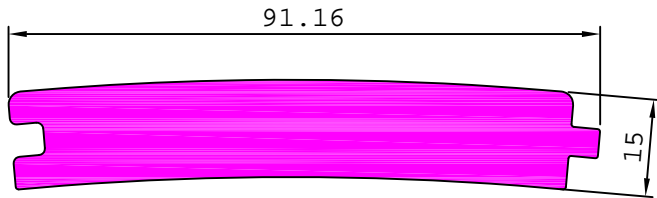

S4346

3.519 kg/m

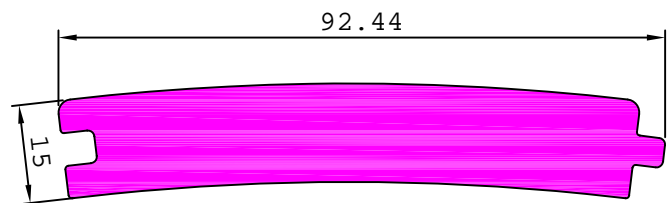

28109

2.314 kg/m

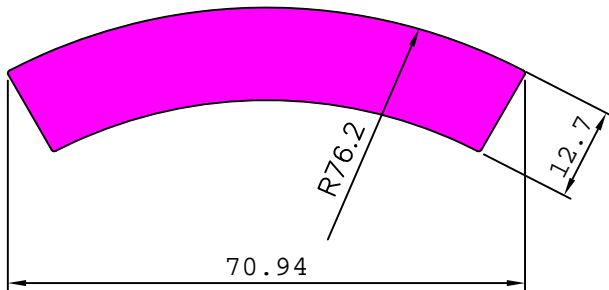

INDUSTRIAL

TEXTILE MACHINERY

24825 1.279 kg/m

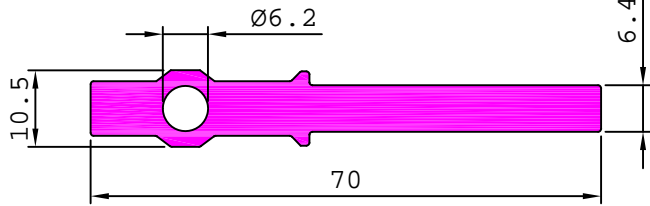

24806 1.594 kg/m

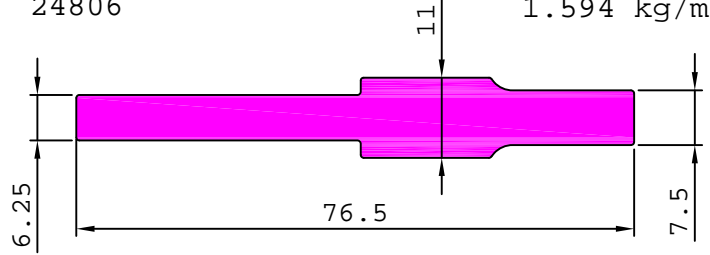

24811 1.786 kg/m

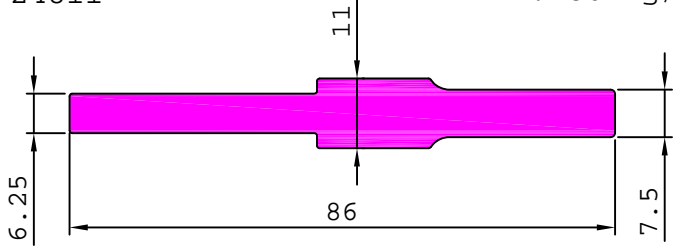

24840 1.172 kg/m

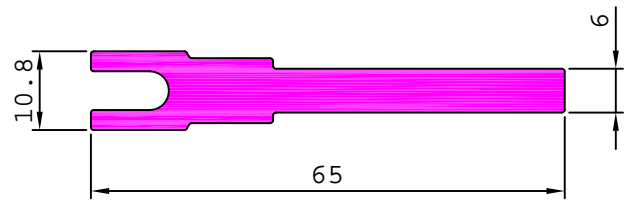

24841 1.427 kg/m

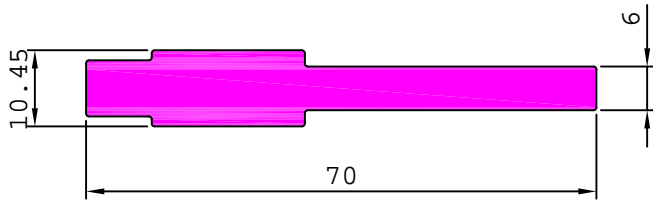

24846 1.129 kg/m

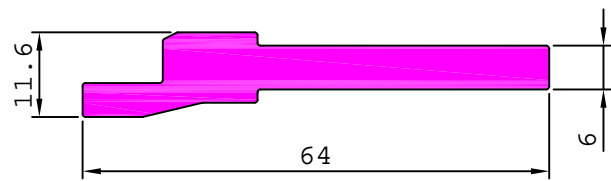

24876 1.046 kg/m

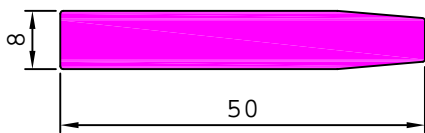

24861 0.897 kg/m

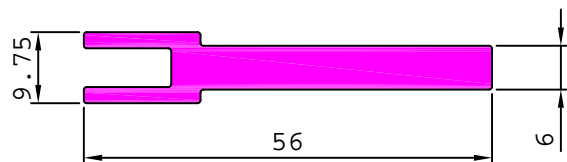

24862 0.939 kg/m

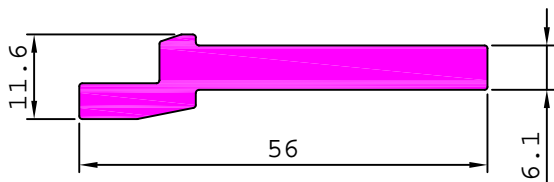

24880 1.626 kg/m

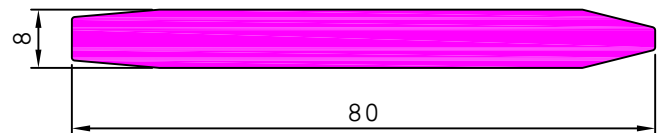

S4747 0.978 kg/m

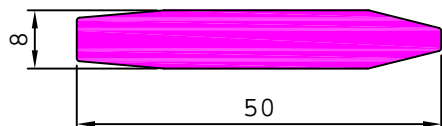

S4783 1.009 kg/m

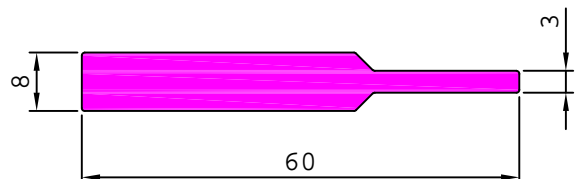

INDUSTRIAL

TEXTILE MACHINERY

24796

1.015 kg/m

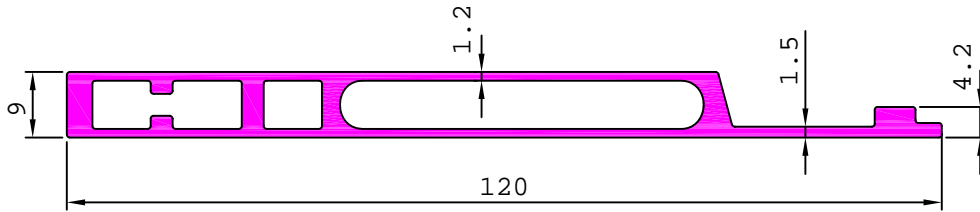

24797

0.981 kg/m

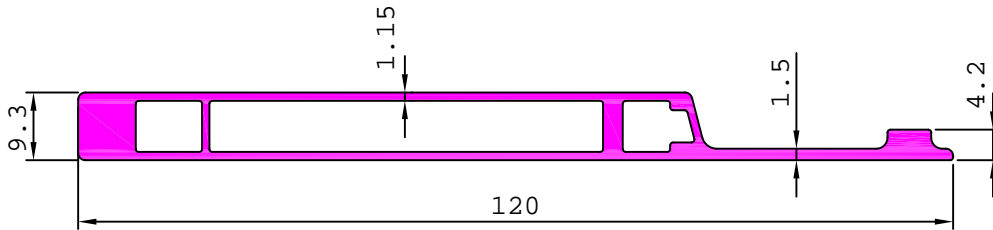

24802

0.908 kg/m

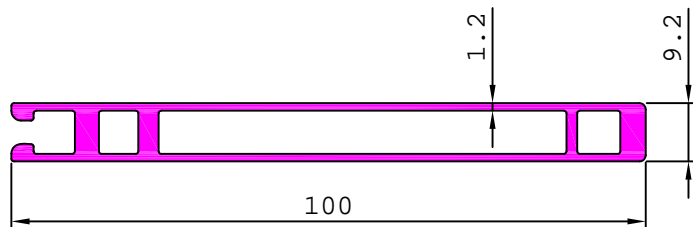

24848

0.855 kg/m

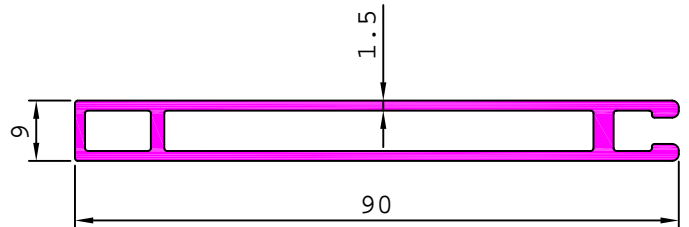

24807

1.217 kg/m

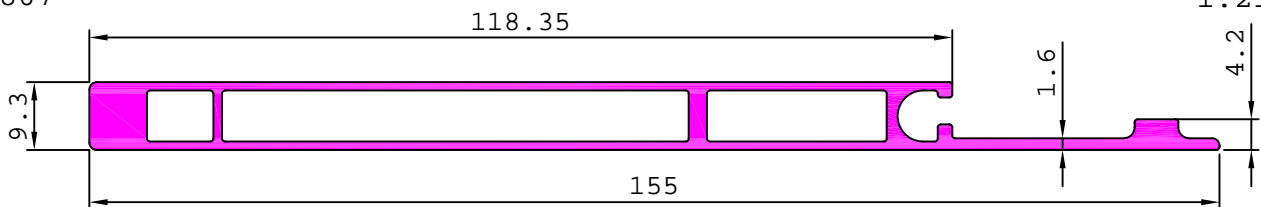

24808

1.017 kg/m

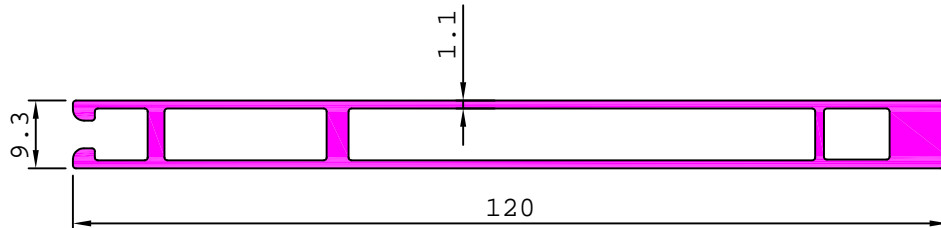

24812

1.038 kg/m

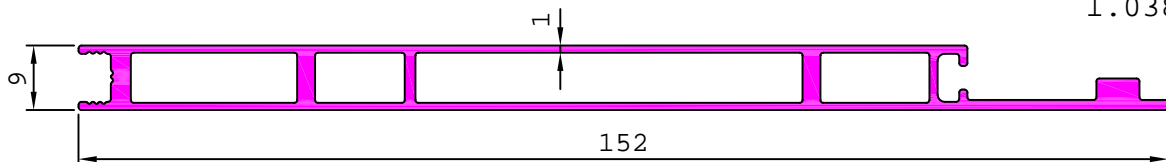

24819

1.252 kg/m

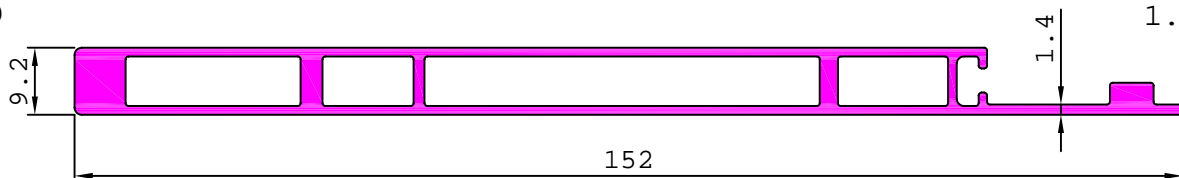

INDUSTRIAL

TEXTILE MACHINERY

24851

1.190 kg/m

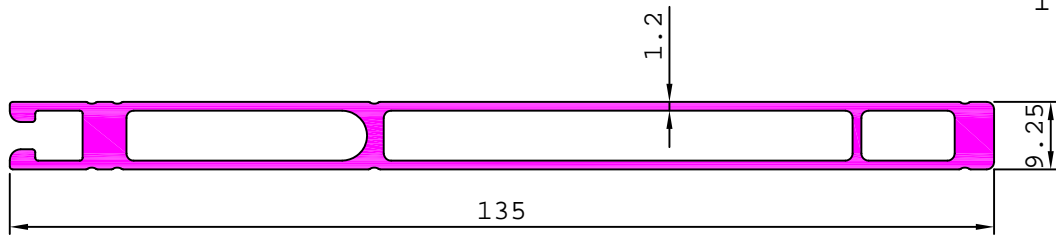

24831

0.838 kg/m

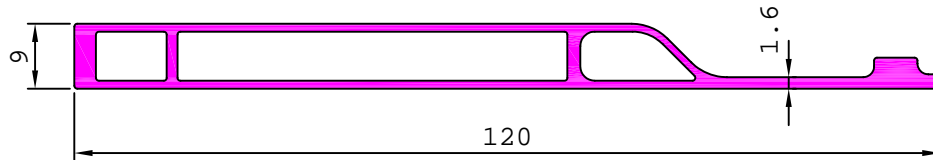

24878

0.949 kg/m

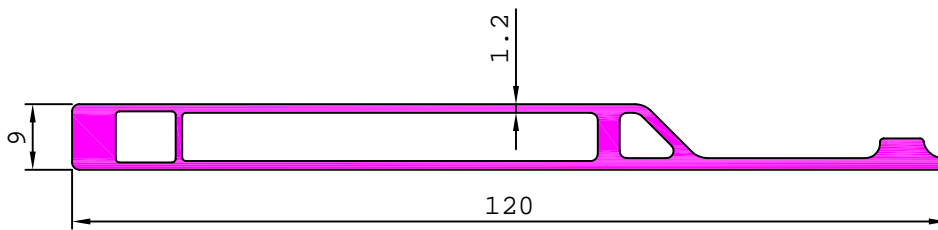

27622

0.946 kg/m

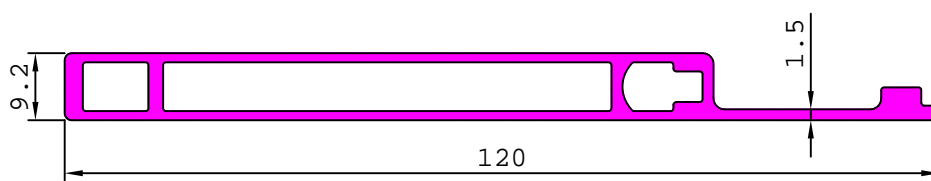

27359

0.830 kg/m

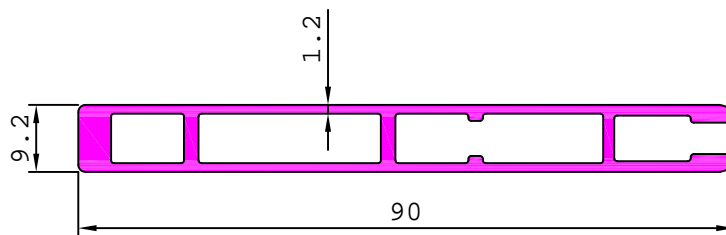

27665

0.780 kg/m

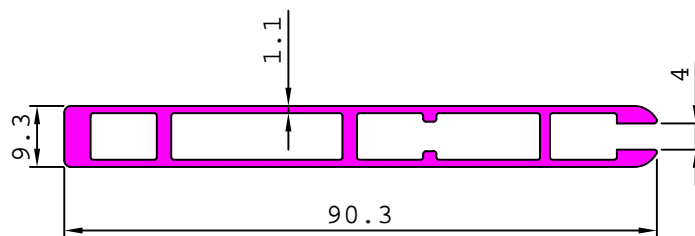

24864

1.067 kg/m

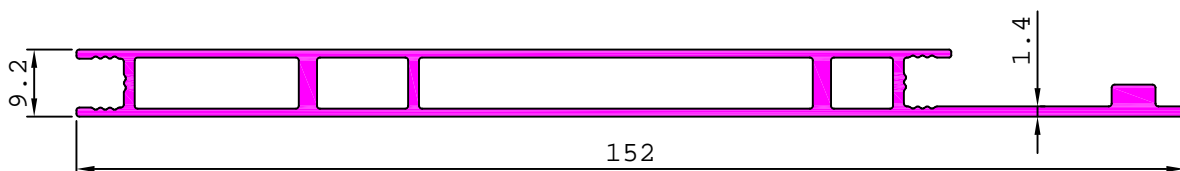

INDUSTRIAL

TEXTILE MACHINERY

S4400

0.862 kg/m

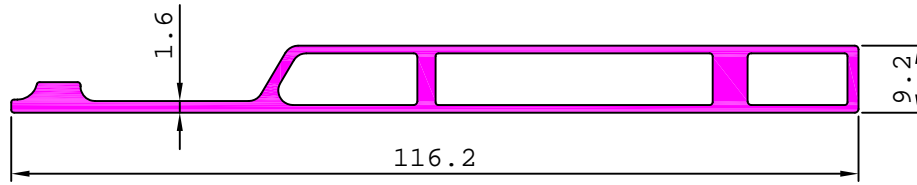

S4480

0.811 kg/m

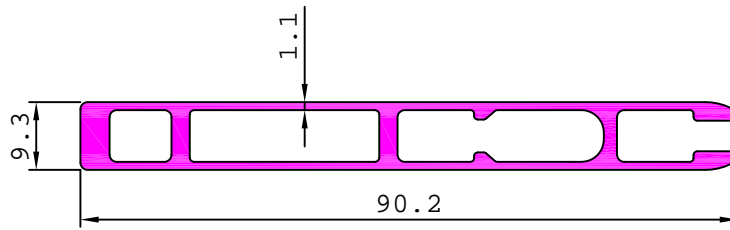

INDUSTRIAL

TEXTILE MACHINERY

24776

10.430 kg/m

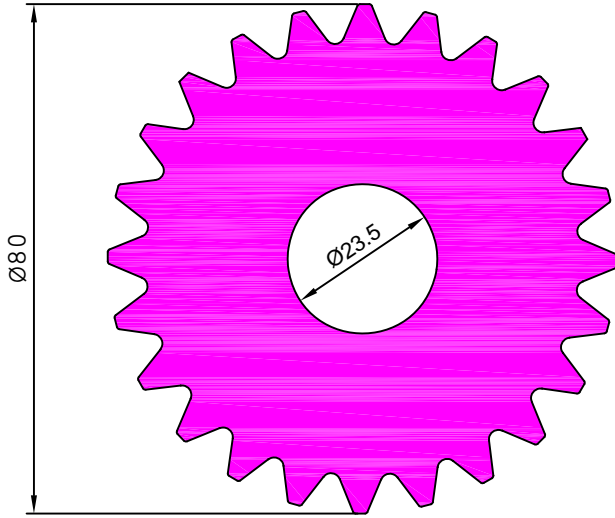

24768

11.712 kg/m

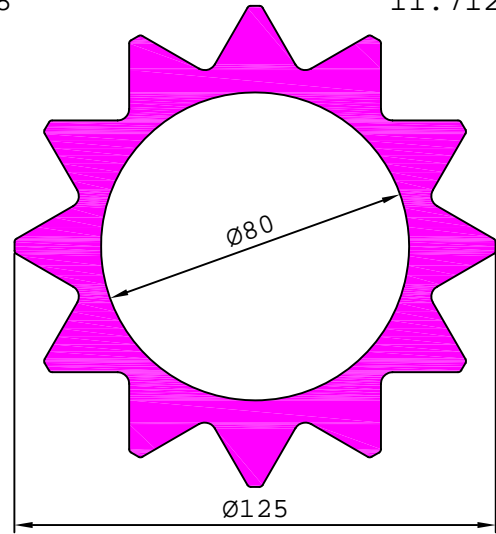

24824

6.306 kg/m

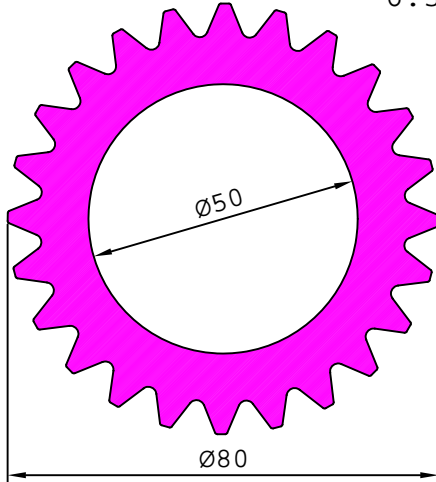

24762

1.479 kg/m

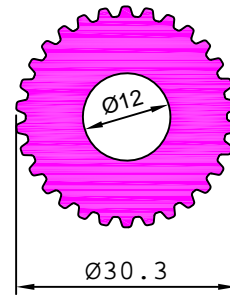

24763

8.057 kg/m

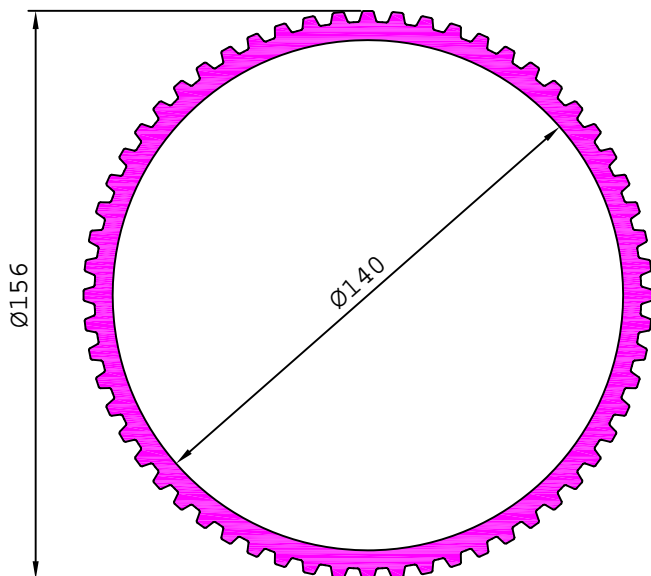

24764

7.803 kg/m

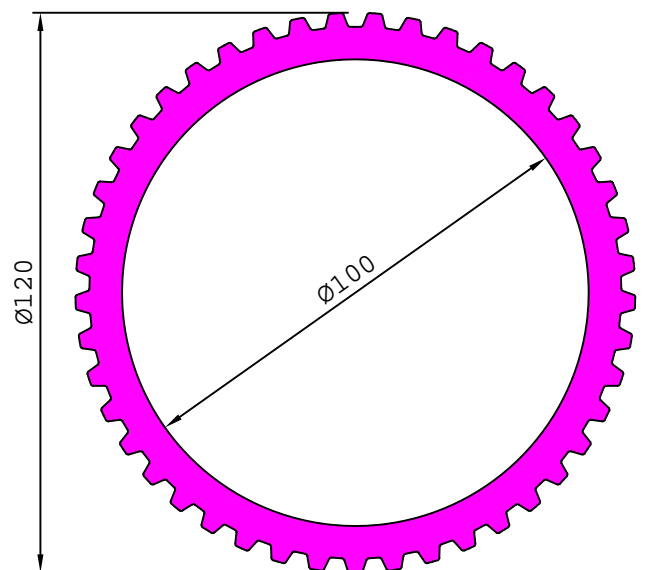

INDUSTRIAL

TEXTILE MACHINERY

24874

11.527 kg/m

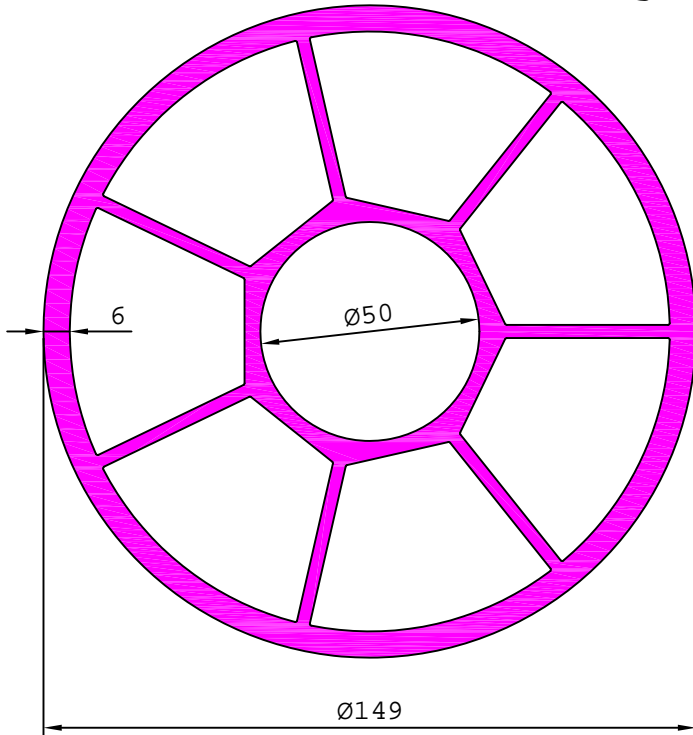

24885

3.728 kg/m

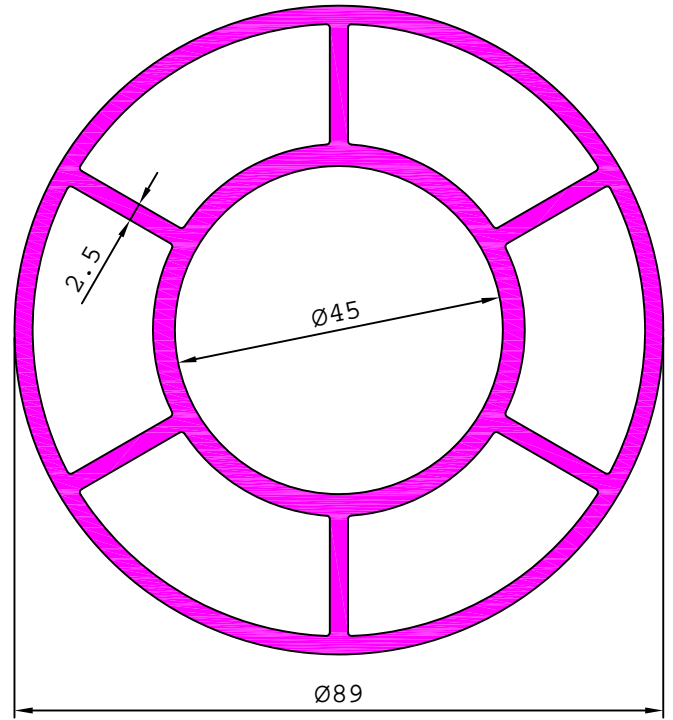

S4981

12.709 kg/m

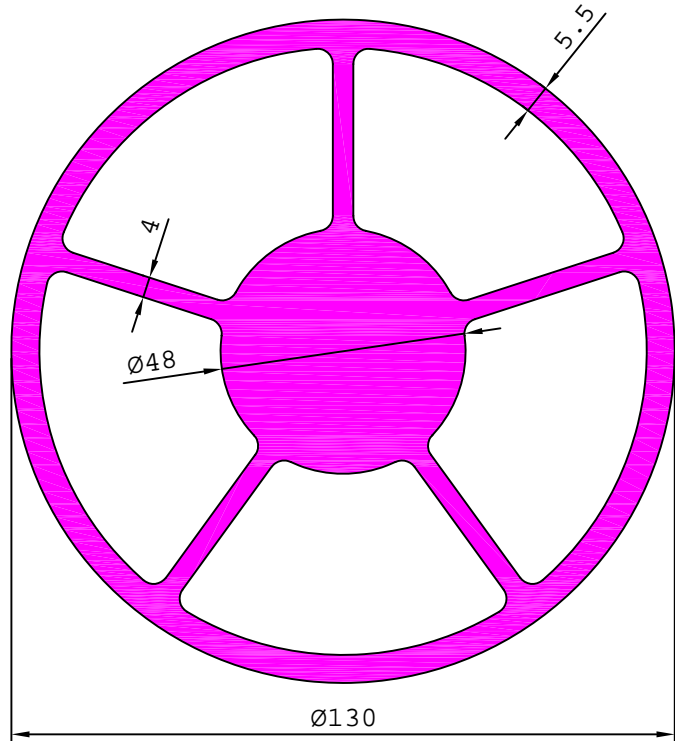

S4982

5.675 kg/m

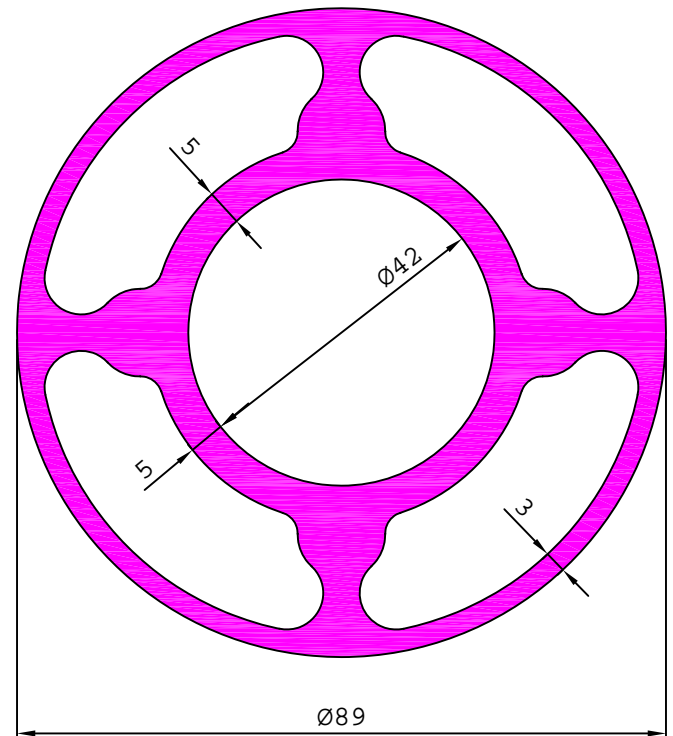

S4838

0.290 kg/m

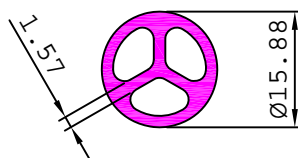

INDUSTRIAL

TEXTILE MACHINERY

S4762

9.575 kg/m

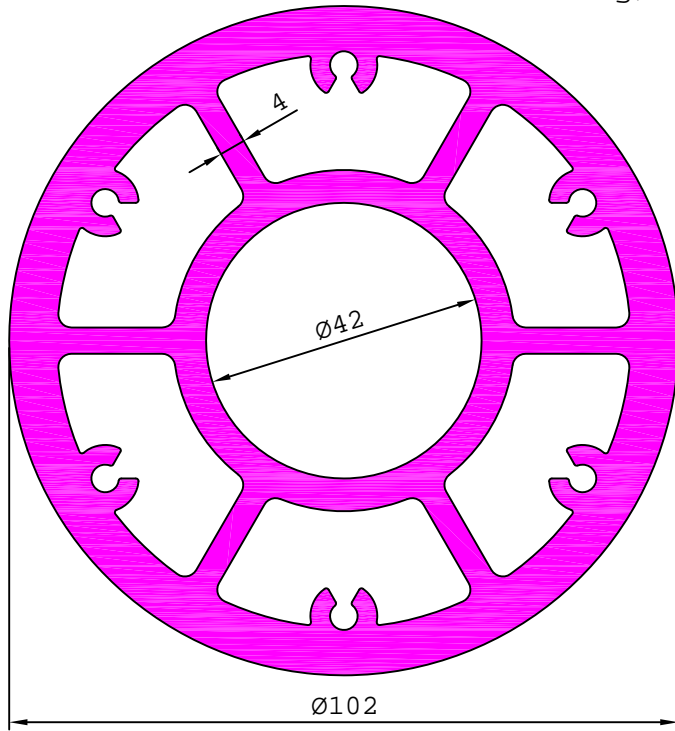

INDUSTRIAL

TEXTILE MACHINERY

24820

2.692 kg/m

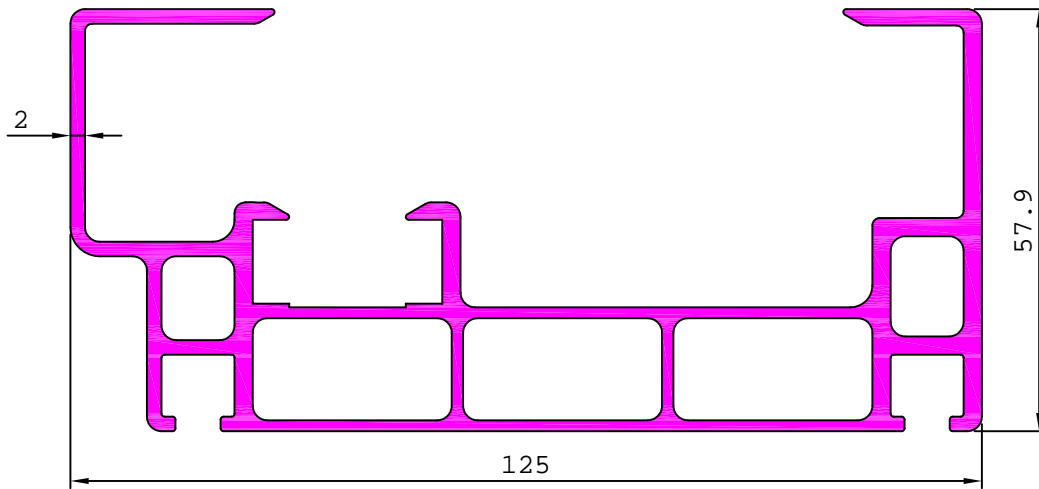

24829

2.691 kg/m

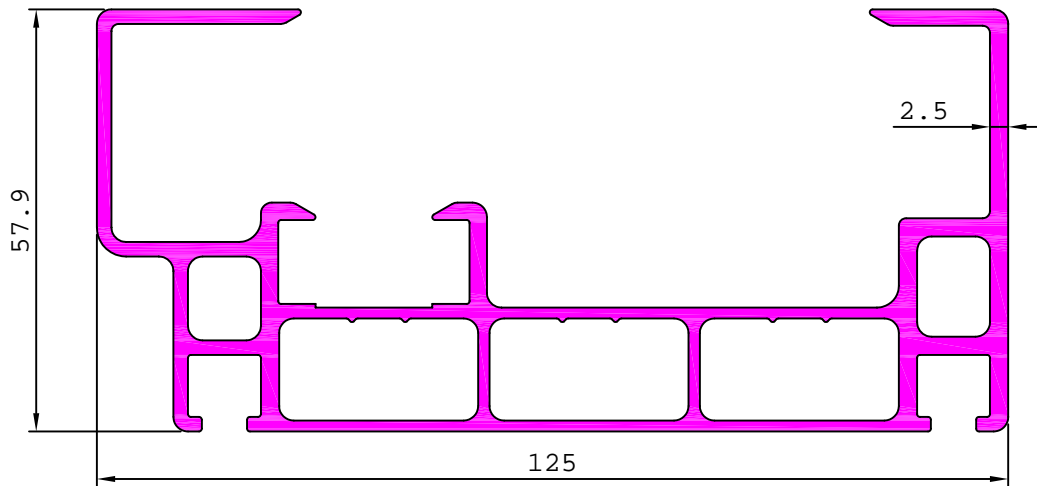

24798

2.722 kg/m

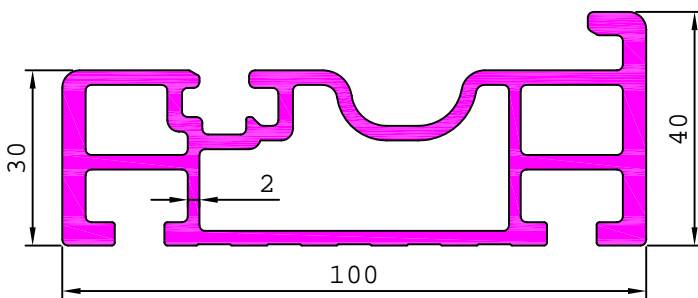

24835

3.063 kg/m

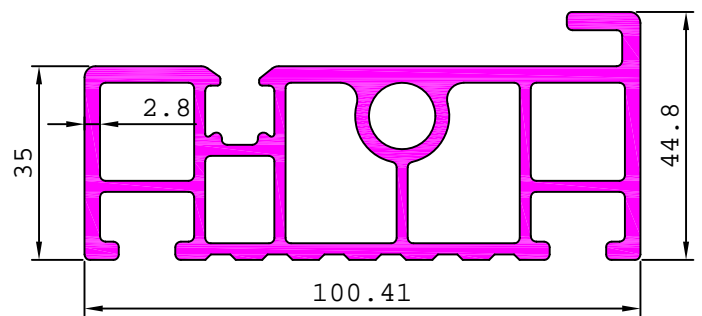

24809

2.332 kg/m

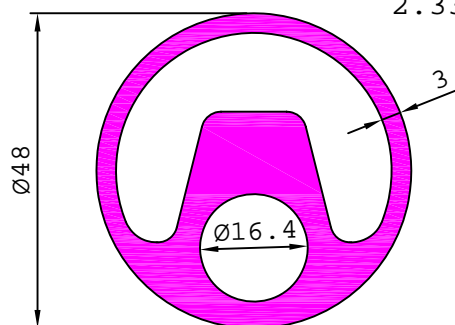

24834

0.822 kg/m

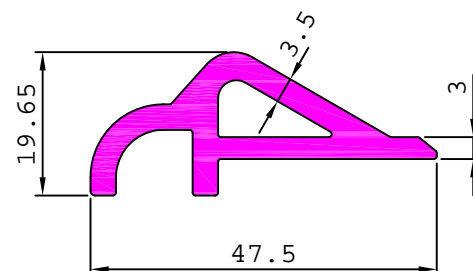

INDUSTRIAL

TEXTILE MACHINERY

24791 4.106 kg/m

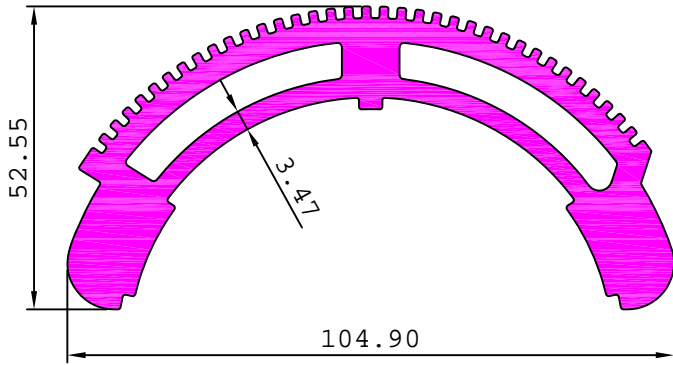

24795 3.695 kg/m

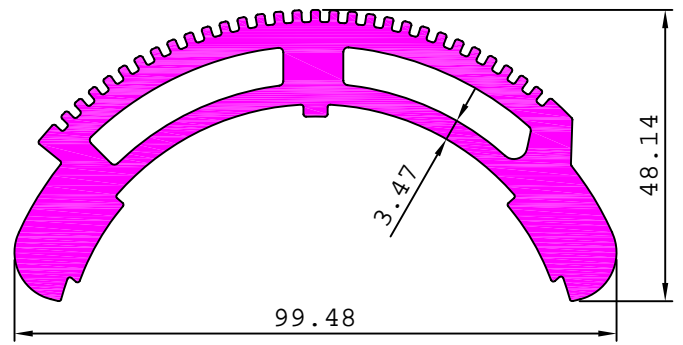

24731 2.223 kg/m

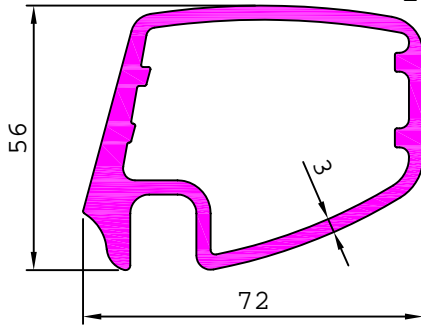

24879 1.200 kg/m

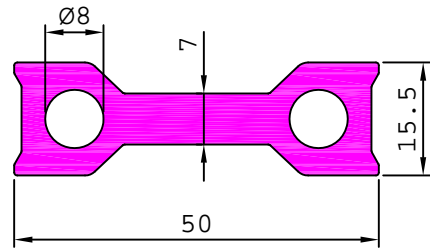

S4947 1.221 kg/m

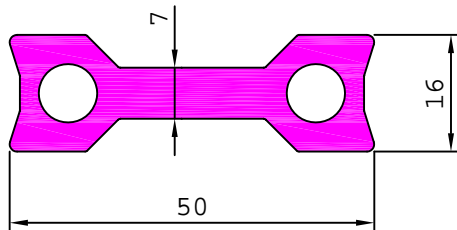

INDUSTRIAL

TEXTILE MACHINERY

24788

1.907 kg/m

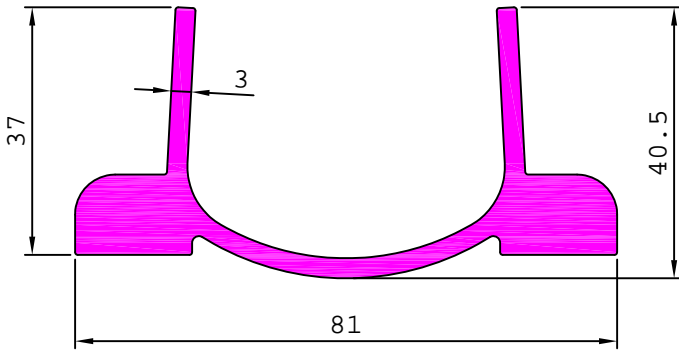

24833

2.099 kg/m

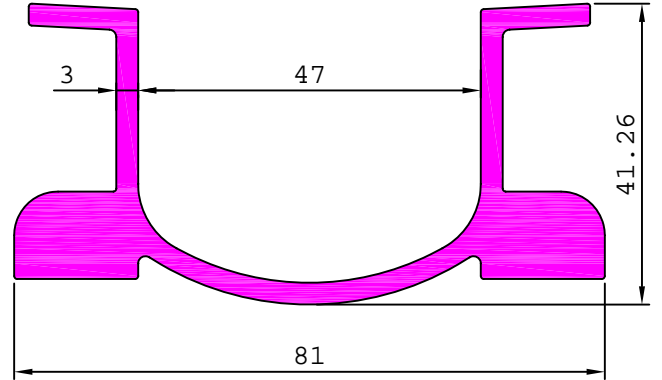

24845

3.574 kg/m

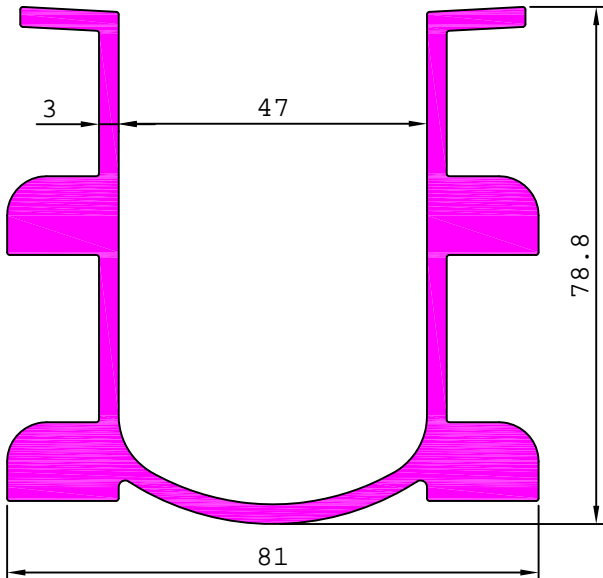

INDUSTRIAL

TEXTILE MACHINERY

24860 0.206 kg/m

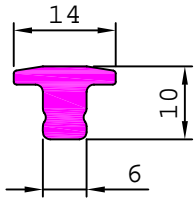

24734 0.534 kg/m

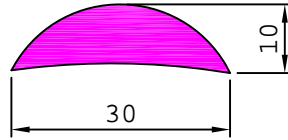

24736 0.772 kg/m

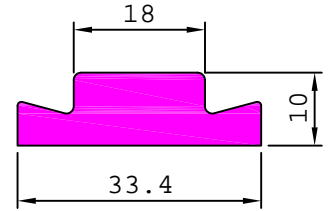

24739 1.224 kg/m

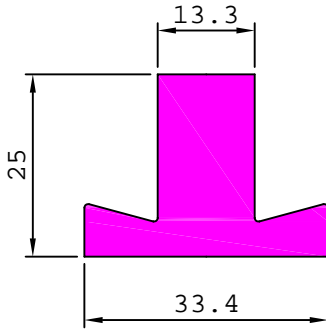

24746 0.724 kg/m

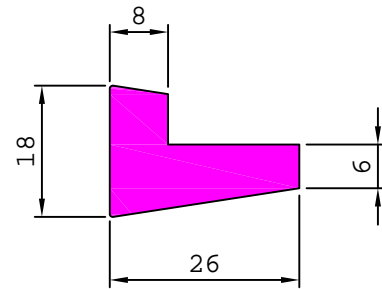

24759 0.609 kg/m

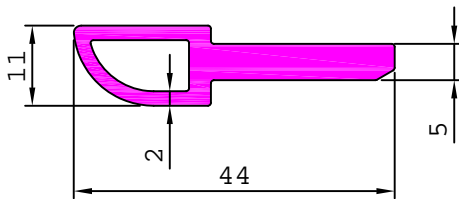

24790 0.538 kg/m

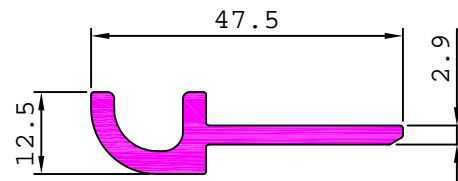

24830 0.431 kg/m

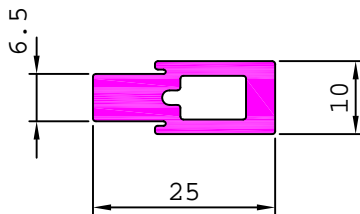

24786 1.357 kg/m

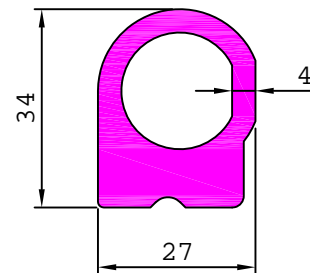

24745 1.986 kg/m

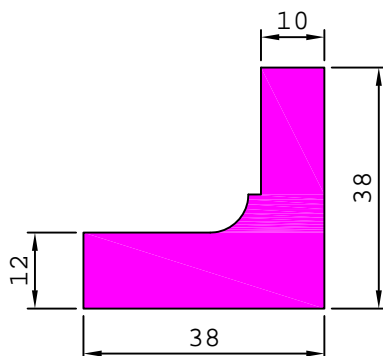

24777 2.800 kg/m

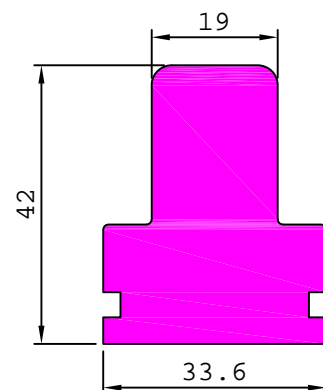

INDUSTRIAL

TEXTILE MACHINERY

24781

2.132 kg/m

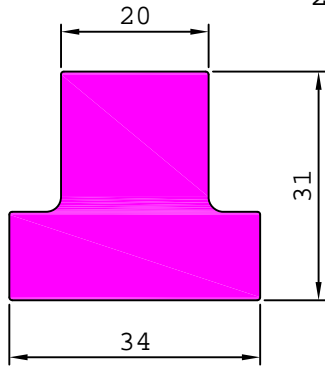

24737

2.434 kg/m

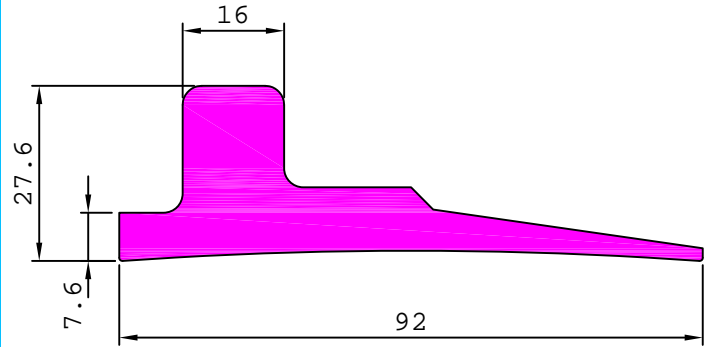

24740

5.797 kg/m

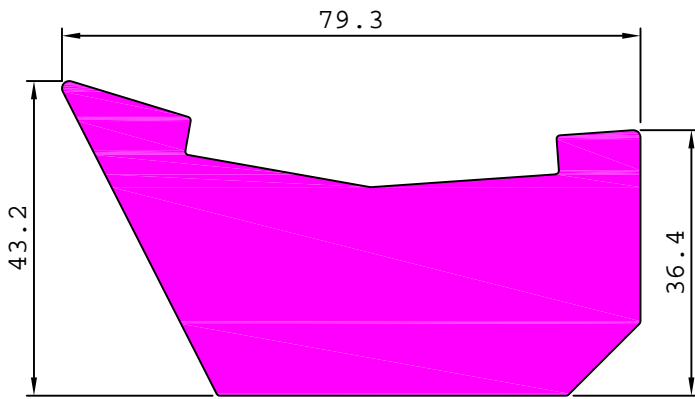

24769

12.824 kg/m

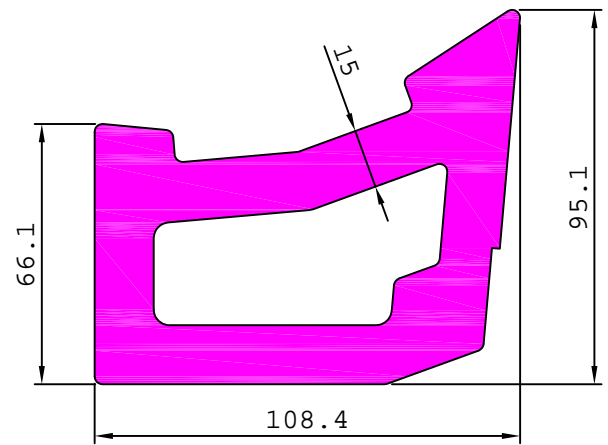

24770

9.505 kg/m

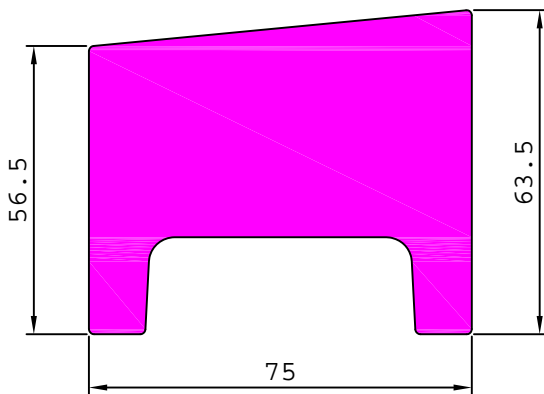

24799

5.042 kg/m

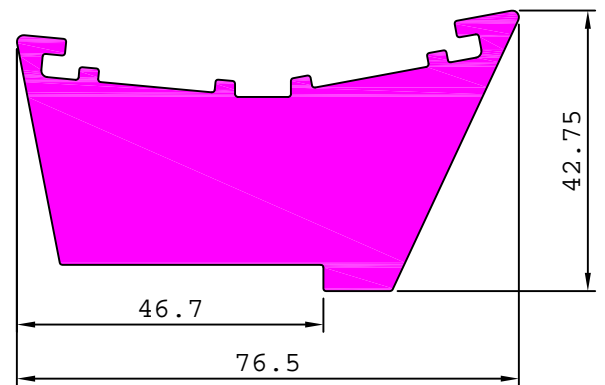

24774

5.946 kg/m

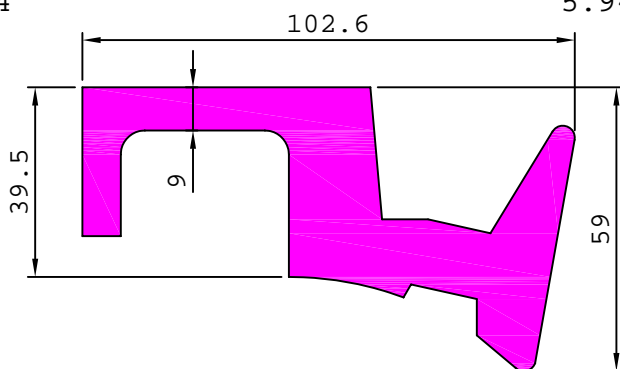

24787

2.143 kg/m

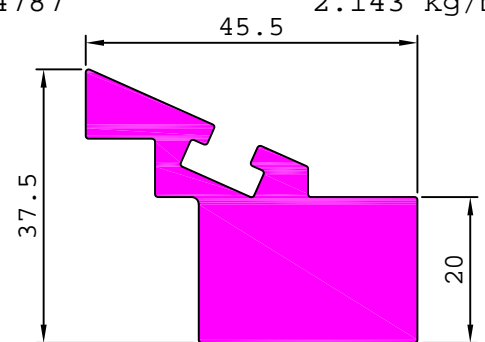

INDUSTRIAL

TEXTILE MACHINERY

24801 76.8 7.022 kg/m

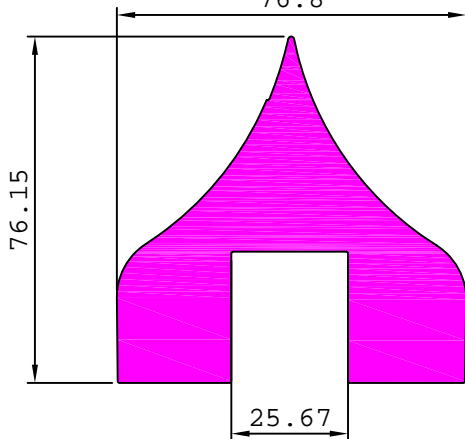

24828 5.523 kg/m

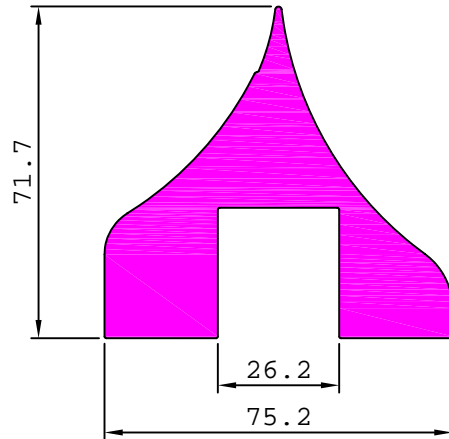

24823 4.265 kg/m

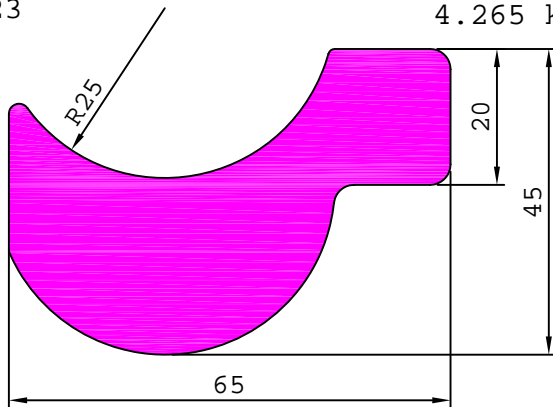

24843 2.912 kg/m

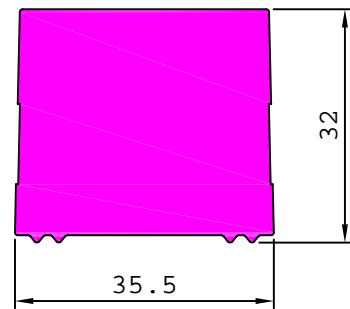

24881 5.541 kg/m

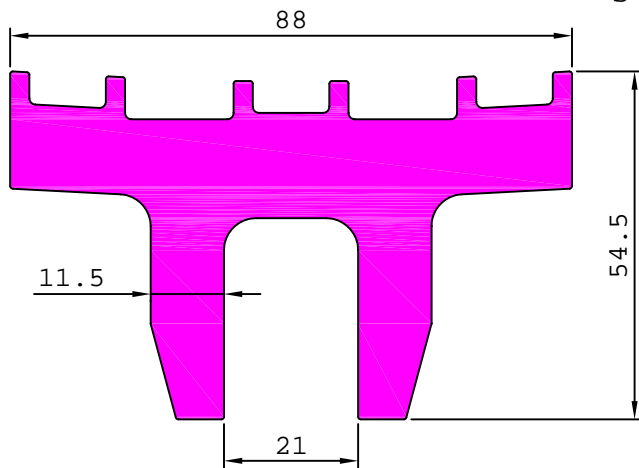

24870 4.152 kg/m

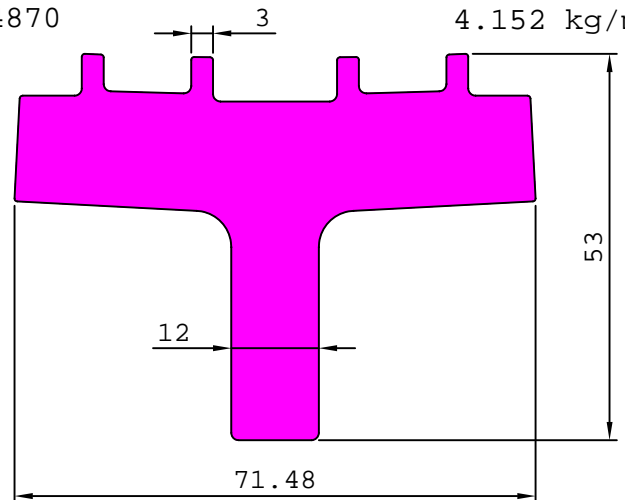

24867 4.094 kg/m

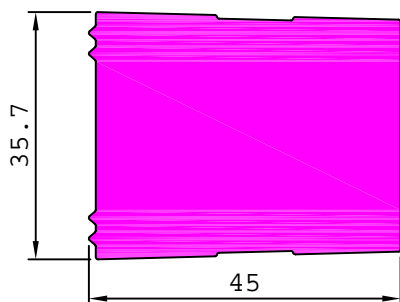

24884 0.560 kg/m

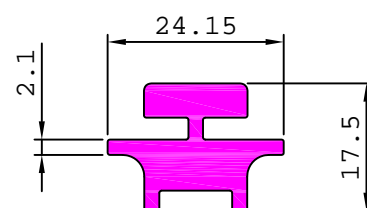

INDUSTRIAL

TEXTILE MACHINERY

24844 45.25 2.743 kg/m

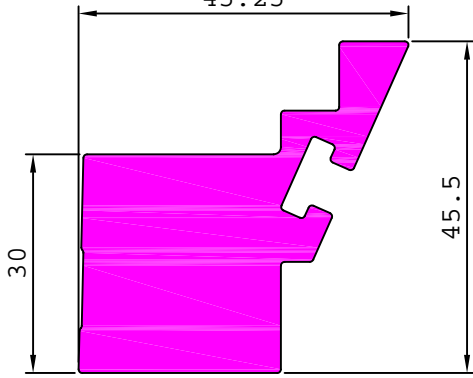

28253 2.711 kg/m

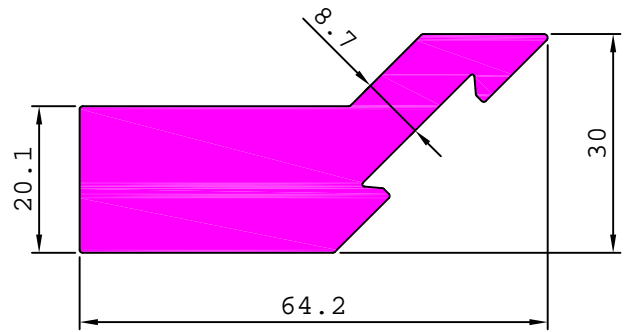

S4317 0.592 kg/m

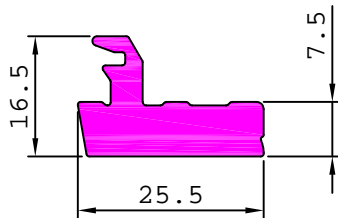

S4817 1.839 kg/m

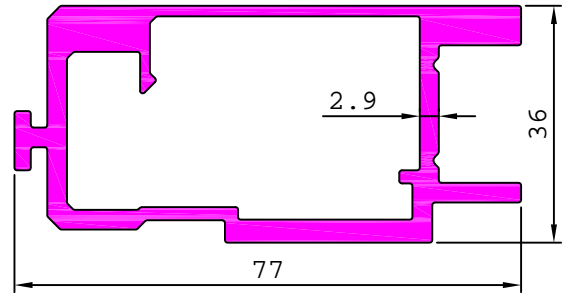

S4712 8.005 kg/m

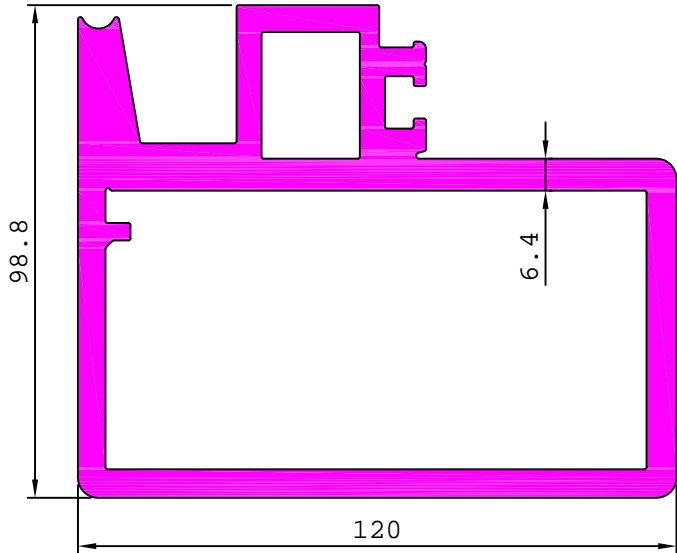

S5060 4.992 kg/m

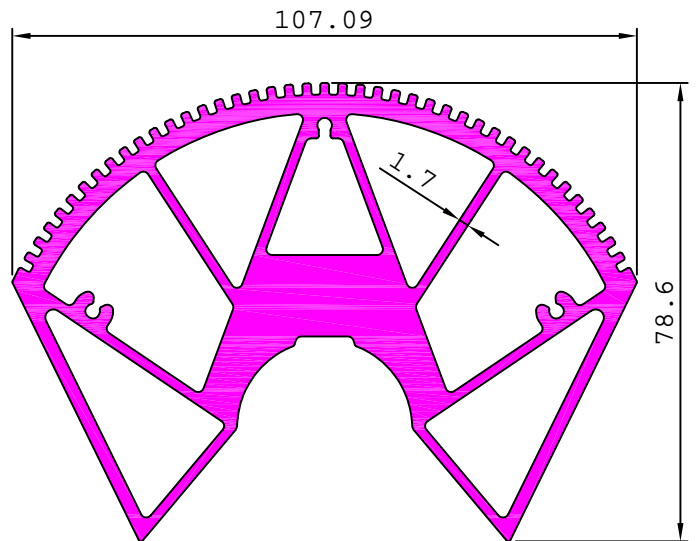

S4338 3.535 kg/m

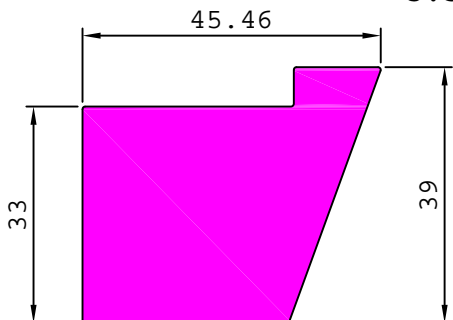

INDUSTRIAL

SUIT CASE

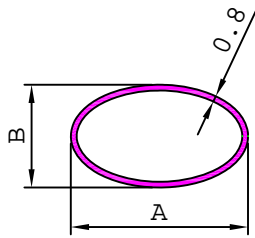

SL No	SECTION No	A	B	WEIGHT kg/m
1	15245	28.50	18.50	0.156
2	24907	24.30	14.10	0.127
3	24909	32.20	22.80	0.183

24910

0.300 kg/m

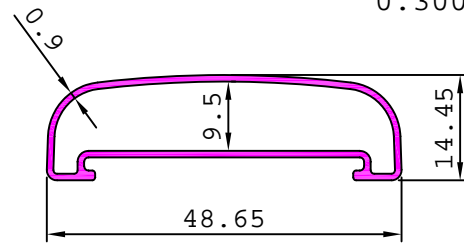

24911

0.384 kg/m

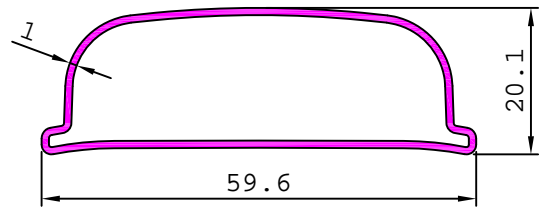

24908

0.113 kg/m

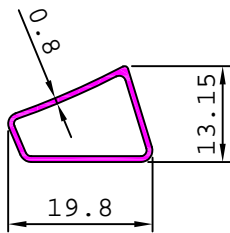

24912

0.160 kg/m

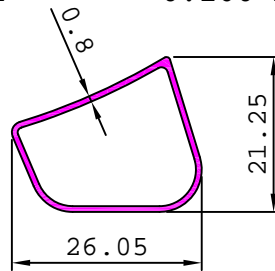

24913

0.126 kg/m

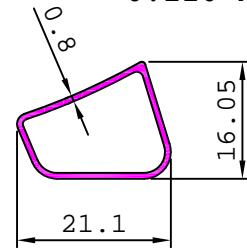

24914

0.092 kg/m

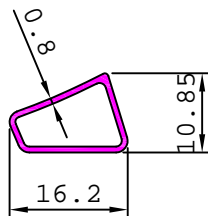

24906

0.152 kg/m

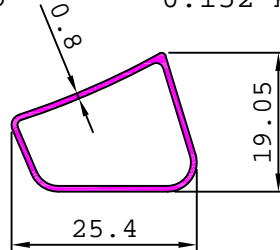

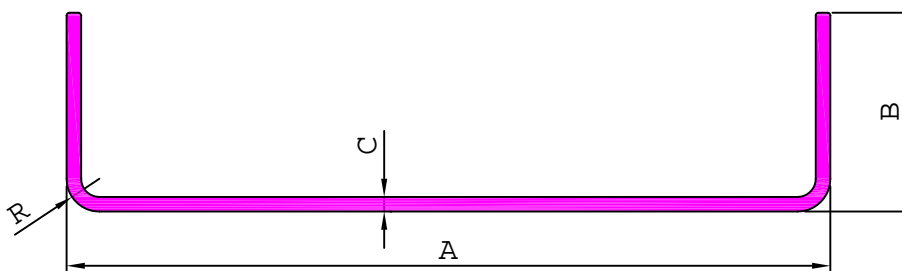
INDUSTRIAL**ELECTRICALS**

SL No	SECTION No	A	B	C	R	WEIGHT kg/m
1	S5008	90.00	57.00	3.00	4.00	1.586
2	S5009	96.00	15.00	2.00	4.00	0.645
3	25238	126.00	15.00	2.00	4.50	0.804
4	25282	153.00	86.50	2.50	5.00	2.145
5	25228	165.00	57.00	3.00	4.00	2.194
6	25229	171.00	15.00	2.00	4.50	1.047
7	25226	181.00	15.00	2.00	4.50	1.101
8	25237	185.00	57.00	3.00	4.00	2.356
9	25239	191.00	15.00	2.00	4.50	1.155
10	S5010	200.00	57.00	3.00	4.00	2.477
11	25225	201.00	15.00	2.00	4.50	1.209
12	S5031	206.00	15.00	2.20	4.00	1.361
13	25236	211.00	15.00	2.00	4.50	1.263
14	S5032	241.50	15.00	2.30	4.00	1.642

INDUSTRIAL

ELECTRICALS

25158

2.407 kg/m

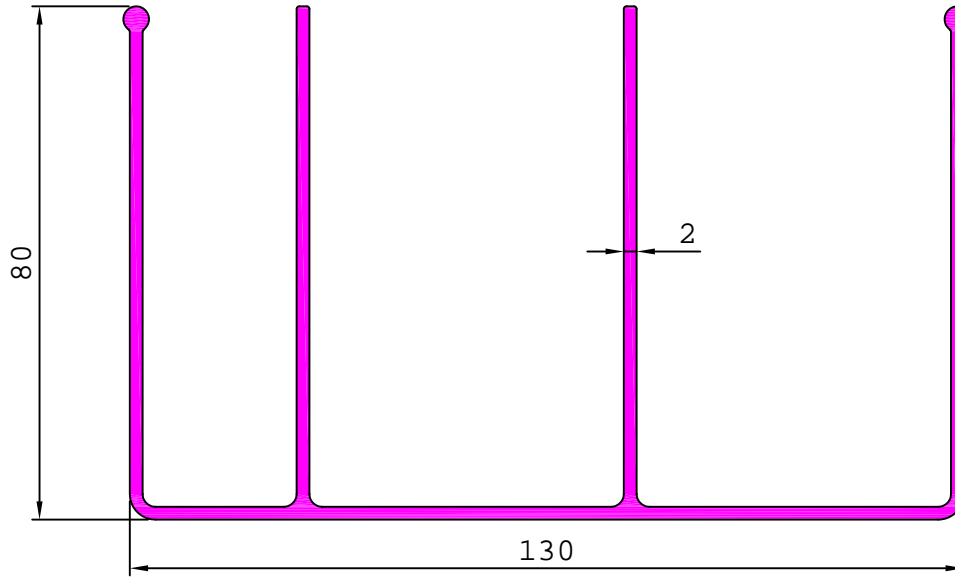

25159

3.685 kg/m

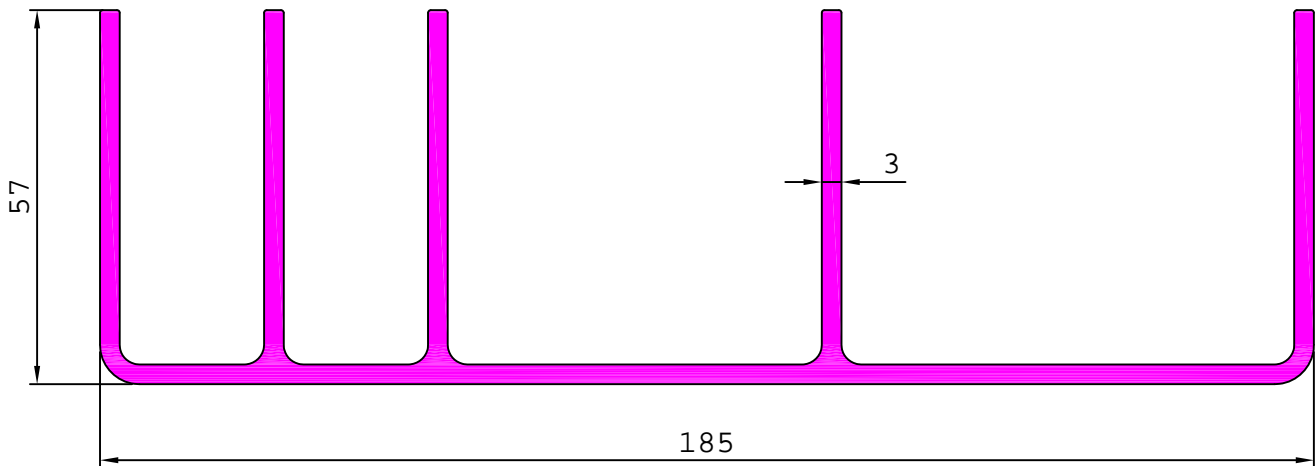

25160

3.156 kg/m

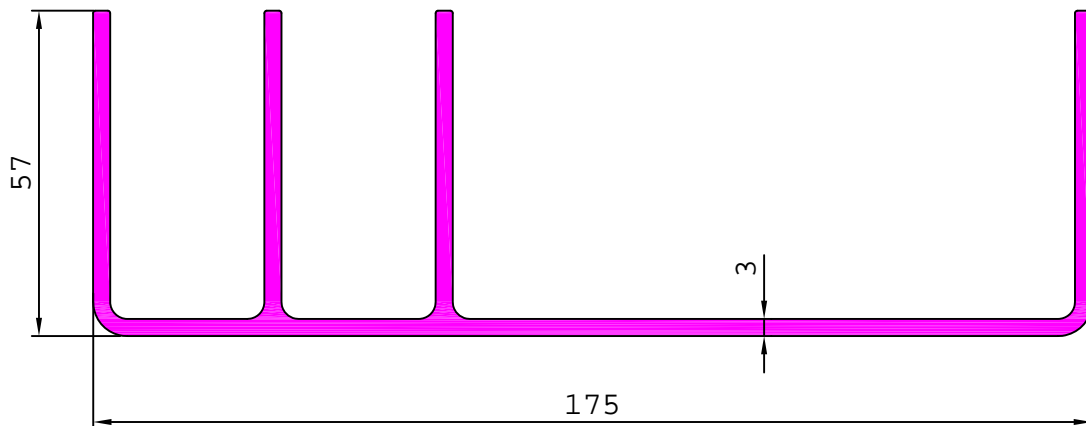

INDUSTRIAL

ELECTRICALS

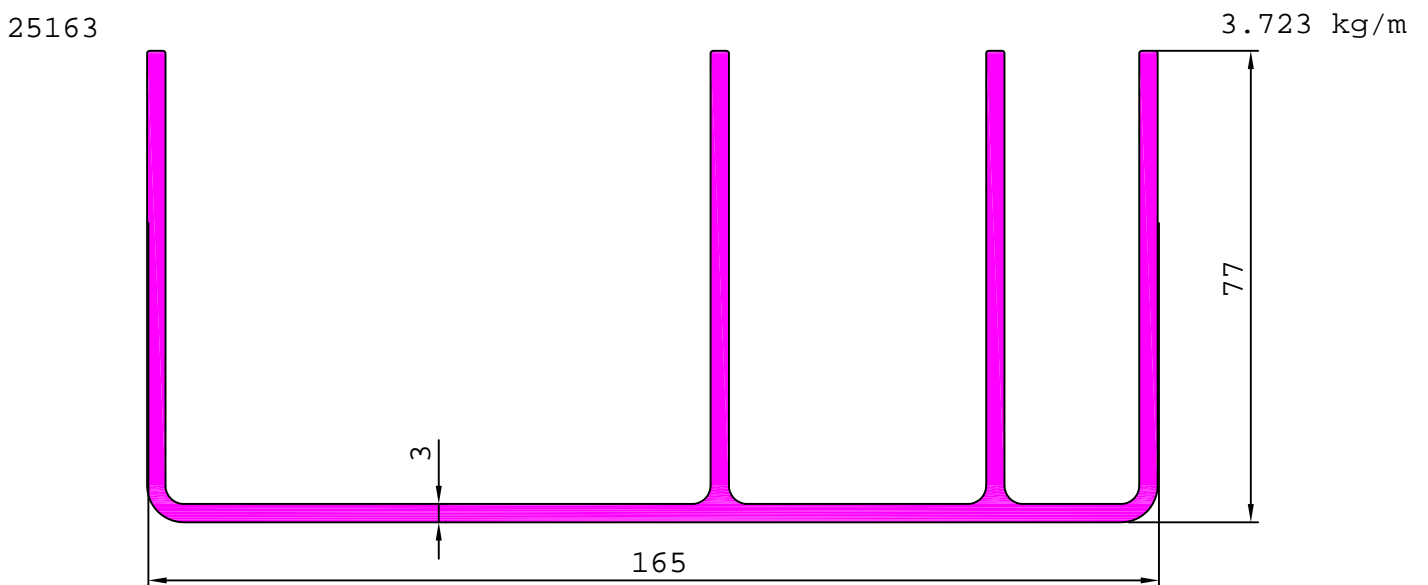
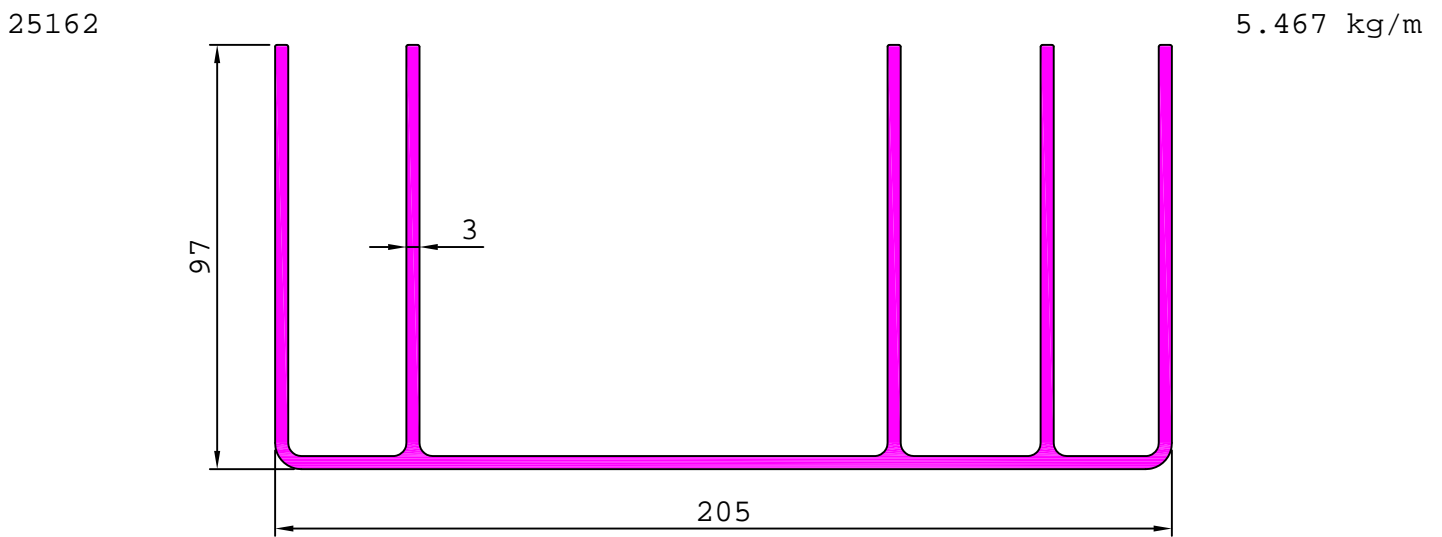
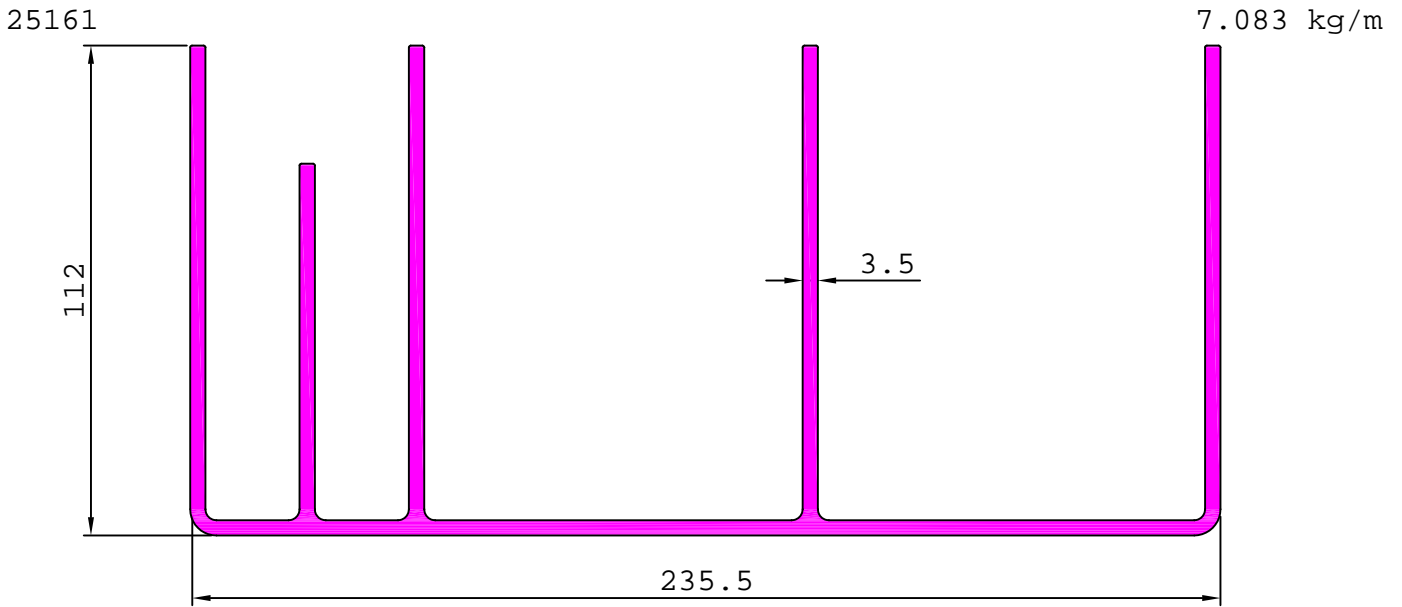

INDUSTRIAL

ELECTRICALS

25164

3.885 kg/m

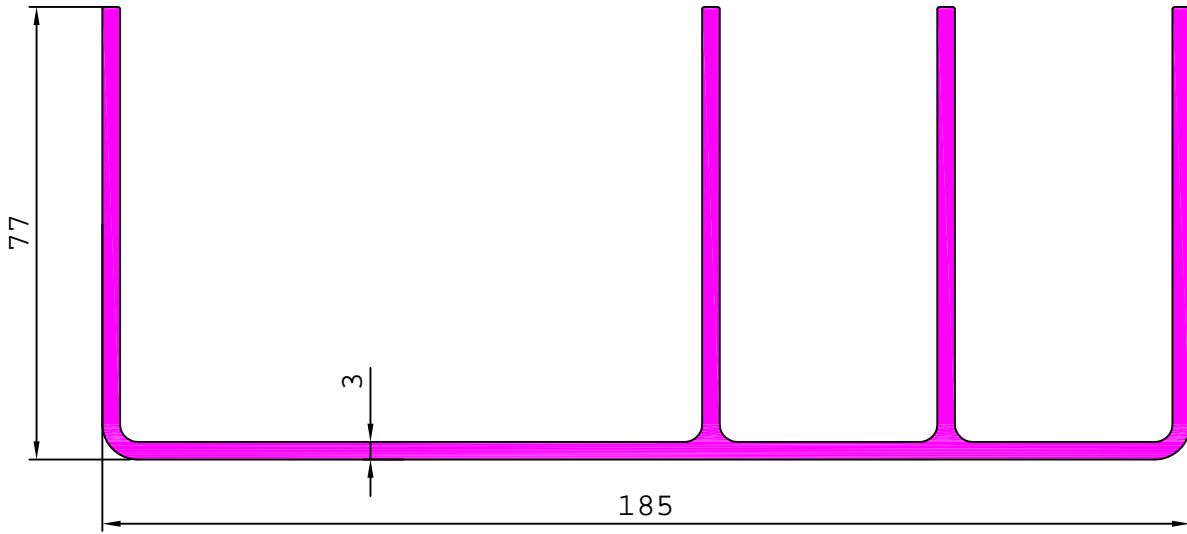

25224

5.372 kg/m

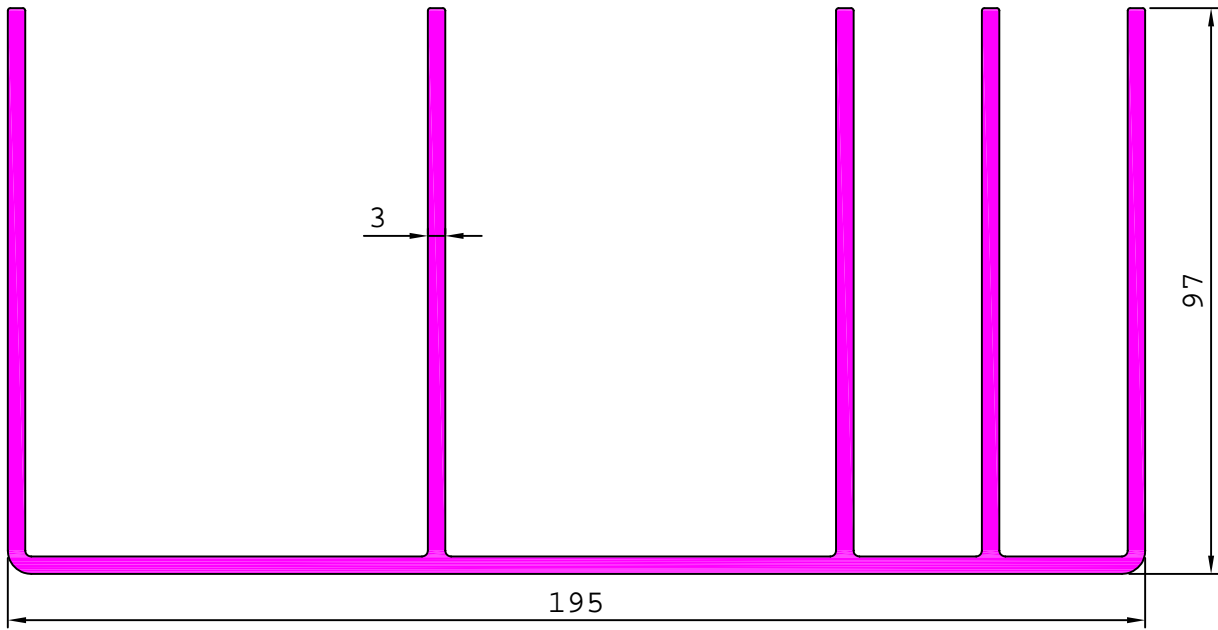

25227

3.509 kg/m

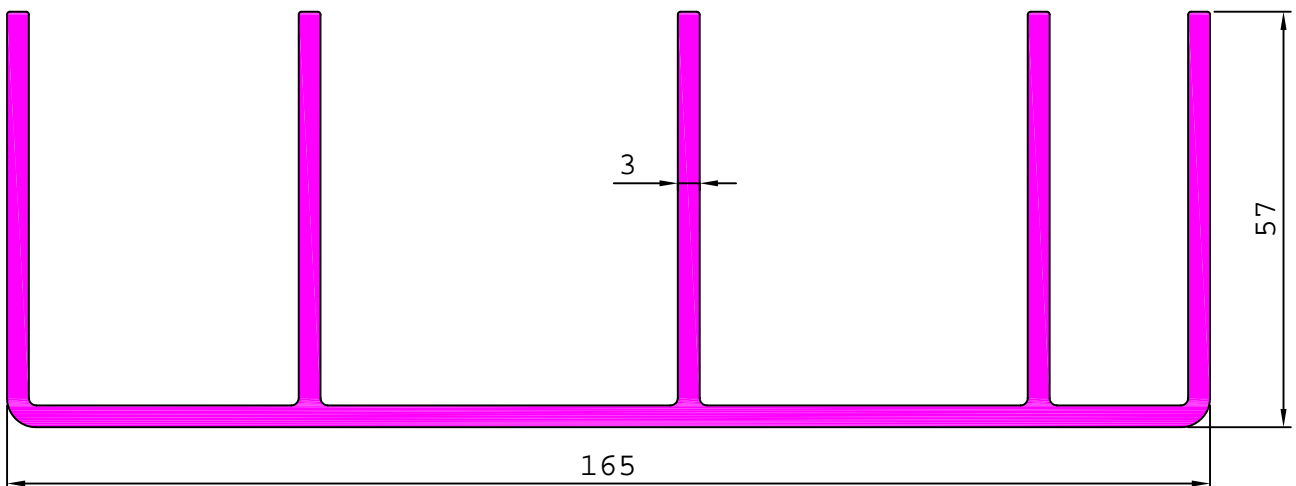

INDUSTRIAL

ELECTRICALS

25230

3.833 kg/m

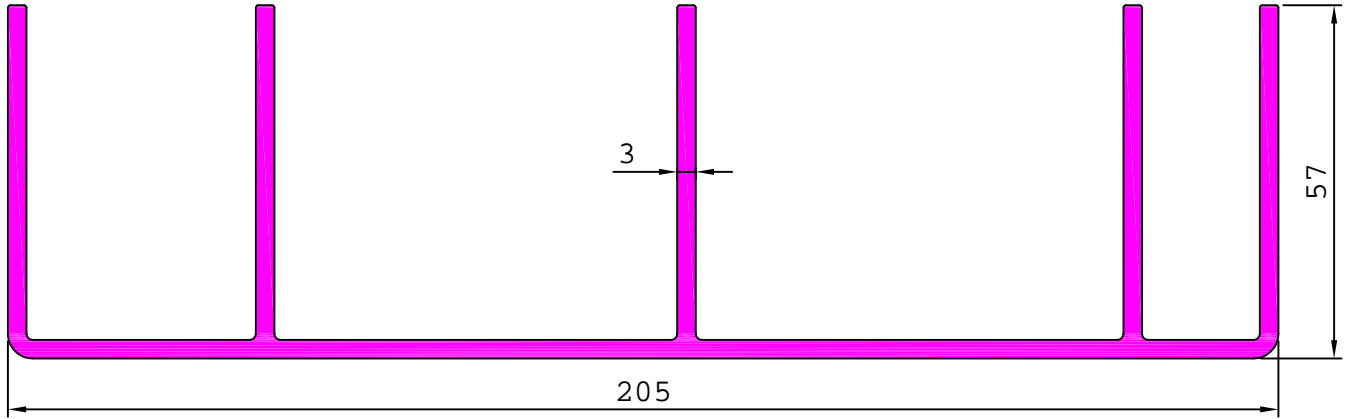

25231

2.267 kg/m

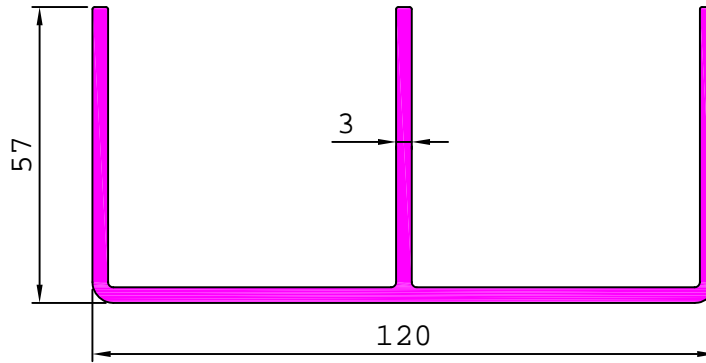

25232

3.232 kg/m

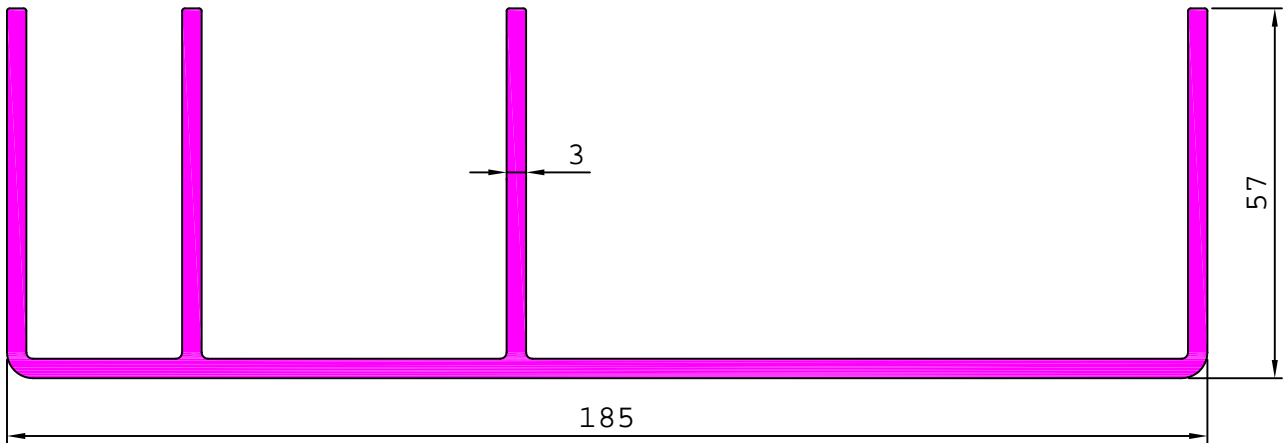

25233

3.671 kg/m

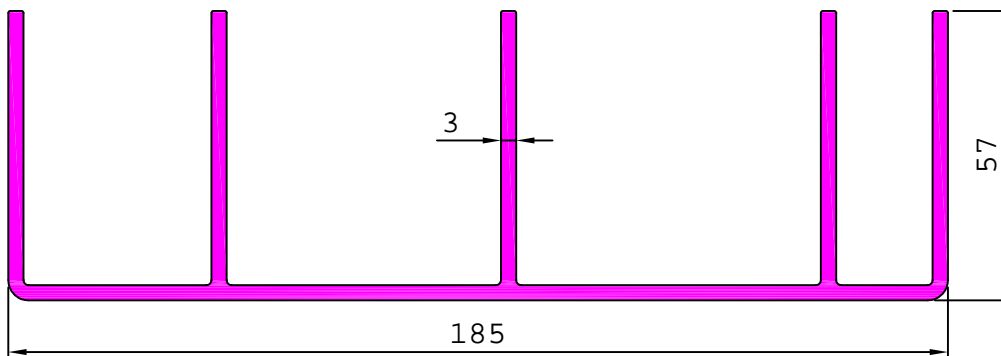

INDUSTRIAL

ELECTRICALS

25234

3.671 kg/m

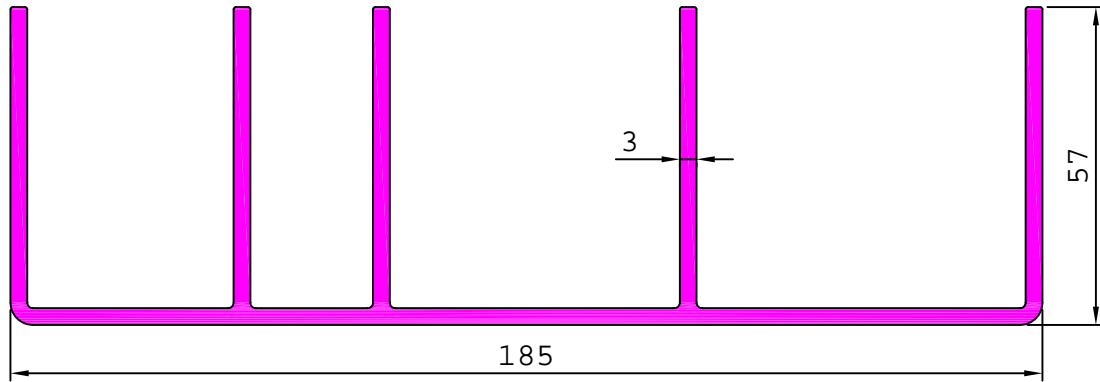

25235

3.232 kg/m

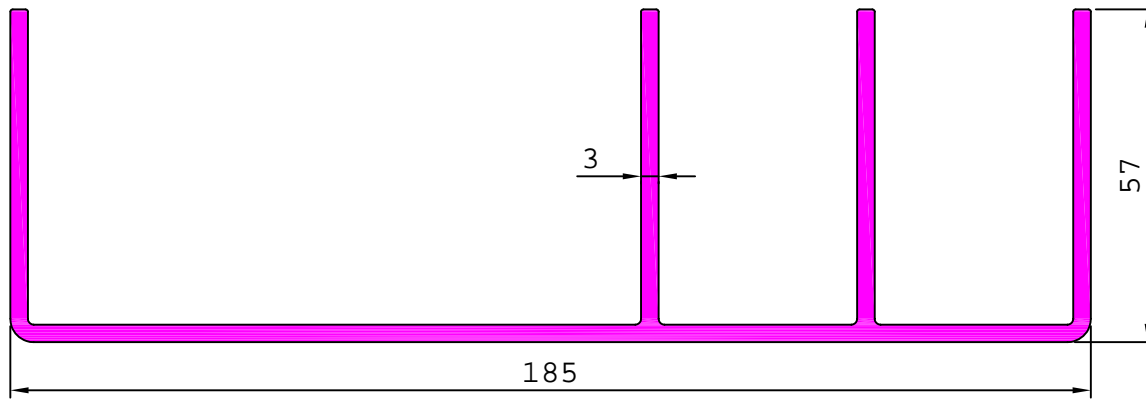

25240

3.590 kg/m

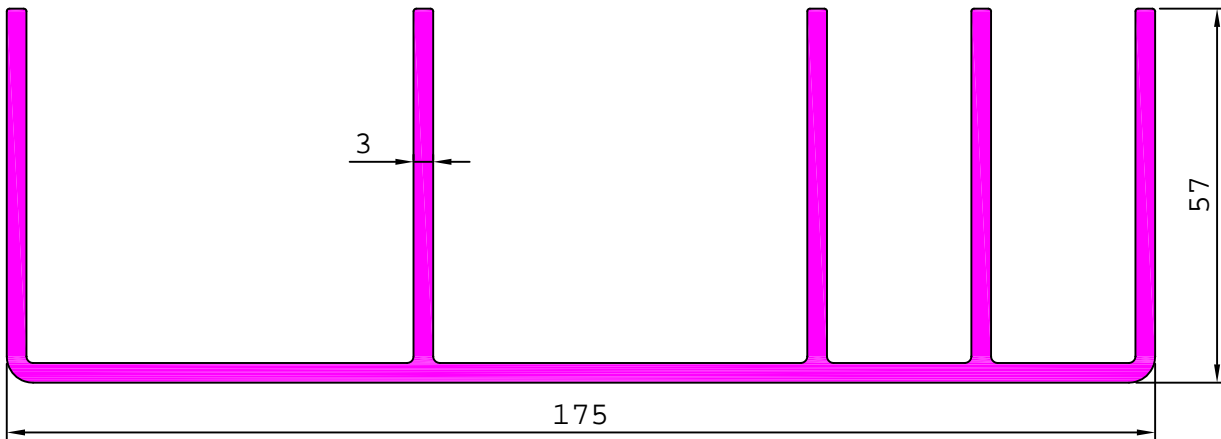

S4643

3.175 kg/m

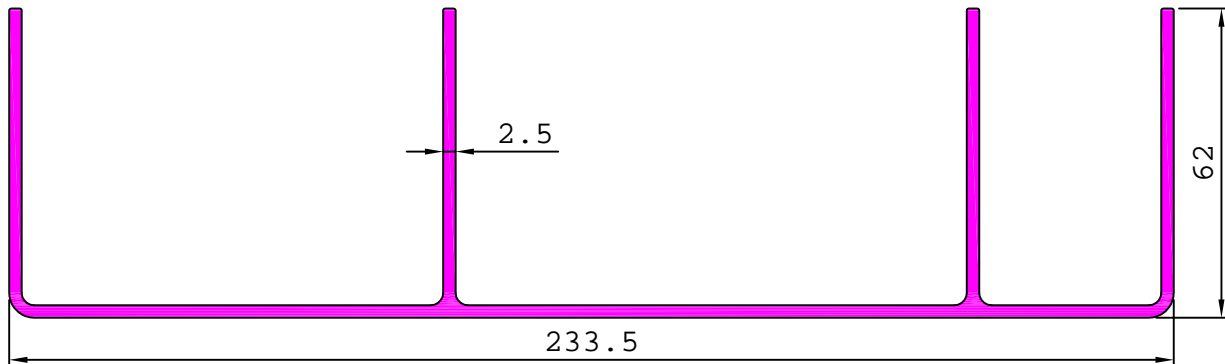

INDUSTRIAL

ELECTRICALS

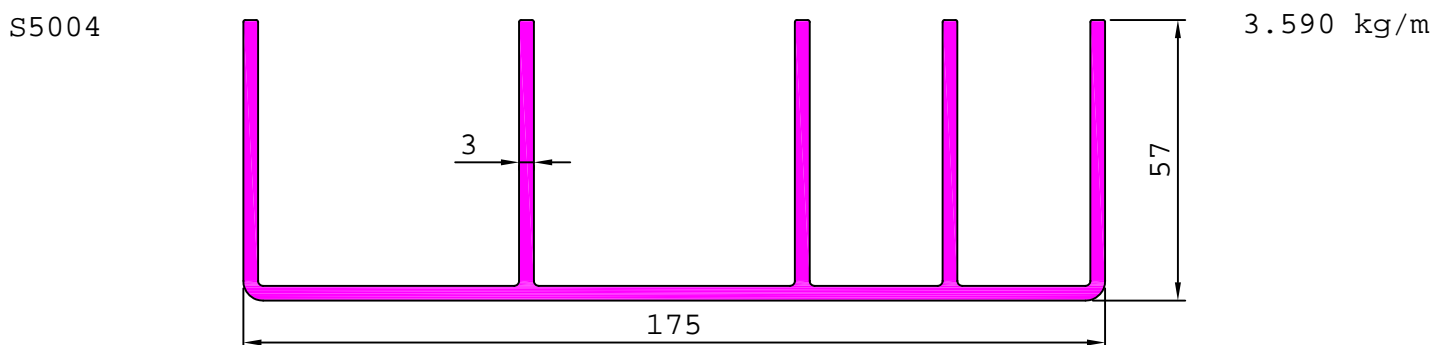
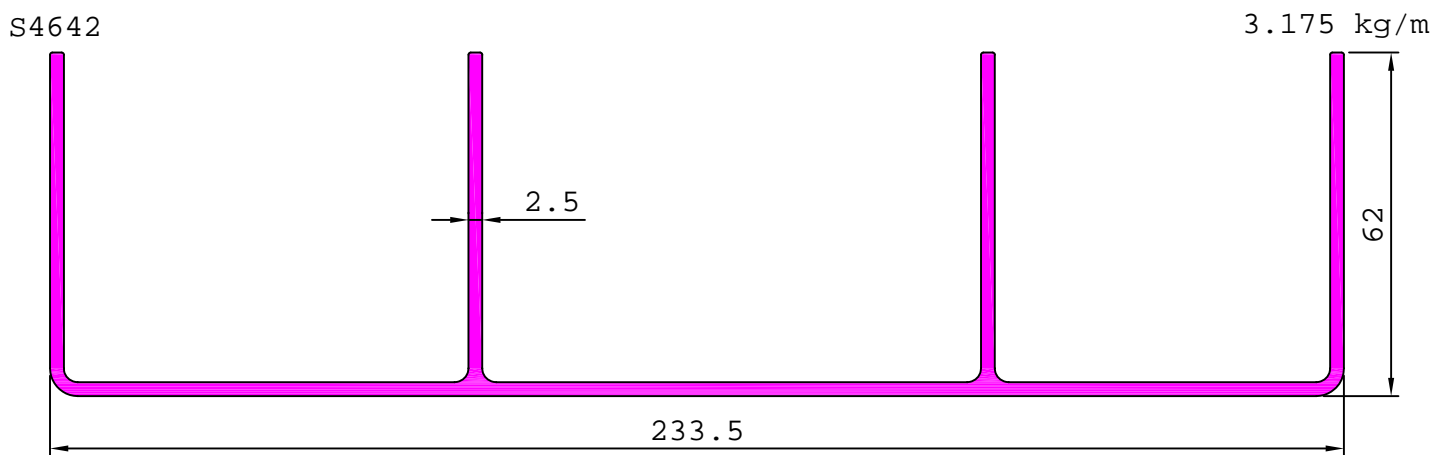
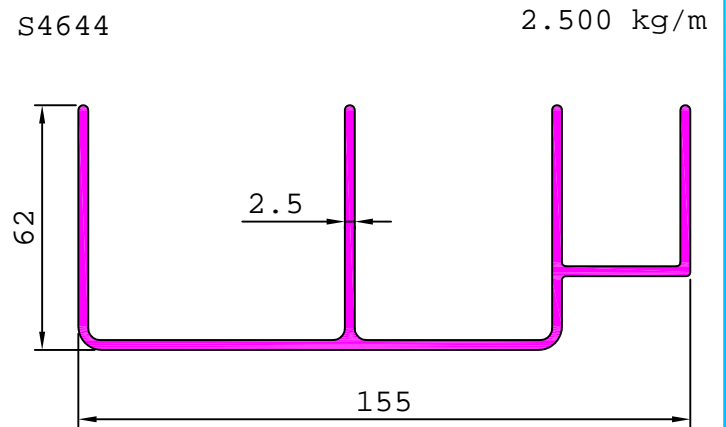
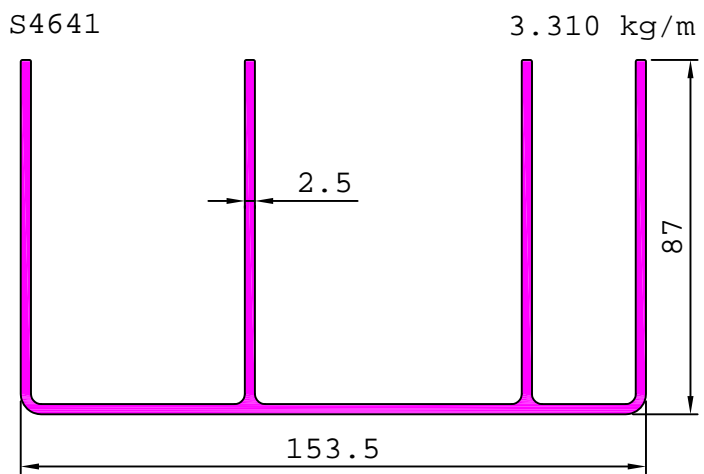
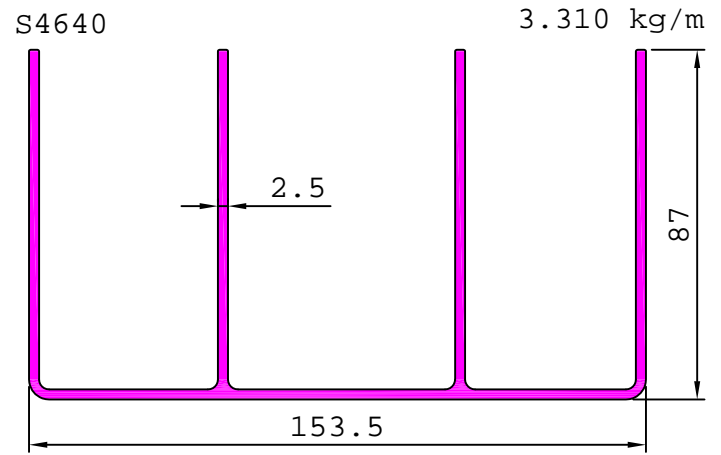
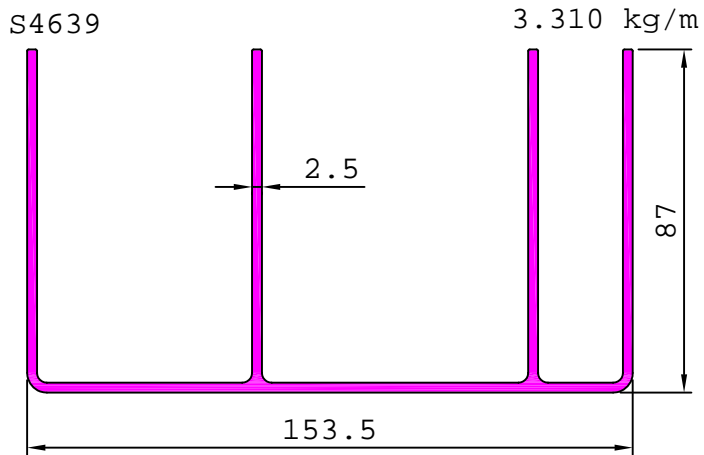

INDUSTRIAL

ELECTRICALS

S5005

3.232 kg/m

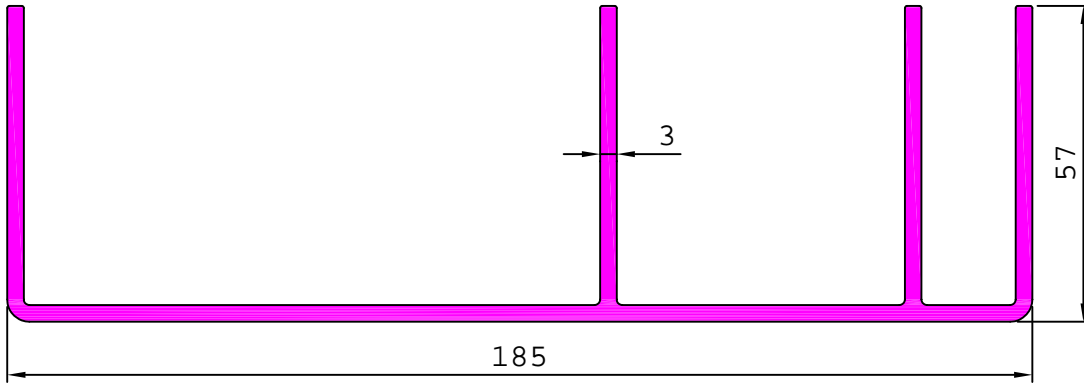

S5006

3.232 kg/m

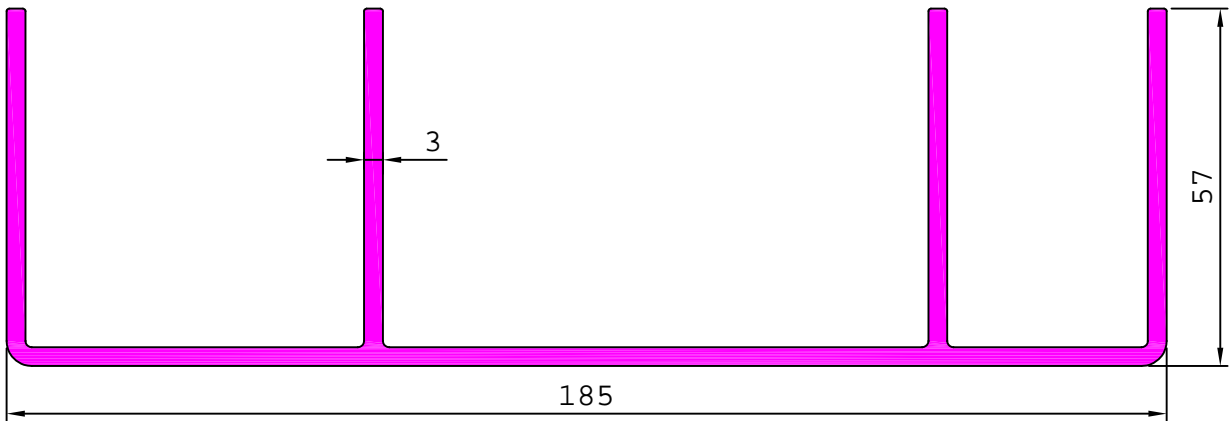

S5007

2.794 kg/m

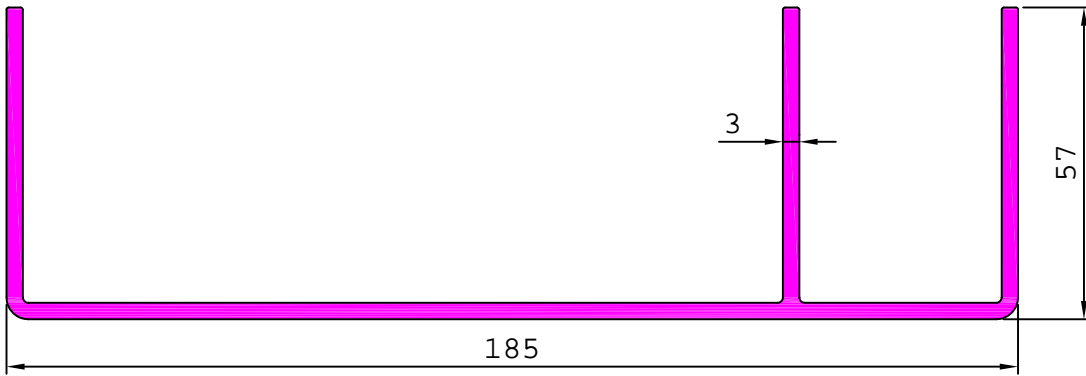

S5070

5.807 kg/m

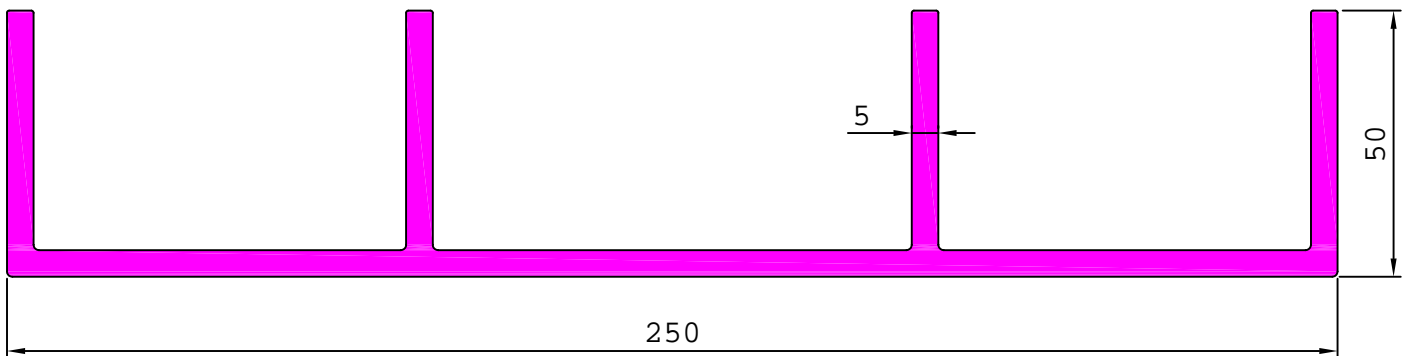

INDUSTRIAL

ELECTRICALS

29403

6.059 kg/m

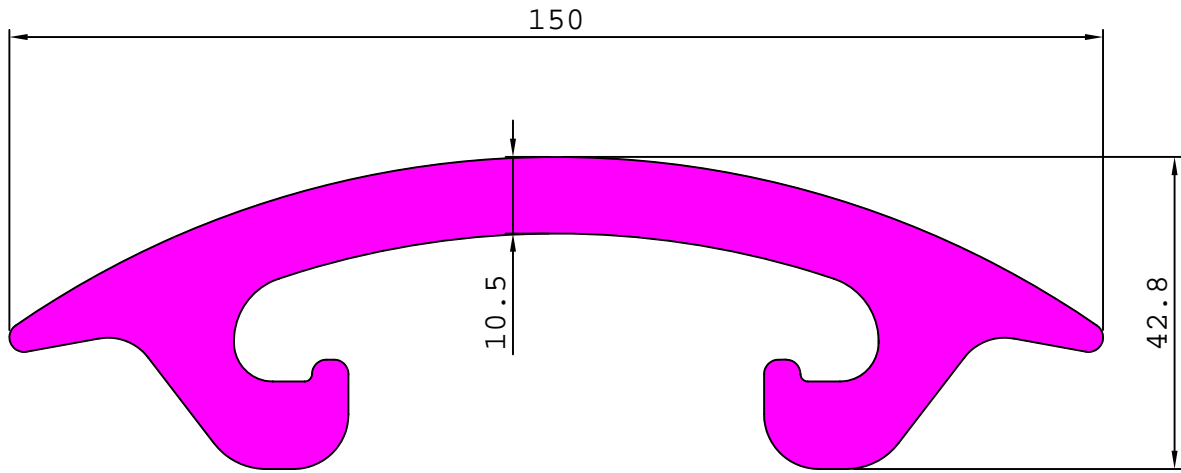

25190

8.098 kg/m

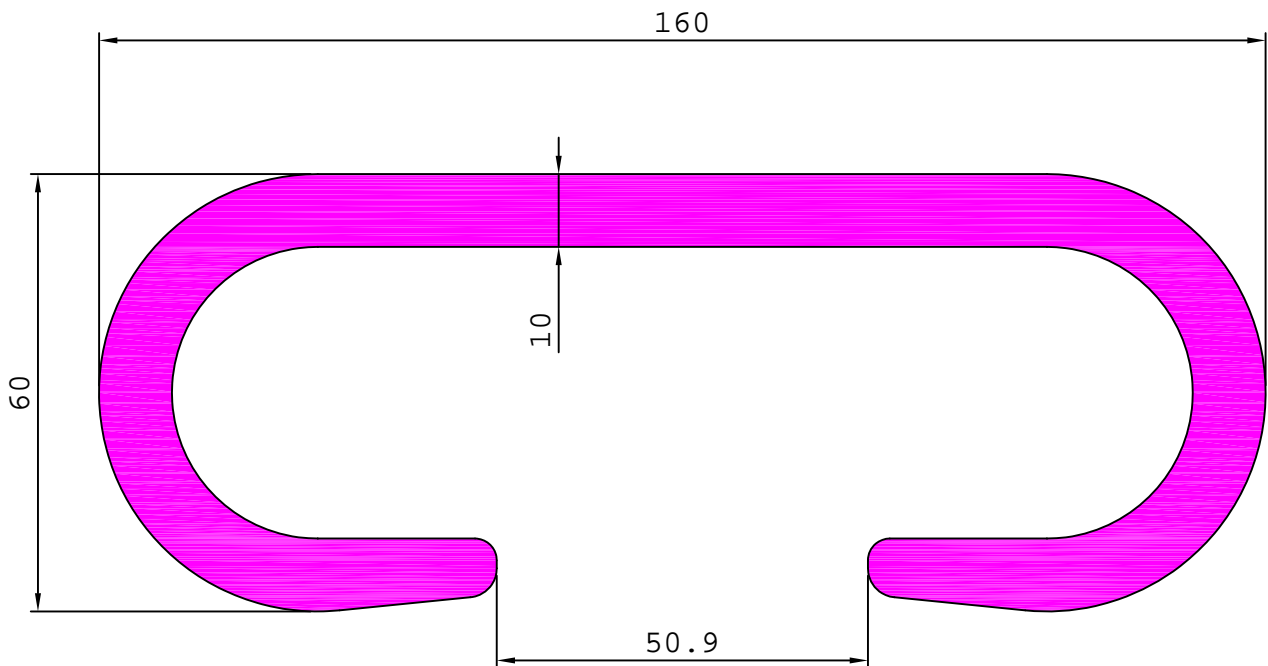

INDUSTRIAL

ELECTRICALS

25147 2.930 kg/m

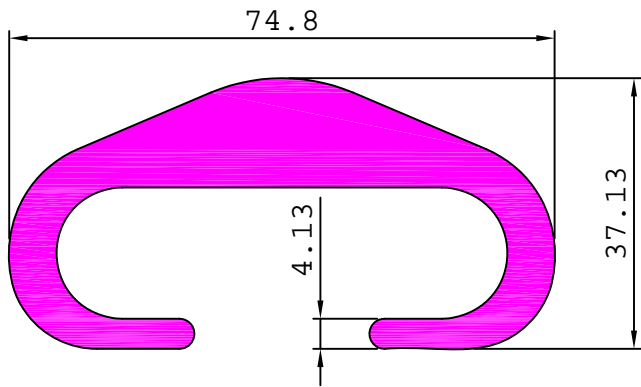

25153 4.158 kg/m

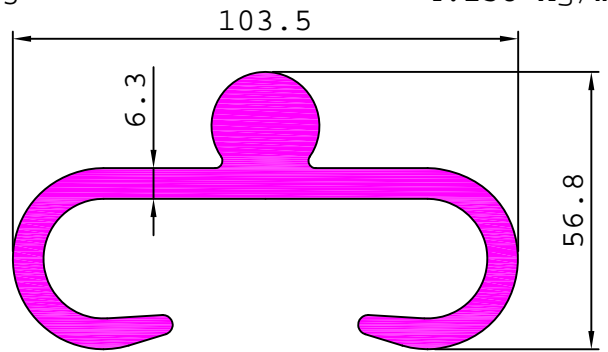

25166 2.048 kg/m

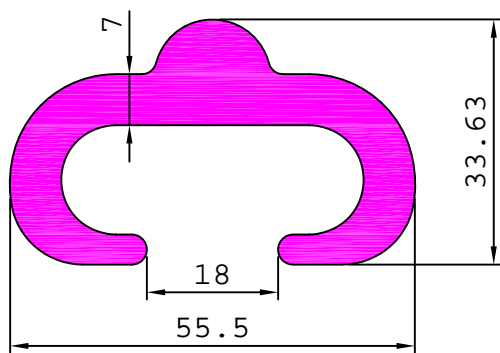

25170 1.795 kg/m

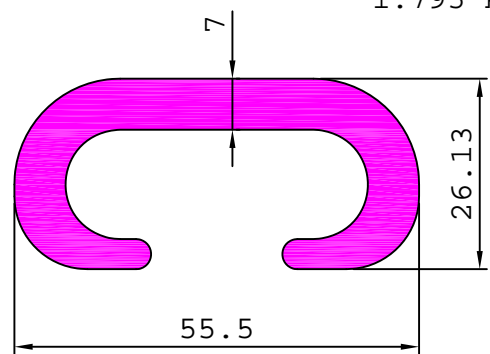

25177 2.469 kg/m

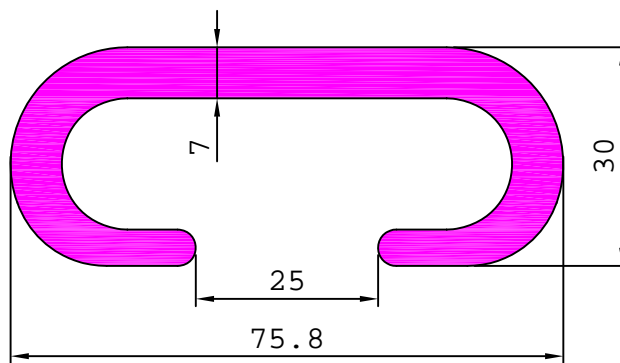

25165 4.893 kg/m

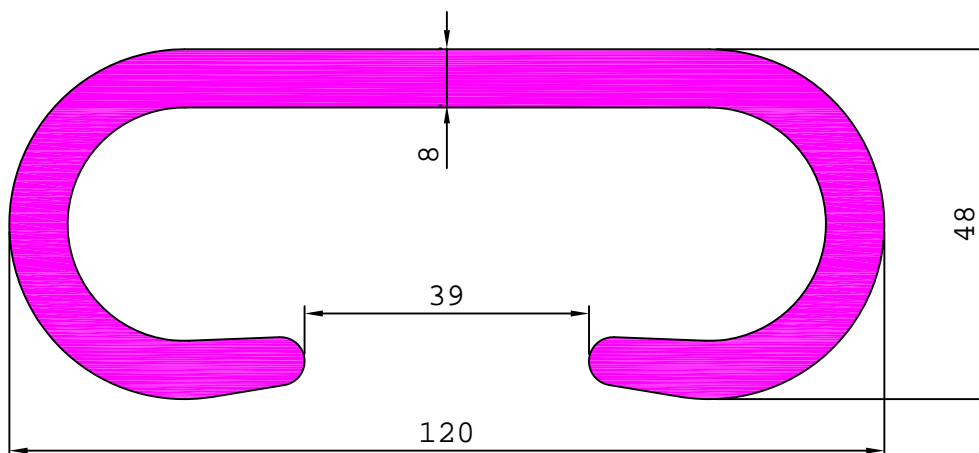

INDUSTRIAL

ELECTRICALS

25178

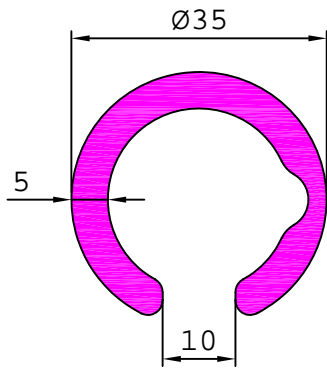

1.080 kg/m

25206

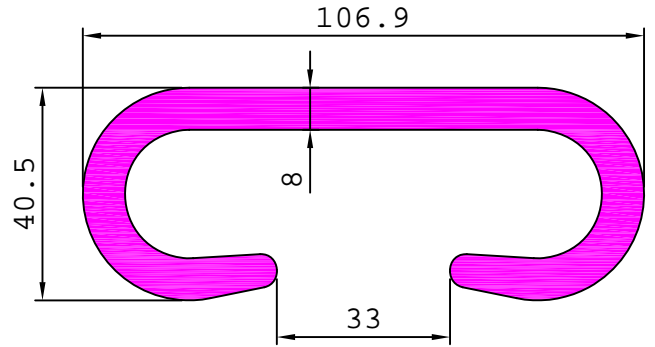

4.268 kg/m

S4328

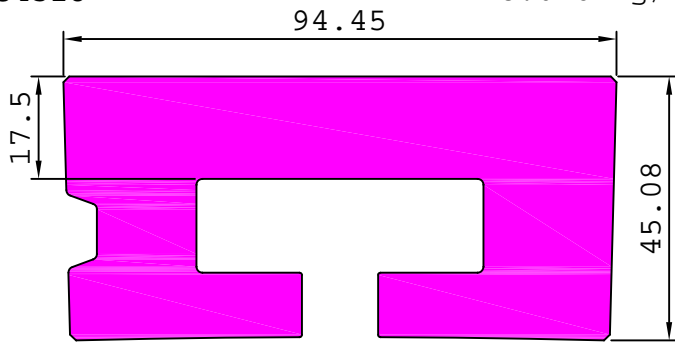

8.610 kg/m

INDUSTRIAL

ELECTRICALS

28231

26.401 kg/m

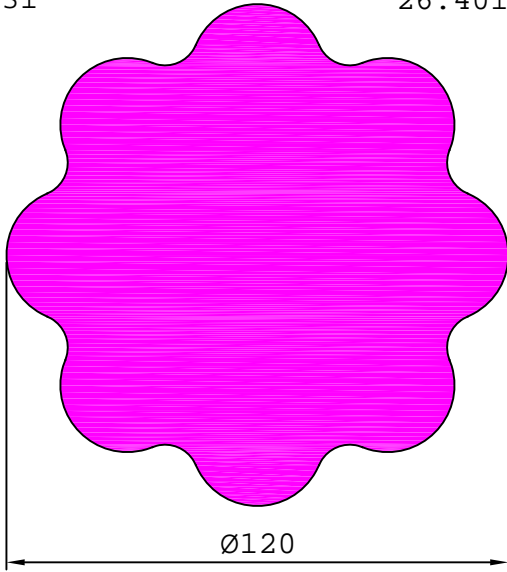

S4830

23.850 kg/m

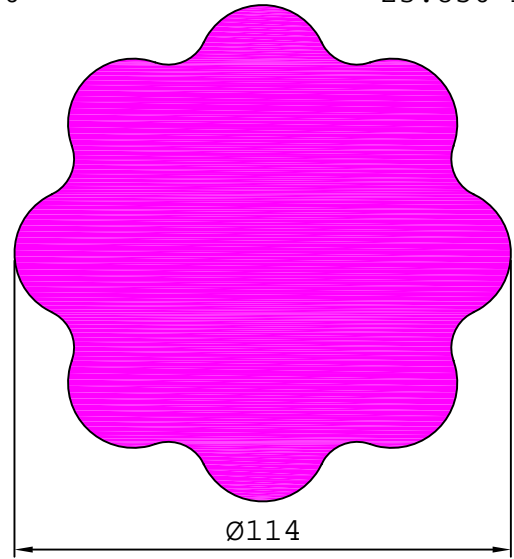

S4933

20.551 kg/m

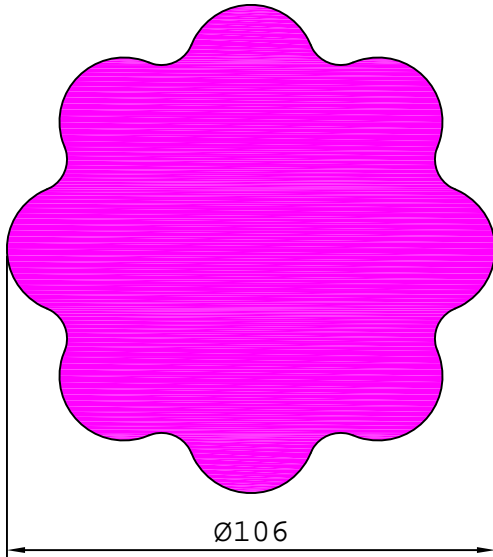

S4934

17.615 kg/m

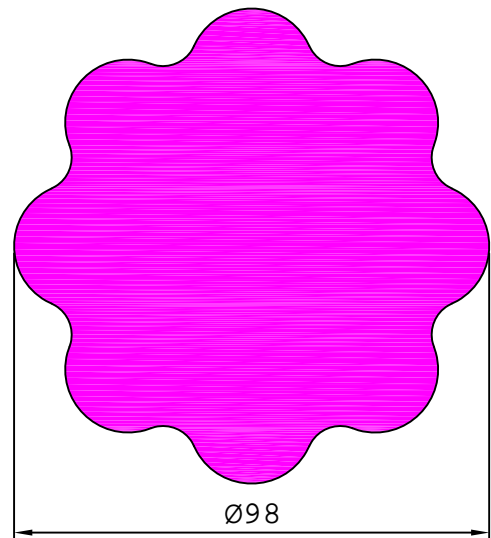

S4995

35.934 kg/m

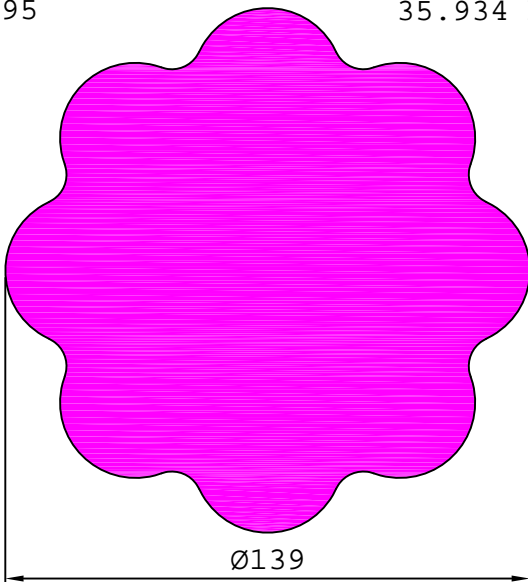

S5001

11.347 kg/m

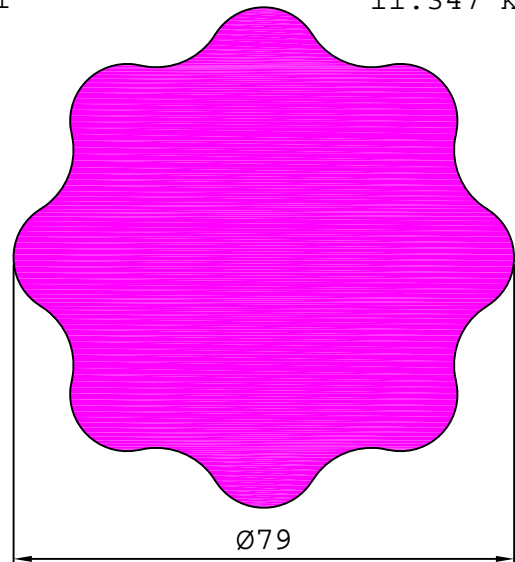

INDUSTRIAL

ELECTRICALS

S5200

22.856 kg/m

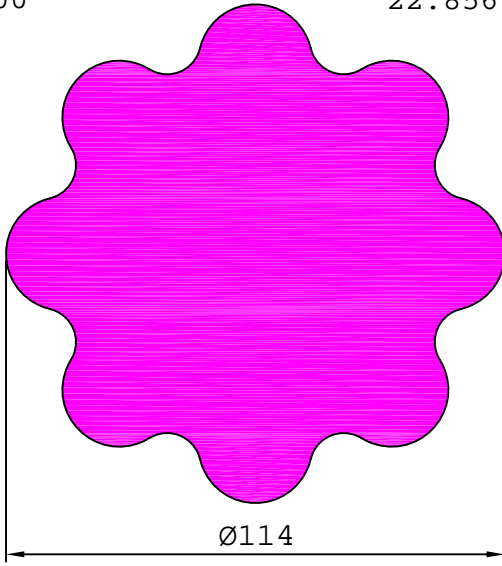

S5201

19.755 kg/m

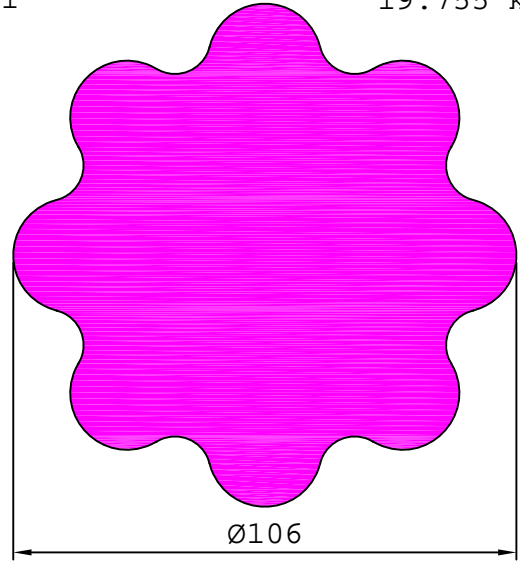

S5202

25.332 kg/m

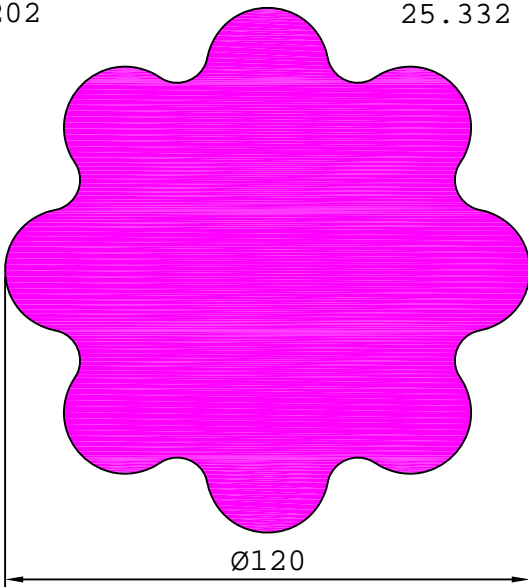

S5204

34.256 kg/m

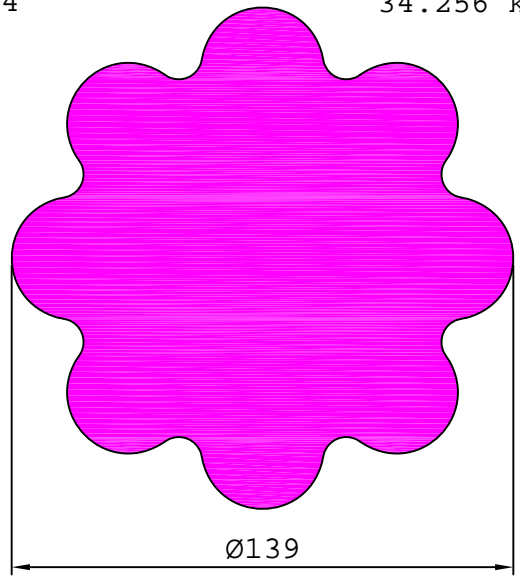

S5205

11.144 kg/m

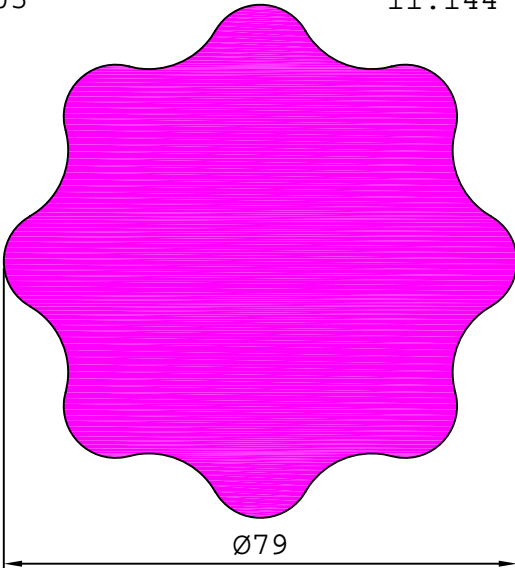

S5206

16.900 kg/m

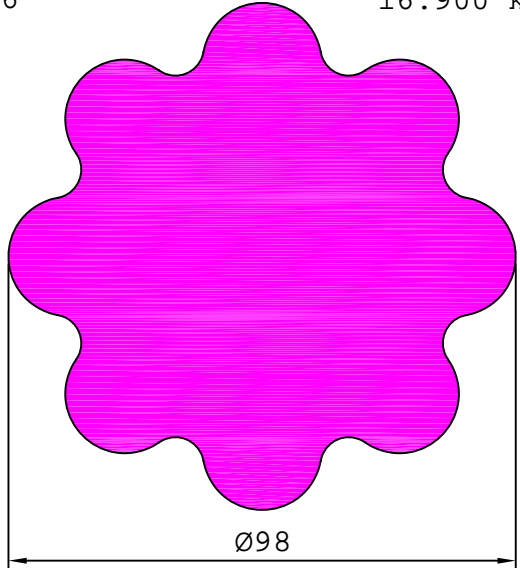

INDUSTRIAL

ELECTRICALS

S5097

10.531 kg/m

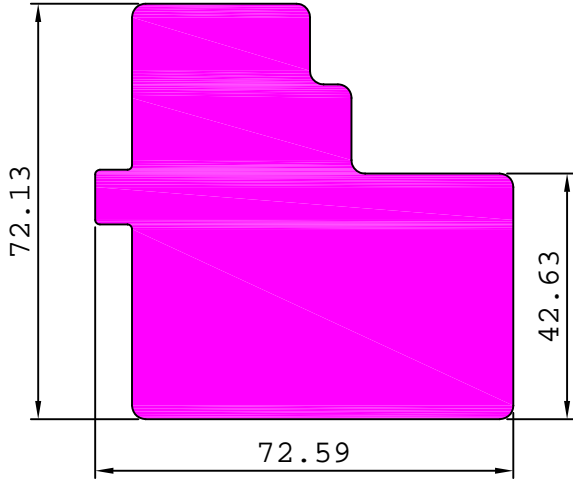

S5098

11.676 kg/m

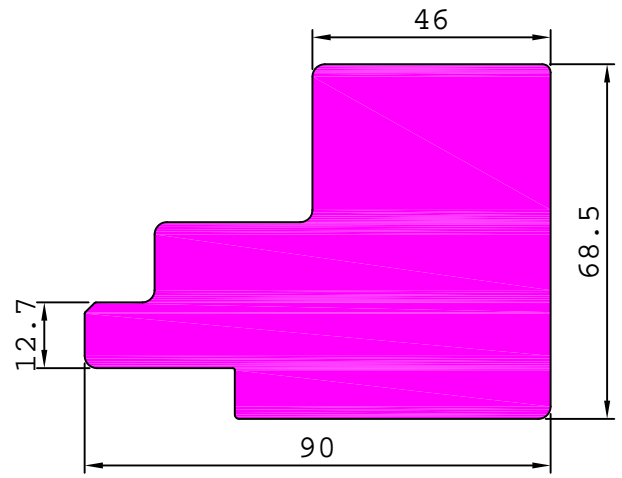

S5099

10.560 kg/m

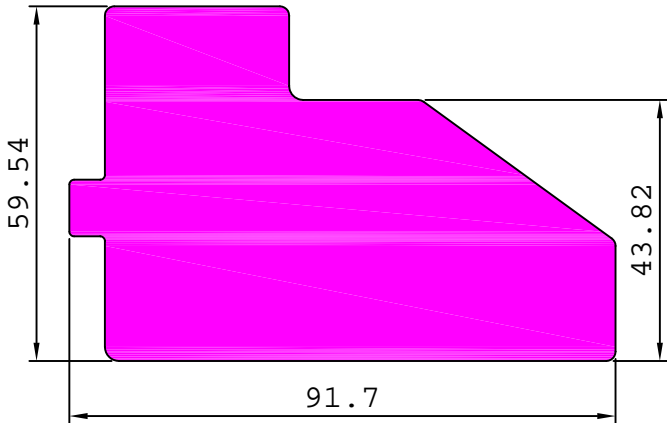

INDUSTRIAL

ELECTRICALS

25052

1.932 kg/m

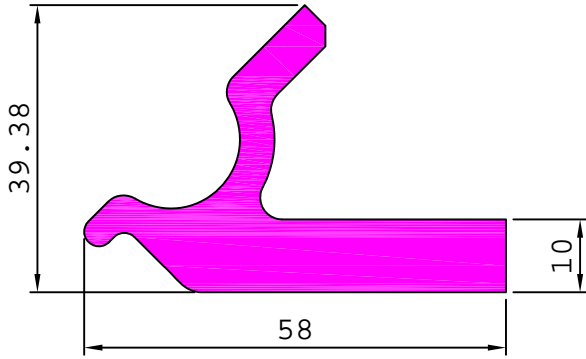

25065

0.708 kg/m

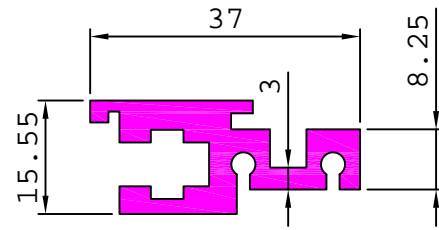

25059

0.371 kg/m

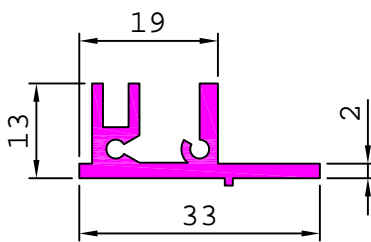

25060

0.336 kg/m

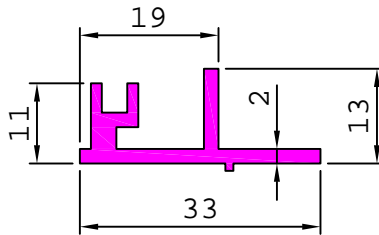

25063

0.129 kg/m

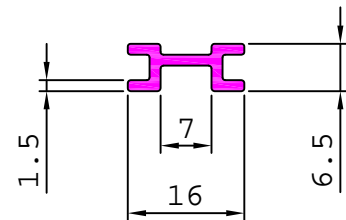

25064

1.094 kg/m

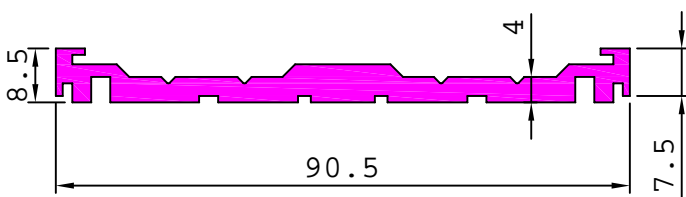

25069

0.798 kg/m

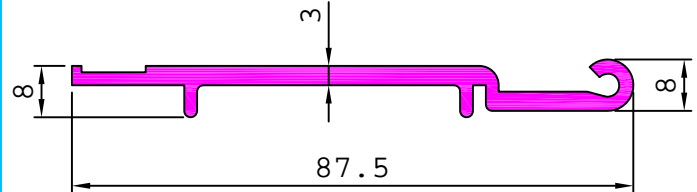

25075

0.800 kg/m

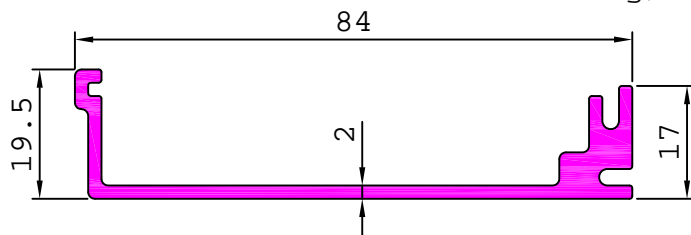

25081

0.358 kg/m

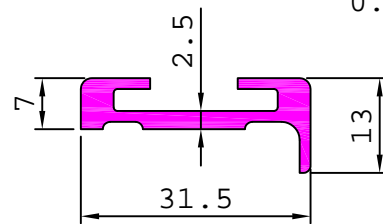

25091

2.934 kg/m

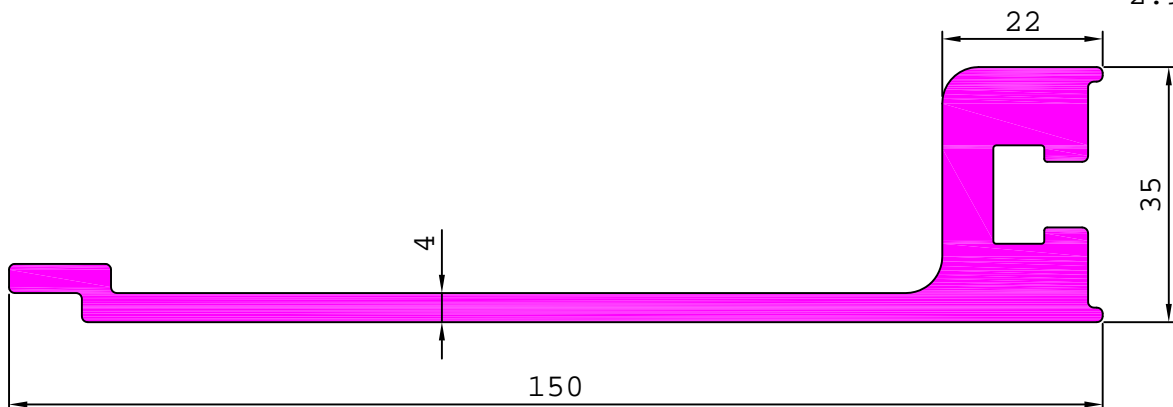

INDUSTRIAL

ELECTRICALS

25092

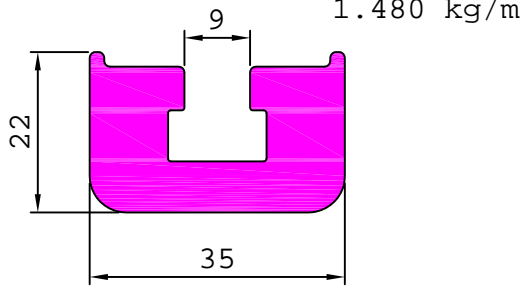

25080

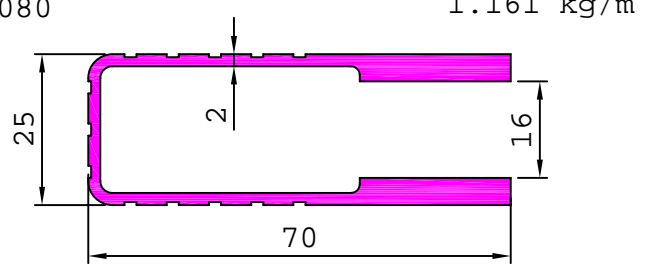

25095

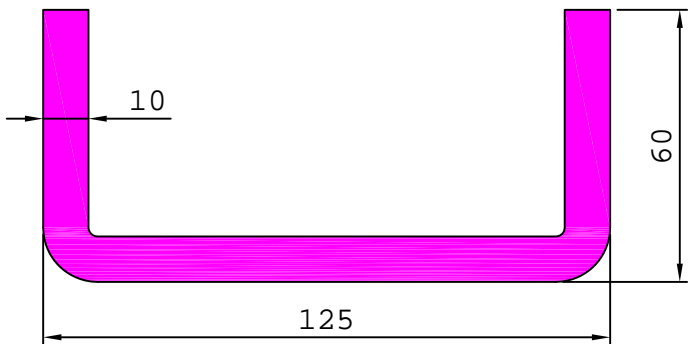

25133

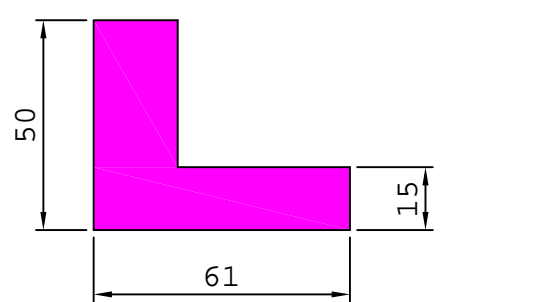

25129

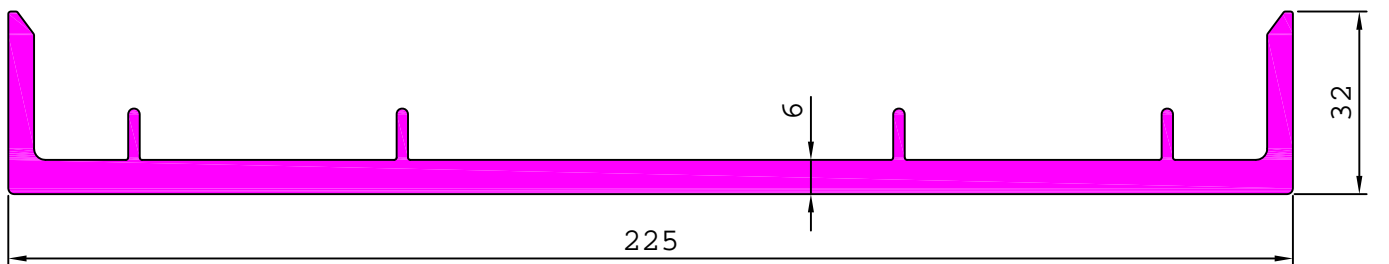

25140

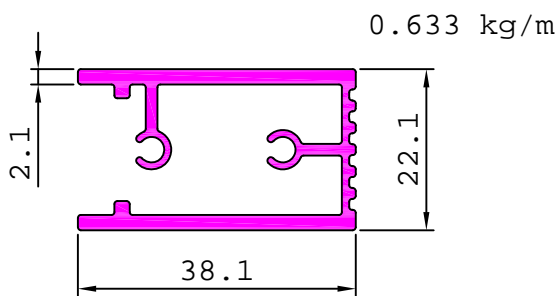

25144

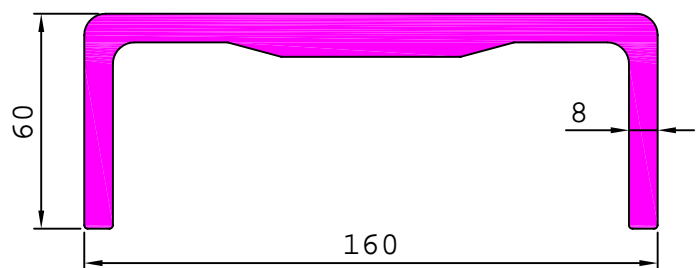

25142

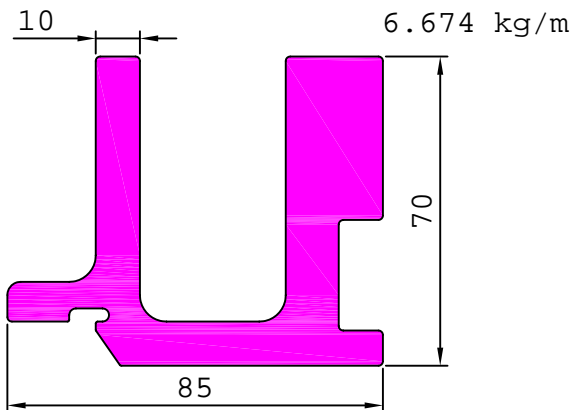

25143

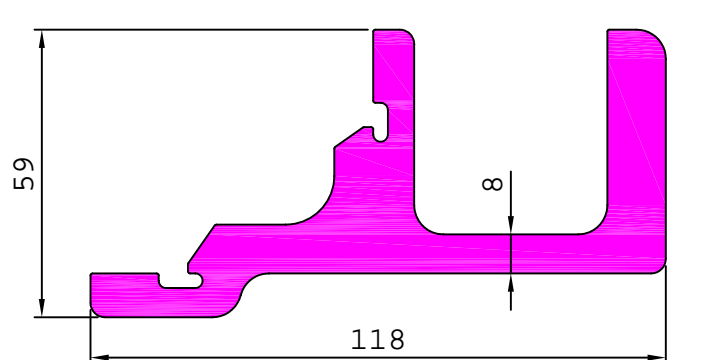

INDUSTRIAL

ELECTRICALS

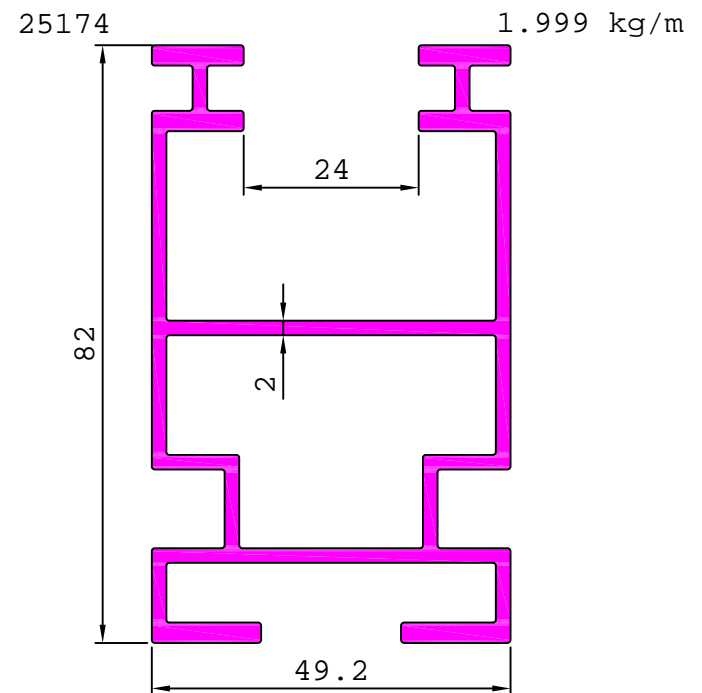
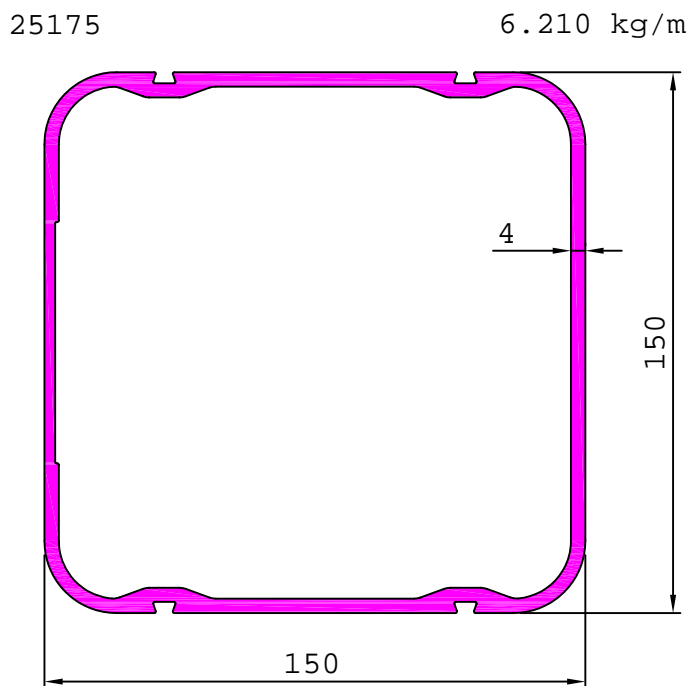
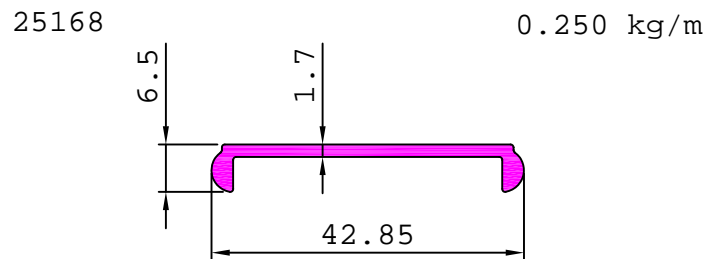
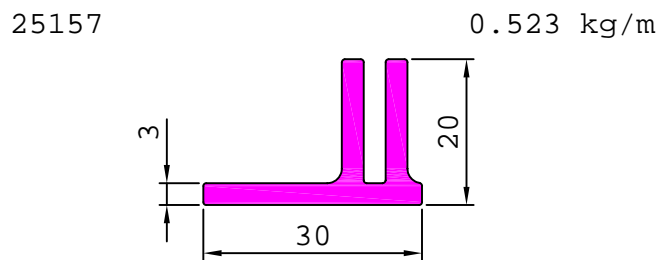
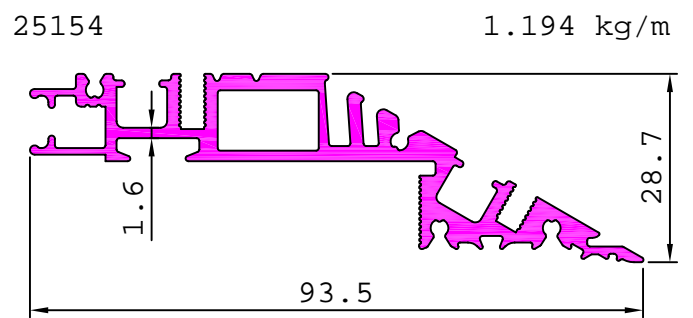
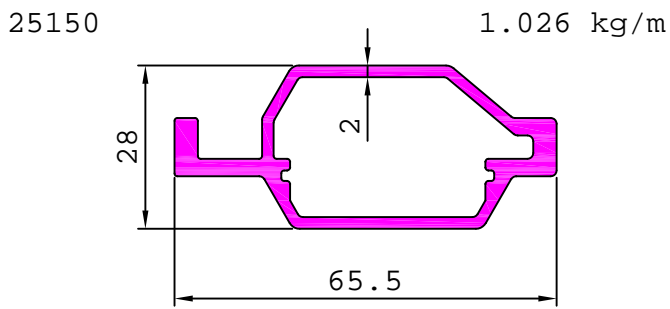
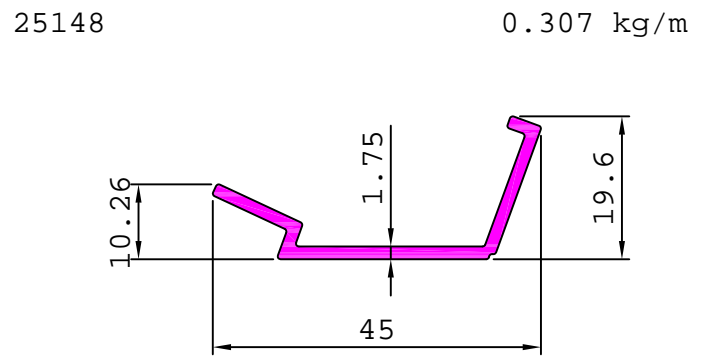
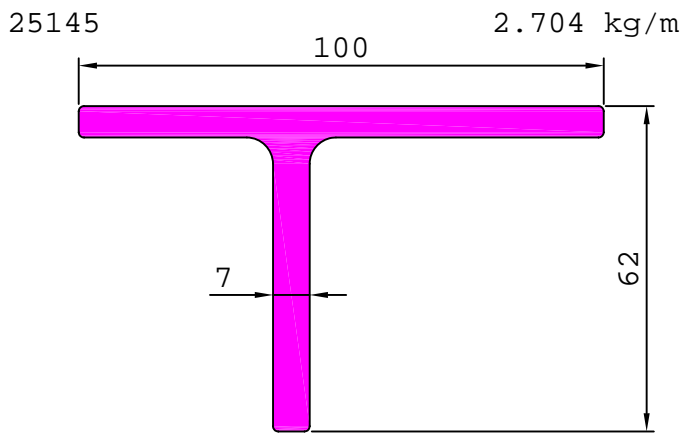

INDUSTRIAL

ELECTRICALS

25167 0.940 kg/m

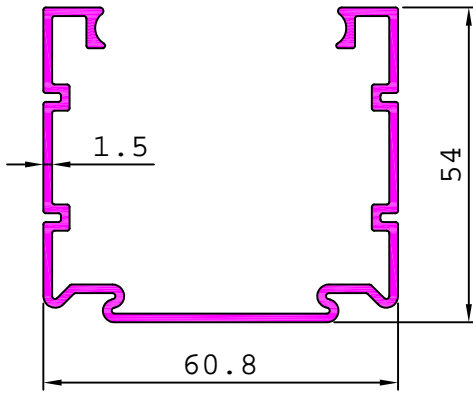

25171 0.717 kg/m

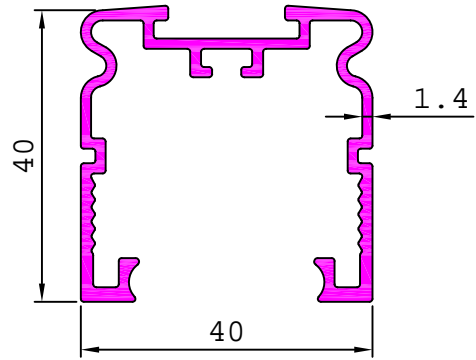

25172 1.250 kg/m

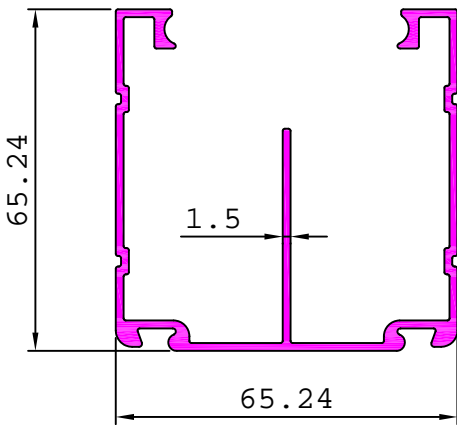

25176 1.397 kg/m

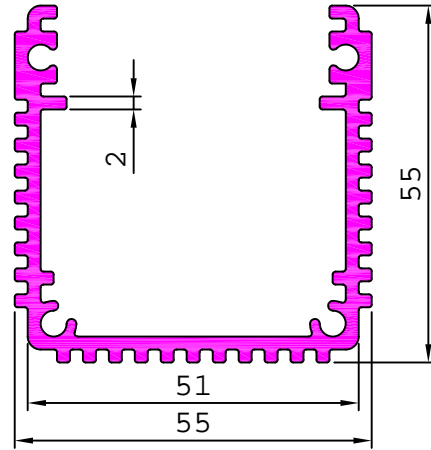

25180 0.726 kg/m

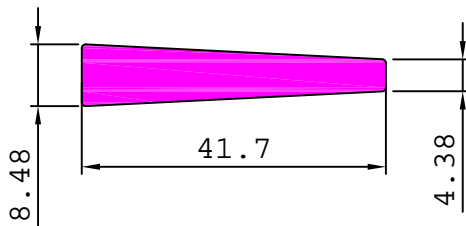

25181 0.409 kg/m

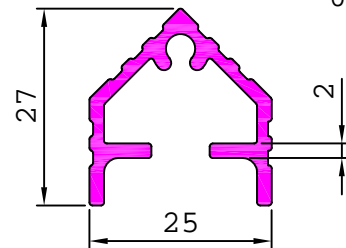

25182 0.721 kg/m

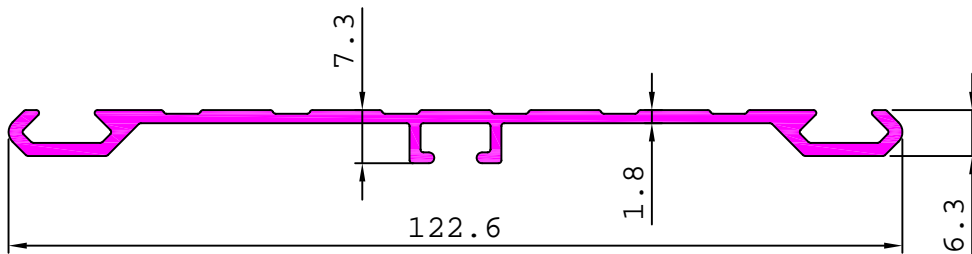

25183 0.938 kg/m

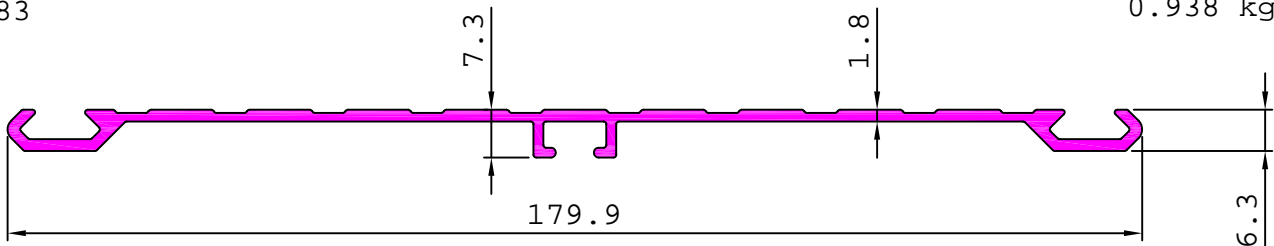

INDUSTRIAL

ELECTRICALS

25184

0.695 kg/m

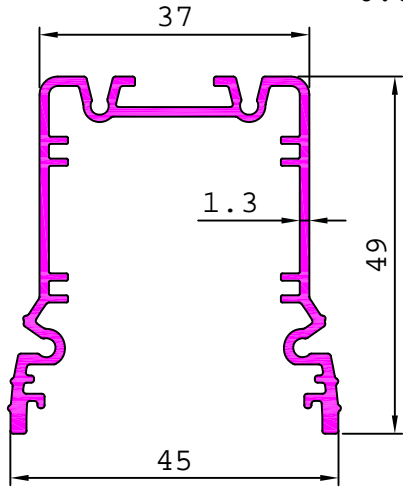

25185

1.514 kg/m

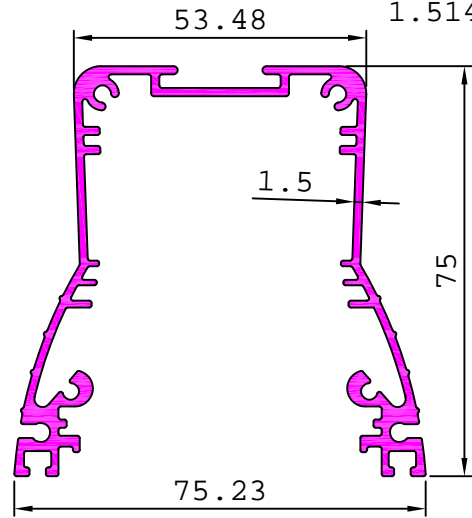

25186

2.661 kg/m

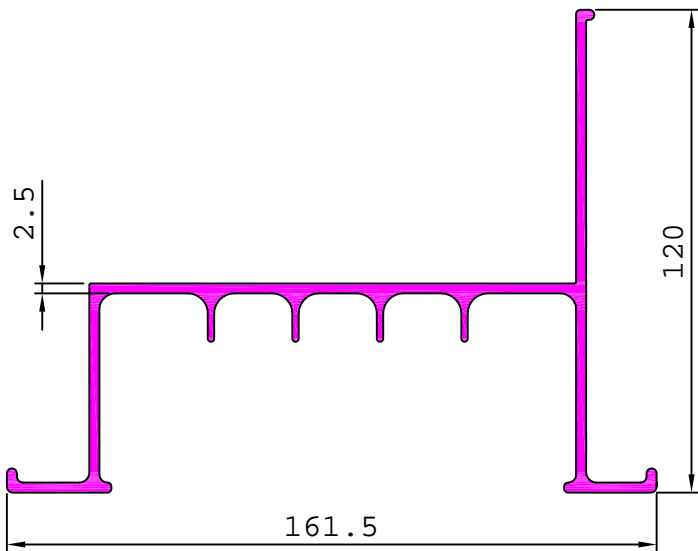

25187

0.890 kg/m

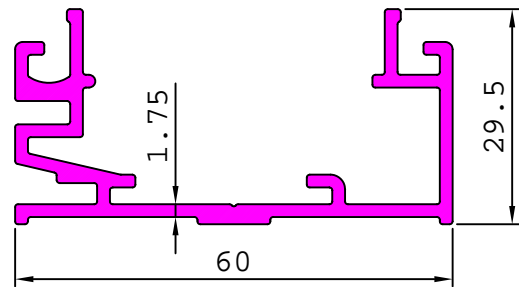

25188

0.846 kg/m

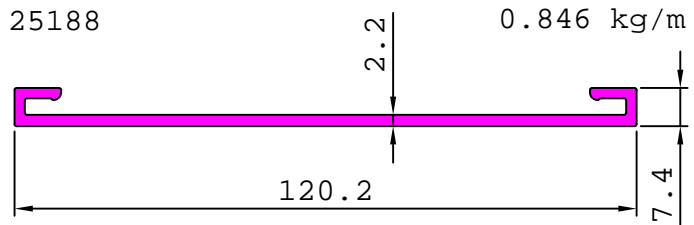

25189

2.053 kg/m



25191

0.822 kg/m

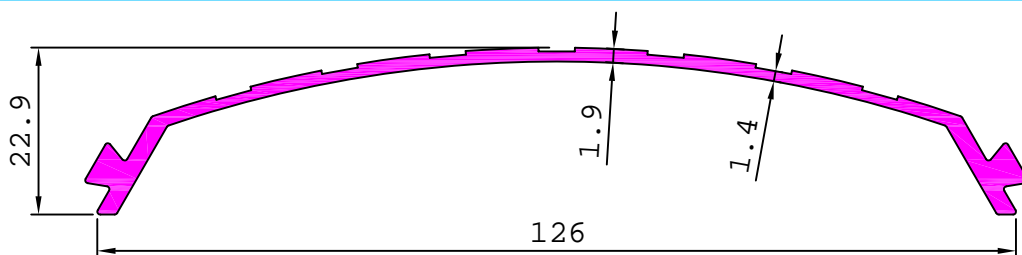

INDUSTRIAL

ELECTRICALS

25192

1.007 kg/m

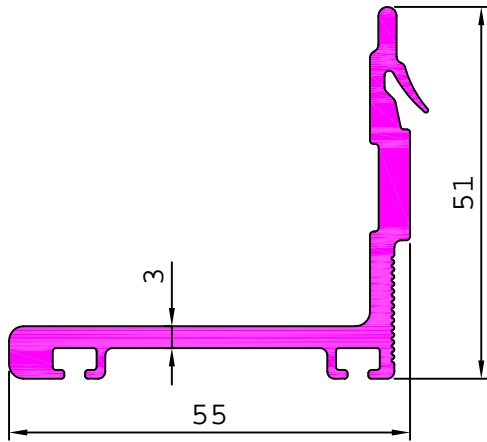

25198

0.865 kg/m

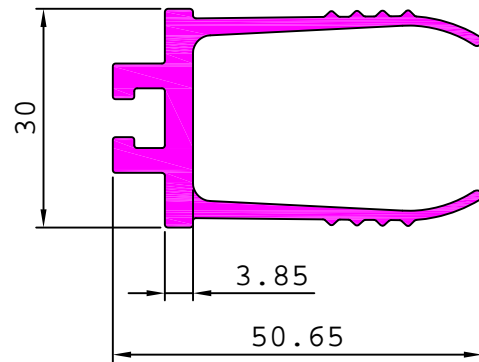

25196

0.725 kg/m

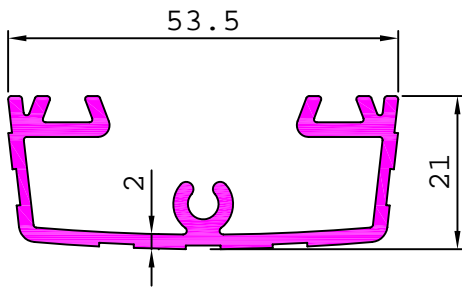

25197

0.257 kg/m

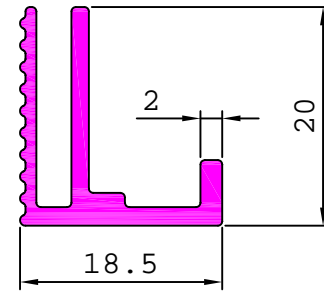

25199

0.435 kg/m

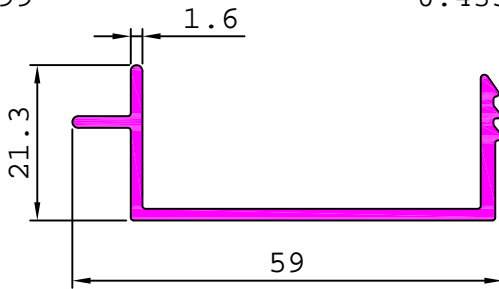

25203

0.418 kg/m

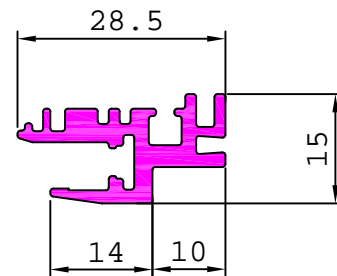

25200

2.911 kg/m

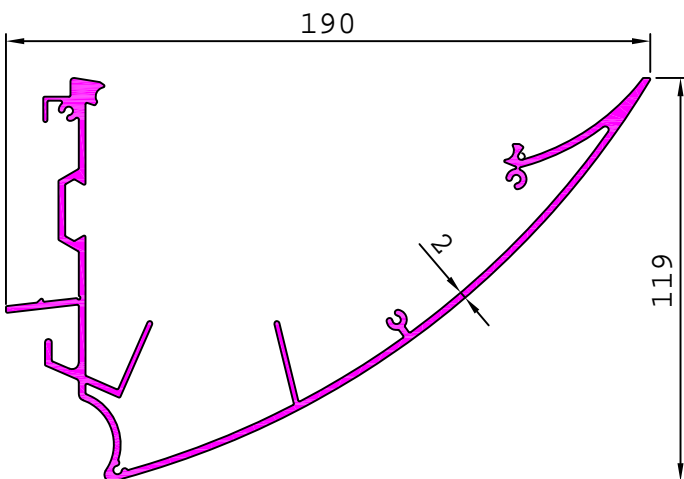

25204

0.117 kg/m

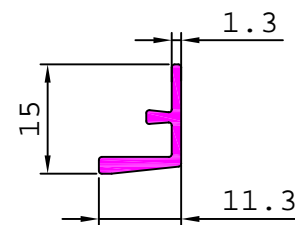

25207

0.185 kg/m

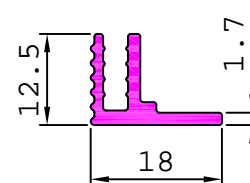

INDUSTRIAL

ELECTRICALS

25193

7.616 kg/m

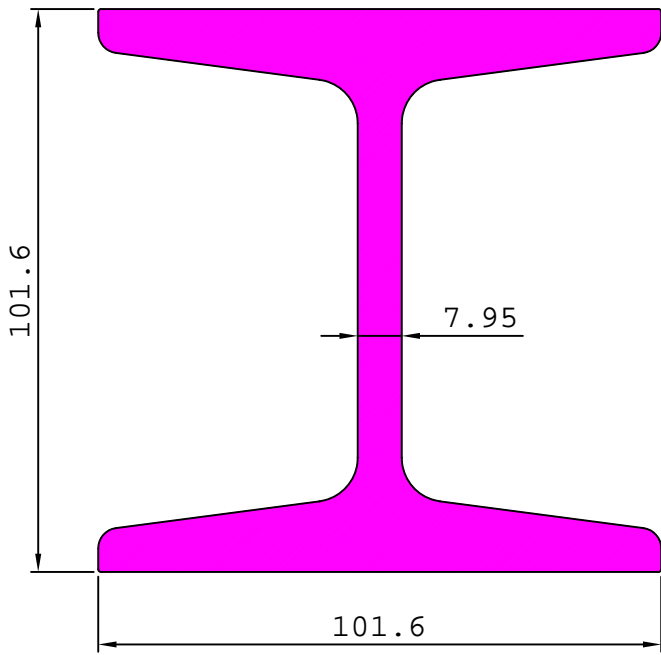

25194

8.013 kg/m

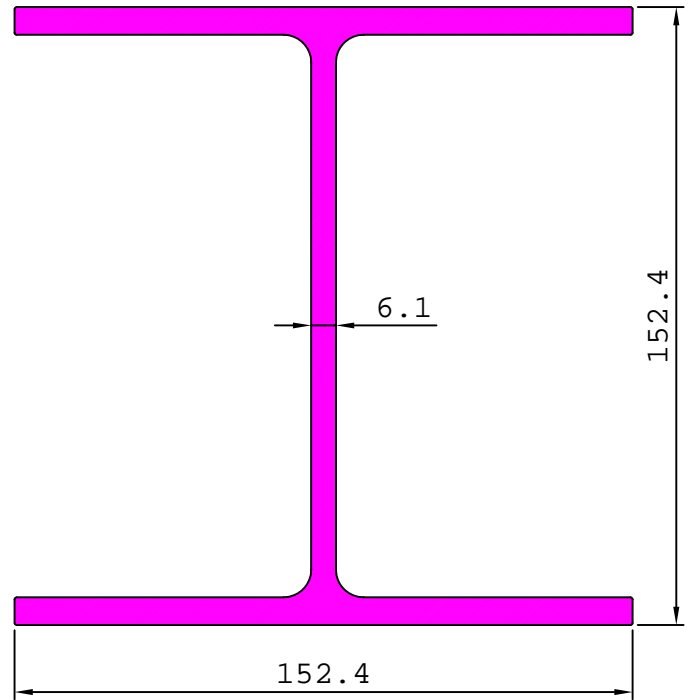

25195

14.007 kg/m

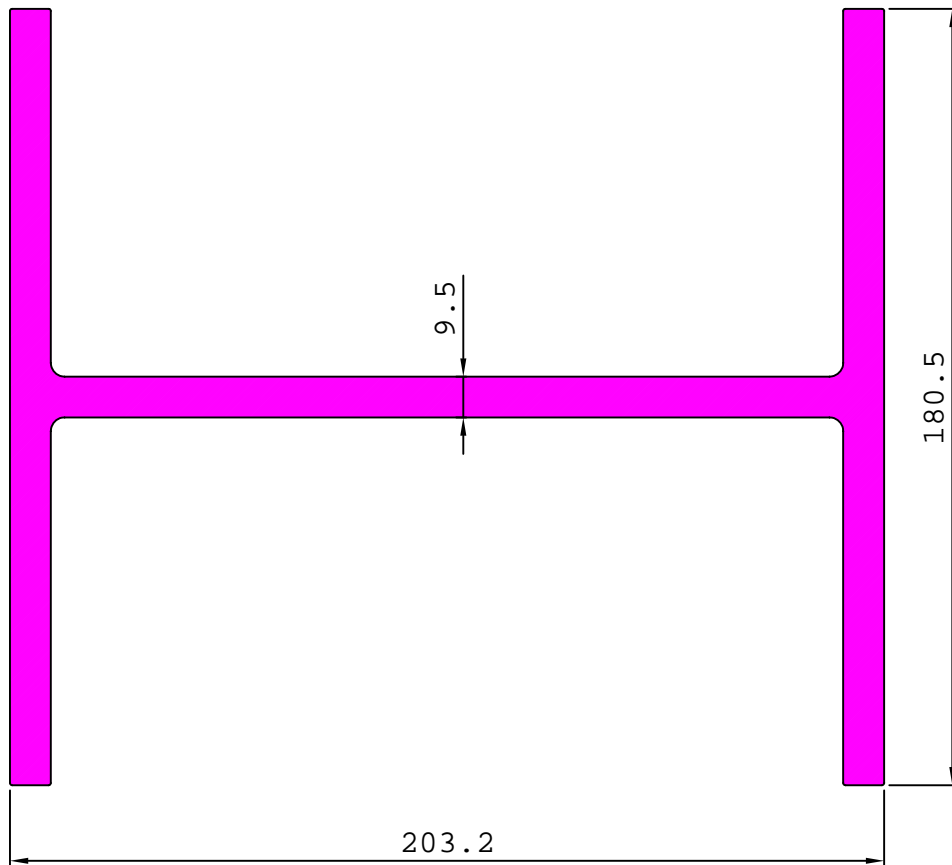

INDUSTRIAL

ELECTRICALS

25205

3.640 kg/m

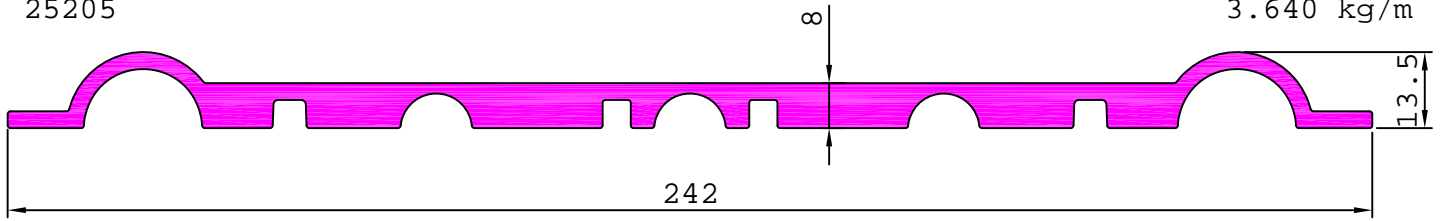

25208

0.201 kg/m

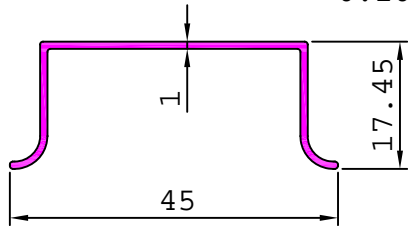

25212

0.447 kg/m

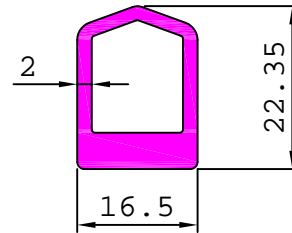

25209

0.232 kg/m

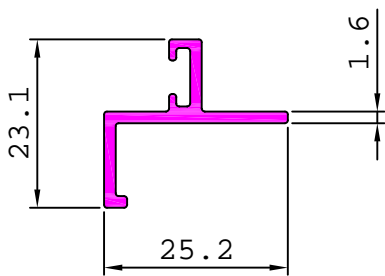

25210

0.103 kg/m

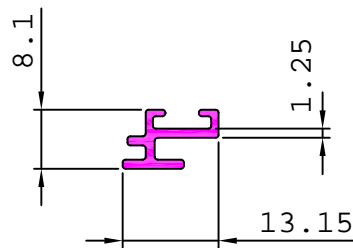

25211

0.087 kg/m

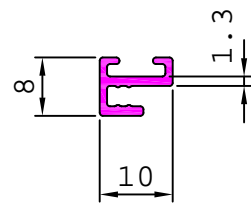

25213

0.824 kg/m

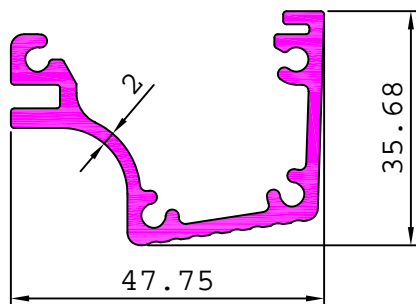

25216

3.273 kg/m

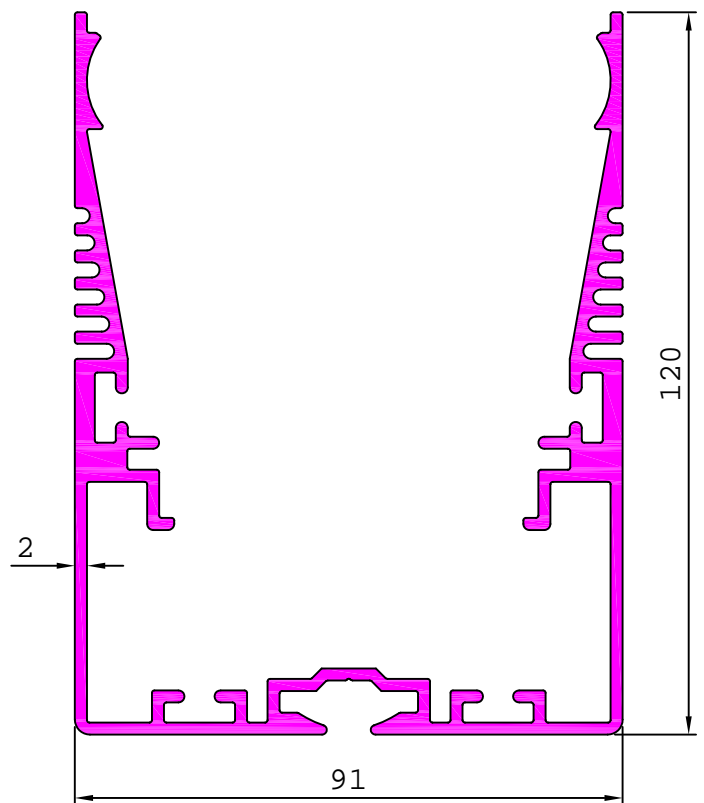

25217

3.379 kg/m

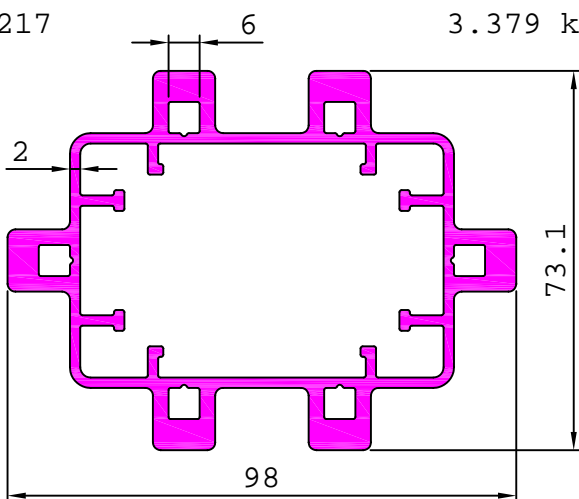

INDUSTRIAL

ELECTRICALS

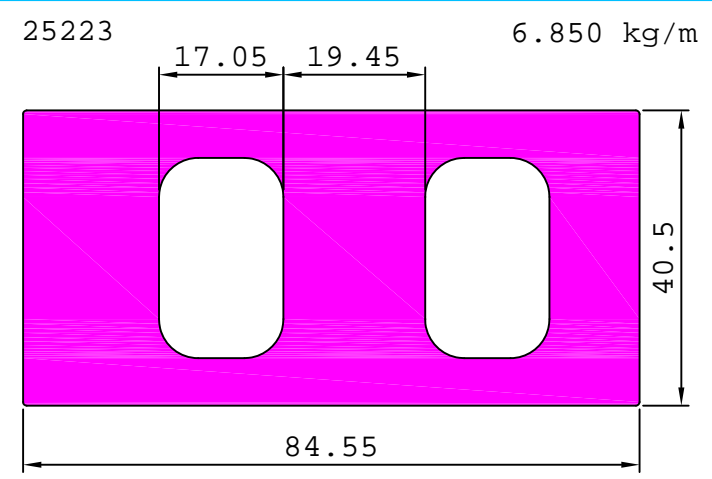
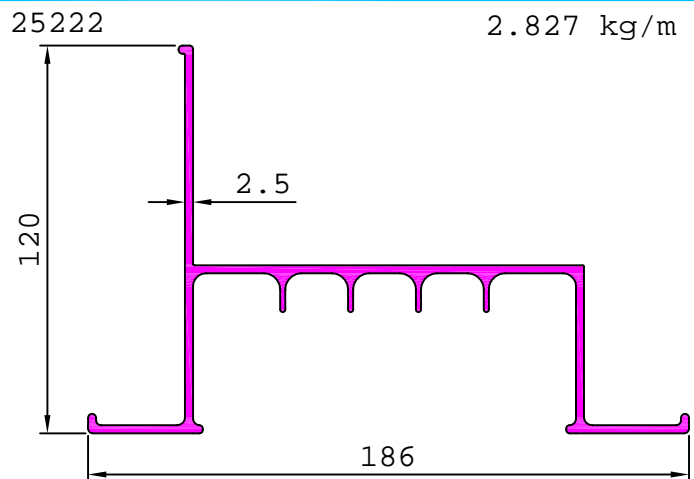
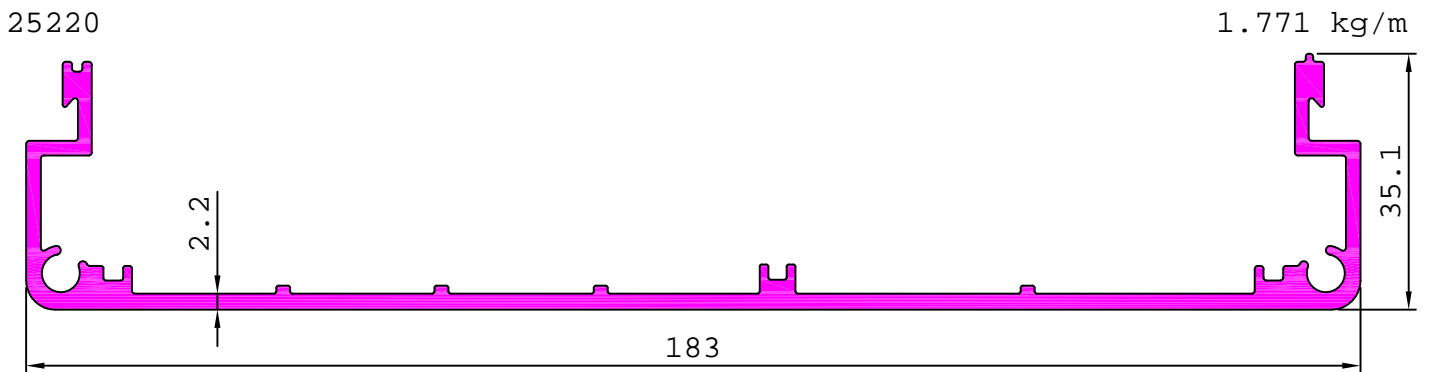
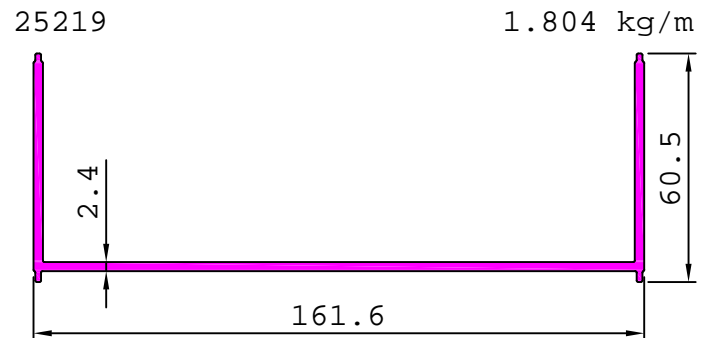
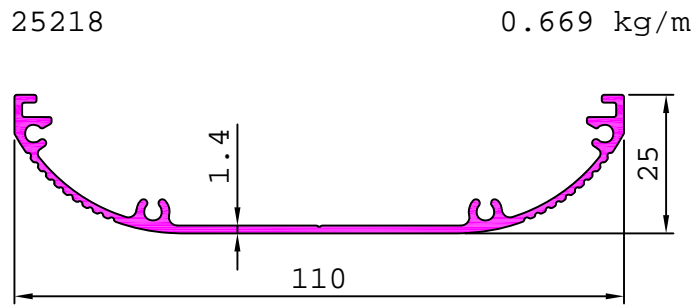
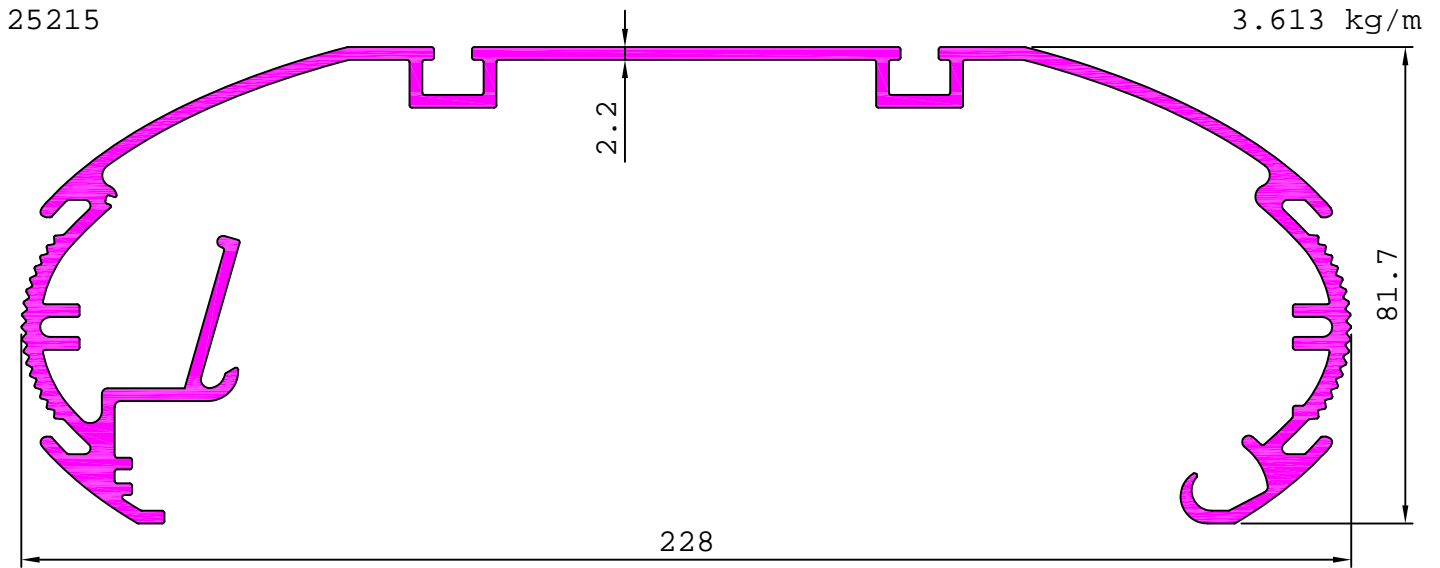

INDUSTRIAL

ELECTRICALS

25221

2.244 kg/m

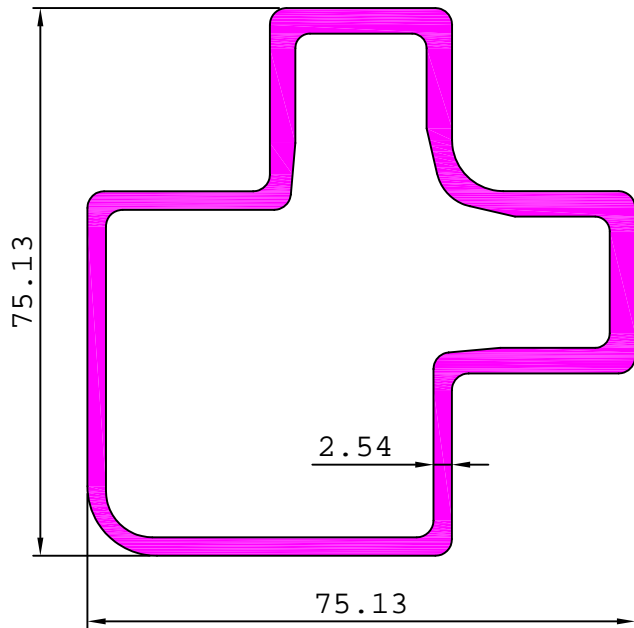

25243

0.630 kg/m

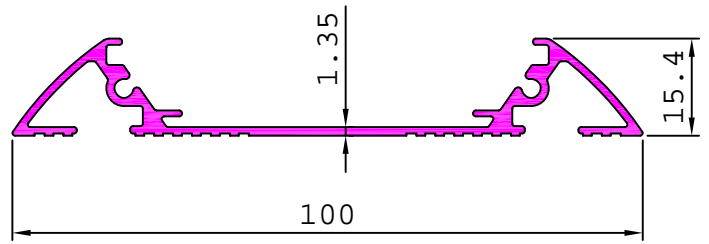

25244

1.350 kg/m

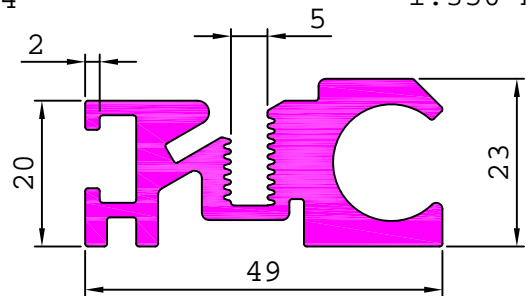

25241

1.539 kg/m

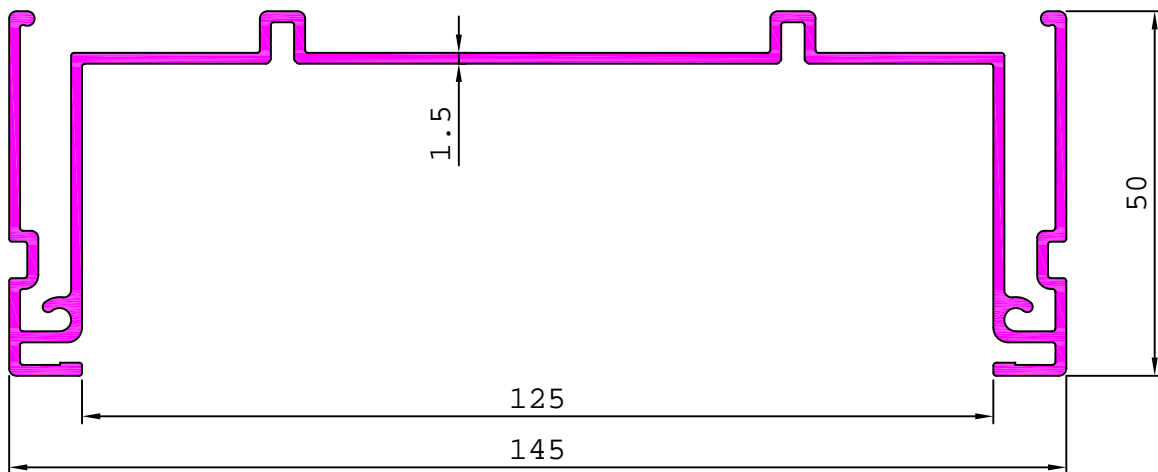

25242

1.341 kg/m

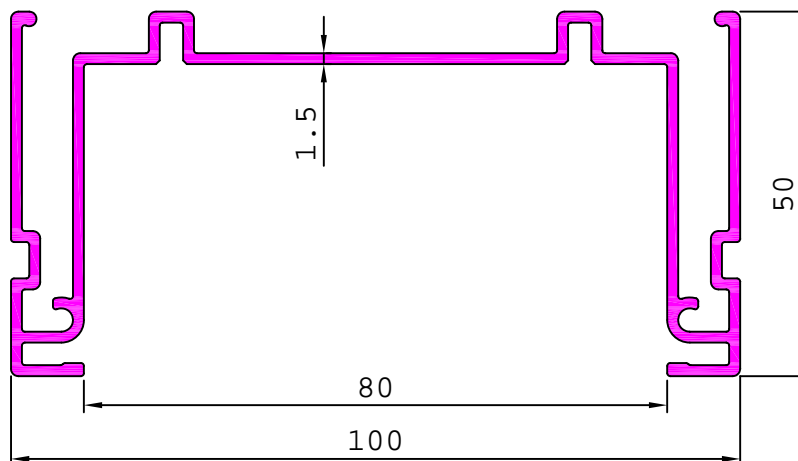

INDUSTRIAL

ELECTRICALS

25097

0.560 kg/m

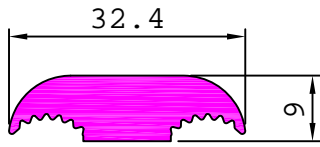

25098

1.341 kg/m

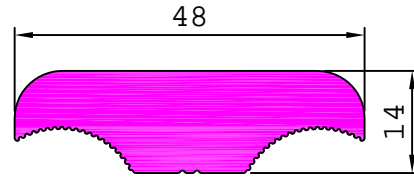

25099

0.881 kg/m

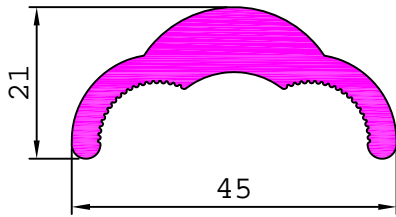

25100

2.325 kg/m

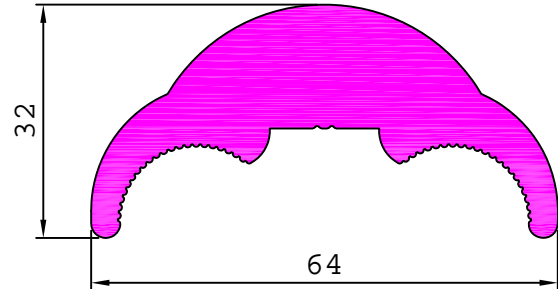

S4330

0.429 kg/m

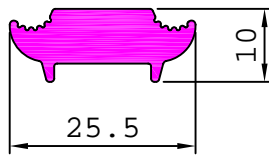

S4331

0.614 kg/m

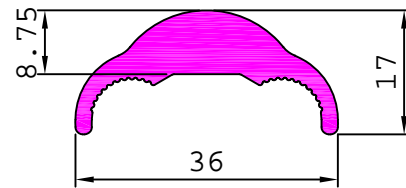

S4362

1.614 kg/m

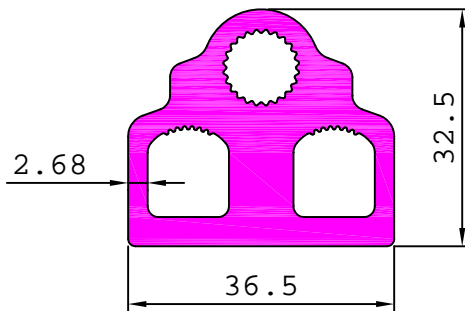

S4363

1.710 kg/m

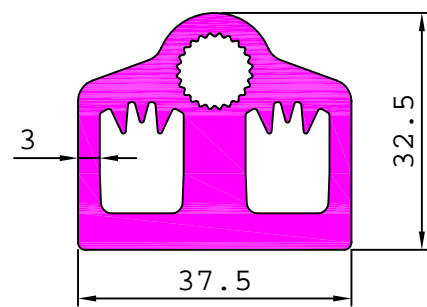

S5208

0.727 kg/m

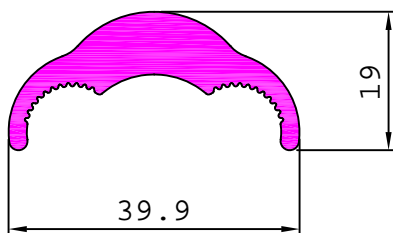

S5209

0.488 kg/m

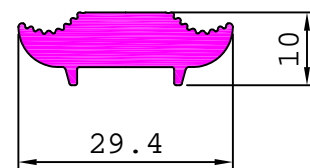

INDUSTRIAL

ELECTRICALS

25245

2.879 kg/m

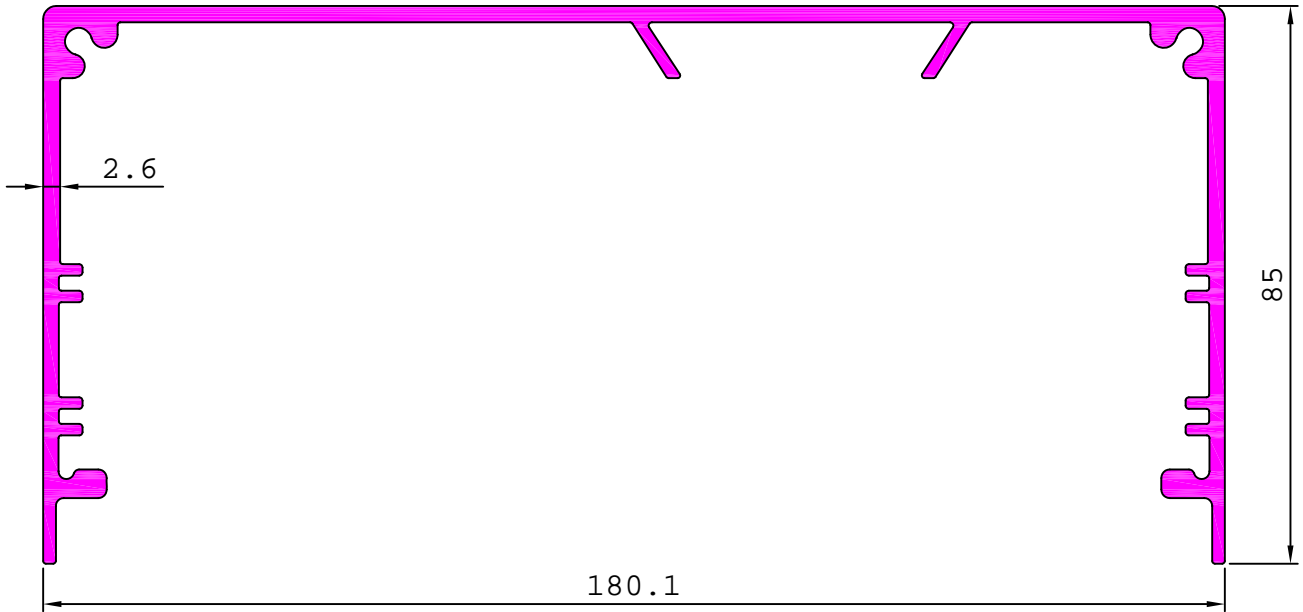

25246

7.787 kg/m

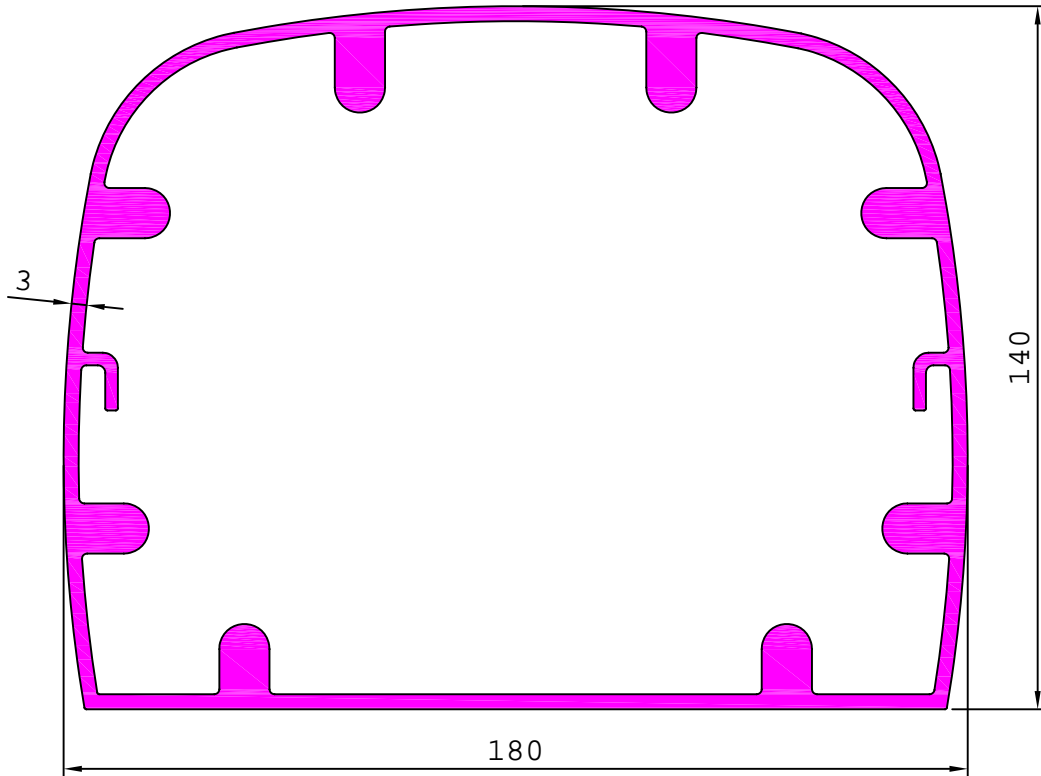

25247

0.437 kg/m

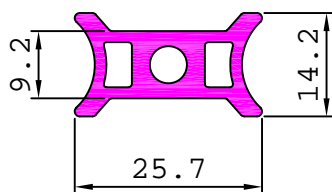

25250

0.248 kg/m

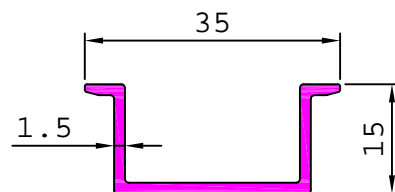

INDUSTRIAL

ELECTRICALS

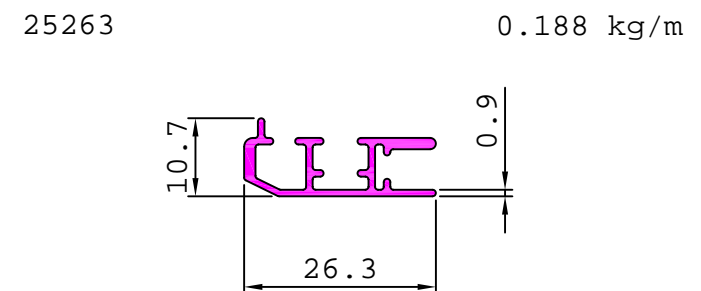
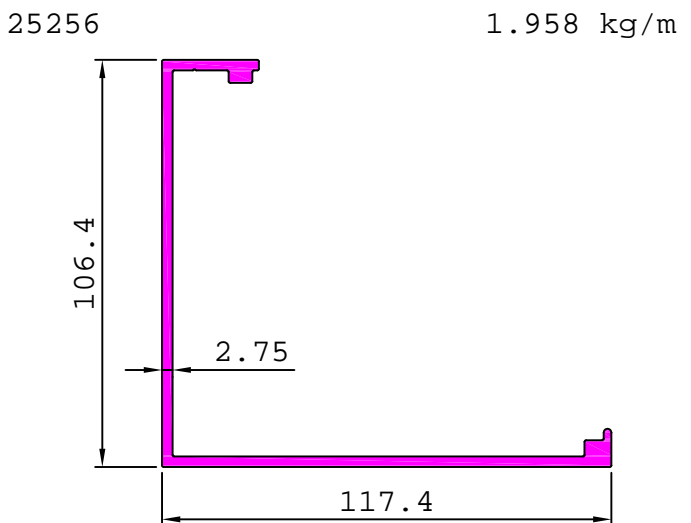
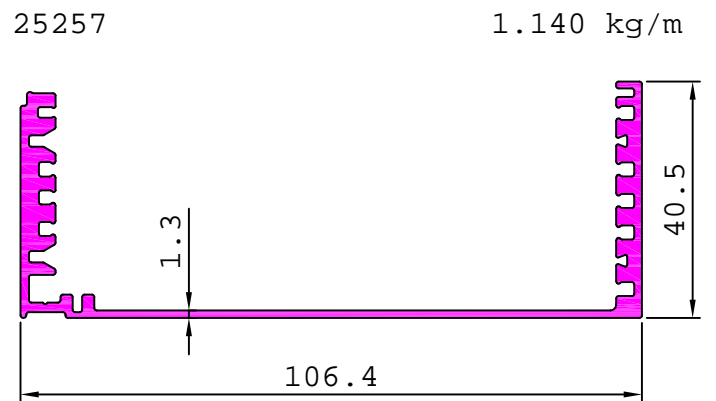
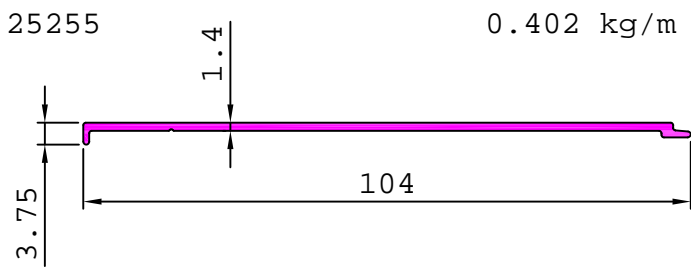
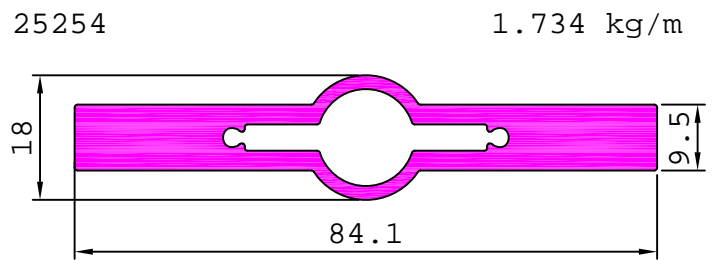
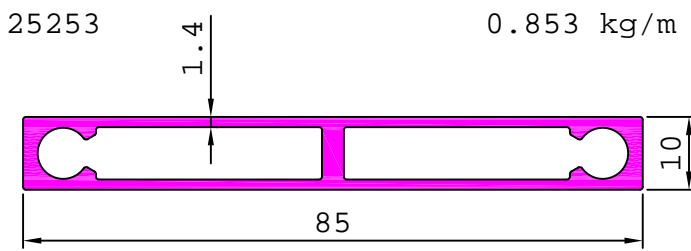
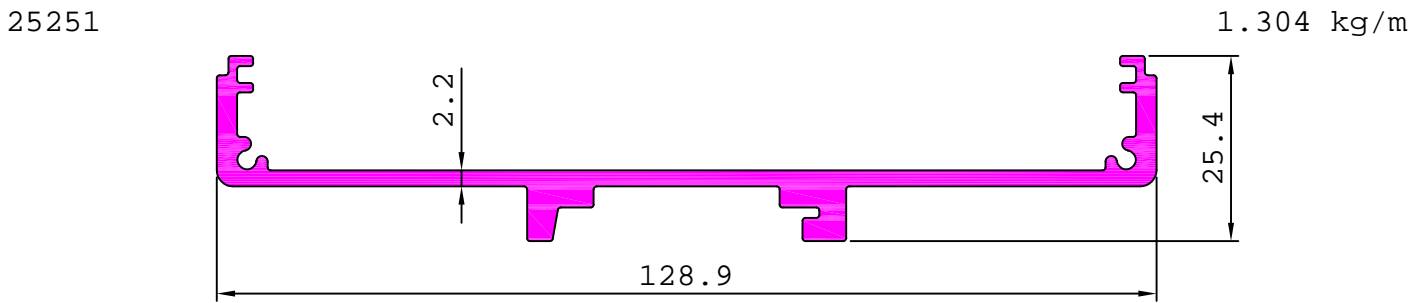
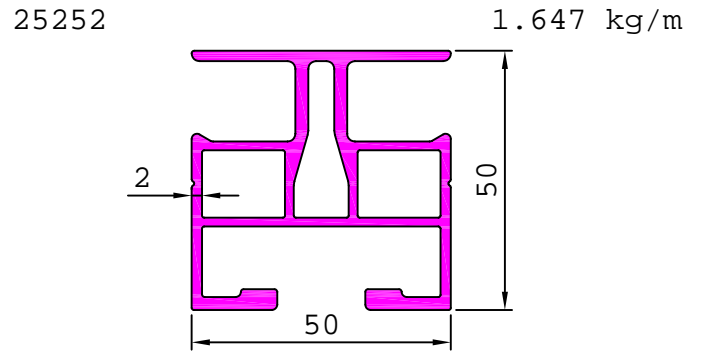
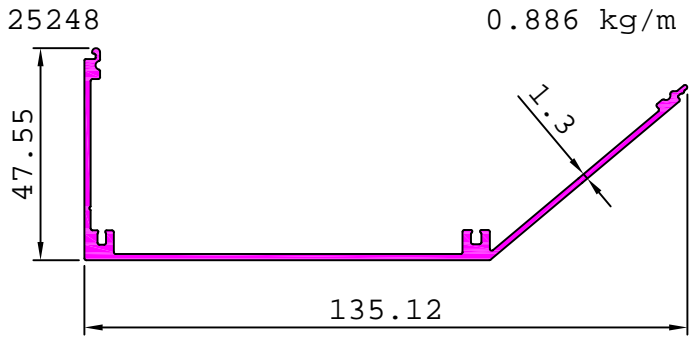

INDUSTRIAL

ELECTRICALS

25258

1.204 kg/m

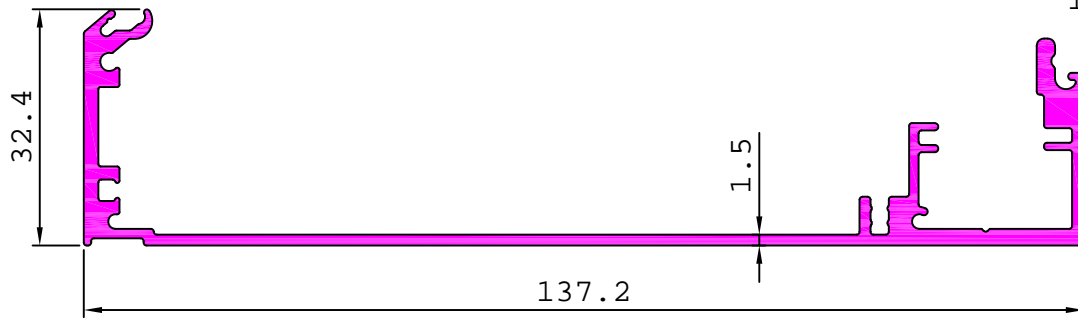

25264

5.955 kg/m

25267

1.498 kg/m

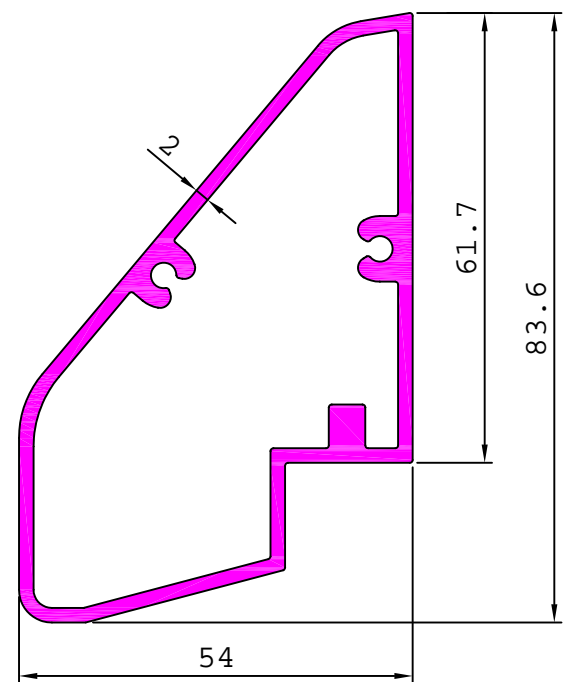
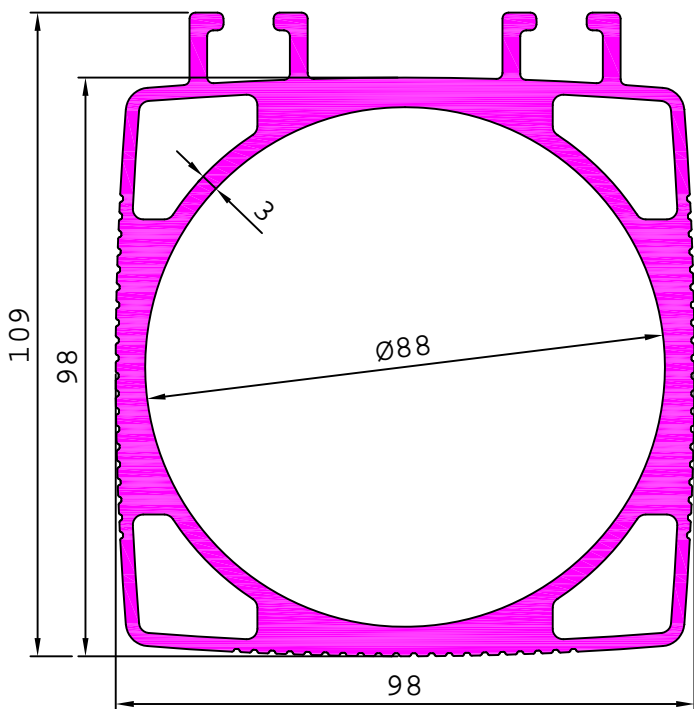

25265

3.467 kg/m

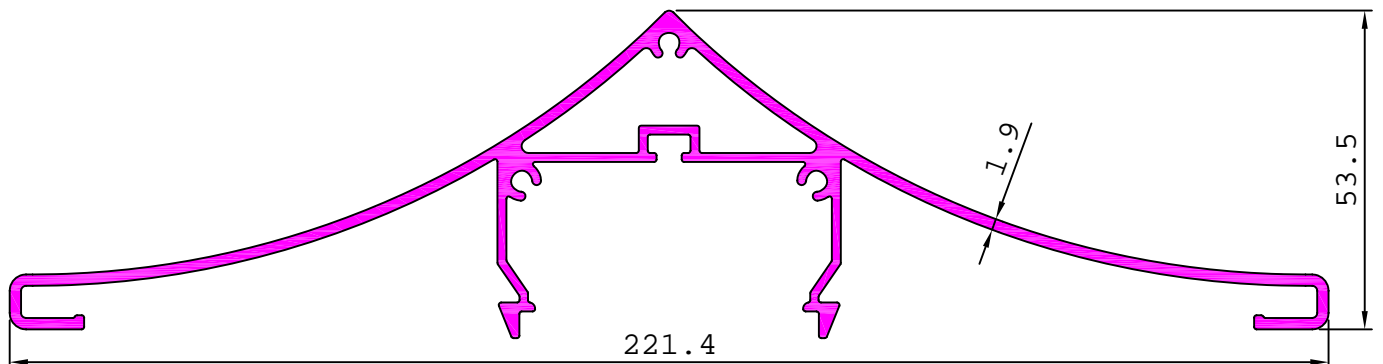

25269

6.427 kg/m

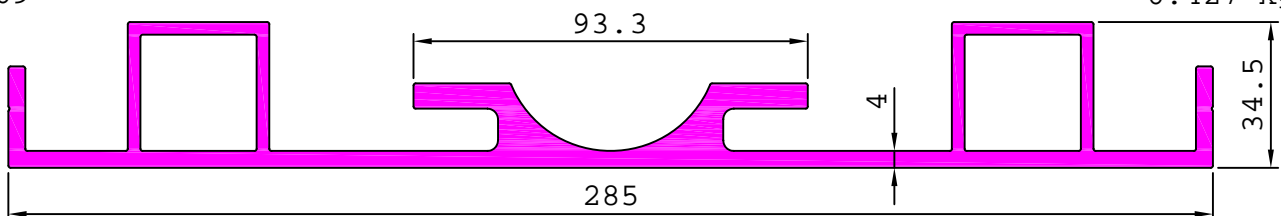

INDUSTRIAL

ELECTRICALS

25266

0.302 kg/m

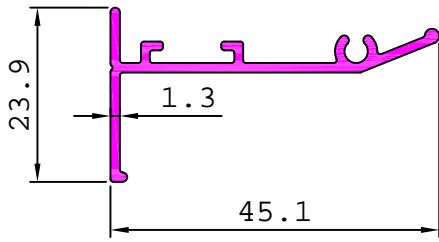

25268

0.400 kg/m

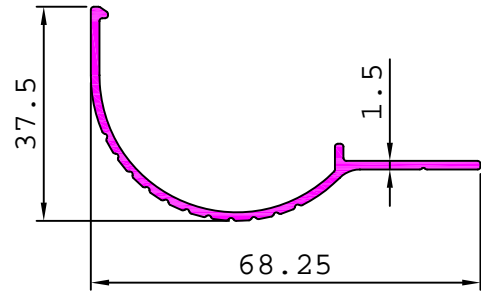

25270

2.427 kg/m

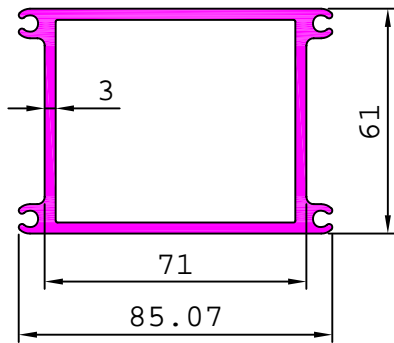

25275

1.424 kg/m

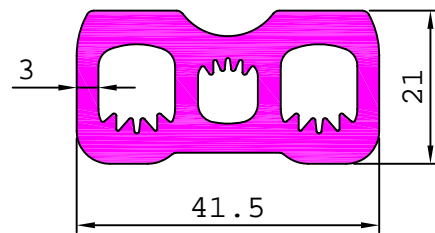

25274

4.606 kg/m

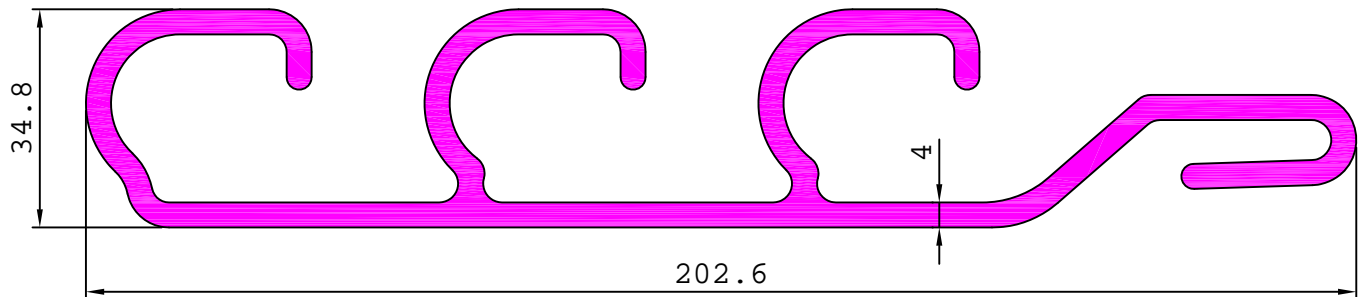

25278

1.193 kg/m

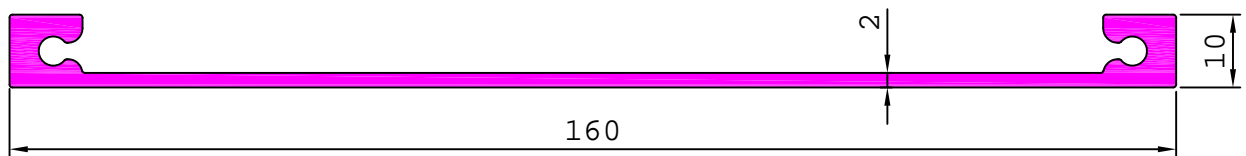

25279

2.136 kg/m

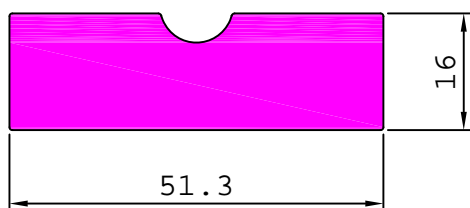

25280

0.293 kg/m

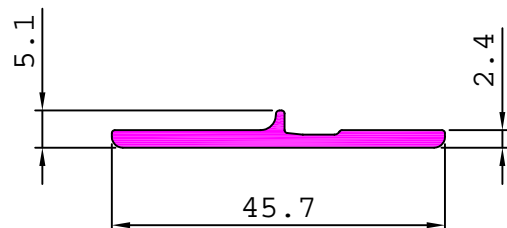

INDUSTRIAL

ELECTRICALS

S4918

3.143 kg/m

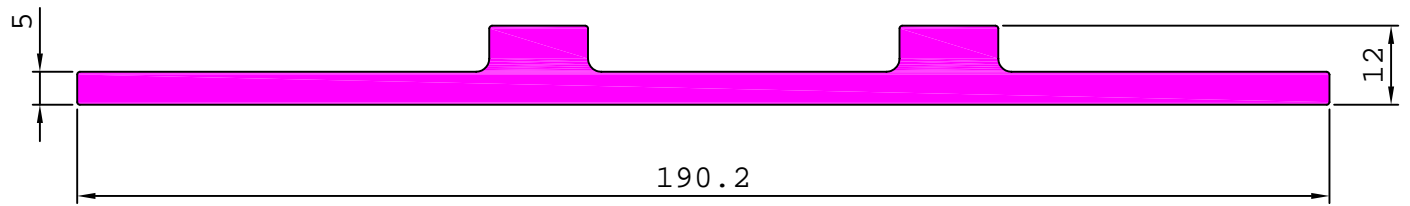

25283

2.748 kg/m

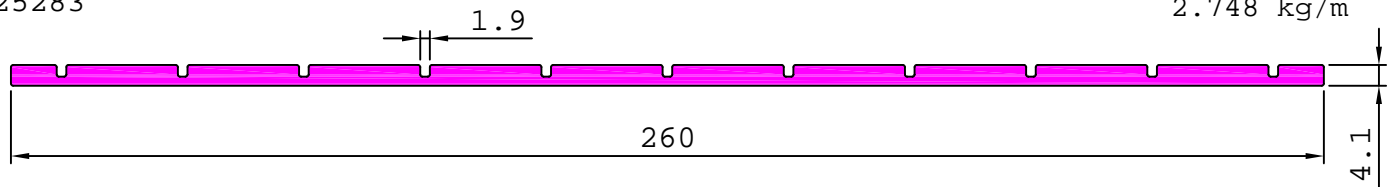

25284

20.074 kg/m

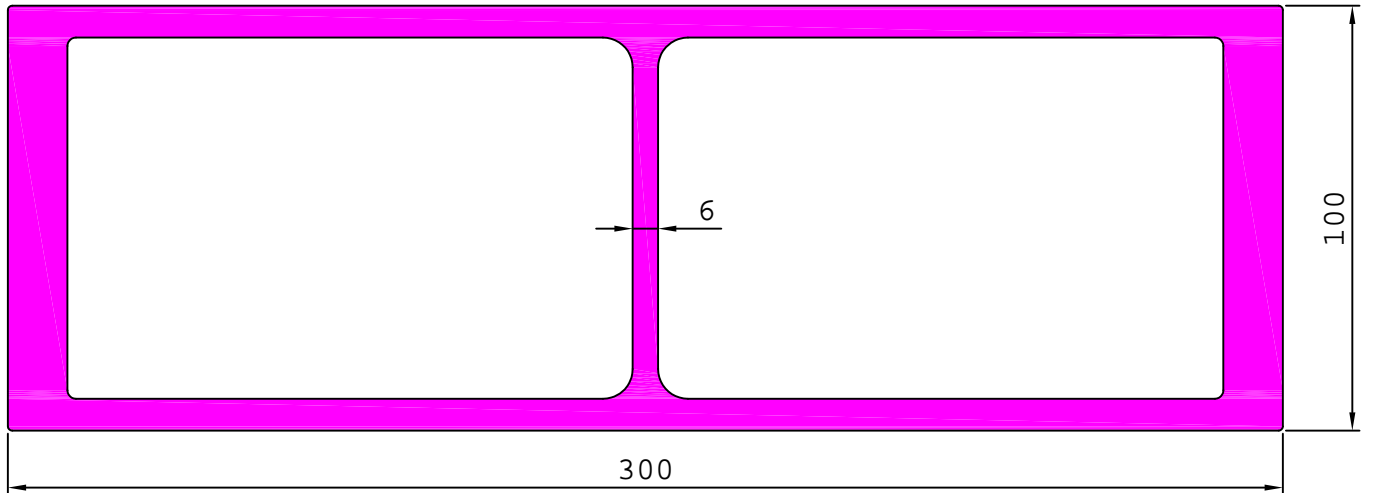

25285

10.729 kg/m

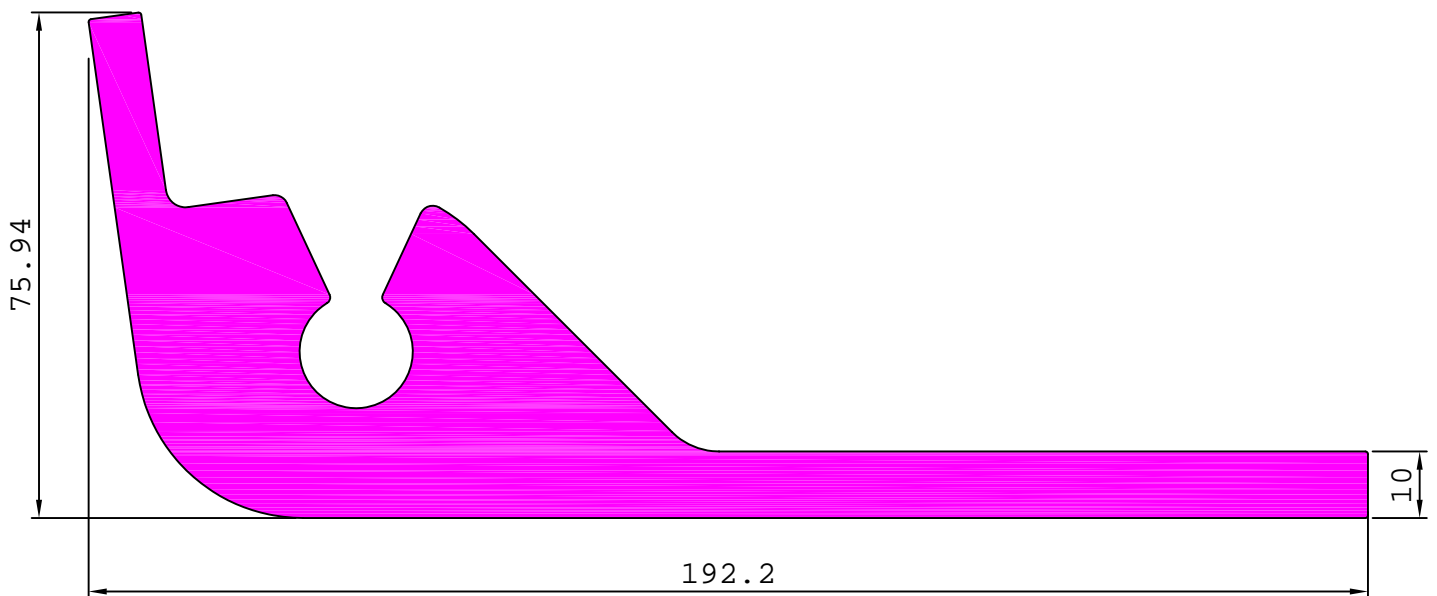

INDUSTRIAL

ELECTRICALS

25286

10.742 kg/m

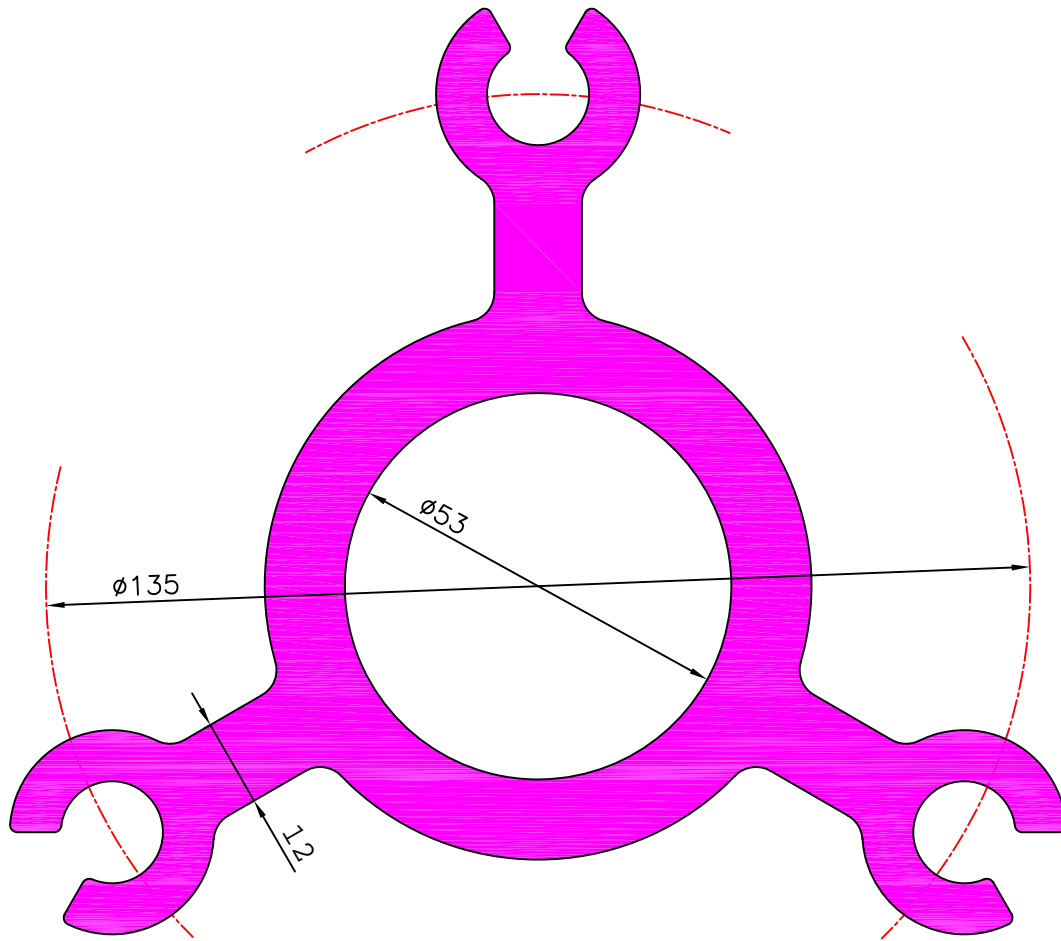

25288

6.281 kg/m

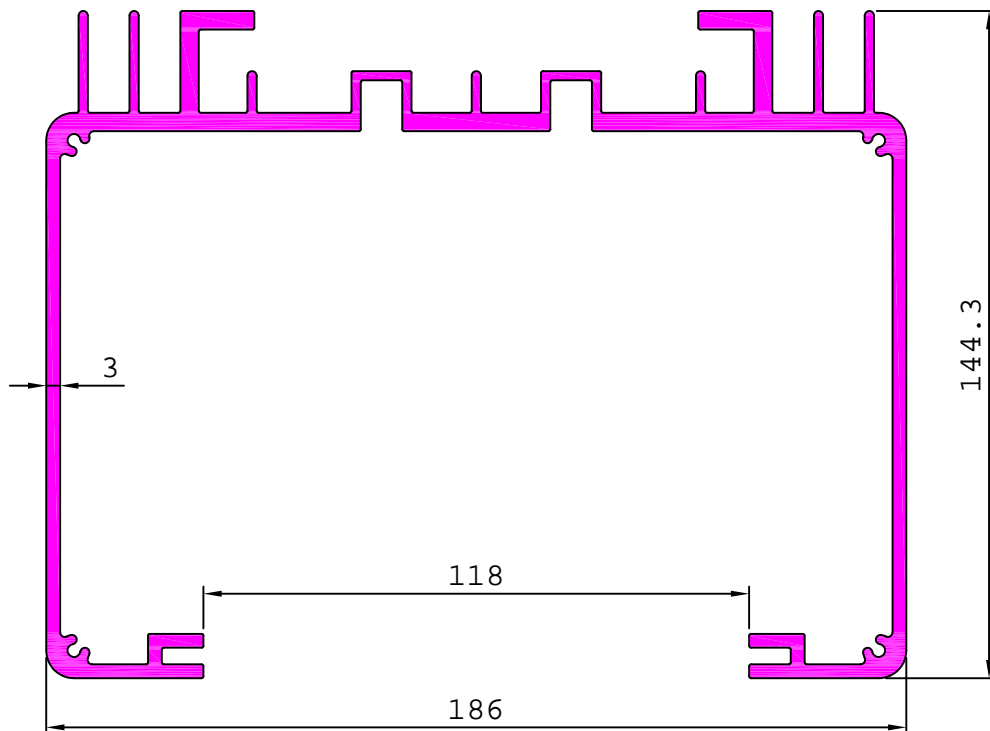

INDUSTRIAL

ELECTRICALS

25287

19.981 kg/m

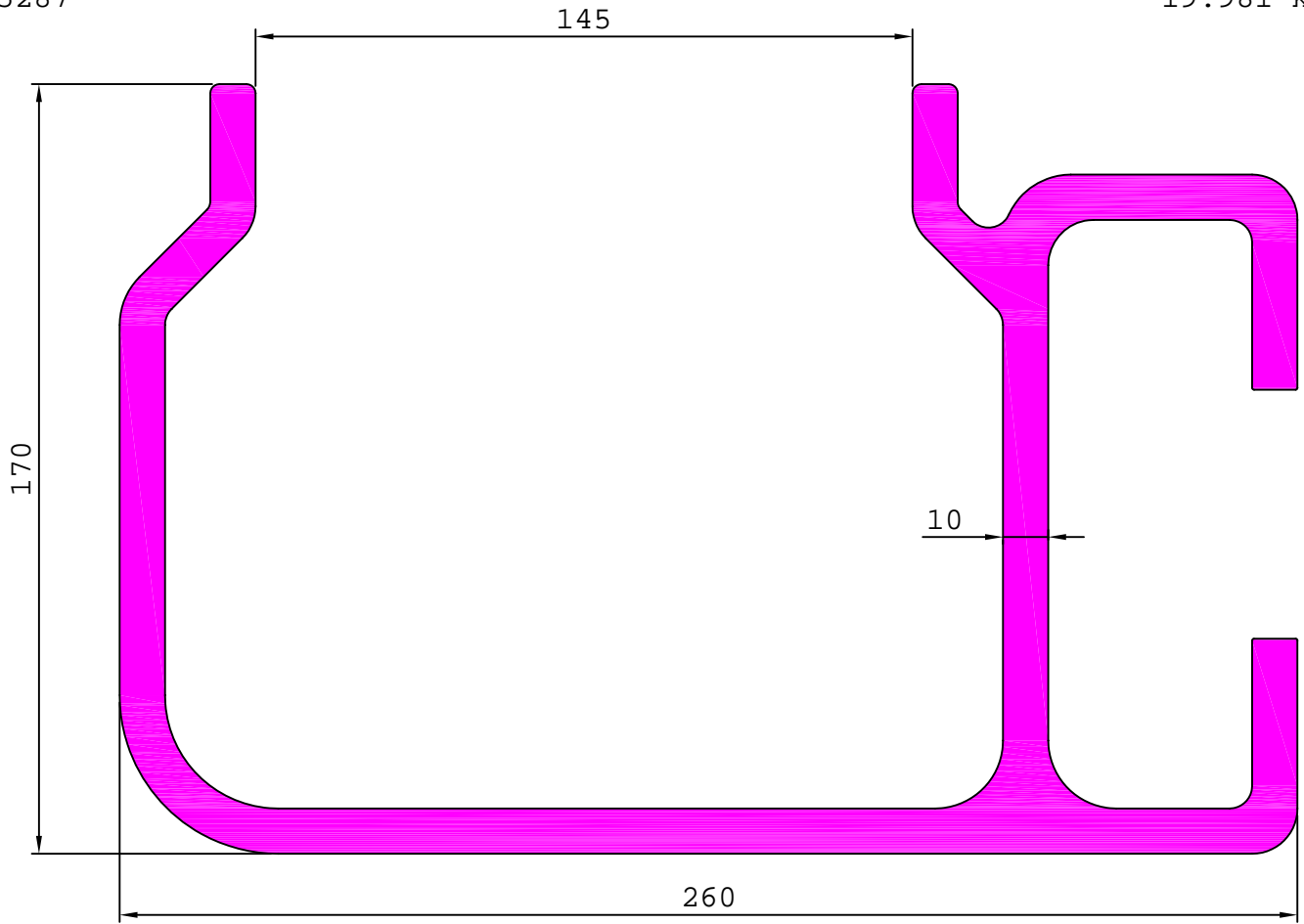

25290 0.307 kg/m

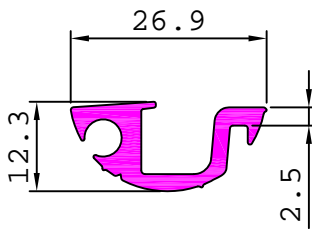

25294 0.250 kg/m

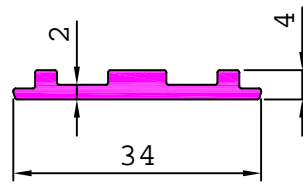

25296 0.068 kg/m

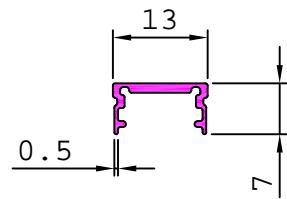

25291

5.023 kg/m

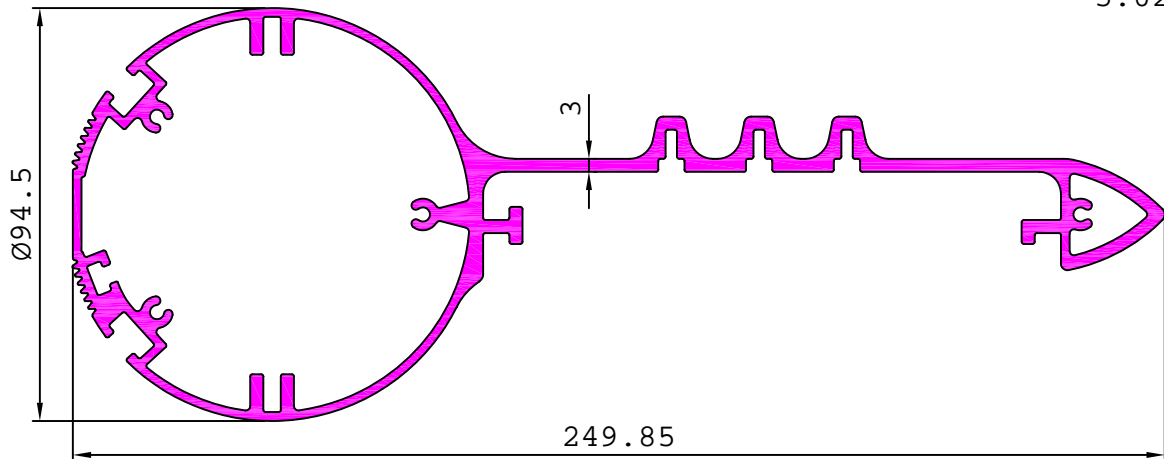

INDUSTRIAL

ELECTRICALS

25292

1.632 kg/m

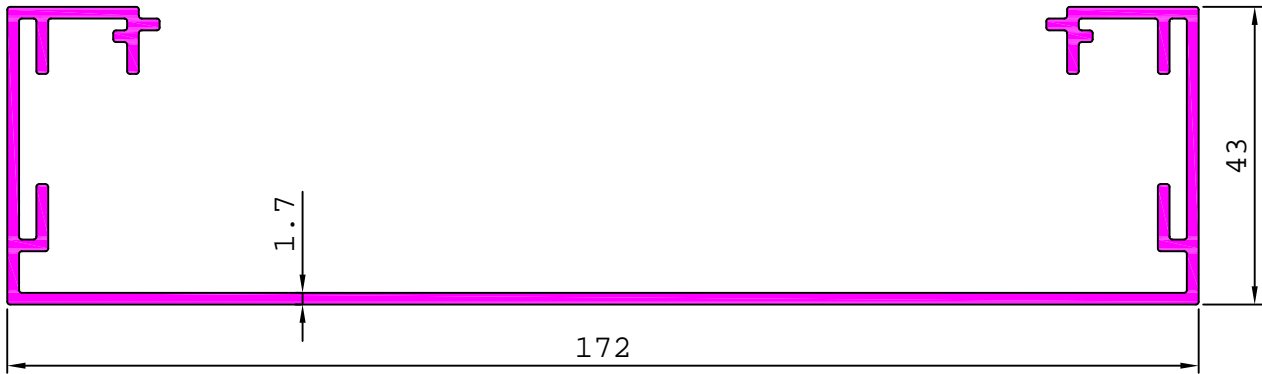

25295

0.613 kg/m

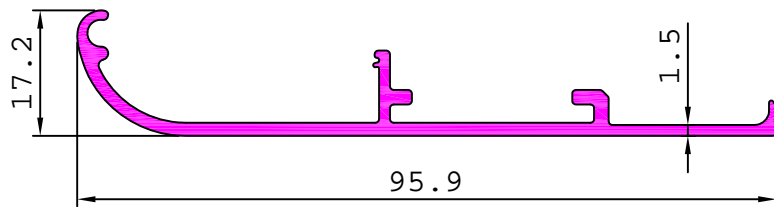

25297

0.213 kg/m

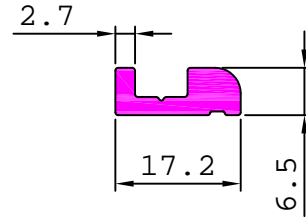

25298

0.959 kg/m

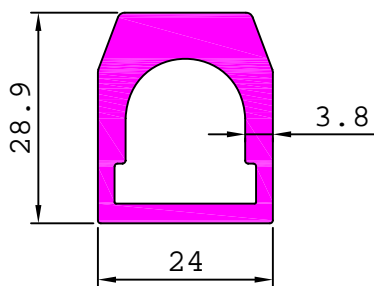

S4213

3.899 kg/m

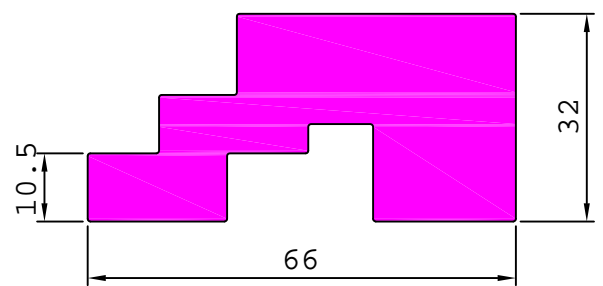

25300

3.241 kg/m

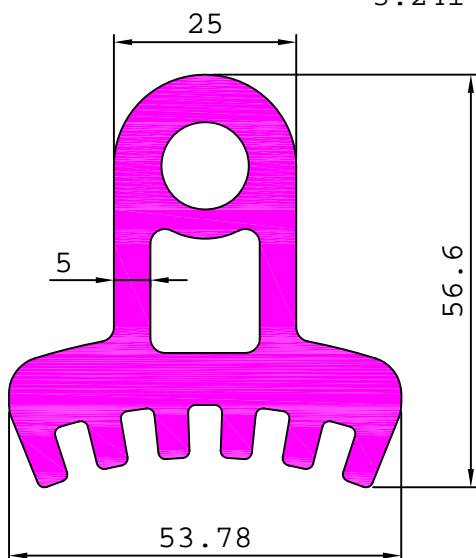

S4283

1.863 kg/m

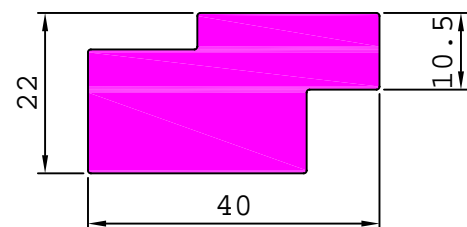

S4379

0.765 kg/m

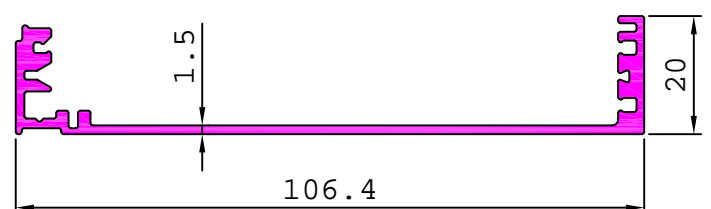

INDUSTRIAL

ELECTRICALS

S4405 0.173 kg/m

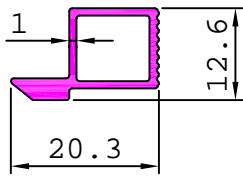

S4436 0.116 kg/m

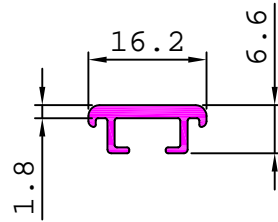

25289 0.206 kg/m

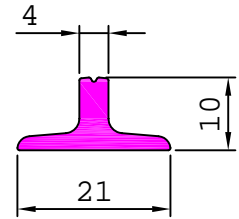

S4430 0.276 kg/m

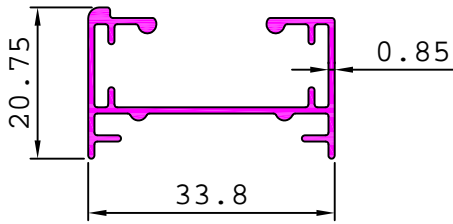

S4414 0.365 kg/m

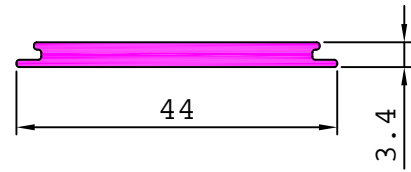

S4437 0.253 kg/m

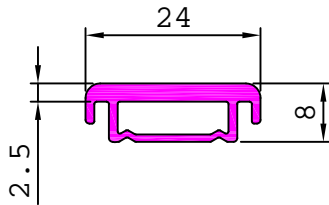

S4463 1.317 kg/m



S4495 5.879 kg/m

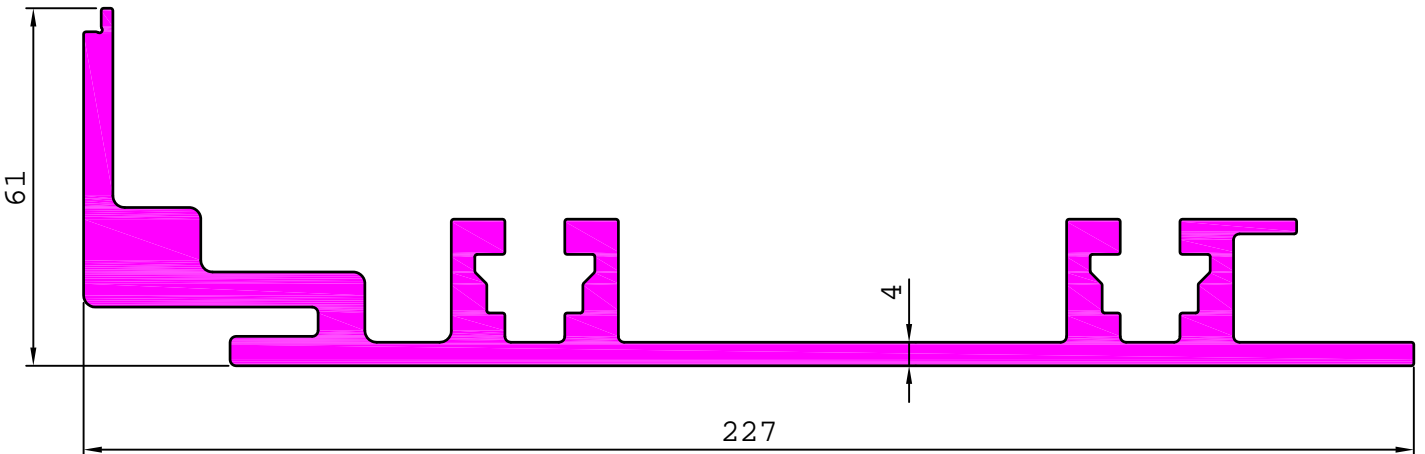

S4496 6.470 kg/m

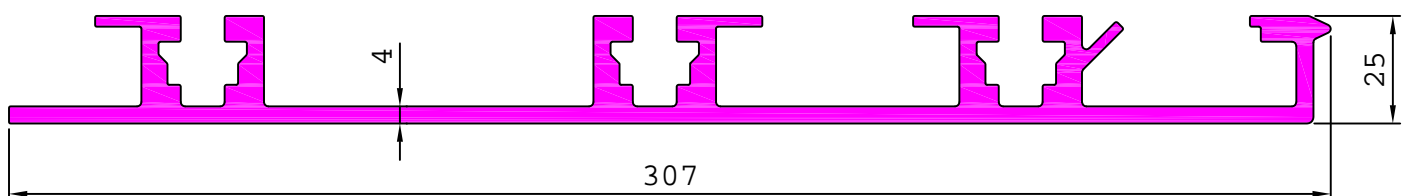

INDUSTRIAL

ELECTRICALS

S4532

1.725 kg/m

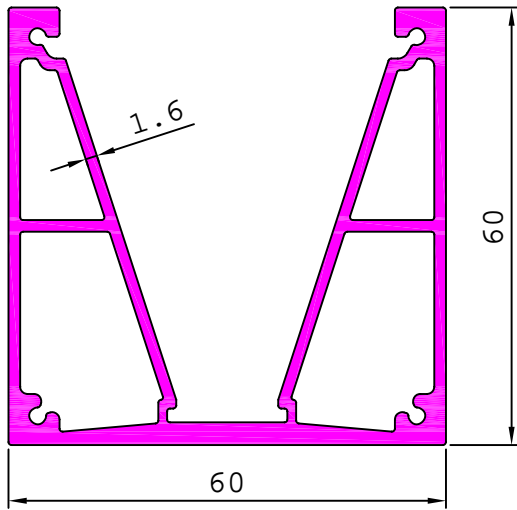

S4549

0.491 kg/m

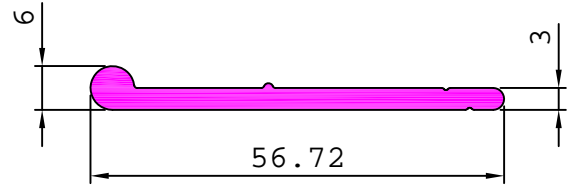

S4717

0.566 kg/m

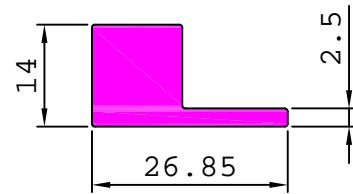

S4550

0.941 kg/m

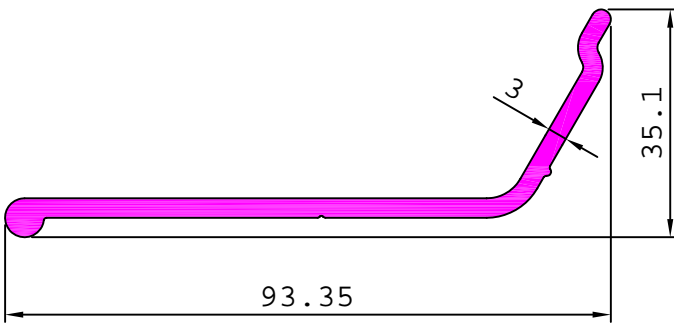

S4787

5.274 kg/m

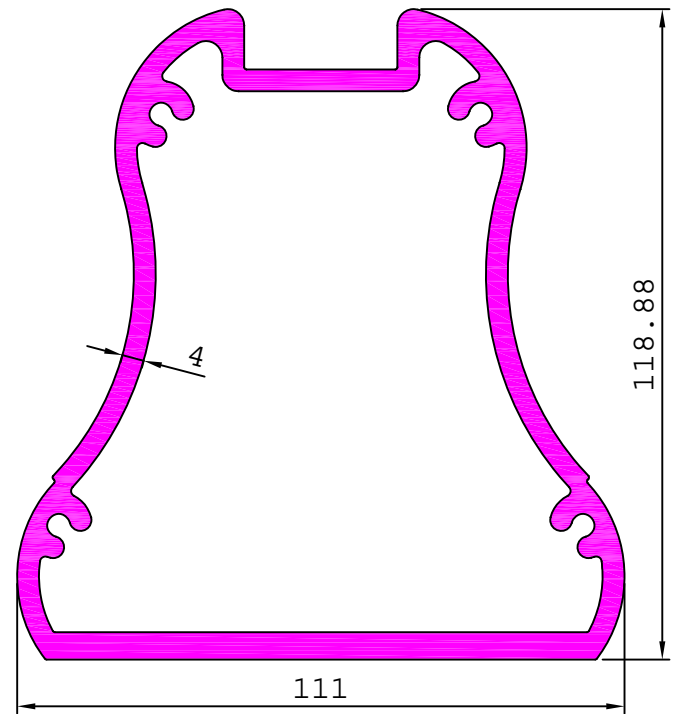

S4760

4.078 kg/m

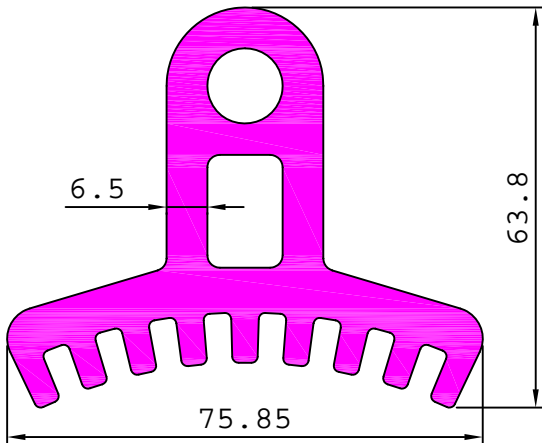

S4816

0.470 kg/m

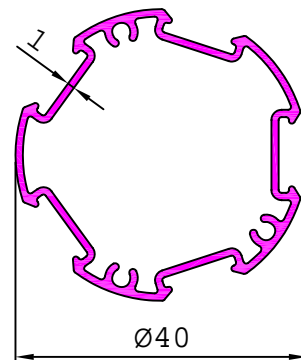

S4761

2.409 kg/m

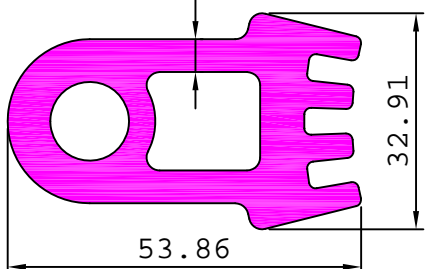

INDUSTRIAL

ELECTRICALS

S4941 1.387 kg/m

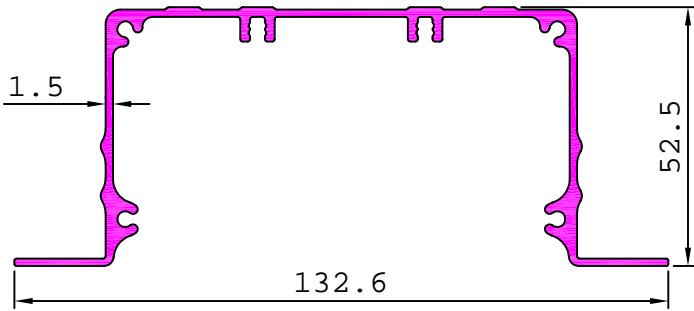

S4952 0.640 kg/m

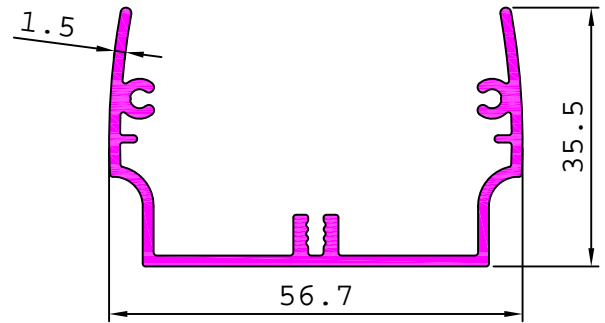

S4994 0.413 kg/m

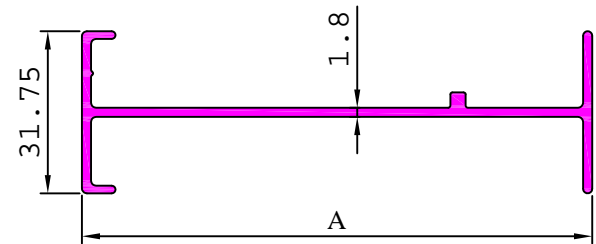
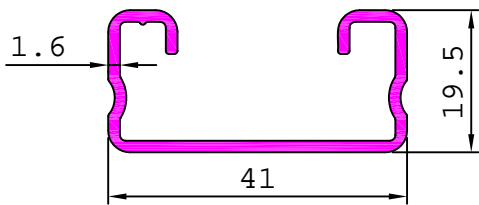

SL No	SECTION No	A	WEIGHT kg/m
1	S4993	90.00	0.792
2	S4992	100.00	0.840

S4998 0.314 kg/m

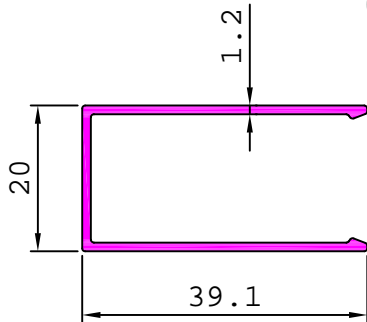

S4999 0.063 kg/m

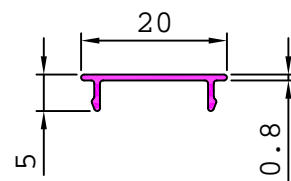

S5035 0.308 kg/m

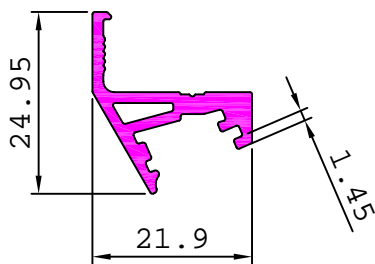

S5034 2.271 kg/m

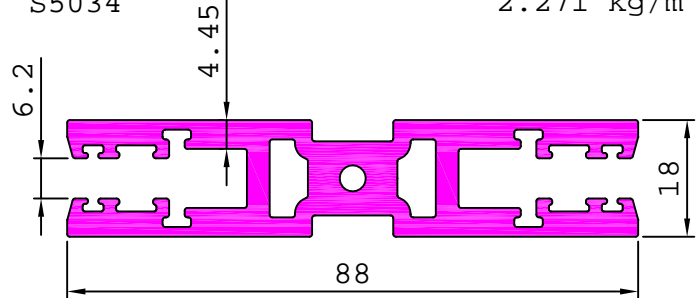

29396 3.866 kg/m

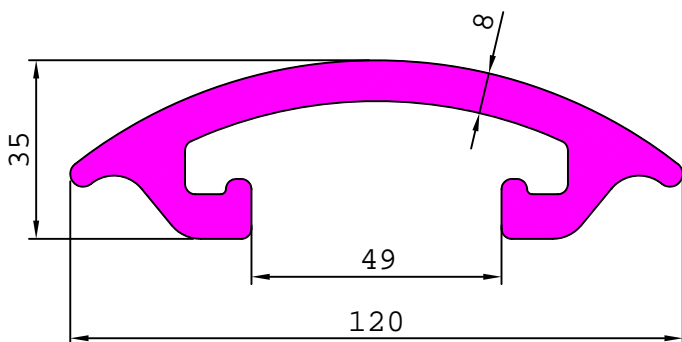

29184 1.476 kg/m

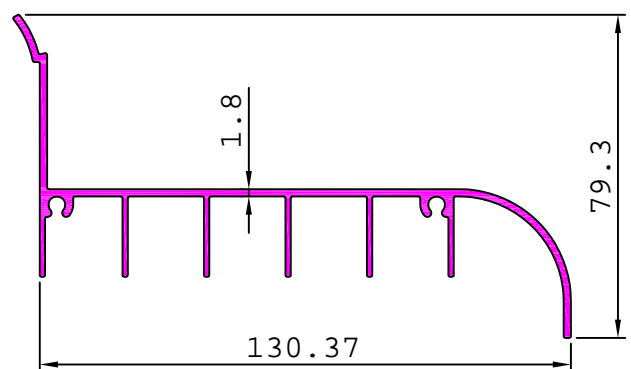

INDUSTRIAL

ELECTRICALS

28138

2.733 kg/m

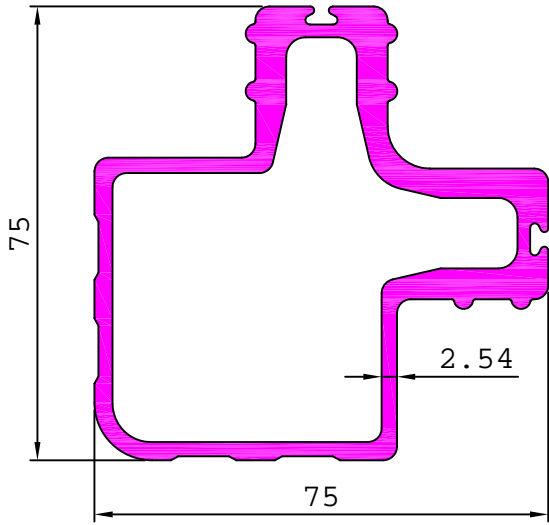

29235

0.834 kg/m

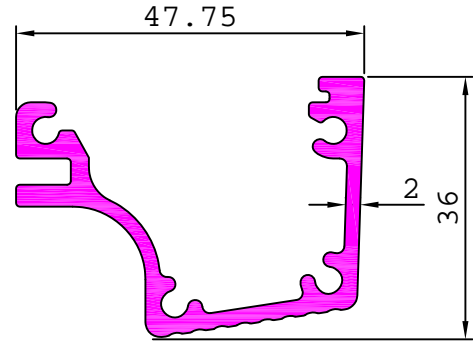

28177

2.551 kg/m

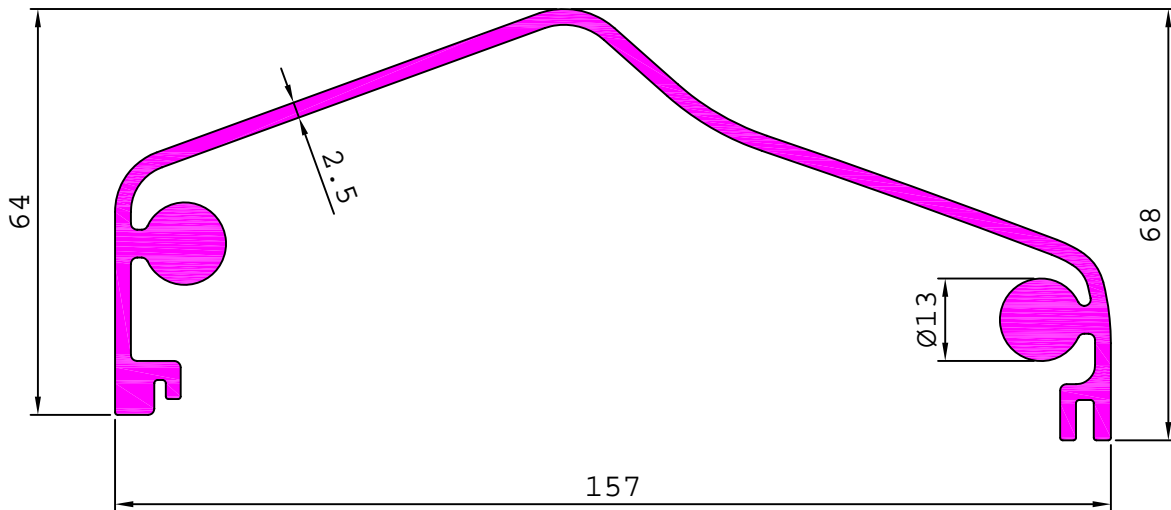

35077

0.157 kg/m

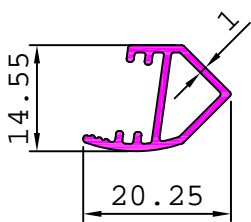

35078

0.565 kg/m

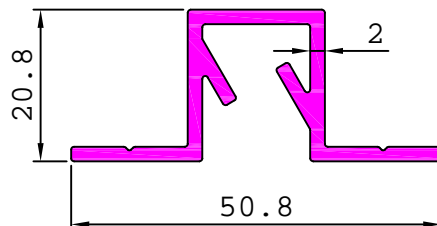

35079

0.630 kg/m

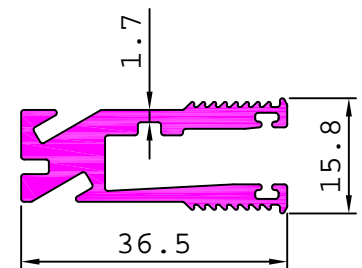

INDUSTRIAL

ELECTRICALS

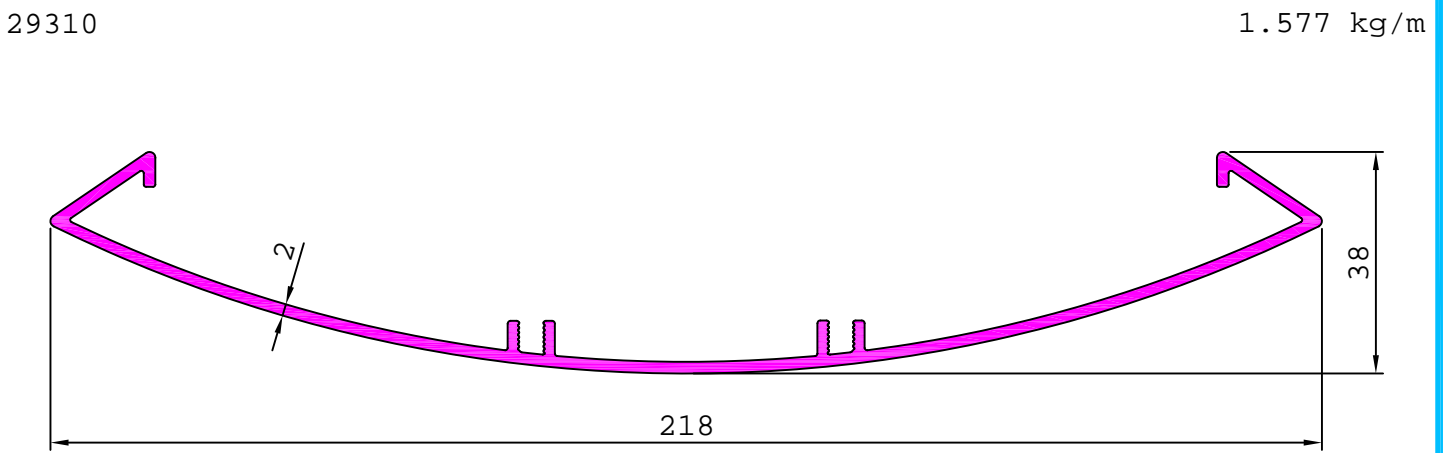
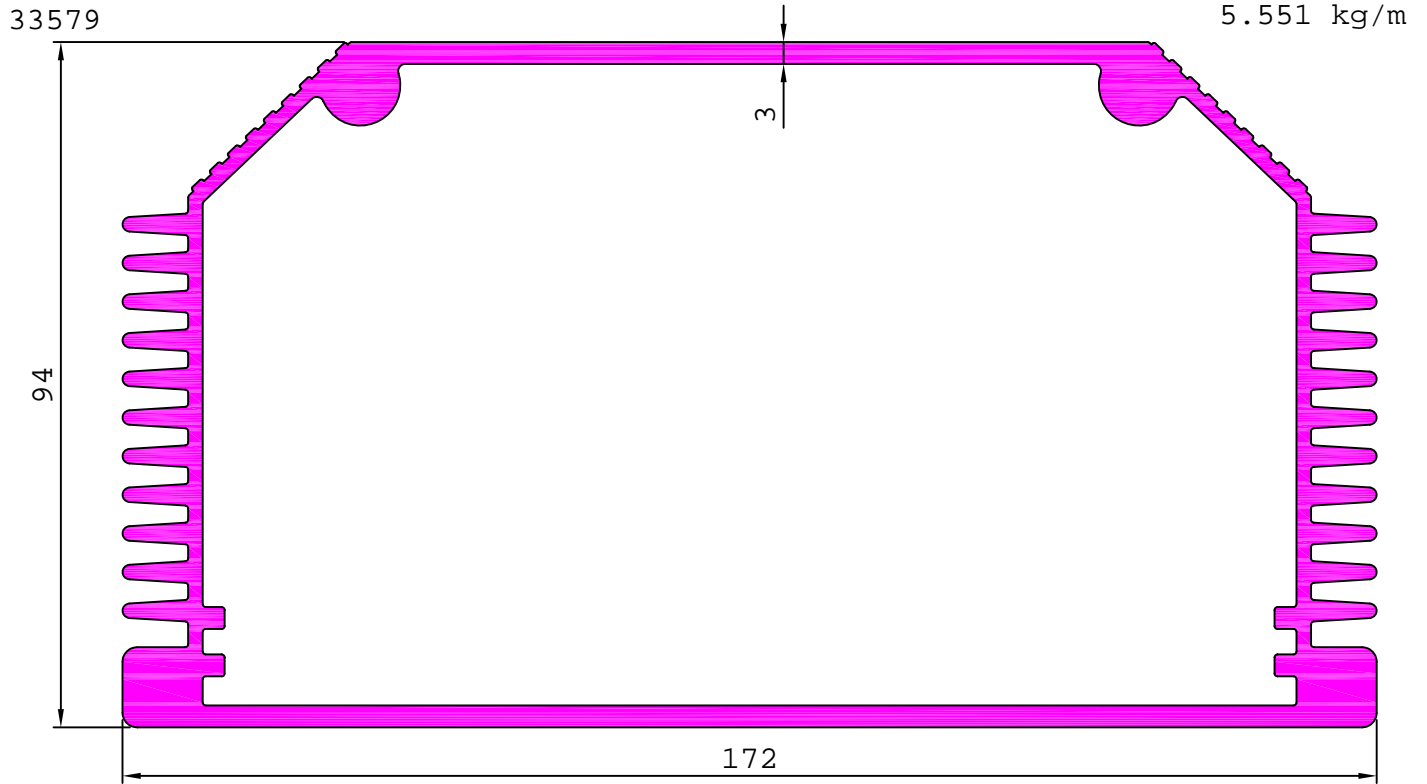

35080 0.830 kg/m

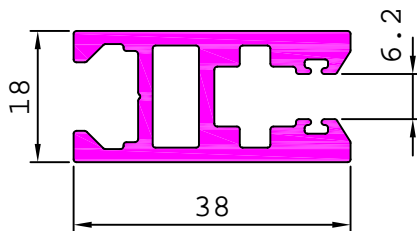

35081 0.363 kg/m

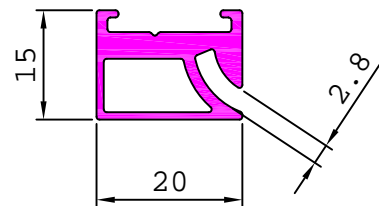

INDUSTRIAL

ELECTRICALS

28957

0.339 kg/m

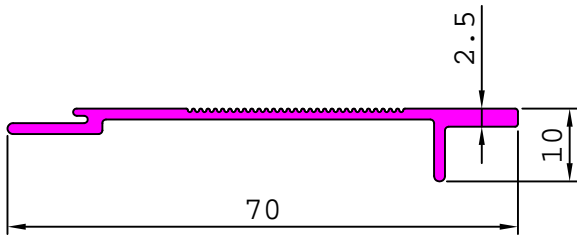

S5123

1.703 kg/m

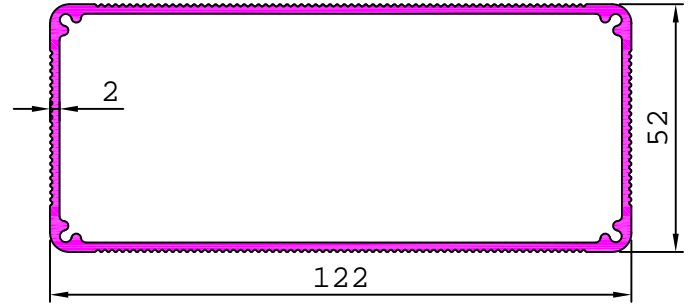

S5191

0.316 kg/m

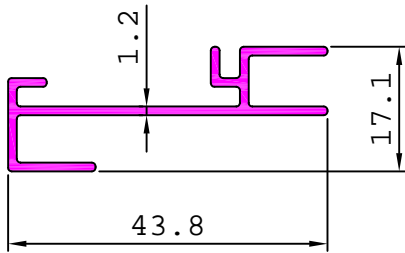

INDUSTRIAL

TUBE LIGHT SECTIONS

25201 0.173 kg/m

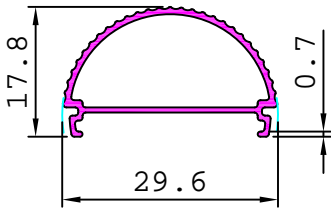

25202 0.212 kg/m

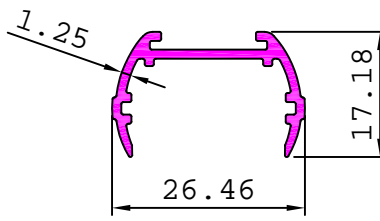

25214 0.129 kg/m

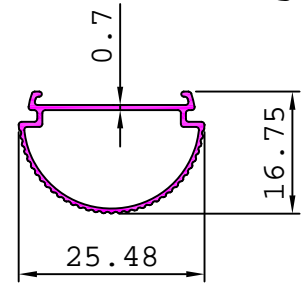

25806 0.265 kg/m

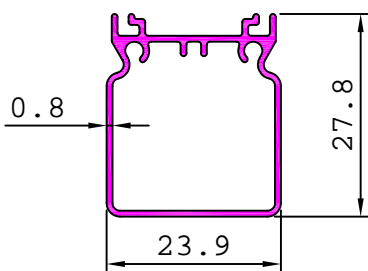

25249 0.174 kg/m

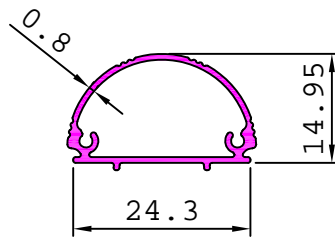

25272 0.092 kg/m

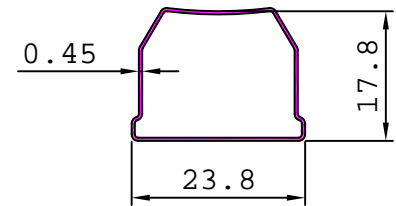

25273 0.104 kg/m

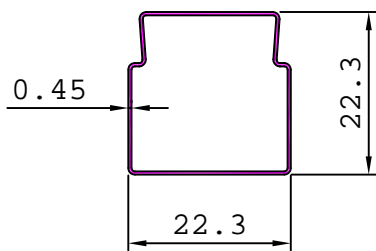

25299 0.157 kg/m

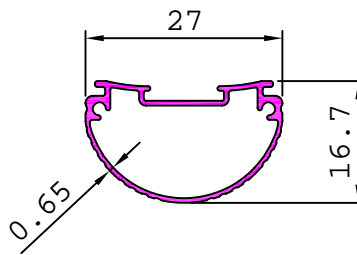

33588 0.249 kg/m

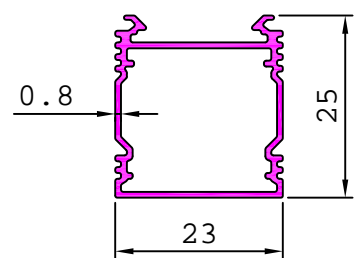

S4439 0.173 kg/m

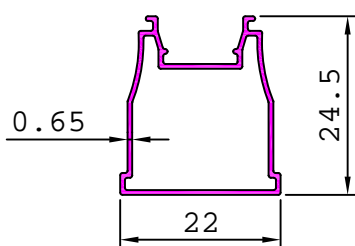

25293 0.284 kg/m

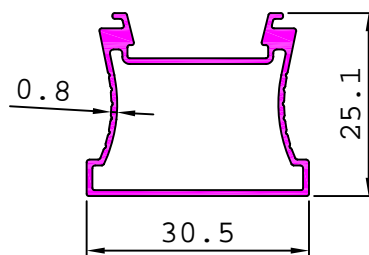

S4538 0.090 kg/m

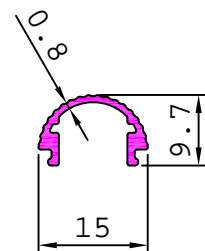

S4835 0.166 kg/m

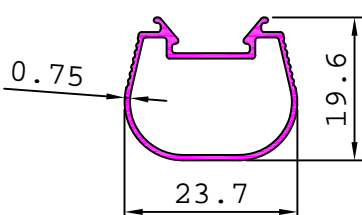

25259 0.183 kg/m

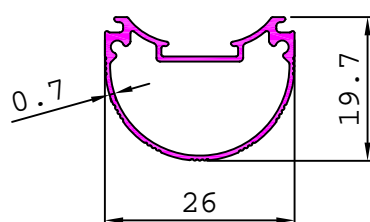

25260 0.361 kg/m

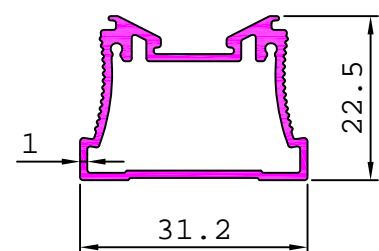

INDUSTRIAL

TUBE LIGHT SECTIONS

25261 0.209 kg/m

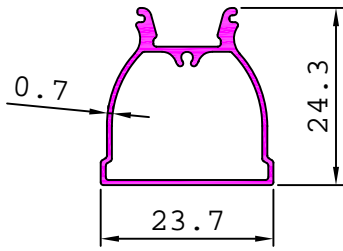

25262 0.205 kg/m

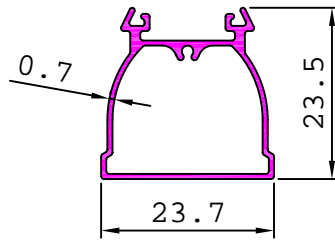

25276 0.104 kg/m

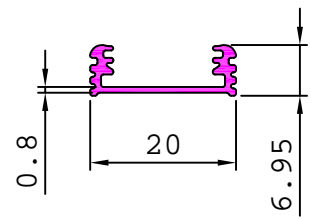

25277 0.302 kg/m

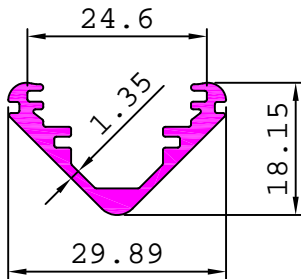

INDUSTRIAL

ELECTRONICS

25705 2.286 kg/m

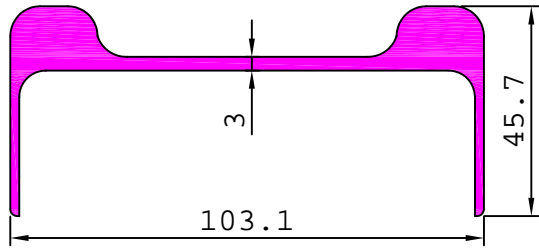

25708 0.353 kg/m

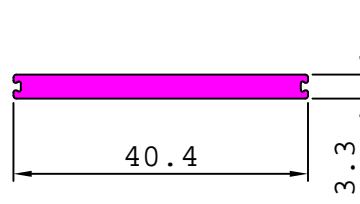

25714 0.509 kg/m

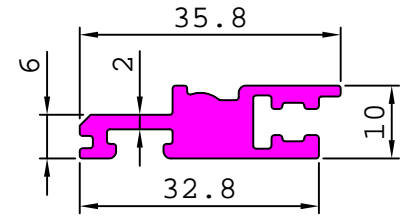

25713 1.660 kg/m

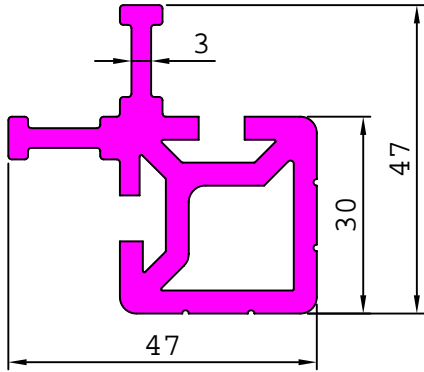

25715 0.610 kg/m

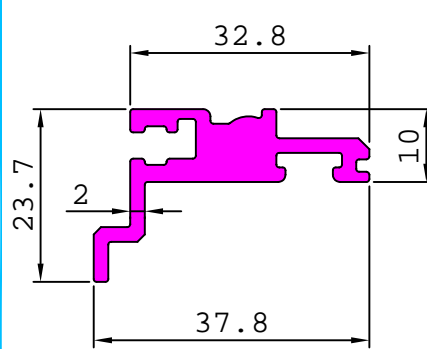

25716 1.122 kg/m

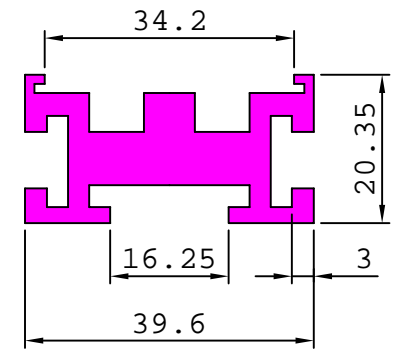

25717 1.316 kg/m

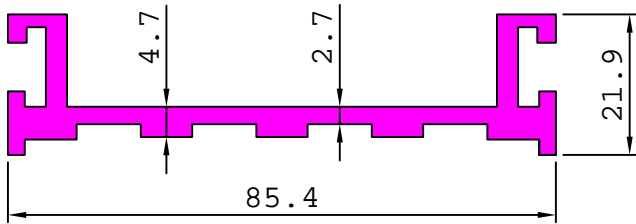

25726 1.018 kg/m

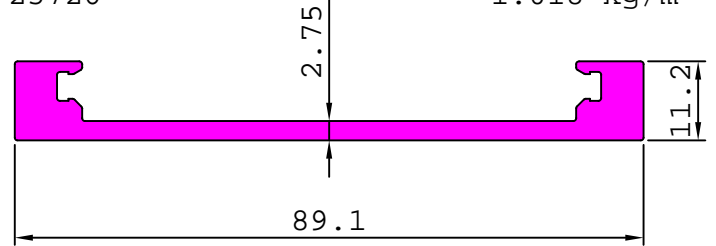

25725 2.239 kg/m

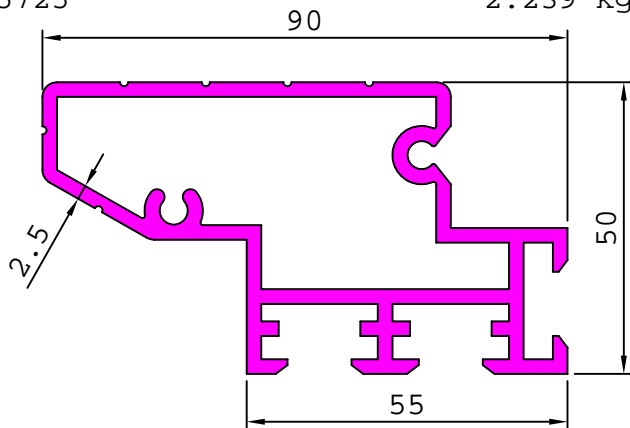

25732 1.594 kg/m

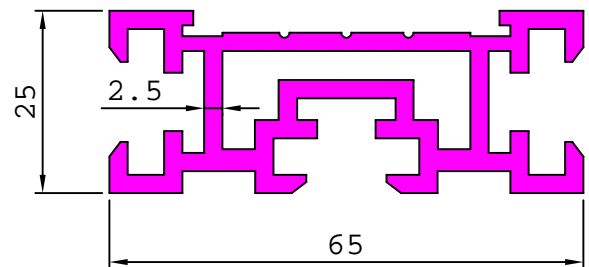

25720 0.468 kg/m

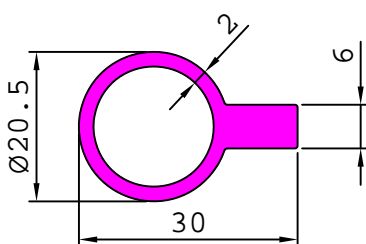

25724 0.273 kg/m

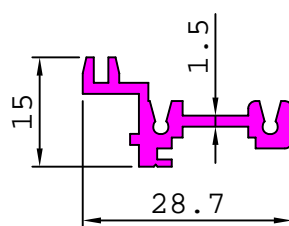

25729 0.600 kg/m

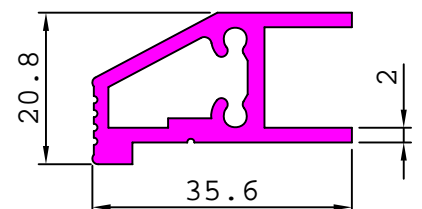

INDUSTRIAL

ELECTRONICS

25730 0.365 kg/m

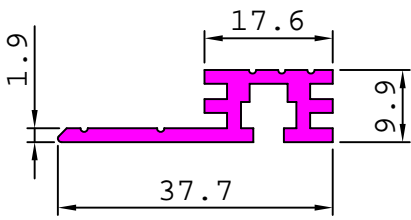

25736 0.169 kg/m

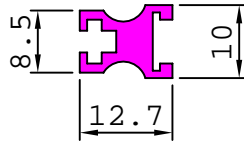

25737 0.401 kg/m

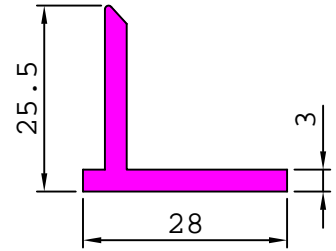

25740 0.433 kg/m

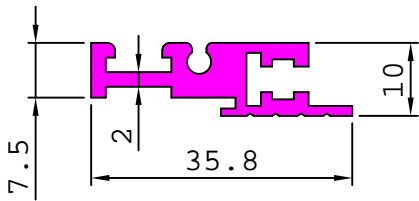

25742 0.531 kg/m

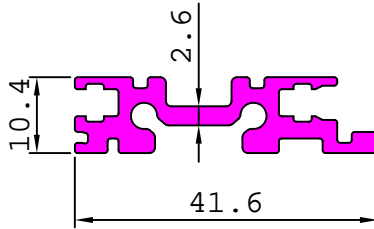

25745 0.600 kg/m

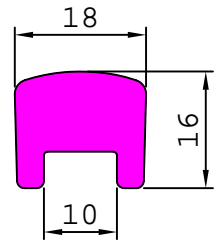

25748 1.387 kg/m

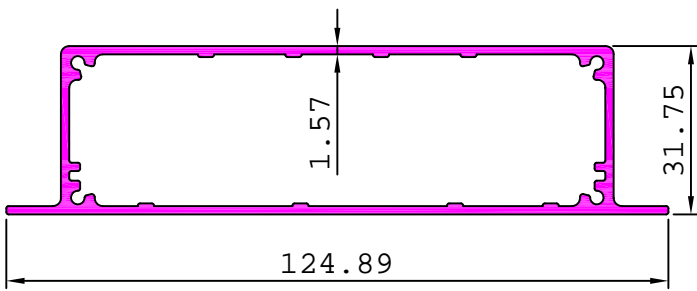

25749 2.533 kg/m

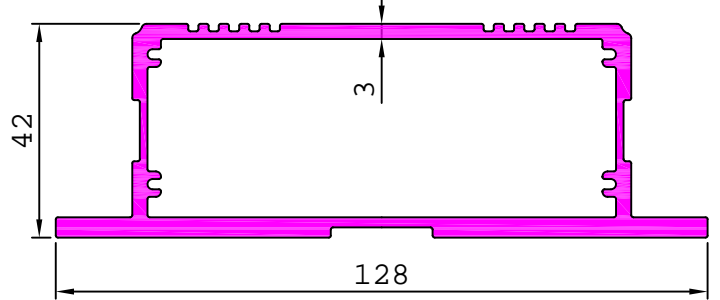

25750 0.373 kg/m

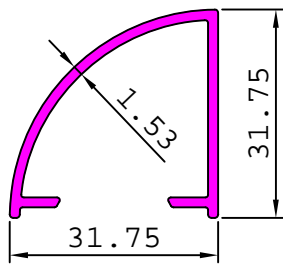

25752 0.178 kg/m

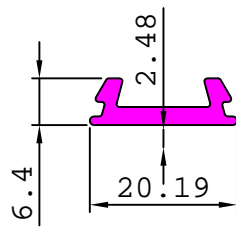

25755 0.353 kg/m

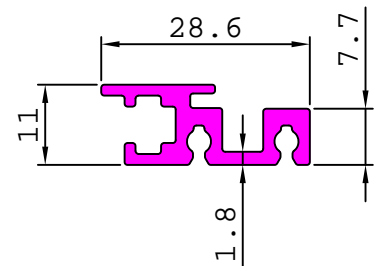

25754 2.178 kg/m

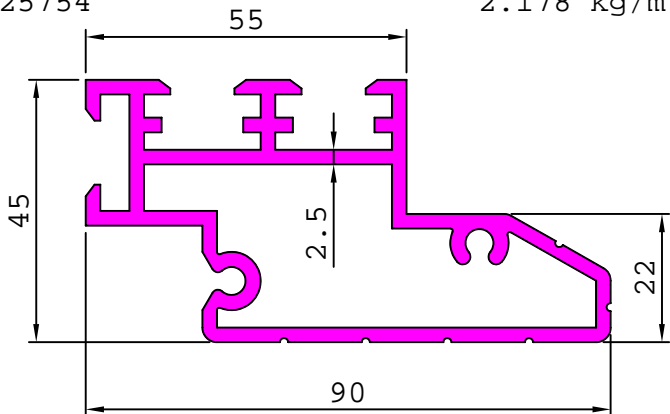

25760 0.634 kg/m

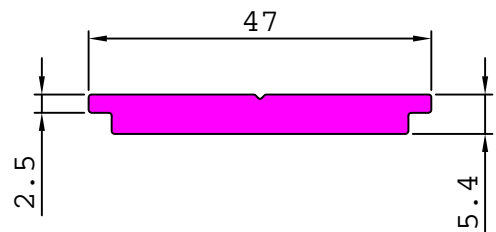

INDUSTRIAL

ELECTRONICS

25761

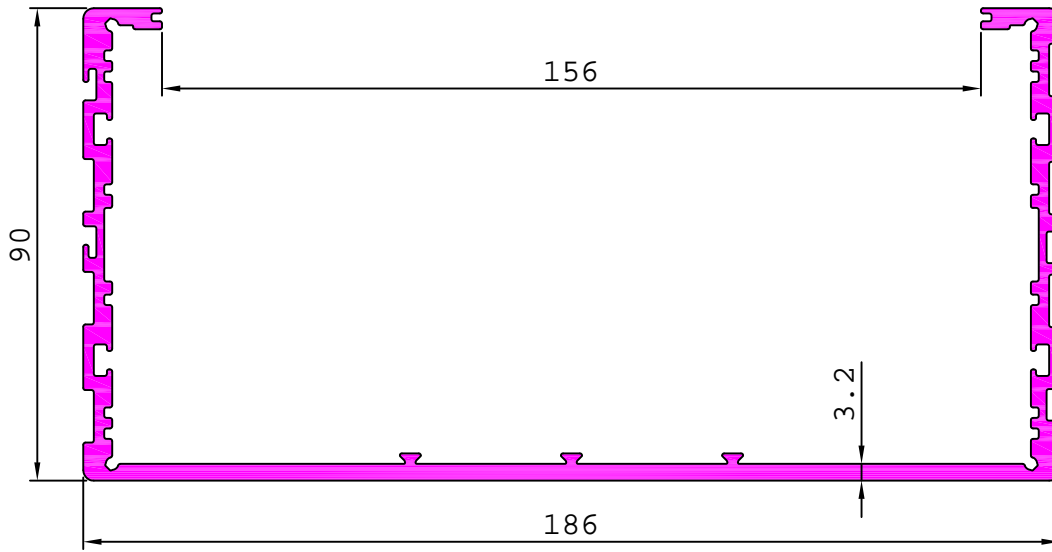

3.489 kg/m

25766

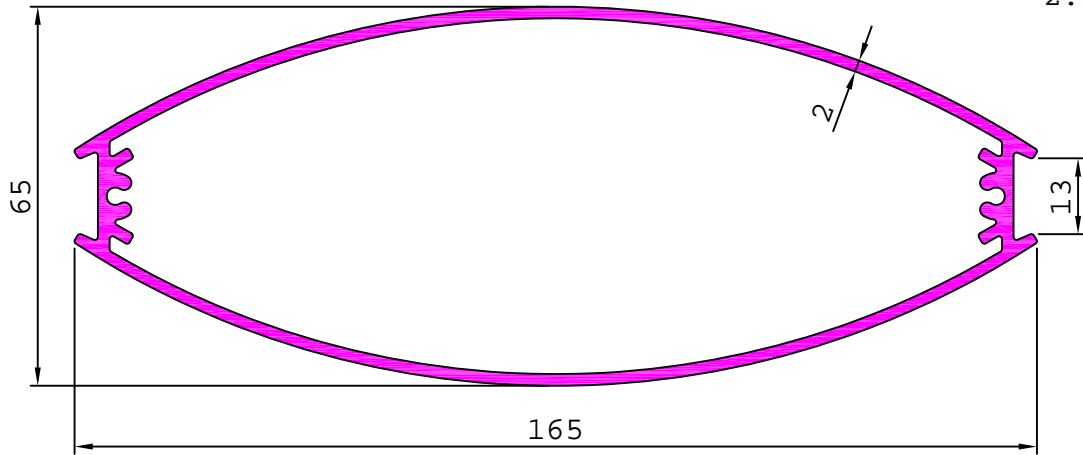

2.261 kg/m

25767

2.100 kg/m

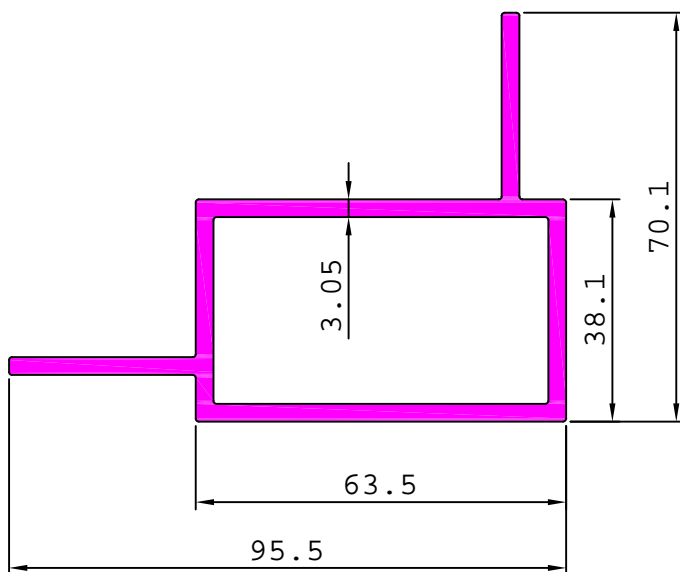

25768

0.781 kg/m

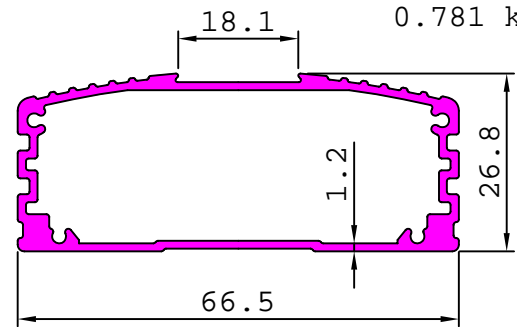

25770

1.078 kg/m

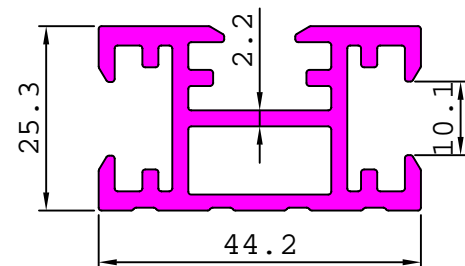

INDUSTRIAL

ELECTRONICS

25769

1.845 kg/m

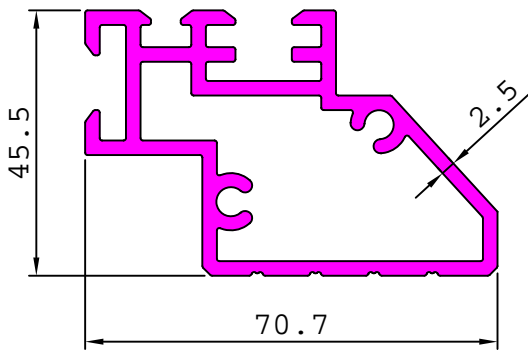

25771

1.633 kg/m

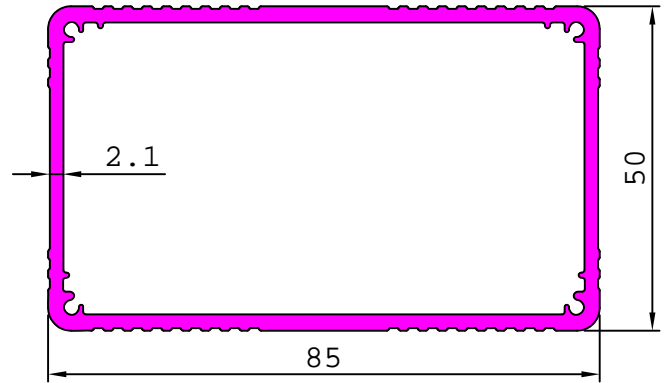

25773

2.094 kg/m

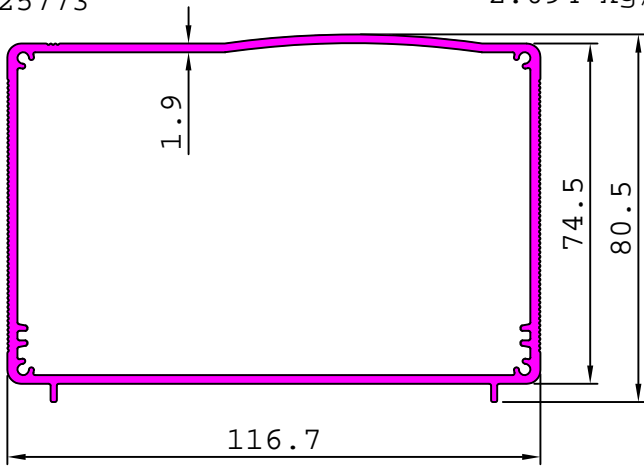

25776

1.665 kg/m

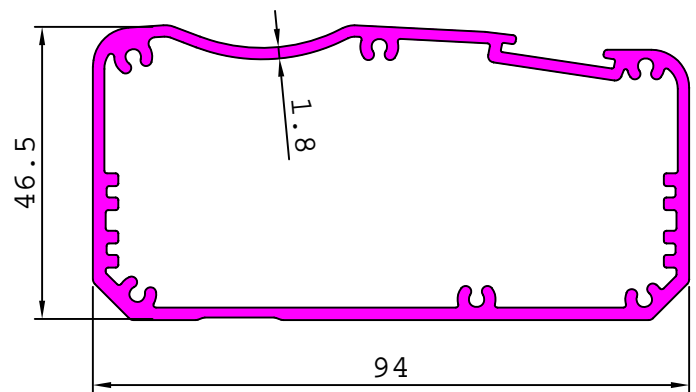

25772

0.260 kg/m

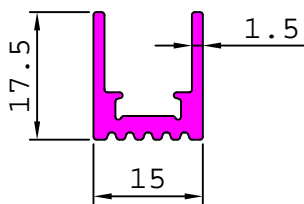

25775

0.351 kg/m

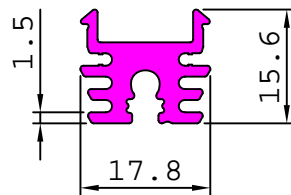

25778

0.301 kg/m

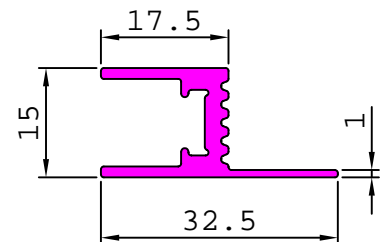

25777

2.304 kg/m

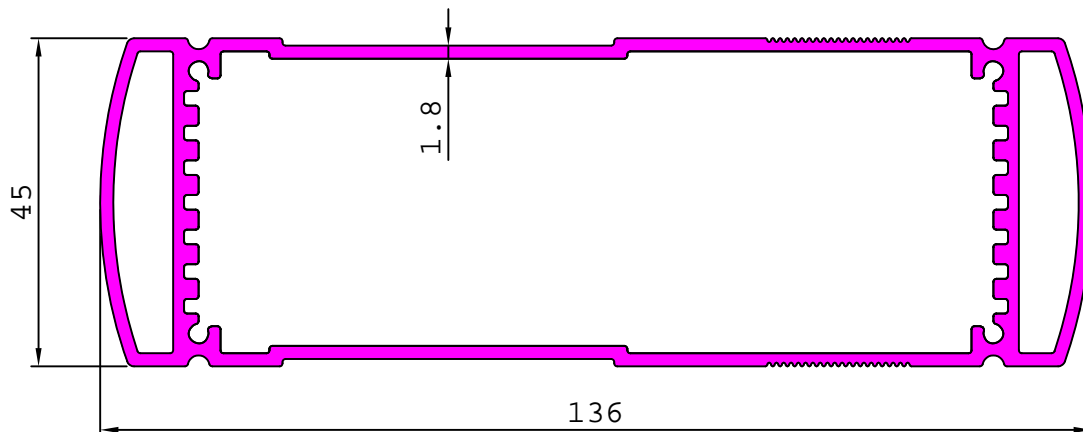

INDUSTRIAL

ELECTRONICS

25774

1.061 kg/m

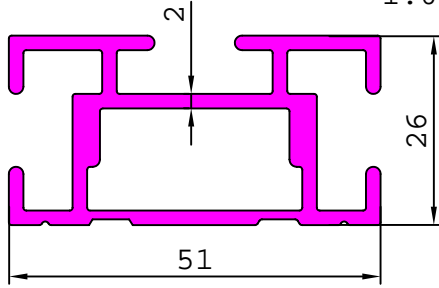

25781

0.215 kg/m

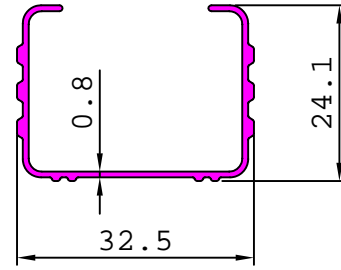

25779

2.321 kg/m

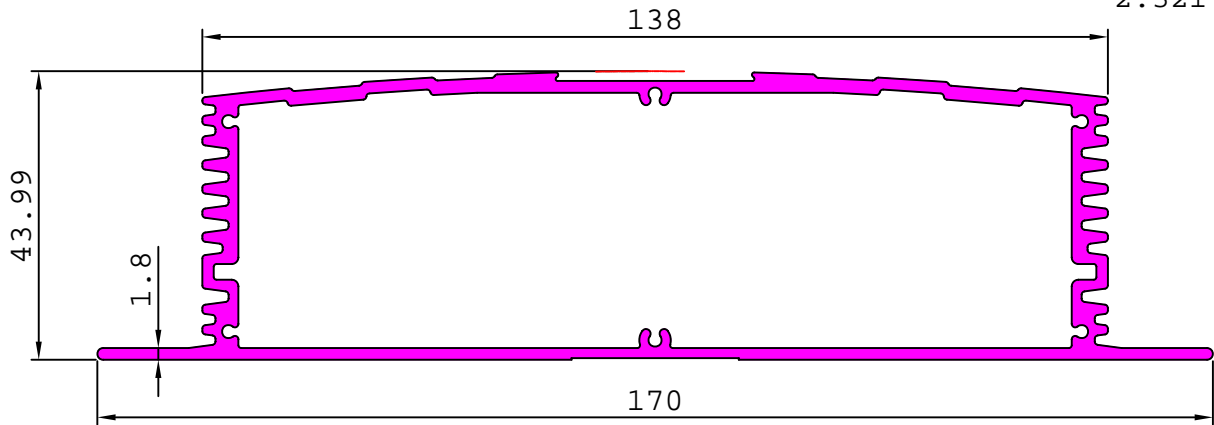

25780

1.613 kg/m

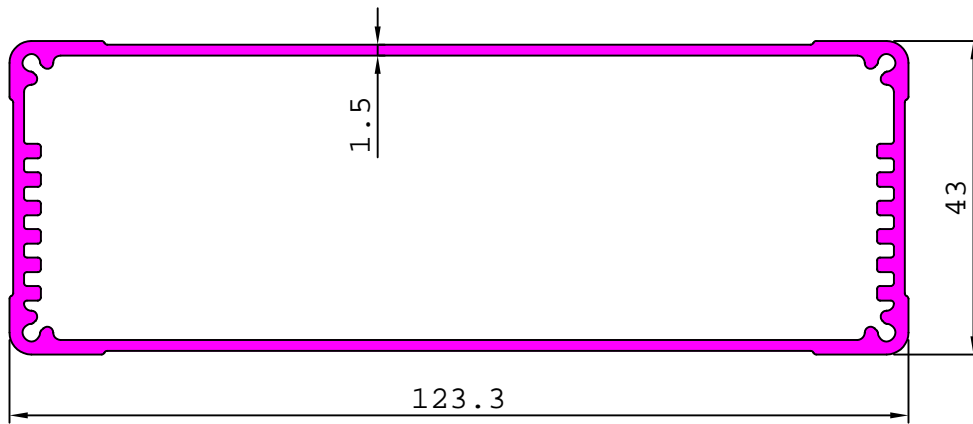

25788

1.359 kg/m

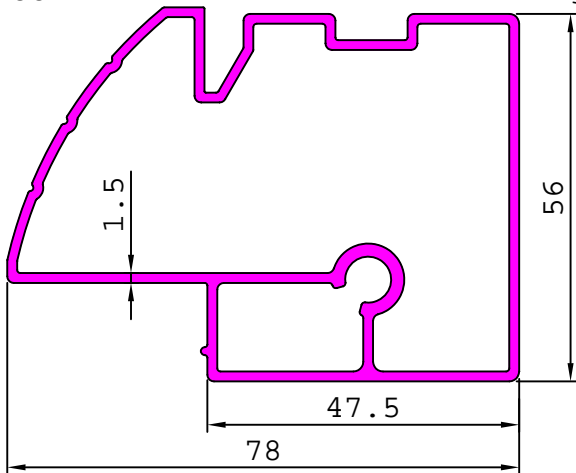

25789

1.157 kg/m

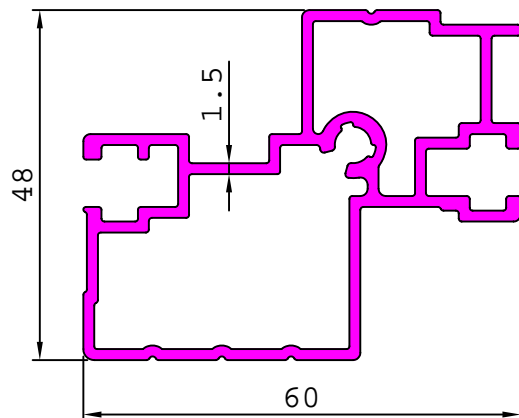

INDUSTRIAL

ELECTRONICS

25782

0.272 kg/m

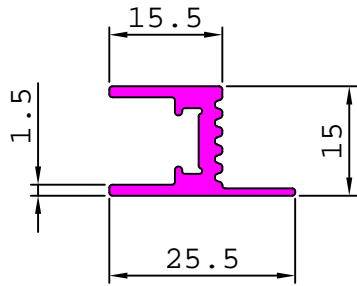

25783

1.053 kg/m

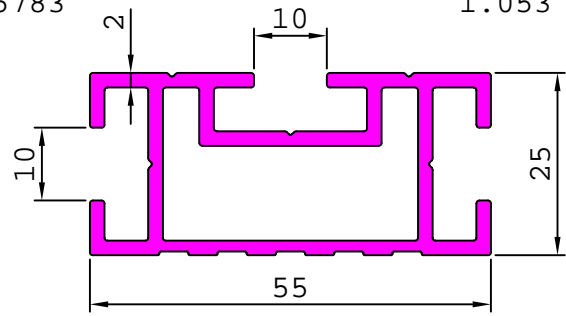

25784

1.538 kg/m

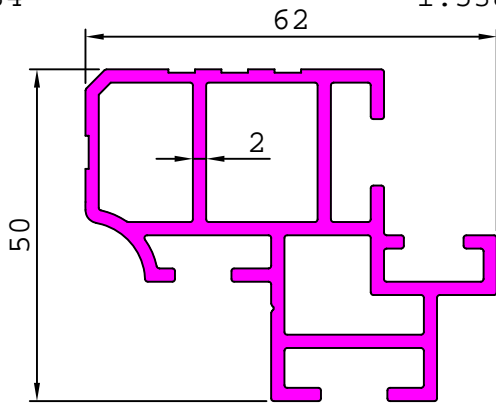

25786

1.544 kg/m

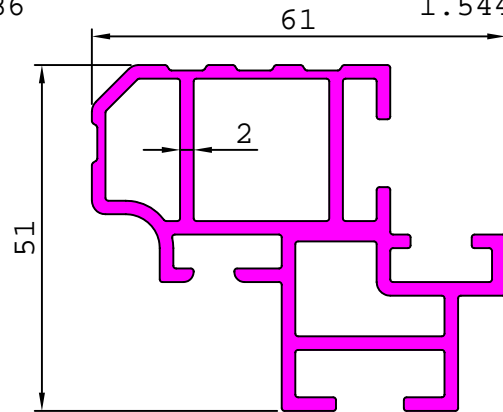

25785

1.540 kg/m

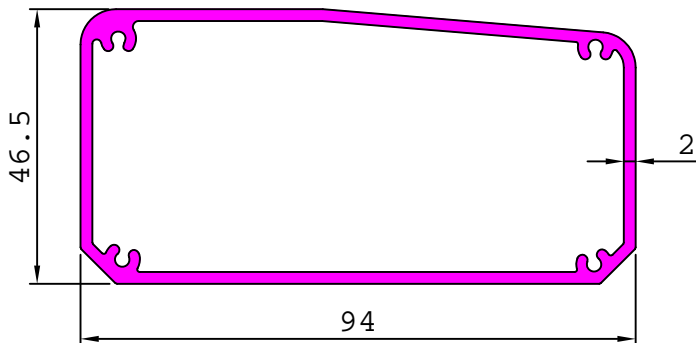

25787

0.960 kg/m

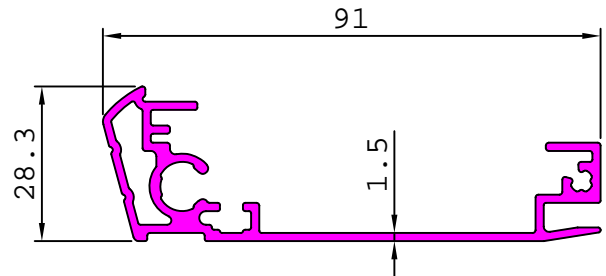

25790

2.034 kg/m

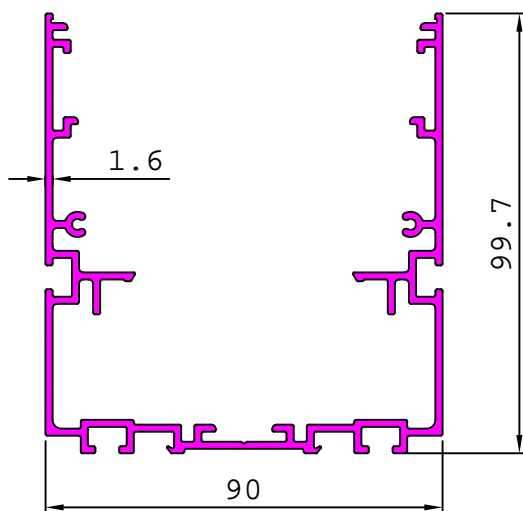

25791

2.148 kg/m

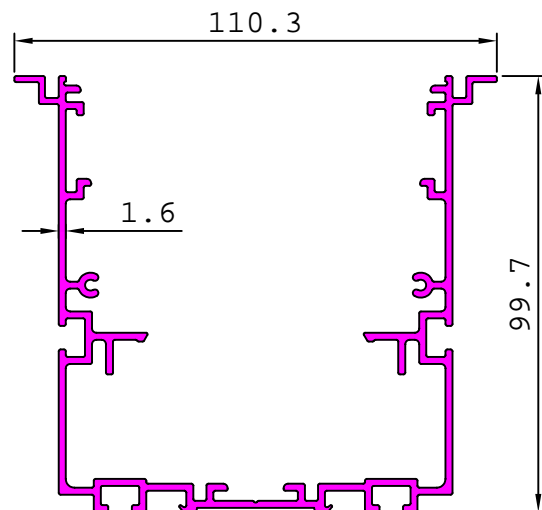

INDUSTRIAL

ELECTRONICS

25192

1.007kg/m

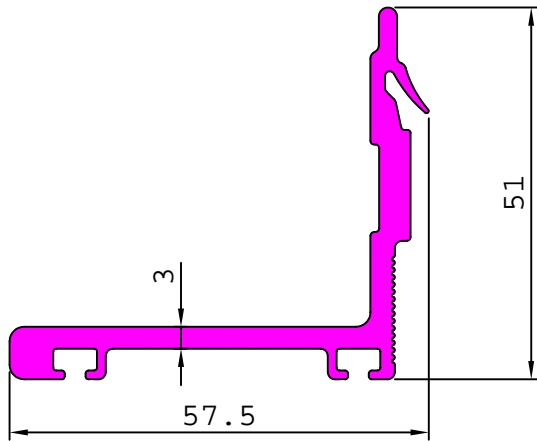

25793

1.069 kg/m

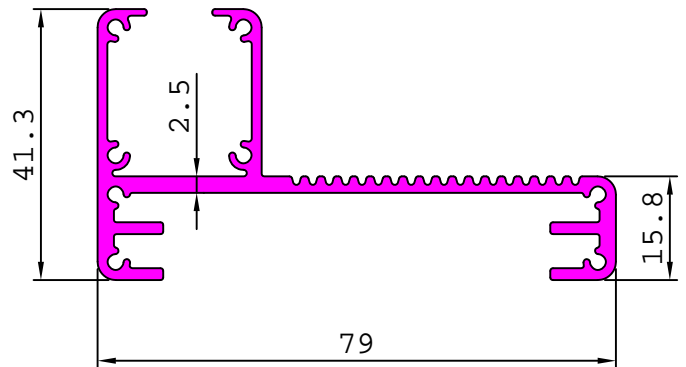

25794

0.307 kg/m

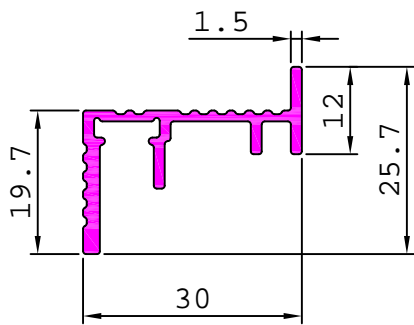

25795

0.942 kg/m

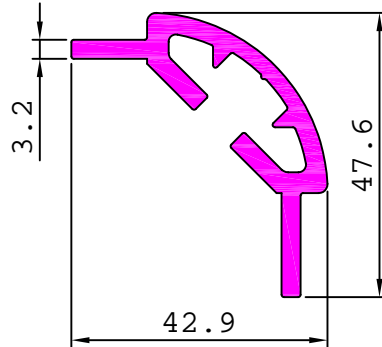

25797

0.347 kg/m

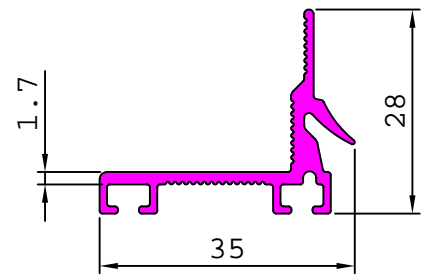

25792

0.414 kg/m

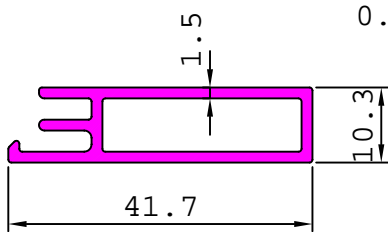

25799

0.373 kg/m

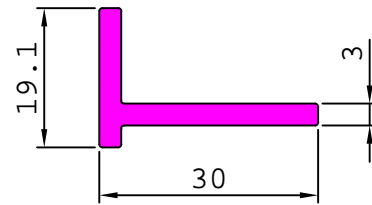

25796

11.811 kg/m

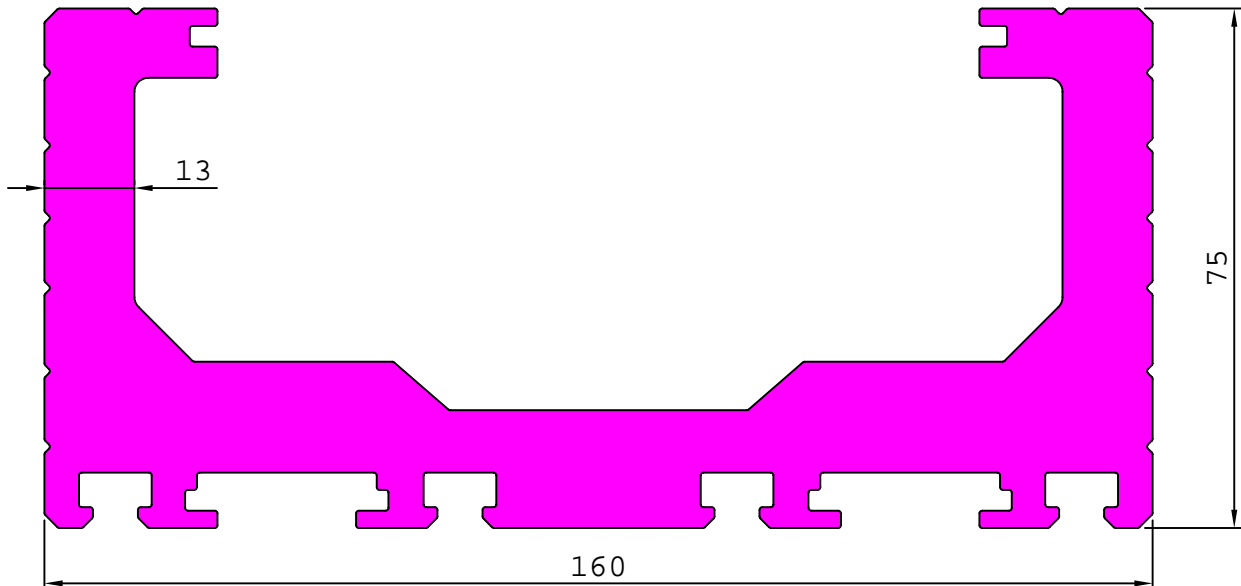

INDUSTRIAL

ELECTRONICS

25800

1.998 kg/m

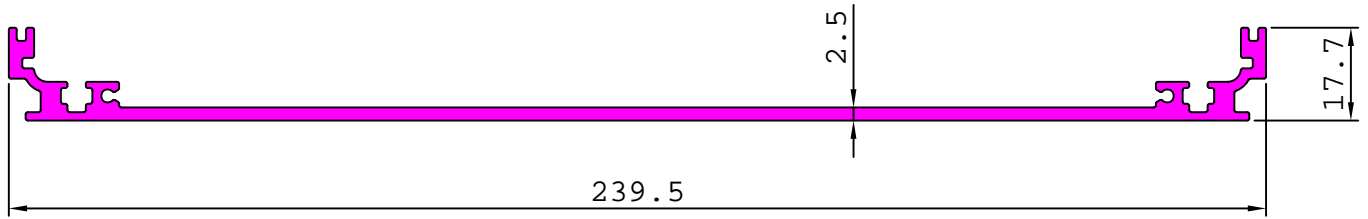

25801

1.681 kg/m

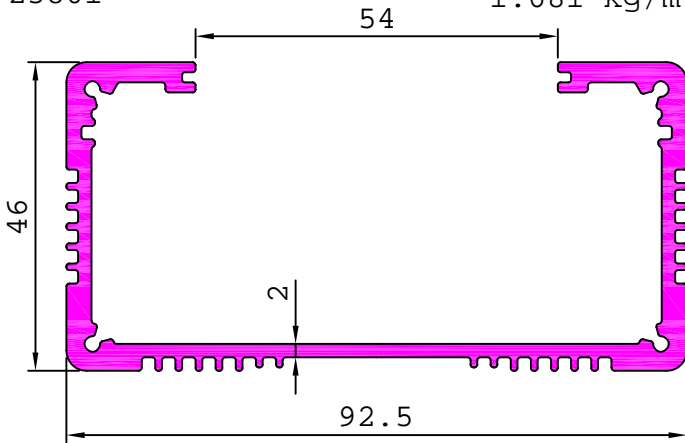

25808

1.533 kg/m

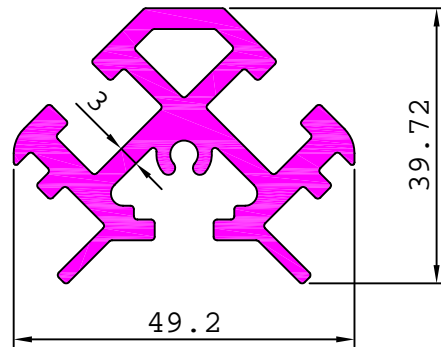

25802

3.030 kg/m

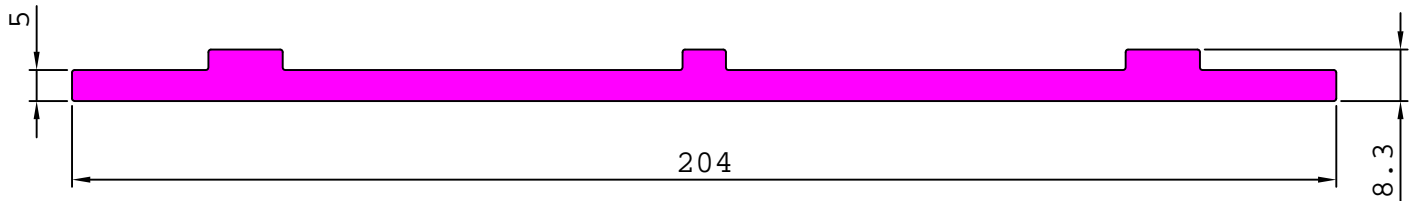

25803

7.957 kg/m

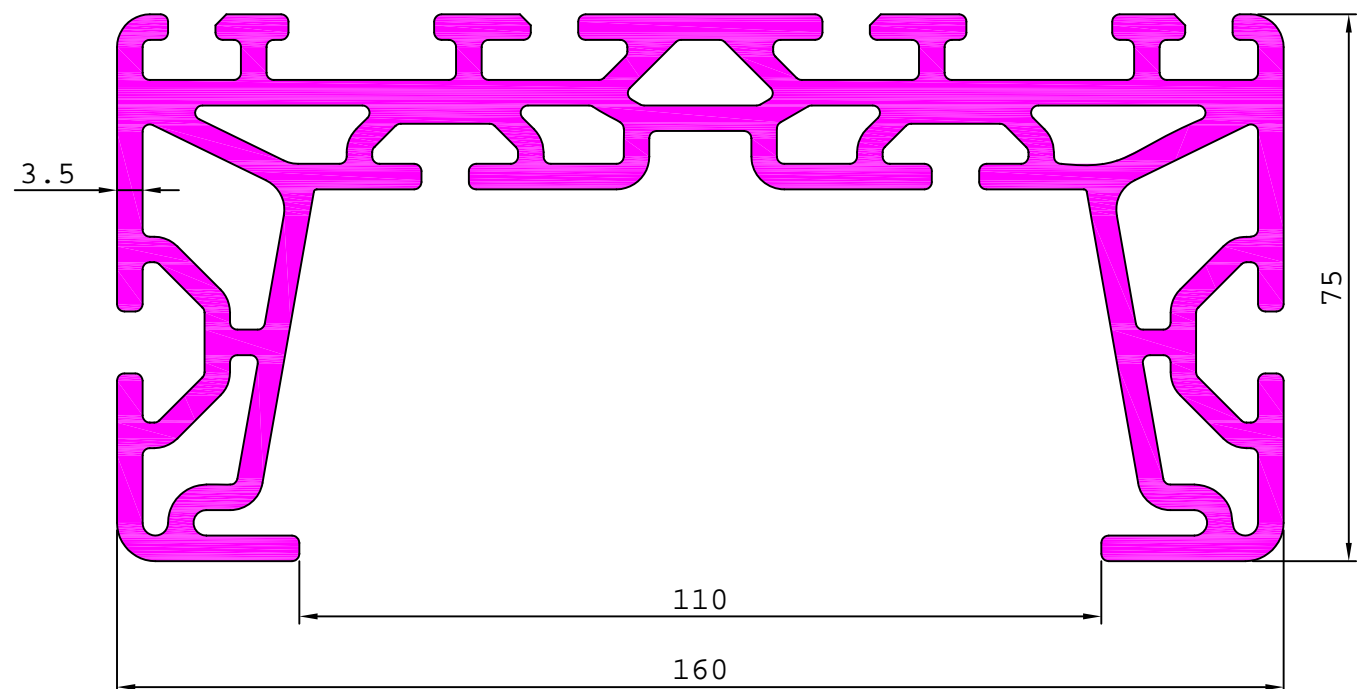

INDUSTRIAL

ELECTRONICS

25798

23.035 kg/m

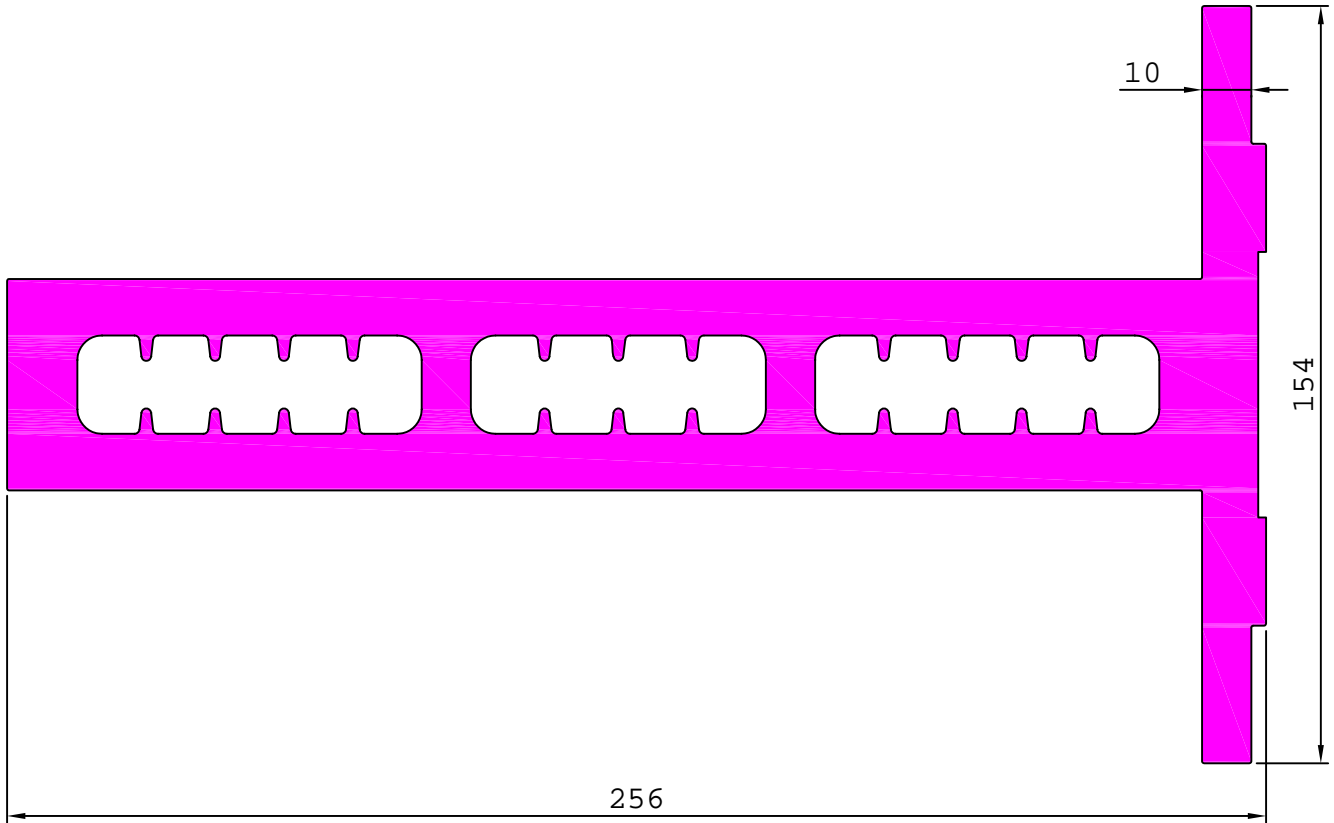

25807

1.860 kg/m

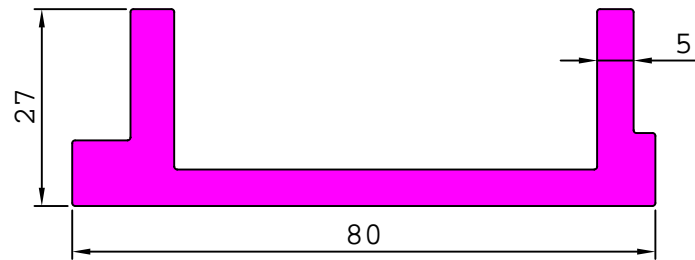

25813

1.521 kg/m

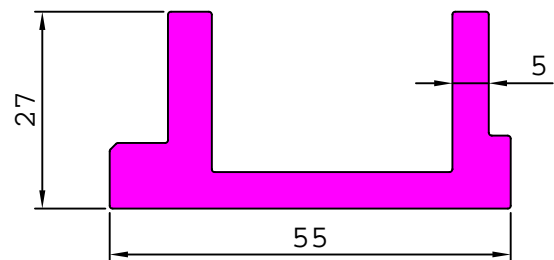

25809

2.085 kg/m

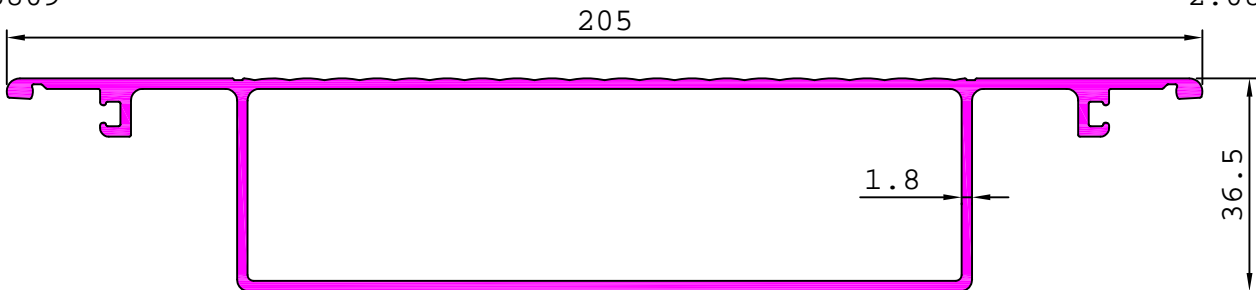

25810

8.468 kg/m

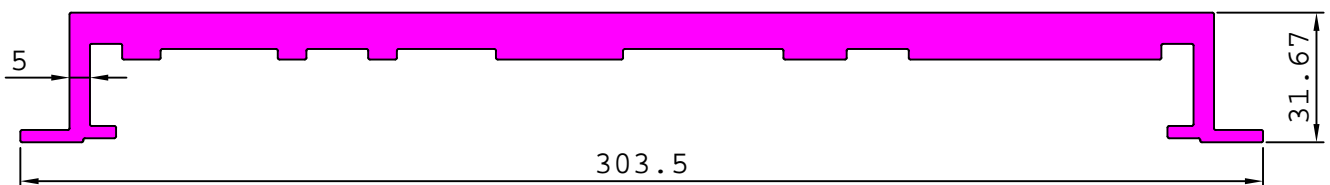

INDUSTRIAL

ELECTRONICS

25804

7.576 kg/m

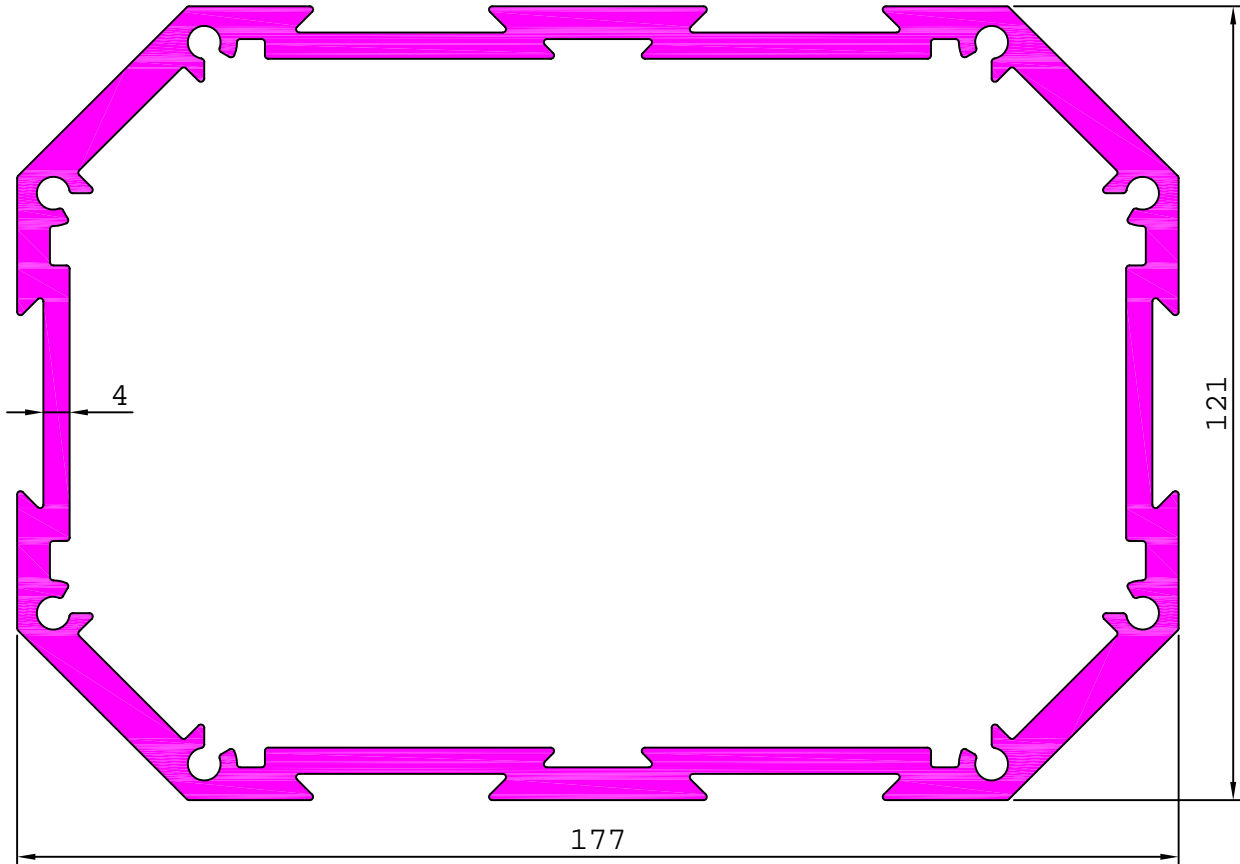

25805

8.652 kg/m

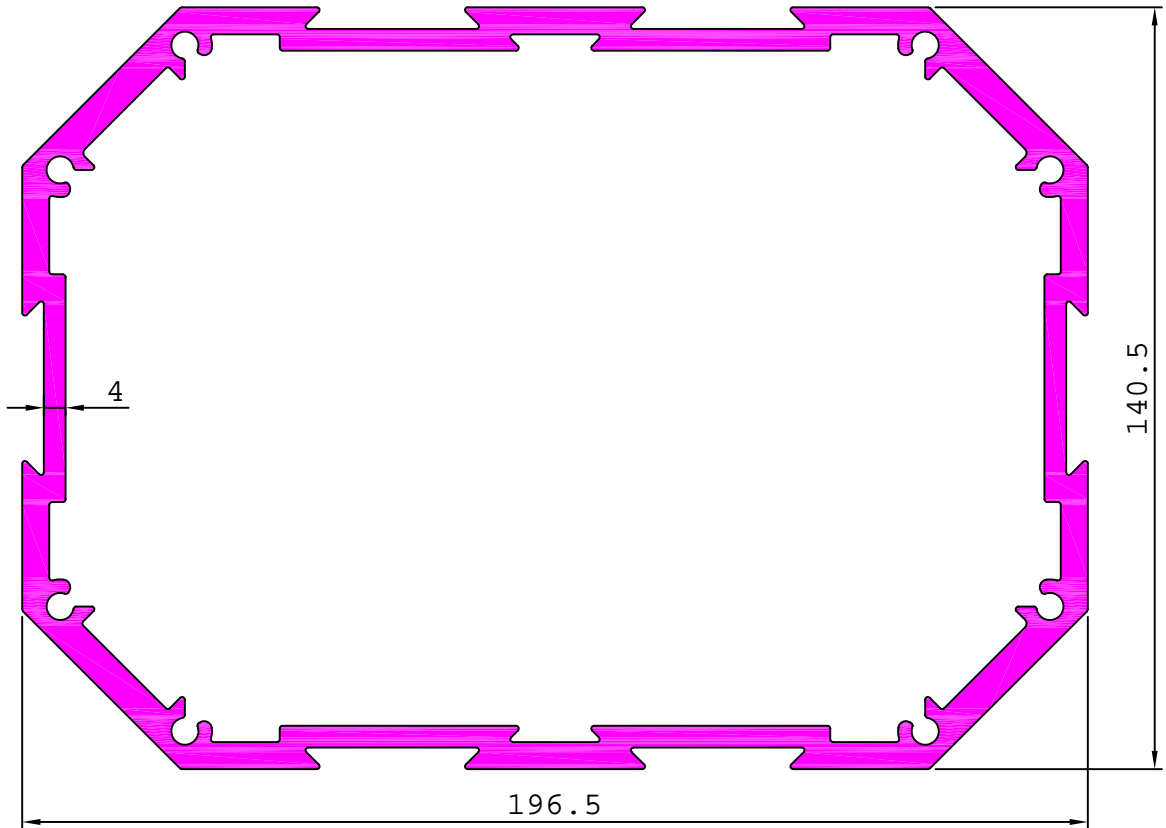

INDUSTRIAL

ELECTRONICS

25811 0.331 kg/m

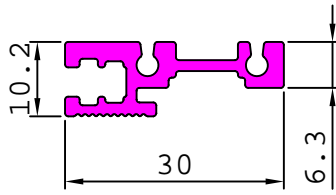

25812 0.353 kg/m

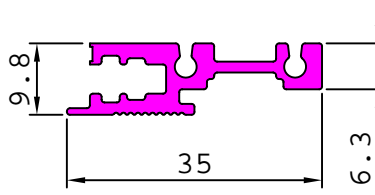

25815 0.326 kg/m

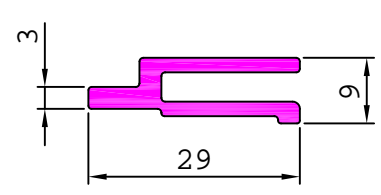

25814 2.484 kg/m

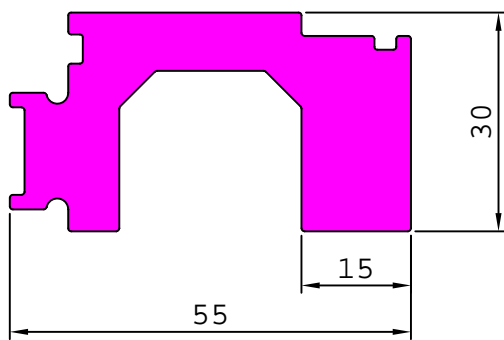

25821 1.218 kg/m

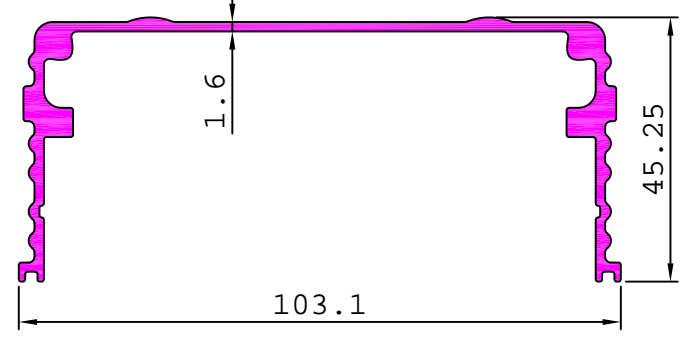

25823 0.644 kg/m

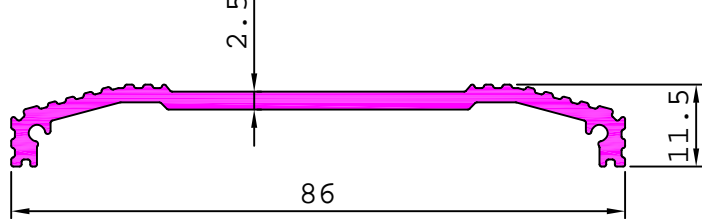

MATCHING WITH 25822

25820 1.043 kg/m

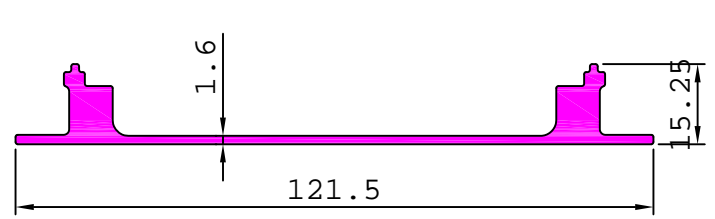

MATCHING WITH 25821

25822 2.065 kg/m

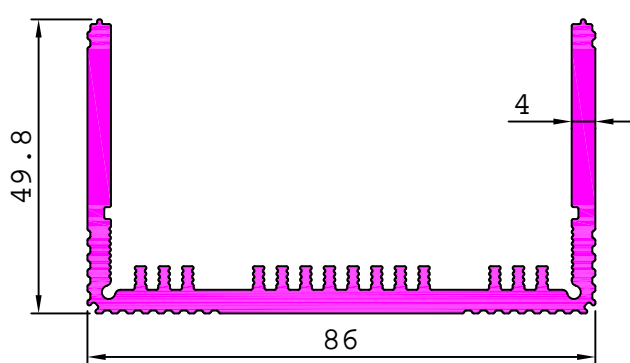

S4863 1.448 kg/m

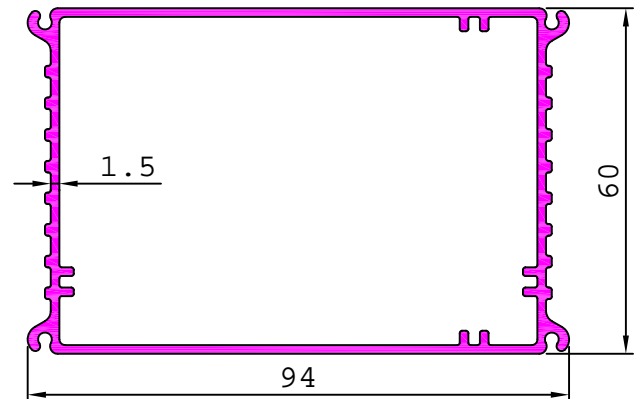

25825 2.559 kg/m

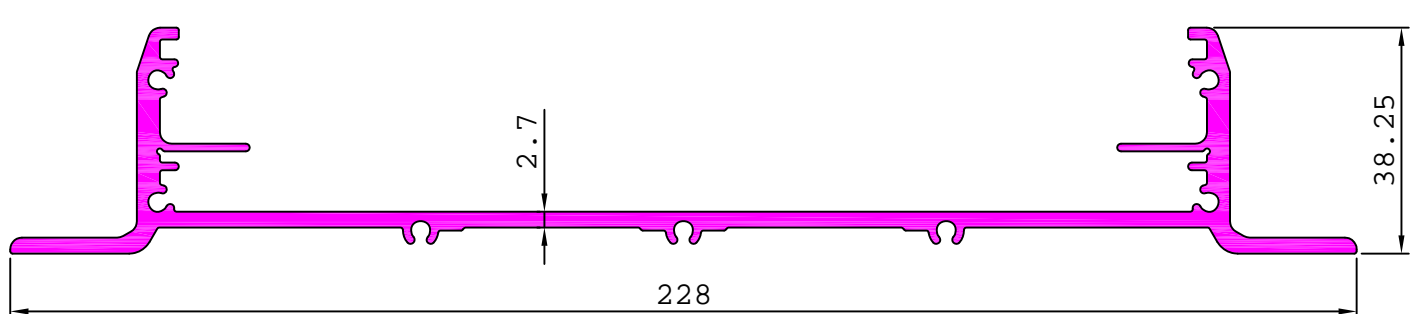

INDUSTRIAL

ELECTRONICS

25824

7.643 kg/m

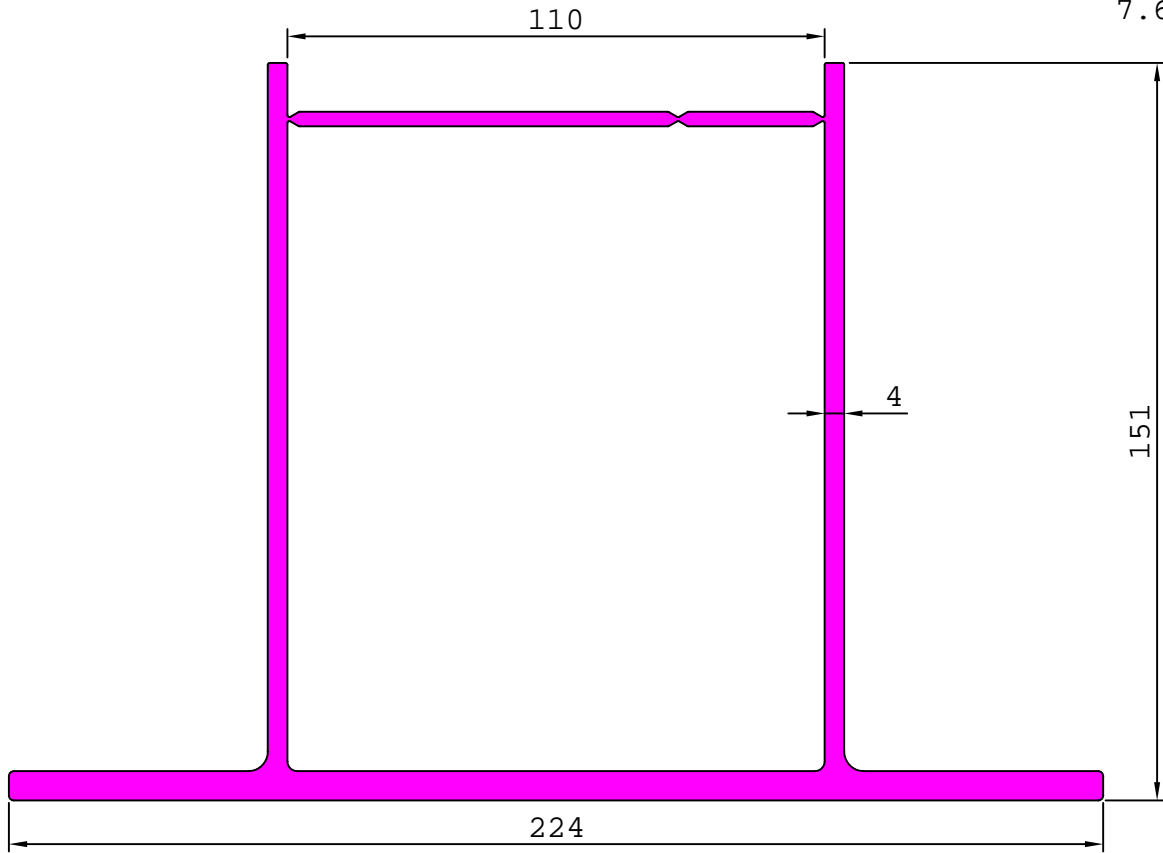

25826

0.471 kg/m

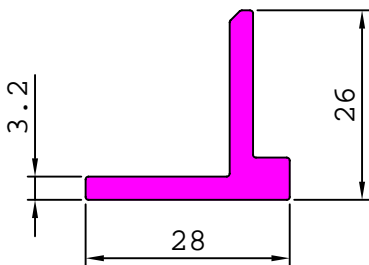

25827

0.217 kg/m

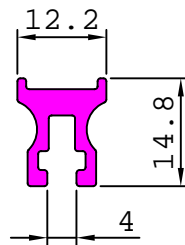

25828

0.367 kg/m

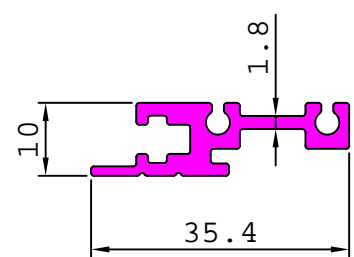

28938

3.488 kg/m

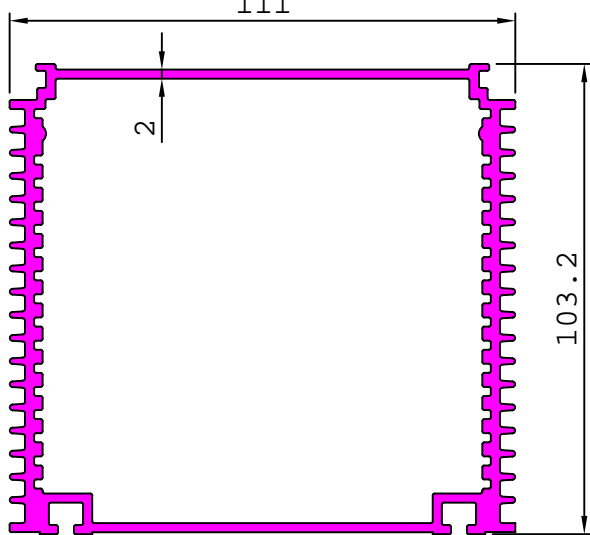

26407

2.224 kg/m

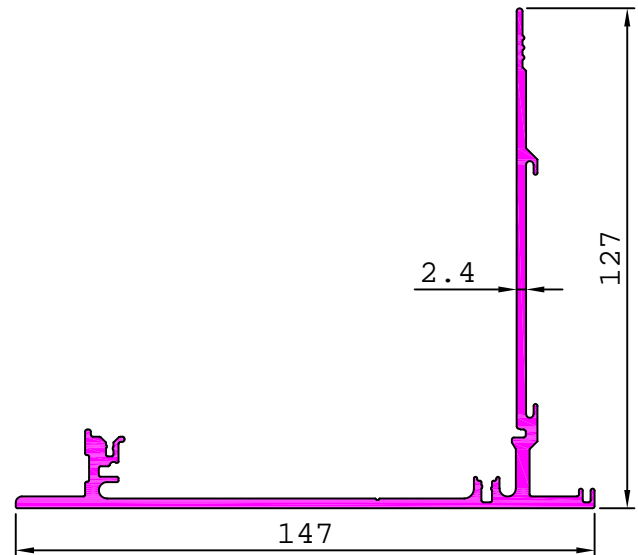

INDUSTRIAL

ELECTRONICS

S4246

31.803 kg/m

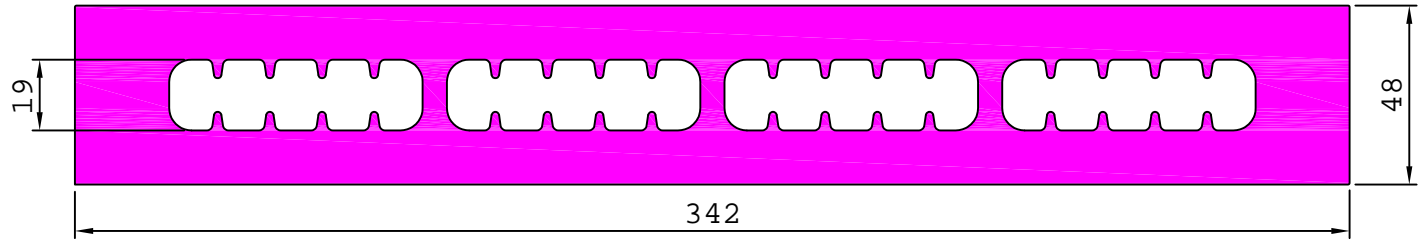

S4673

1.637 kg/m

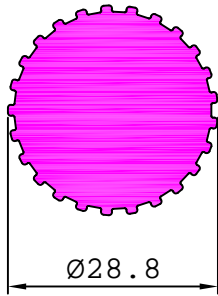

S4674

1.429 kg/m

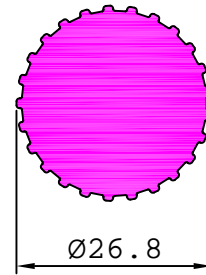

S4848

1.233 kg/m

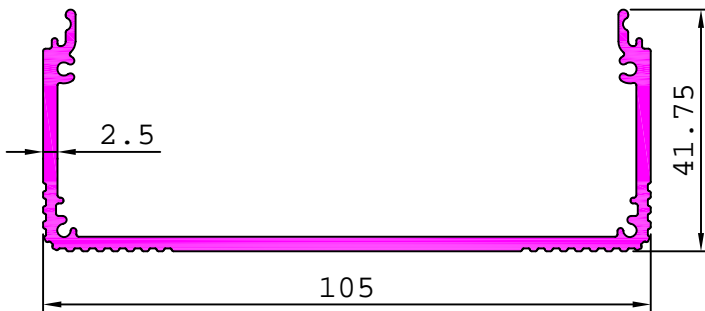

S4849

0.924 kg/m

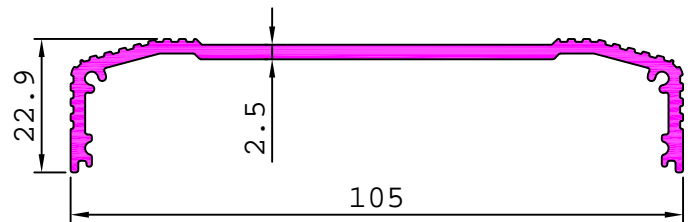

S4939

2.546 kg/m

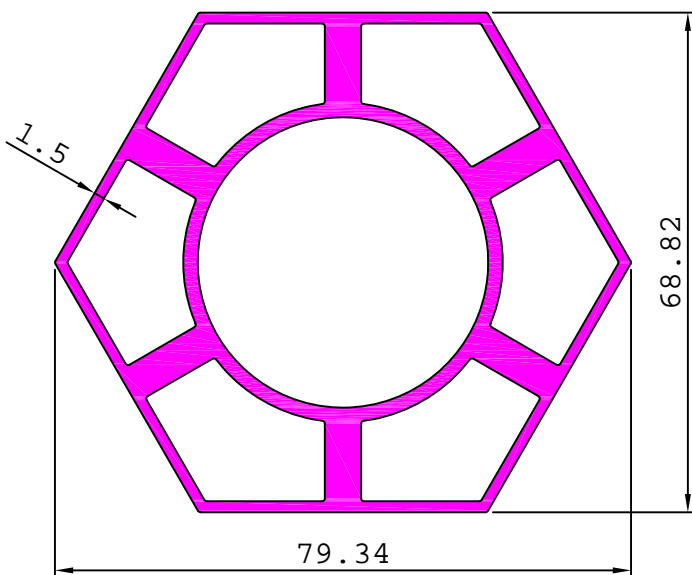

28171

3.468 kg/m

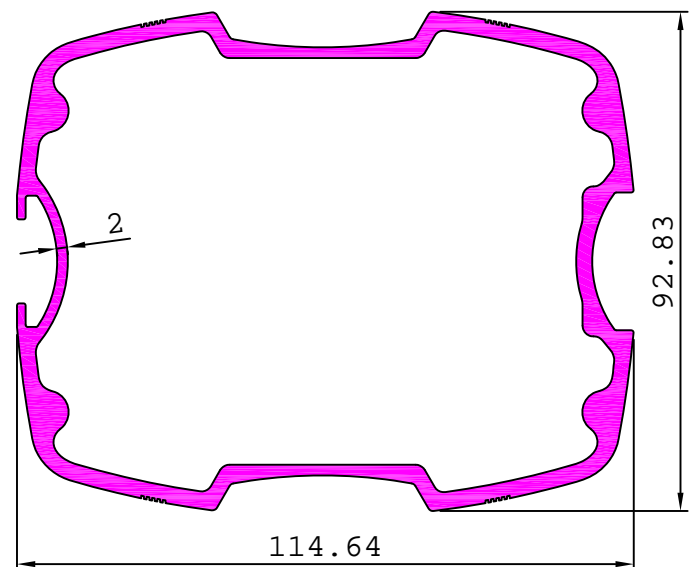

INDUSTRIAL

ELECTRONICS

27757 4.712 kg/m

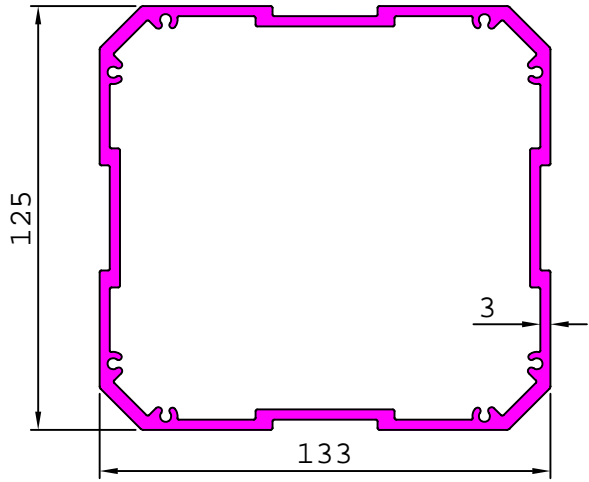

27763 4.066 kg/m

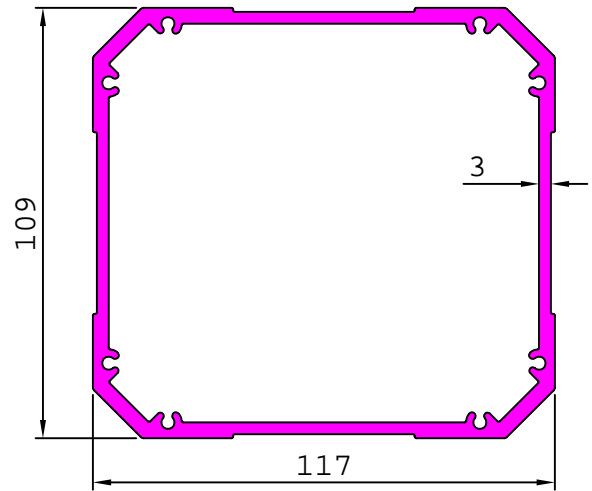

27882 30.140 kg/m

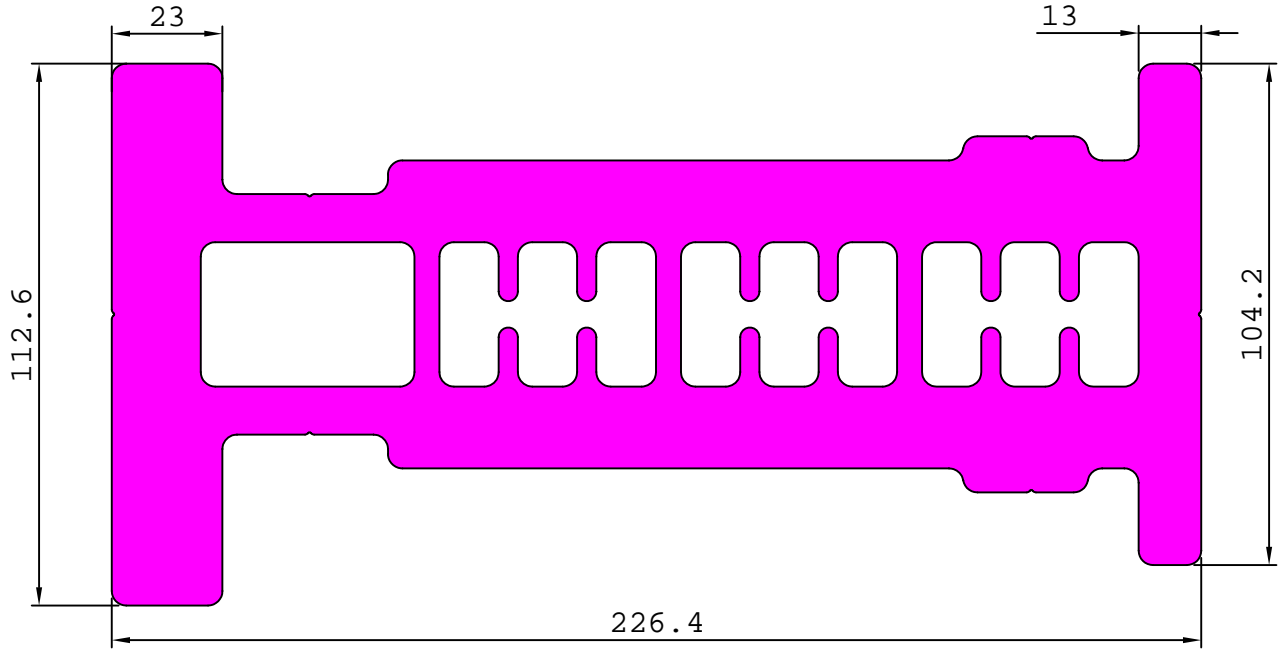

27902 23.855 kg/m

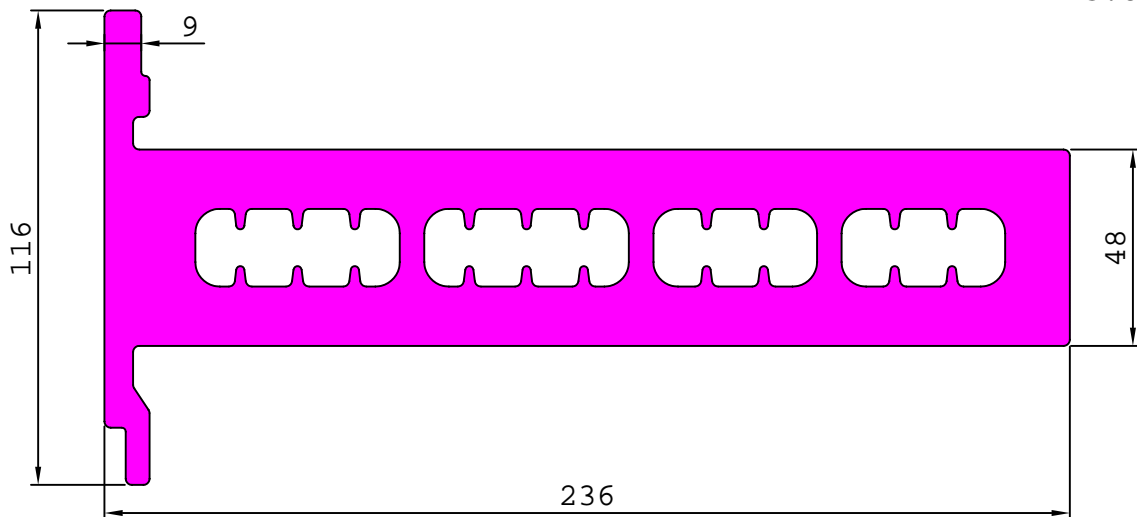

INDUSTRIAL

ELECTRONICS

25816 0.374 kg/m

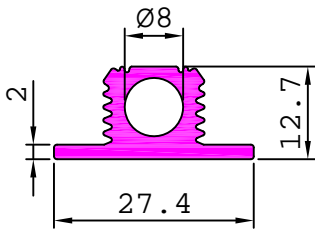

25818 0.468 kg/m

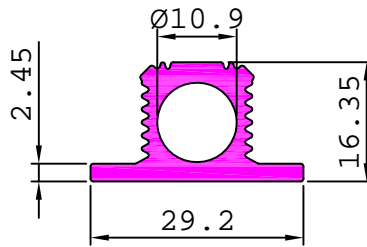

29003 0.458 kg/m

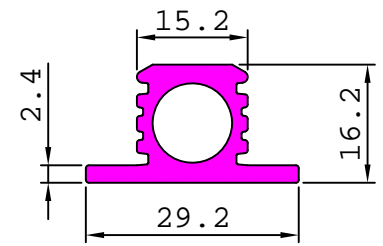

25817 3.069 kg/m

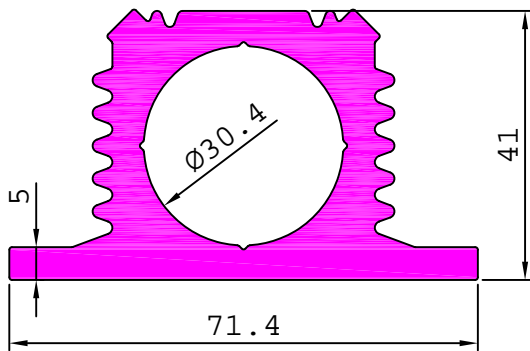

29195 2.561 kg/m

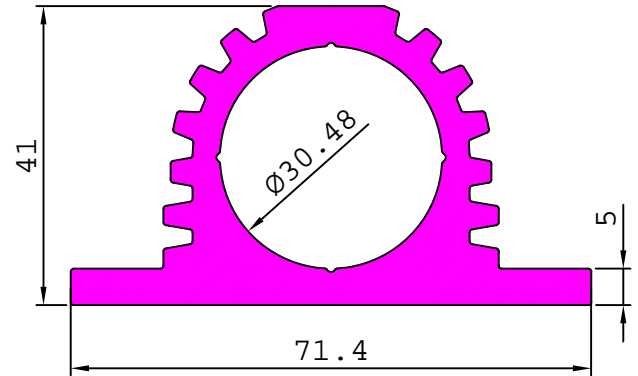

25819 1.169 kg/m

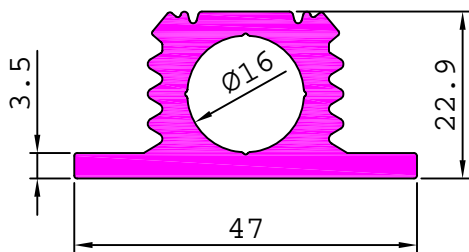

S4855 0.501 kg/m

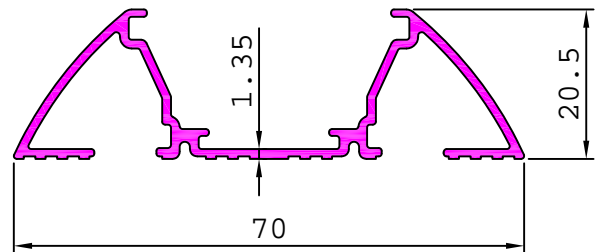

25281 0.723 kg/m

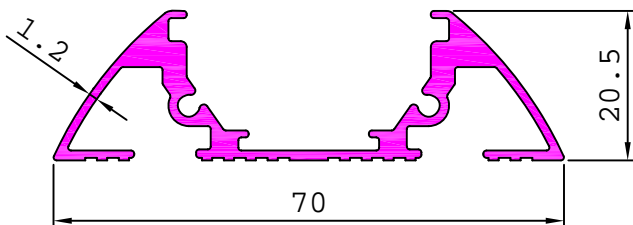

S4854 0.550 kg/m

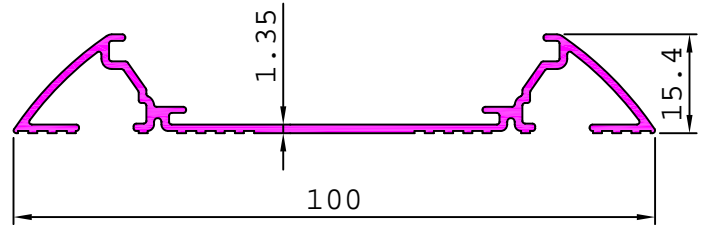

28196

1.448 kg/m

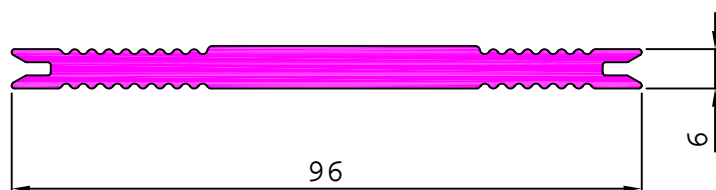

INDUSTRIAL

ELECTRONICS

29329

4.836 kg/m

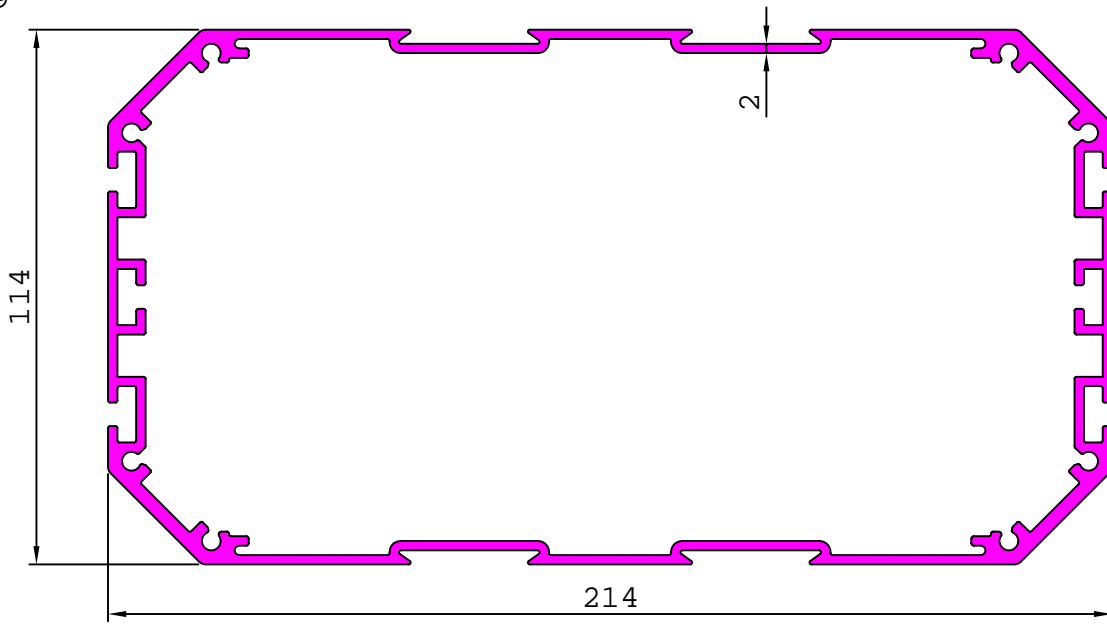

29409

4.506 kg/m

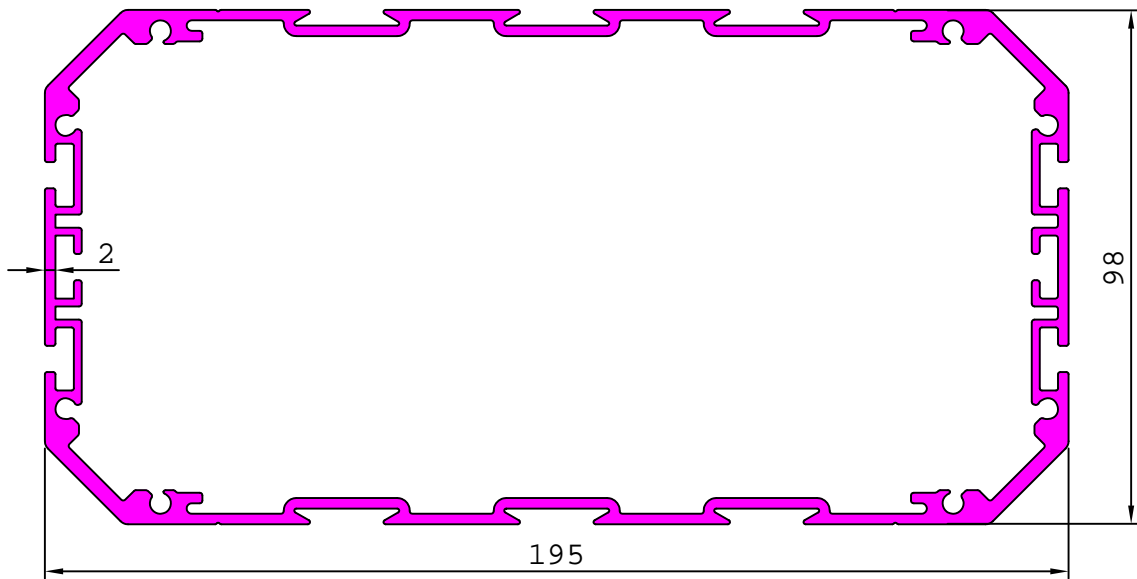

INDUSTRIAL

ELECTRONICS

S4342

10.206 kg/m

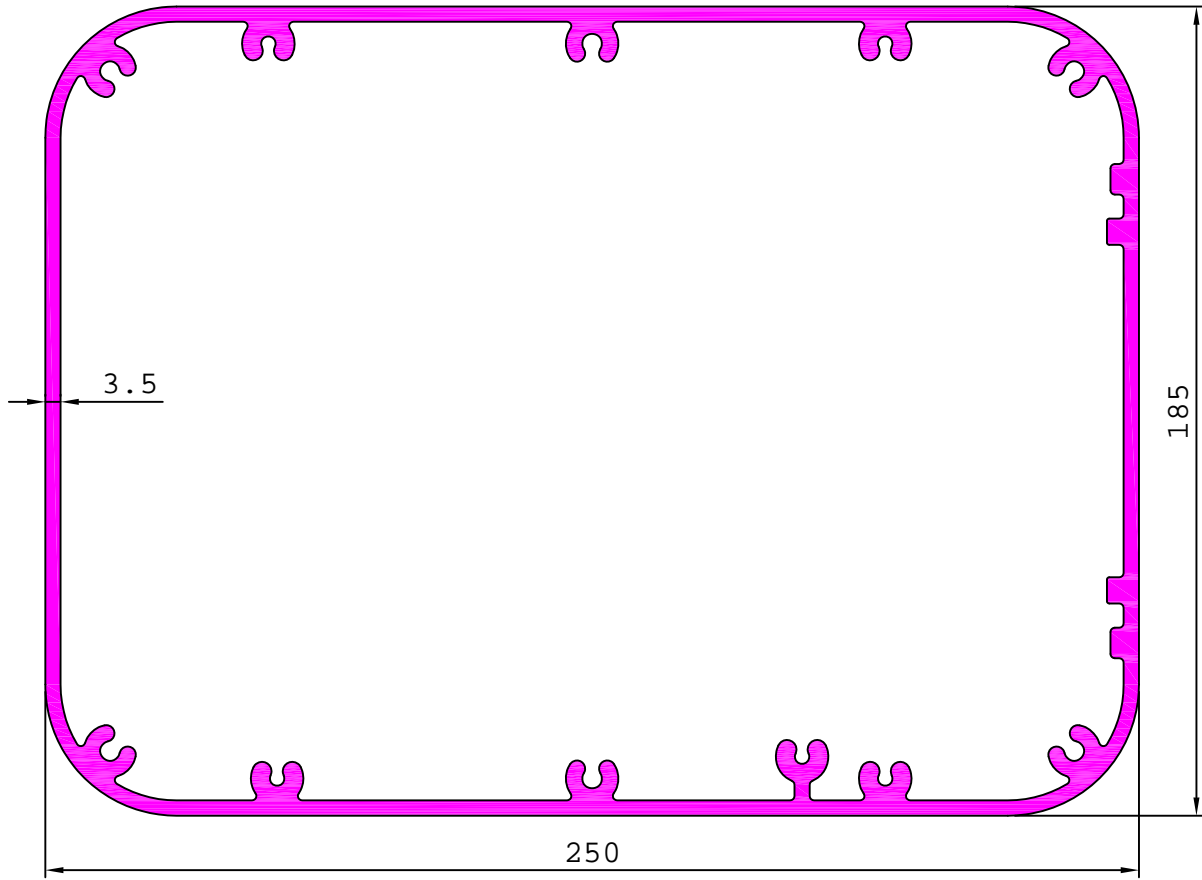

S5166

8.130 kg/m

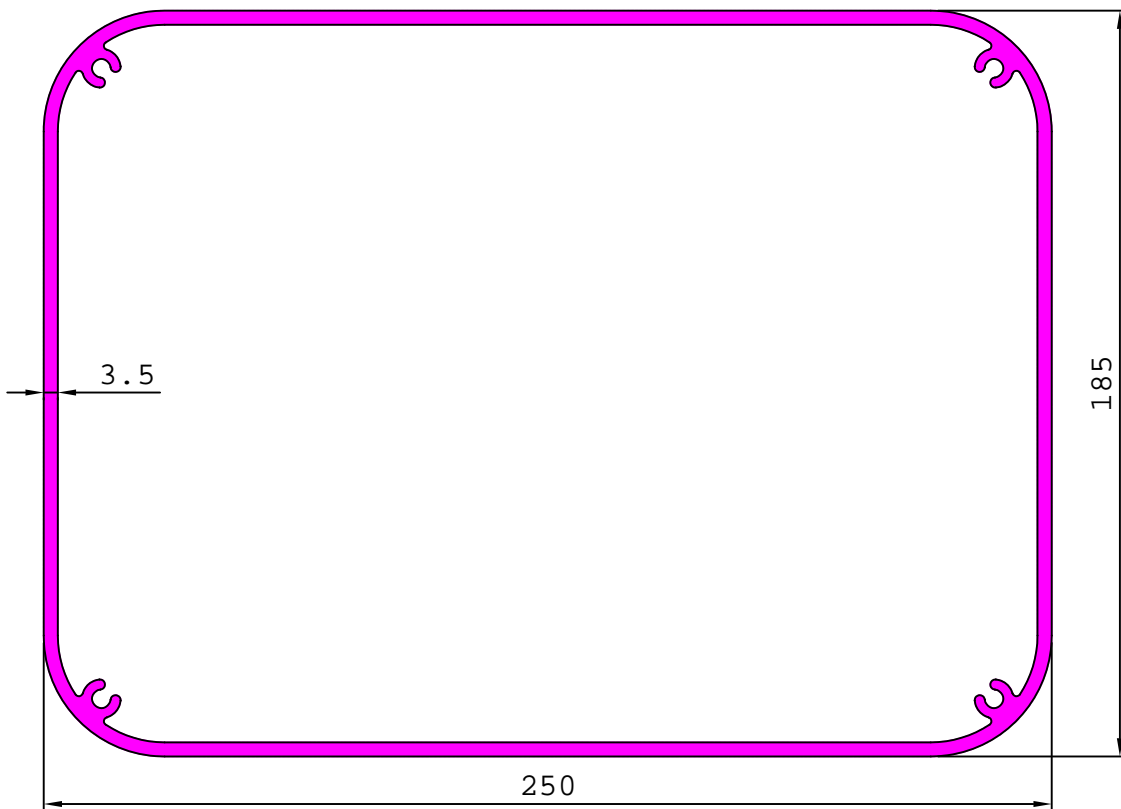

INDUSTRIAL

ELECTRONICS

28144

4.240 kg/m

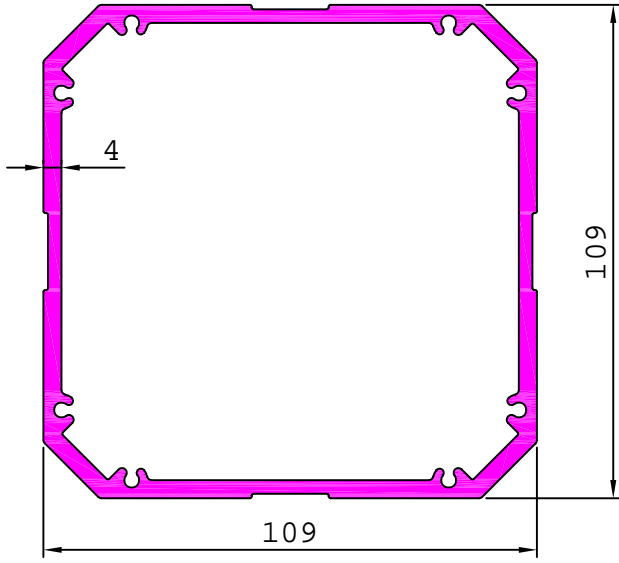

29563

4.650 kg/m

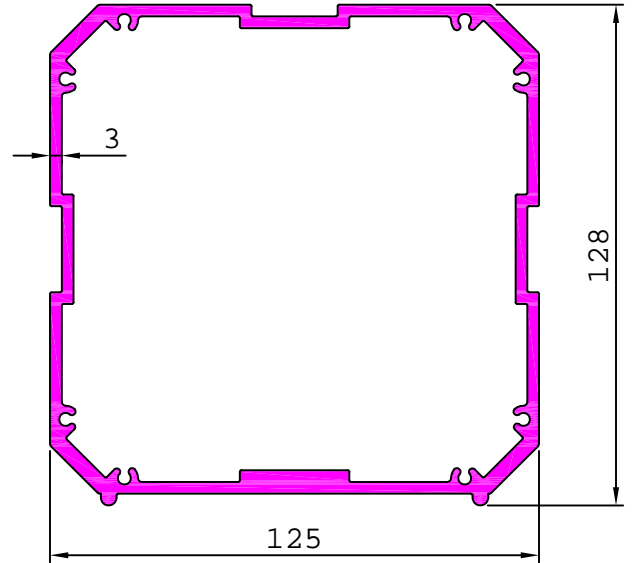

INDUSTRIAL

SOLAR POWER SECTION

26206 0.622 kg/m

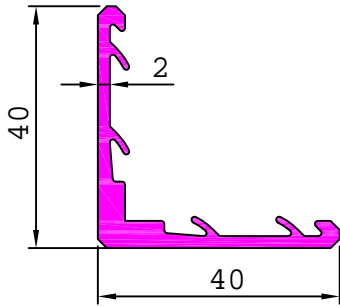

26215 0.365 kg/m

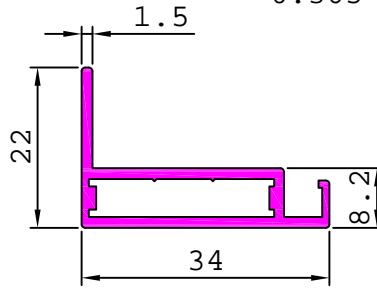

26214 0.261 kg/m

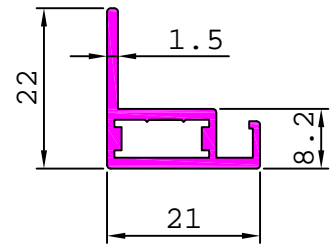

26210 0.578 kg/m

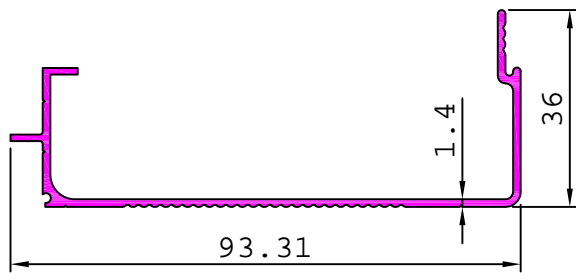

26211 0.688 kg/m

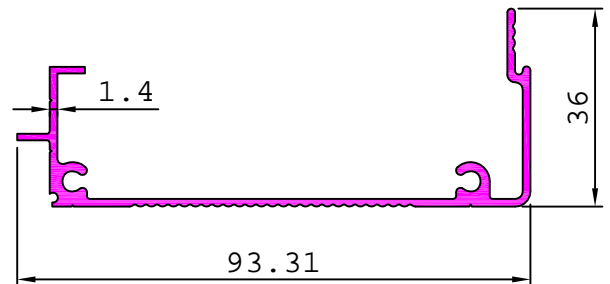

26216 0.941 kg/m

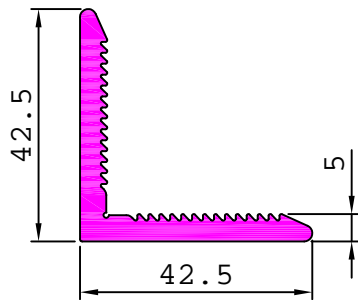

26217 0.552 kg/m

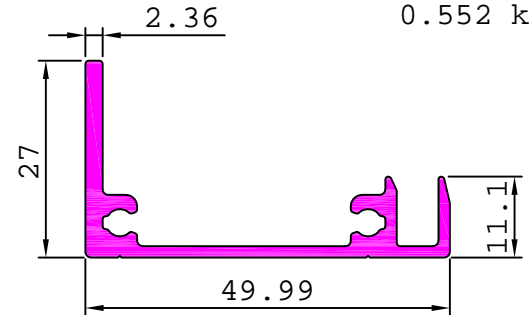

26219 0.285 kg/m

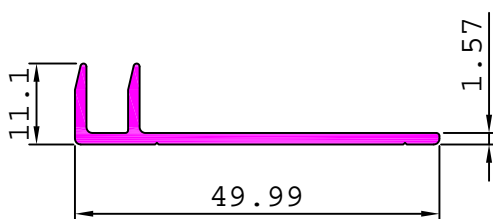

26225 0.829 kg/m

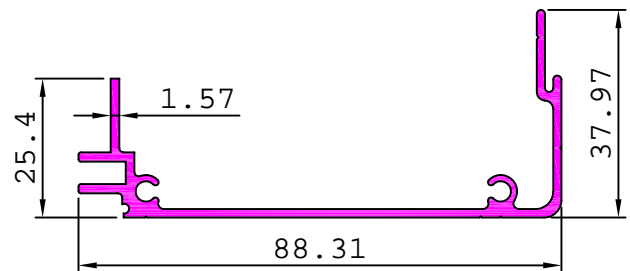

26224 0.141 kg/m

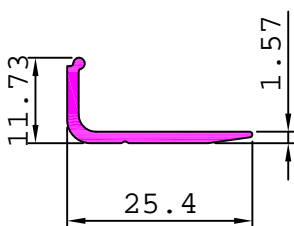

26232 0.111 kg/m

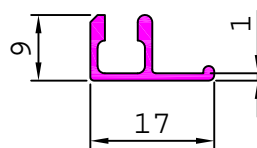

26233 0.163 kg/m

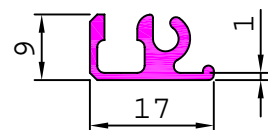

INDUSTRIAL

SOLAR POWER SECTION

26235 0.494 kg/m

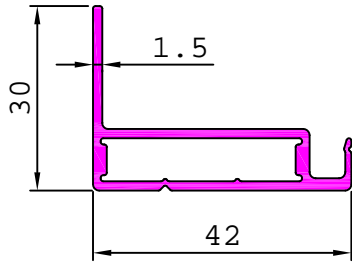

26240 0.339 kg/m

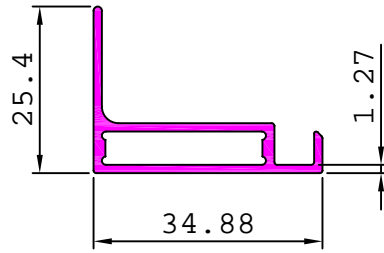

26241 0.633 kg/m

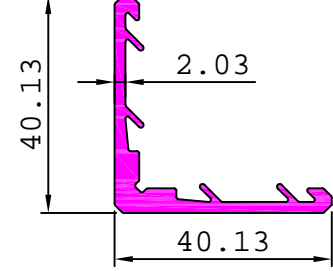

26242 0.605 kg/m

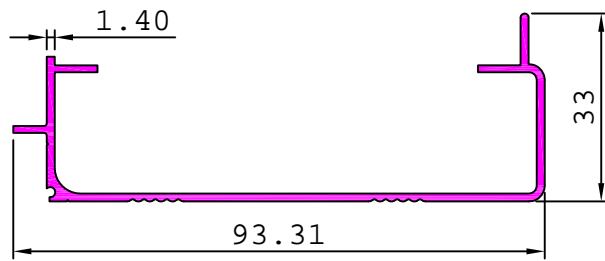

26243 0.716 kg/m

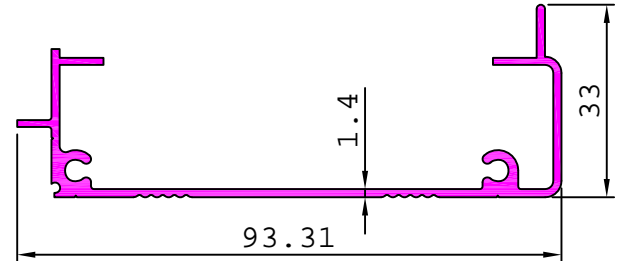

26244 0.198 kg/m

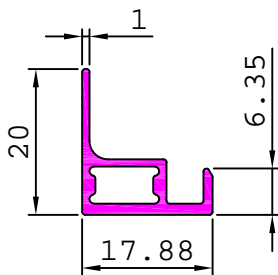

26245 0.780 kg/m

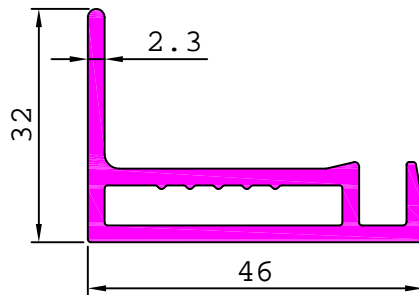

26249 0.531 kg/m

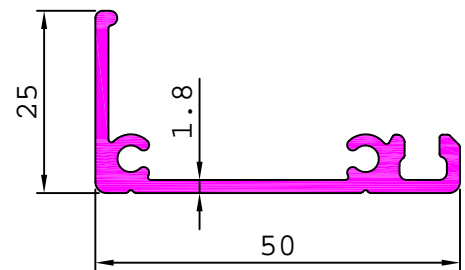

26250 0.315 kg/m

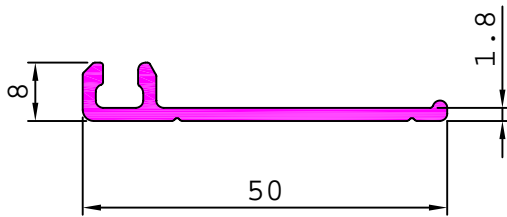

26251 0.483 kg/m

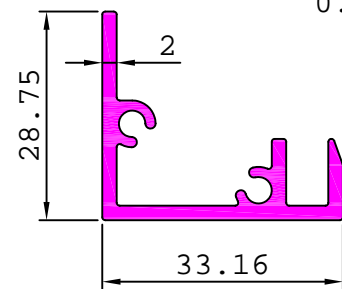

26253 0.627 kg/m

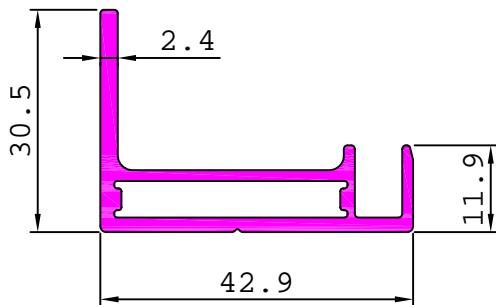

26259 0.374 kg/m

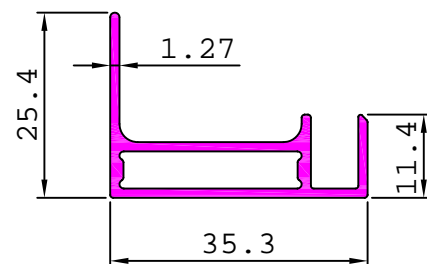

INDUSTRIAL

SOLAR POWER SECTION

26256 0.256 kg/m

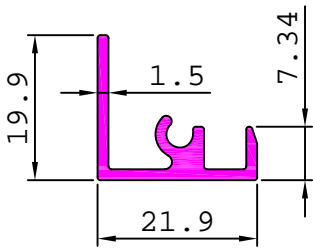

26257 0.133 kg/m

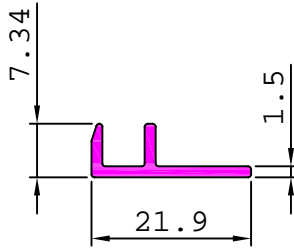

26258 0.270 kg/m

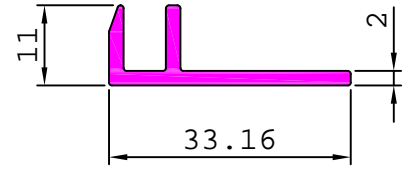

26261 0.113 kg/m

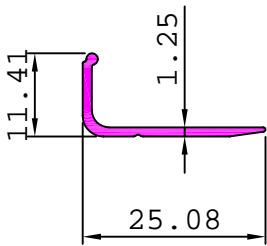

26263 0.719 kg/m

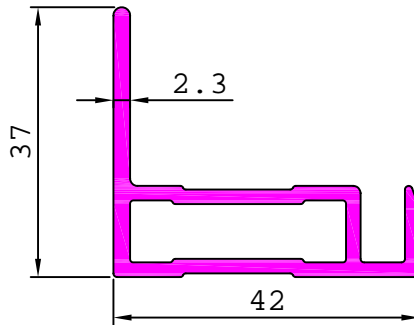

26266 0.372 kg/m

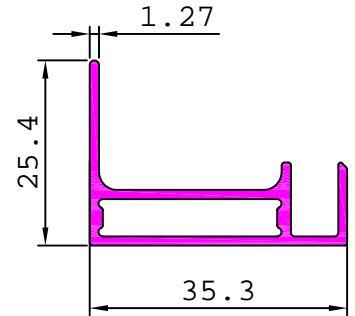

26267 0.173 kg/m

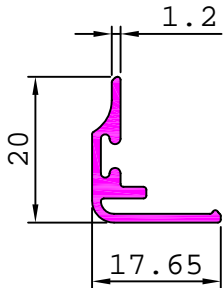

26269 0.631 kg/m

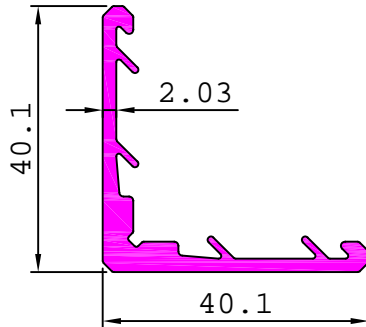

26270 0.378 kg/m

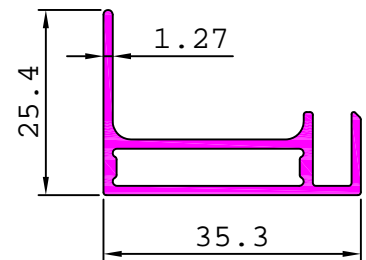

26268 0.708 kg/m

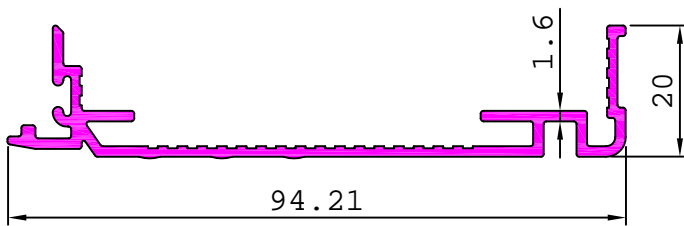

26271 0.471 kg/m

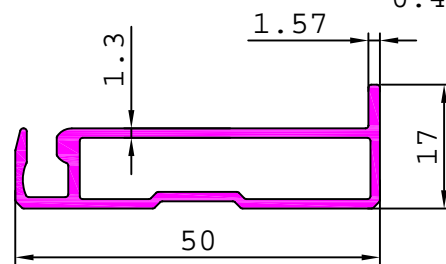

26272 0.344 kg/m

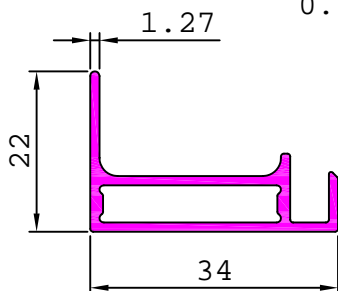

26273 0.902 kg/m

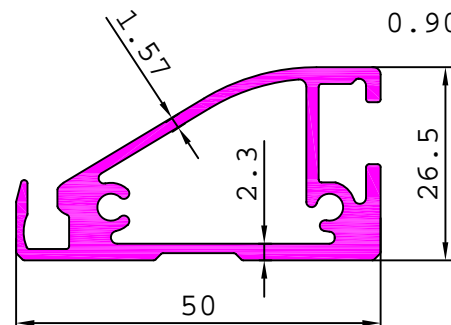

INDUSTRIAL

SOLAR POWER SECTION

26274

0.618 kg/m

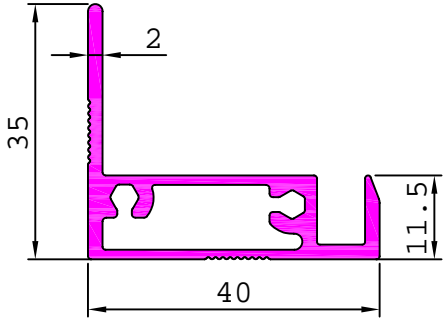

26275

0.525 kg/m

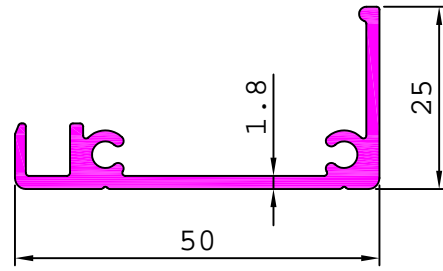

26276

0.680 kg/m

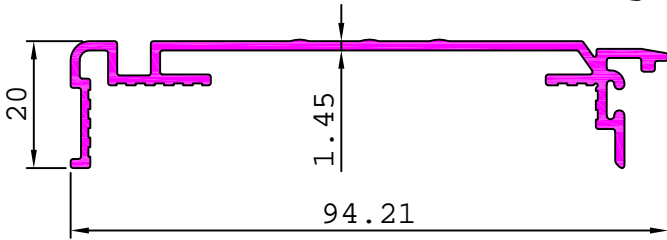

26282

0.571 kg/m

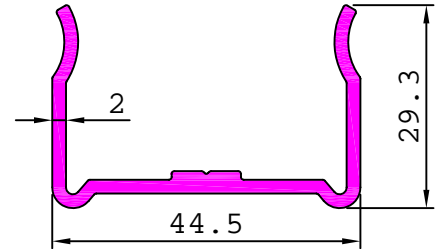

26277

0.308 kg/m

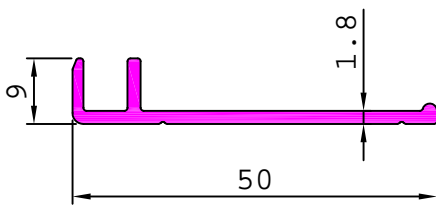

26278

0.355 kg/m

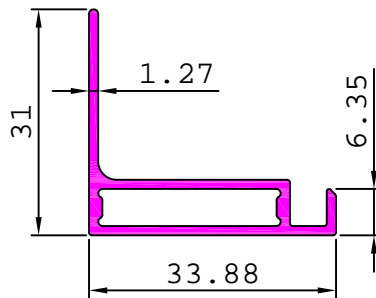

26279

0.721 kg/m

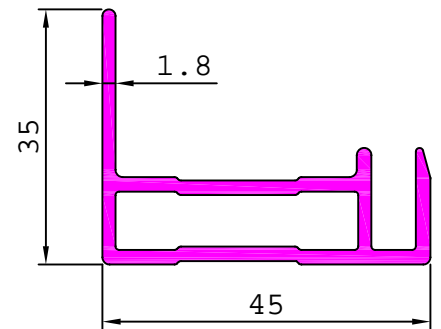

26280

0.967 kg/m

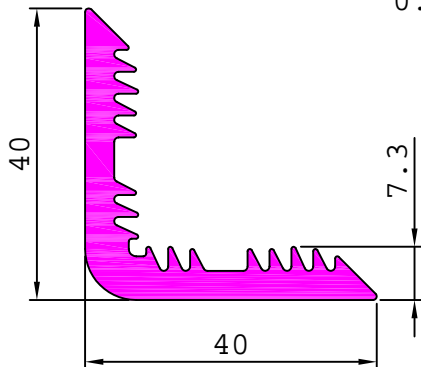

26281

1.055 kg/m

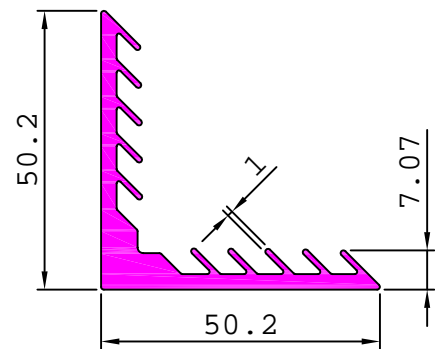

26284

0.614 kg/m

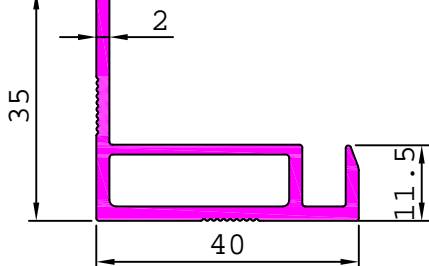

26285

0.648 kg/m

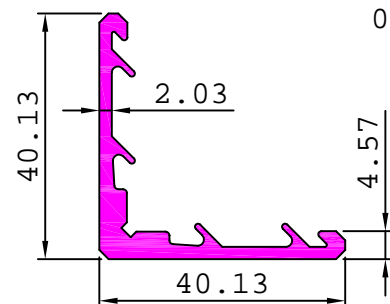

INDUSTRIAL

SOLAR POWER SECTION

26283 0.862 kg/m

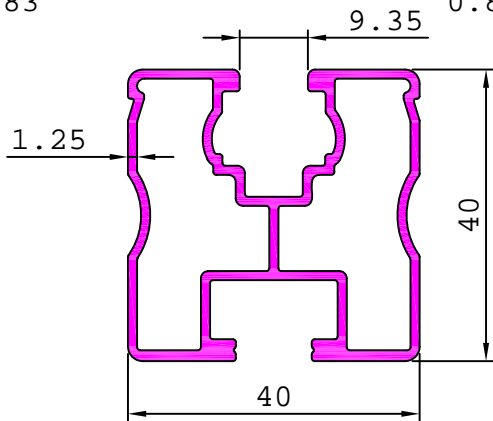

S5164 1.176 kg/m

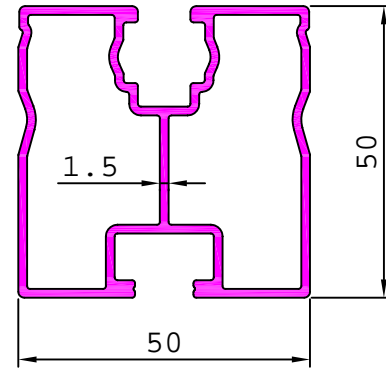

26286 0.741 kg/m

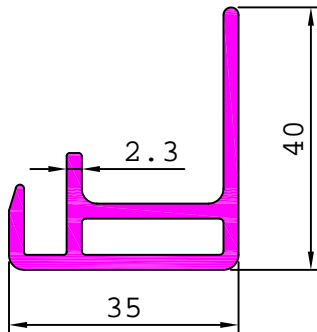

26287 0.273 kg/m

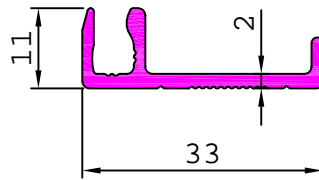

26288 0.419 kg/m

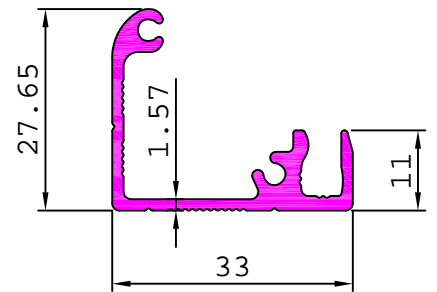

26289 0.595 kg/m

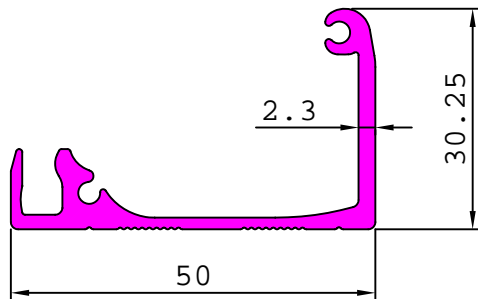

26290 0.599 kg/m

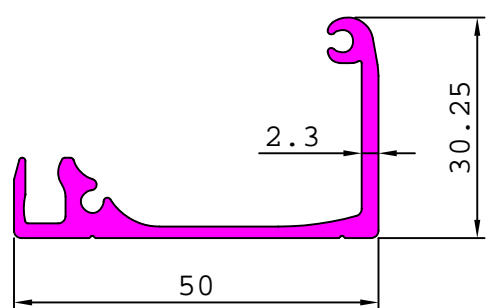

26291 0.454 kg/m

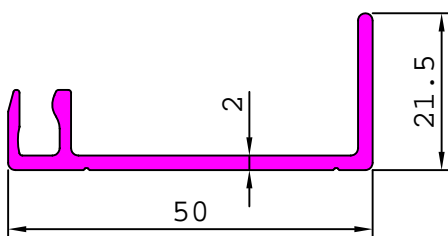

26295 0.419 kg/m

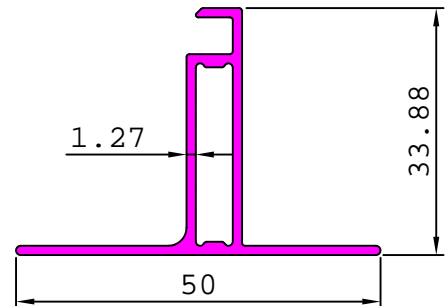

26294 0.380 kg/m

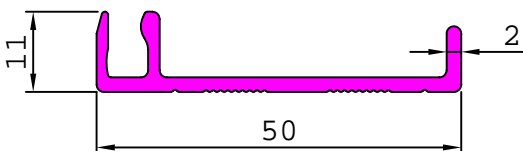

26299 0.343 kg/m

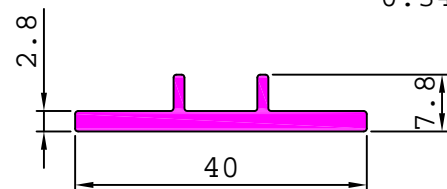

INDUSTRIAL

SOLAR POWER SECTION

26292

1.028 kg/m

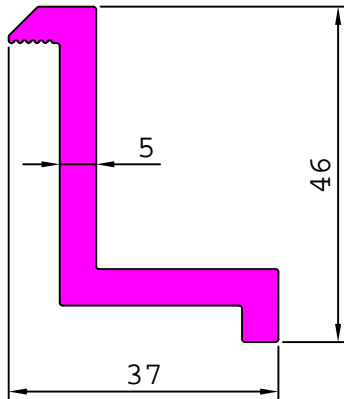

26293

0.933 kg/m

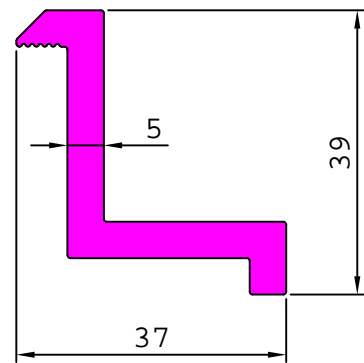

27909

1.365 kg/m

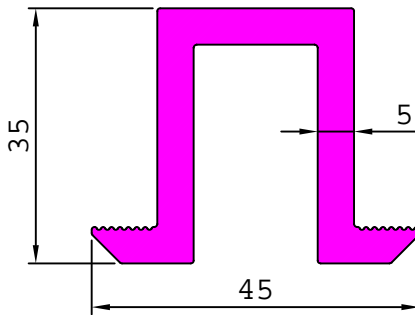

26296

0.404 kg/m

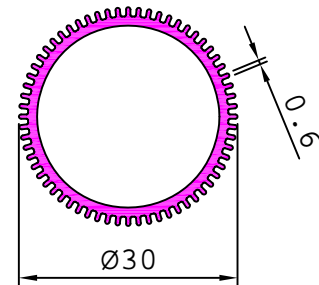

26297

0.642 kg/m

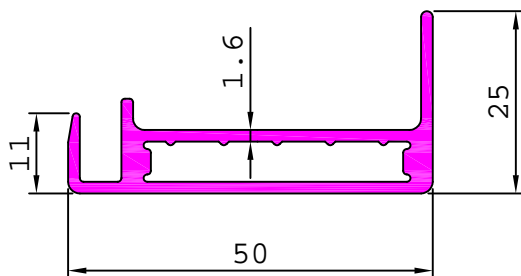

26298

0.520 kg/m

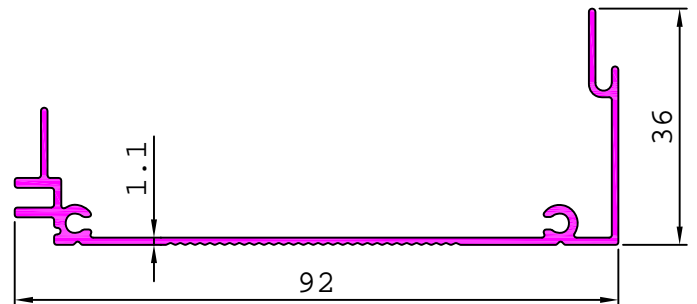

26300

0.475 kg/m

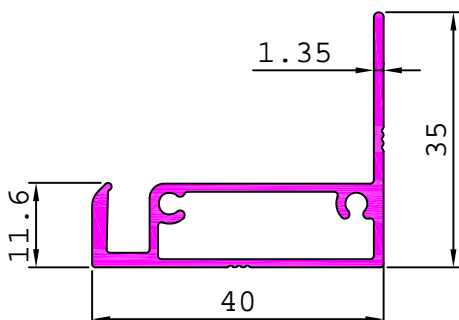

38001

0.392 kg/m

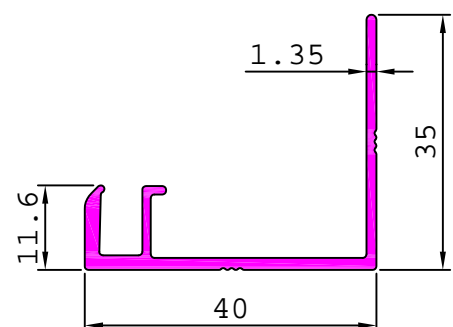

INDUSTRIAL

SOLAR POWER SECTION

38002

0.837 kg/m

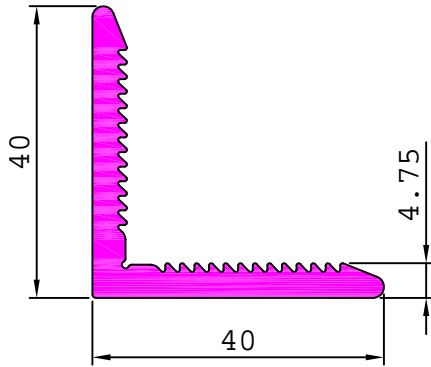

38003

0.636 kg/m

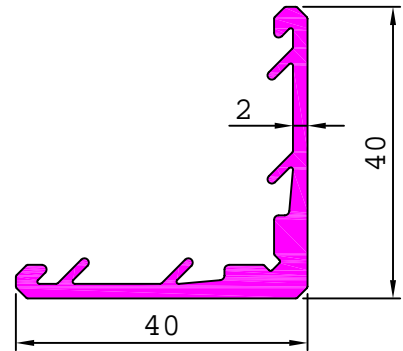

38004

0.546 kg/m

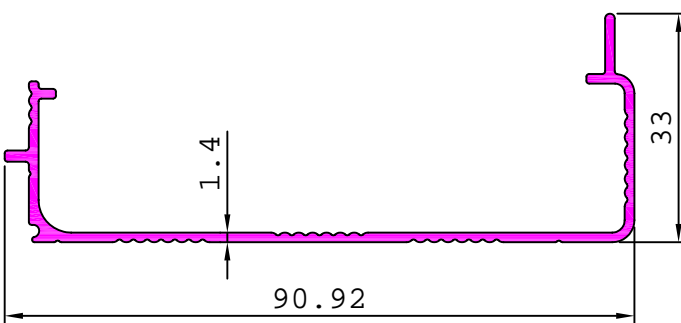

38005

0.650 kg/m

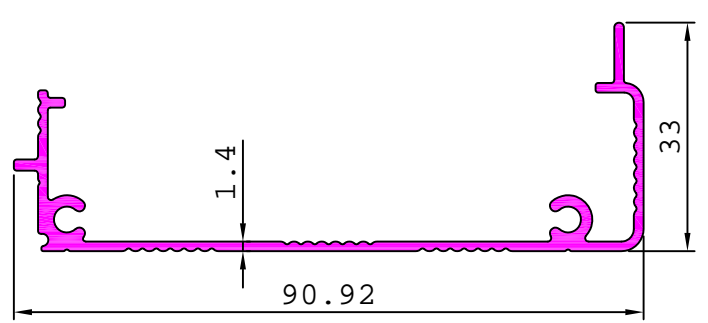

38006

0.473 kg/m

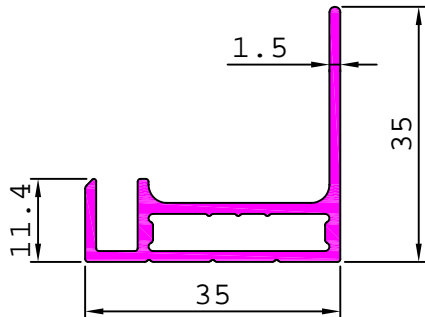

38007

1.201 kg/m

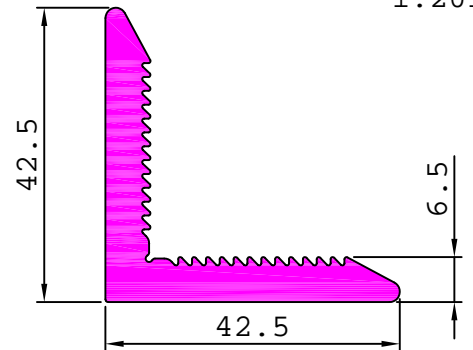

S4389

0.660 kg/m

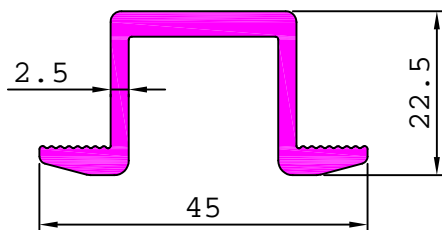

S4507

0.274 kg/m

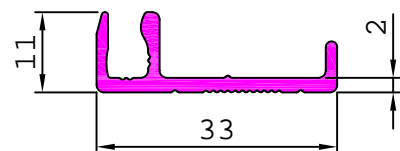

S4508

0.418 kg/m

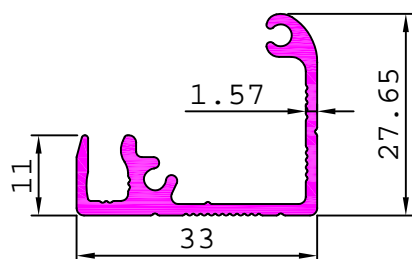

S4509

0.277 kg/m

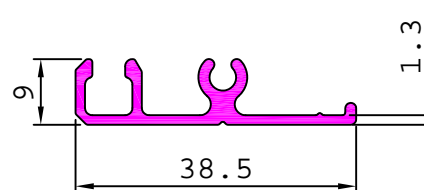

INDUSTRIAL

SOLAR POWER SECTION

S4510

0.254 kg/m

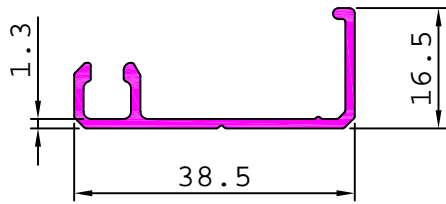

S4923

0.466 kg/m

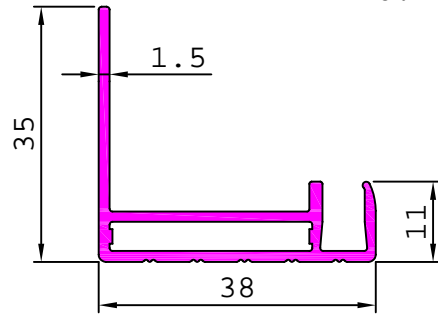

S4924

0.725 kg/m

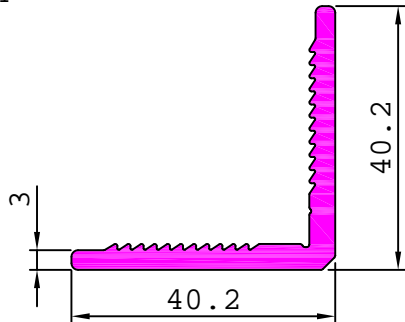

S4936

0.402 kg/m

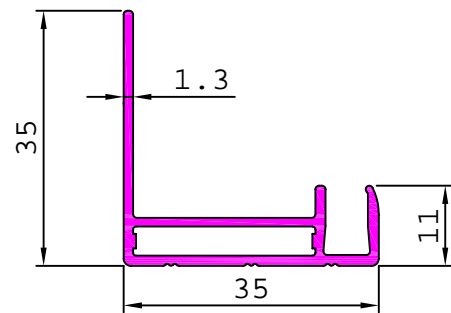

S5041

0.374 kg/m

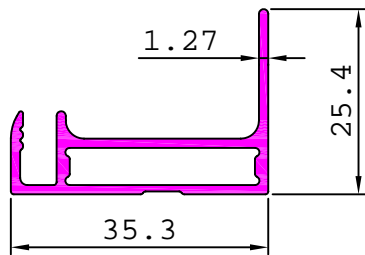

S5042

0.339 kg/m

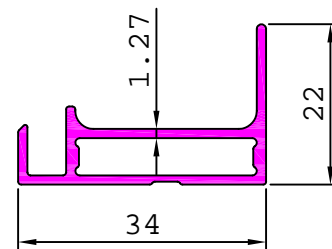

S4334

0.954 kg/m

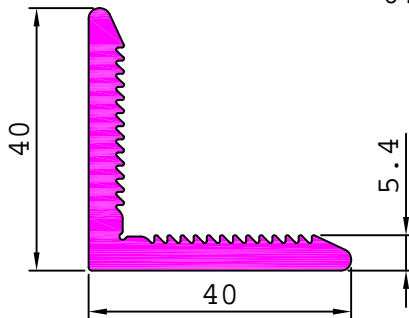

S4335

0.474 kg/m

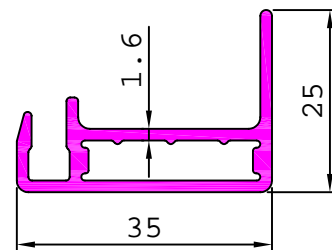

S4483

0.380 kg/m

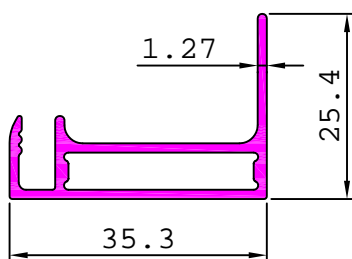

S4321

0.493 kg/m

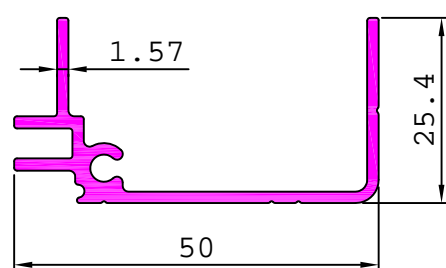

INDUSTRIAL

HEAT SINKS

26301

5.511 kg/m

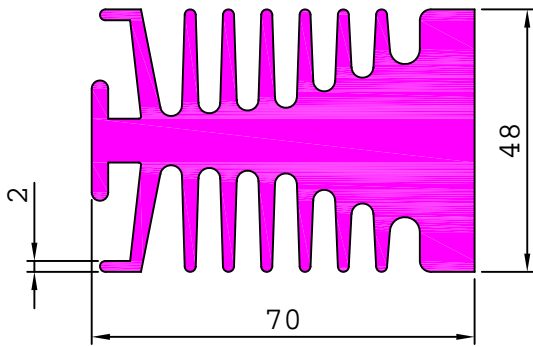

26302

2.864 kg/m

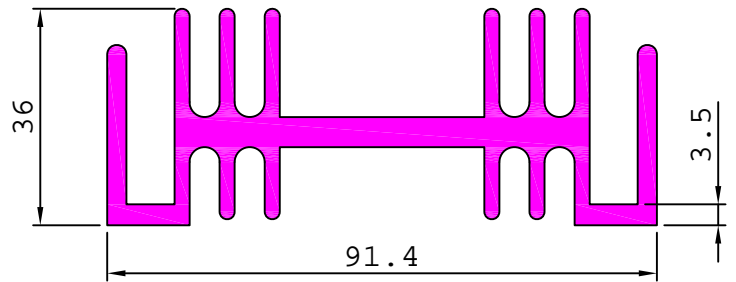

26303

4.860 kg/m

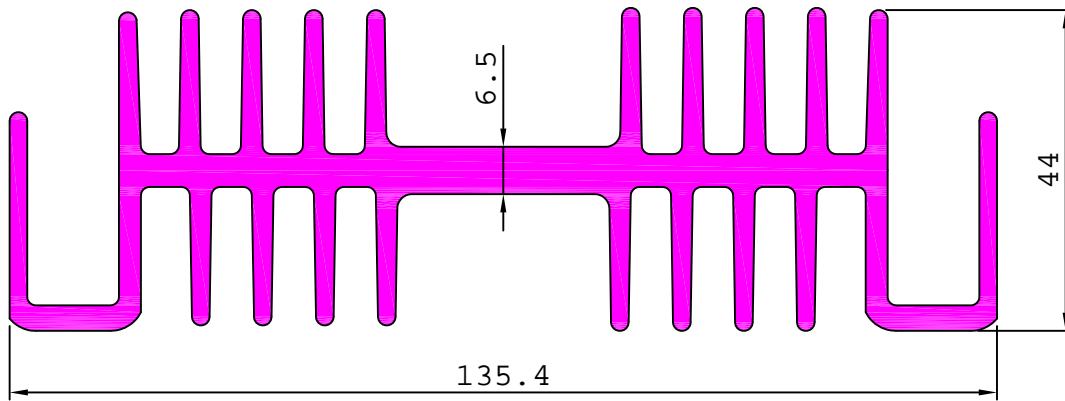

26304

4.097 kg/m

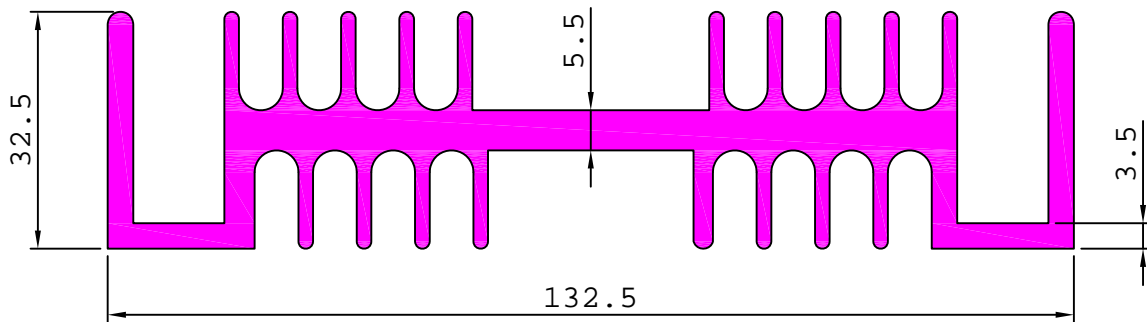

26305

1.824 kg/m

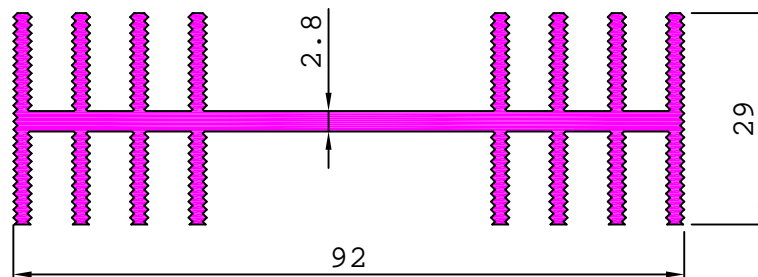

INDUSTRIAL

HEAT SINKS

26308

8.990 kg/m

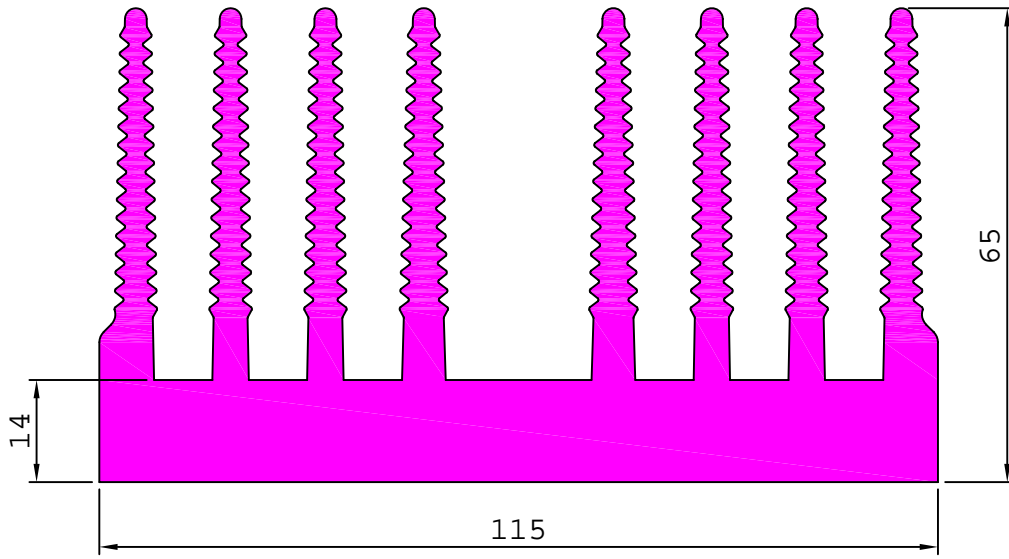

26309

13.932 kg/m

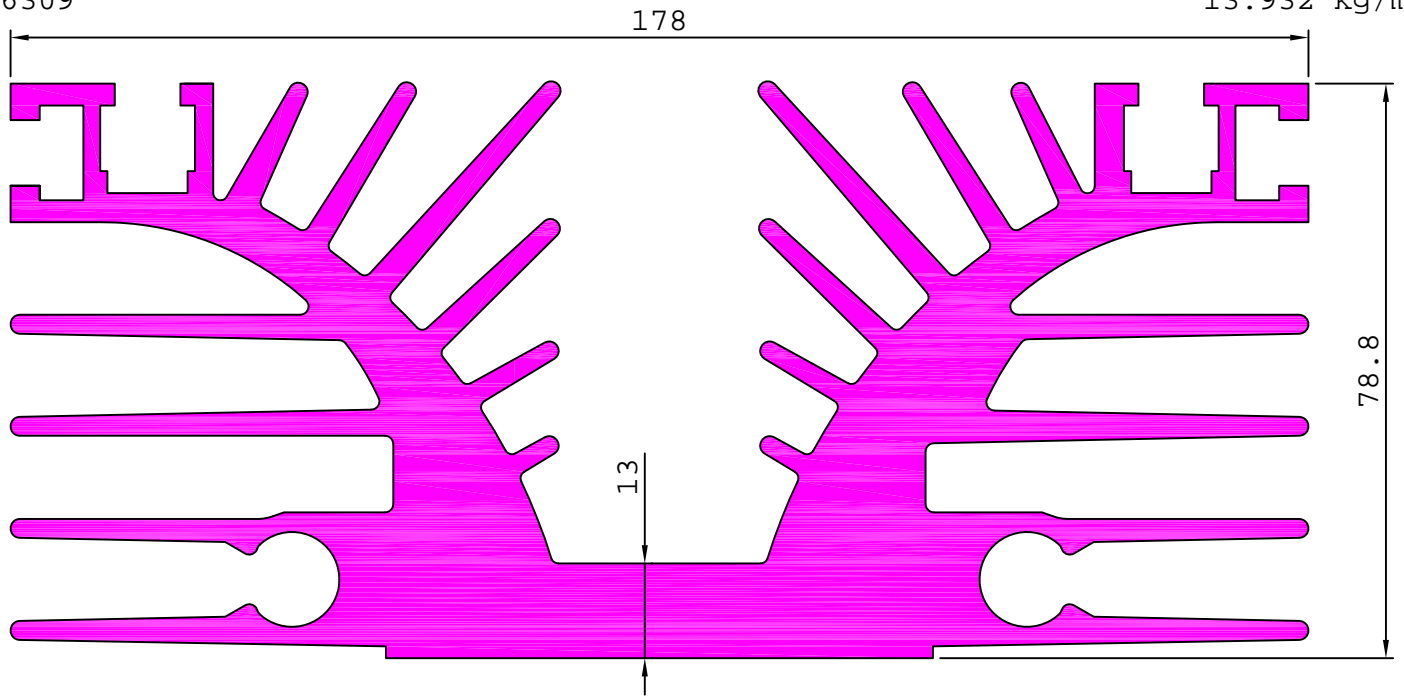

26310

6.666 kg/m

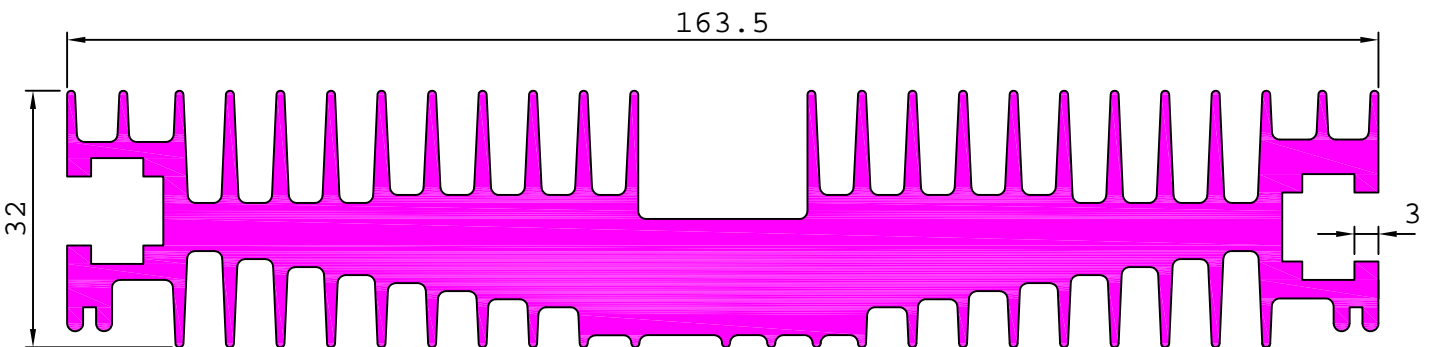

INDUSTRIAL

HEAT SINKS

26312

1.146 kg/m

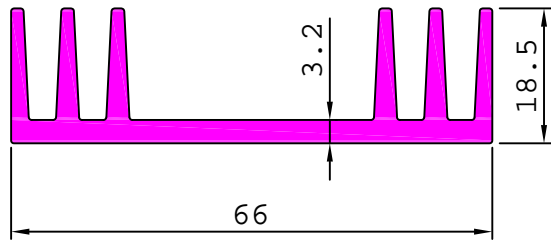

26313

1.177 kg/m

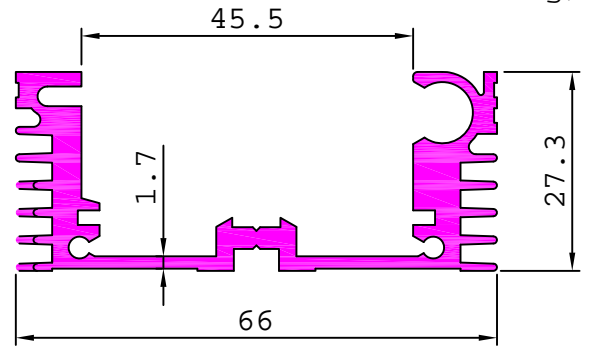

26315

0.930 kg/m

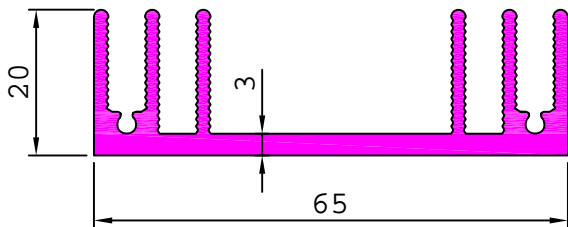

26321

0.552 kg/m

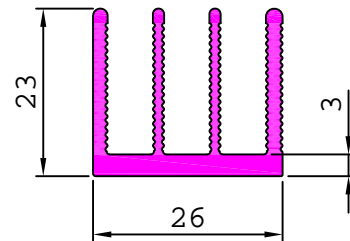

26317

4.558 kg/m

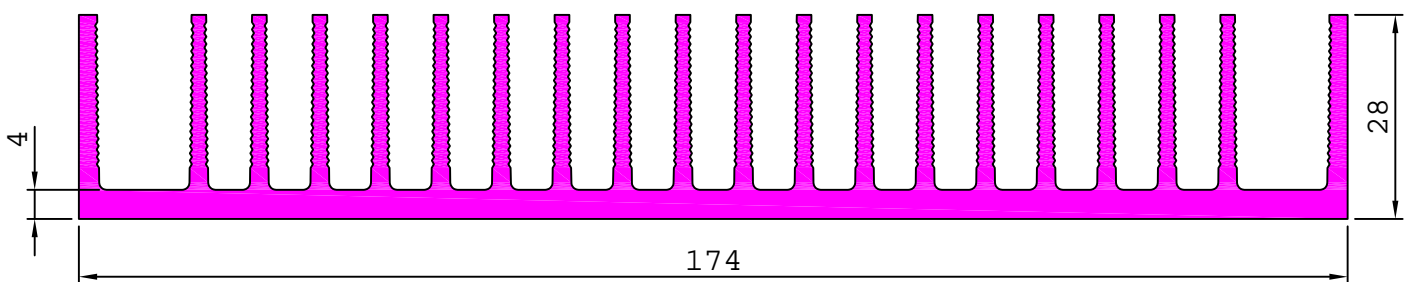

26318

178

13.933 kg/m

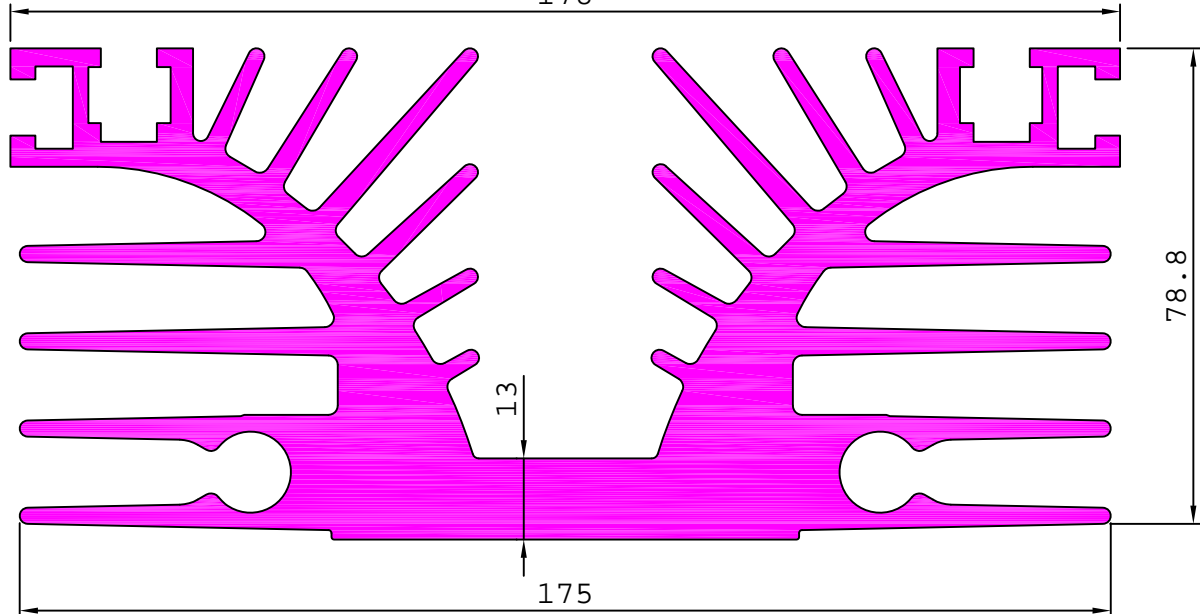

INDUSTRIAL

HEAT SINKS

26320

10.746 kg/m

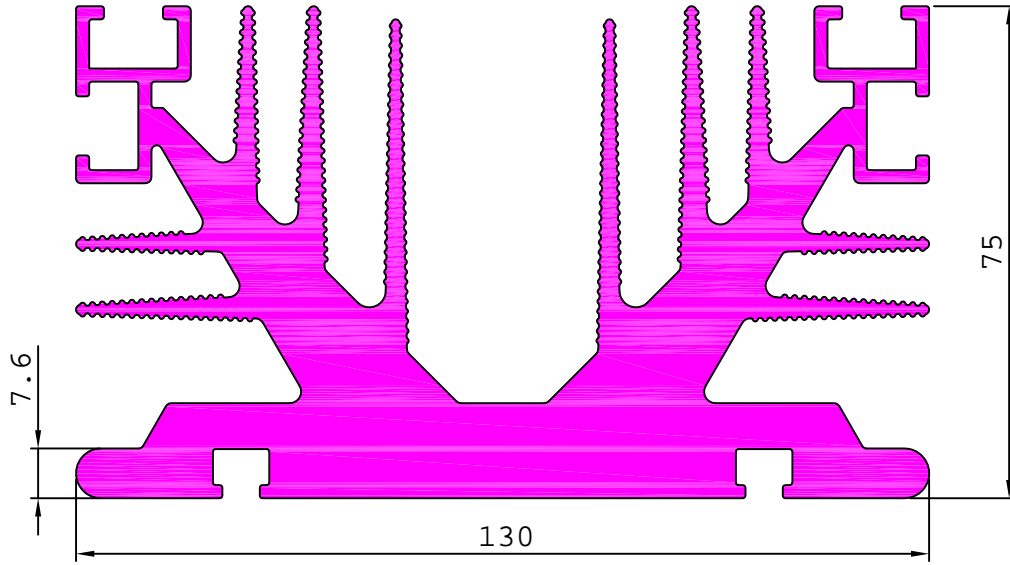

26323

9.504 kg/m

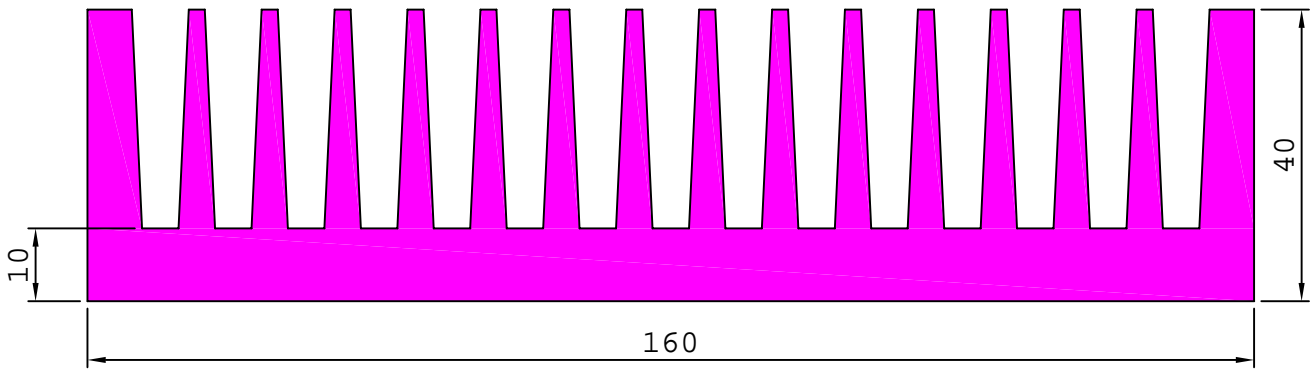

26337

7.722 kg/m

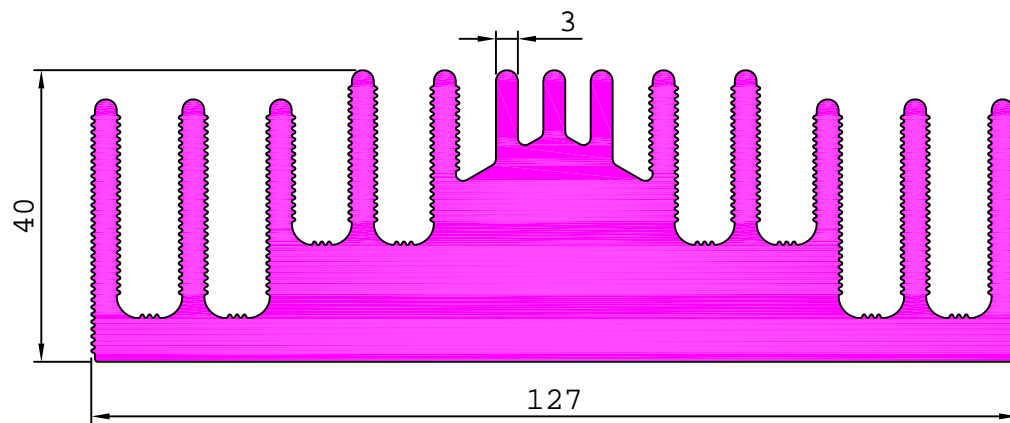

26346

0.334 kg/m

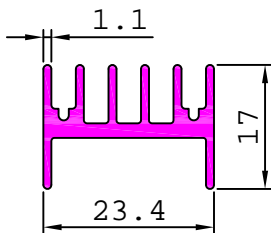

26350

0.259 kg/m

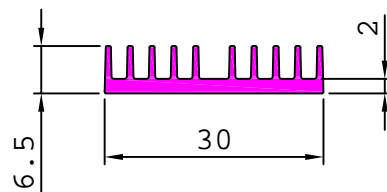

INDUSTRIAL

HEAT SINKS

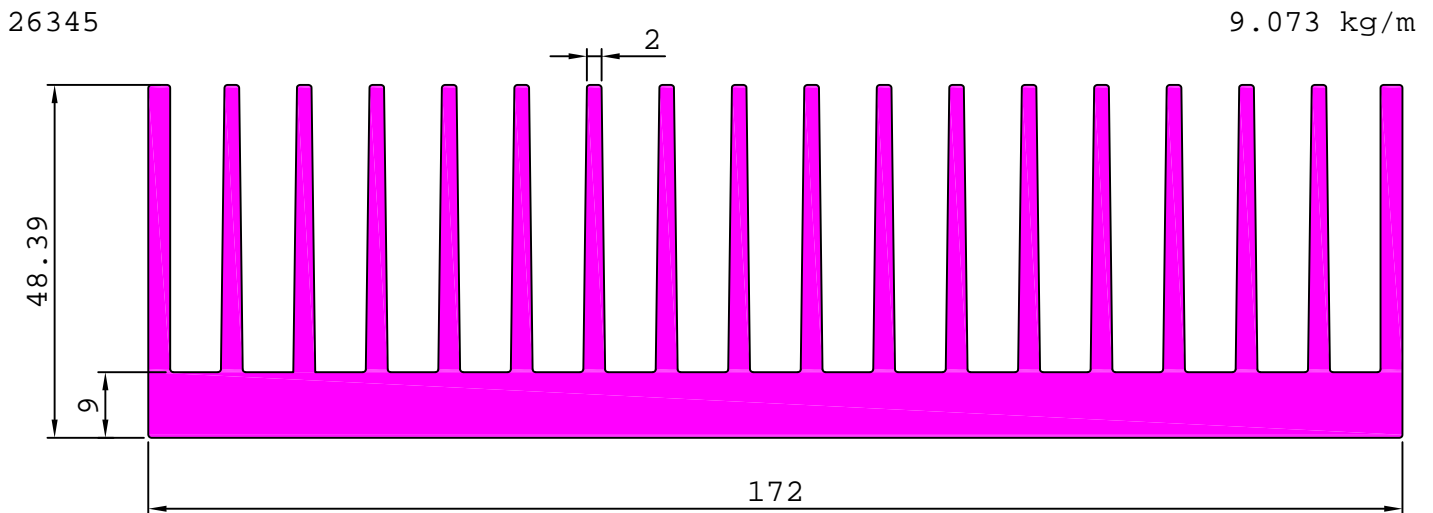
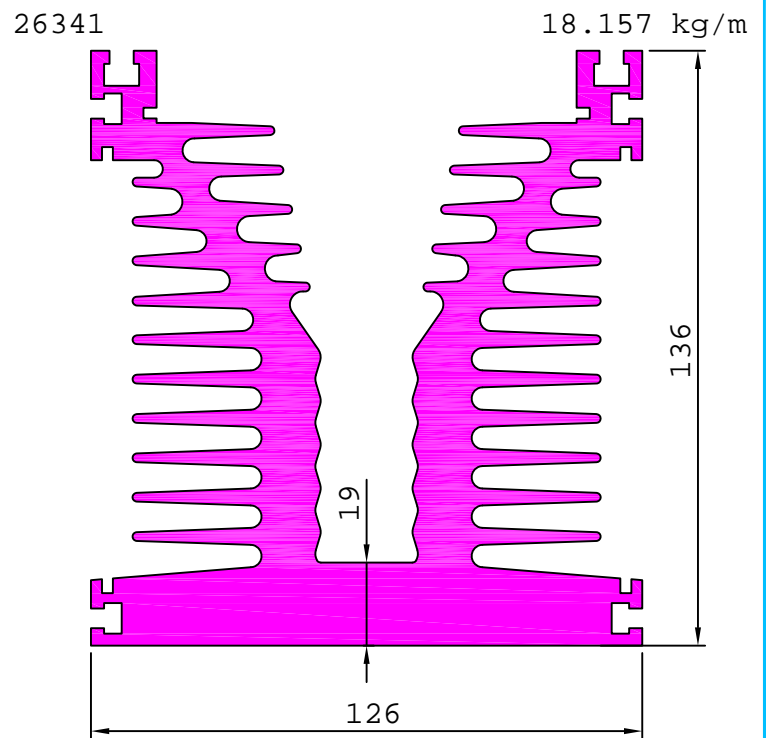
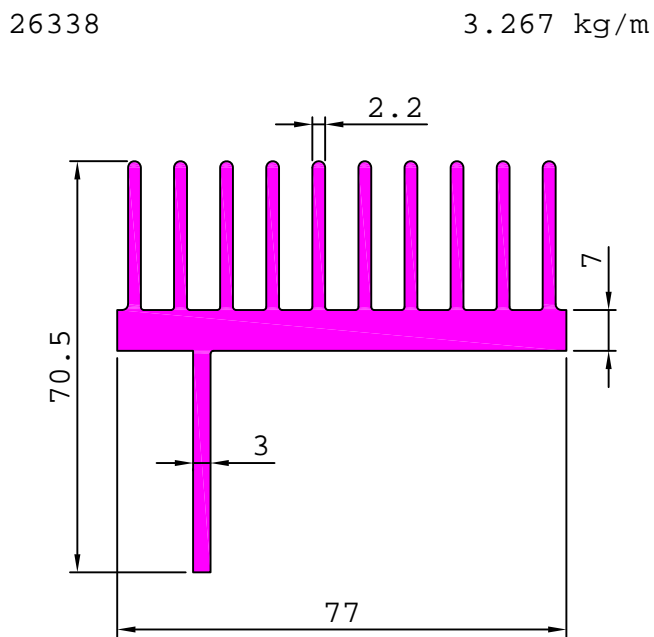
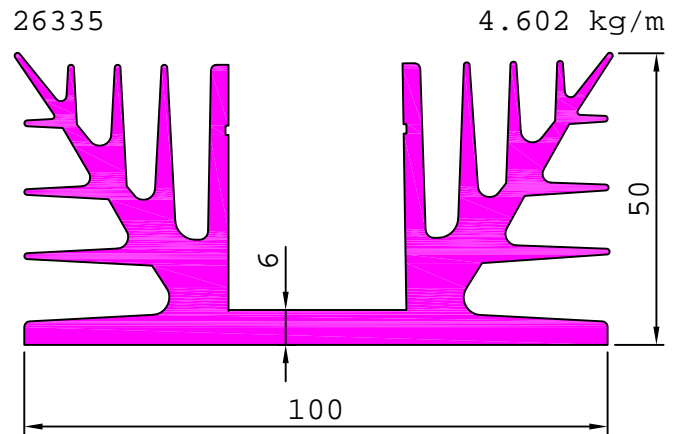
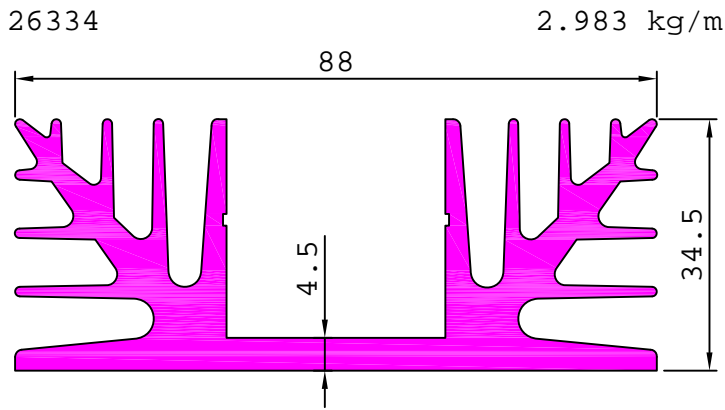

INDUSTRIAL

HEAT SINKS

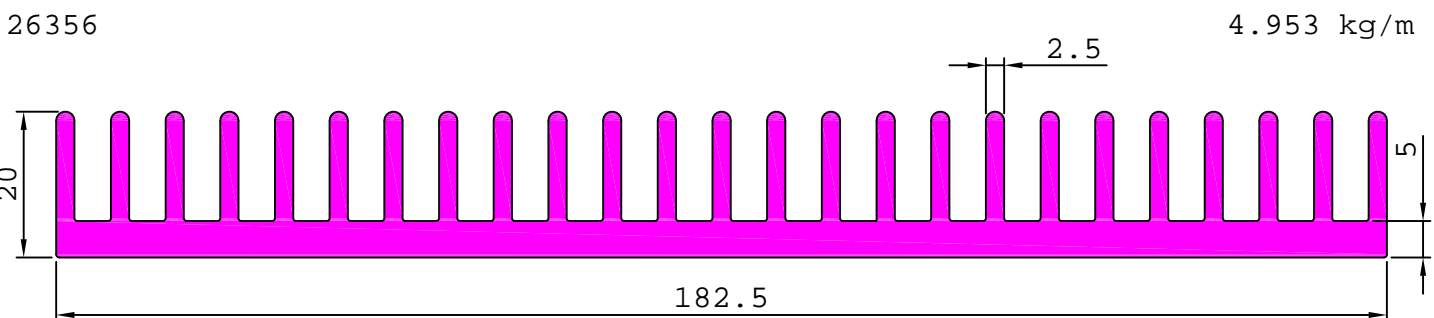
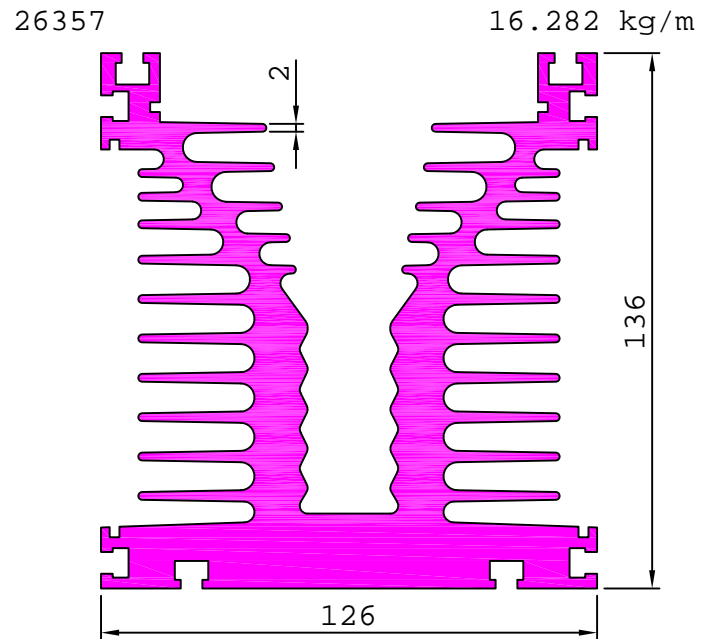
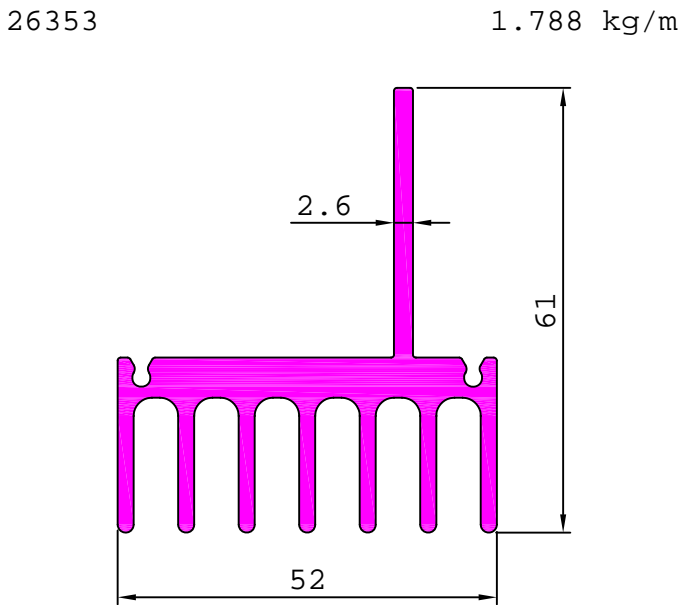
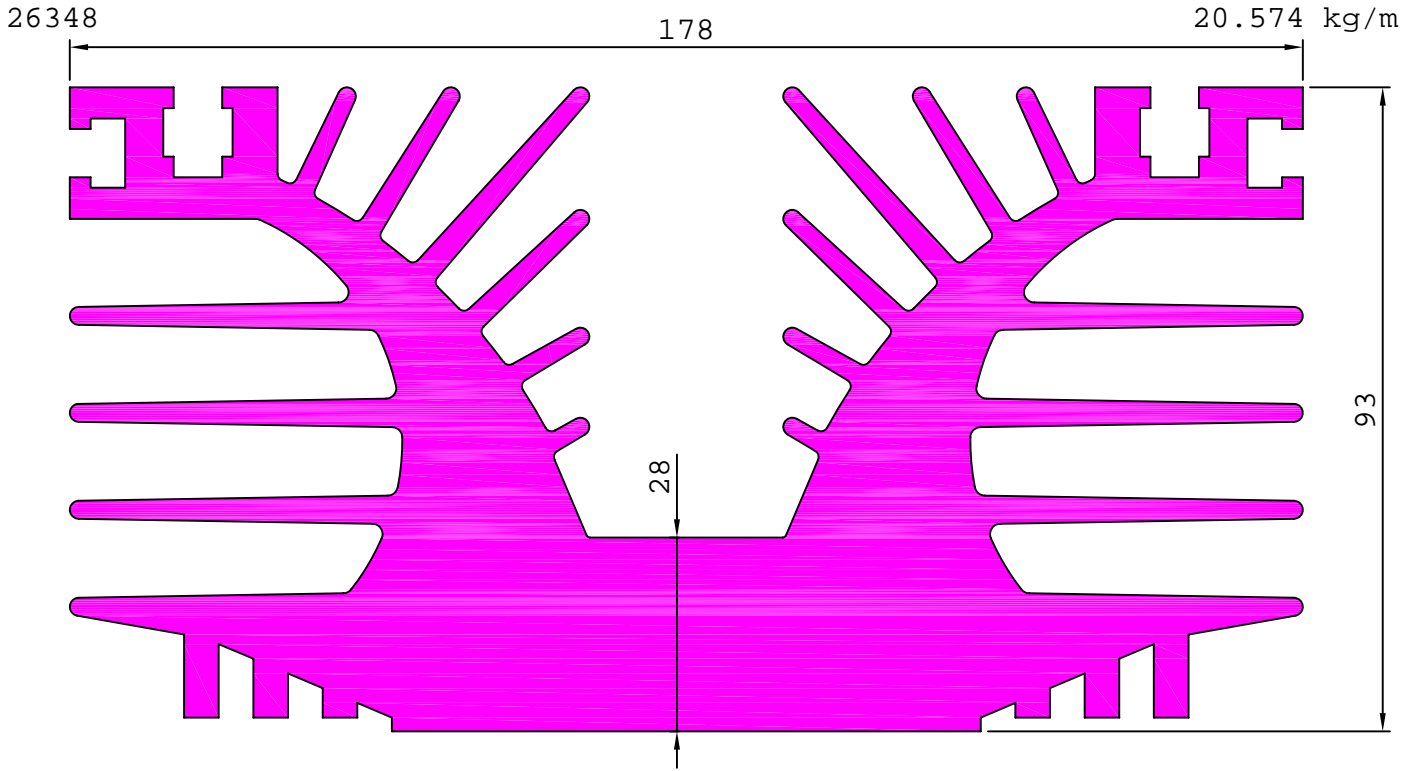

INDUSTRIAL

HEAT SINKS

26360

3.535 kg/m

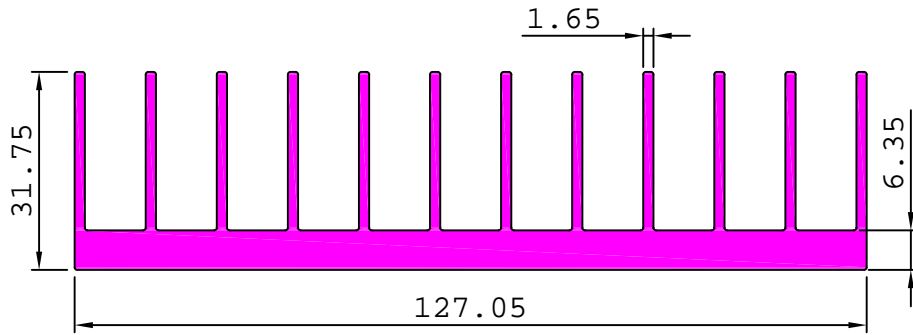

26358

3.113 kg/m

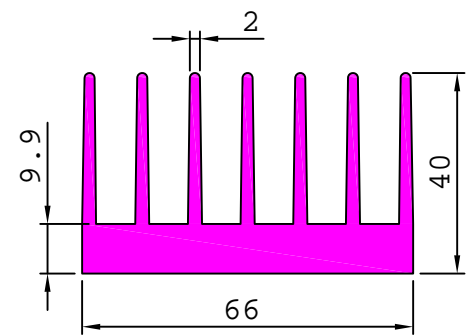

26362

1.401 kg/m

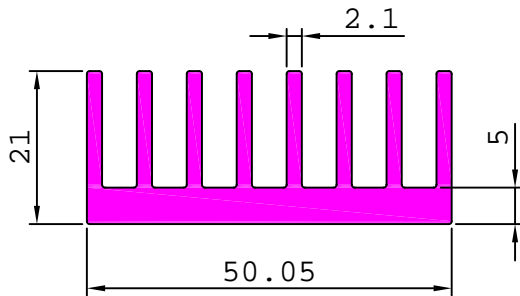

26365

2.013 kg/m

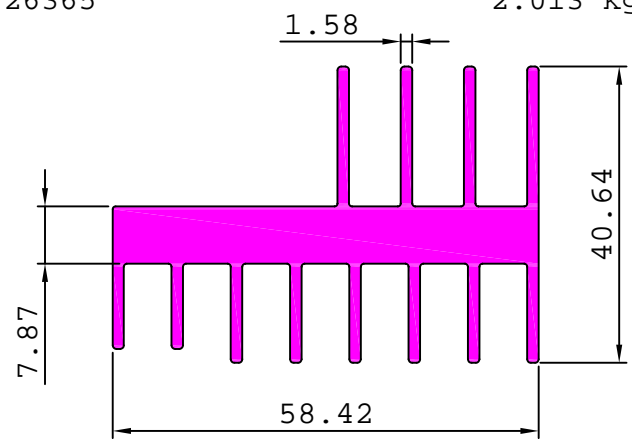

26368

3.366 kg/m

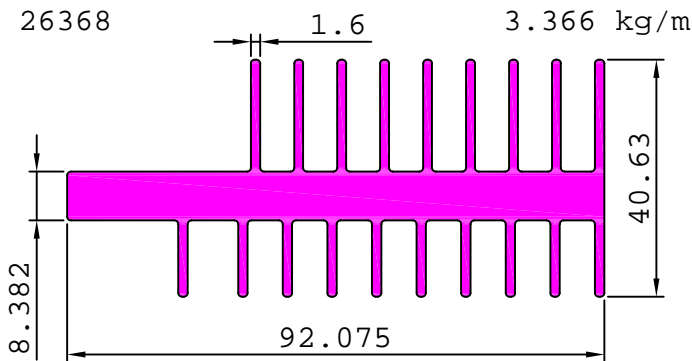

26370

2.345 kg/m

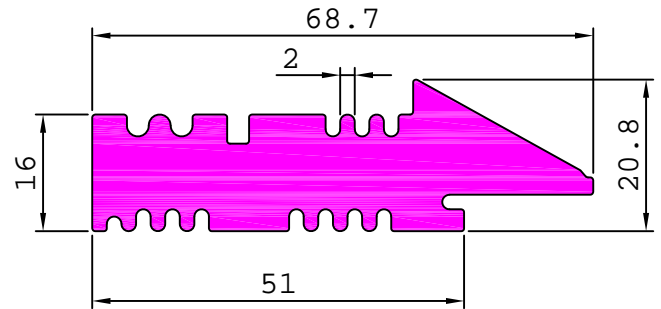

26371

13.416 kg/m

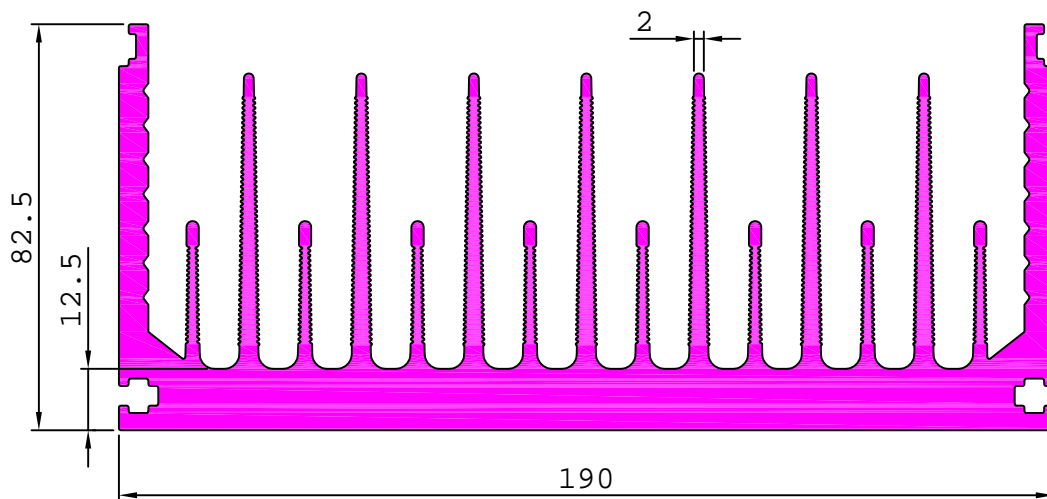

INDUSTRIAL

HEAT SINKS

26372

5.733 kg/m

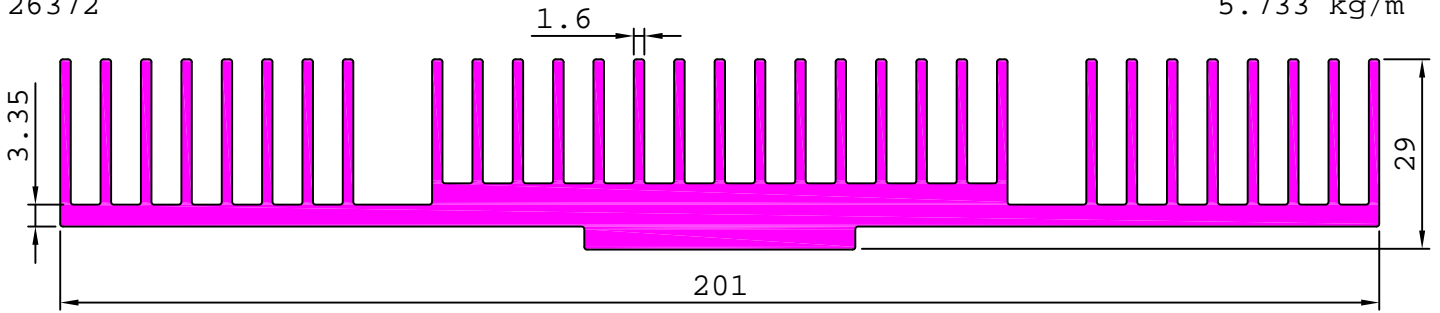

26374

10.880 kg/m

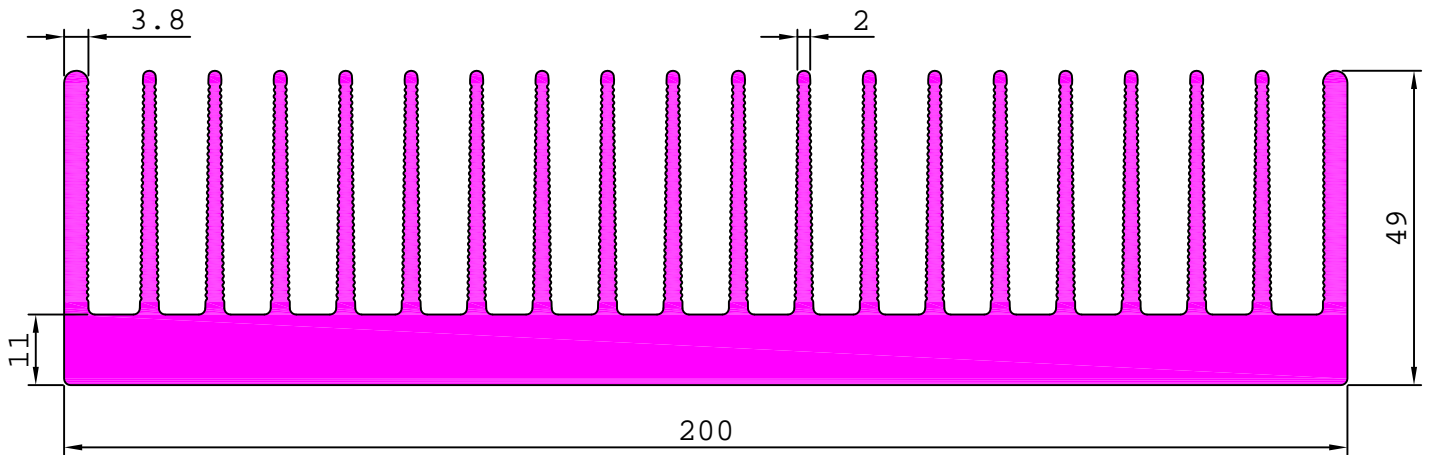

26379

5.762 kg/m

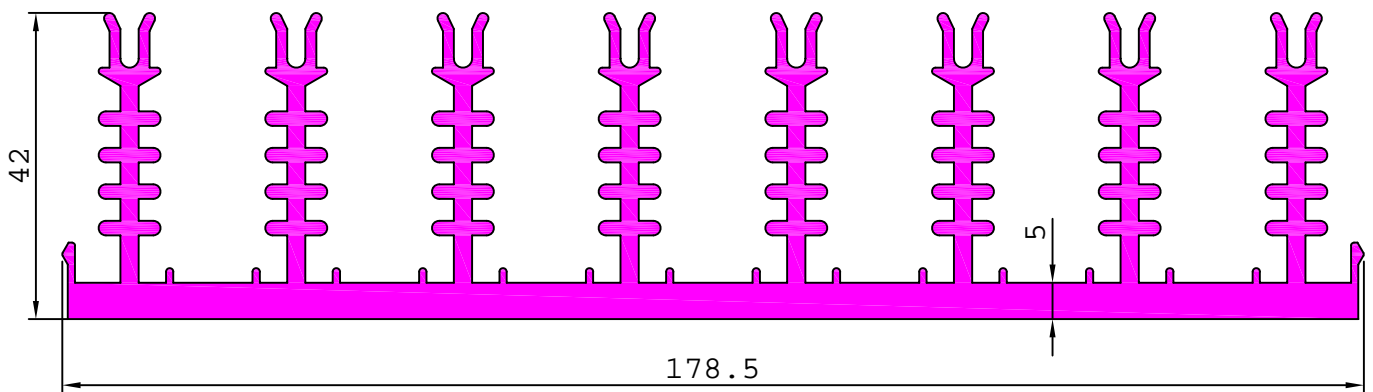

26382

7.650 kg/m

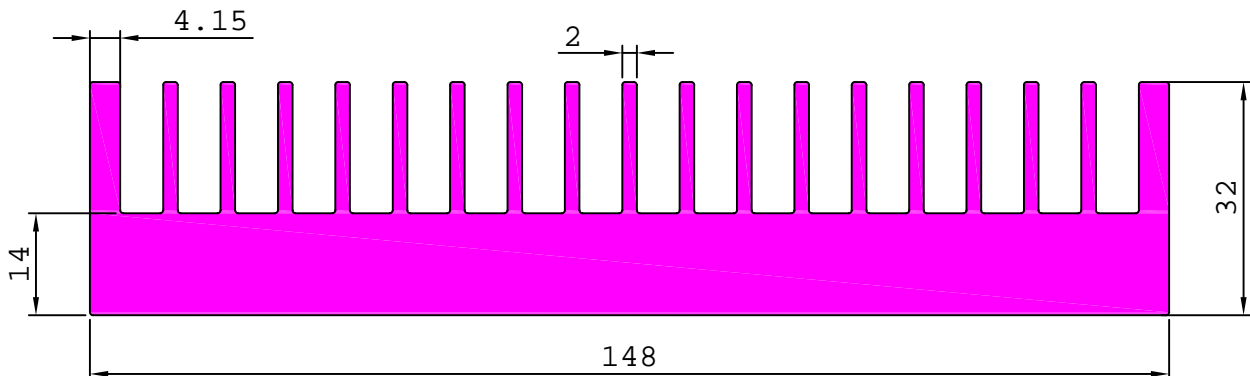

INDUSTRIAL

HEAT SINKS

26373

3.629 kg/m

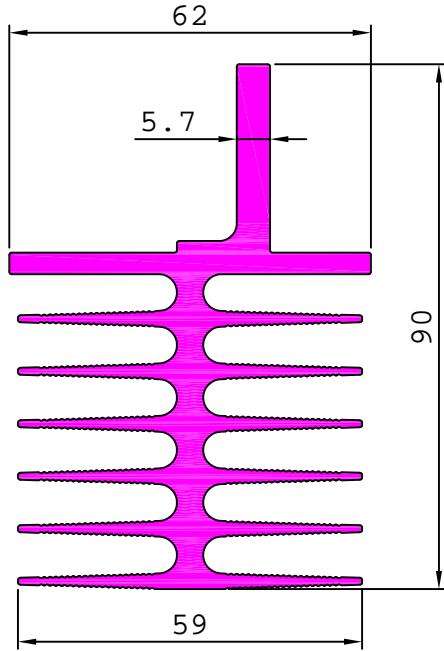

26380

16.568 kg/m

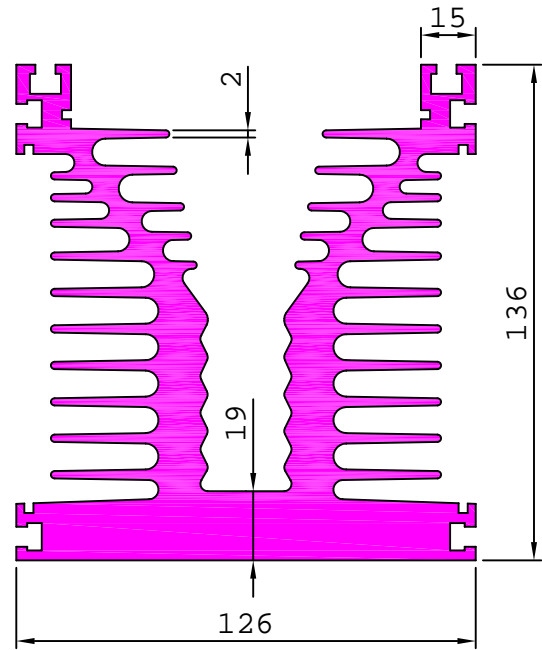

26384

13.747 kg/m

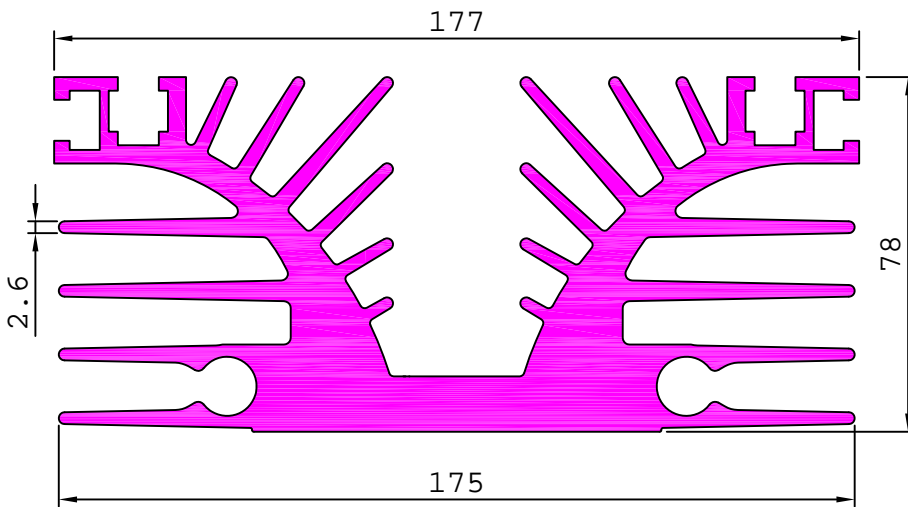

26387

0.177 kg/m

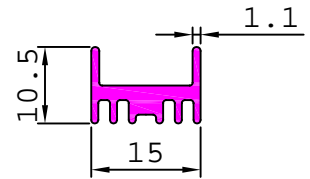

26391

0.777 kg/m

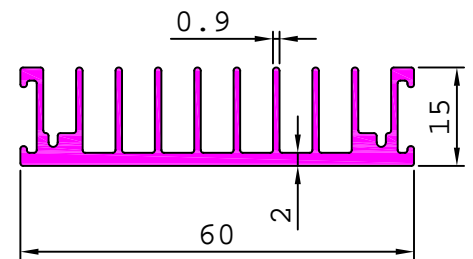

26390

1.368 kg/m

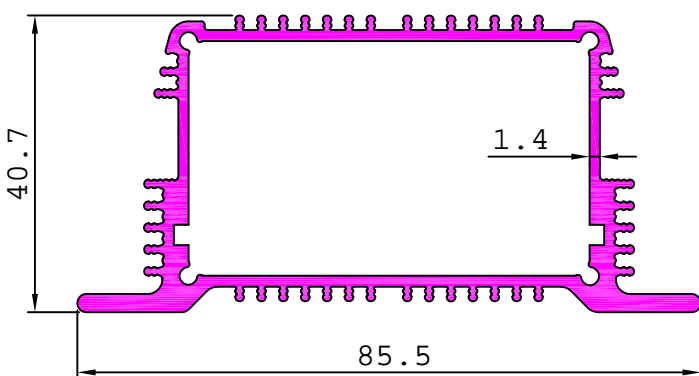

26392

1.160 kg/m

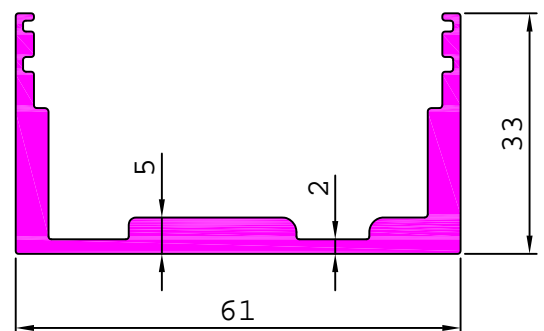

INDUSTRIAL

HEAT SINKS

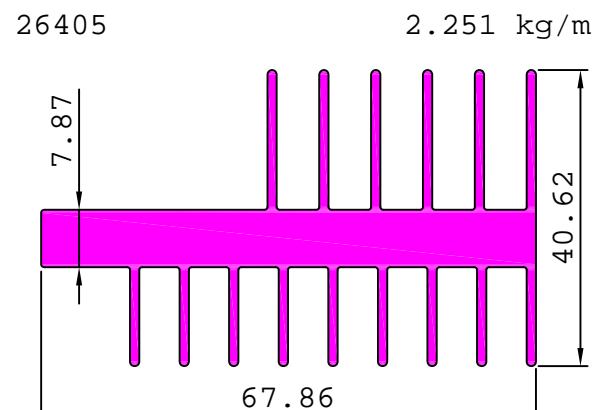
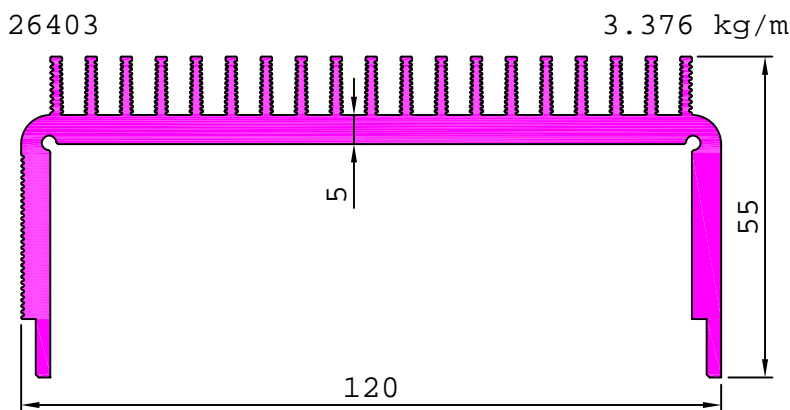
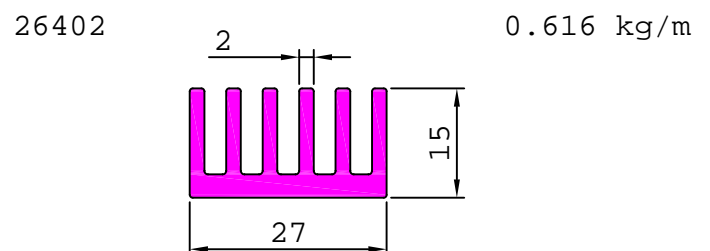
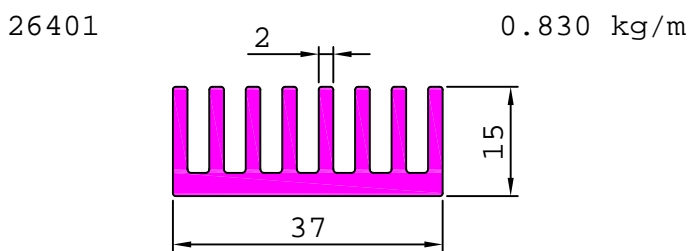
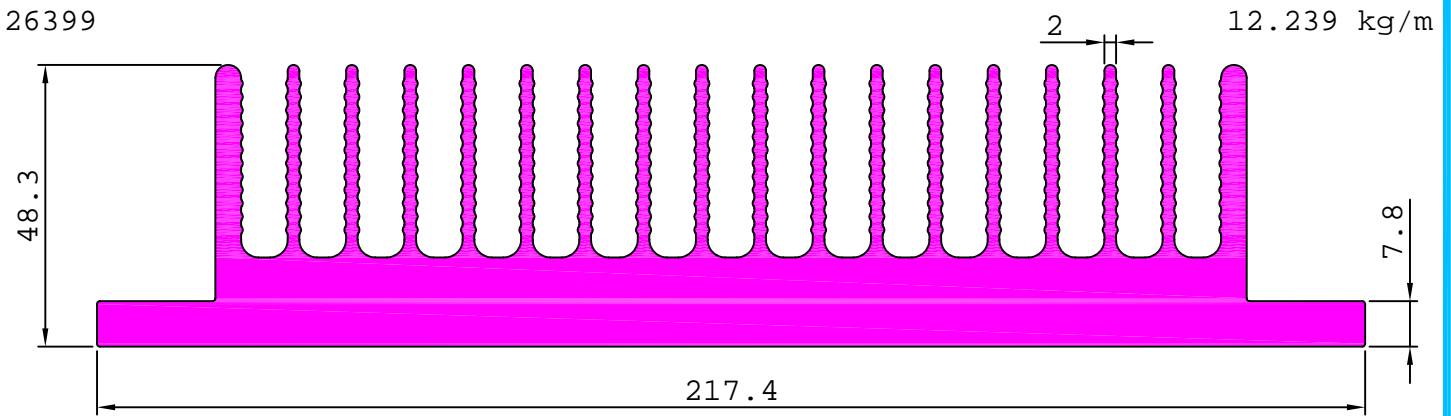
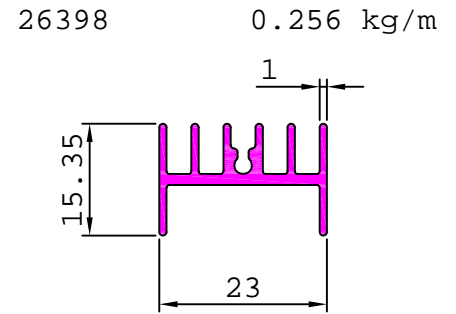
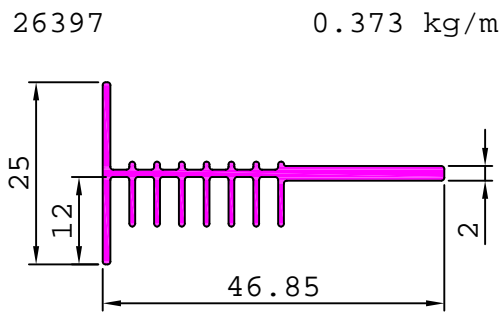
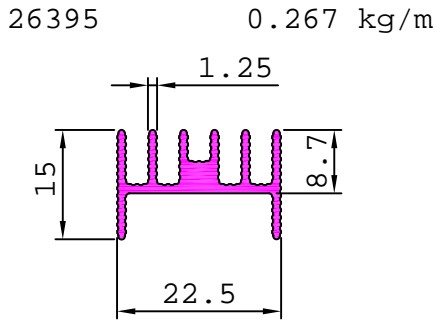
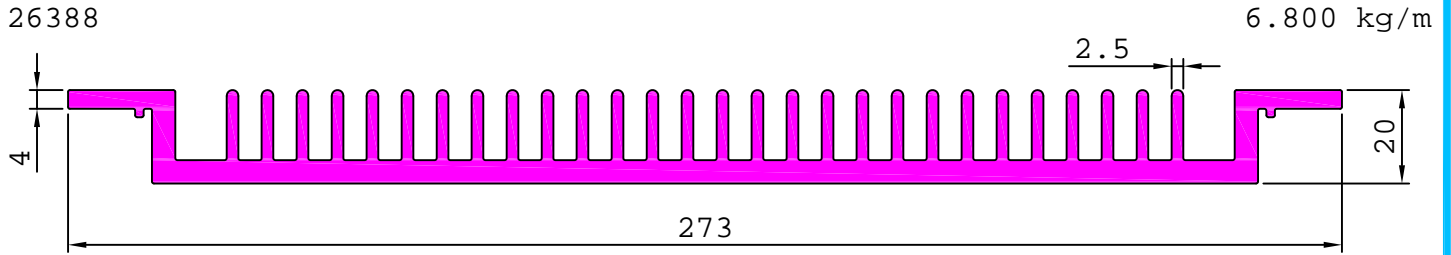

INDUSTRIAL

HEAT SINKS

26404

4.143 kg/m

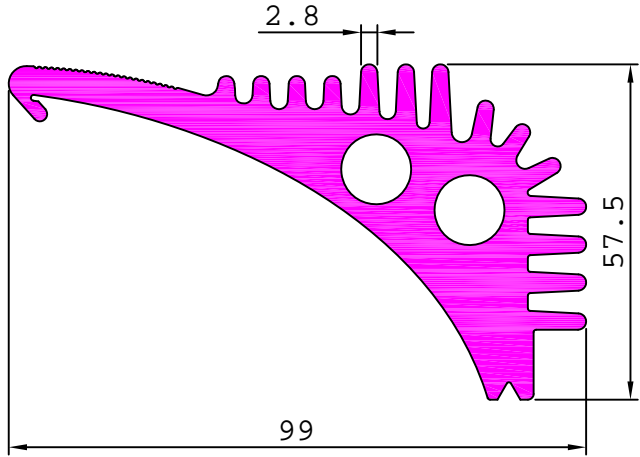

26408

4.899 kg/m

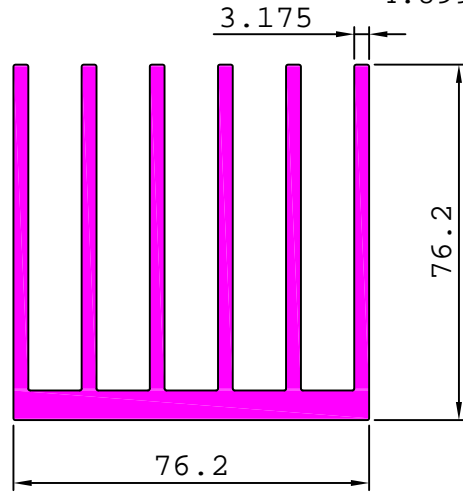

26406

3.390 kg/m

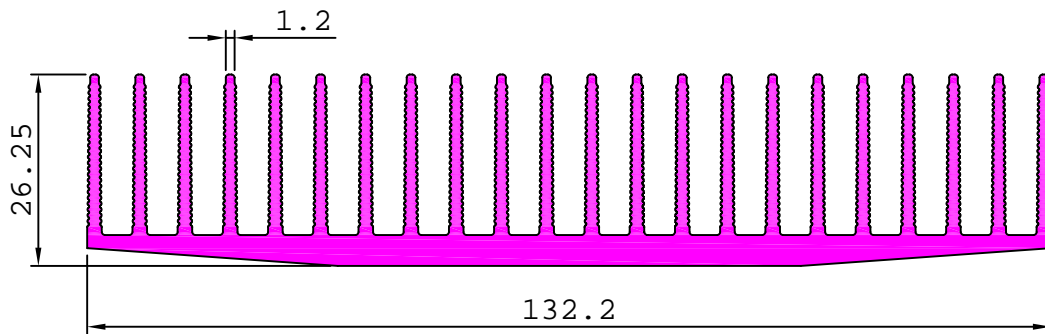

26410

6.813 kg/m

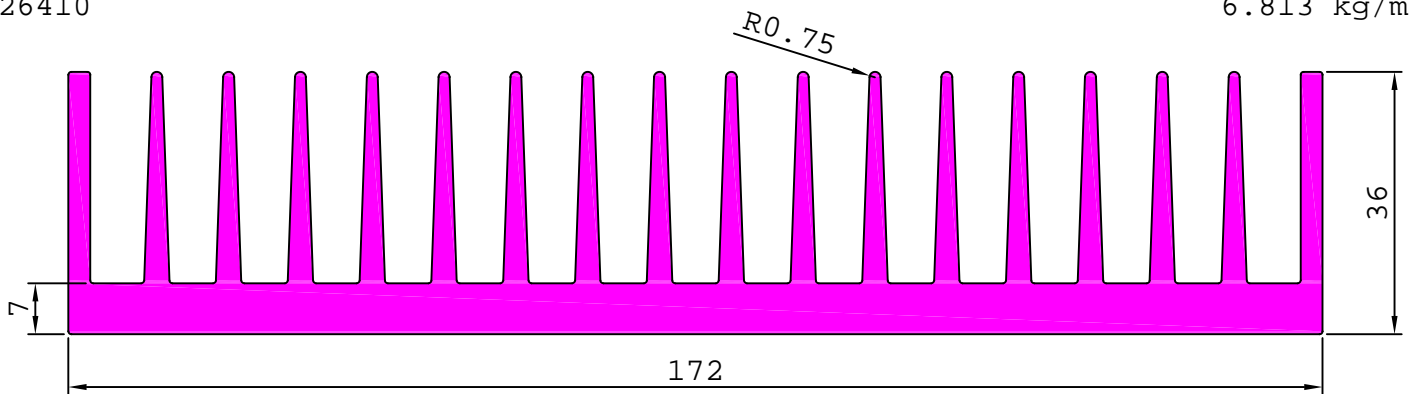

26413

3.927 kg/m

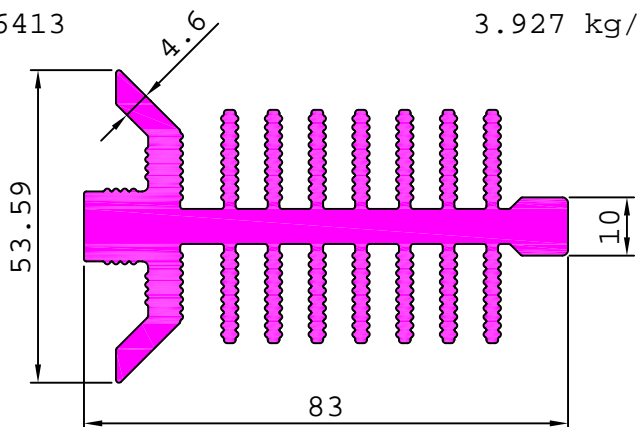

26414

2.667 kg/m

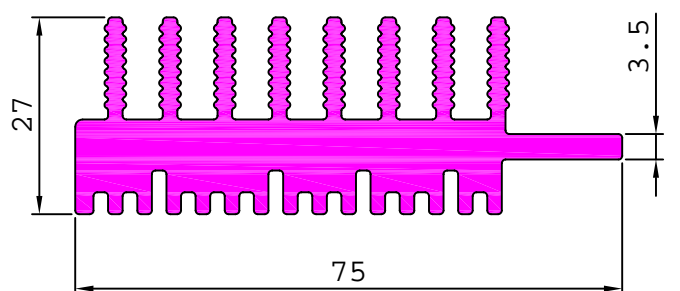

INDUSTRIAL

HEAT SINKS

26411

9.466 kg/m

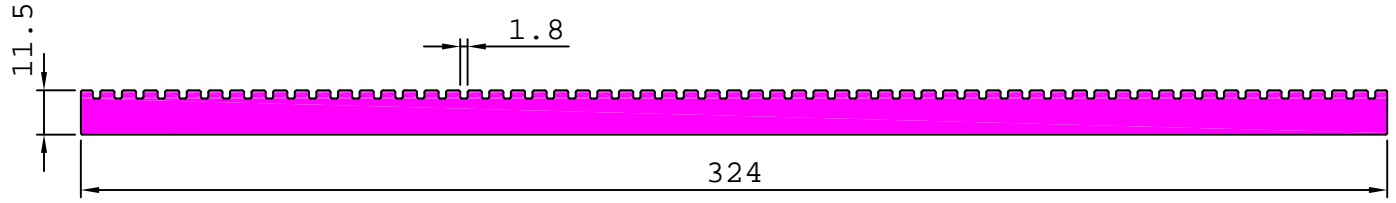

26412

8.860 kg/m

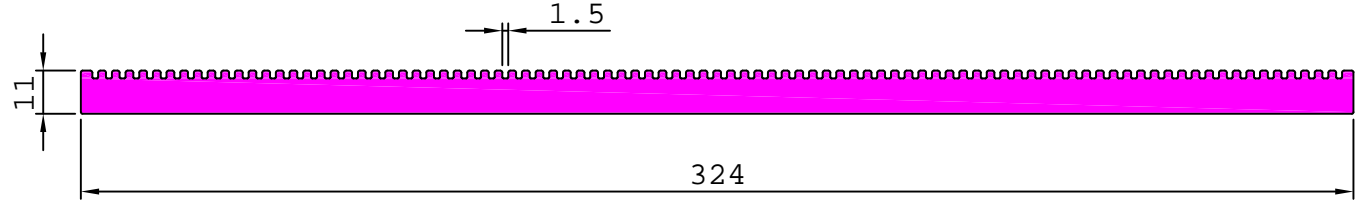

26415

22.862 kg/m

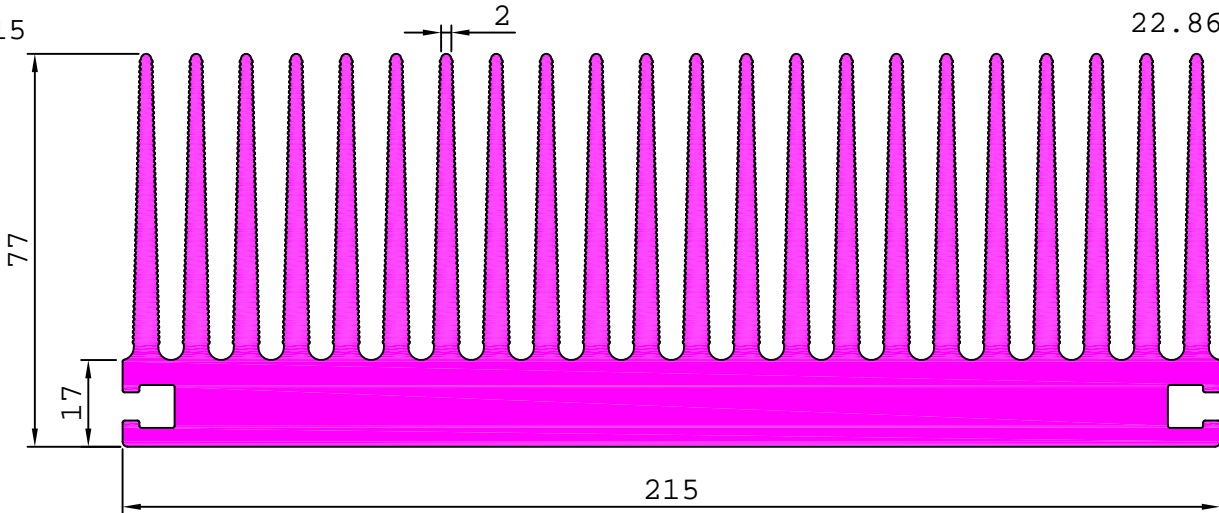

26418

10.770 kg/m

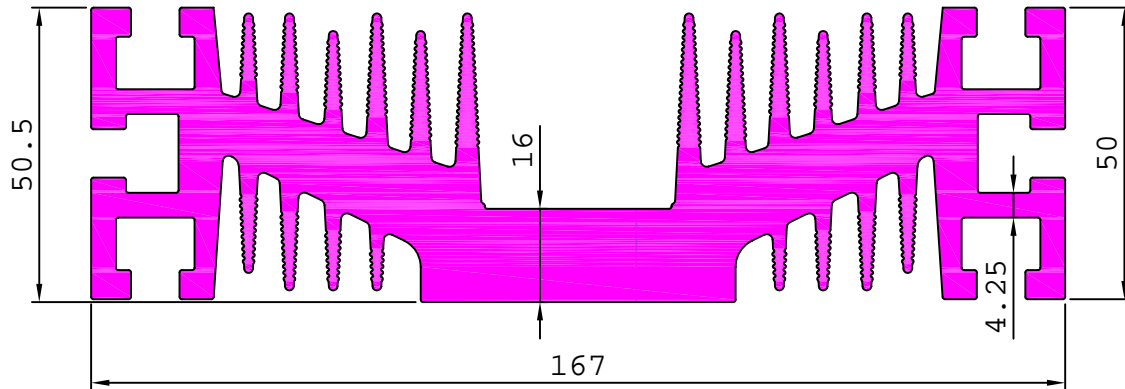

26417

0.259 kg/m

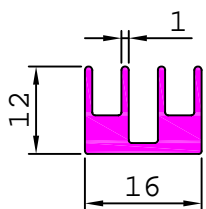

26419

1.189 kg/m

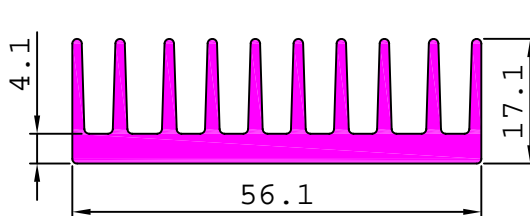

26420

0.788 kg/m

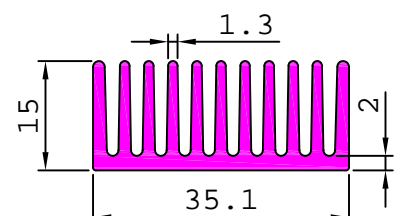

INDUSTRIAL

HEAT SINKS

26416 1.971 kg/m

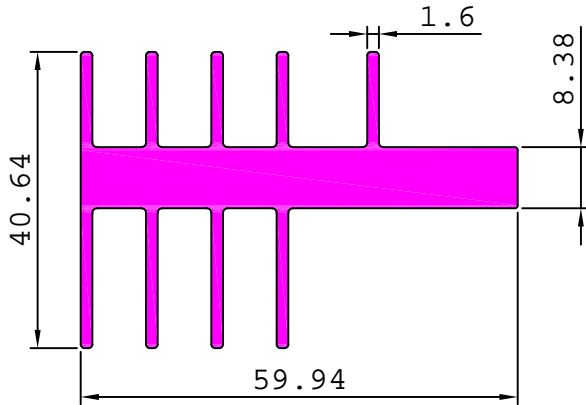

26421 3.194 kg/m

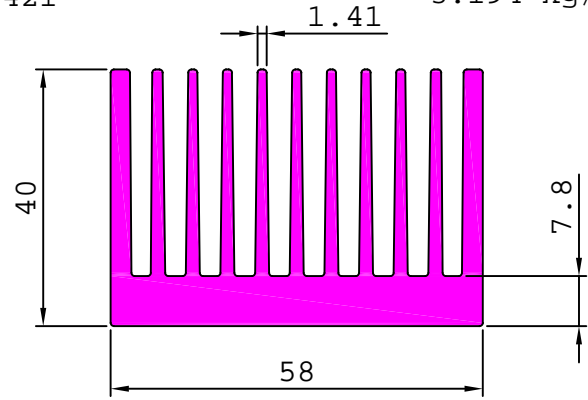

26422 2.267 kg/m

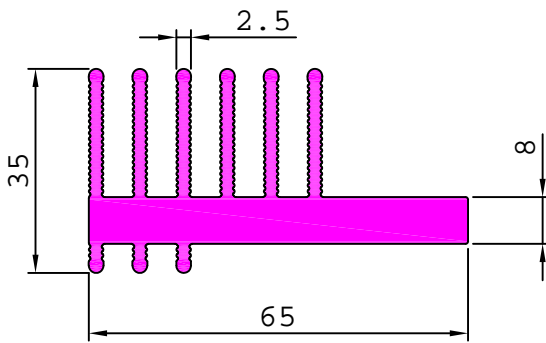

26423 3.497 kg/m

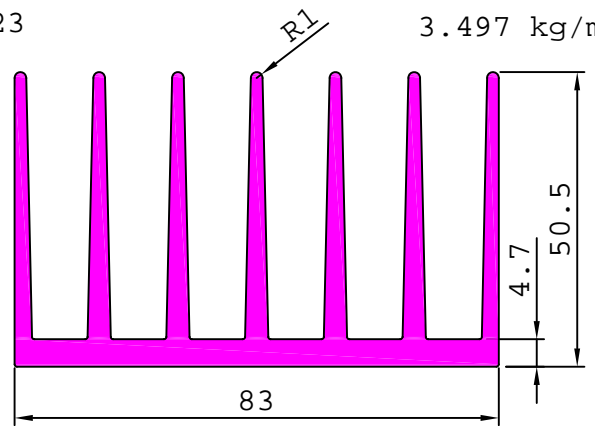

26424 10.060 kg/m

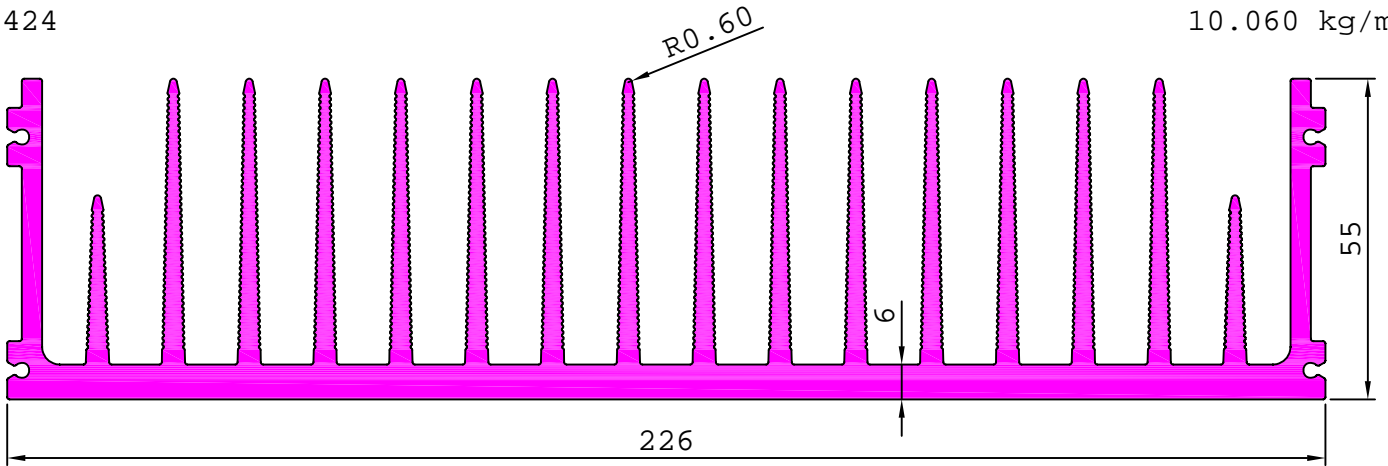

26428 10.648 kg/m

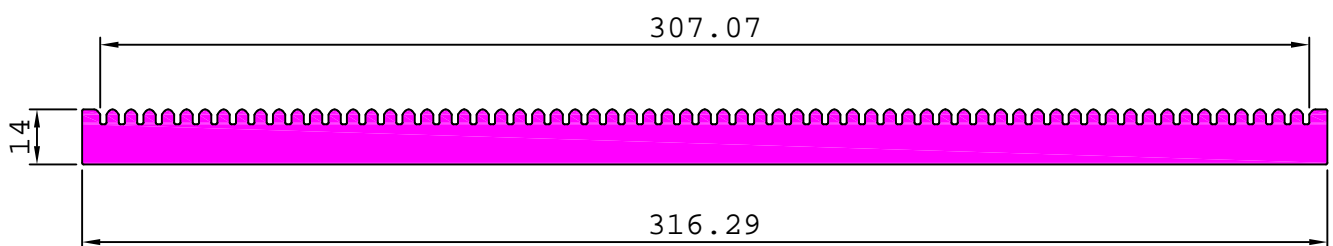

INDUSTRIAL

HEAT SINKS

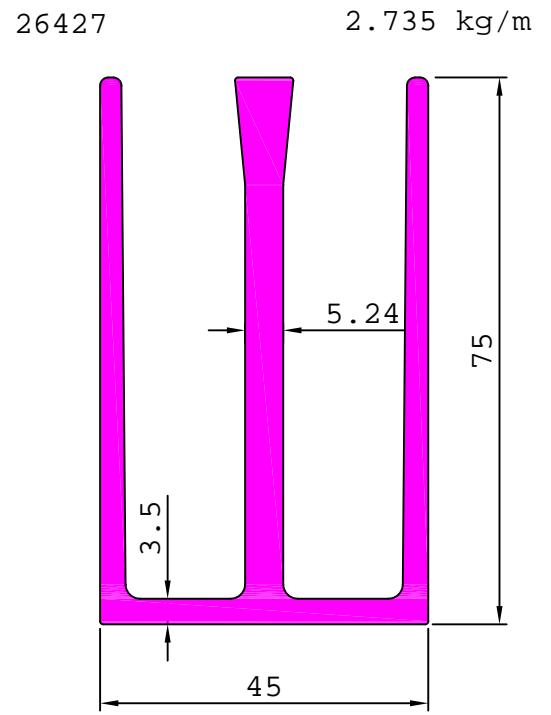
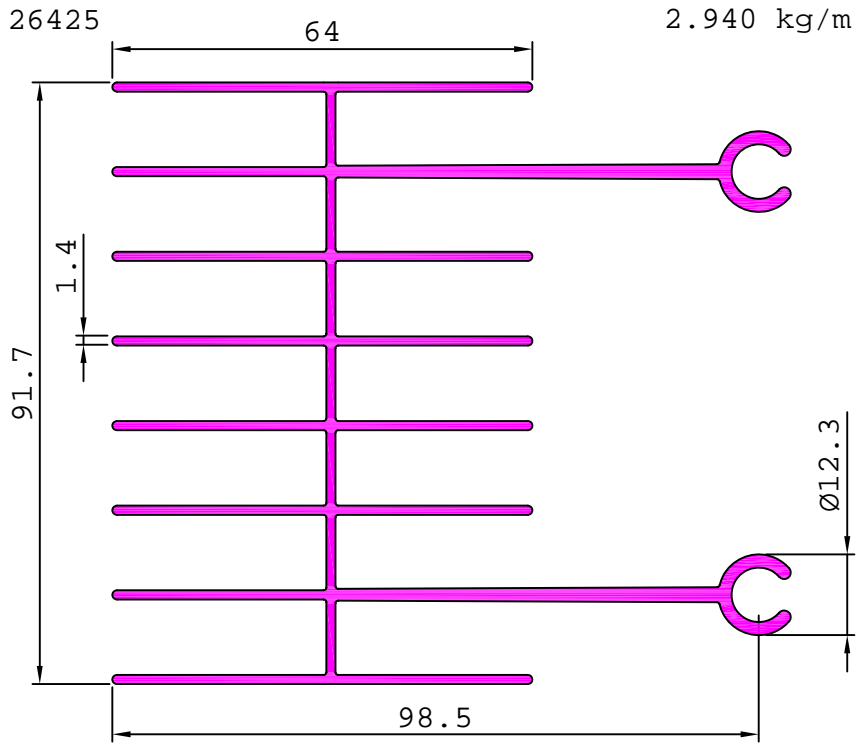

26426 1.770 kg/m

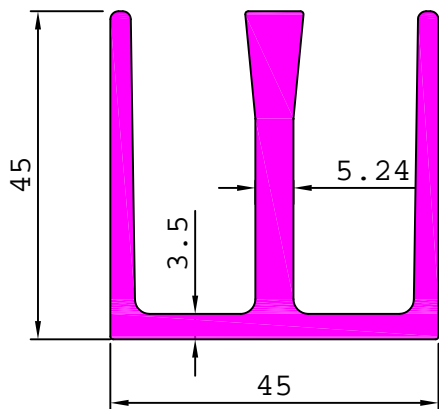

26429 3.037 kg/m

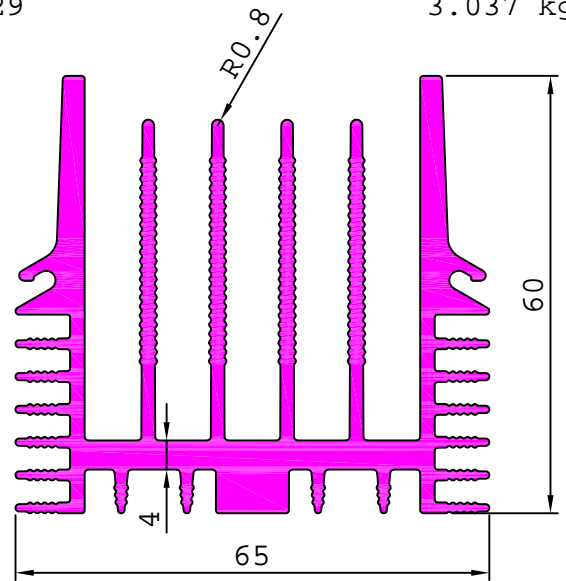

26433 2.122 kg/m

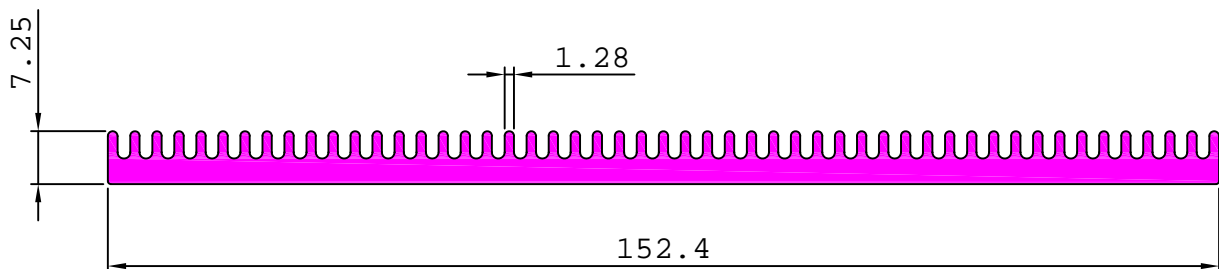

INDUSTRIAL

HEAT SINKS

26430

2.650 kg/m

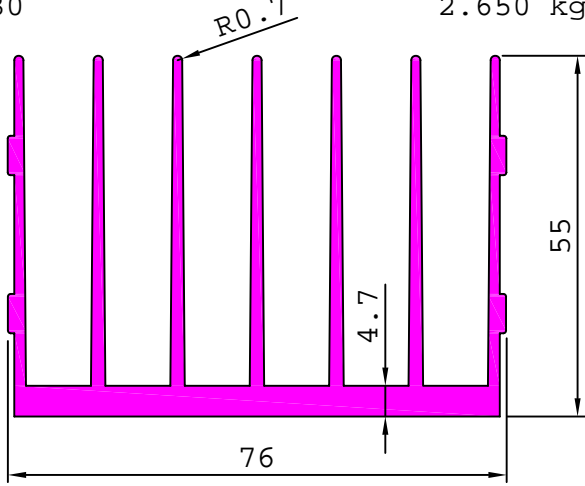

26438

1.676 kg/m

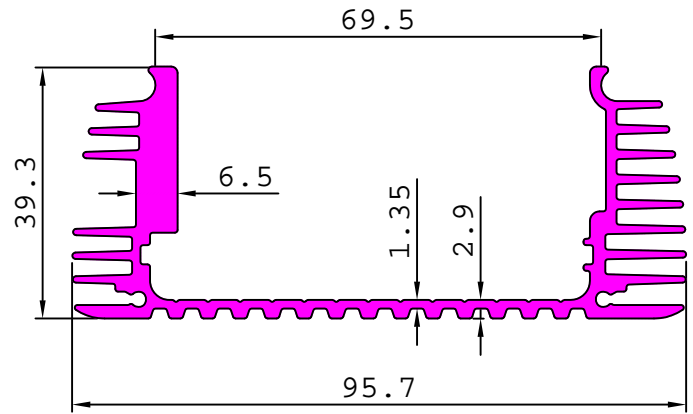

26434

4.045 kg/m

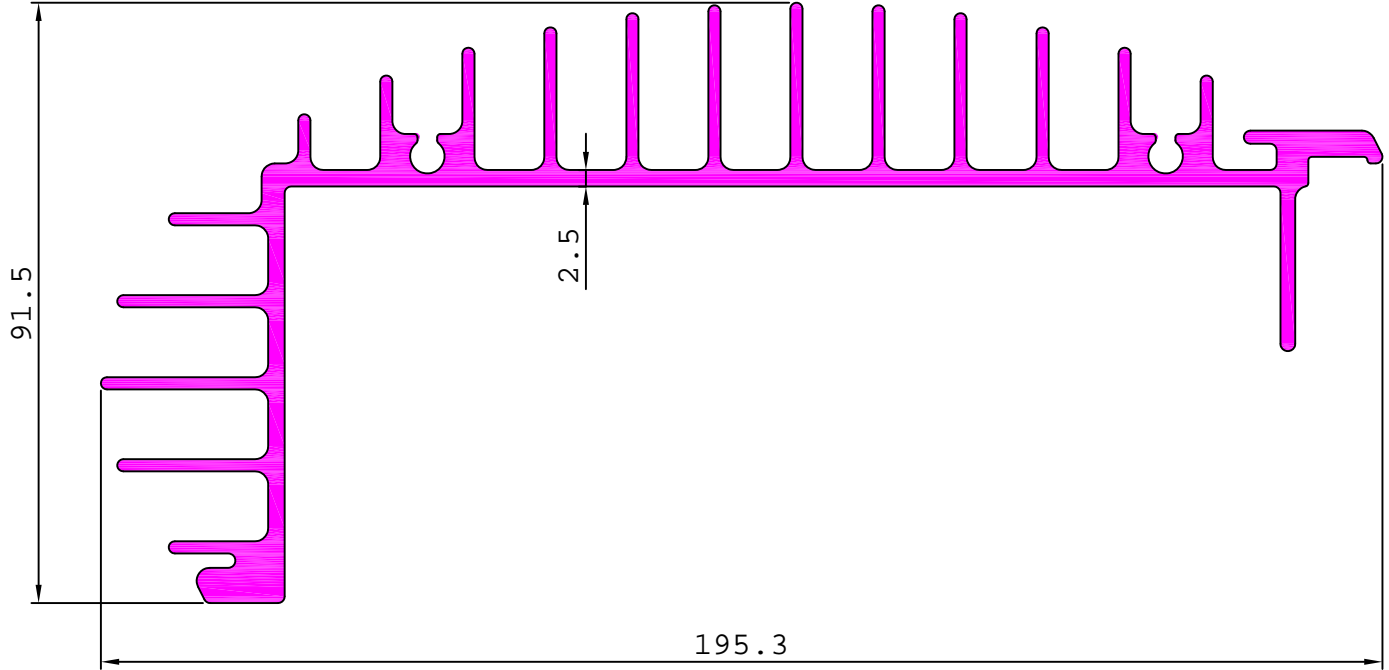

26440

20.958 kg/m

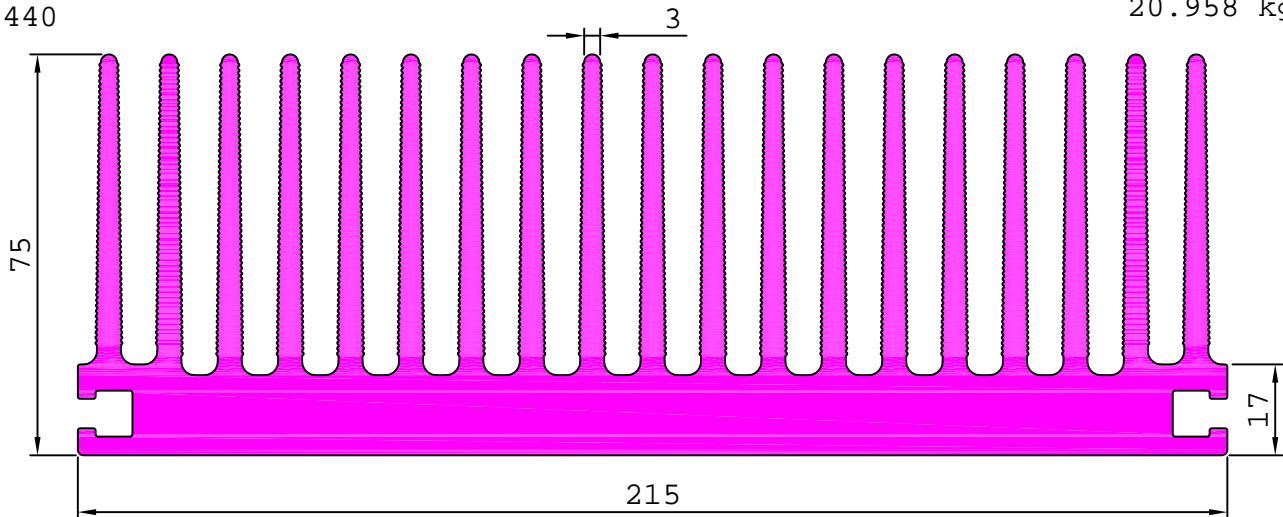

INDUSTRIAL

HEAT SINKS

26435

27.703 kg/m

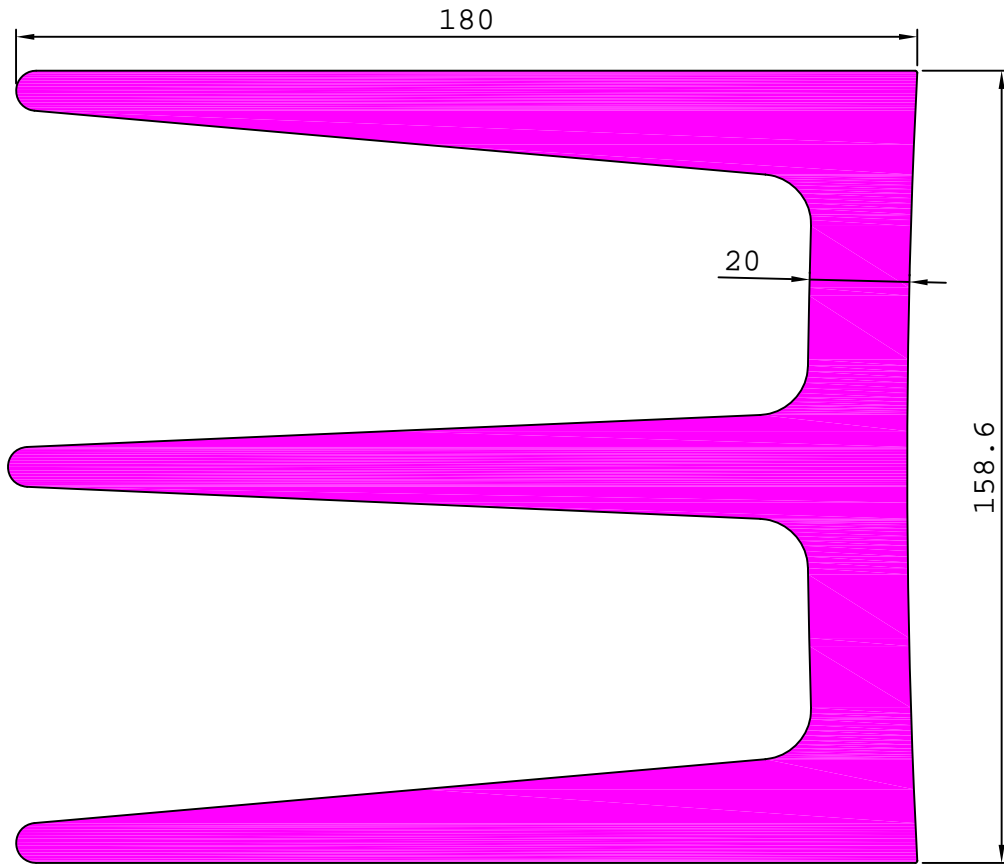

33538

28.089 kg/m

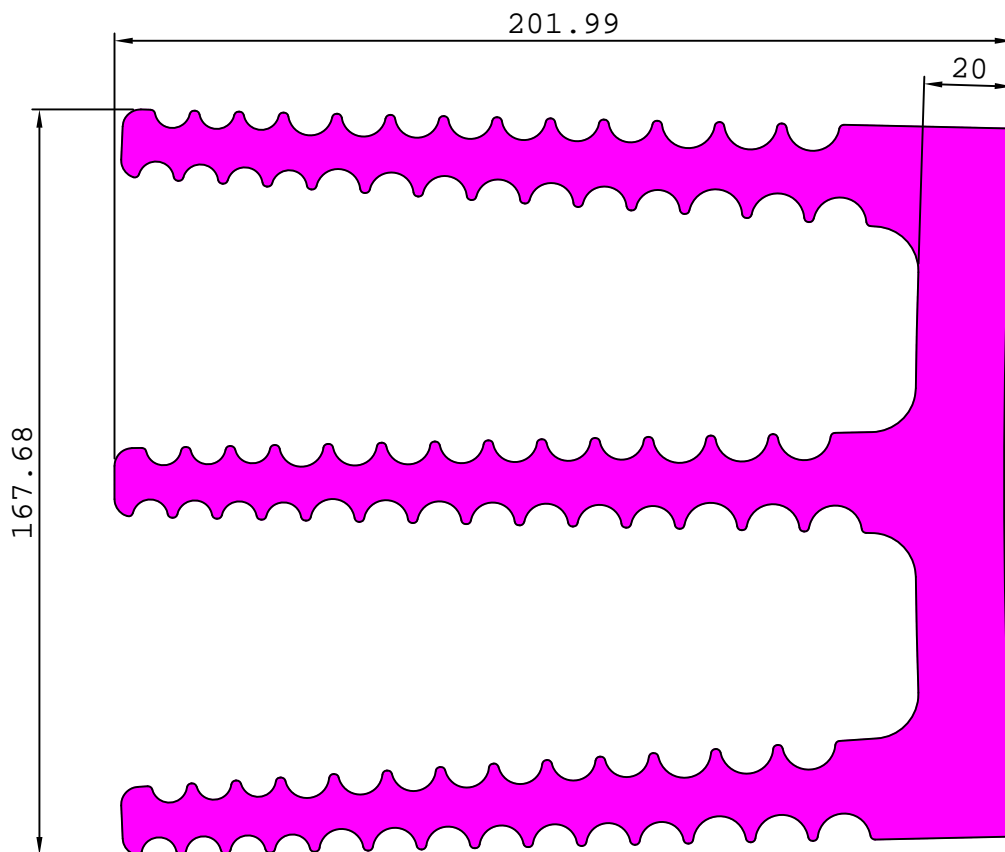

INDUSTRIAL

HEAT SINKS

26436

2.787 kg/m

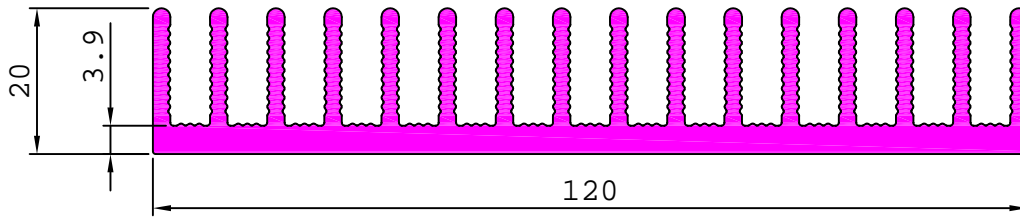

26439

0.899 kg/m

26450

0.692 kg/m

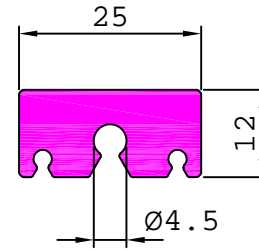
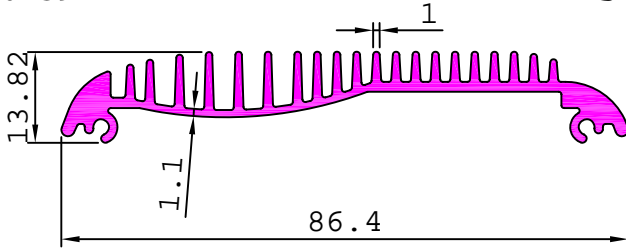

26442

7.106 kg/m

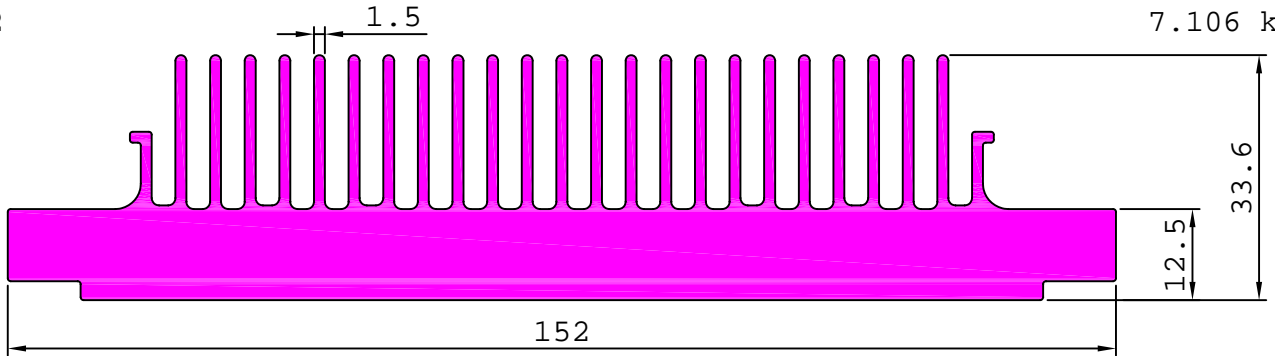

26444

6.472 kg/m

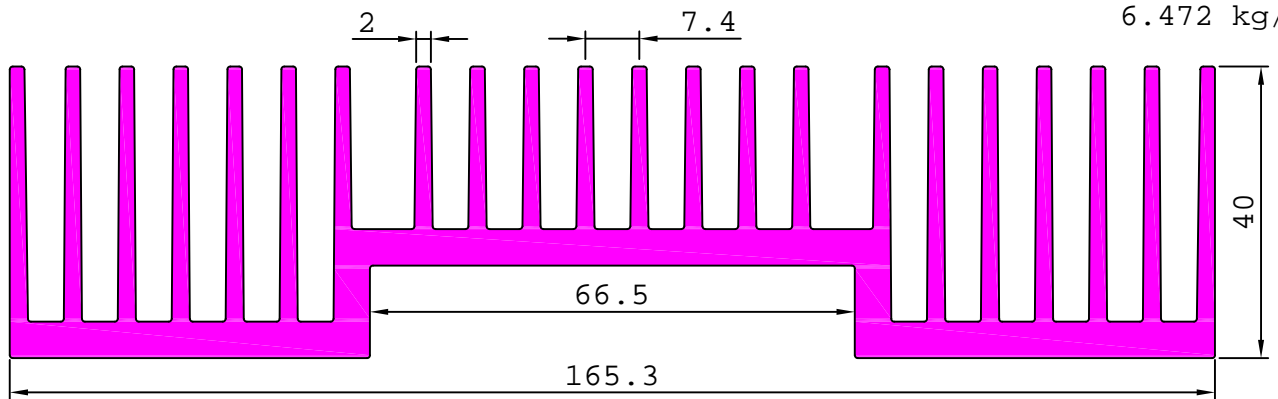

26446

3.390 kg/m

26447

1.866 kg/m

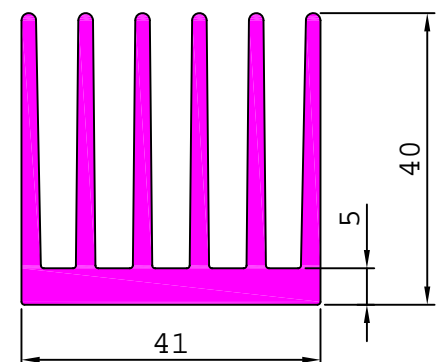
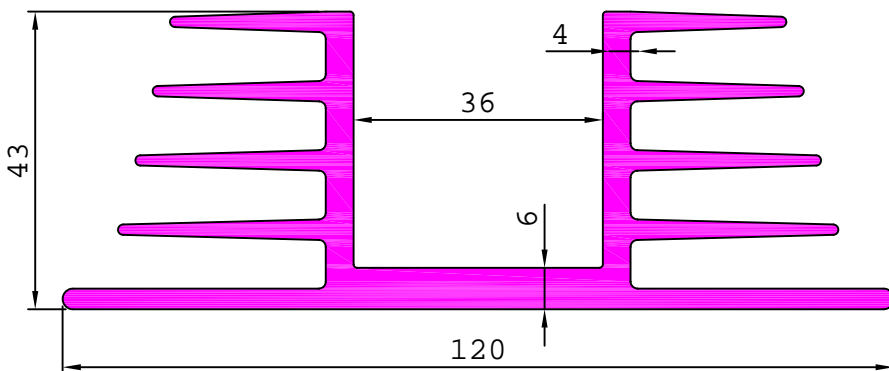

INDUSTRIAL

HEAT SINKS

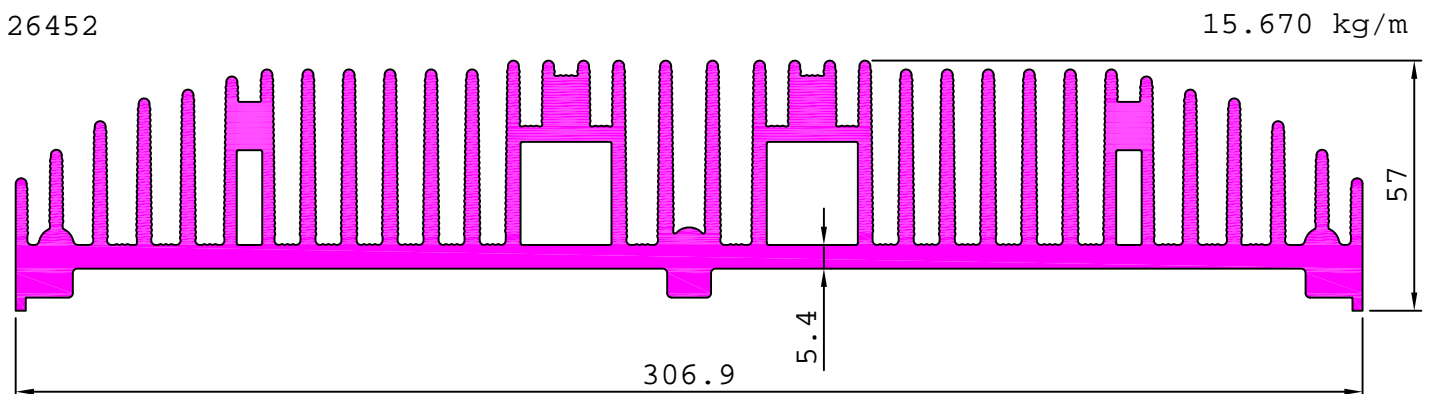
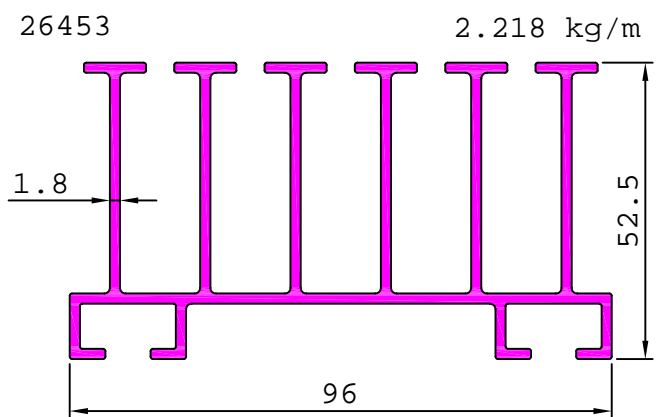
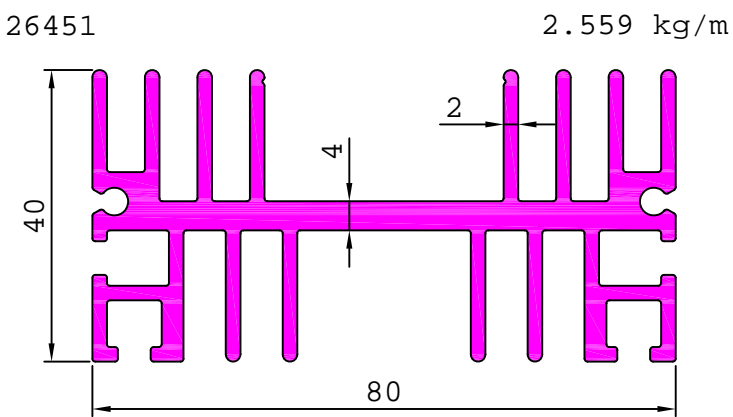
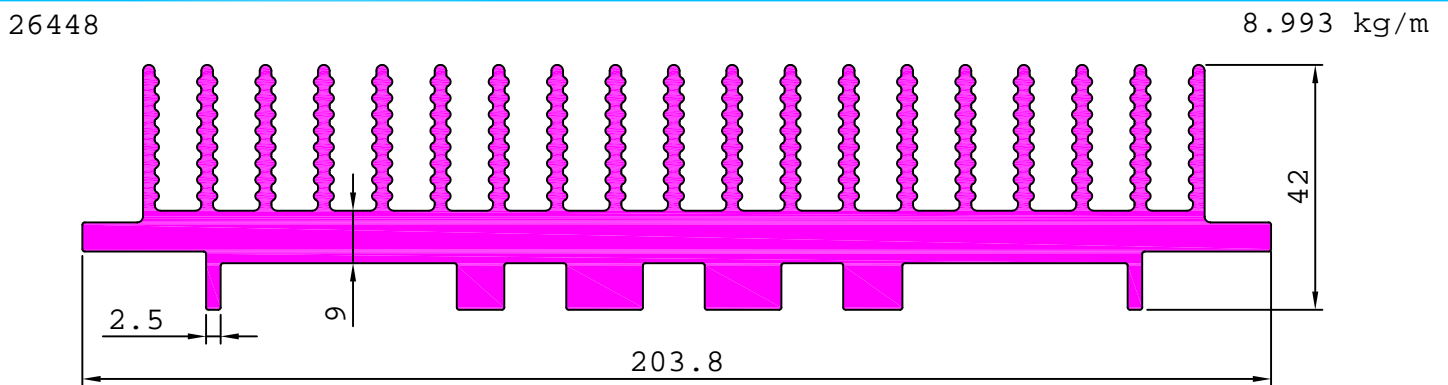
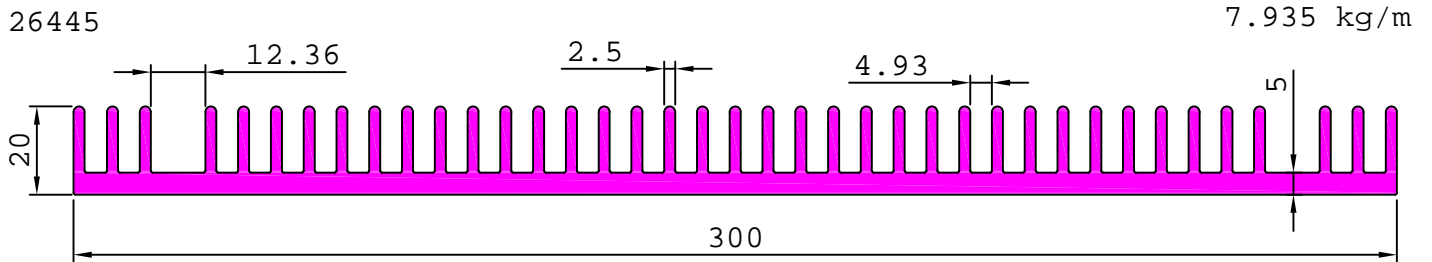
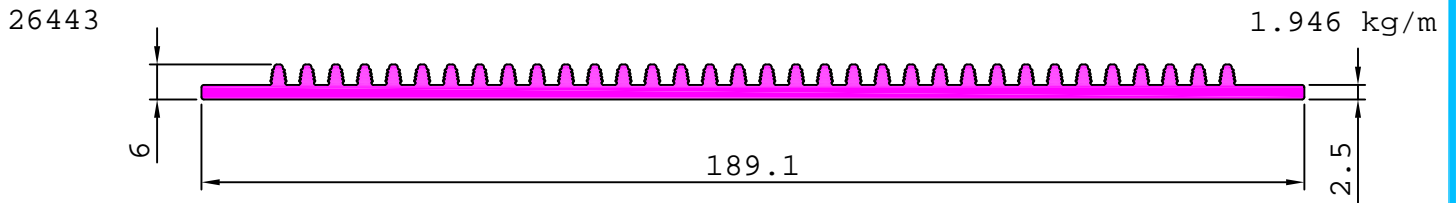

INDUSTRIAL

HEAT SINKS

26455

9.551 kg/m

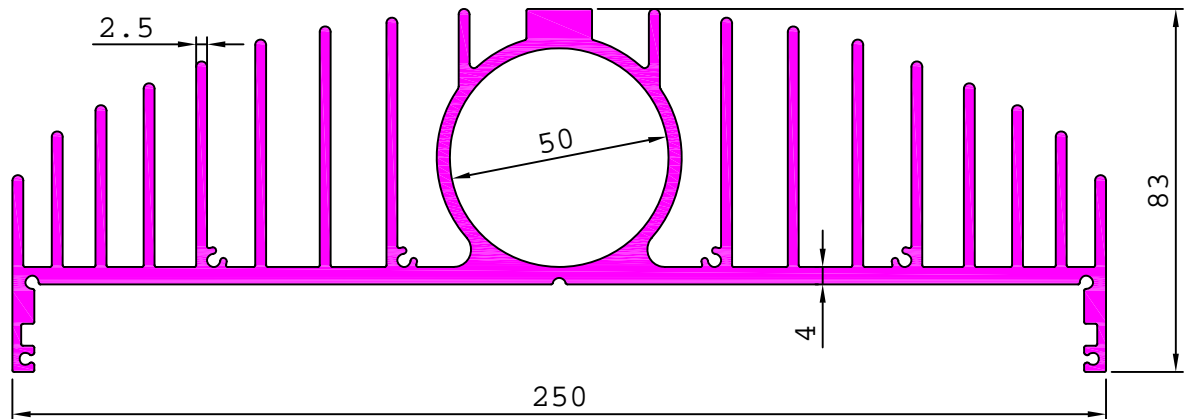

26456

3.140 kg/m

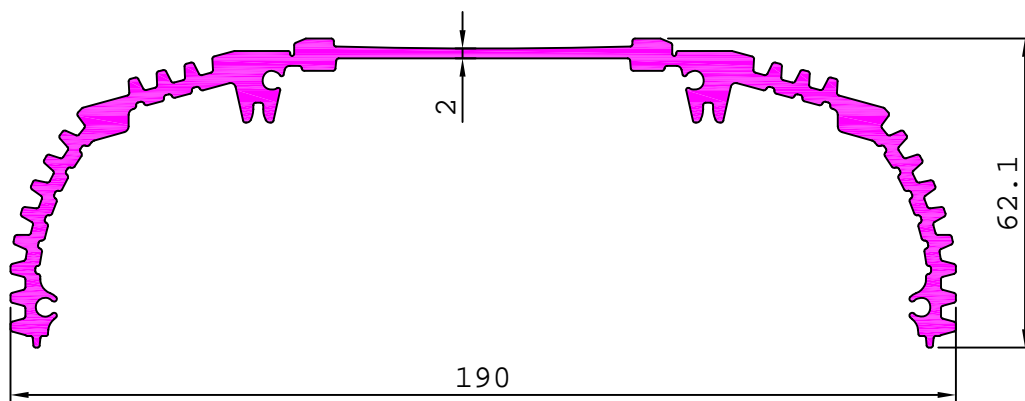

26457

5.601 kg/m

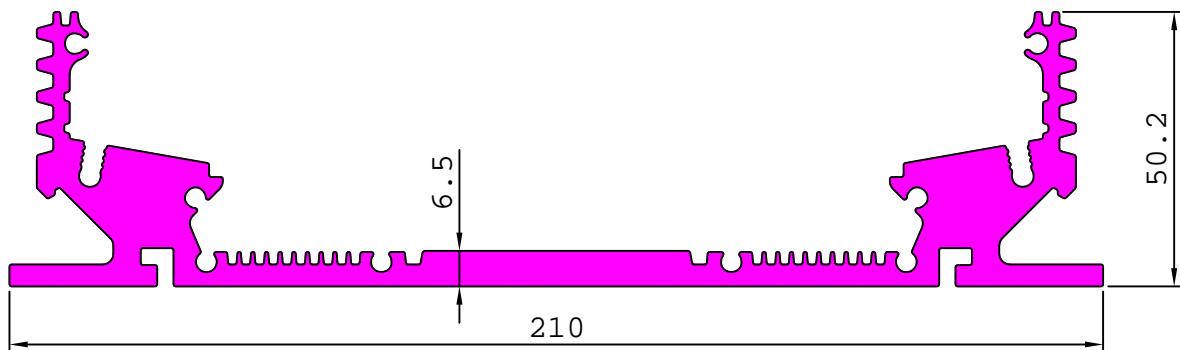

26458

0.802 kg/m

26459

4.485 kg/m

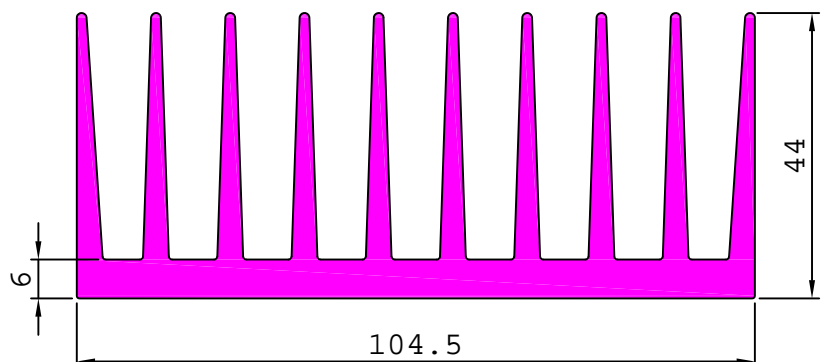
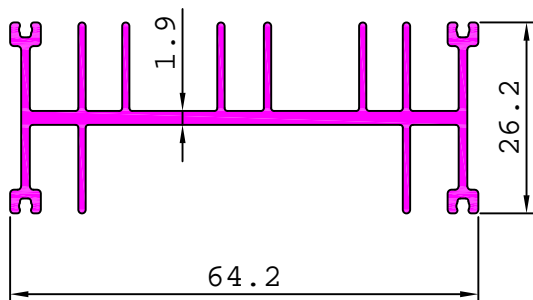

INDUSTRIAL

HEAT SINKS

26454

3.335 kg/m

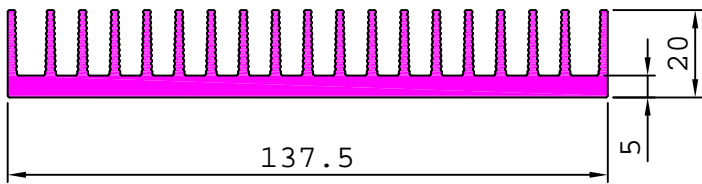

26466

2.284 kg/m

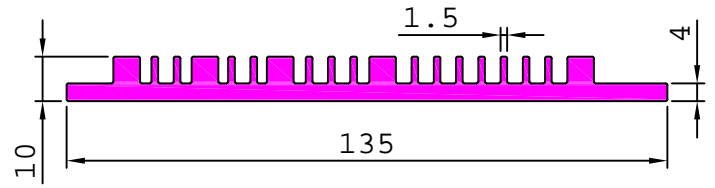

26460

4.366 kg/m

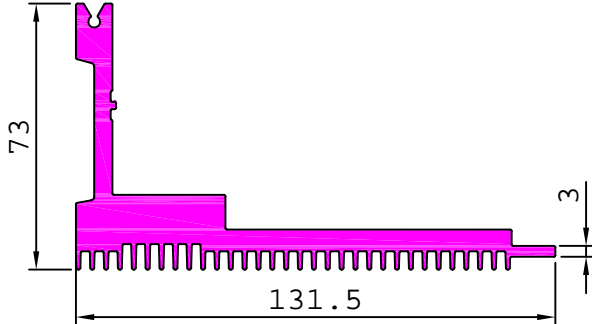

26464

2.082 kg/m

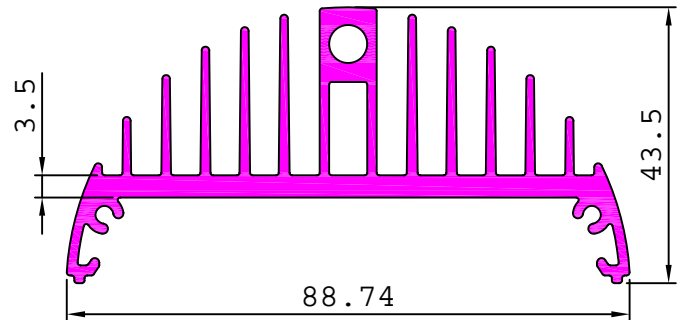

26461

5.653 kg/m

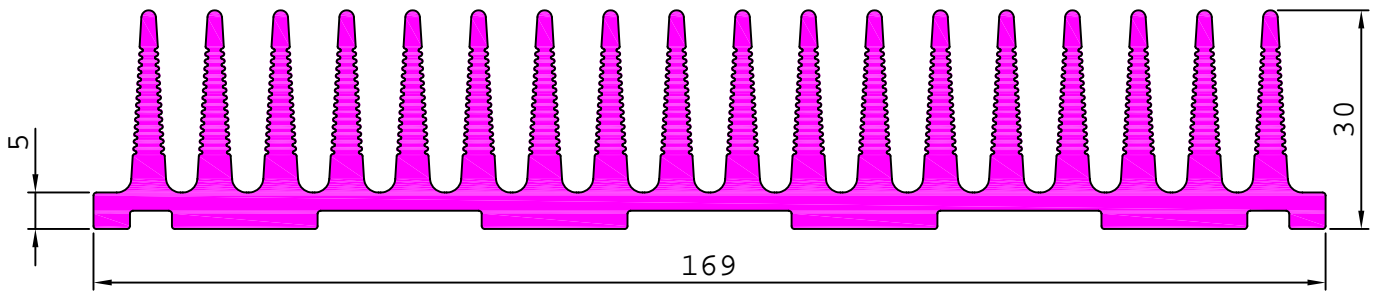

26463

17.789 kg/m

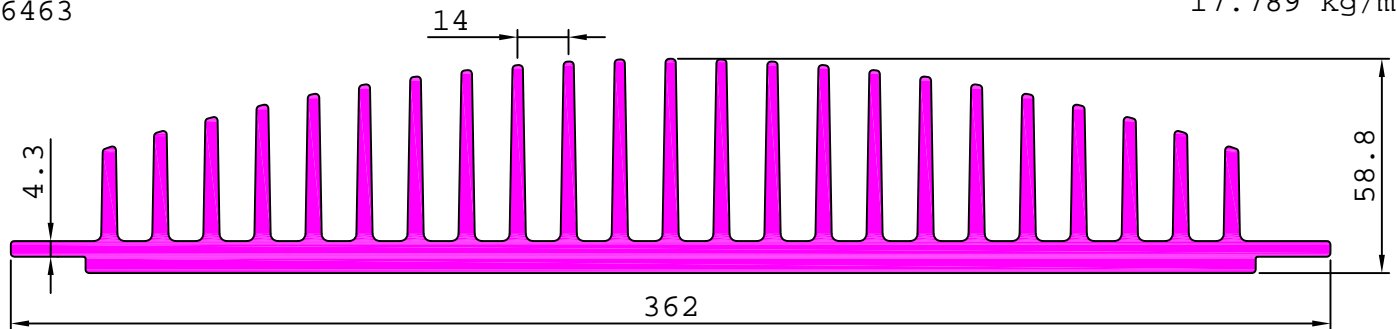

26462

0.507 kg/m

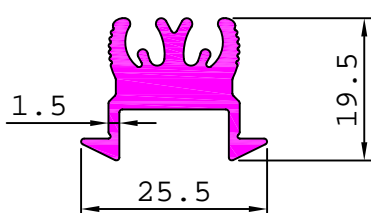

26467

4.197 kg/m

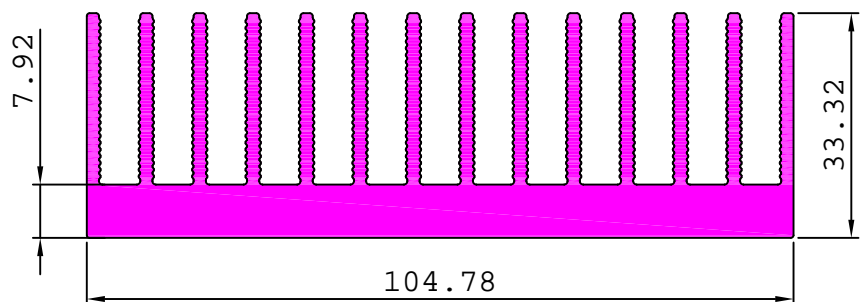

INDUSTRIAL

HEAT SINKS

26468

8.844 kg/m

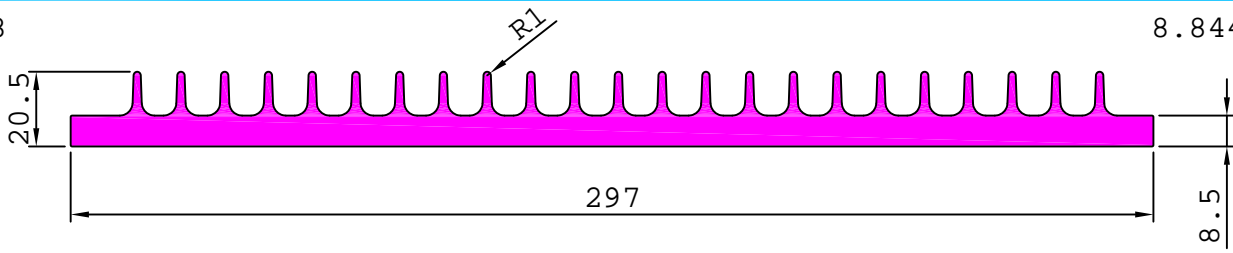

26469

6.582 kg/m

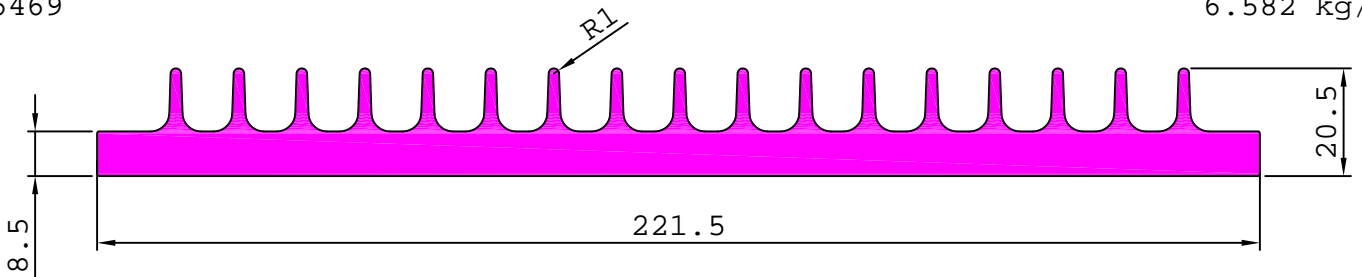

26470

1.661 kg/m

26471

2.403 kg/m

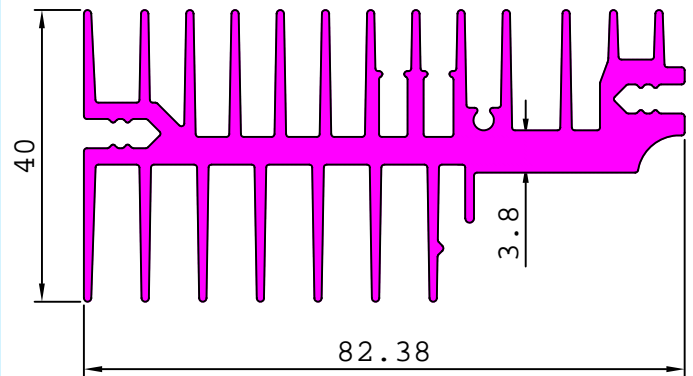
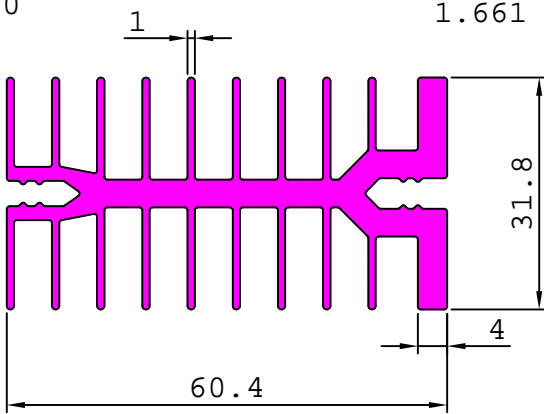

26472

13.899 kg/m

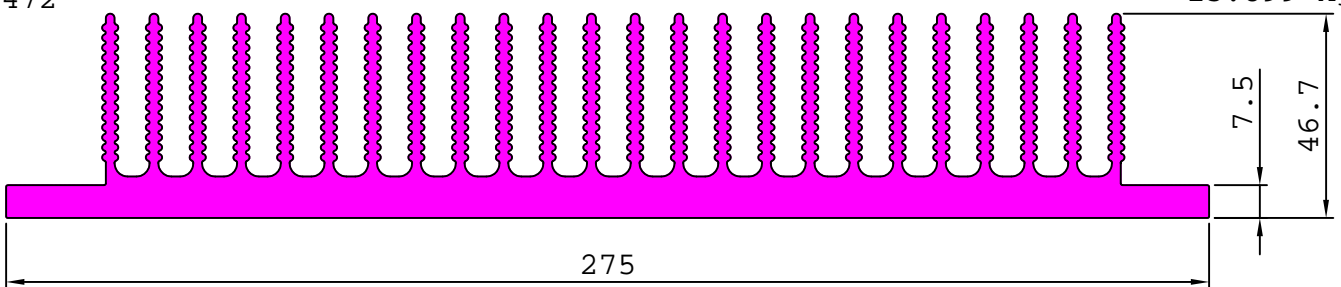

26473

10.864 kg/m

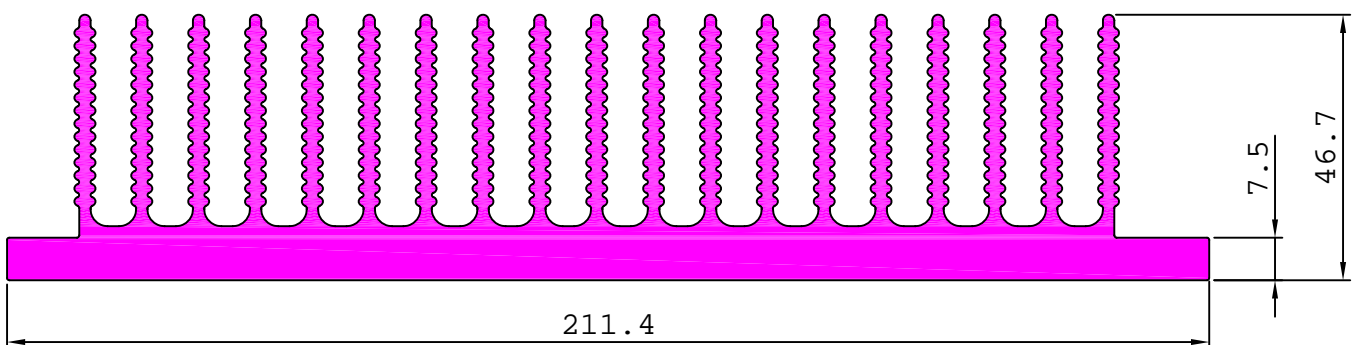

INDUSTRIAL

HEAT SINKS

26474 0.275 kg/m

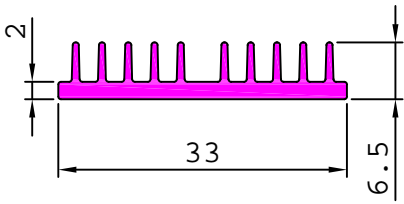

26481 0.287 kg/m

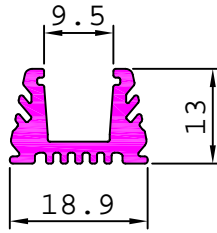

26487 1.143 kg/m

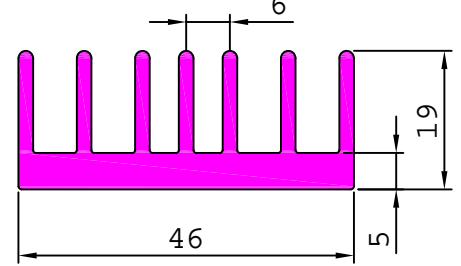

26476 3.409 kg/m

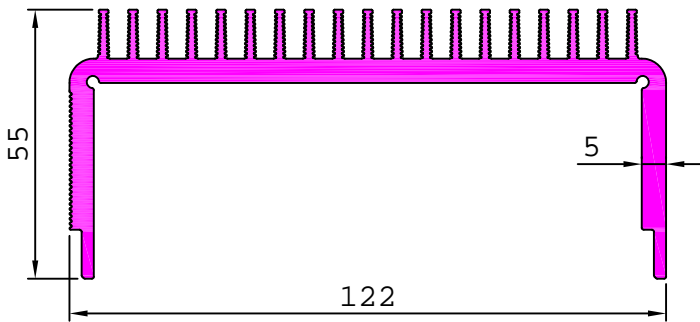

26477 3.059 kg/m

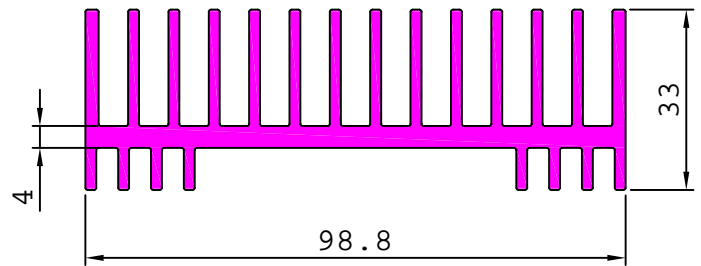

26479 7.696 kg/m

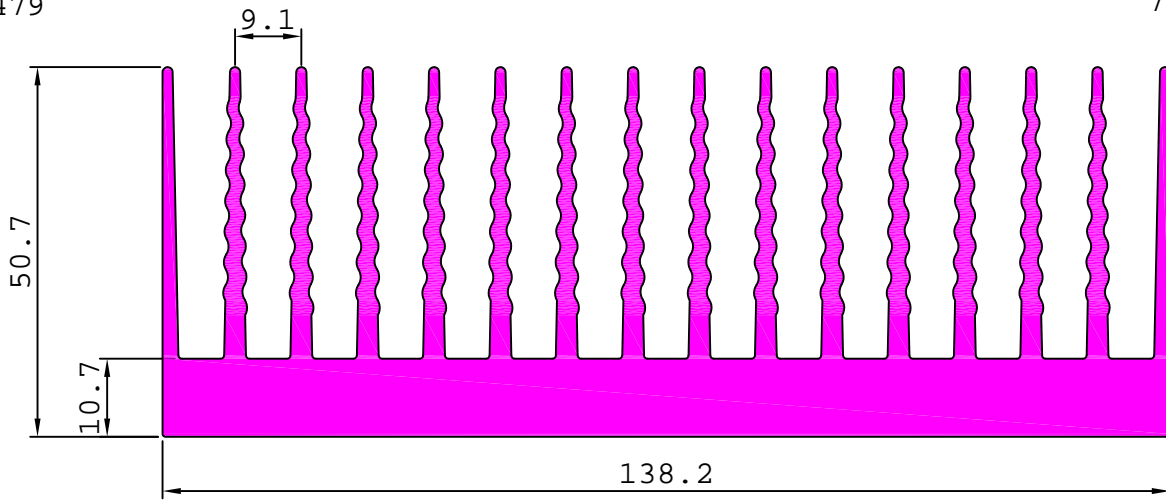

26480 5.841 kg/m

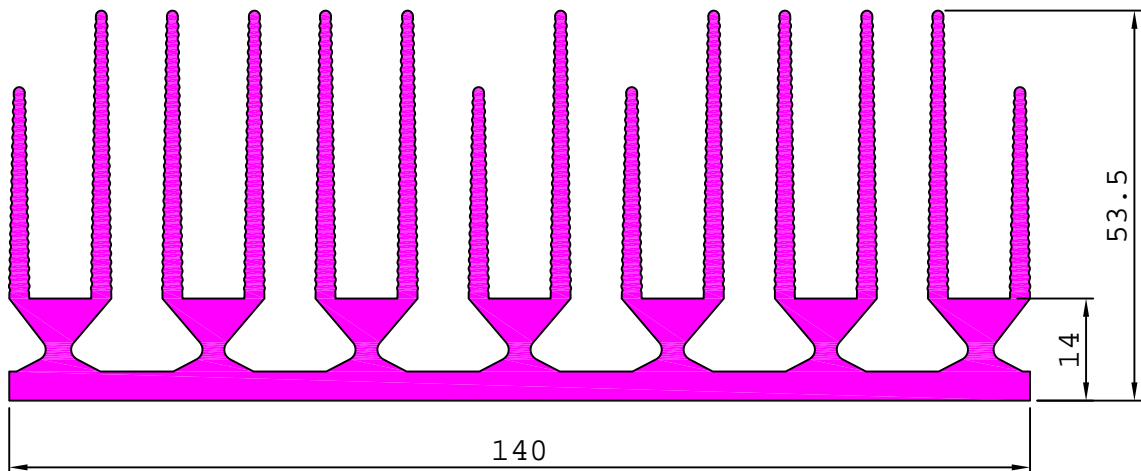

INDUSTRIAL

HEAT SINKS

26482

8.305 kg/m

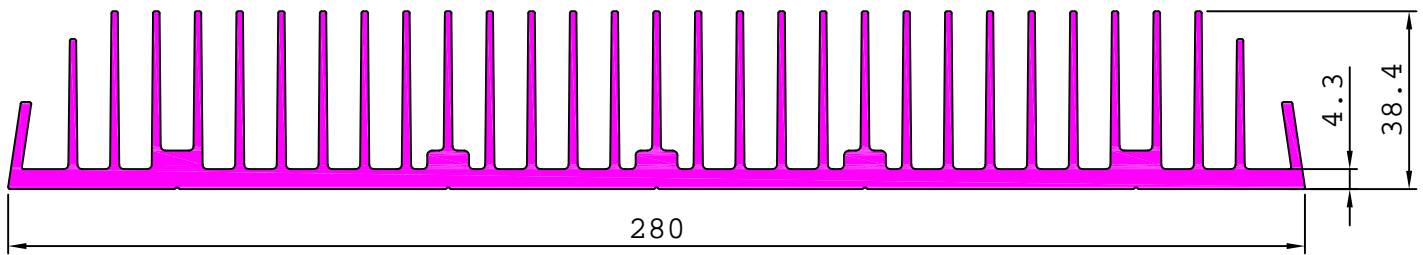

26483

5.511 kg/m

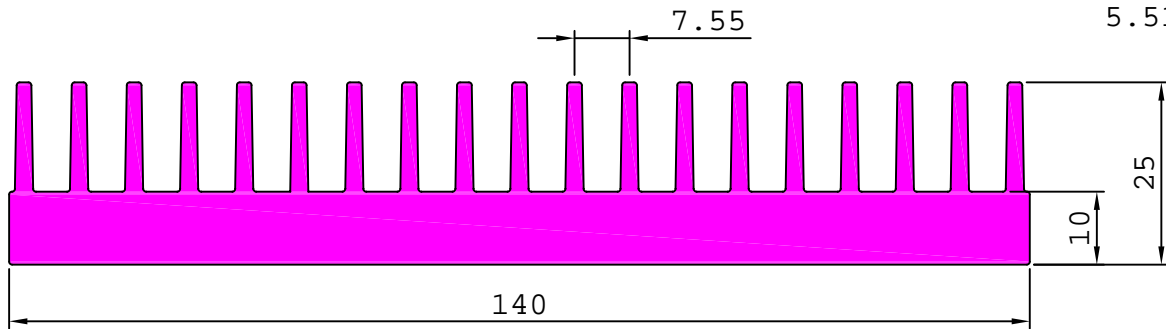

26484

1.363 kg/m

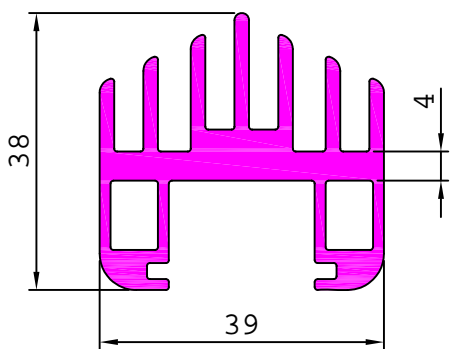

26488

4.607 kg/m

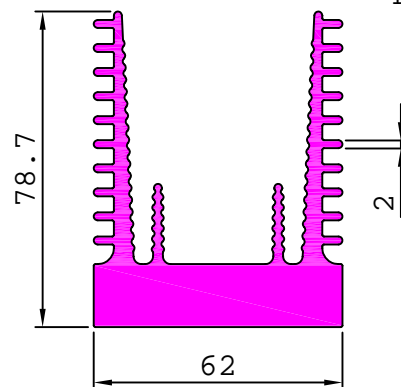

26485

2.708 kg/m

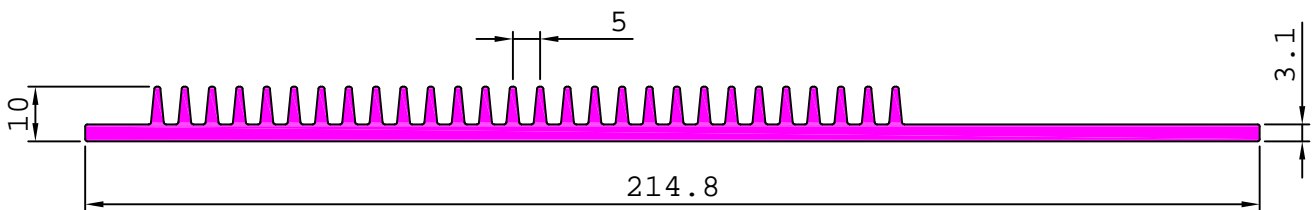

26490

6.418 kg/m

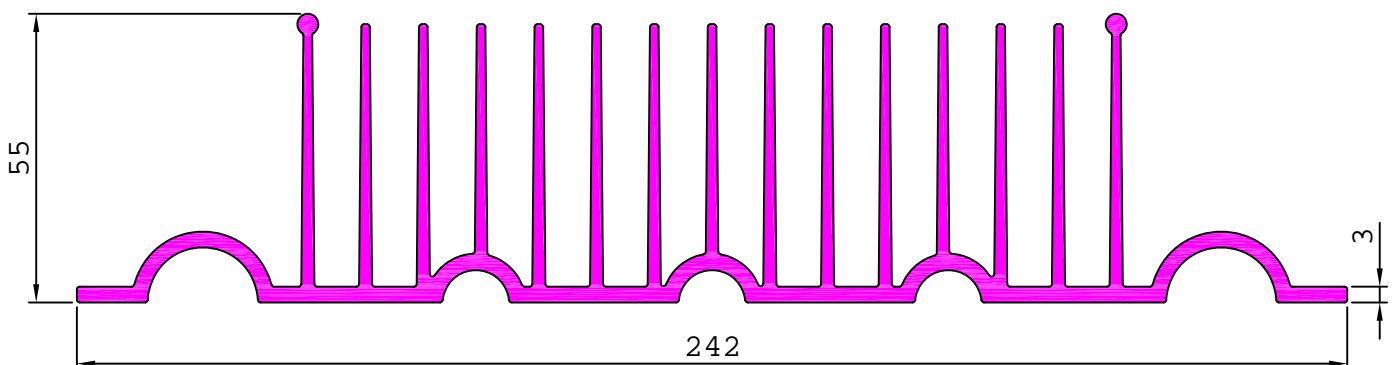

INDUSTRIAL

HEAT SINKS

26486

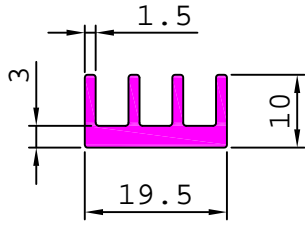

0.271 kg/m

26491

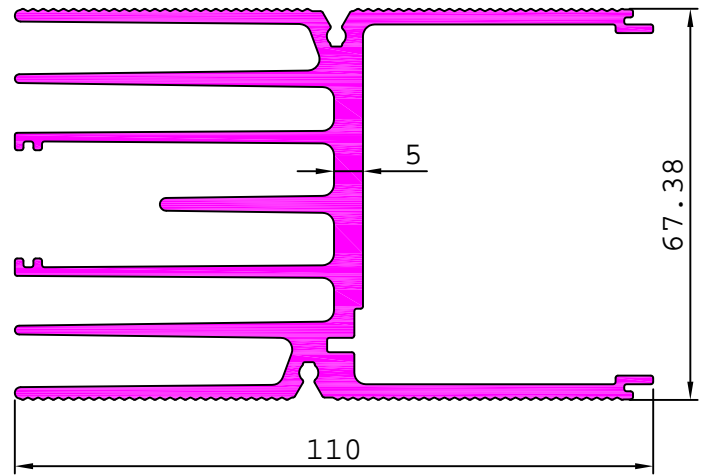

3.740 kg/m

26489

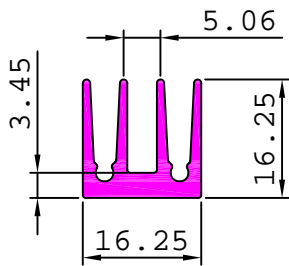

0.322 kg/m

26492

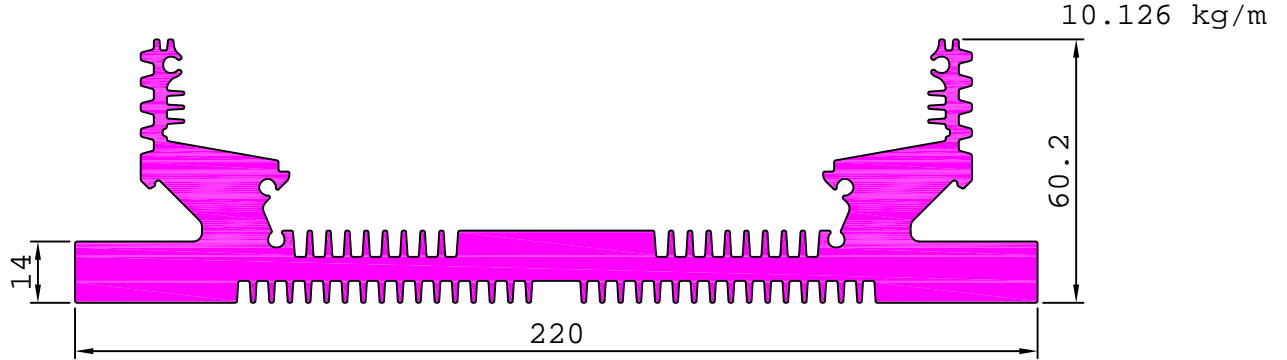

10.126 kg/m

26493

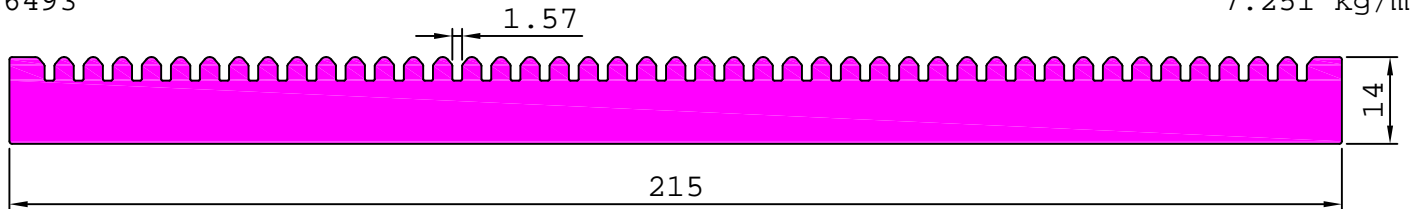

7.251 kg/m

26494

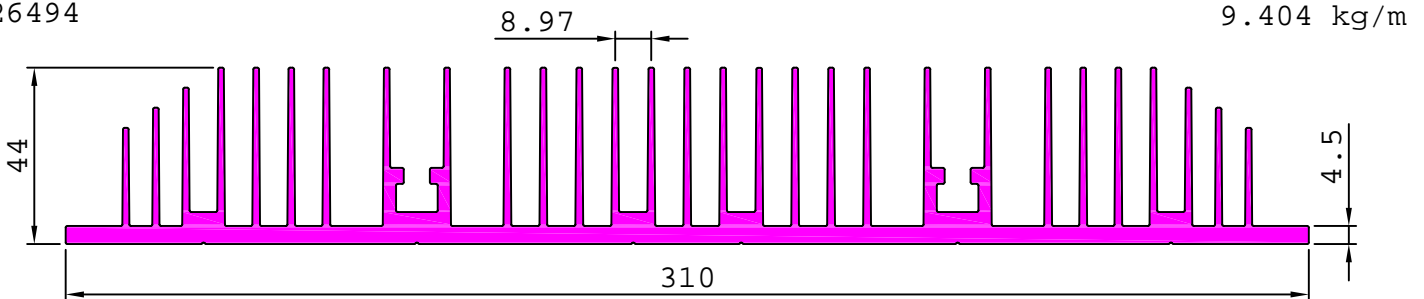

9.404 kg/m

26495

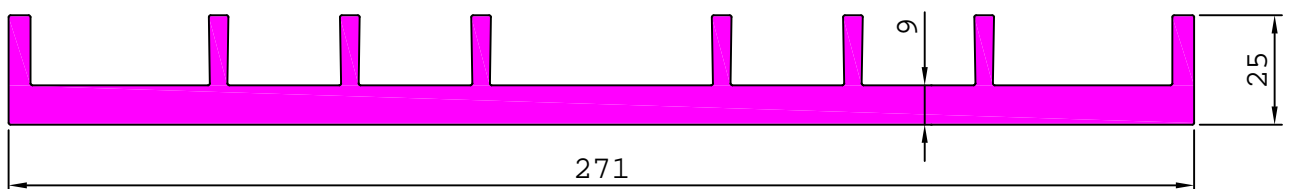

8.120 kg/m

INDUSTRIAL

HEAT SINKS

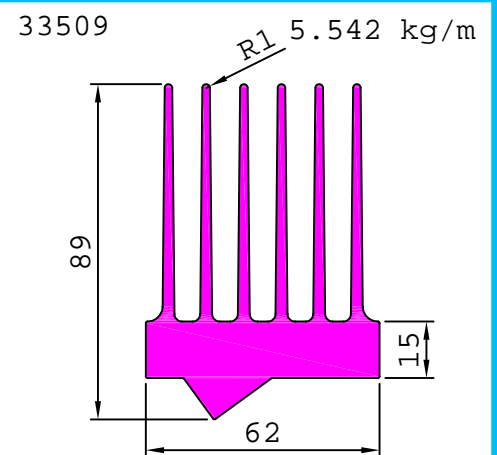
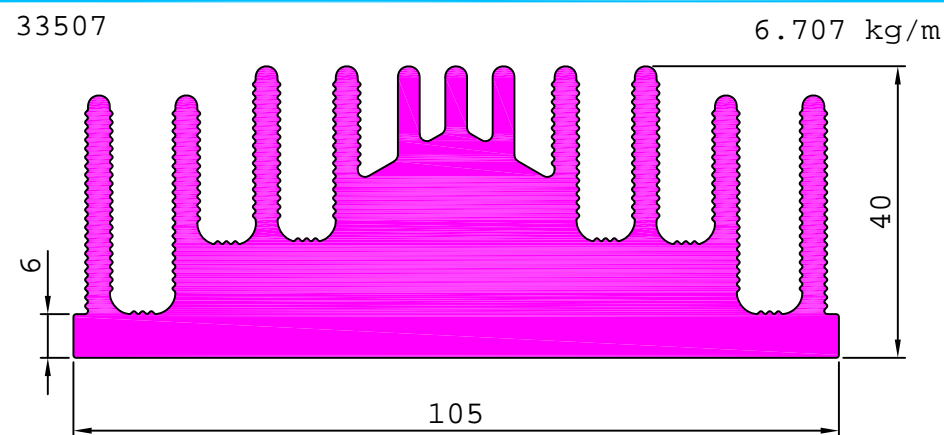
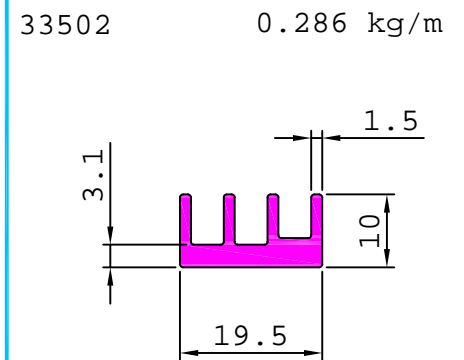
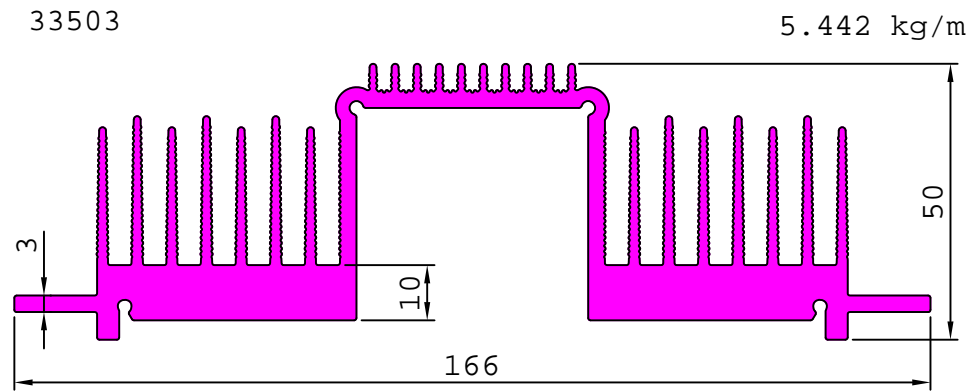
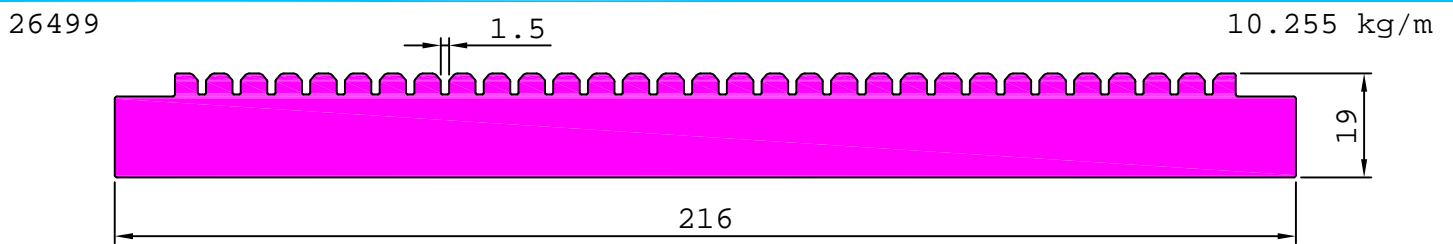
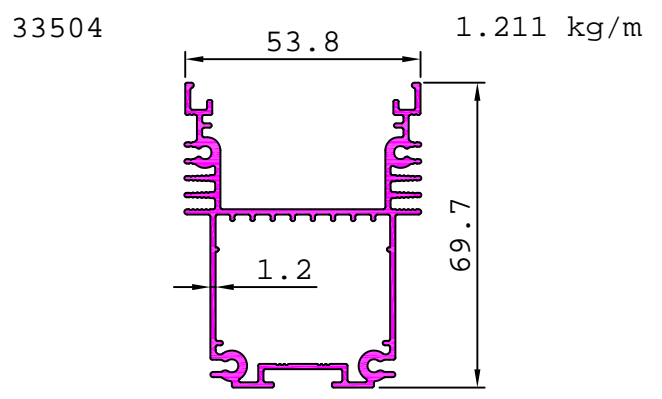
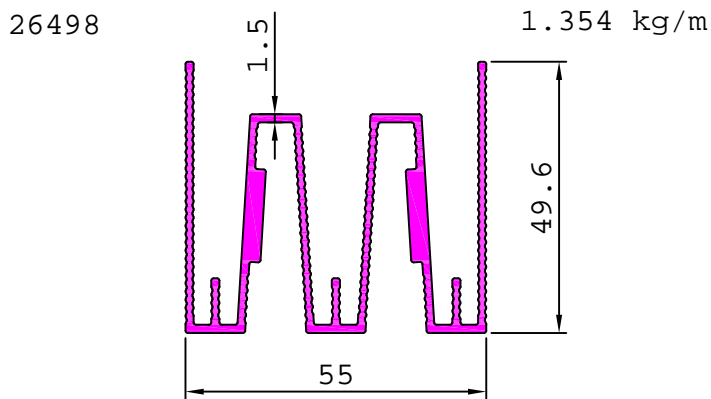
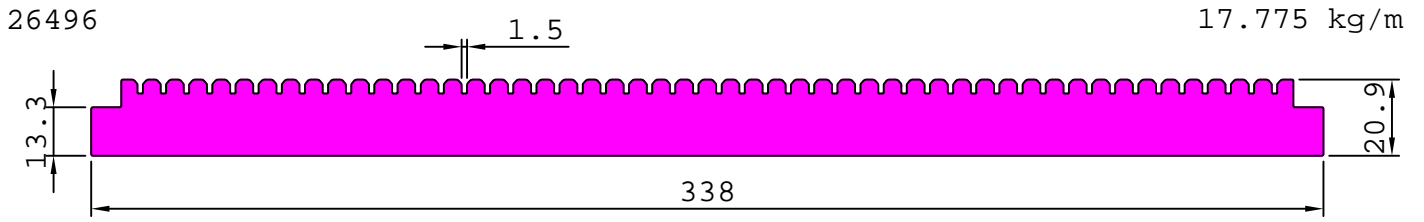

INDUSTRIAL

HEAT SINKS

33506

6.222 kg/m

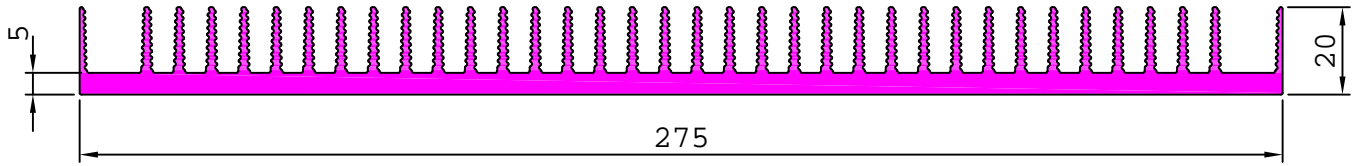

33508

4.919 kg/m

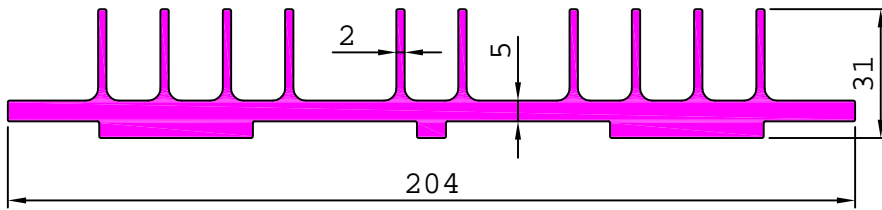

33505

0.810 kg/m

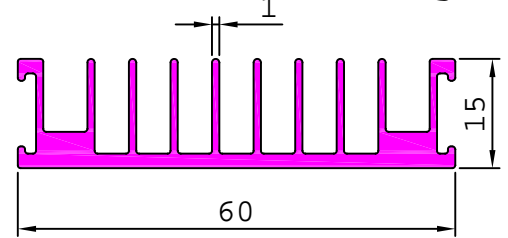

33510

342.1

15.125 kg/m

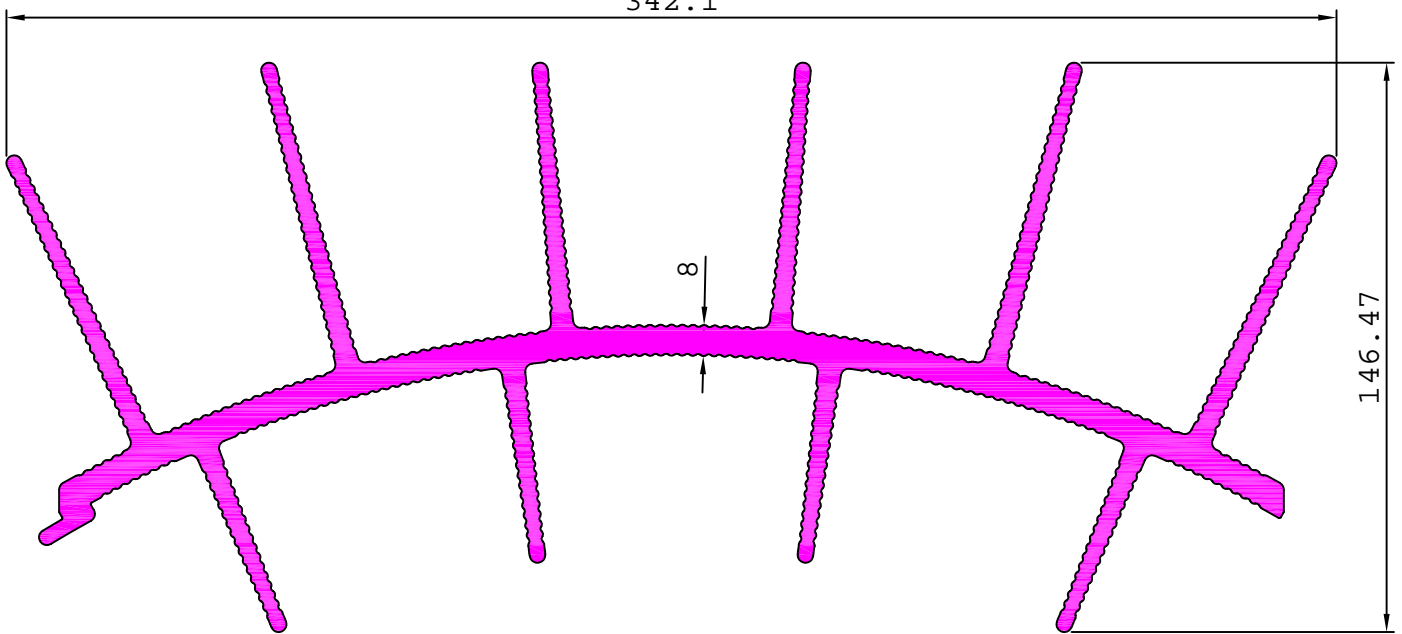

33513

8.660 kg/m

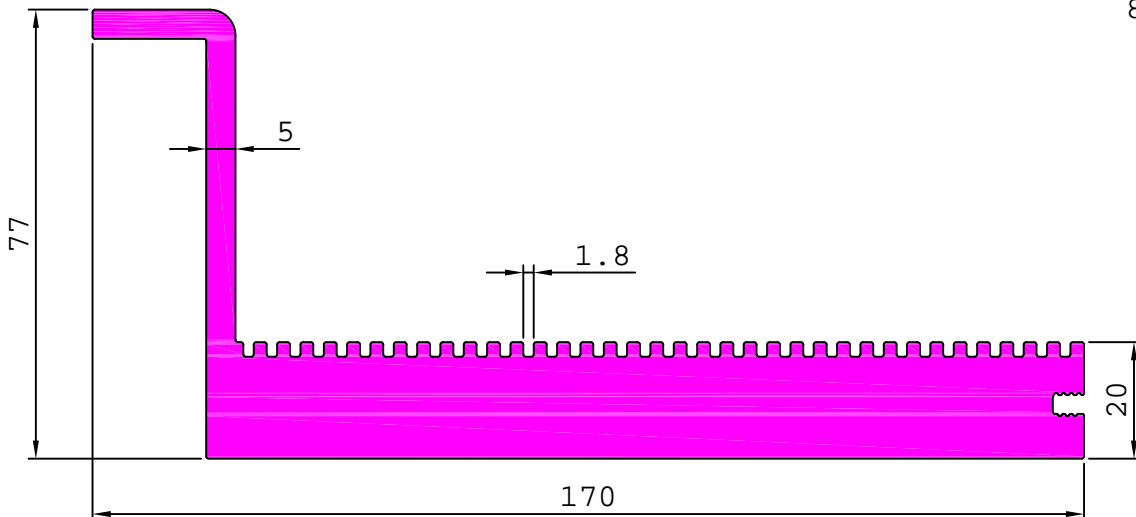

INDUSTRIAL

HEAT SINKS

33511

14.213 kg/m

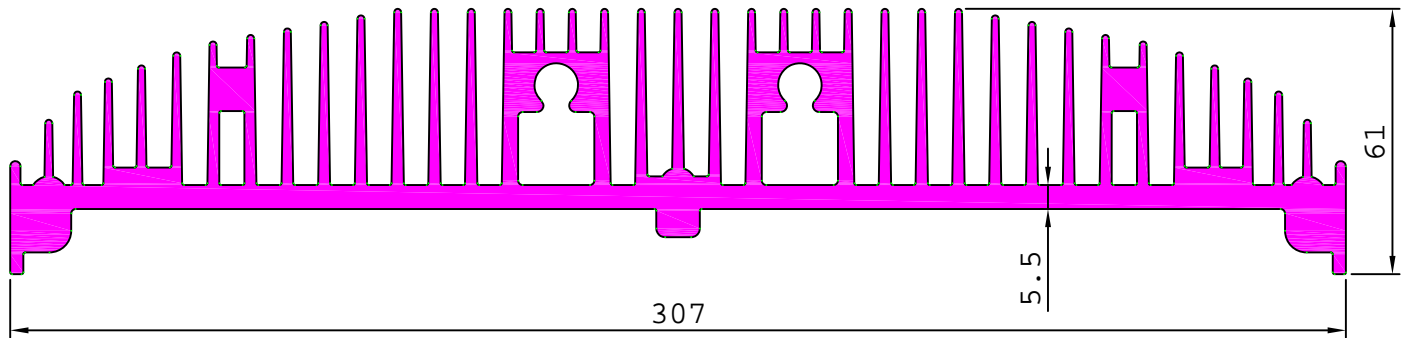

33512

2.493 kg/m

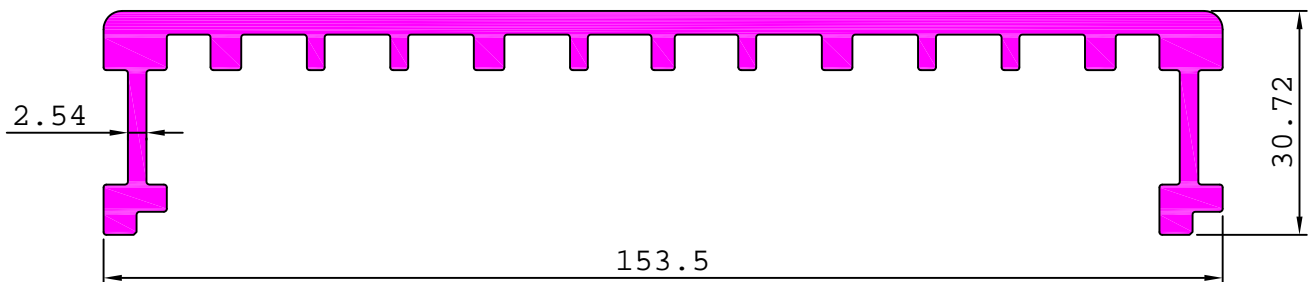

33514

3.101 kg/m

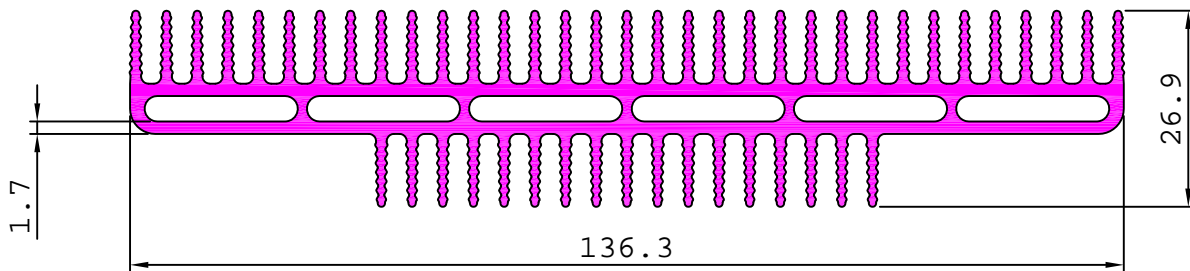

33515

2.661 kg/m

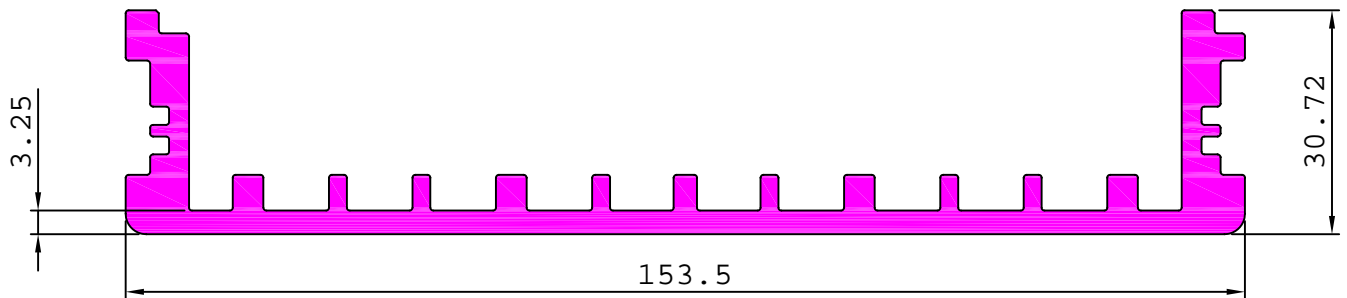

33516

0.363 kg/m

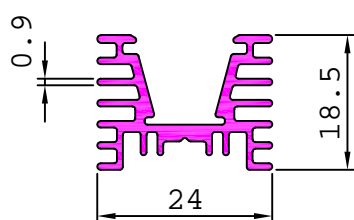

33518

1.119 kg/m

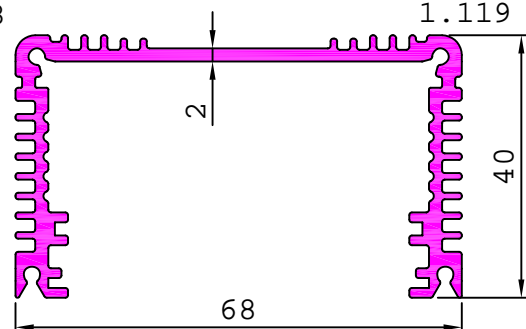

INDUSTRIAL

HEAT SINKS

33517

18.571 kg/m

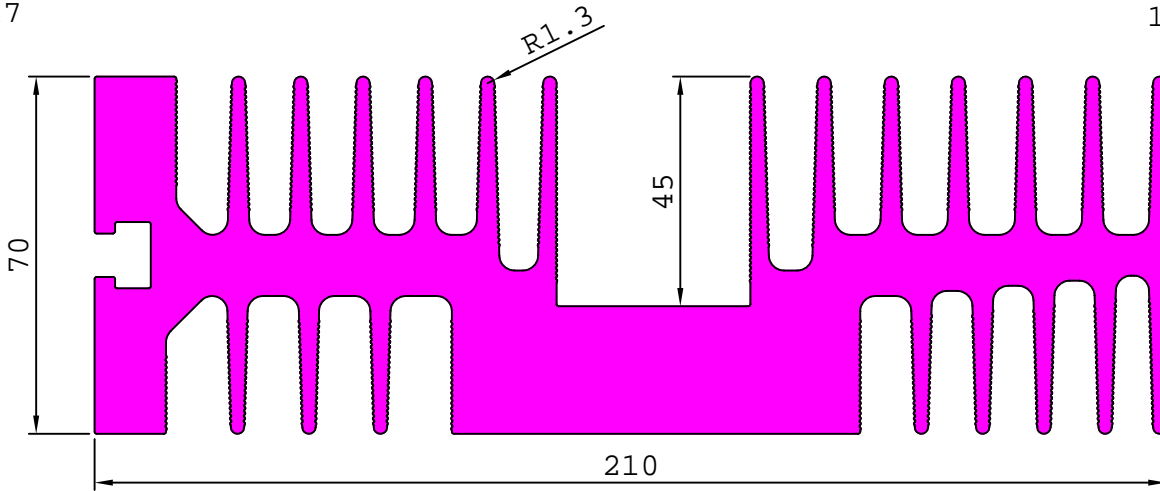

33520

2.105 kg/m

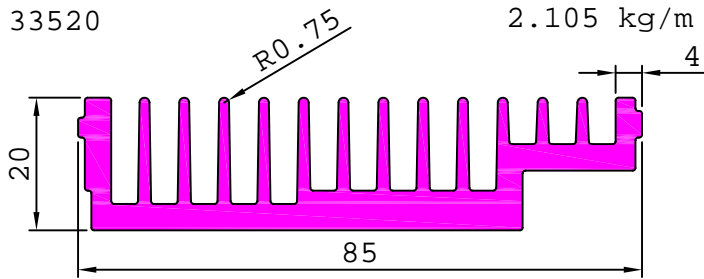

33521

1.206 kg/m

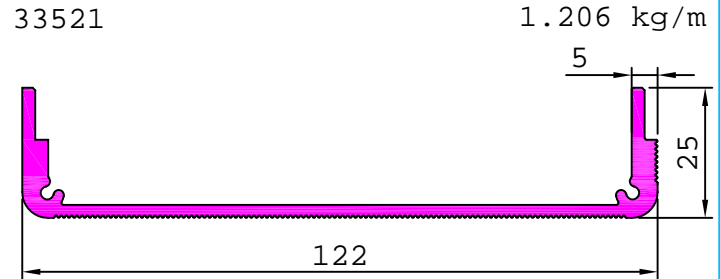

33522

7.007 kg/m

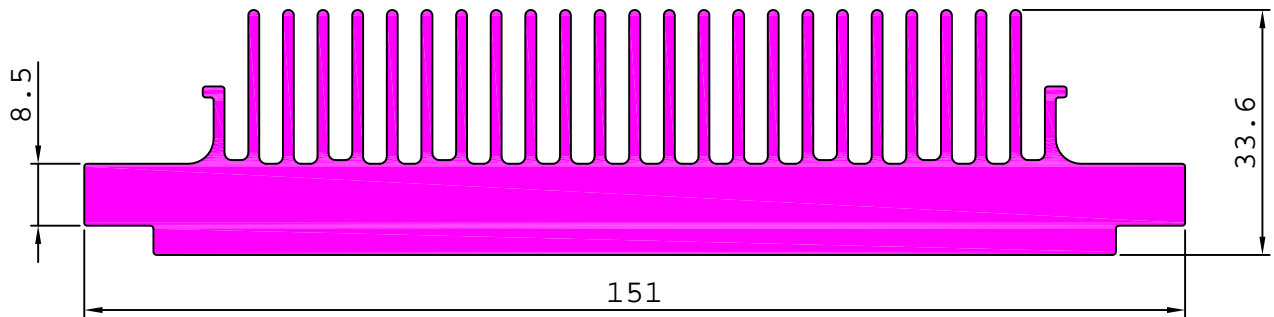

33523

18.489 kg/m

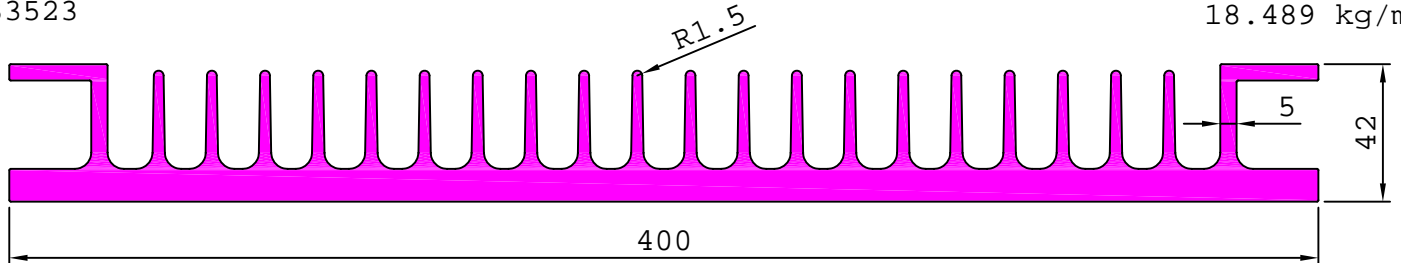

33524

2.797 kg/m

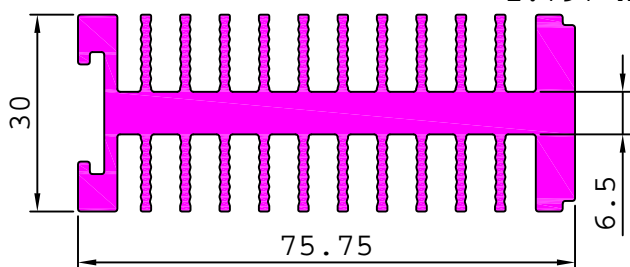

33530

0.847 kg/m

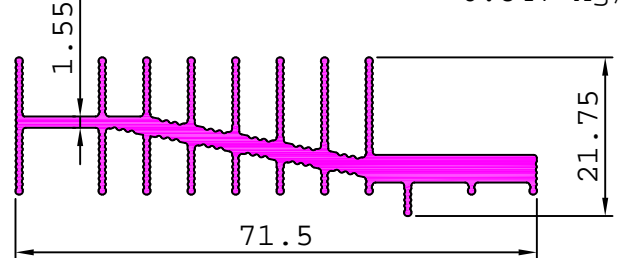

INDUSTRIAL

HEAT SINKS

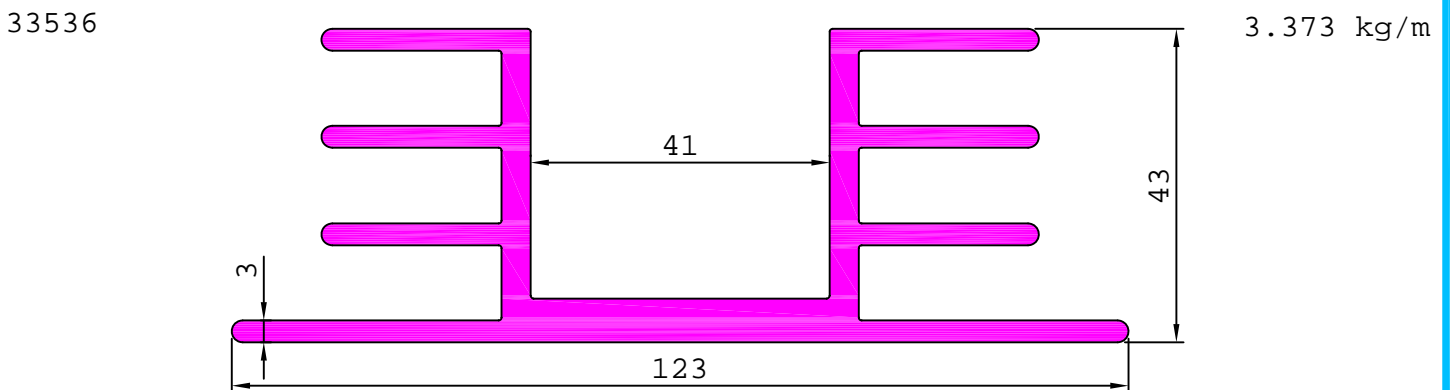
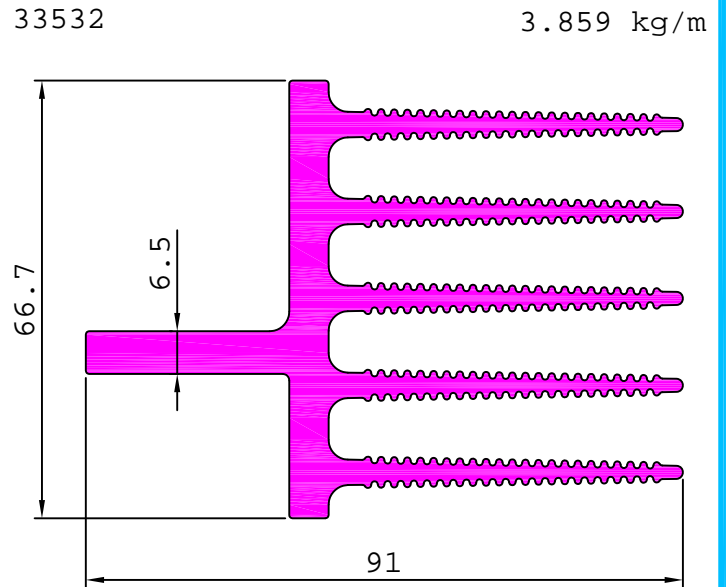
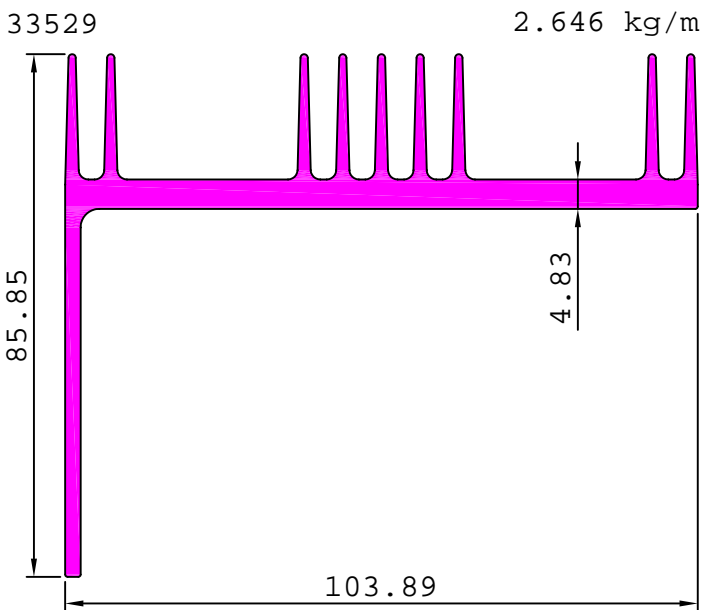
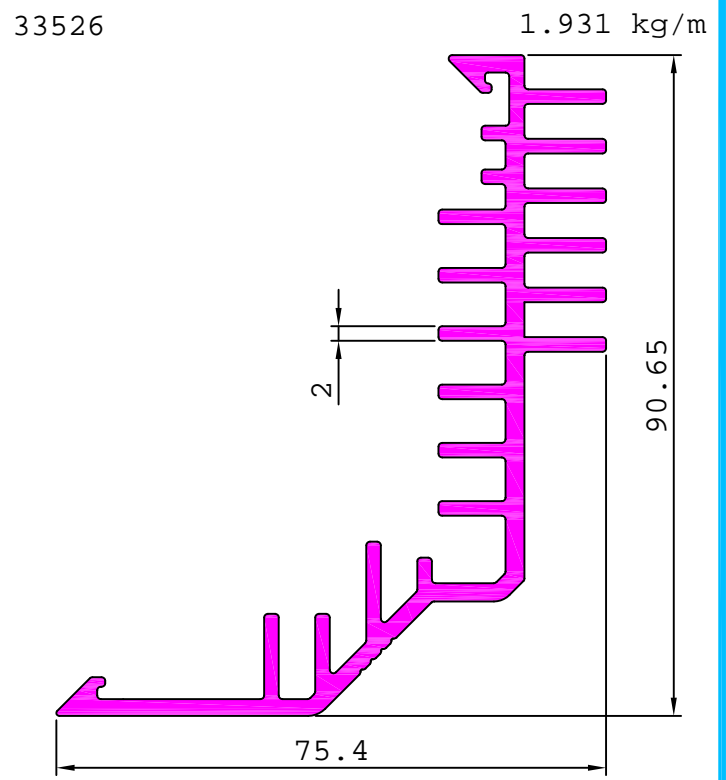
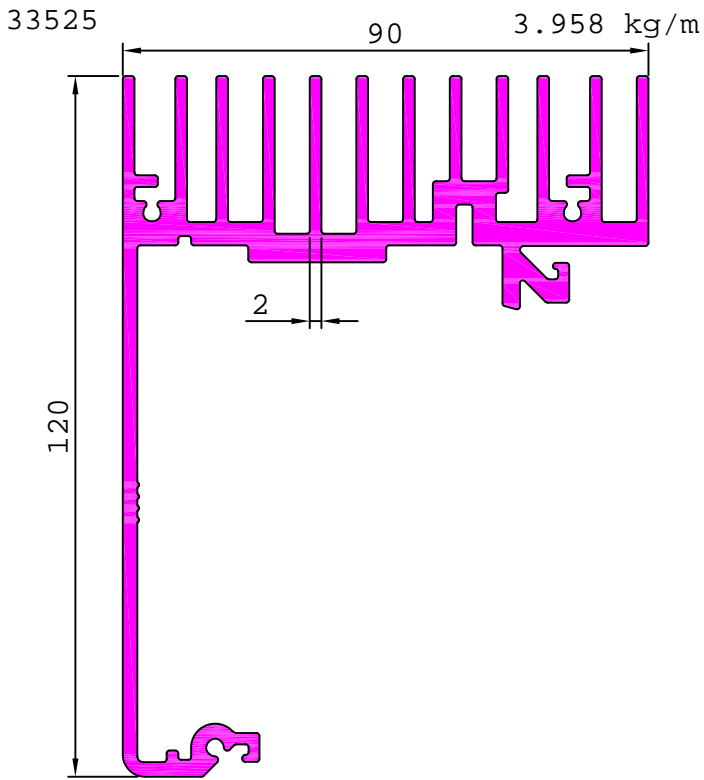

INDUSTRIAL

HEAT SINKS

33531

3.861 kg/m

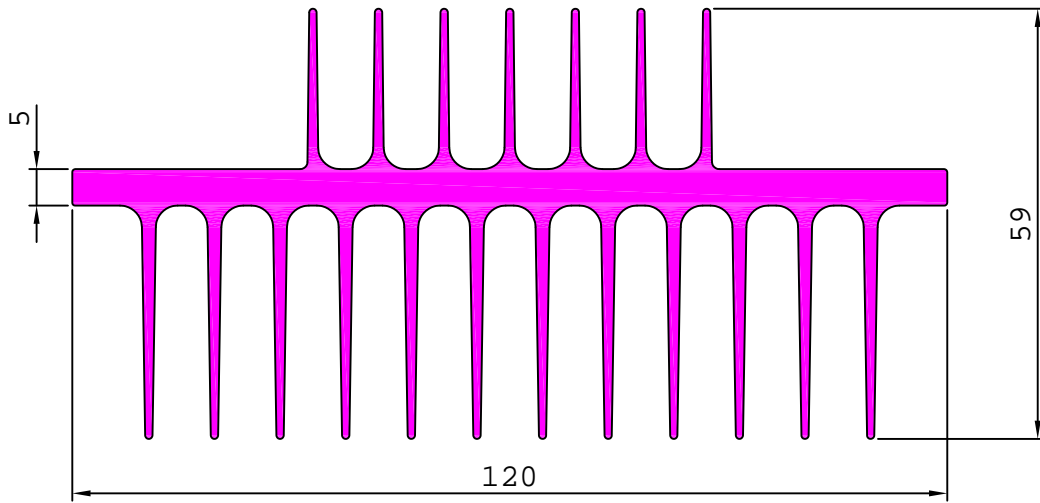

33533

8.405 kg/m

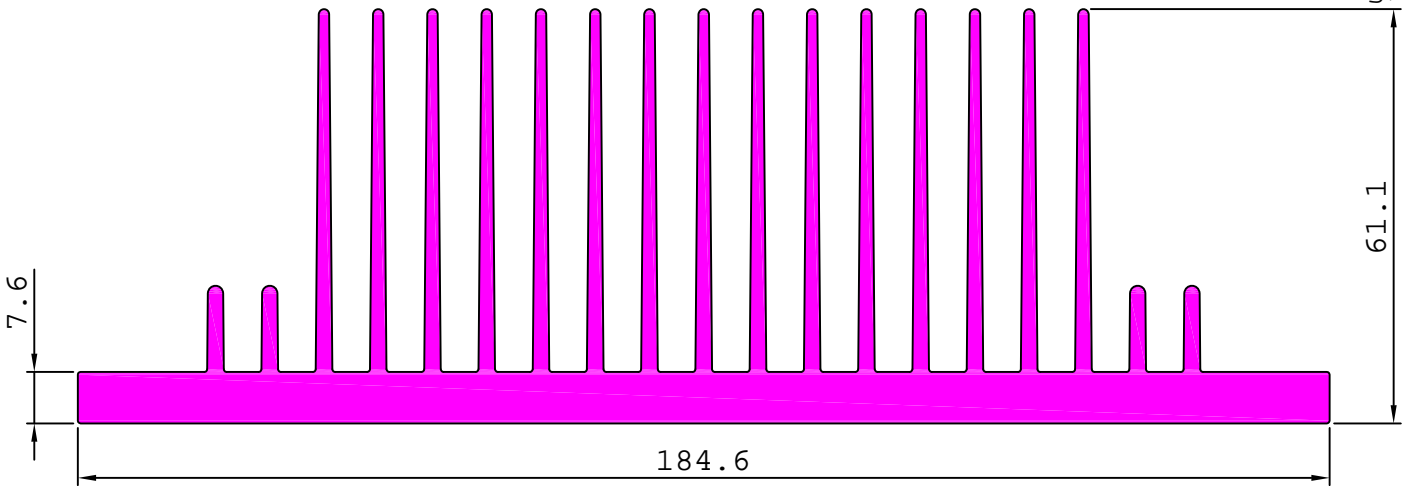

33544

4.674 kg/m

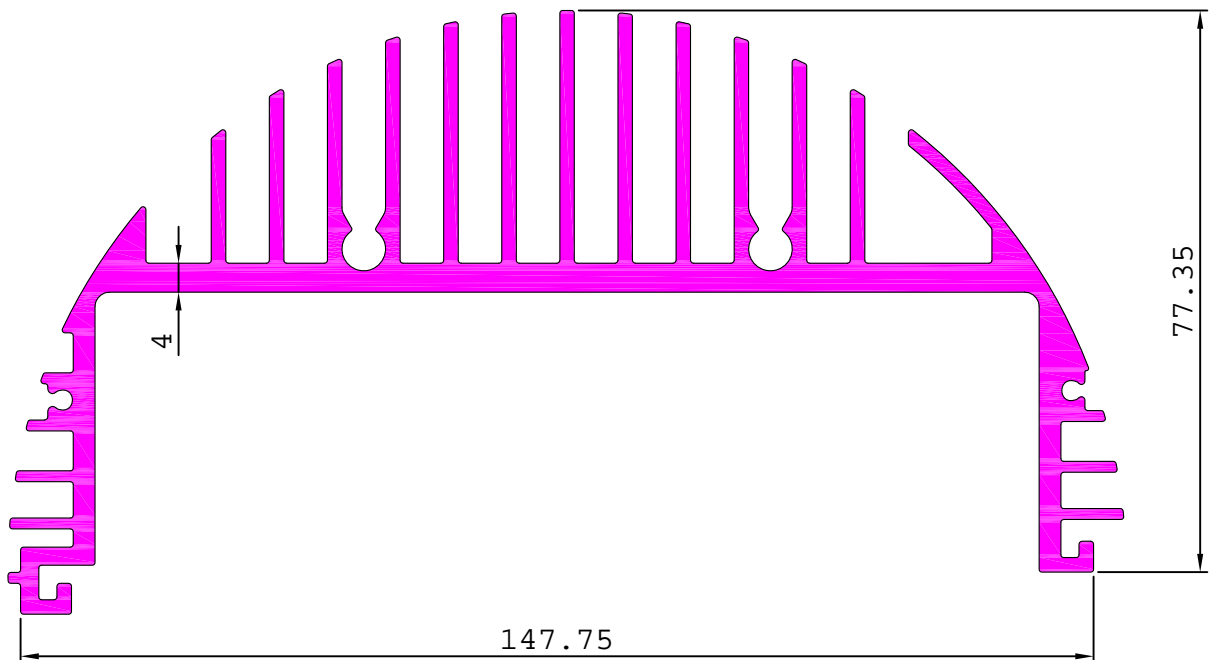

INDUSTRIAL

HEAT SINKS

33535

26.514 kg/m

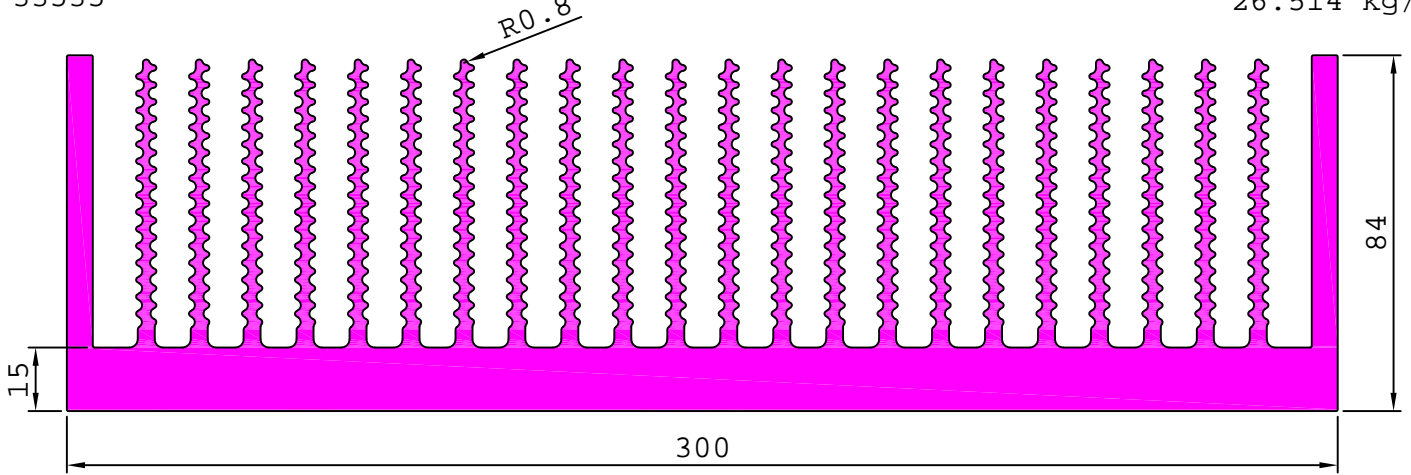

33539

3.704 kg/m

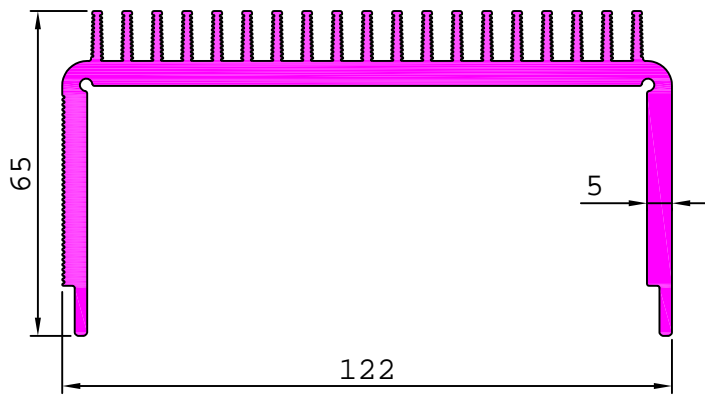

33534

0.394 kg/m

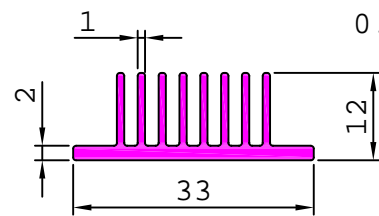

33540

0.501 kg/m

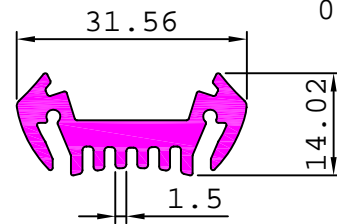

33542

4.773 kg/m

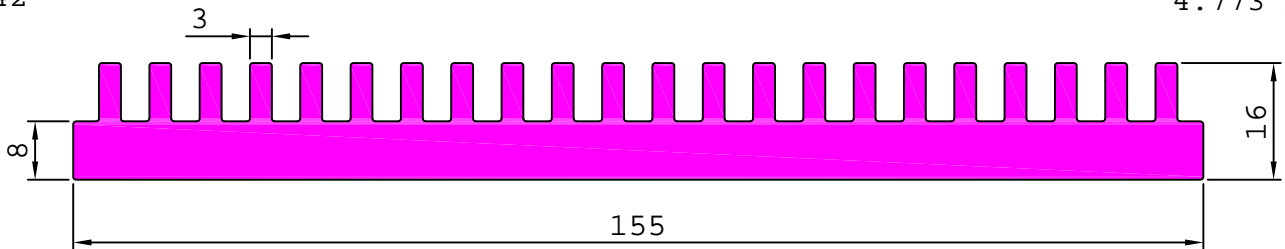

33543

9.164 kg/m

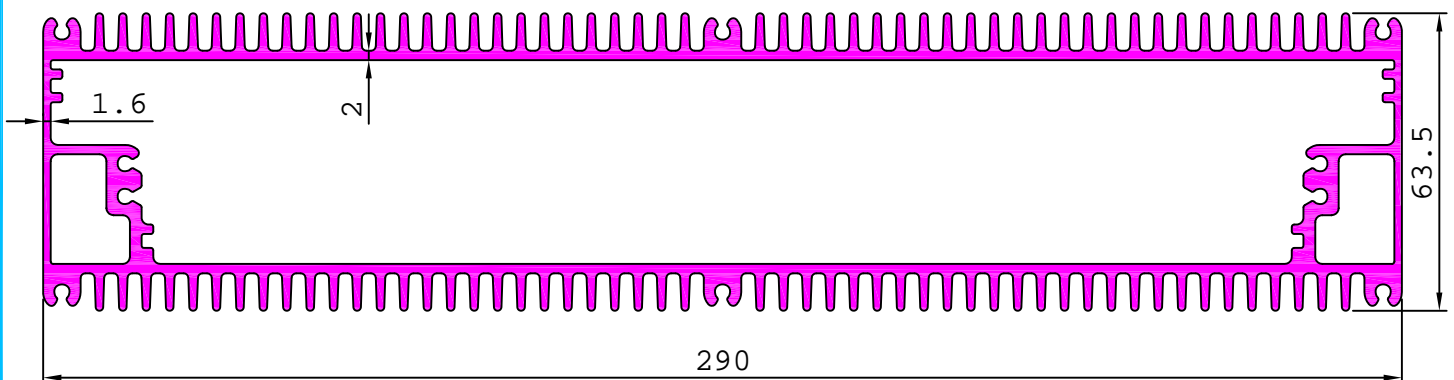

INDUSTRIAL

HEAT SINKS

33545

23.692 kg/m

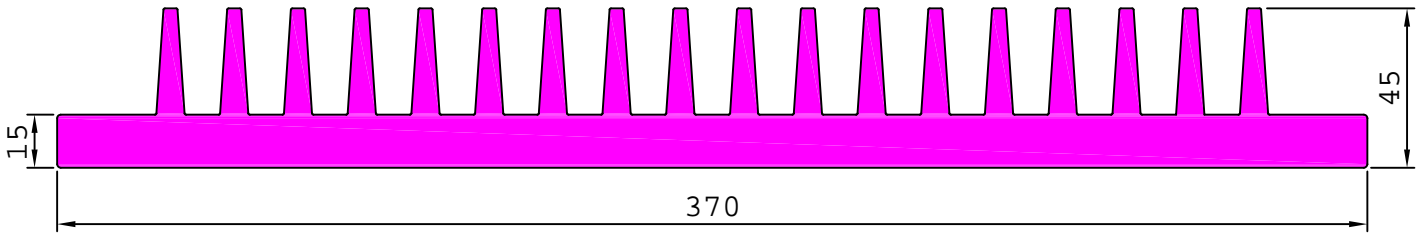

33546

12.730 kg/m

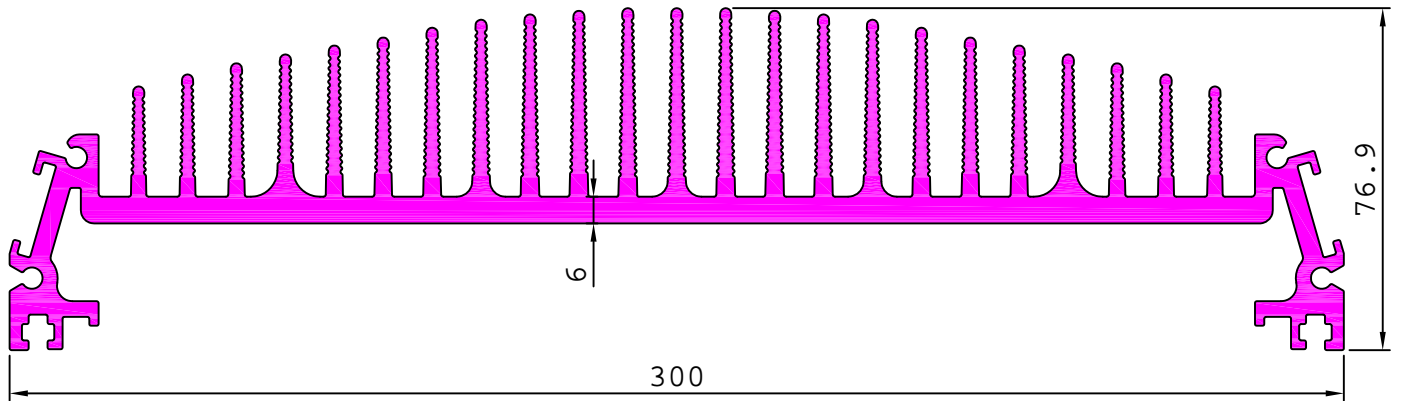

33547

5.035 kg/m

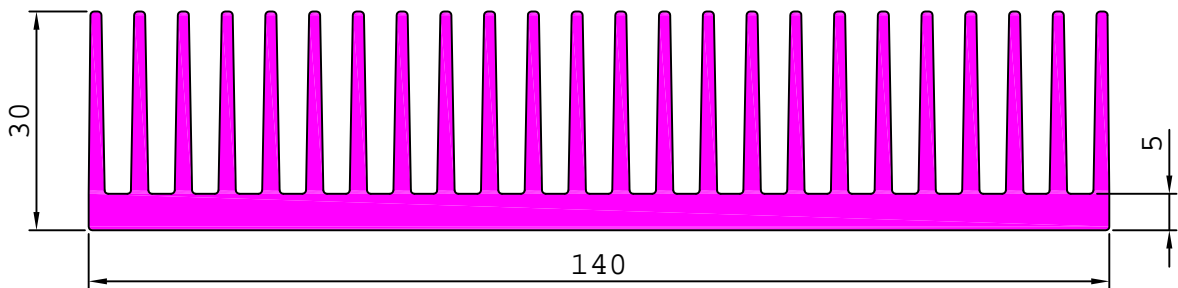

33548

1.924 kg/m

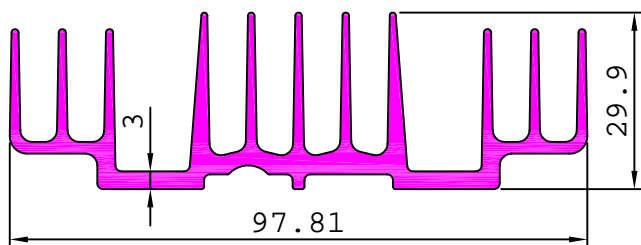

33549

2.602 kg/m

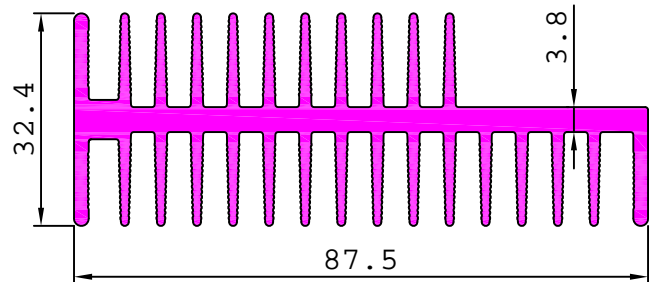

33550

2.896 kg/m

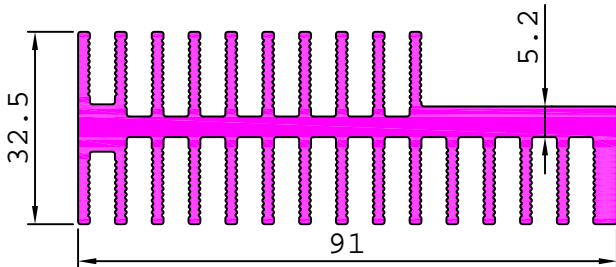

33557

2.021 kg/m

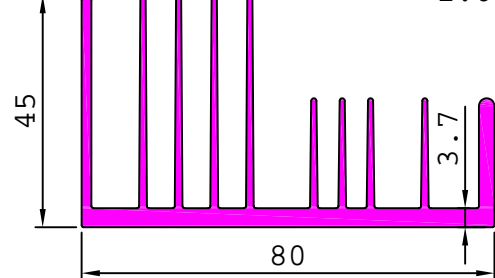

INDUSTRIAL

HEAT SINKS

33553

7.497 kg/m

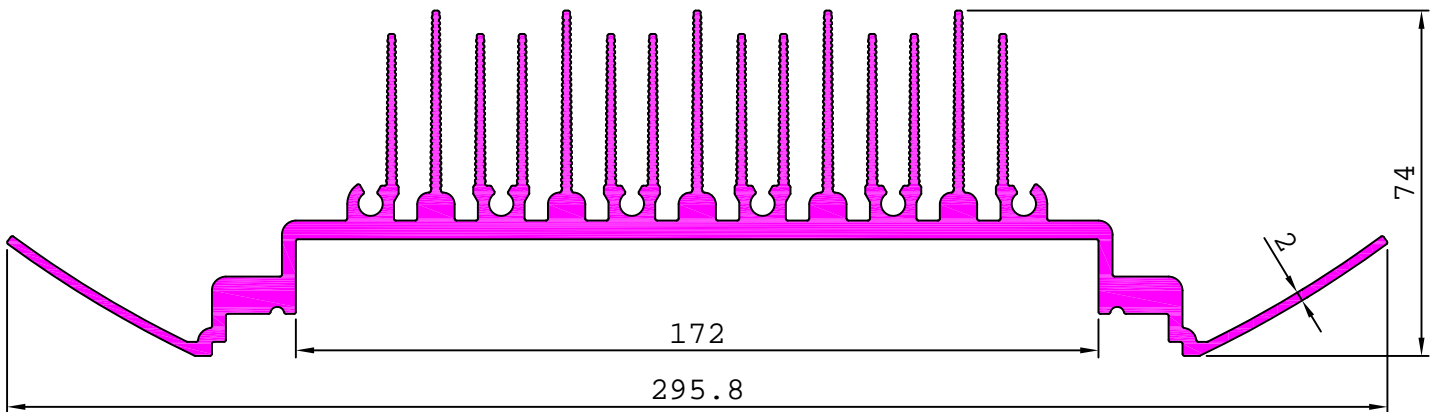

33552

4.728 kg/m

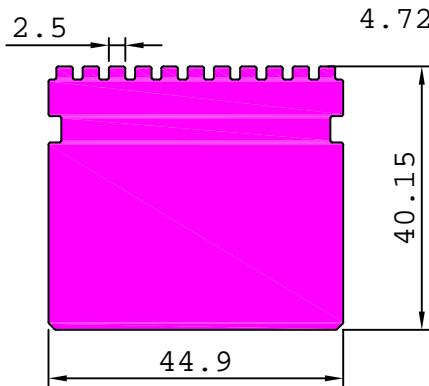

33554

4.575 kg/m

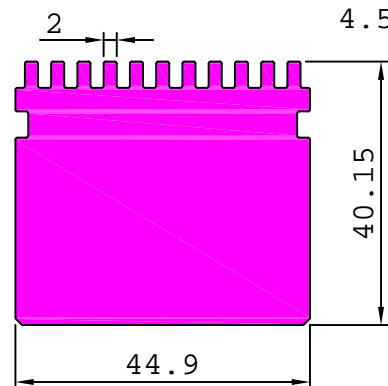

33551

0.728 kg/m

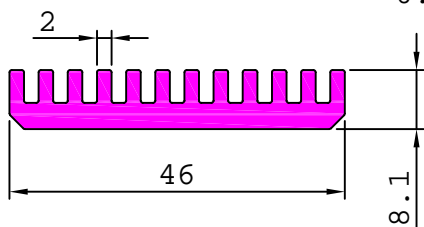

33569

0.781 kg/m

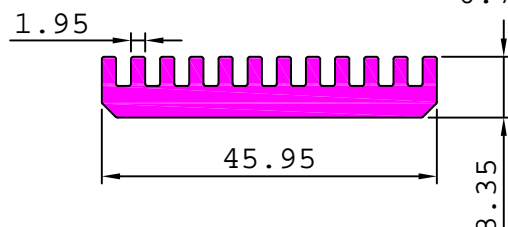

33555

0.744 kg/m

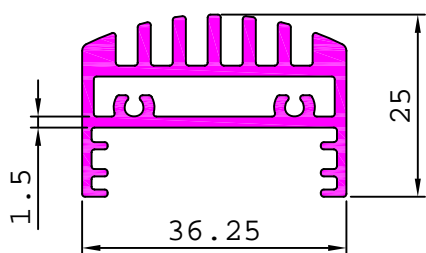

33556

0.759 kg/m

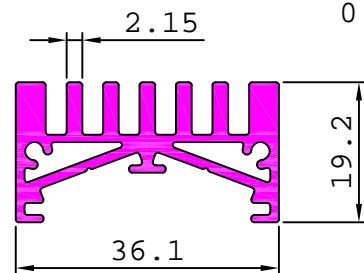

33567

10.117 kg/m

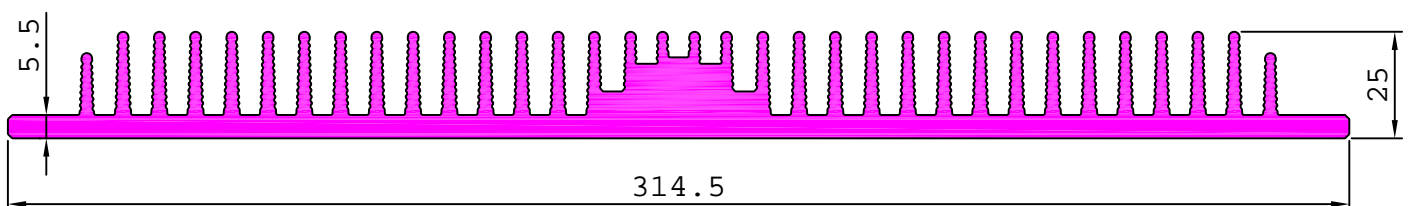

INDUSTRIAL

HEAT SINKS

33558

10.951 kg/m

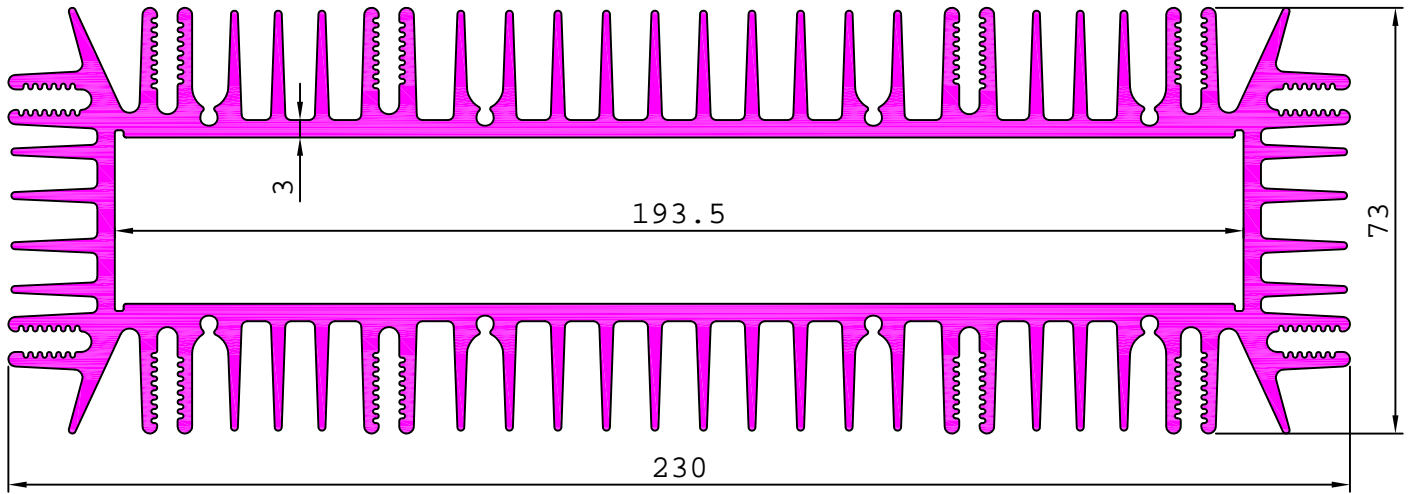

33559

4.918 kg/m

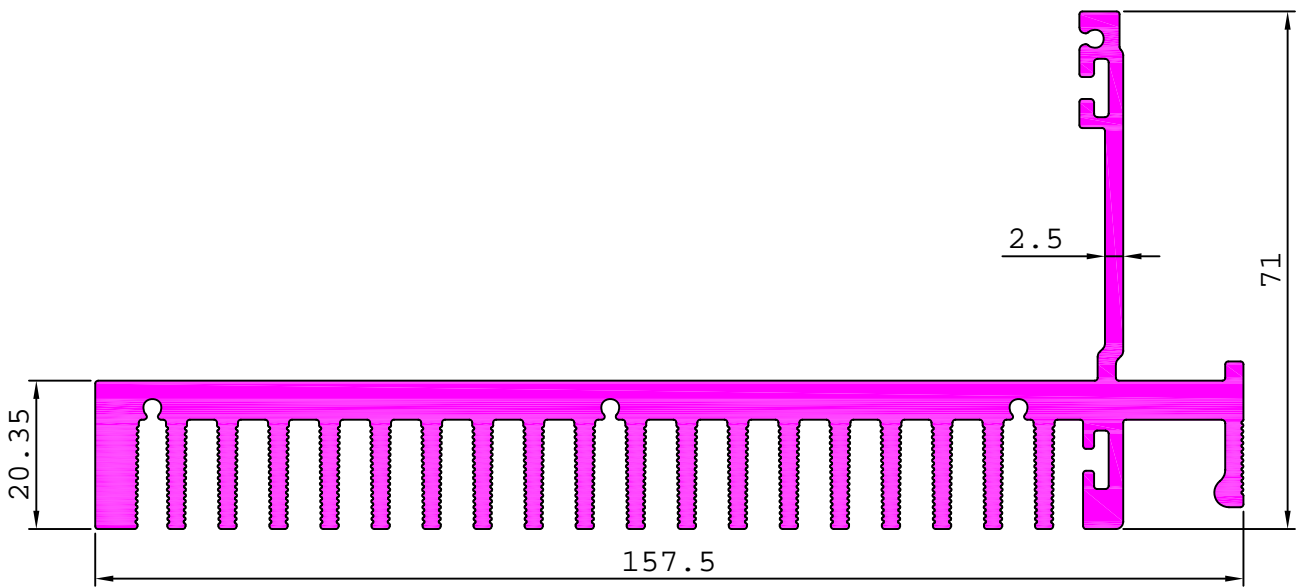

33561

3.562 kg/m

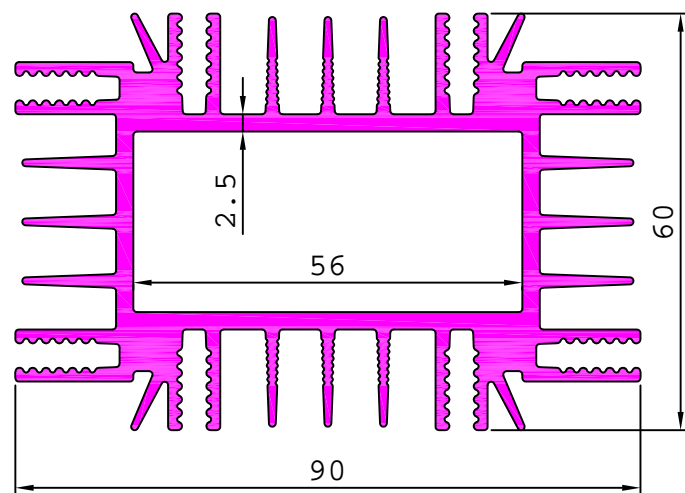

33563

0.953 kg/m

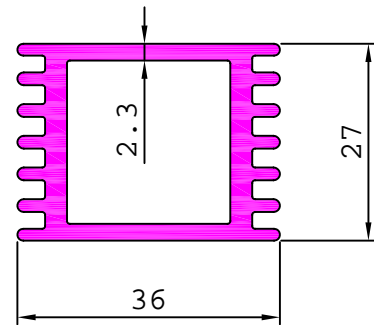

INDUSTRIAL

HEAT SINKS

33562

7.571 kg/m

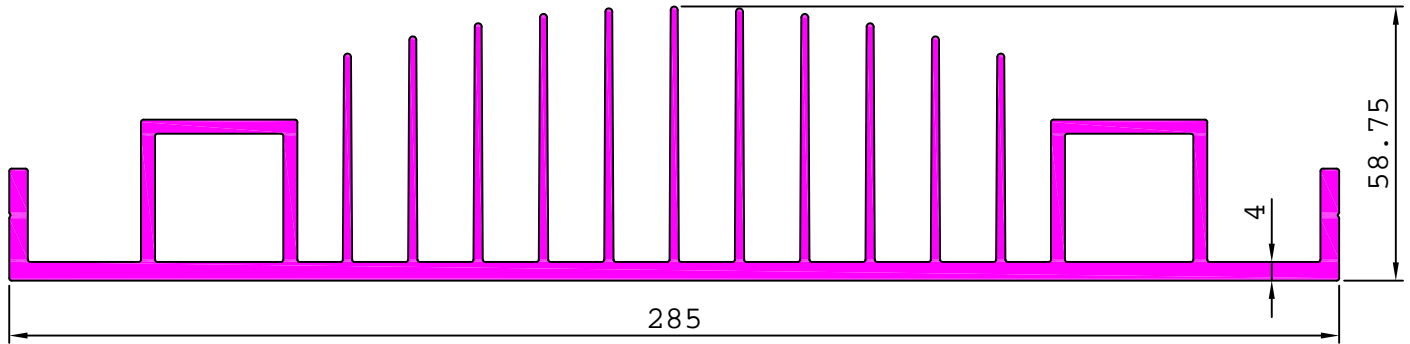

33564

1.116 kg/m

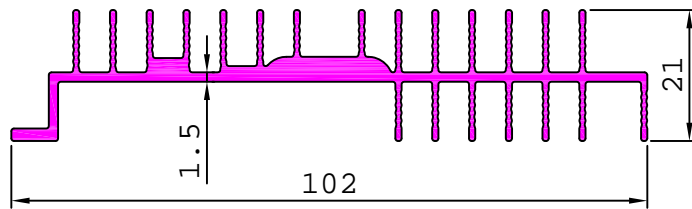

33565

7.093 kg/m

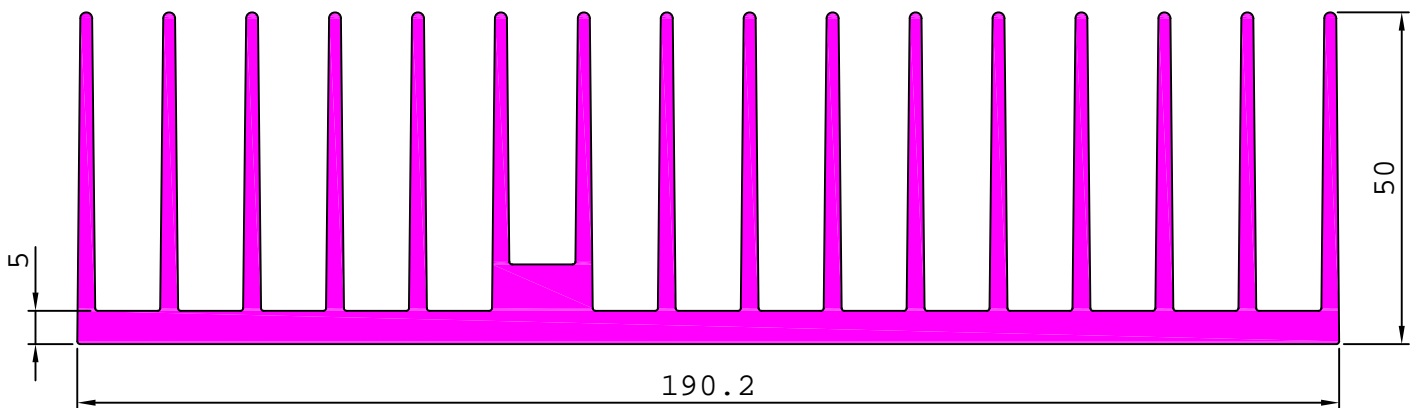

33566

9.041 kg/m

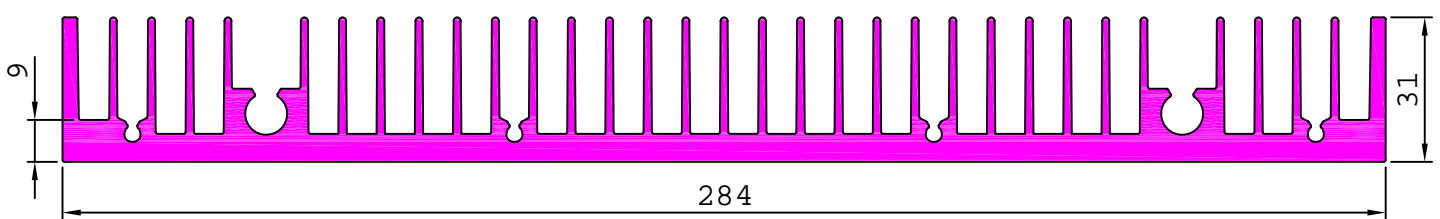

33570

0.674 kg/m

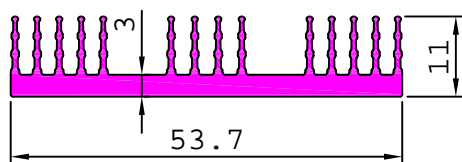

33571

1.501 kg/m

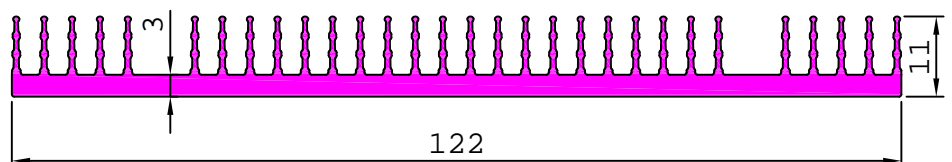

INDUSTRIAL

HEAT SINKS

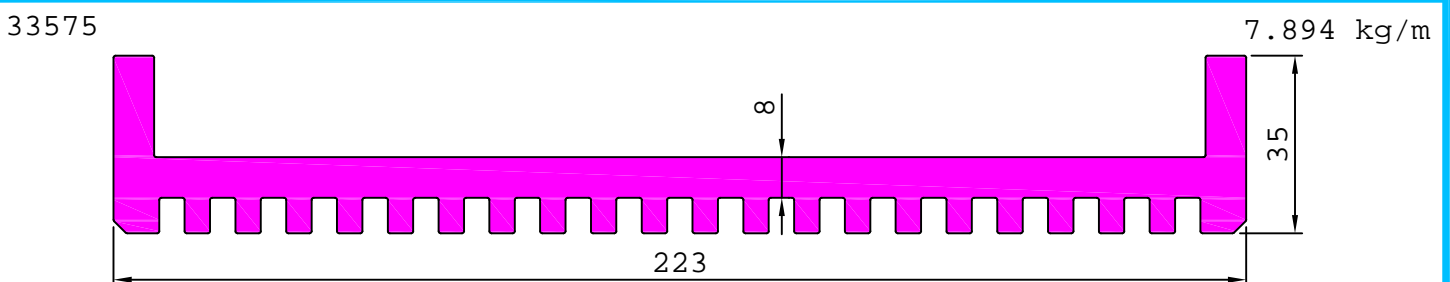
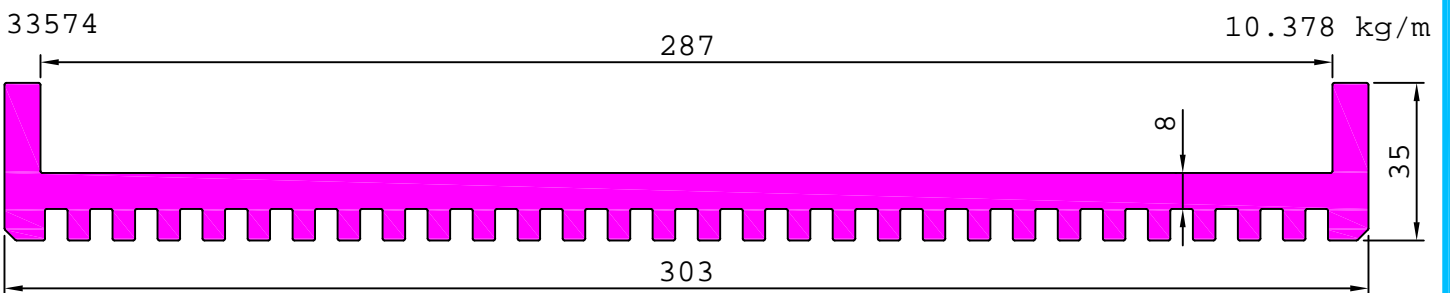
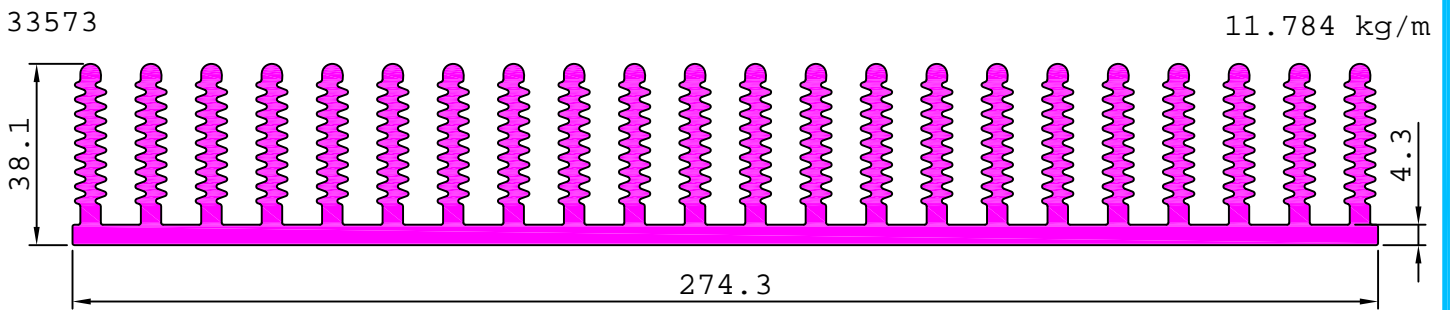
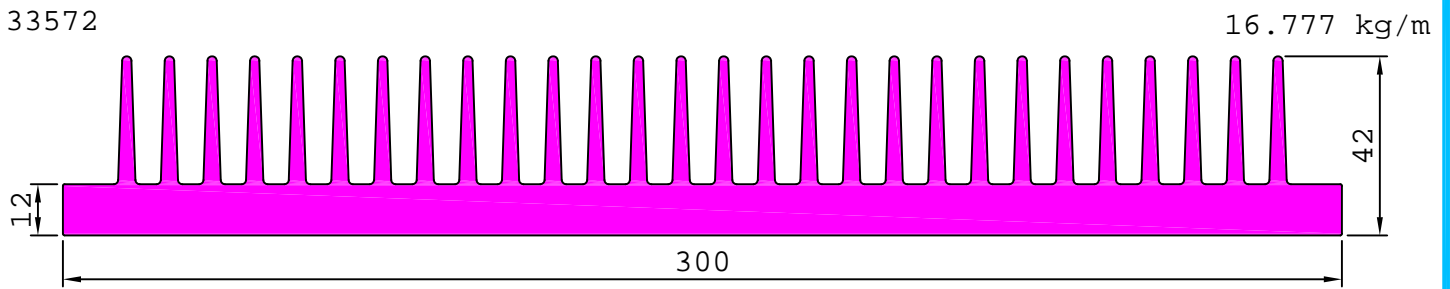
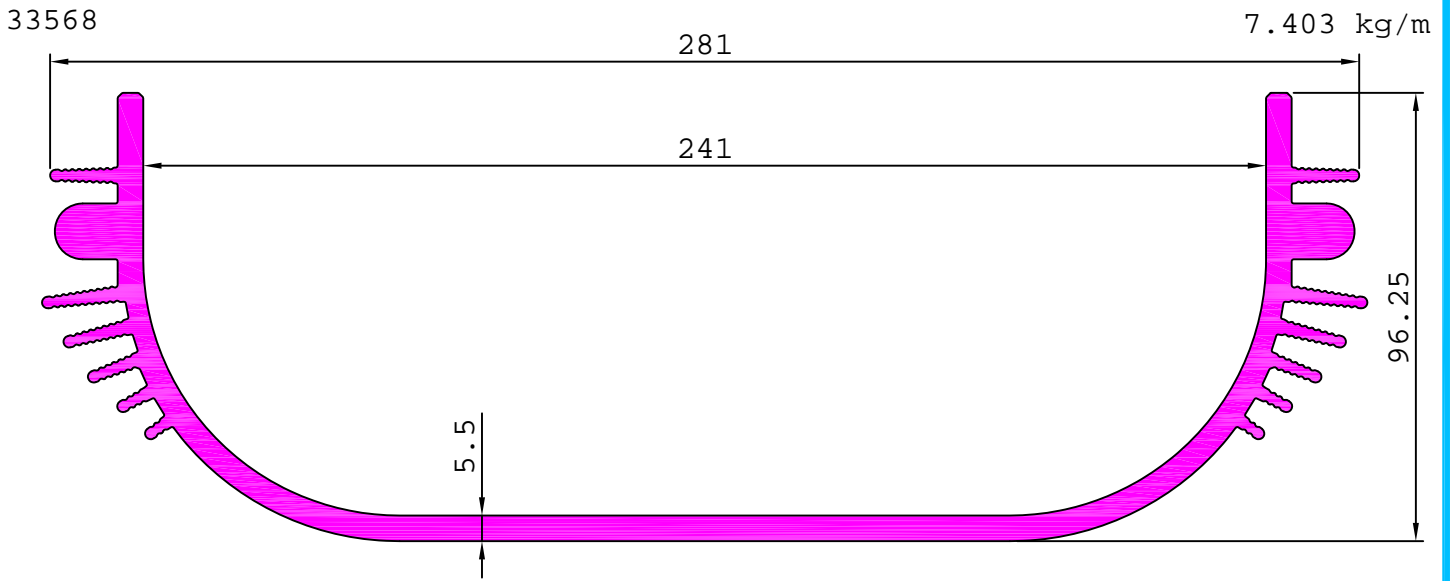

INDUSTRIAL

HEAT SINKS

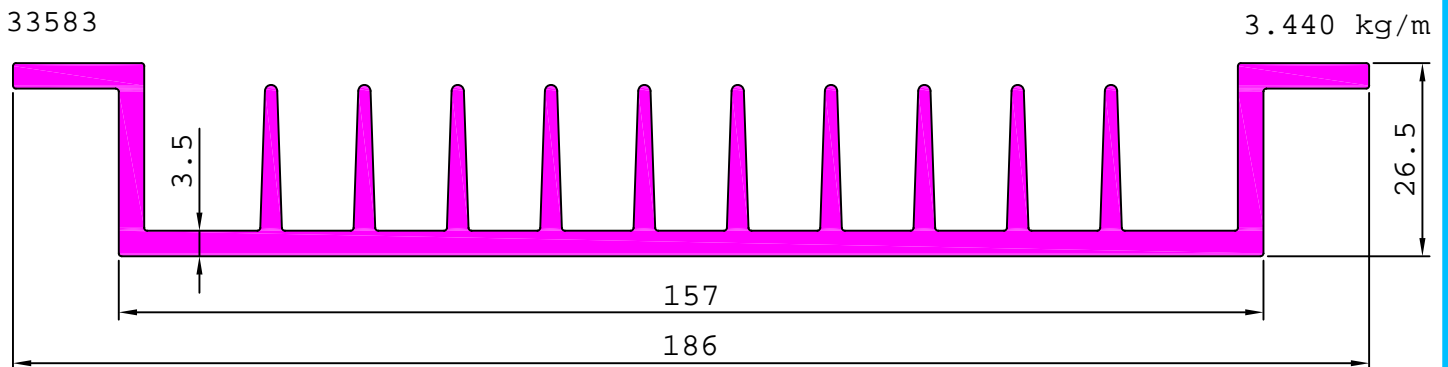
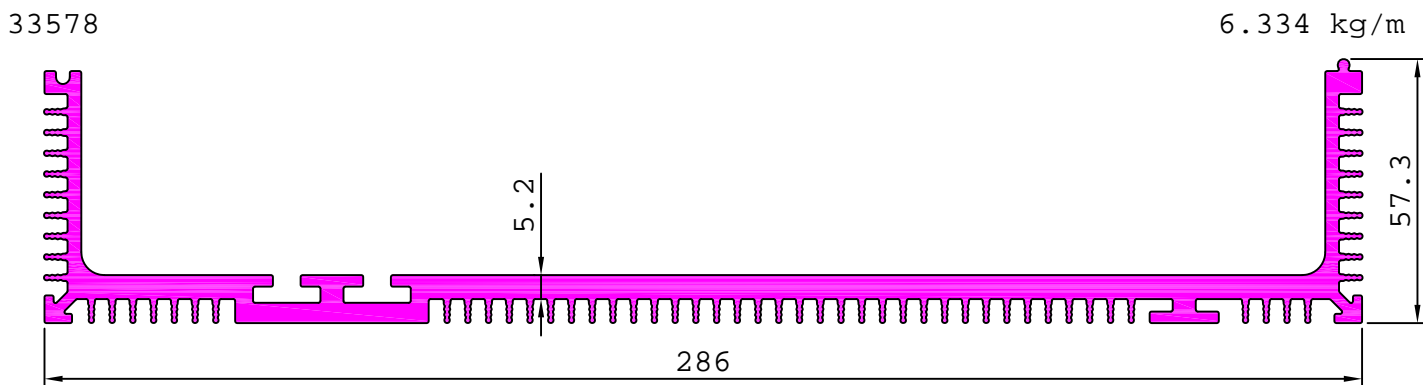
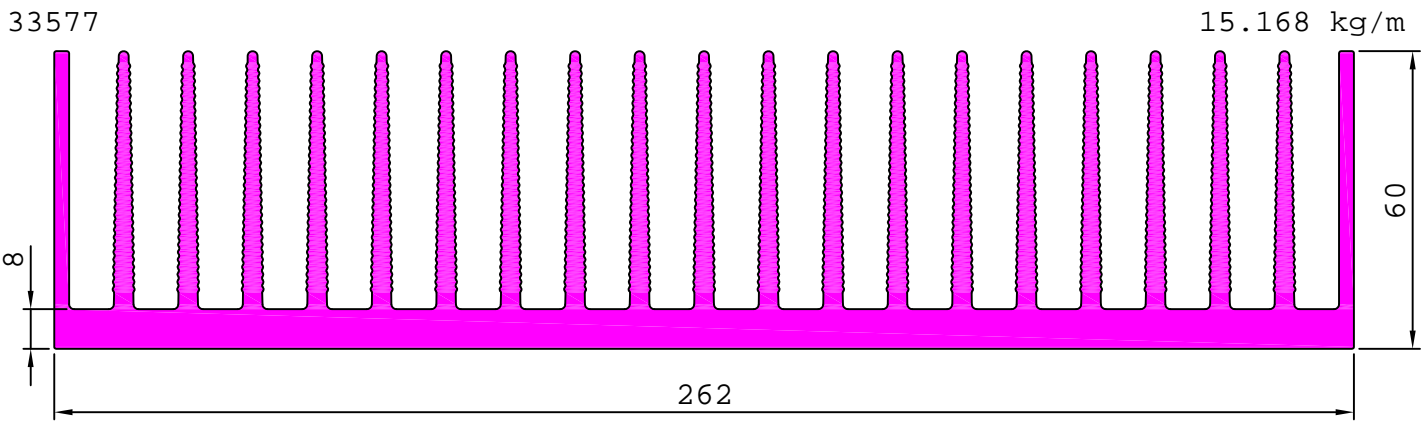
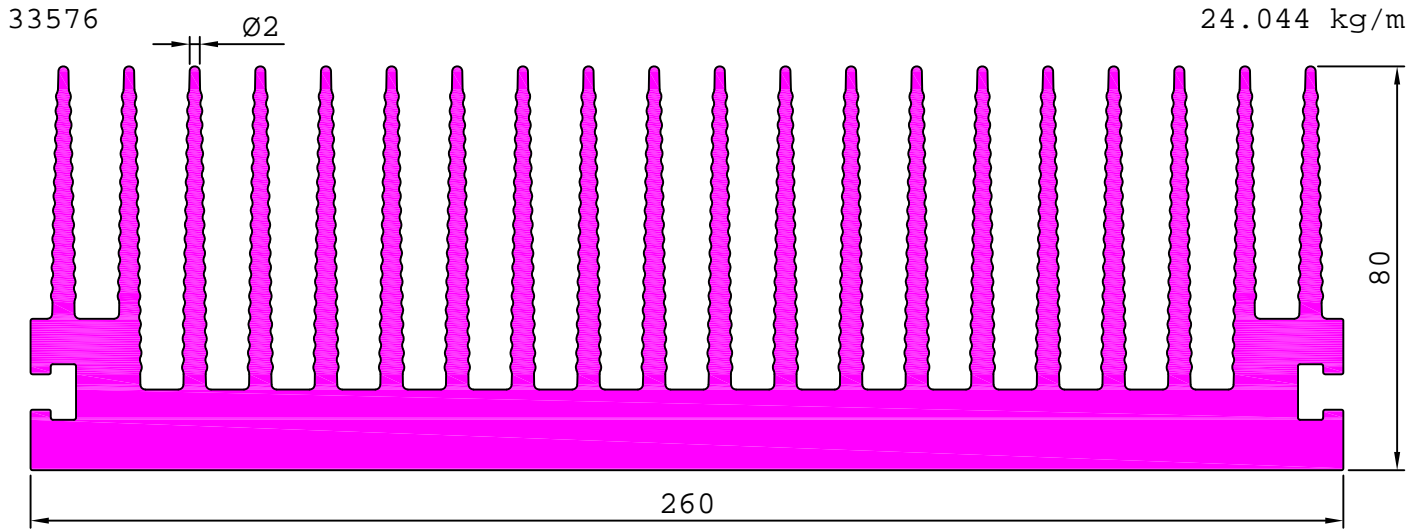

INDUSTRIAL

HEAT SINKS

33580

9.133 kg/m

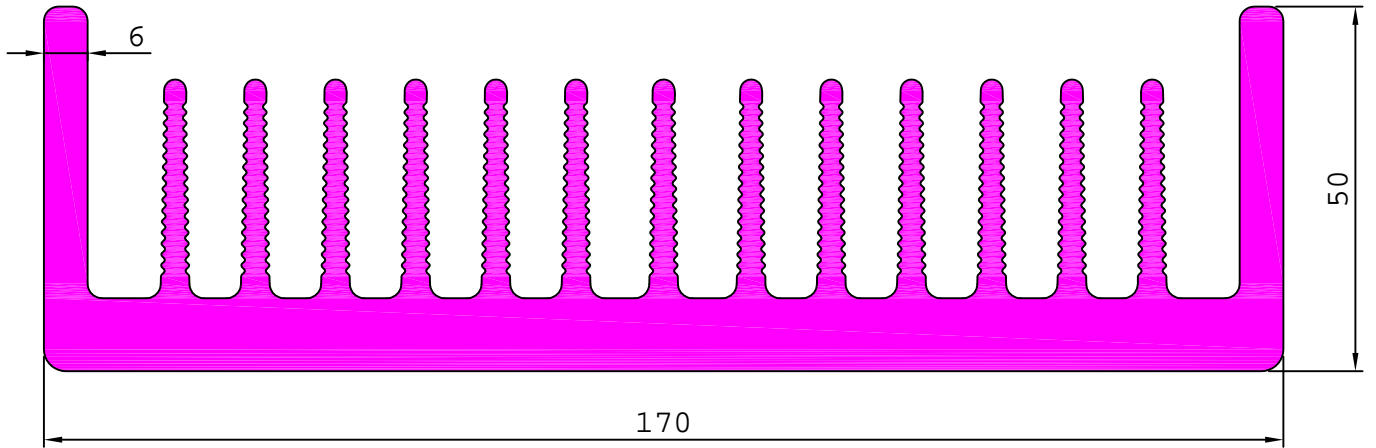

33581

1.350 kg/m

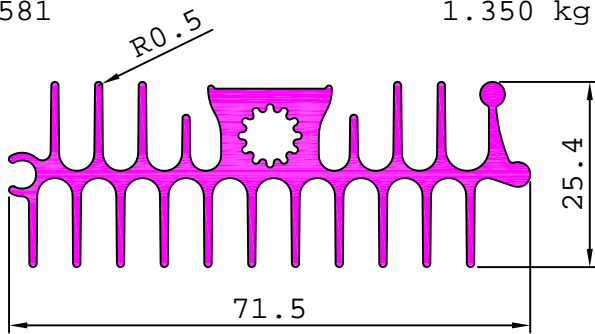

33585

1.079 kg/m

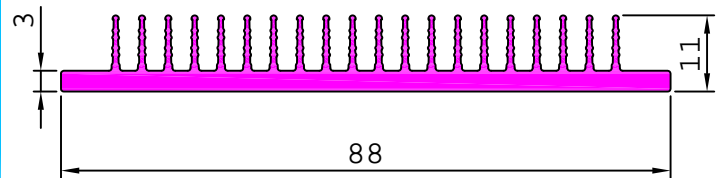

33582

15.941 kg/m

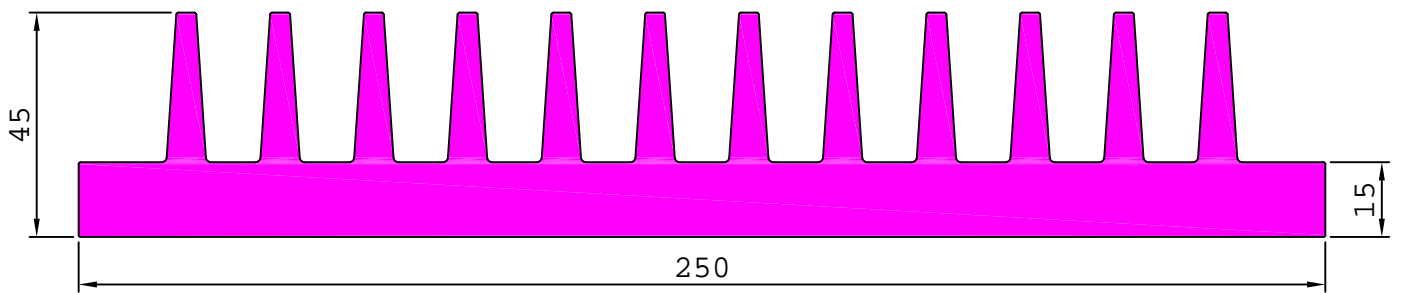

33584

2.415 kg/m

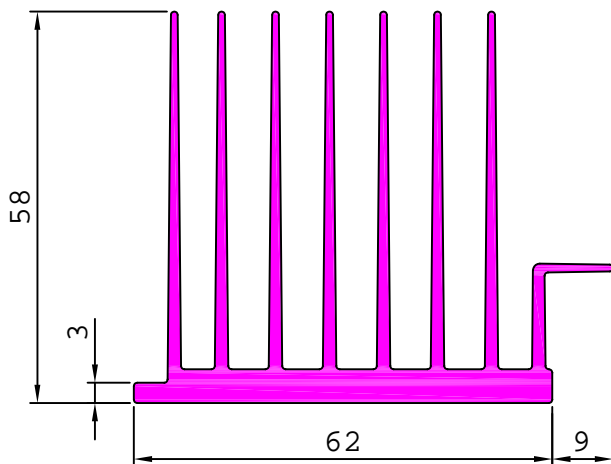

33586

0.874 kg/m

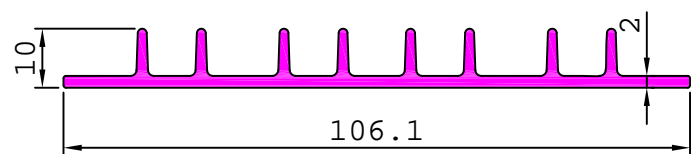

33587

0.279 kg/m

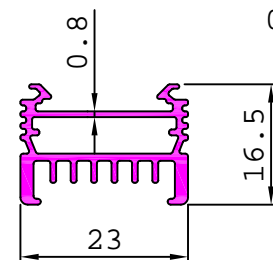

INDUSTRIAL

HEAT SINKS

S4273

1.231 kg/m

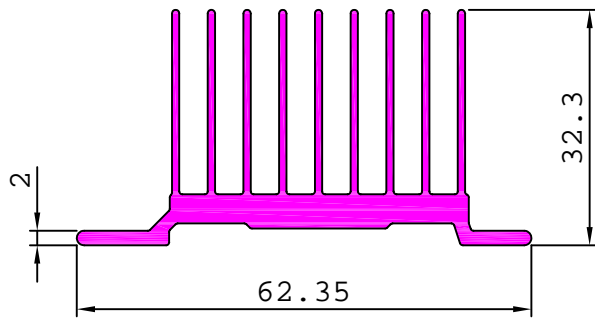

S4306

2.225 kg/m

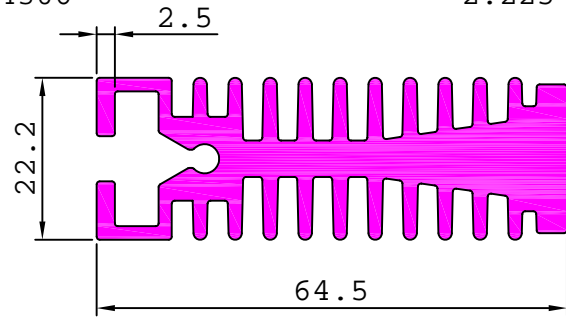

S4276

20.999 kg/m

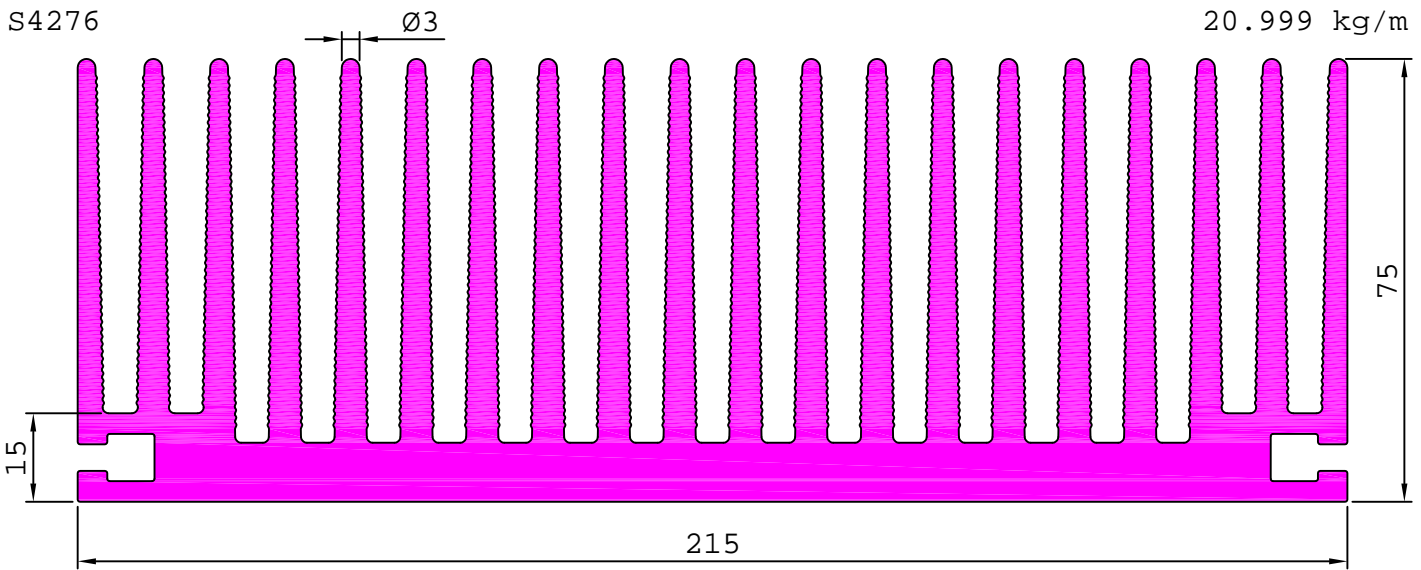

S4326

0.703 kg/m

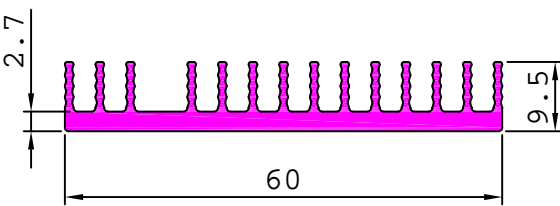

S4337

1.452 kg/m

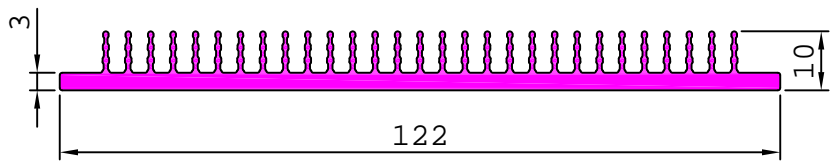

S4372

0.901 kg/m

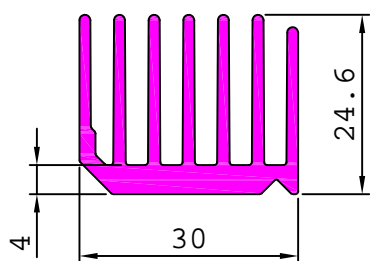

S4447

2.497 kg/m

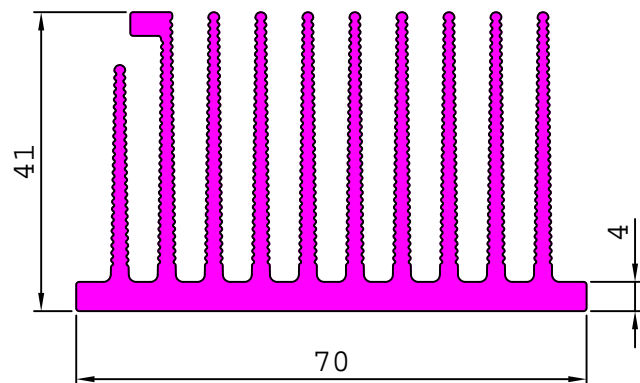

INDUSTRIAL

HEAT SINKS

S4406

13.371 kg/m

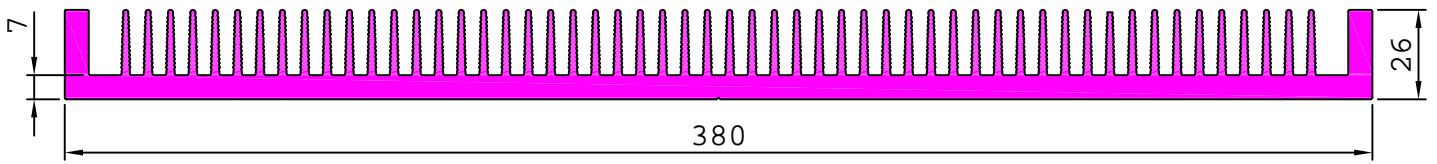

S4415

6.975 kg/m

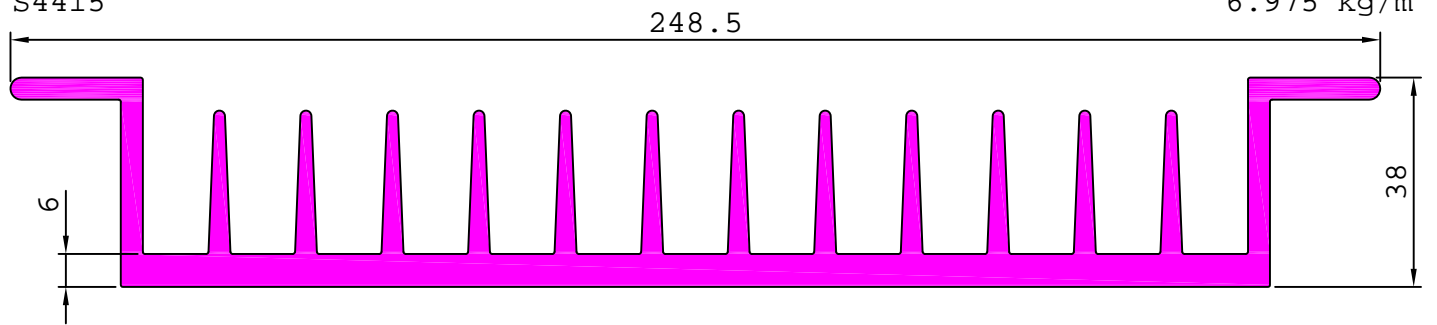

S4466

7.195 kg/m

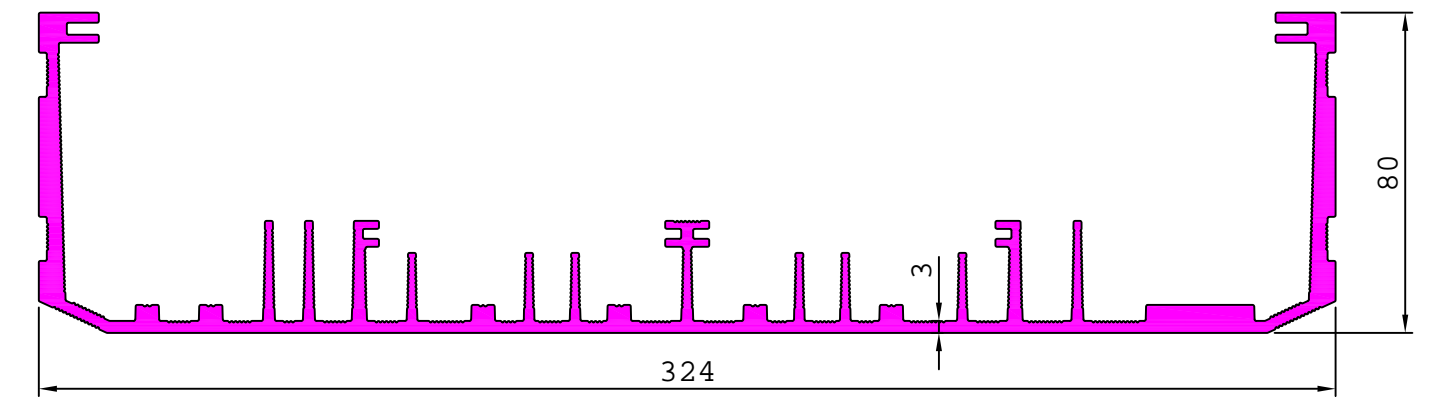

S4479

1.116 kg/m

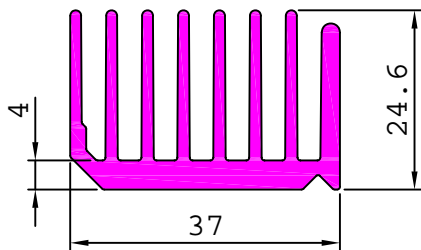

S4498

2.389 kg/m

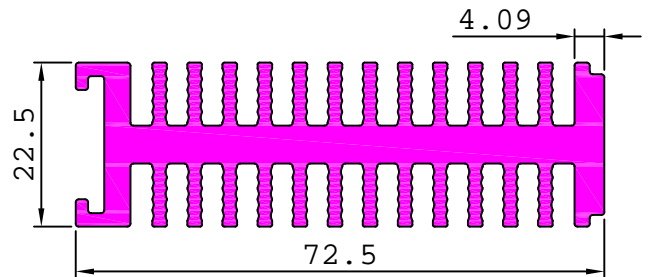

S4531

8.764 kg/m

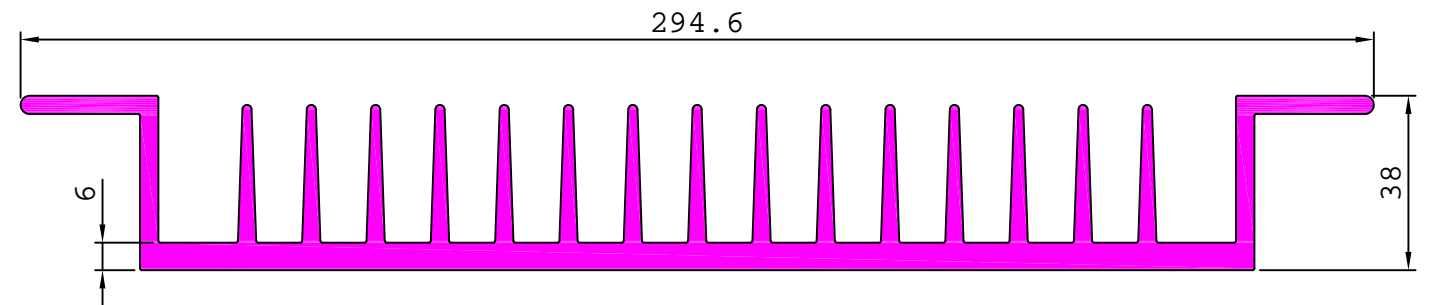

INDUSTRIAL

HEAT SINKS

S4638 3.036 kg/m

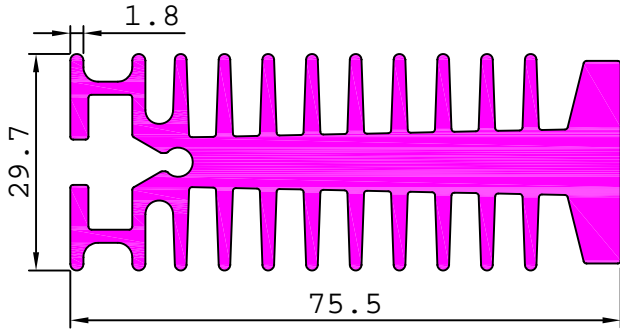

S4696 4.339 kg/m

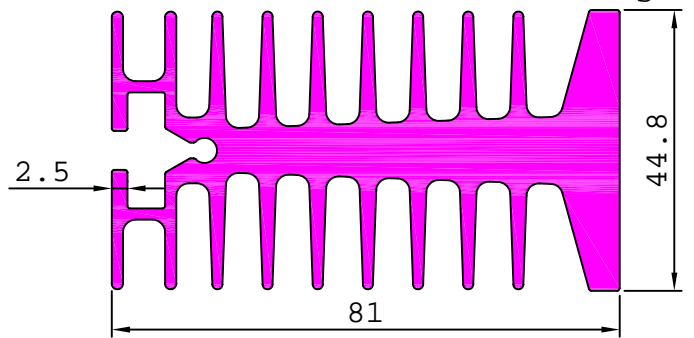

S4637 0.413 kg/m

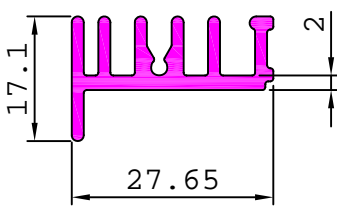

S4719 0.418 kg/m

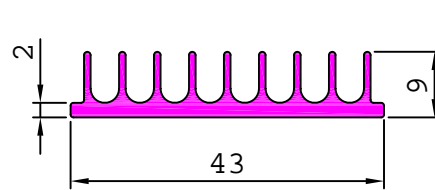

S4720 0.660 kg/m

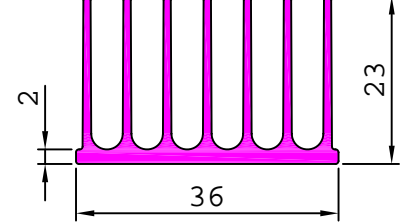

S4764 11.890 kg/m

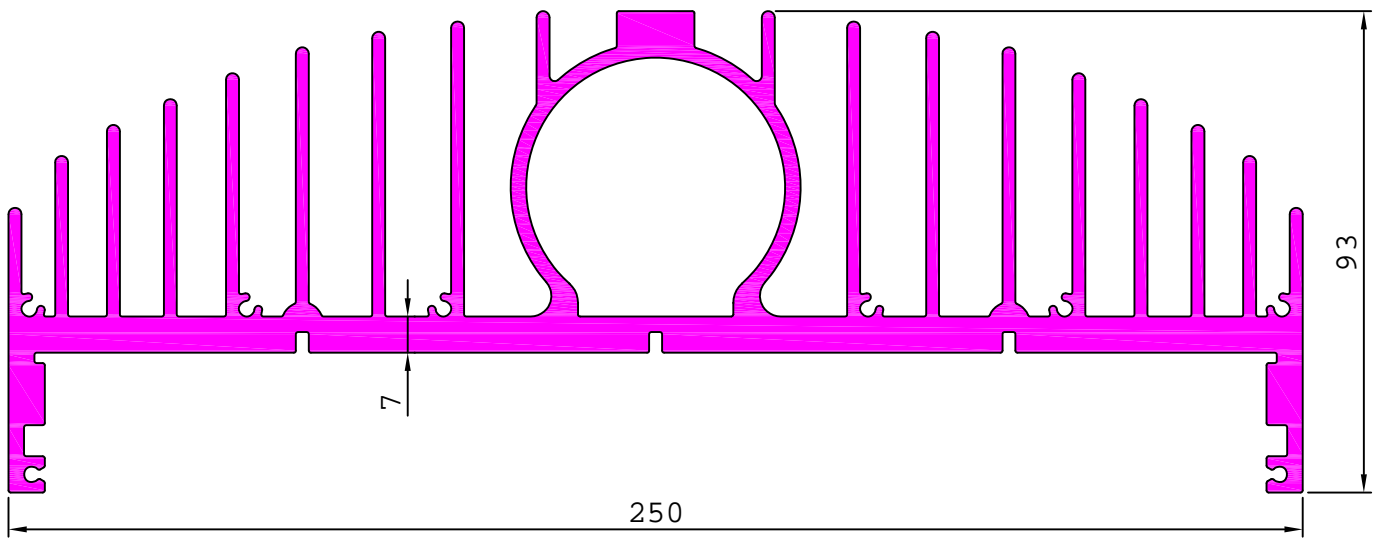

S4804 3.810 kg/m

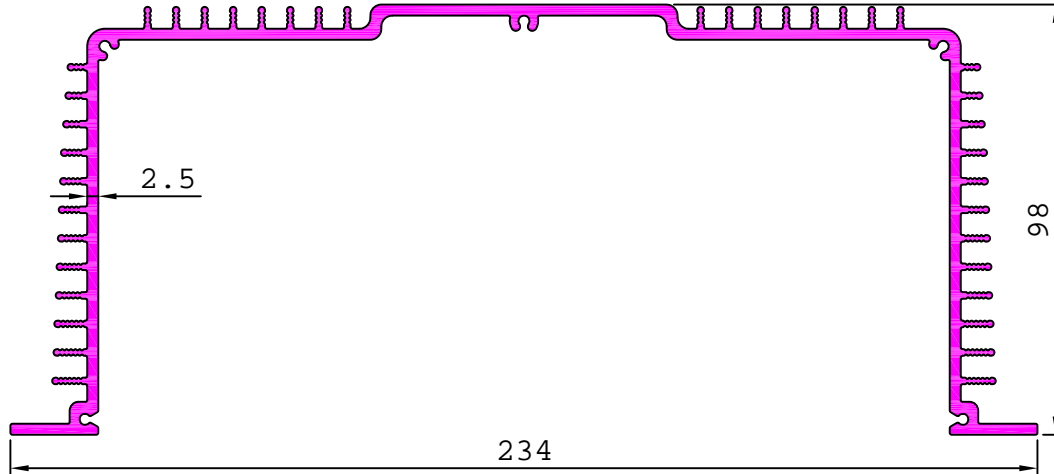

INDUSTRIAL

HEAT SINKS

S4825 3.113 kg/m

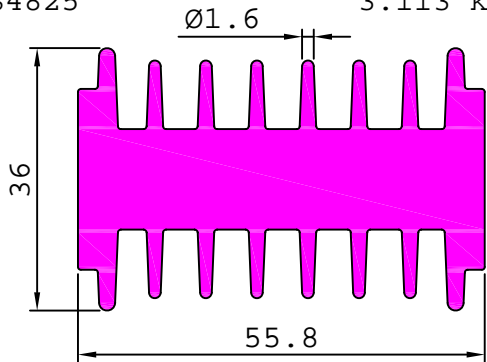

S4914 2.959 kg/m

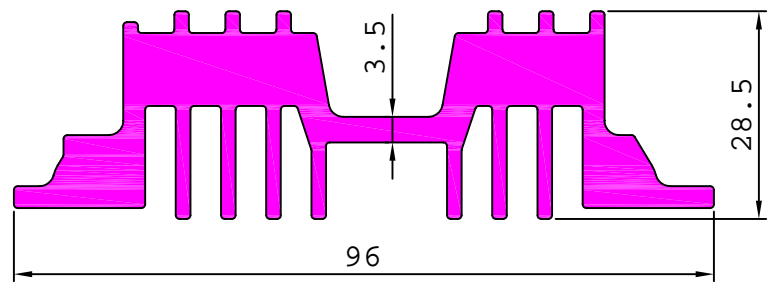

S4824 6.774 kg/m

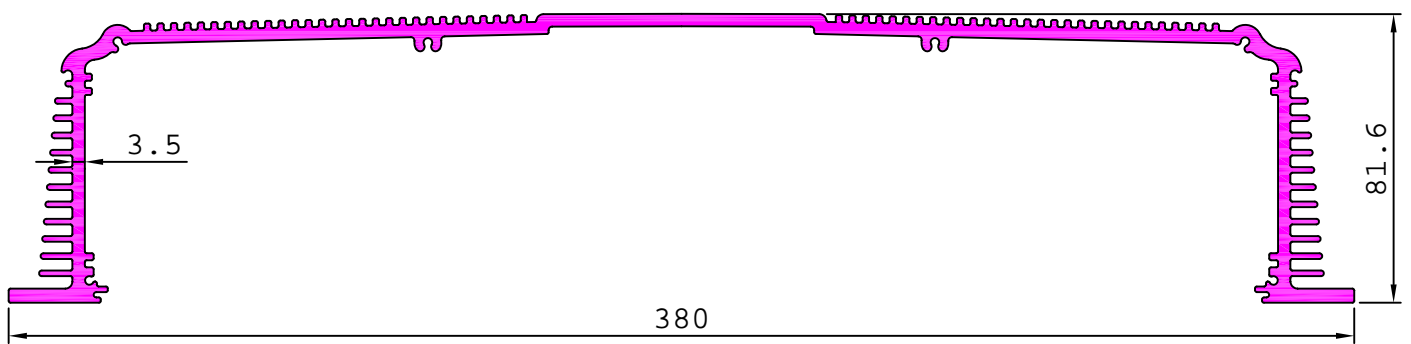

S4839 2.622 kg/m

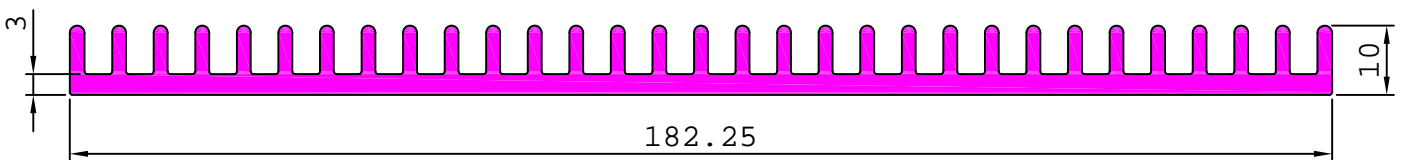

S4942 4.196 kg/m

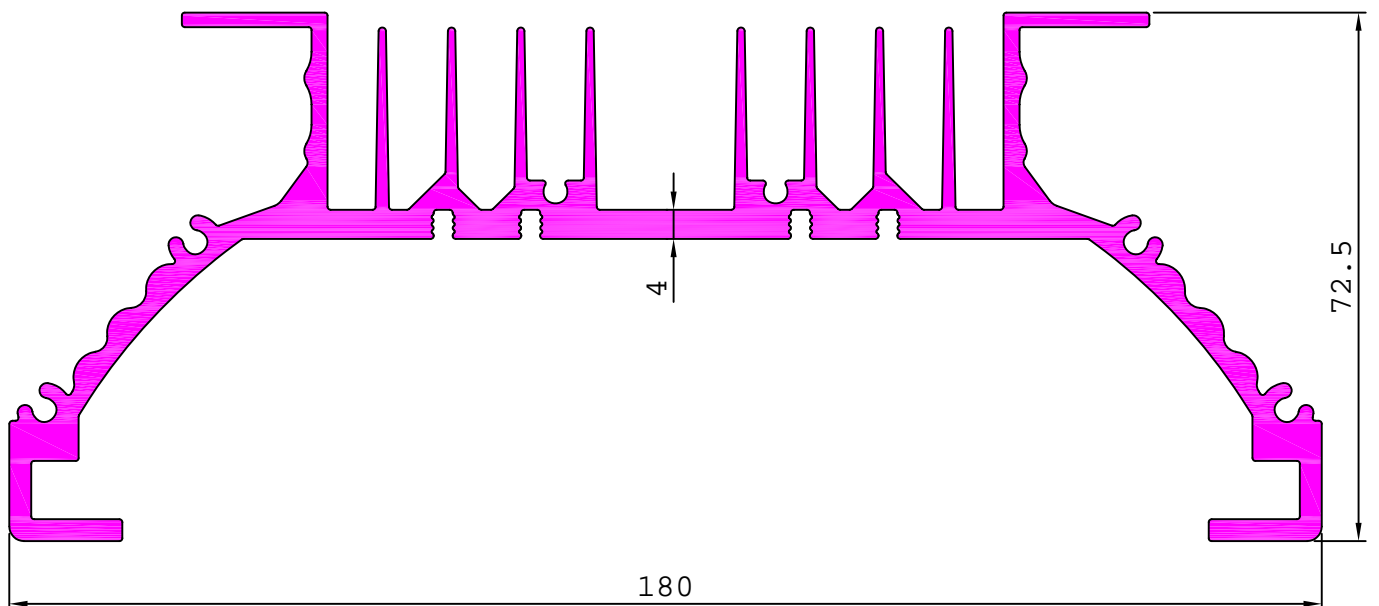

INDUSTRIAL

HEAT SINKS

S4912

9.802 kg/m

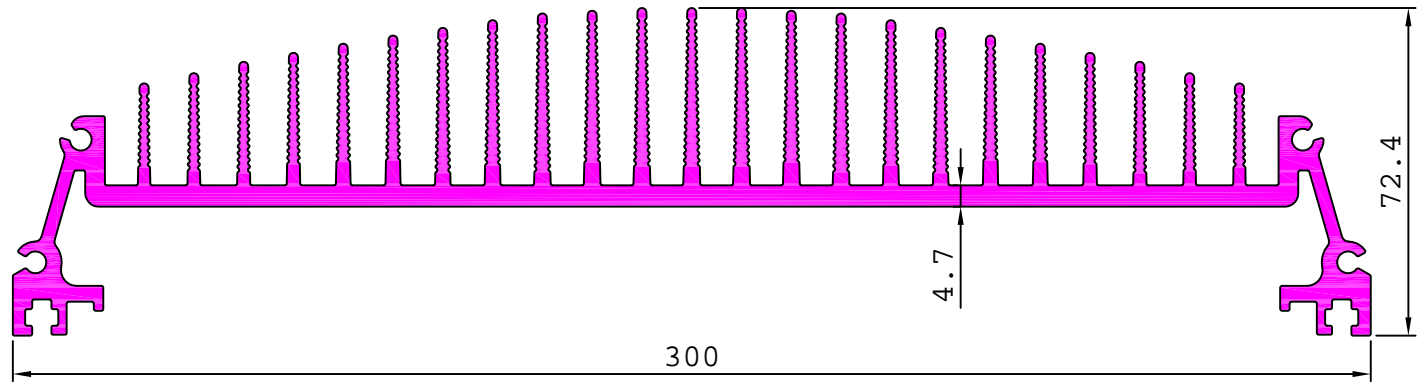

S4940

13.286 kg/m

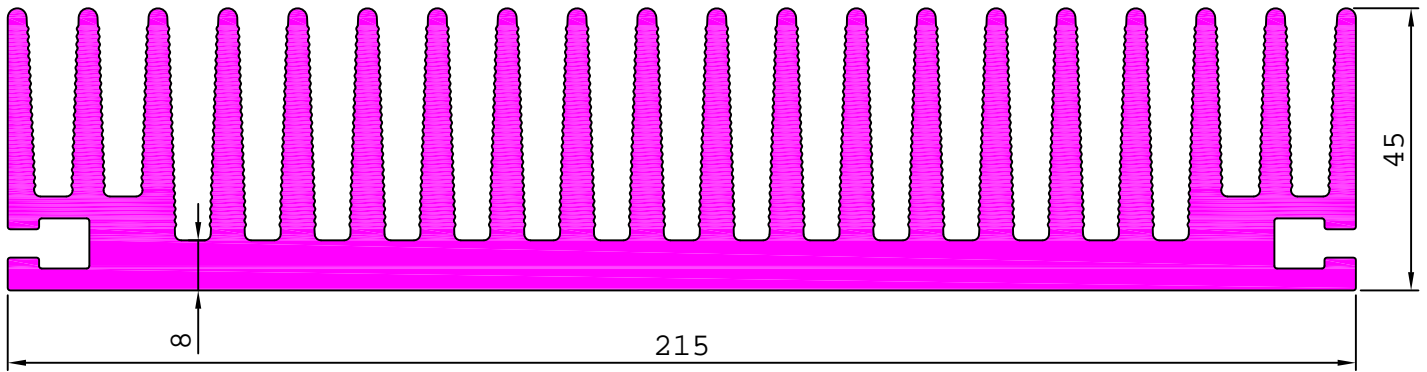

S5086

8.850 kg/m

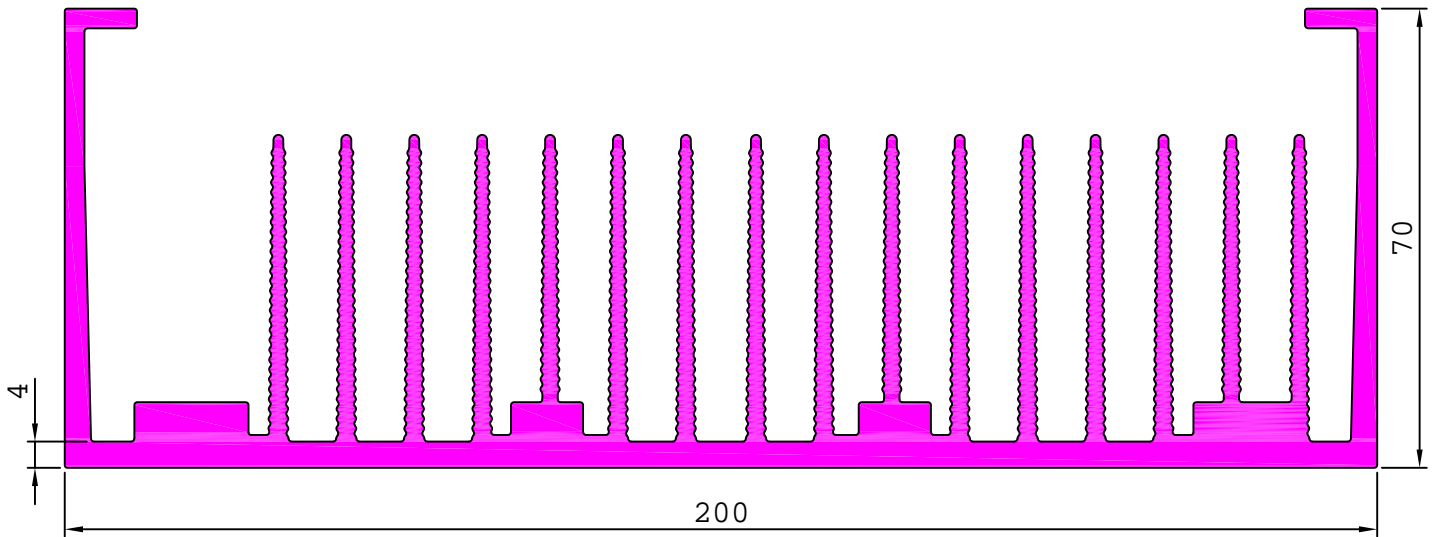

S5030

0.531 kg/m

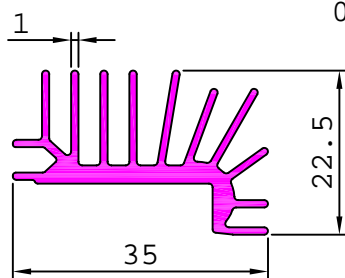

S4709

0.363 kg/m

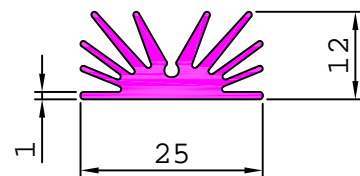

INDUSTRIAL

ROUND HEAT SINKS

26441

2.156 kg/m

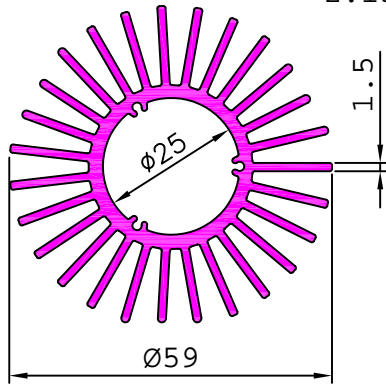

26465

6.840 kg/m

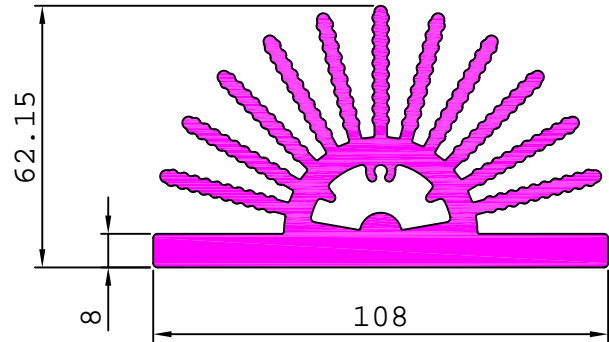

26475

2.579 kg/m

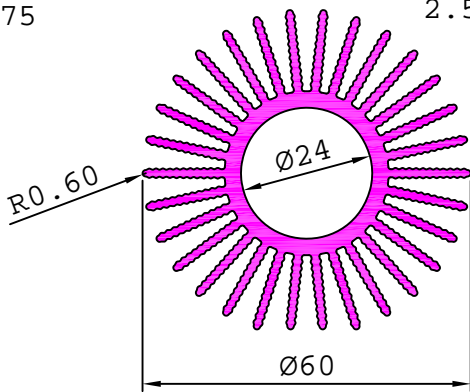

26478

1.852 kg/m

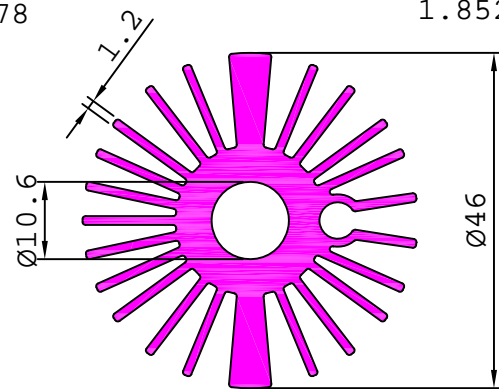

26497

0.757 kg/m

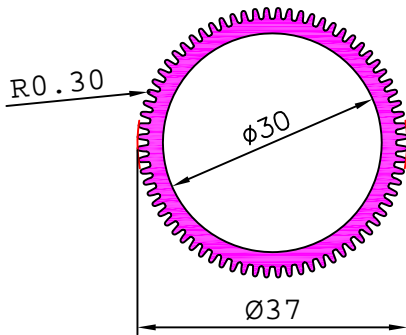

33519

2.157 kg/m

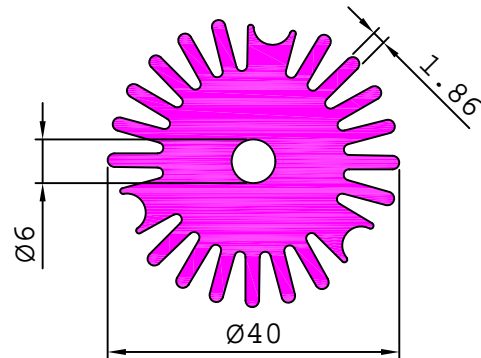

33528

2.327 kg/m

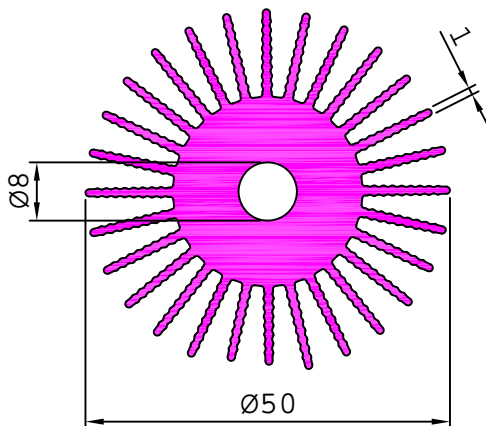

S4486

2.677 kg/m

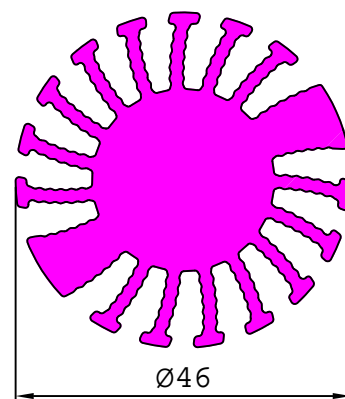

INDUSTRIAL

ROUND HEAT SINKS

26500

10.273 kg/m

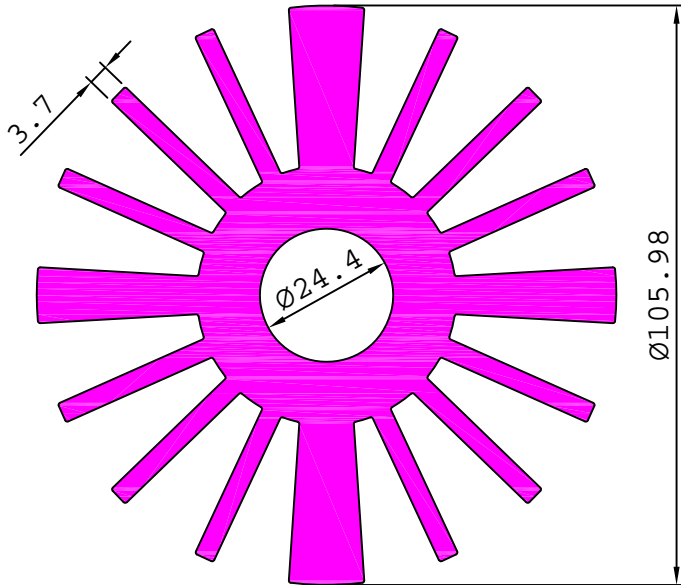

33501

9.179 kg/m

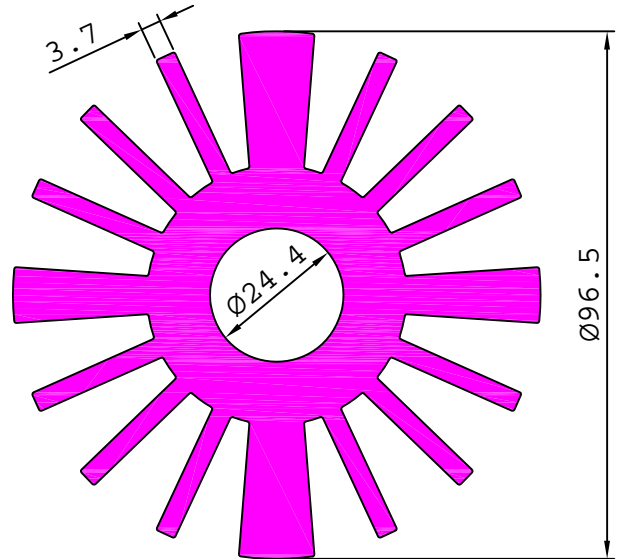

33527

20.979 kg/m

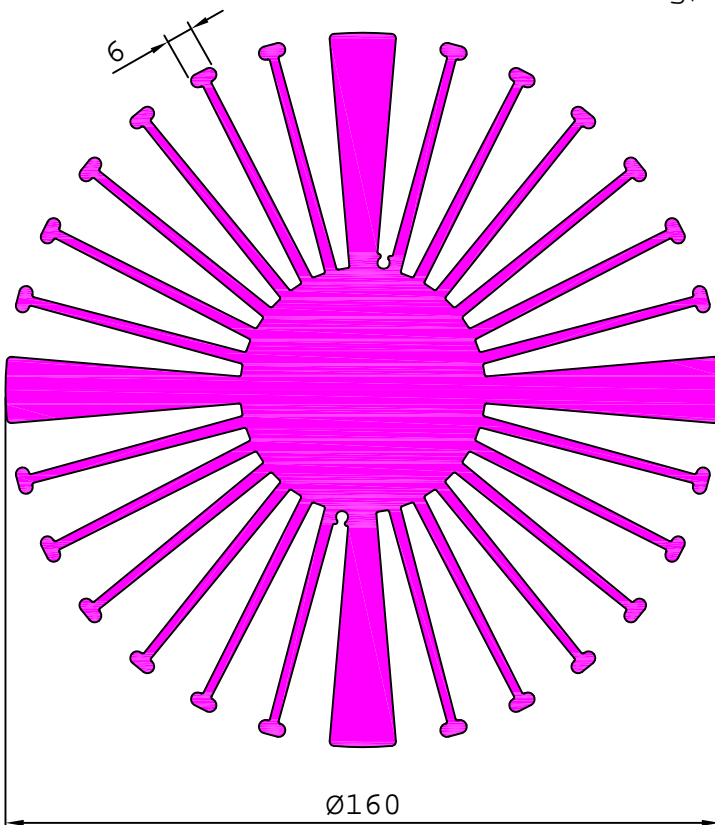

33541

11.579 kg/m

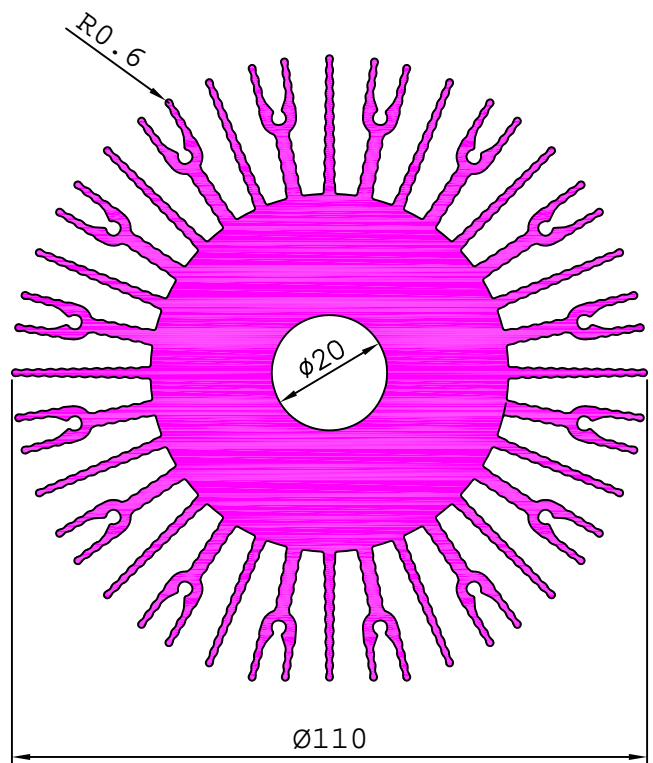

INDUSTRIAL

ROUND HEAT SINKS

33537

14.287 kg/m

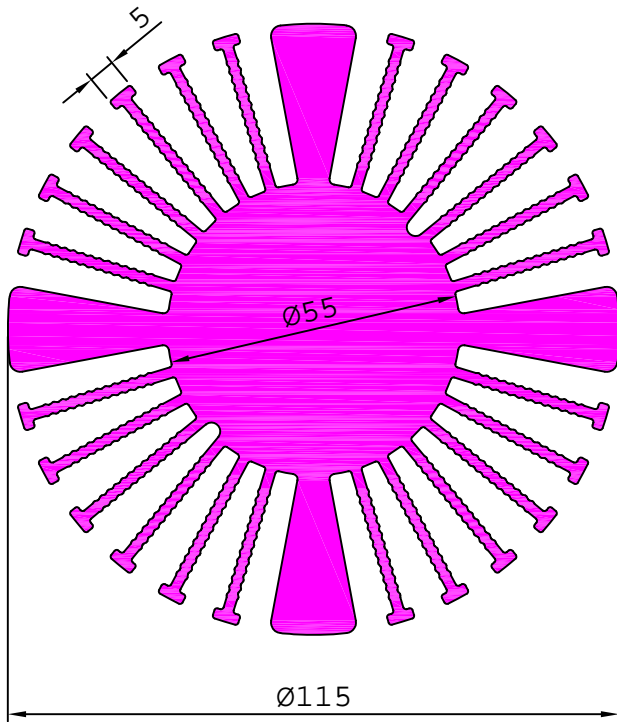

33560

17.734 kg/m

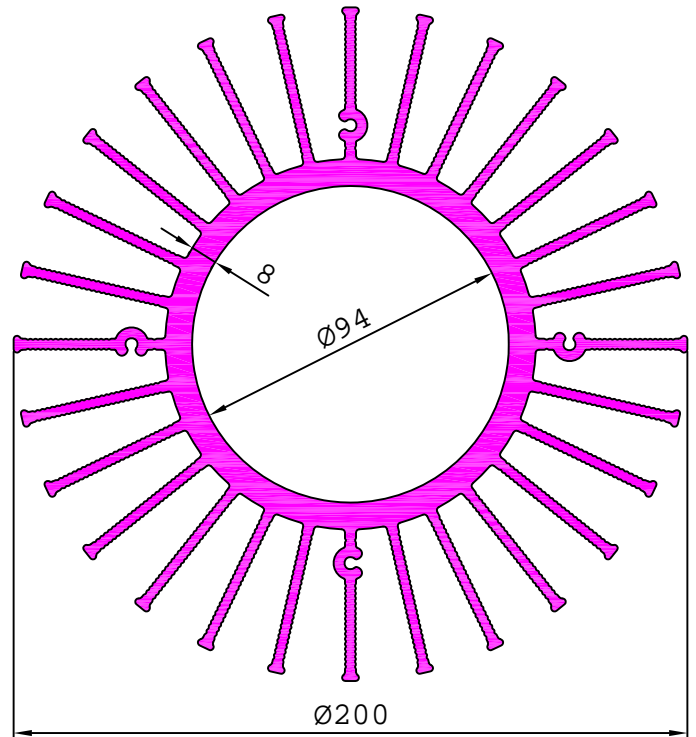

S4333

7.888 kg/m

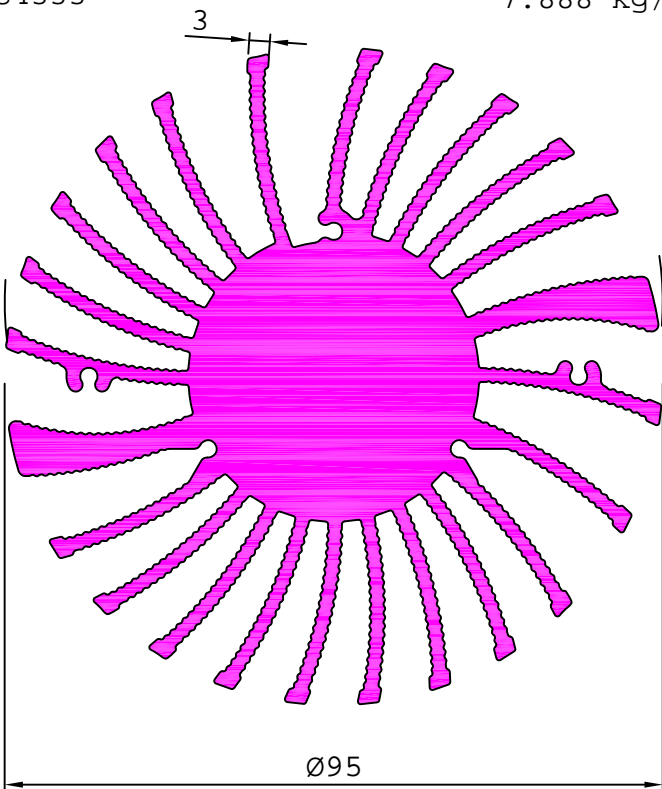

S4788

13.394 kg/m

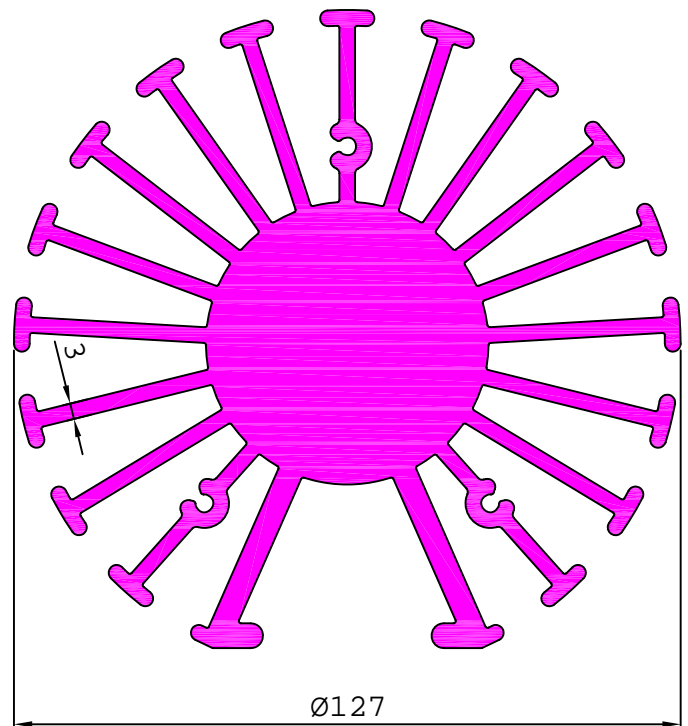

INDUSTRIAL

ROUND HEAT SINKS

S4845

11.097 kg/m

S4925

17.634 kg/m

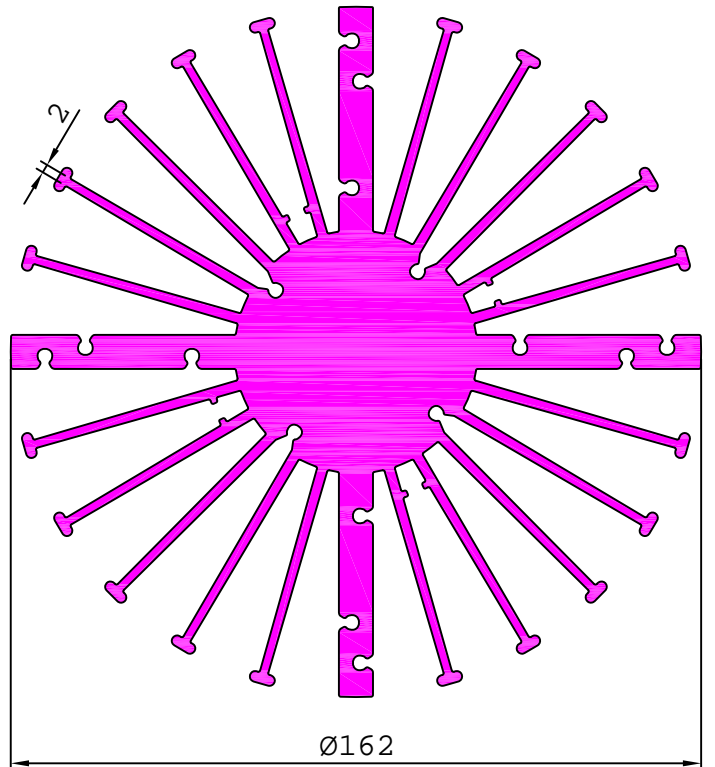
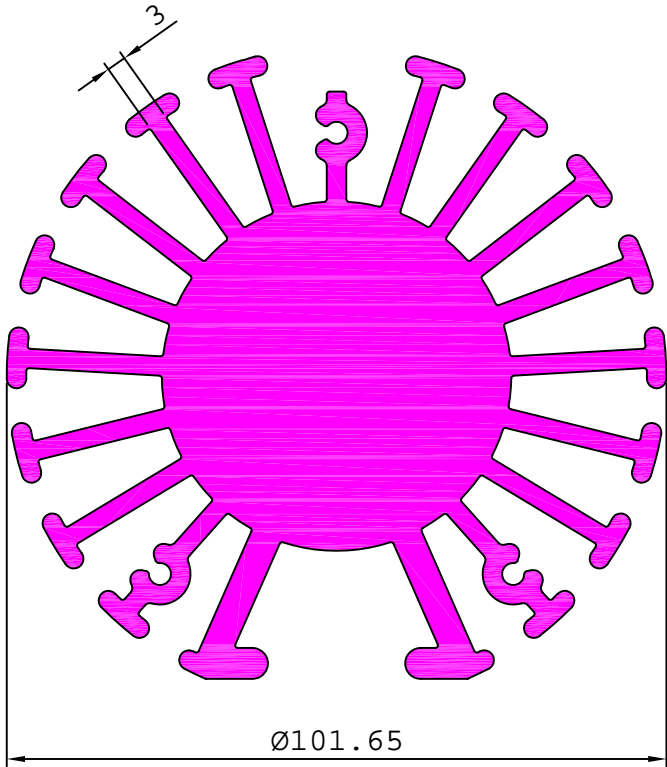

S4960

16.437 kg/m

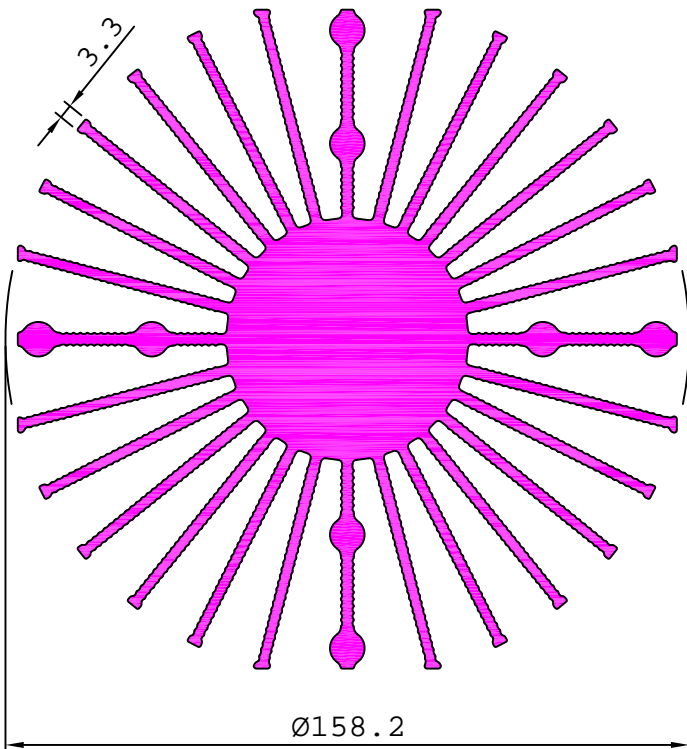

INDUSTRIAL

AIR GRILL PROFILE

26557

0.637 kg/m

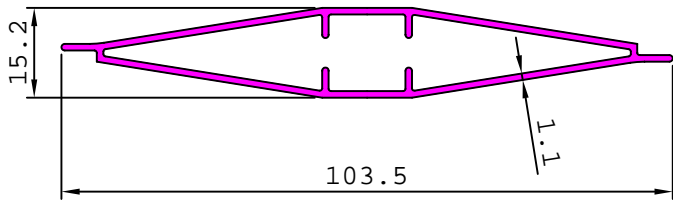

26797

0.660 kg/m

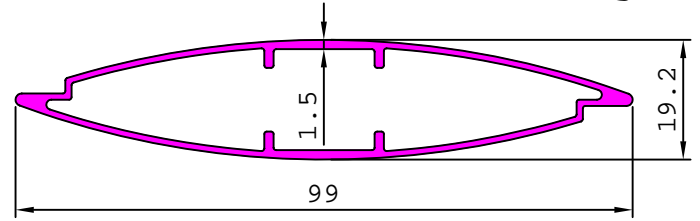

26590

1.052 kg/m

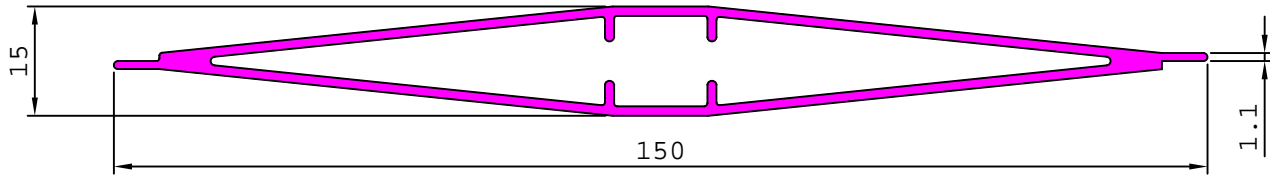

26665

1.082 kg/m

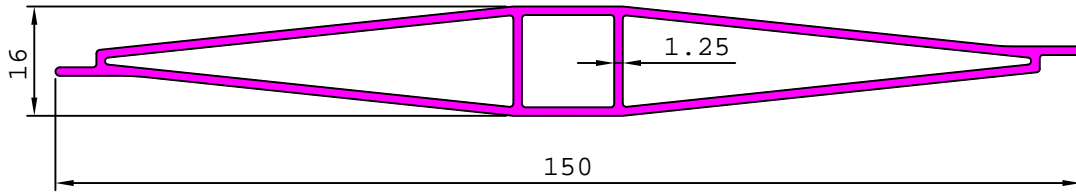

26796

0.845 kg/m

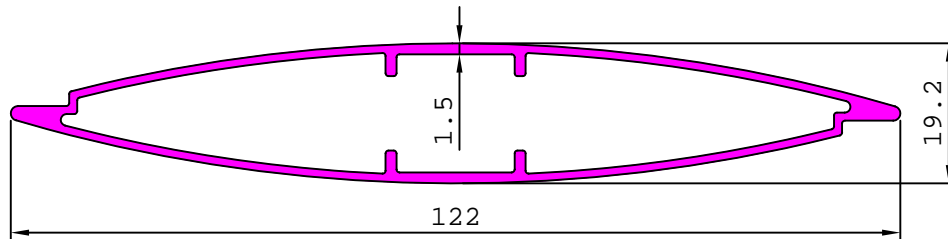

26841

1.575kg/m

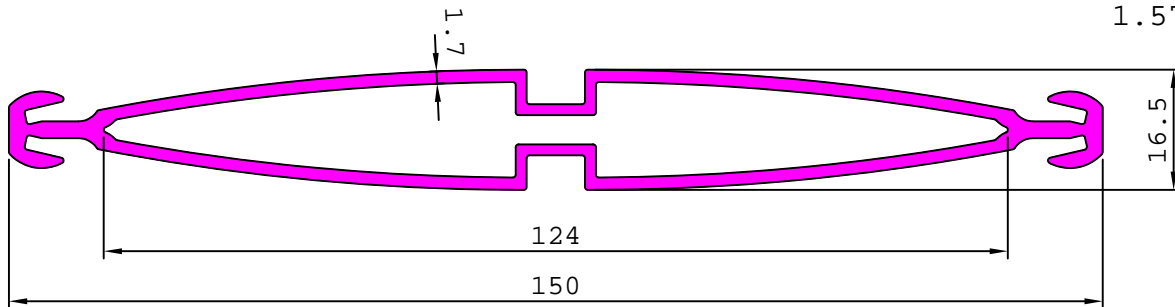

29292

1.621 kg/m

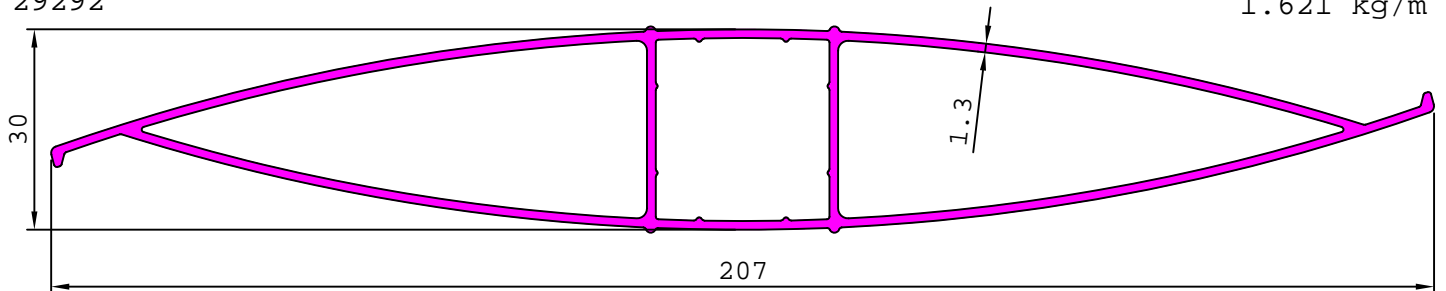

INDUSTRIAL

AIR GRILL PROFILE

26866

1.547 kg/m

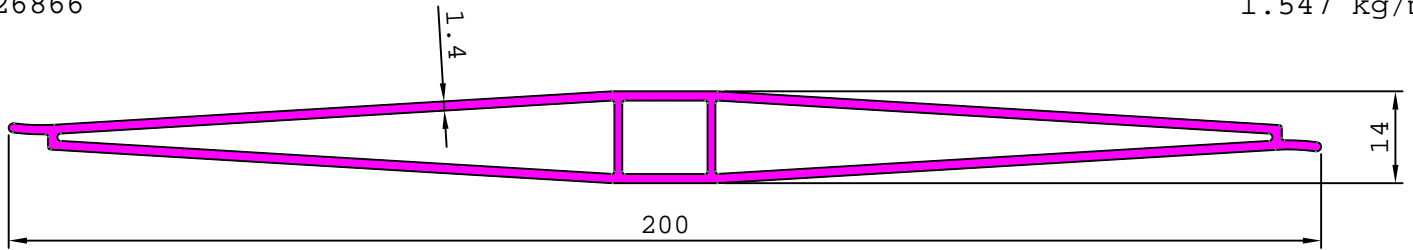

26867

1.580 kg/m

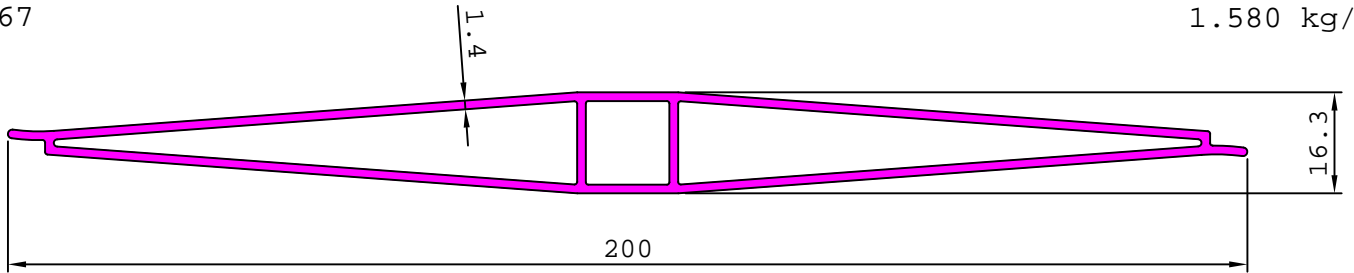

28926

1.390 kg/m

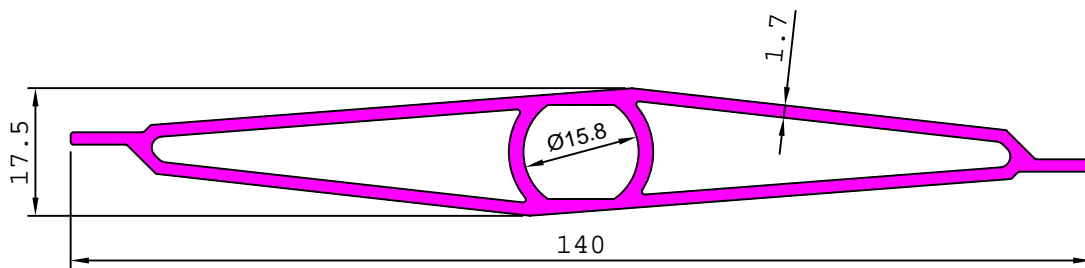

26896

0.671 kg/m

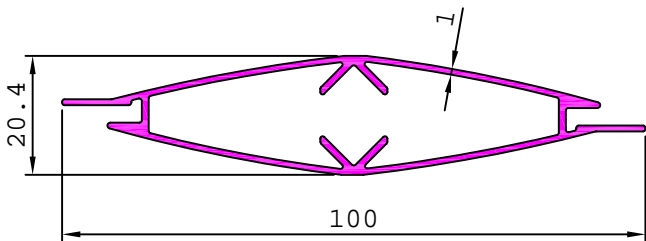

26897

0.784 kg/m

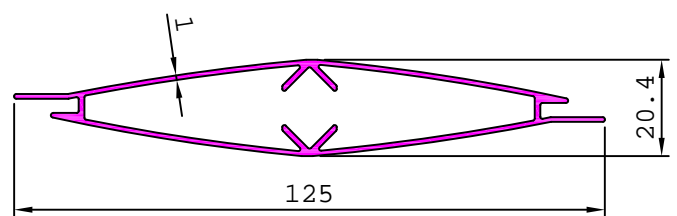

26898

1.138 kg/m

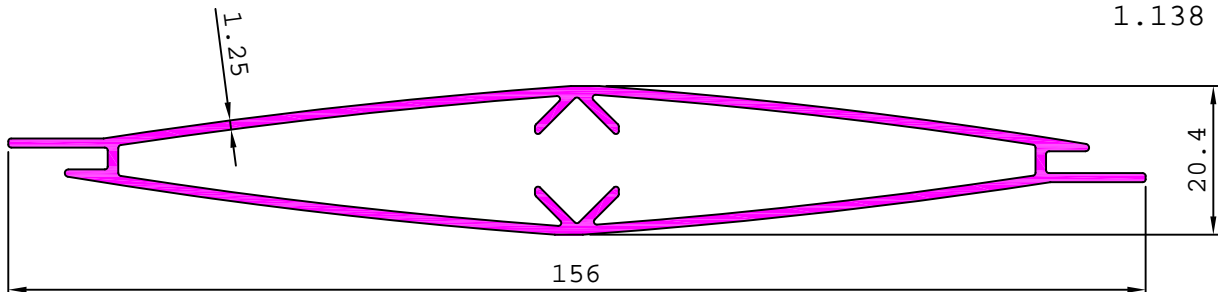

26904

0.330 kg/m

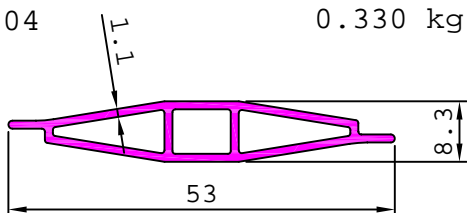

26909

0.681 kg/m

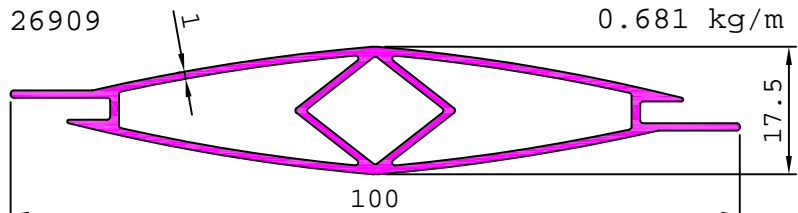

INDUSTRIAL

AIR GRILL PROFILE

26910

0.806 kg/m

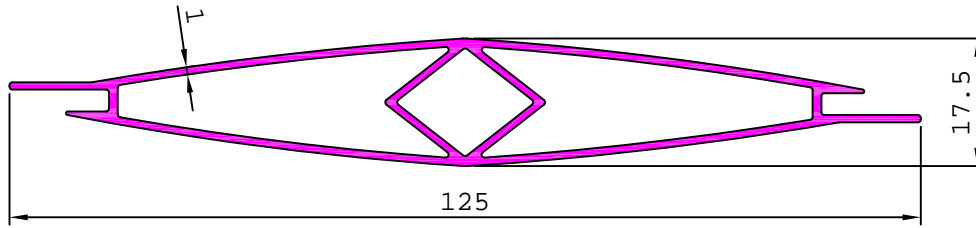

26911

1.173 kg/m

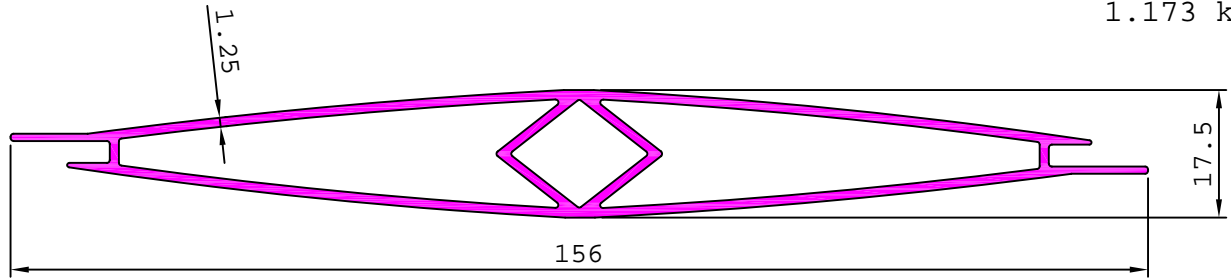

INDUSTRIAL

AIR GRILL PROFILE

26503 0.110 kg/m

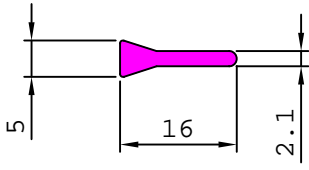

26519 0.112 kg/m

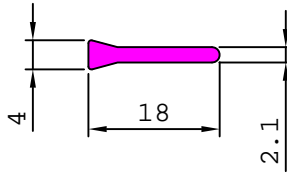

26538 0.108 kg/m

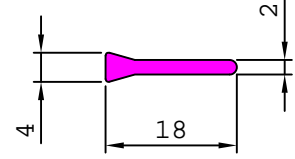

26543 0.100 kg/m

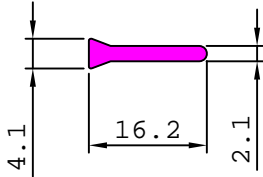

26563 0.110 kg/m

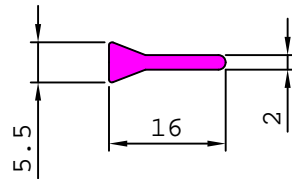

26644 0.096 kg/m

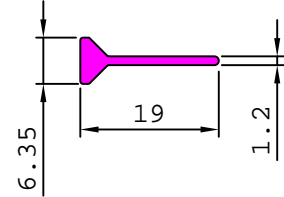

26676 0.083 kg/m

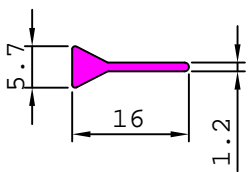

26683 0.076 kg/m

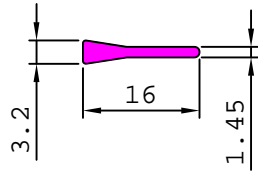

26710 0.109 kg/m

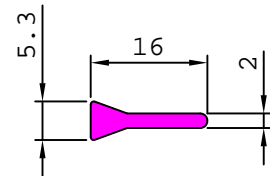

26887 0.095 kg/m

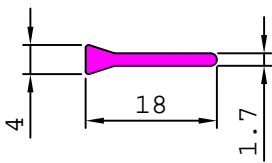

26845 0.118 kg/m

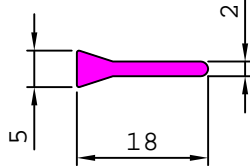

26967 0.062 kg/m

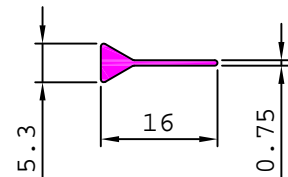

INDUSTRIAL

AIR GRILL PROFILE

26544 0.122 kg/m

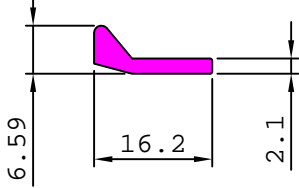

26548 0.126 kg/m

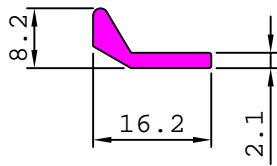

26564 0.112 kg/m

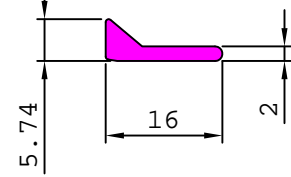

26611 0.103 kg/m

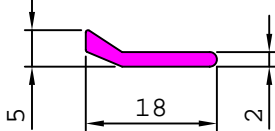

26652 0.111 kg/m

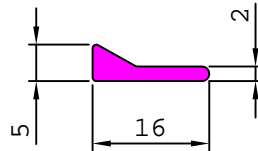

26677 0.097 kg/m

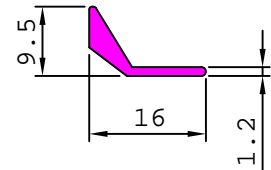

26678 0.093 kg/m

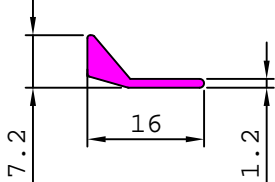

26679 0.079 kg/m

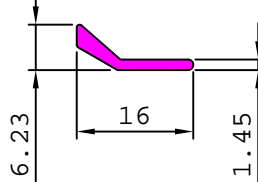

26682 0.075 kg/m

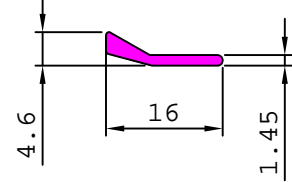

26722 0.101 kg/m

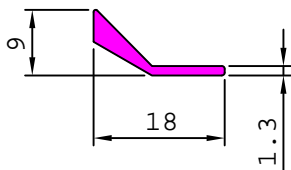

26728 0.120 kg/m

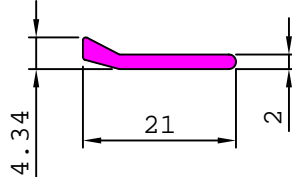

26835 0.074 kg/m

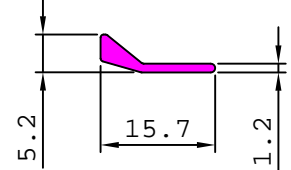

26836 0.077 kg/m

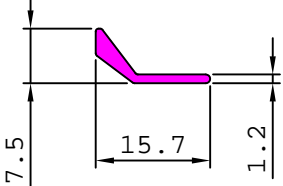

26846 0.112 kg/m

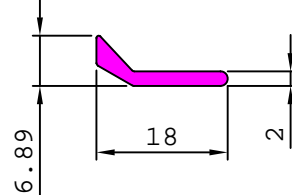

26895 0.070 kg/m

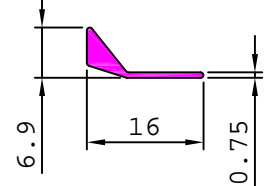

26968 0.080 kg/m

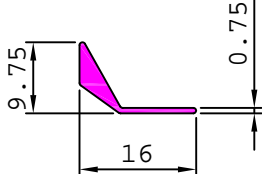

27454 0.119 kg/m

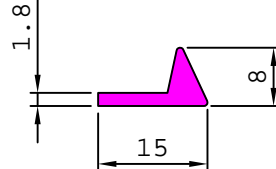

INDUSTRIAL

AIR GRILL PROFILE

26507 0.088 kg/m

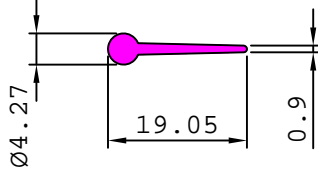

26524 0.081 kg/m

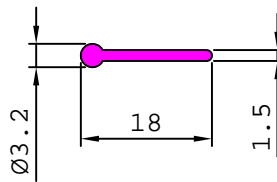

26565 0.075 kg/m

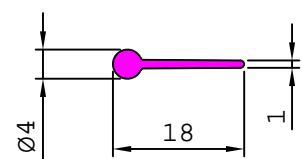

26610 0.078 kg/m

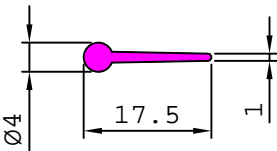

26620 0.081 kg/m

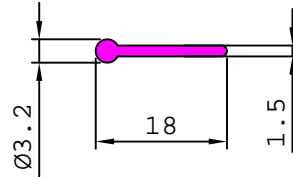

26632 0.081 kg/m

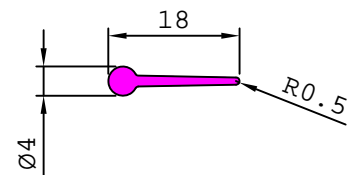

26872 0.055 kg/m

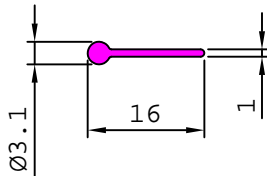

26899 0.062 kg/m

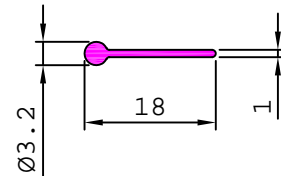

INDUSTRIAL

AIR GRILL PROFILE

26537 0.114 kg/m

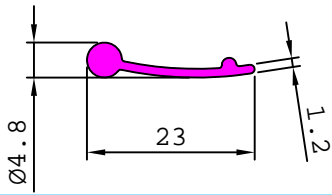

26561 0.102 kg/m

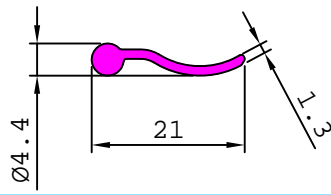

26577 0.100 kg/m

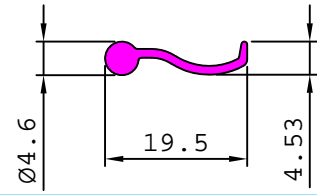

26588 0.099 kg/m

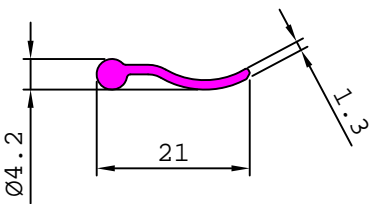

26669 0.114 kg/m

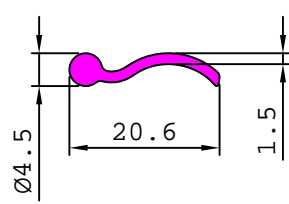

26742 0.112 kg/m

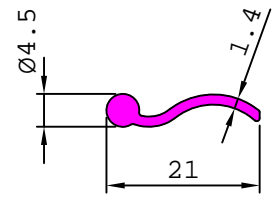

26758 0.115 kg/m

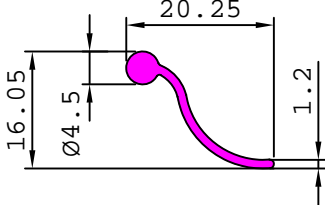

26865 0.071 kg/m

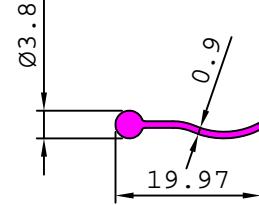

26889 0.106 kg/m

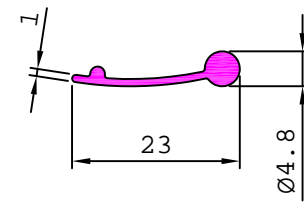

26907 0.088 kg/m

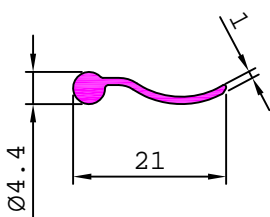

26908 0.106 kg/m

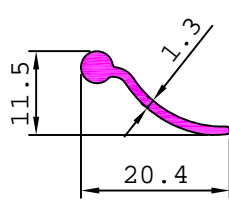

INDUSTRIAL

AIR GRILL PROFILE

26525 0.150 kg/m

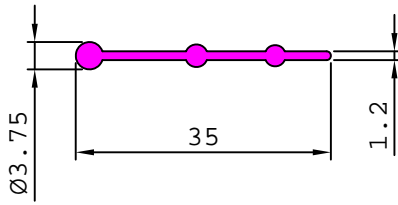

26555 0.143 kg/m

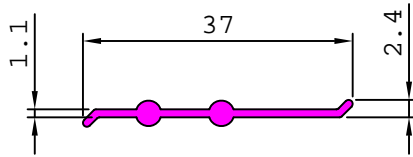

26568 0.141 kg/m

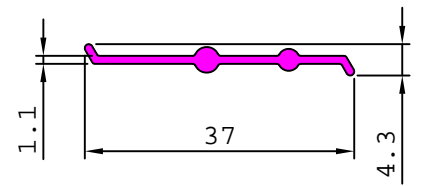

26606 0.187 kg/m

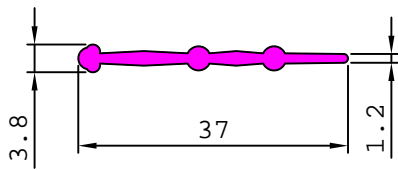

26580 0.097 kg/m

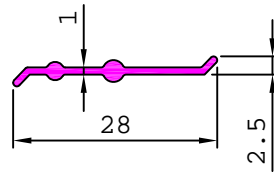

26633 0.109 kg/m

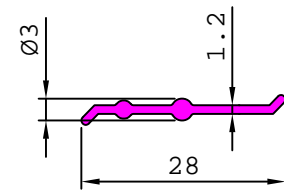

26690 0.082 kg/m

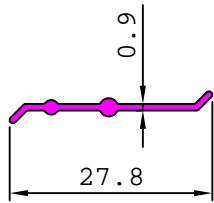

26732 0.147 kg/m

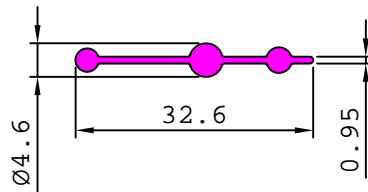

26734 0.165 kg/m

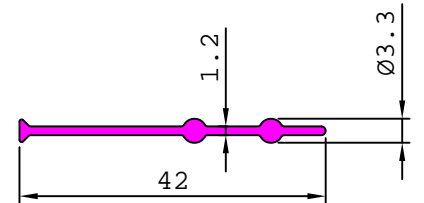

26802 0.097 kg/m

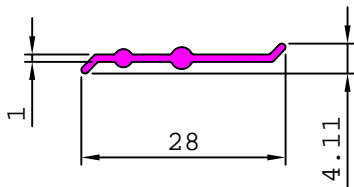

26830 0.138 kg/m

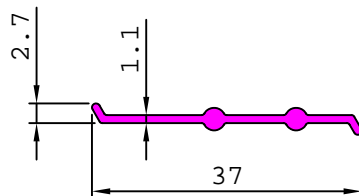

INDUSTRIAL

AIR GRILL PROFILE

13255 0.059 kg/m

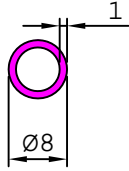

15675 0.167 kg/m

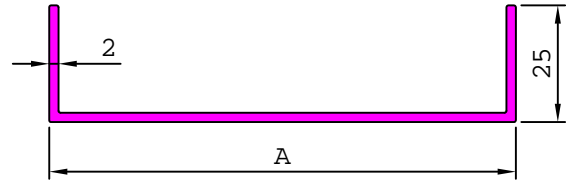
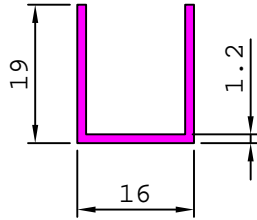

SL. No.	Section No.	A	Weight kg/m
1	15680	100.00	0.788
2	15703	110.00	0.842

15681 0.154 kg/m

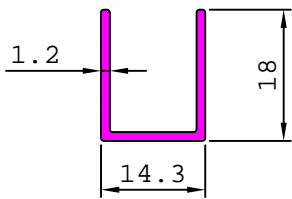

15685 0.142 kg/m

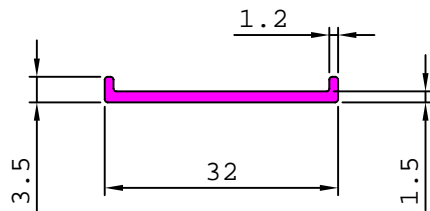

16747 0.335 kg/m

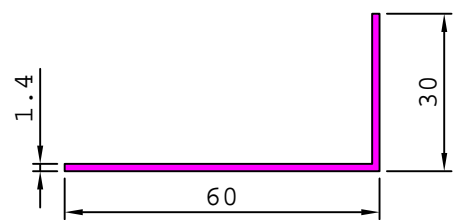

17604 0.204 kg/m

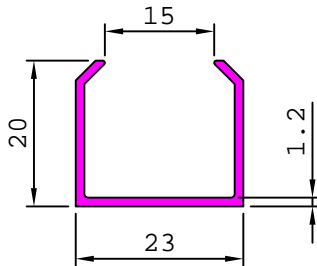

26515 0.369 kg/m

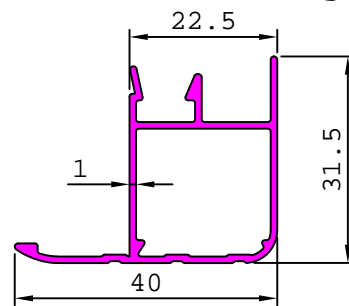

26526 0.220 kg/m

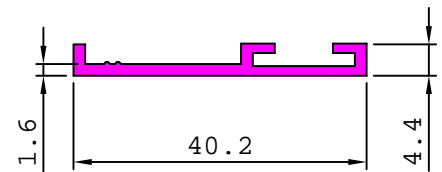

26520 0.444 kg/m

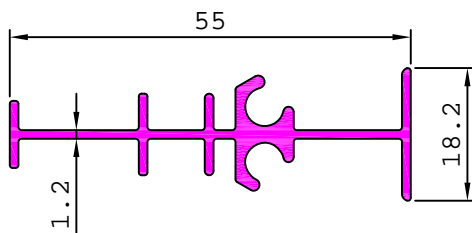

26521 0.439 kg/m

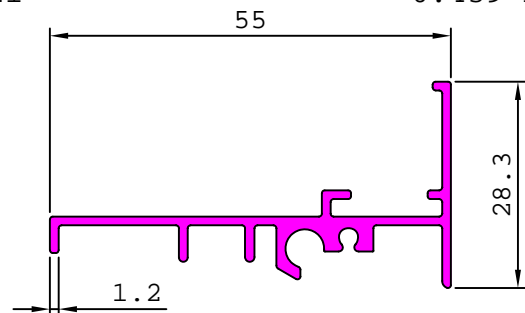

26527 0.181 kg/m

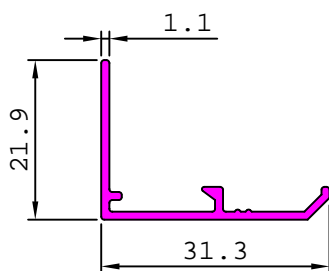

26529 0.139 kg/m

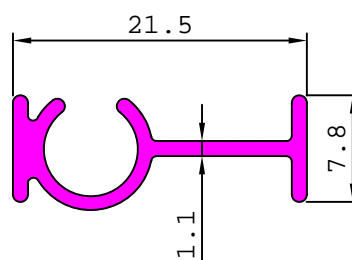

26528 0.358 kg/m

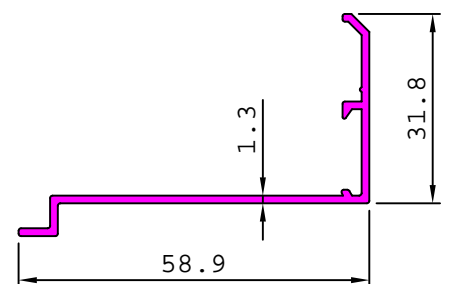

INDUSTRIAL

AIR GRILL PROFILE

26530

0.275 kg/m

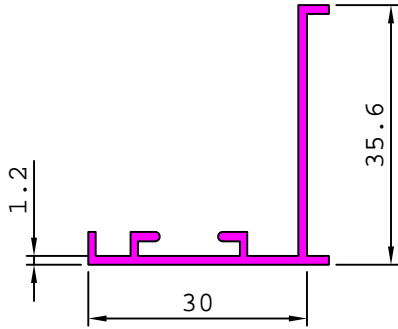

26534

0.286 kg/m

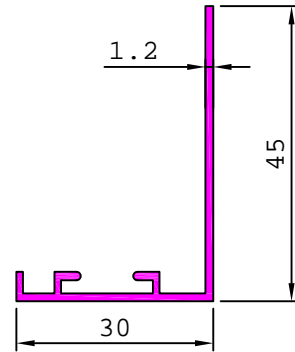

26532

0.488 kg/m

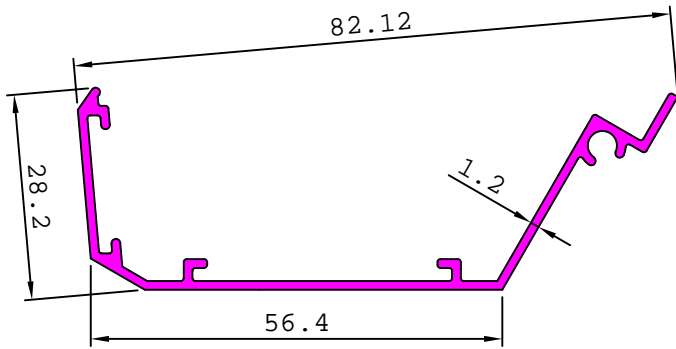

26535

0.228 kg/m

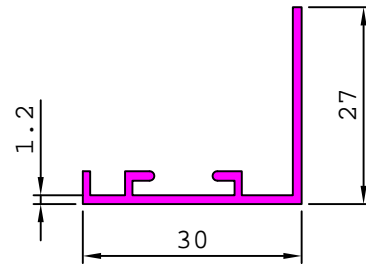

26536

0.408 kg/m

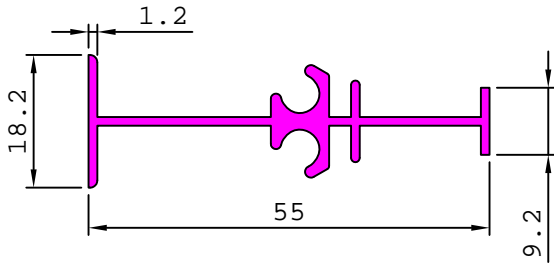

26540

0.417 kg/m

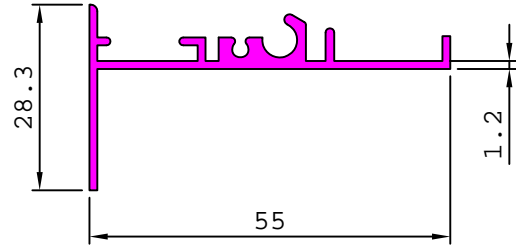

26541

0.263 kg/m

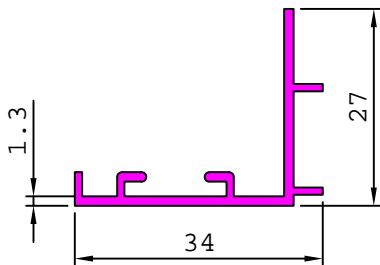

26542

0.122 kg/m

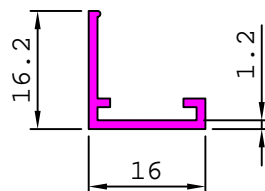

26547

0.172 kg/m

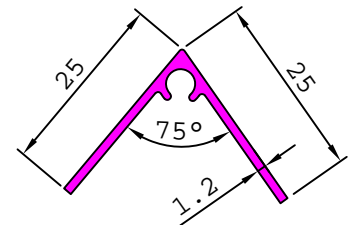

26552

0.418 kg/m

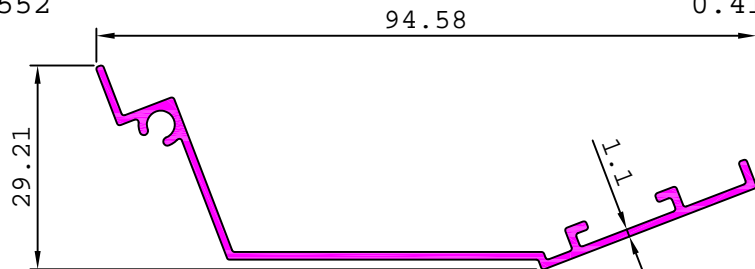

26553

0.227 kg/m

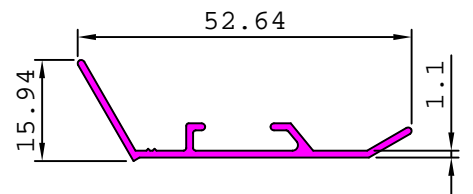

INDUSTRIAL

AIR GRILL PROFILE

26554 0.226 kg/m

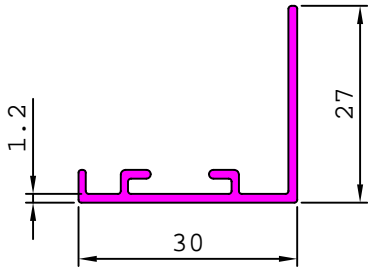

26558 0.177 kg/m

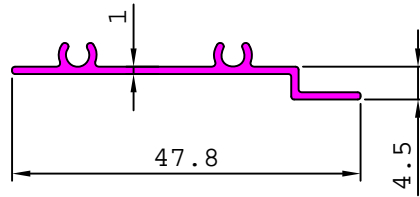

26559 0.151 kg/m

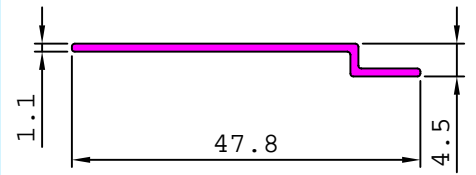

26556 0.454 kg/m

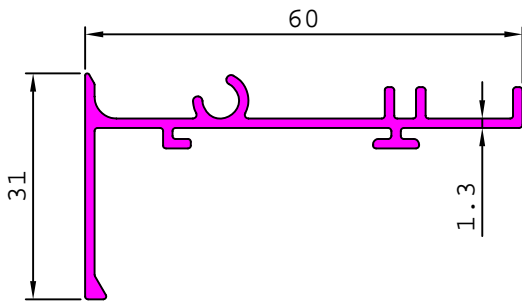

26567 0.427 kg/m

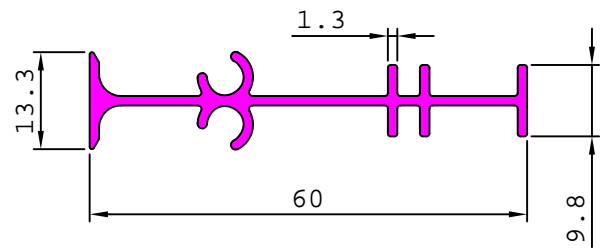

26560 0.781 kg/m

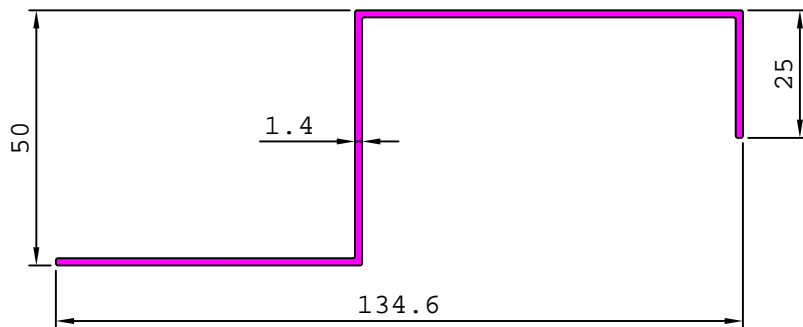

26569 0.384 kg/m

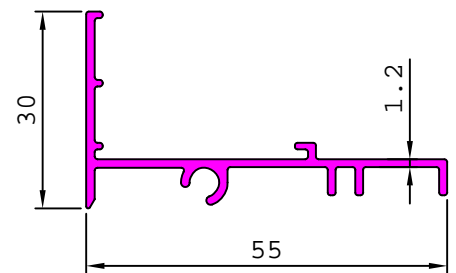

26570 0.398 kg/m

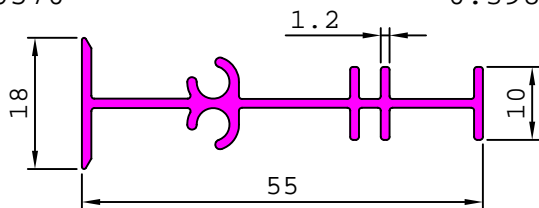

26579 0.345 kg/m

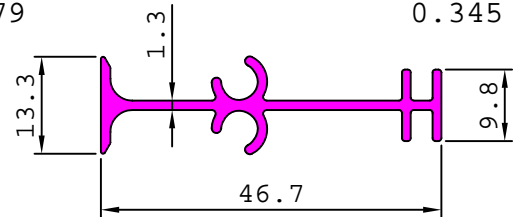

26573 1.000 kg/m

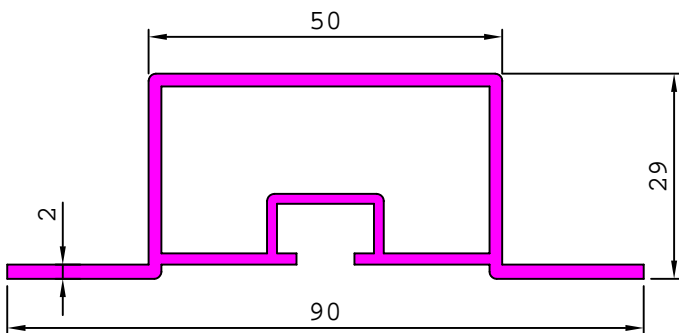

26574 1.549 kg/m

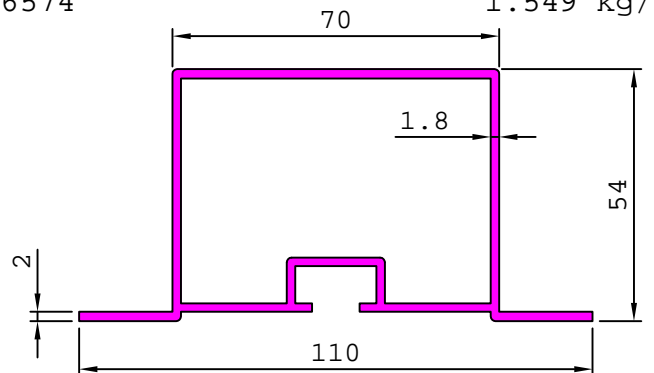

INDUSTRIAL

AIR GRILL PROFILE

26571 1.125 kg/m

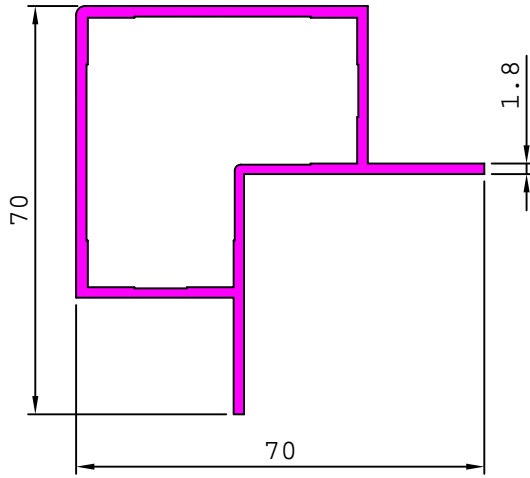

26572 1.555 kg/m

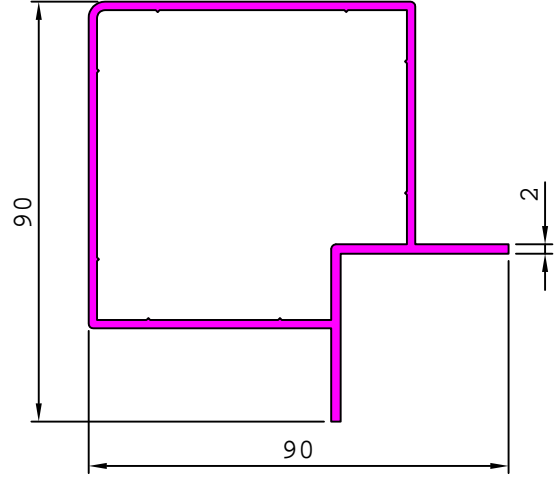

26576 0.072 kg/m

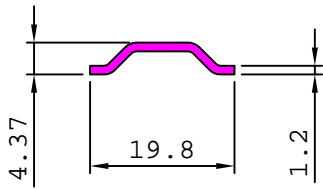

26583 0.310 kg/m

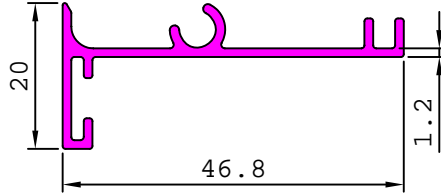

26584 0.125 kg/m

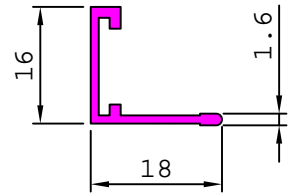

26581 0.425 kg/m

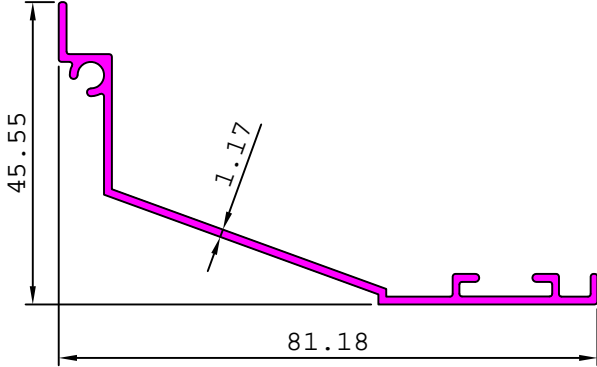

26582 0.794 kg/m

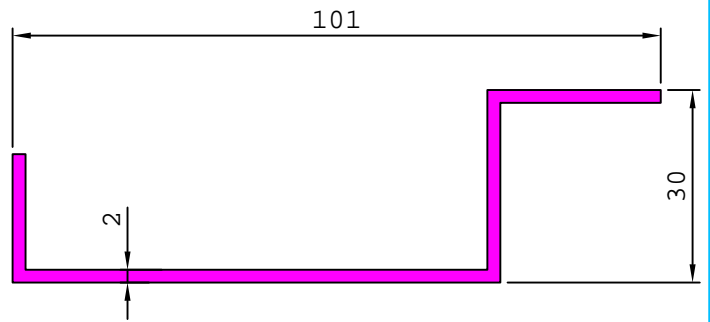

26585 0.145 kg/m

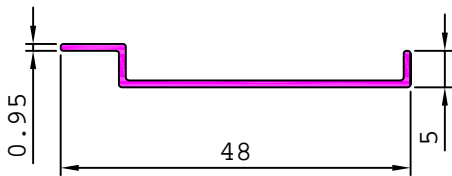

26591 0.231 kg/m

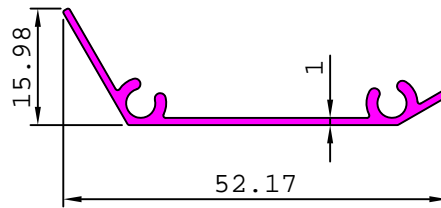

26592 0.140 kg/m

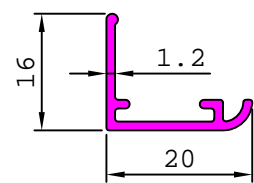

26604 0.301 kg/m

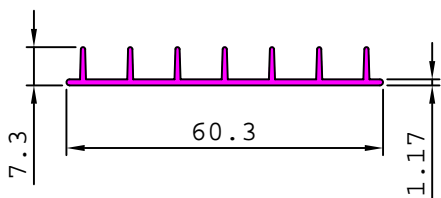

26605 0.106 kg/m

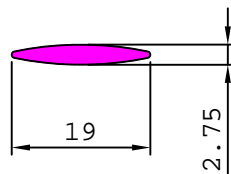

26615 0.210 kg/m

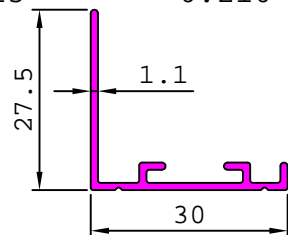

INDUSTRIAL

AIR GRILL PROFILE

26601

0.411 kg/m

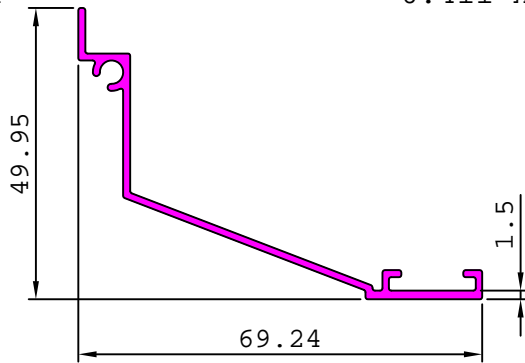

26612

0.285 kg/m

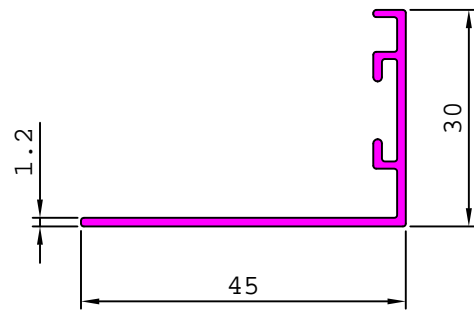

26613

0.232 kg/m

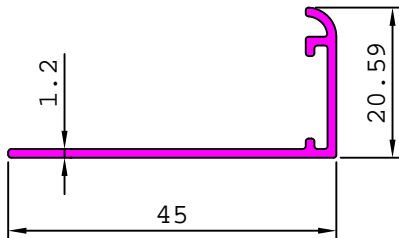

26617

0.571 kg/m

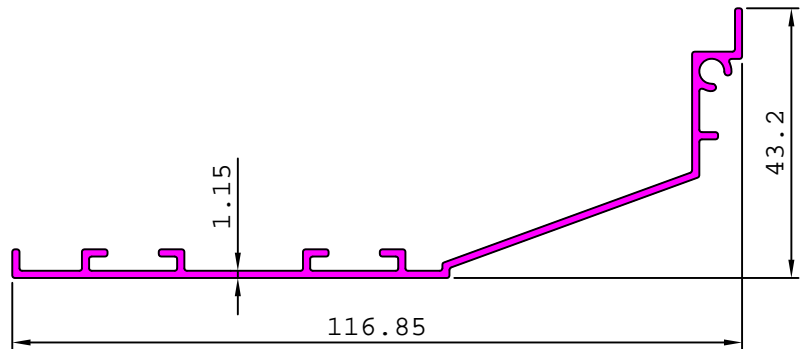

26627

0.162 kg/m

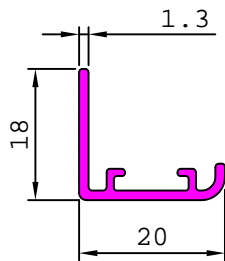

26634

0.163 kg/m

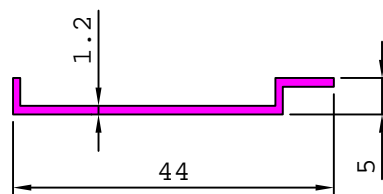

26635

0.204 kg/m

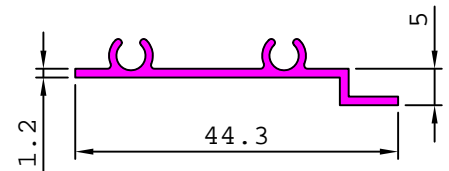

26638

0.212 kg/m

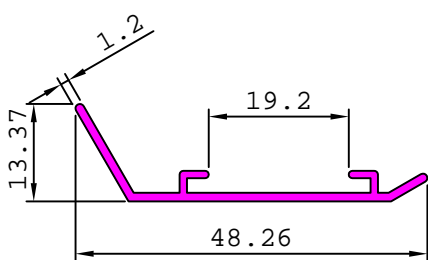

26647

0.150 kg/m

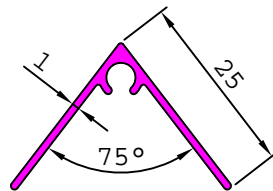

26648

0.241 kg/m

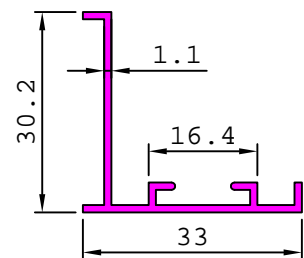

26653

0.597 kg/m

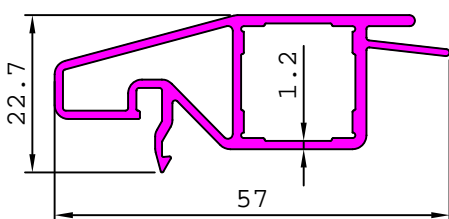

26666

0.114 kg/m

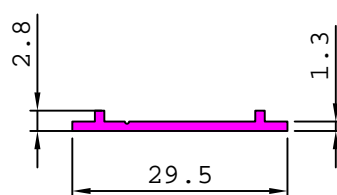

26667

0.172 kg/m

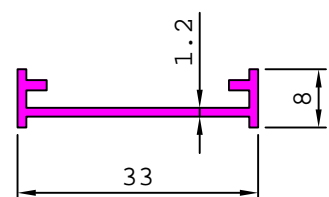

INDUSTRIAL

AIR GRILL PROFILE

26636

0.496 kg/m

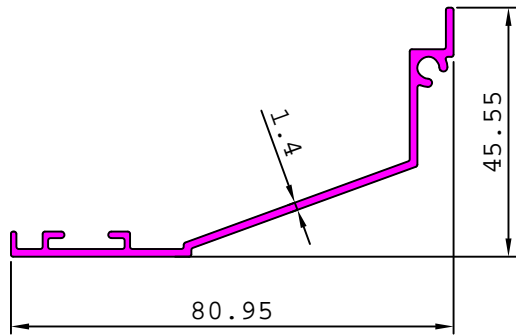

26672

0.436 kg/m

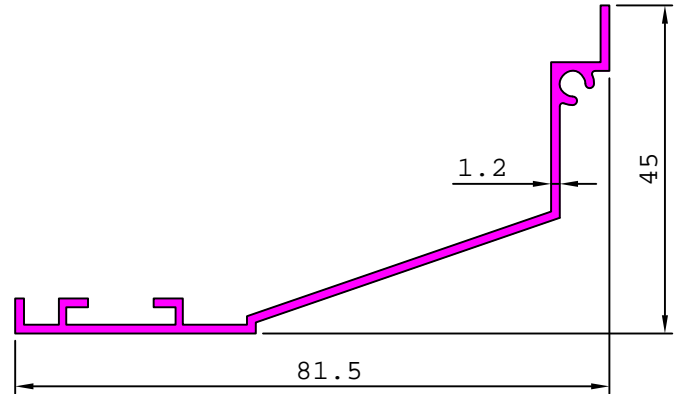

26668

0.202 kg/m

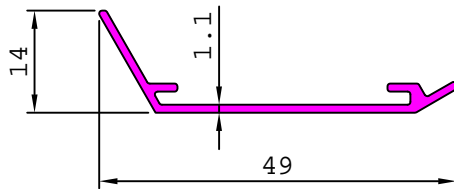

26670

0.386 kg/m

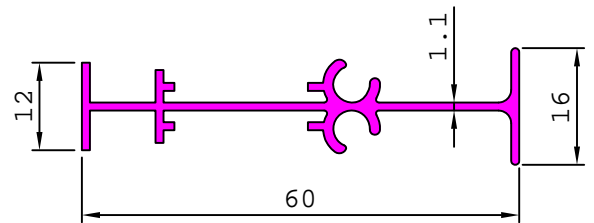

26671

0.372 kg/m

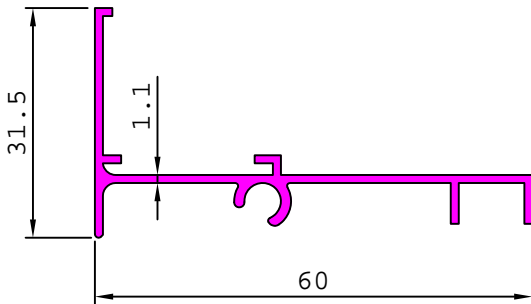

26684

0.451 kg/m

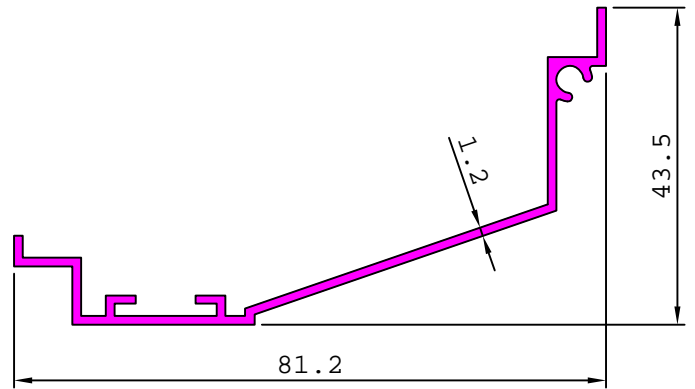

26673

0.961 kg/m

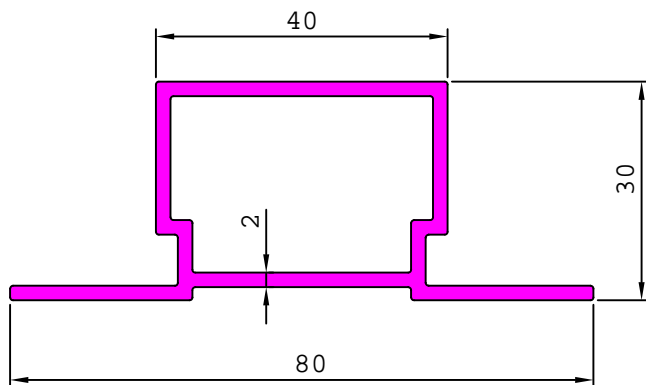

26674

0.626 kg/m

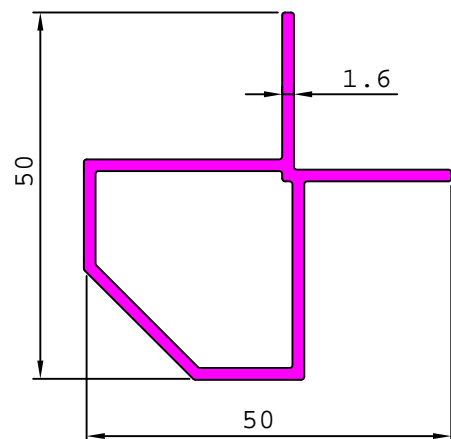

INDUSTRIAL

AIR GRILL PROFILE

26685

0.676 kg/m

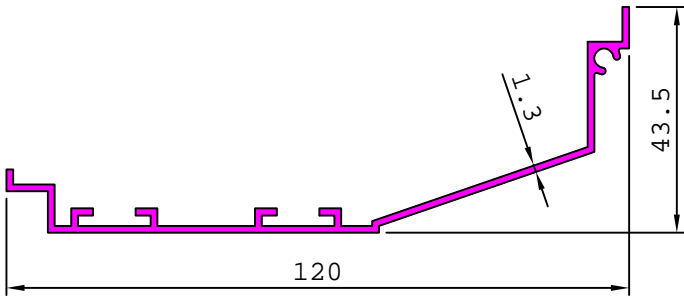

26686

0.248 kg/m

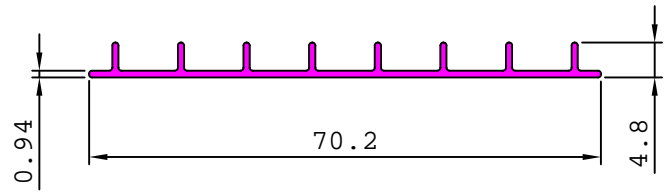

26687

0.213 kg/m

26692

0.176 kg/m

26696

0.457 kg/m

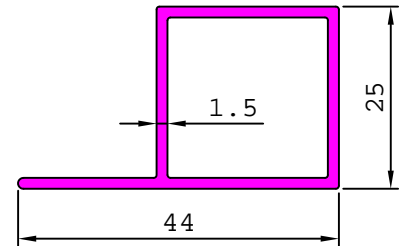
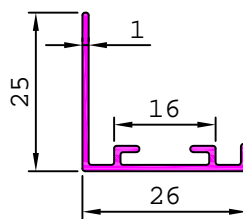
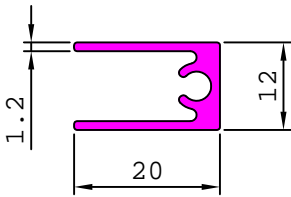

26695

1.608 kg/m

26707

1.193 kg/m

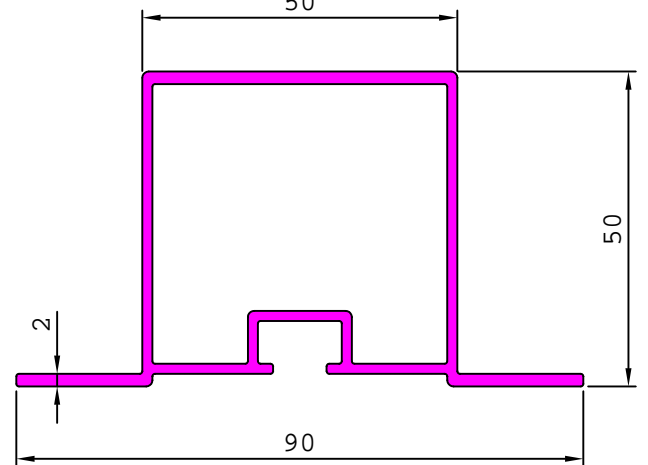
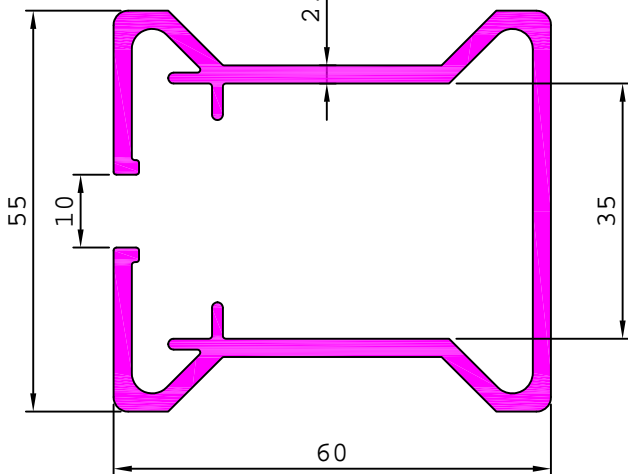

26703

4.473 kg/m

26697

0.632 kg/m

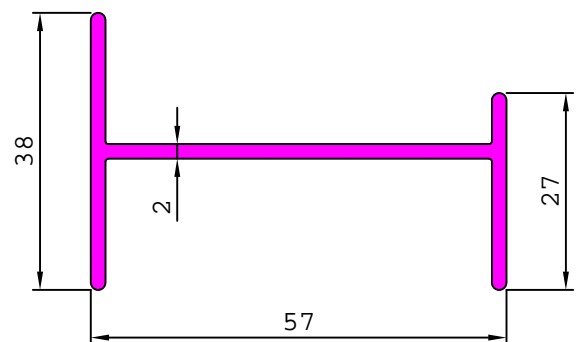
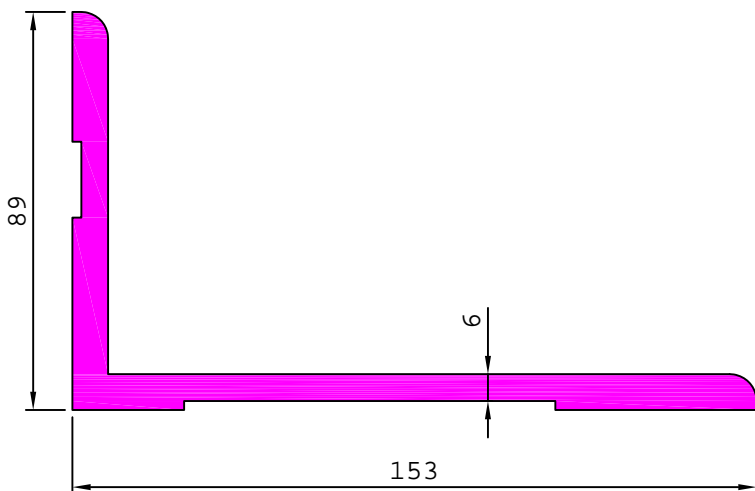

INDUSTRIAL

AIR GRILL PROFILE

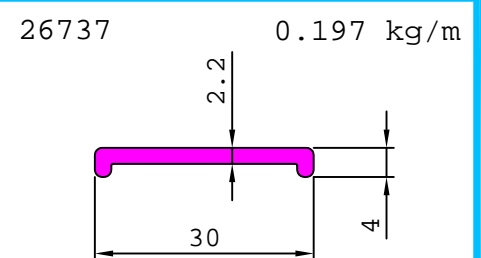
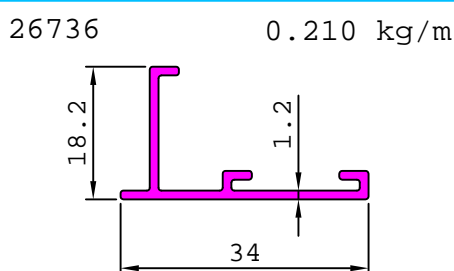
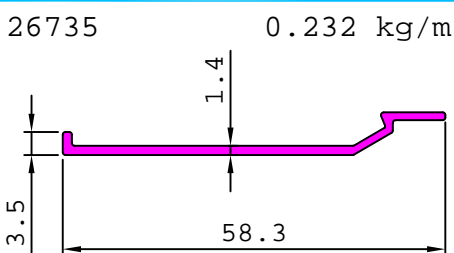
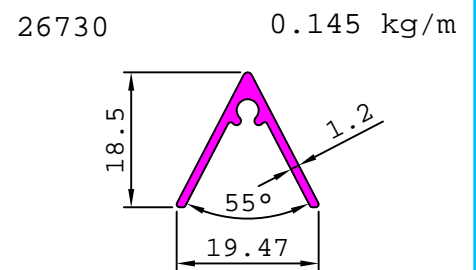
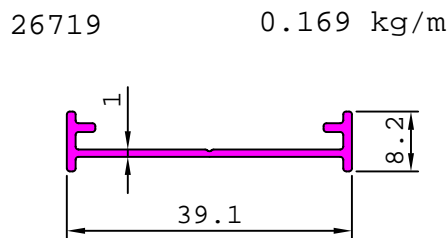
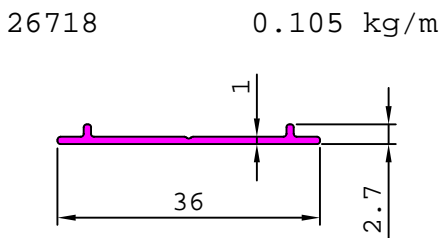
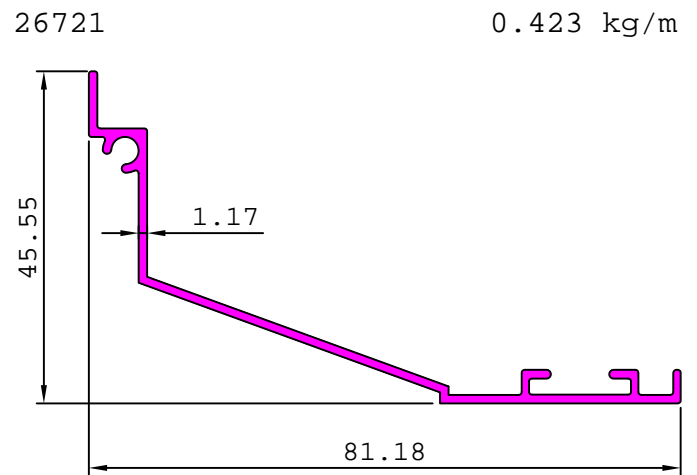
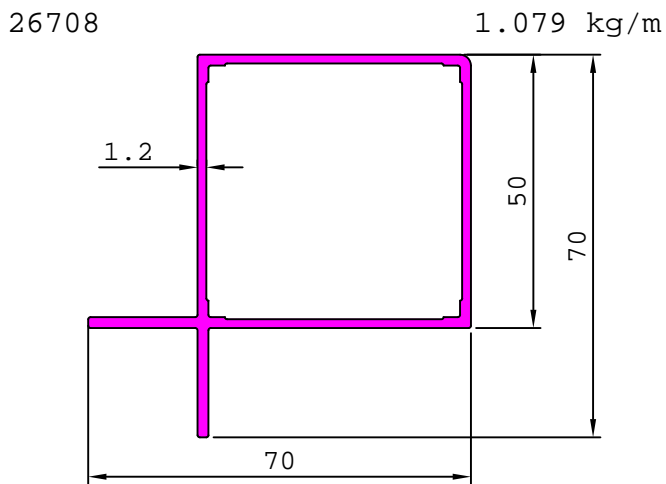
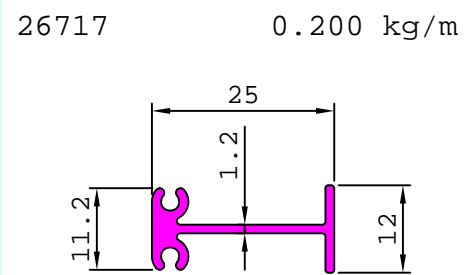
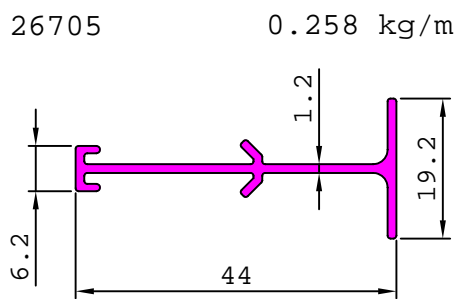
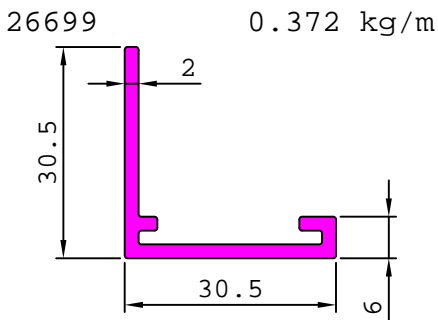
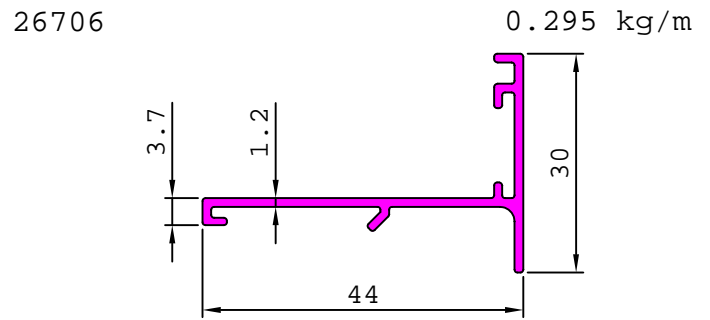
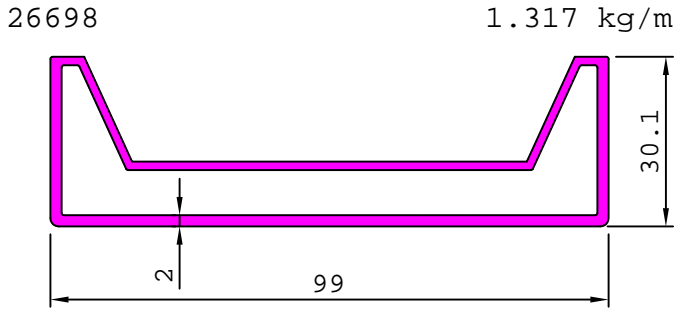

INDUSTRIAL

AIR GRILL PROFILE

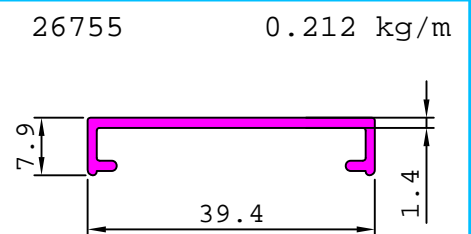
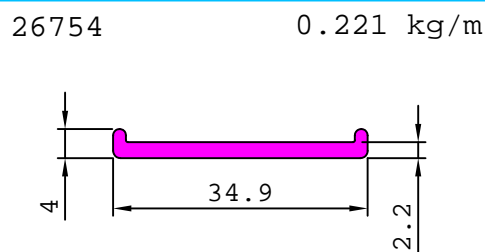
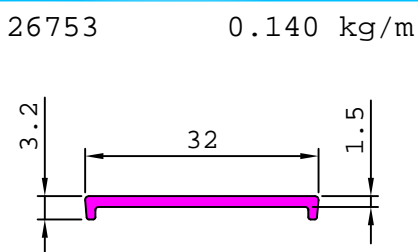
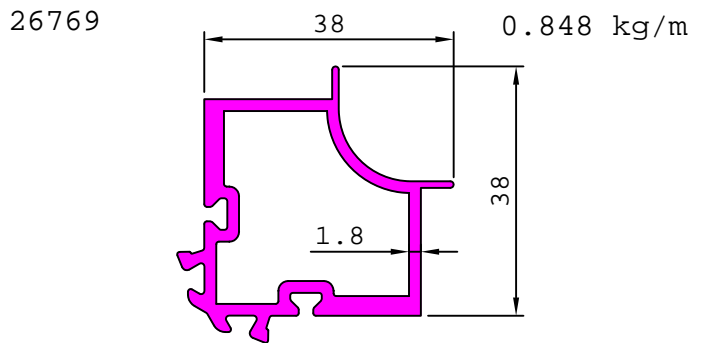
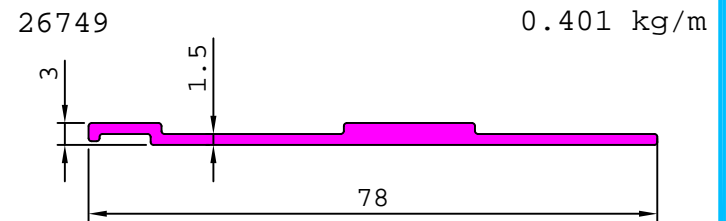
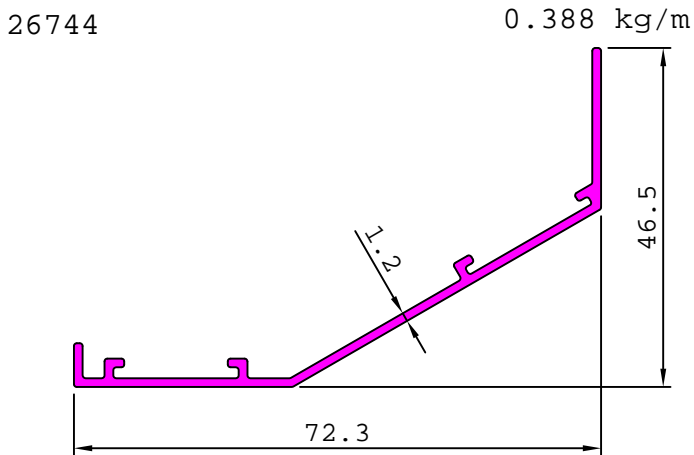
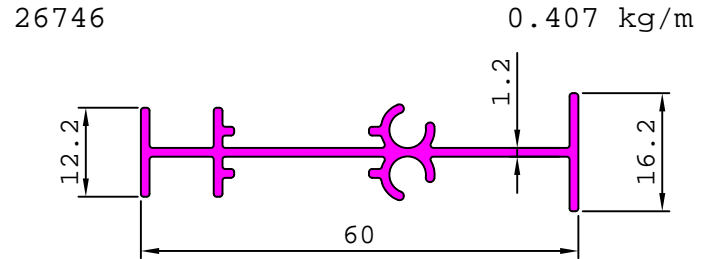
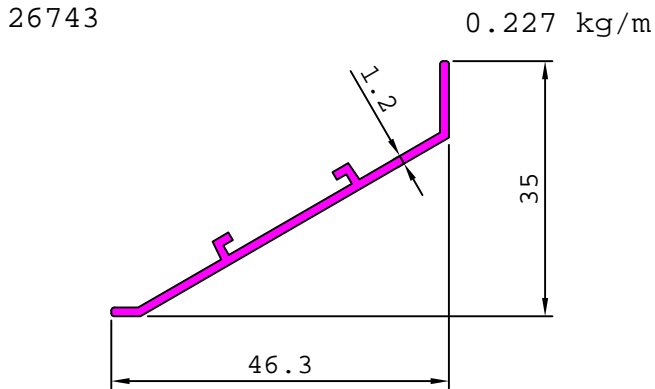
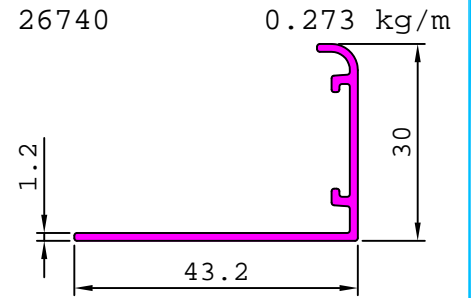
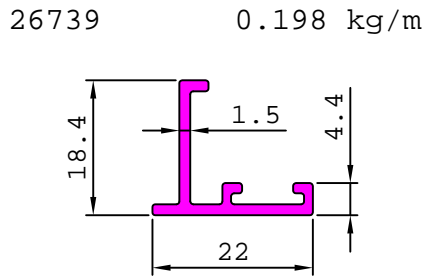
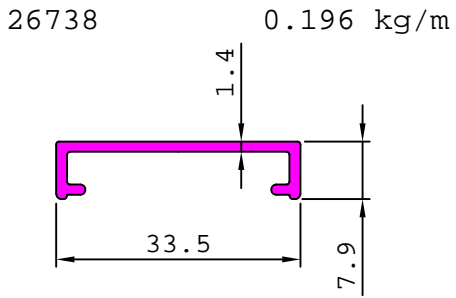
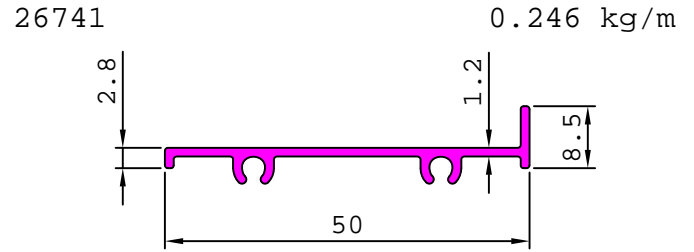
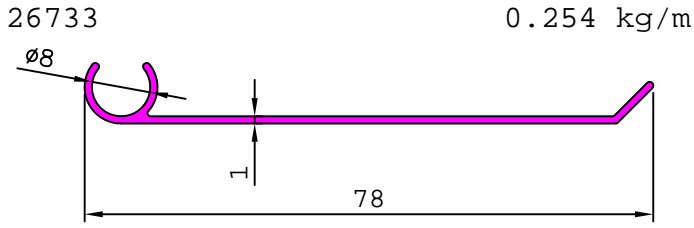

INDUSTRIAL

AIR GRILL PROFILE

26756 0.230 kg/m

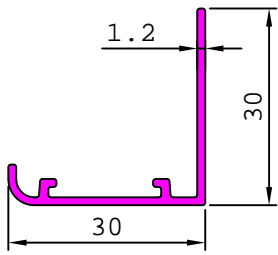

26757 0.110 kg/m

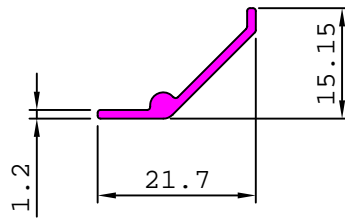

26760 0.217 kg/m

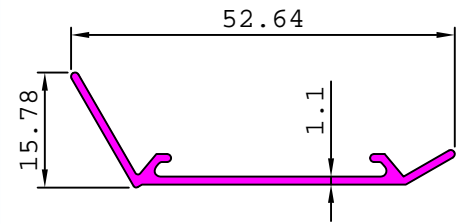

26759 0.625 kg/m

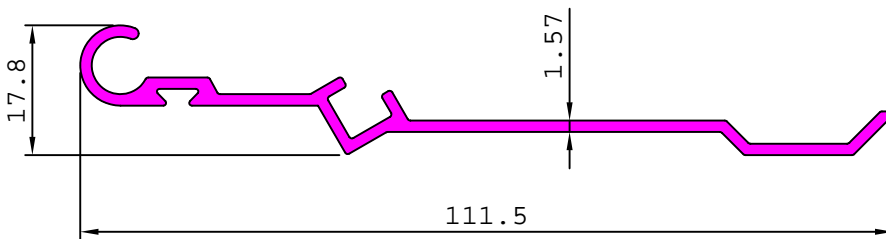

26773 0.353 kg/m

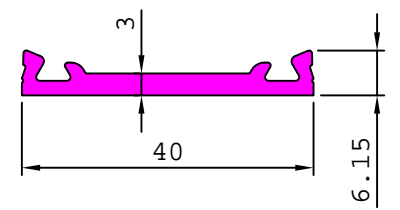

26768 1.315 kg/m

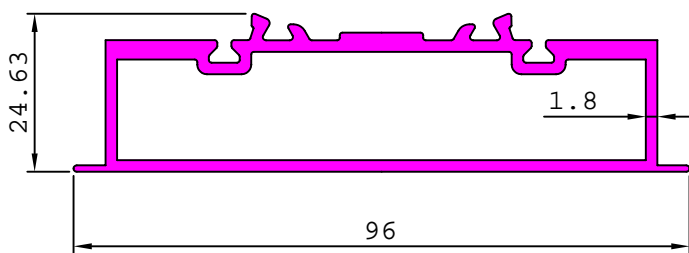

26776 0.373 kg/m

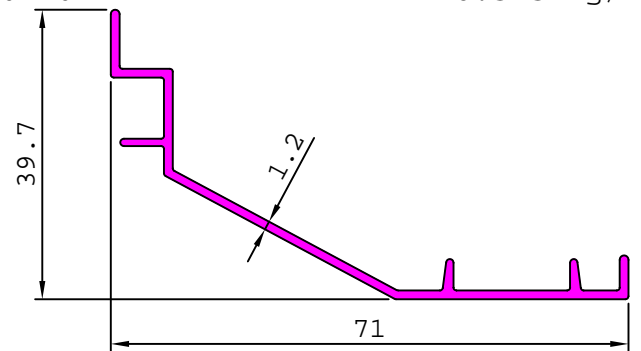

26771 0.492 kg/m

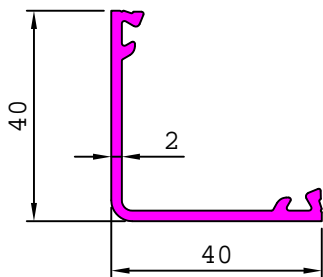

26777 0.253 kg/m

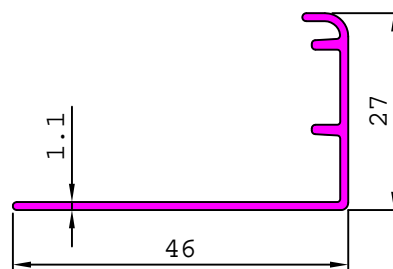

26781 0.138 kg/m

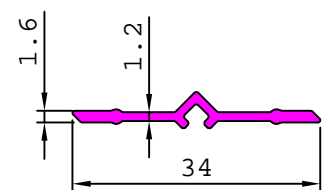

26779 0.321 kg/m

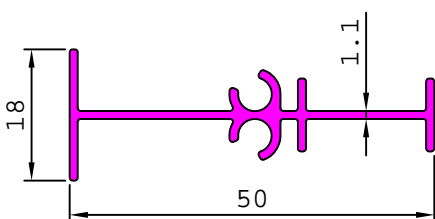

26780 0.351 kg/m

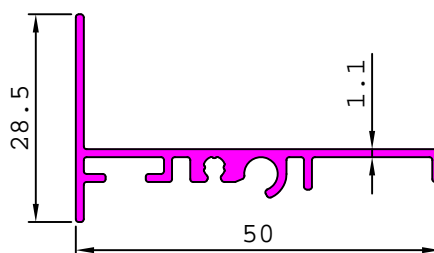

26785 0.567 kg/m

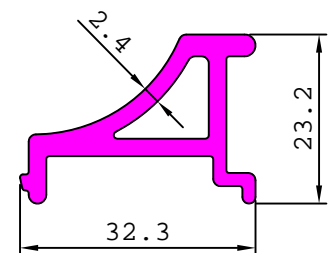

INDUSTRIAL

AIR GRILL PROFILE

26782

0.616 kg/m

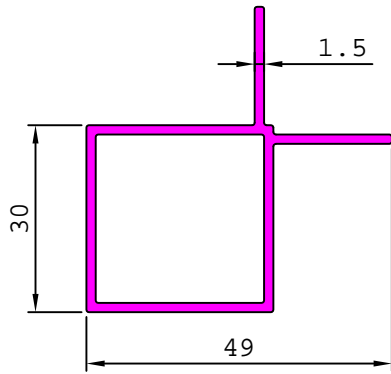

26786

0.270 kg/m

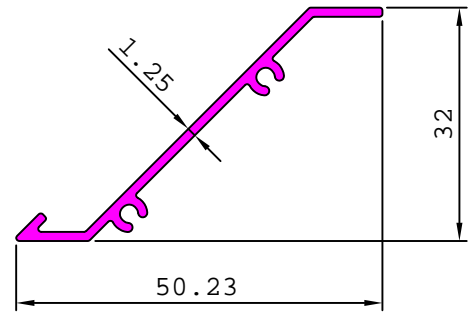

26787

0.486 kg/m

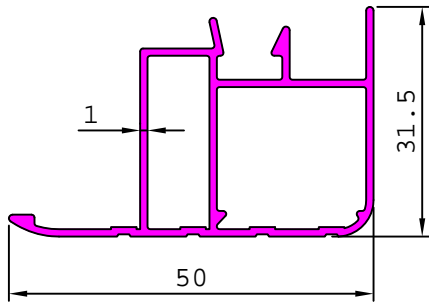

26788

1.544 kg/m

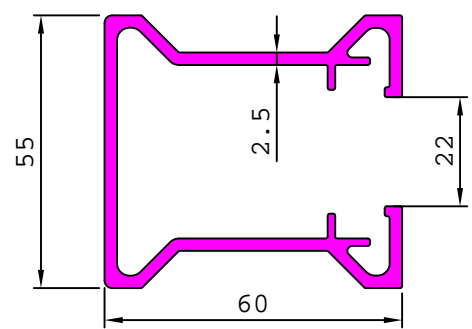

26789

1.210 kg/m

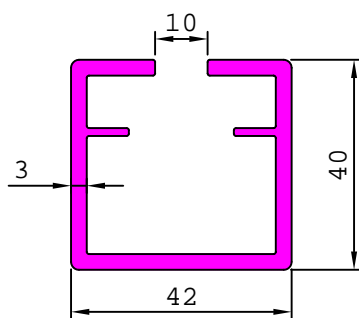

26790

2.635 kg/m

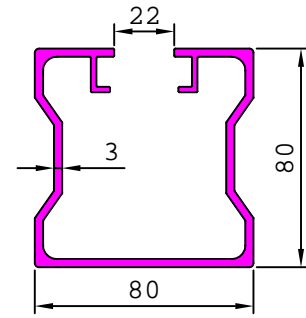

26792

0.842 kg/m

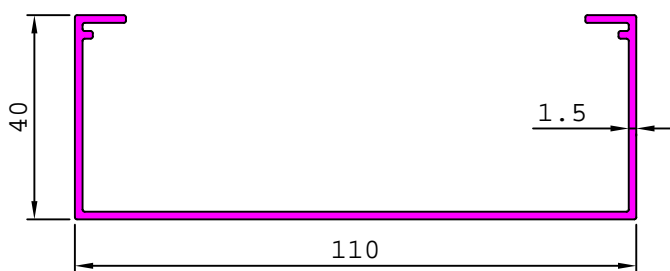

26793

0.950 kg/m

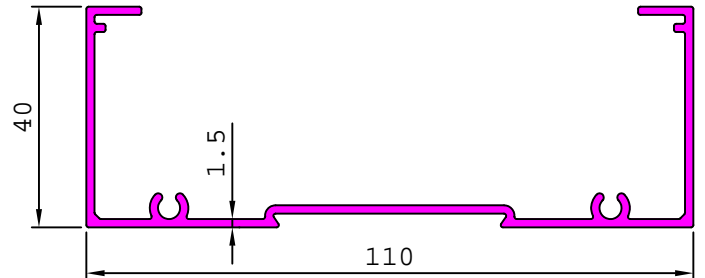

26791

0.356 kg/m

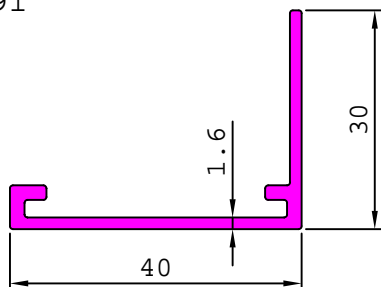

26794

0.385 kg/m

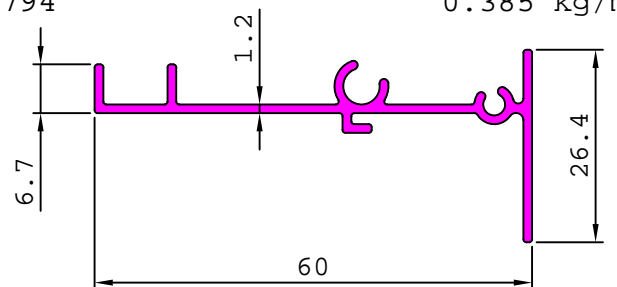

INDUSTRIAL

AIR GRILL PROFILE

26798

0.857 kg/m

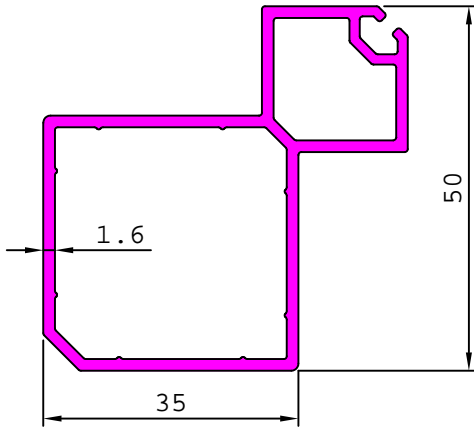

26800

0.694 kg/m

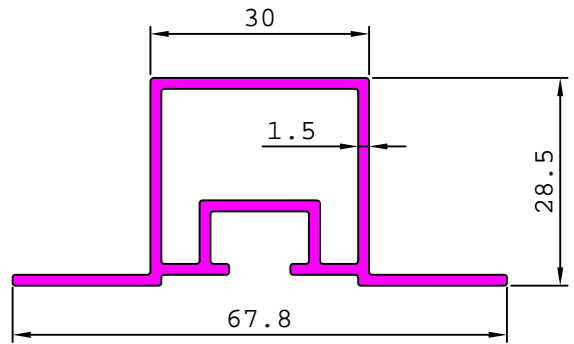

26799

1.123 kg/m

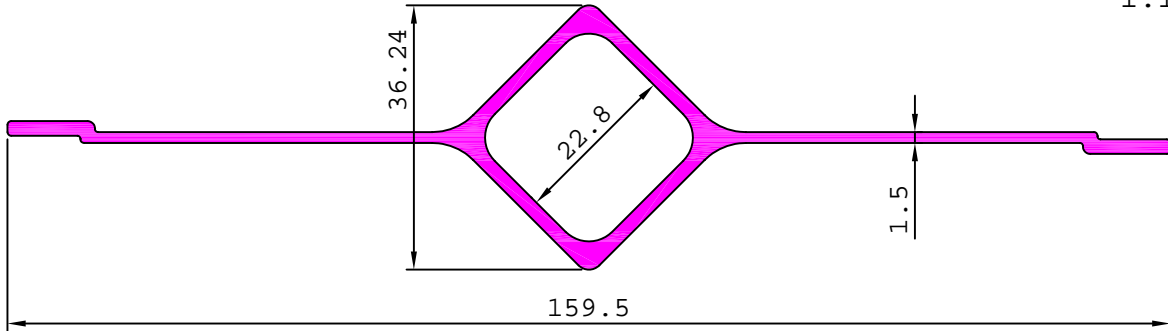

26801

0.811 kg/m

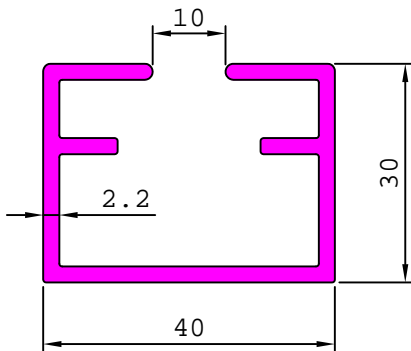

26803

0.567 kg/m

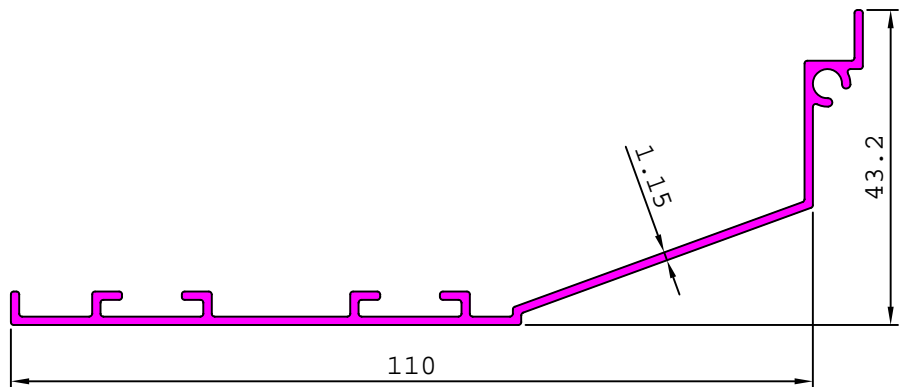

26804

0.273 kg/m

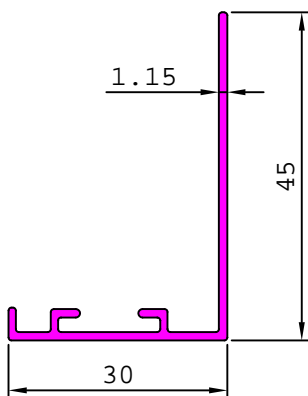

26805

0.209 kg/m

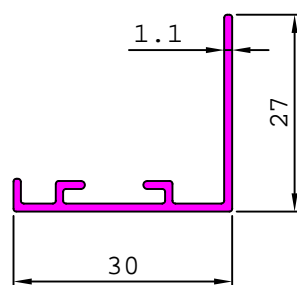

26810

0.217 kg/m

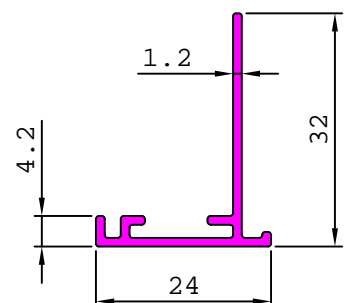

INDUSTRIAL

AIR GRILL PROFILE

26806

0.421 kg/m

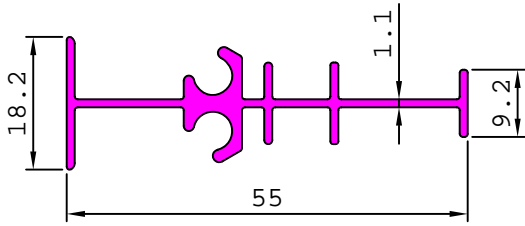

26807

0.417 kg/m

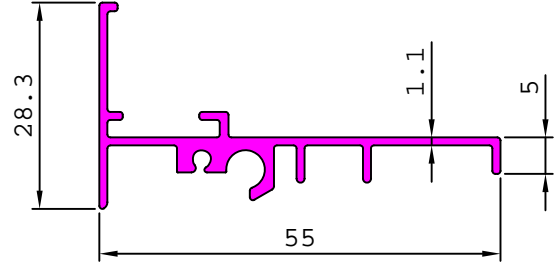

26809

0.434 kg/m

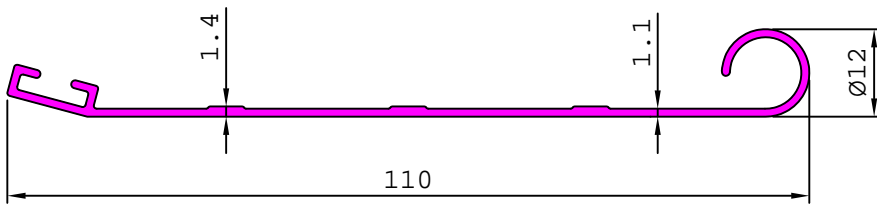

26813

0.245 kg/m

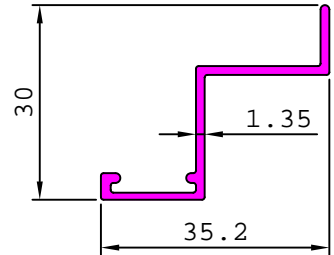

26816

0.826 kg/m

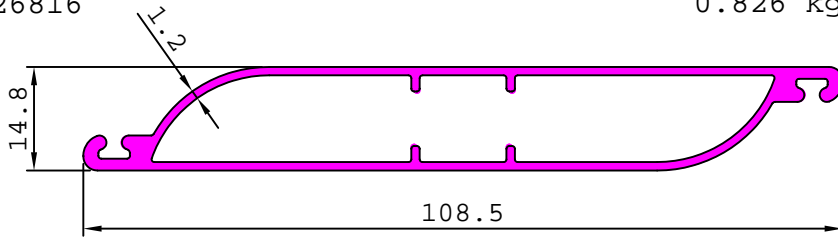

26814

0.158 kg/m

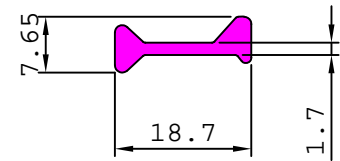

26815

1.103 kg/m

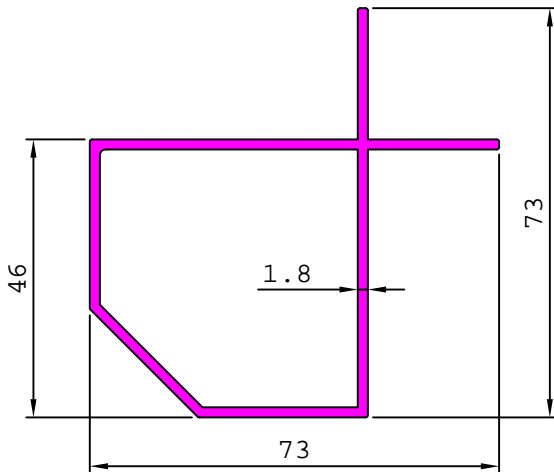

26817

0.311 kg/m

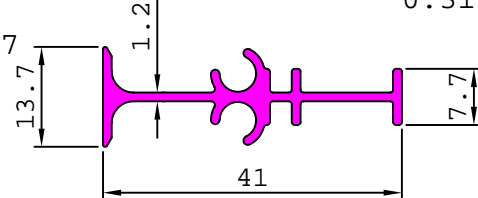

26818

0.291 kg/m

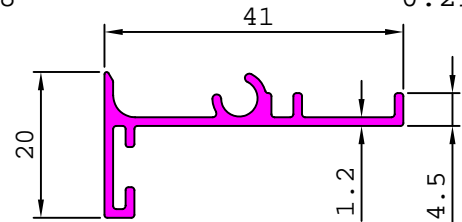

26824

0.138 kg/m

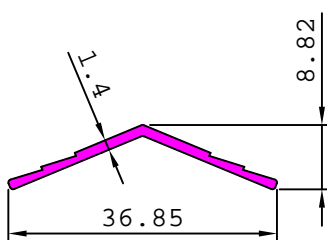

26827

0.164 kg/m

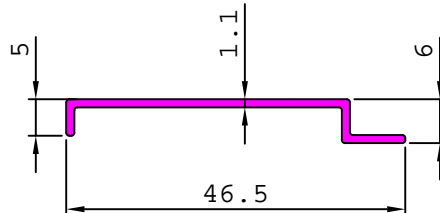

26844

0.193 kg/m

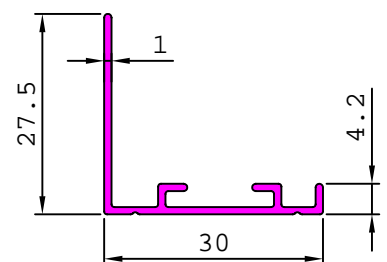

INDUSTRIAL

AIR GRILL PROFILE

26825

0.916 kg/m

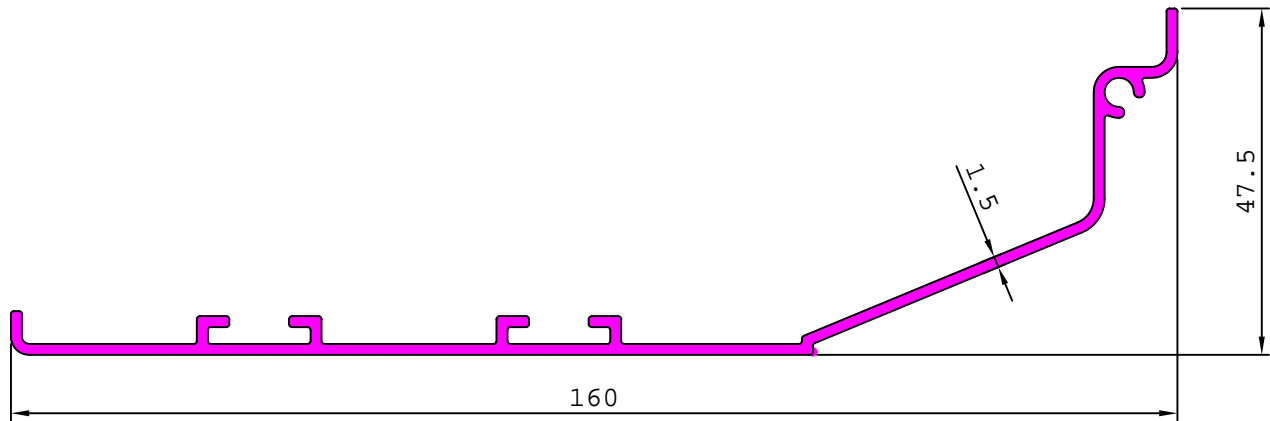

26826

0.716 kg/m

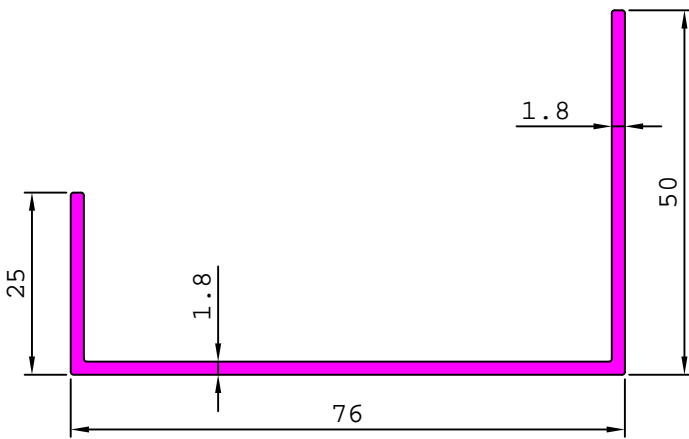

26829

0.502 kg/m

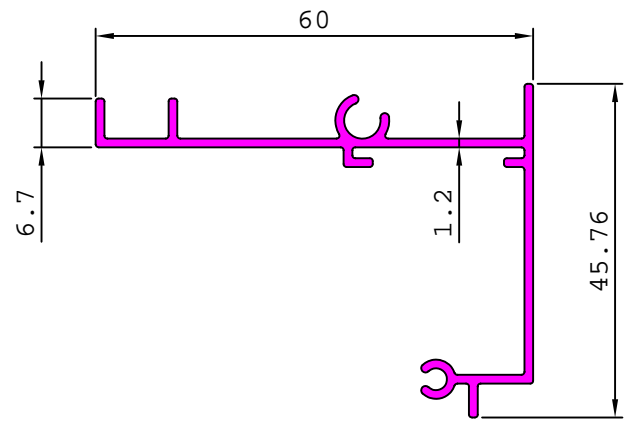

26838

0.483 kg/m

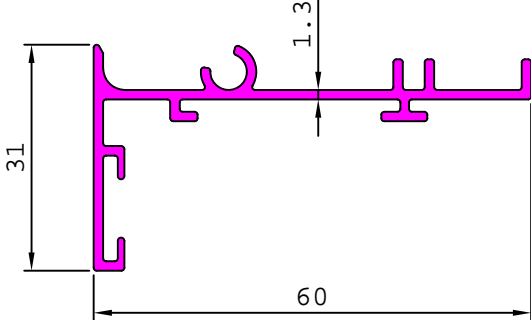

26843

0.262 kg/m

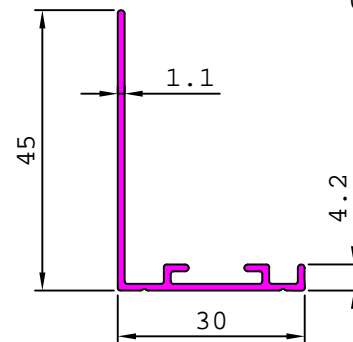

26847

0.397 kg/m

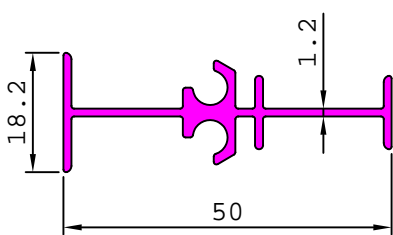

26848

0.479 kg/m

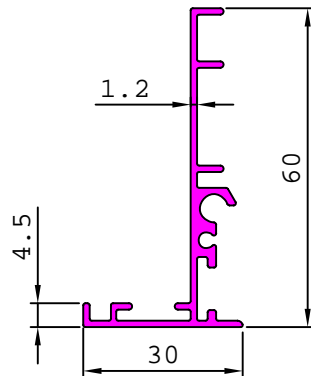

26852

0.371 kg/m

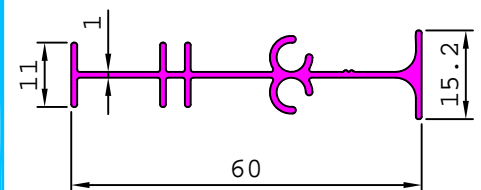

INDUSTRIAL

AIR GRILL PROFILE

26853 0.410 kg/m

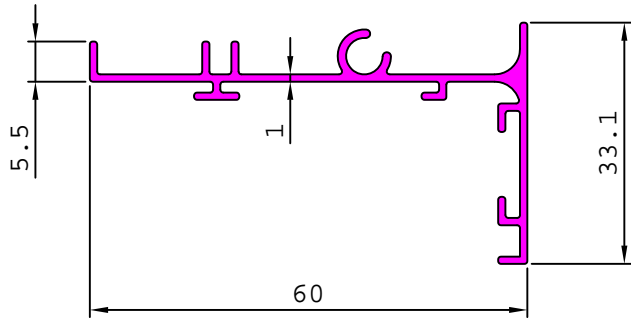

26854 0.180 kg/m

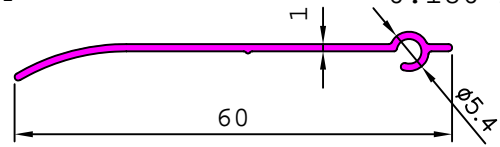

26855 0.142 kg/m

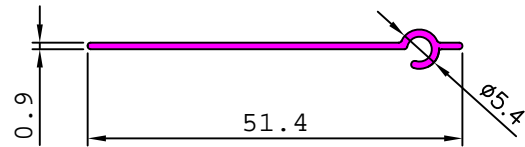

26856 0.421 kg/m

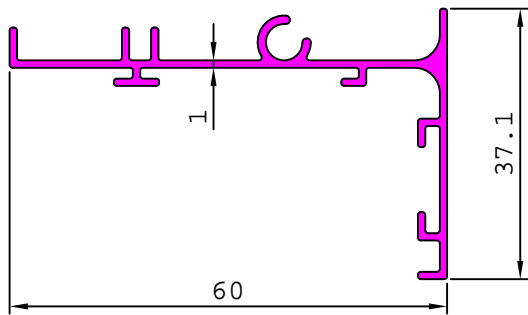

26864 0.333 kg/m

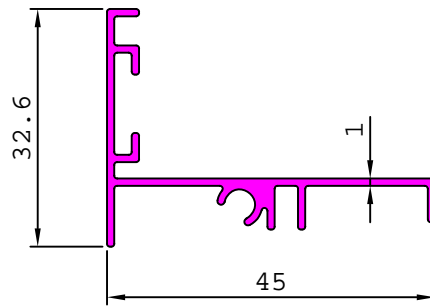

26863 0.324 kg/m

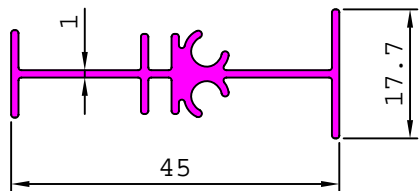

26871 0.196 kg/m

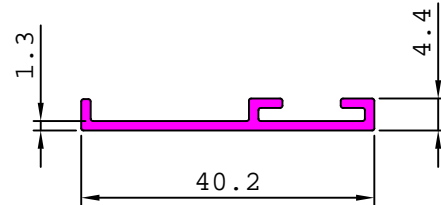

26873 0.406 kg/m

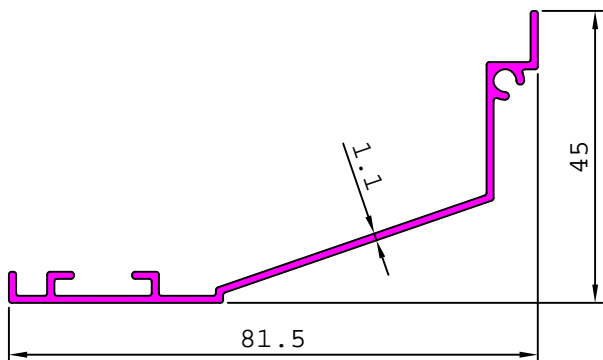

26881 0.412 kg/m

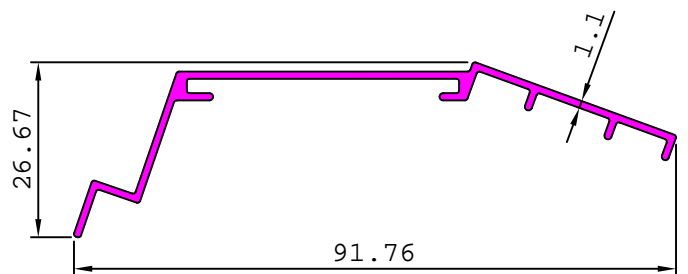

26882 0.195 kg/m

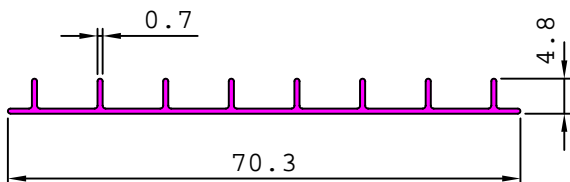

26883 0.184 kg/m

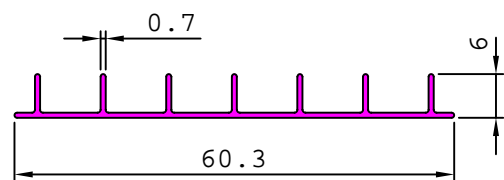

INDUSTRIAL

AIR GRILL PROFILE

26884 0.368 kg/m

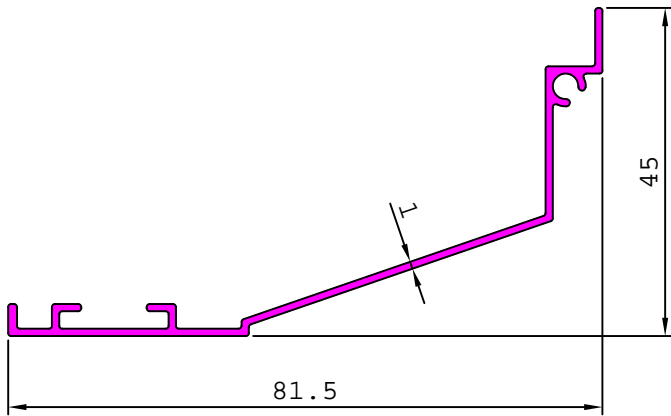

26885 0.126 kg/m

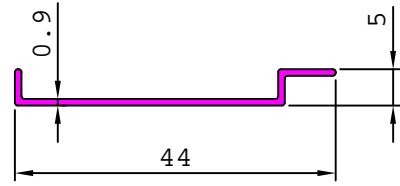

26886 0.161 kg/m

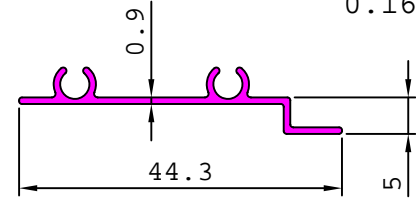

26888 0.353 kg/m

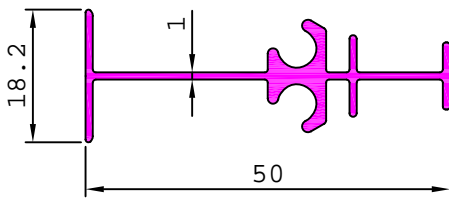

26890 0.360 kg/m

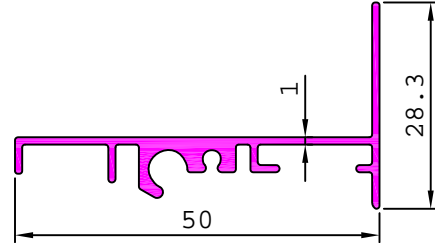

26891 0.244 kg/m

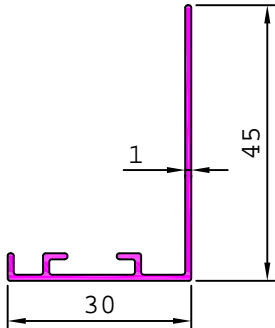

26892 0.405 kg/m

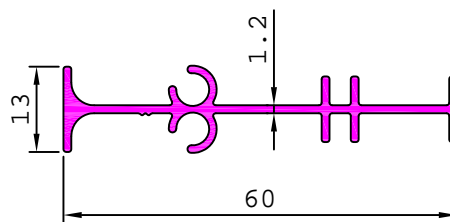

26893 0.409 kg/m

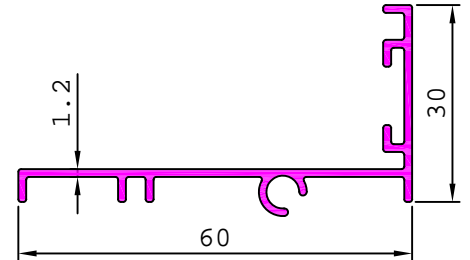

26900 0.215 kg/m

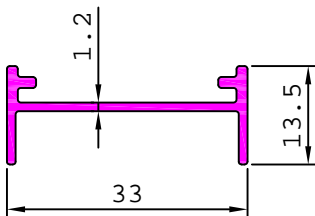

26901 0.112 kg/m

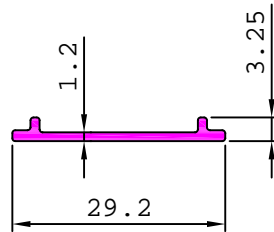

26912 0.088 kg/m

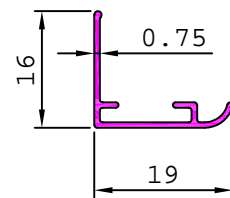

26903 0.396 kg/m

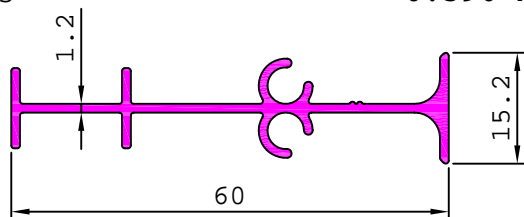

26905 0.339 kg/m

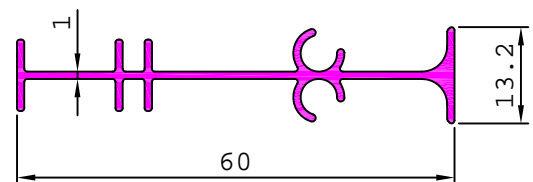

INDUSTRIAL

AIR GRILL PROFILE

26902

0.458 kg/m

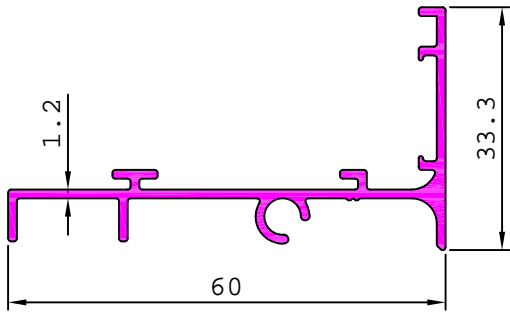

26906

0.355 kg/m

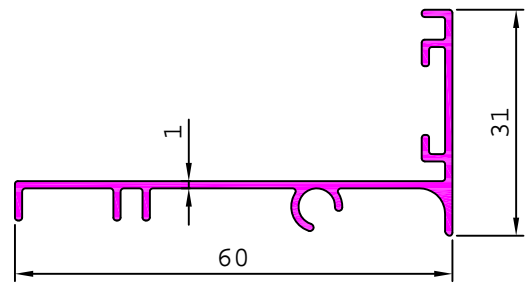

26913

0.517 kg/m

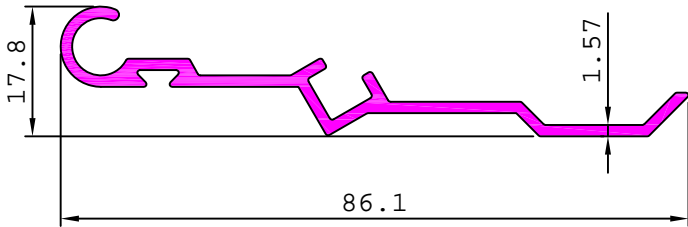

26925

0.581 kg/m

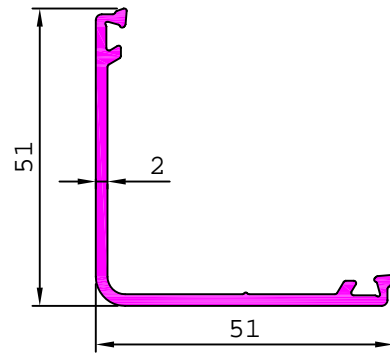

26937

0.347 kg/m

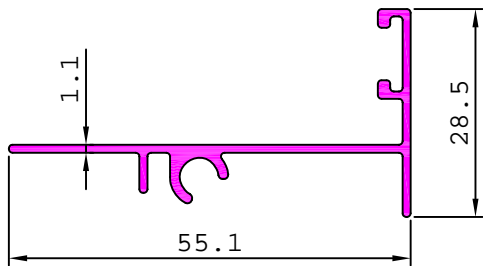

26938

0.336 kg/m

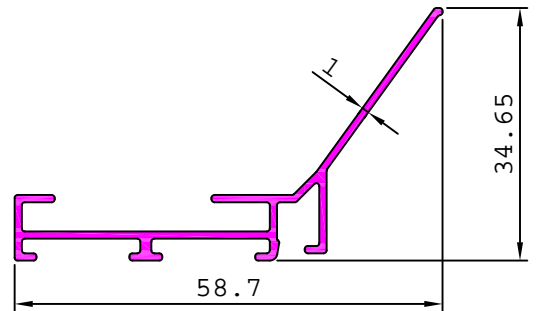

26939

0.323 kg/m

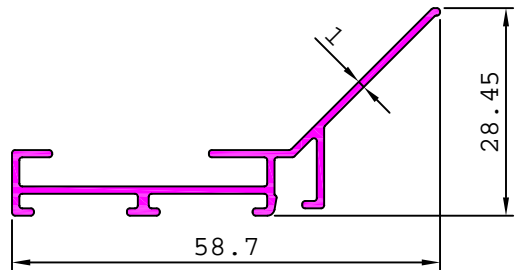

26940

0.956 kg/m

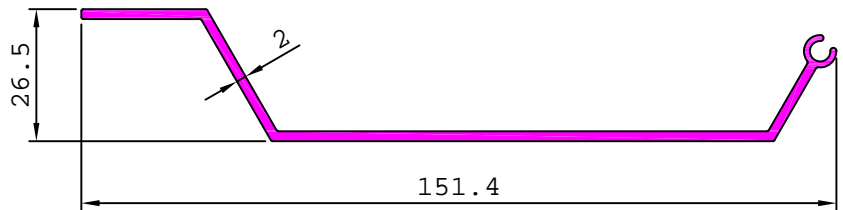

26941

0.683 kg/m

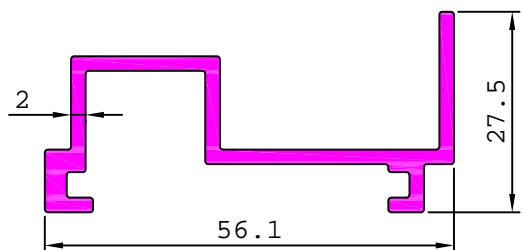

26942

0.167 kg/m

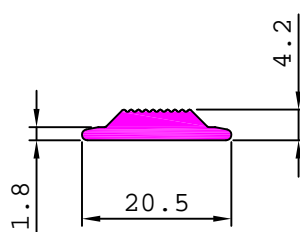

26943

0.211 kg/m

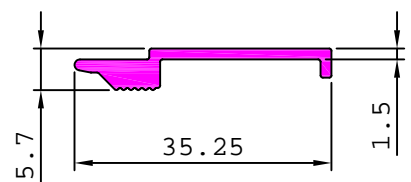

INDUSTRIAL

AIR GRILL PROFILE

26944

0.232 kg/m

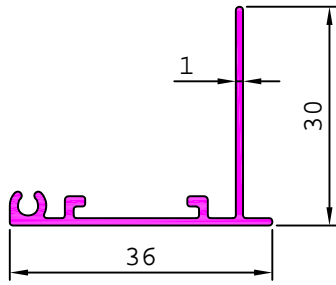

26955

0.108 kg/m

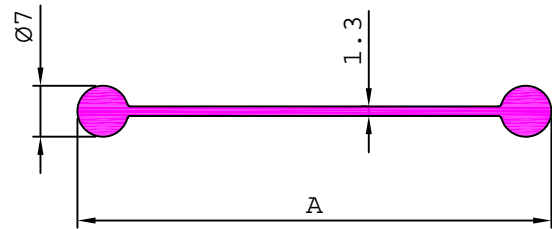
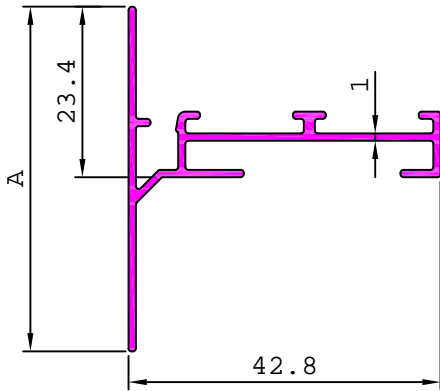
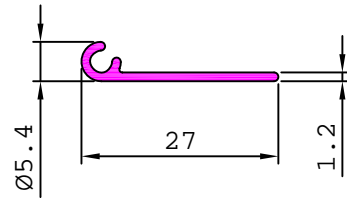

SL. No.	Section No.	A	Weight kg/m
1	26949	36.40	0.329
2	26948	42.85	0.346
3	26946	50.00	0.365
4	26947	55.65	0.381
5	26945	62.30	0.399

SL. No.	Section No.	A	Weight kg/m
1	26954	36.00	0.268
2	26953	48.00	0.300
3	26952	60.00	0.370
4	26951	75.00	0.422
5	26950	87.00	0.464

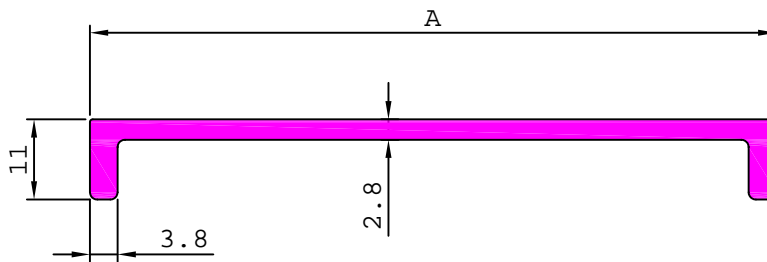

SL. No.	Section No.	A	Weight kg/m
1	26956	163.00	1.399
2	26957	137.60	1.207
3	26958	111.00	1.006
4	26959	86.00	0.817
5	26960	61.67	0.633

INDUSTRIAL

AIR GRILL PROFILE

S4458

0.348 kg/m

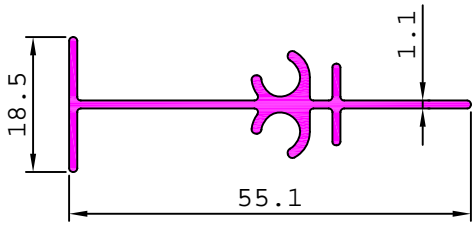

S4988

0.613 kg/m

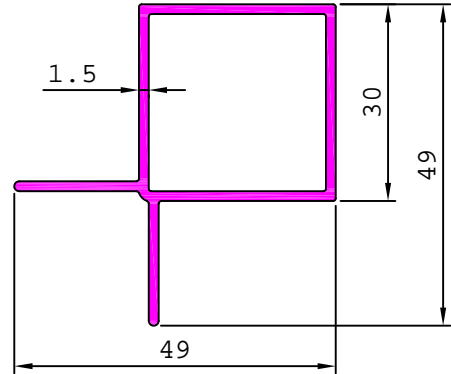

S4990

0.837 kg/m

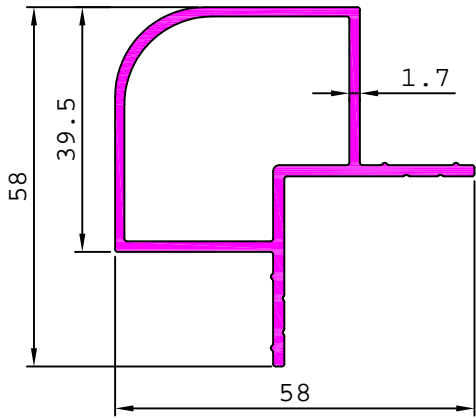

S4989

0.599 kg/m

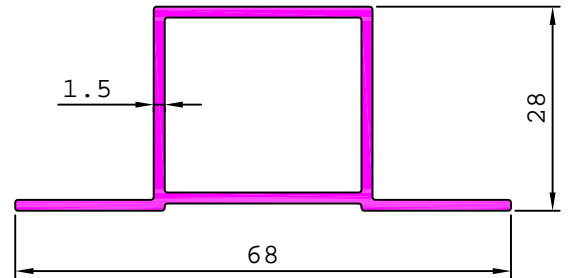

S4991

0.701 kg/m

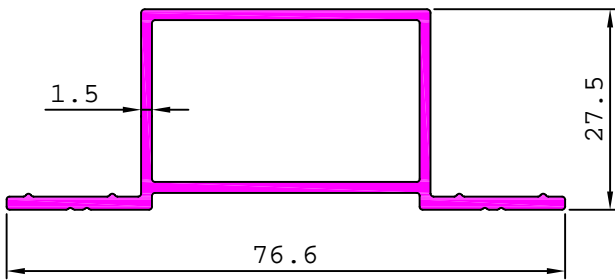

26961

0.700 kg/m

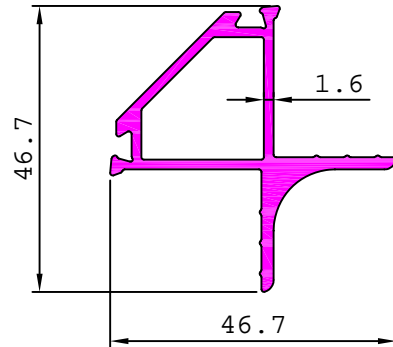

26962

0.113 kg/m

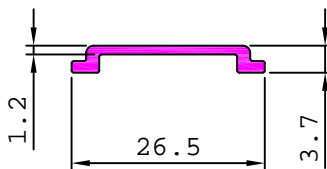

26963

0.244 kg/m

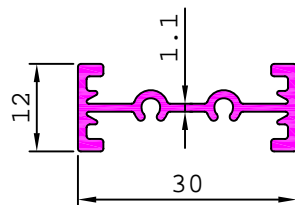

26965

0.148 kg/m

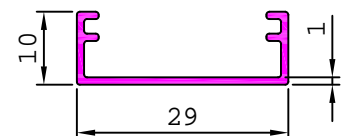

26964

0.210 kg/m

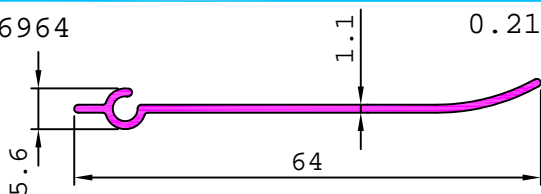

S5160

0.285 kg/m

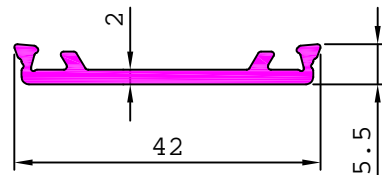

INDUSTRIAL

AIR GRILL PROFILE

26969 0.340 kg/m

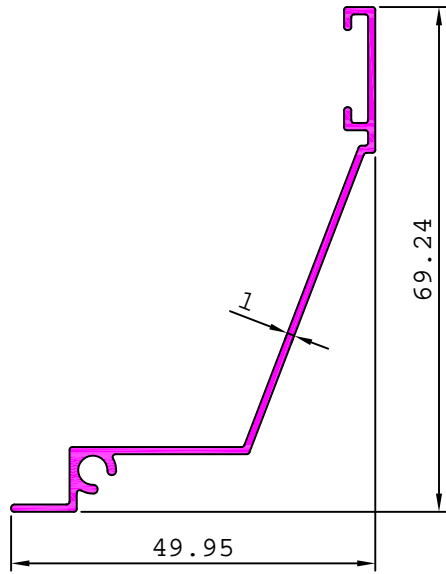

26966 0.305 kg/m

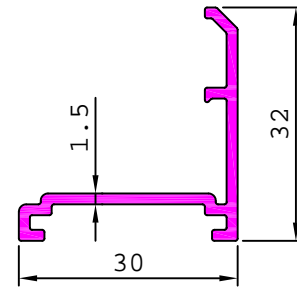

S5159 1.246 kg/m

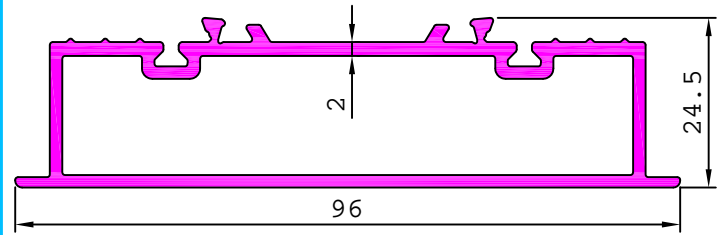

S5158 0.488 kg/m

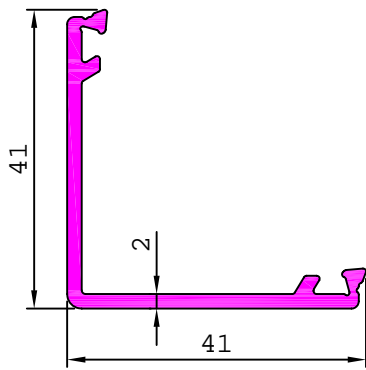

S5161 0.808 kg/m

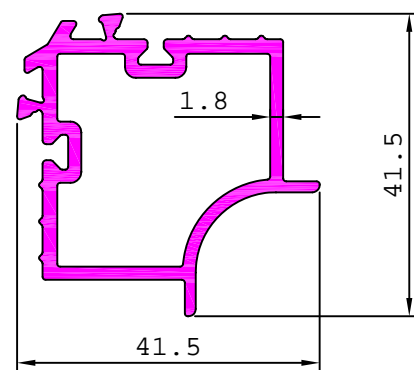

S5162 2.705 kg/m

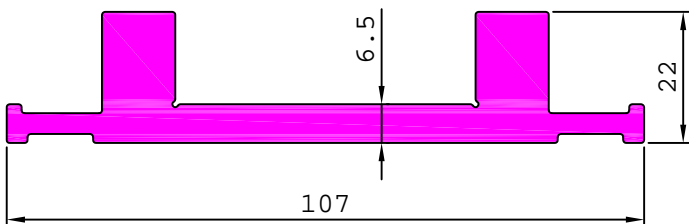

INDUSTRIAL

REFRIGERATION SECTION

26504

2.292 kg/m

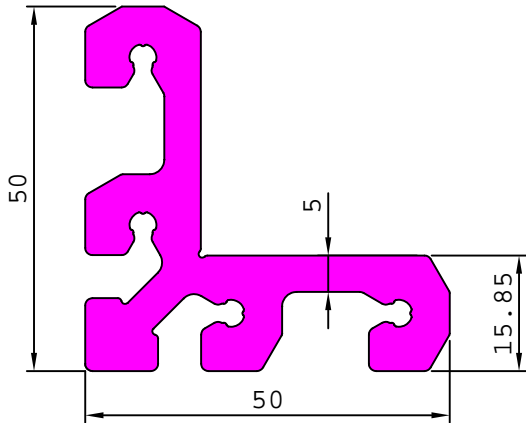

26663

3.173 kg/m

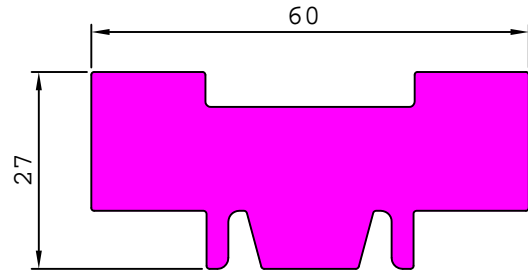

26664

2.547 kg/m

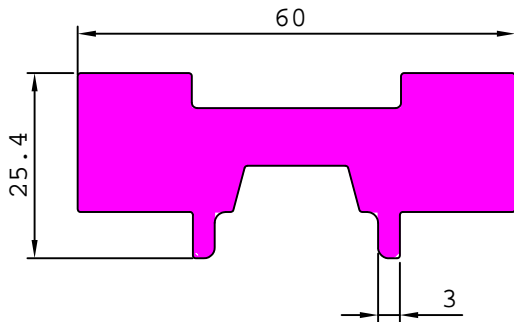

26823

1.268 kg/m

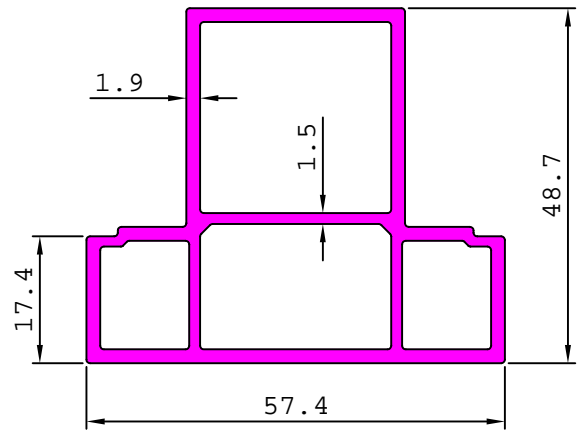

26839

0.717 kg/m

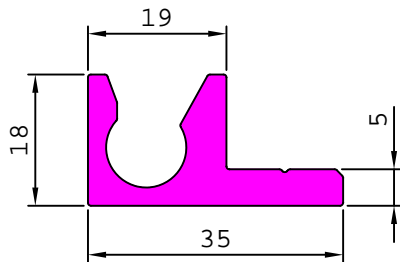

26840

0.886 kg/m

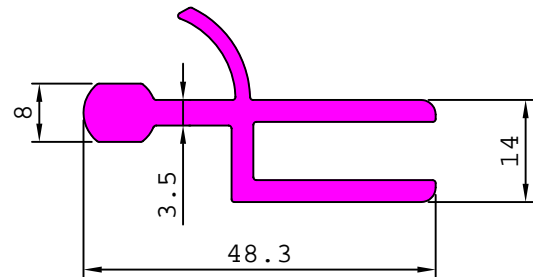

26849

0.850 kg/m

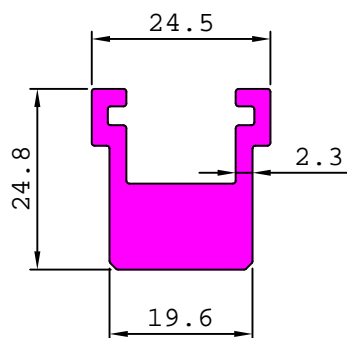

26850

1.327 kg/m

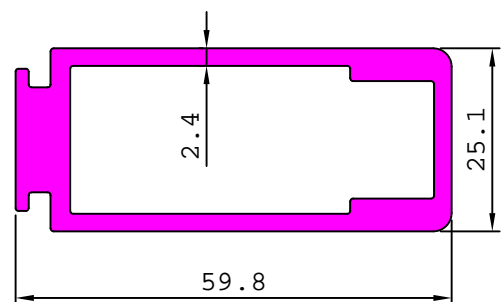

INDUSTRIAL

REFRIGERATION SECTION

26851 1.078 kg/m

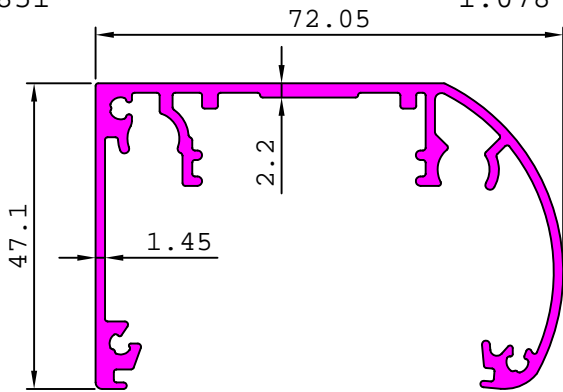

26857 0.526 kg/m

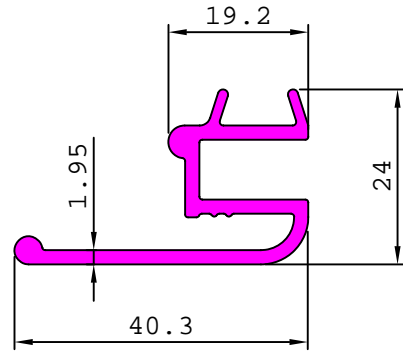

26858 0.777 kg/m

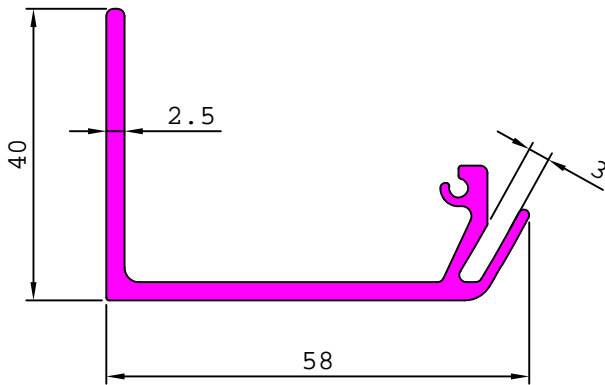

26859 1.181 kg/m

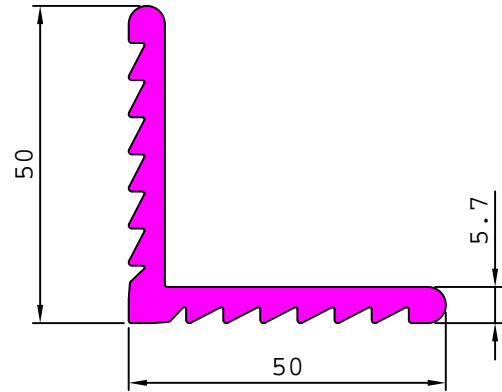

26860 0.267 kg/m

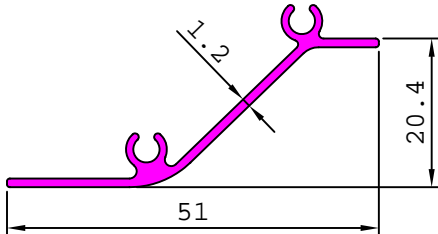

26868 0.155 kg/m

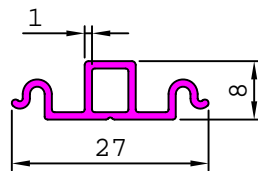

26874 0.347 kg/m

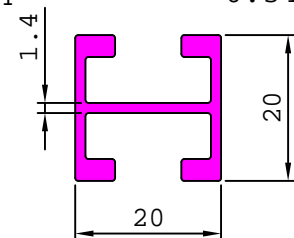

26870 1.724 kg/m

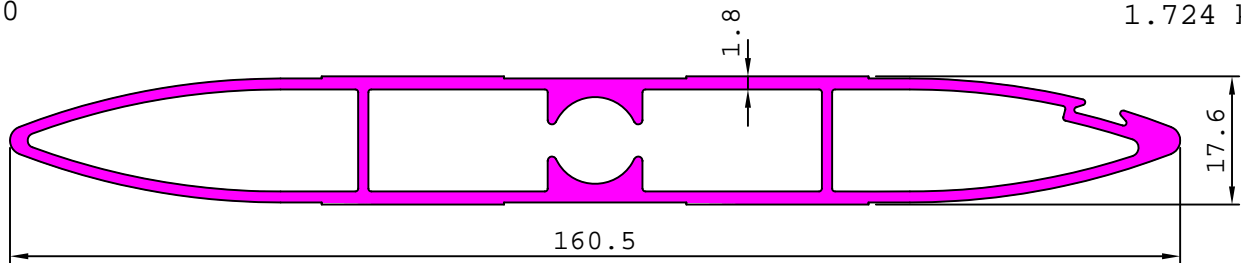

26875 0.160 kg/m

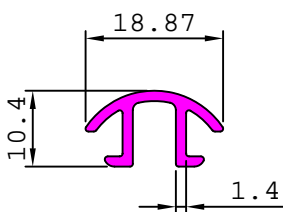

26876 1.050 kg/m

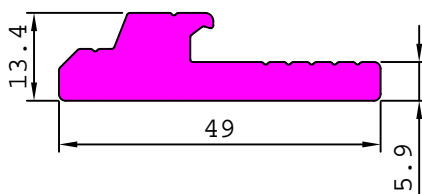

26878 0.429 kg/m

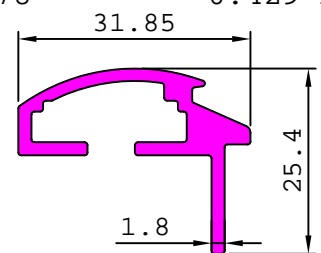

INDUSTRIAL

REFRIGERATION SECTION

26877

0.783 kg/m

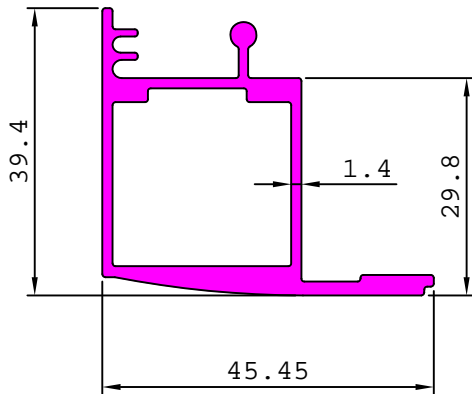

26879

0.795 kg/m

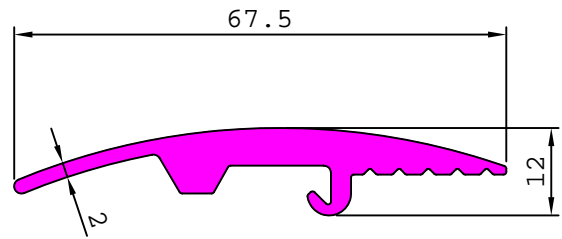

26880

0.897 kg/m

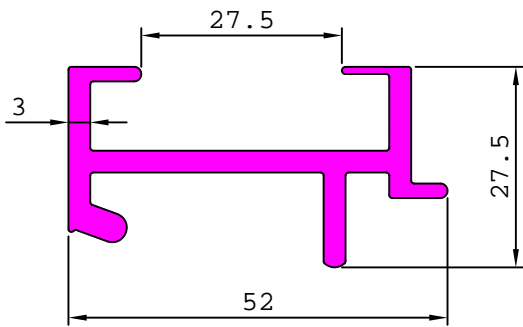

29210

0.855 kg/m

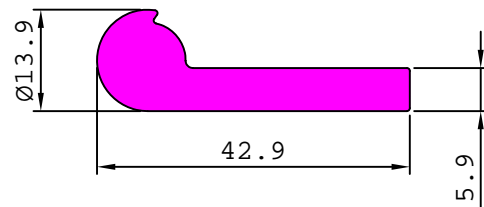

29211

0.740 kg/m

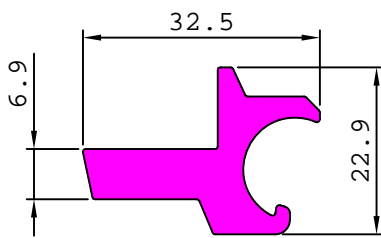

26894

0.656 kg/m

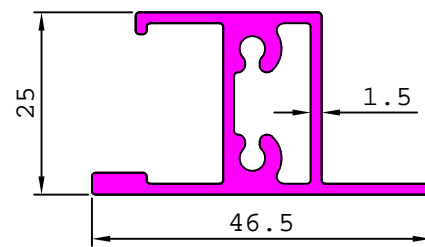

26914

2.479 kg/m

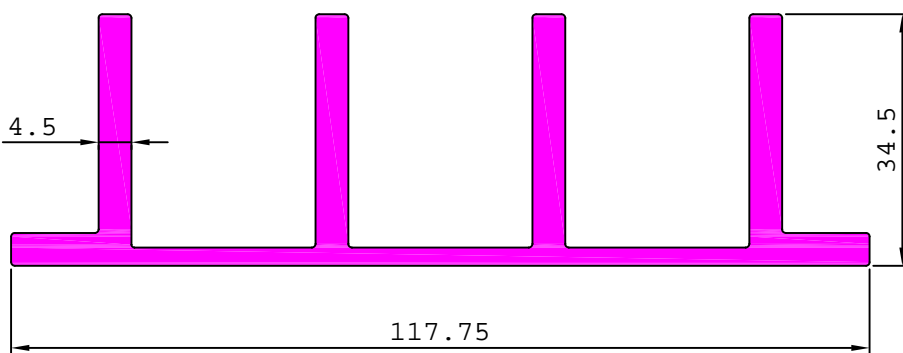

26916

1.489 kg/m

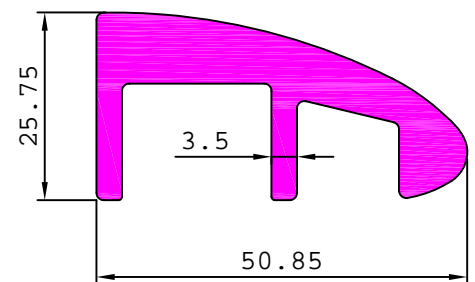

INDUSTRIAL

REFRIGERATION SECTION

26915

0.995 kg/m

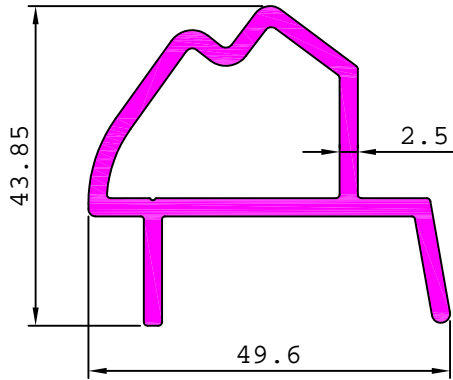

26922

1.060 kg/m

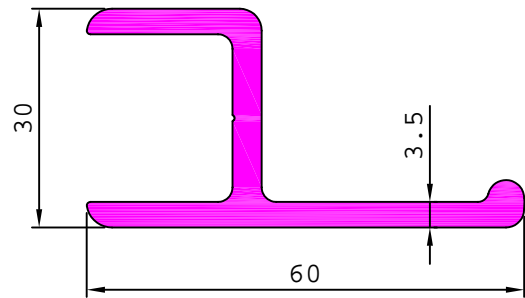

26918

0.770 kg/m

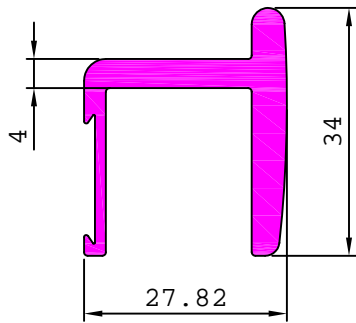

26919

2.410 kg/m

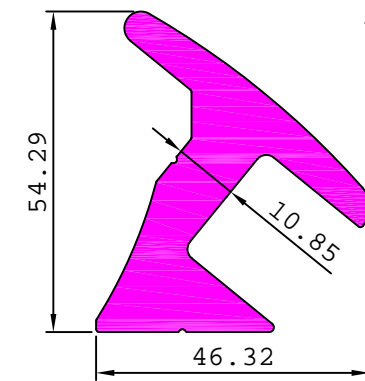

26920

0.974 kg/m

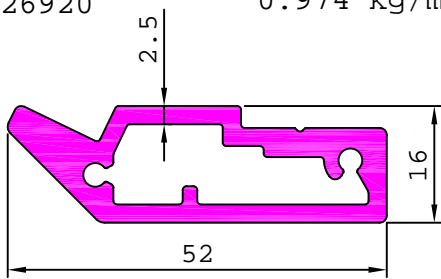

26917

0.818 kg/m

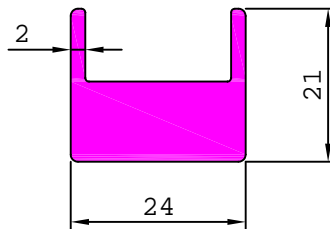

26921

0.124 kg/m

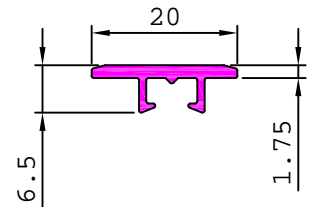

26923

0.084 kg/m

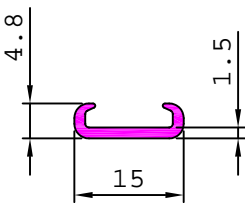

26924

11.619 kg/m

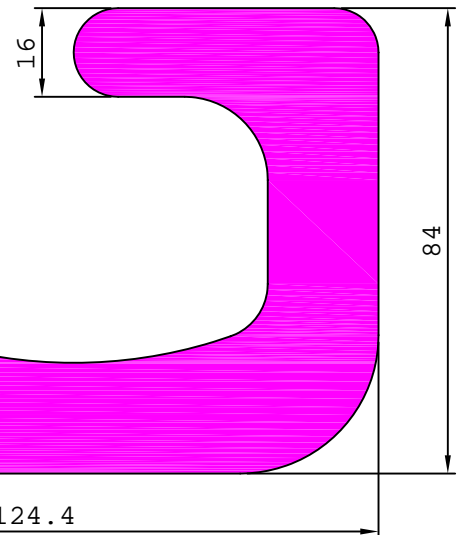

26926

0.760 kg/m

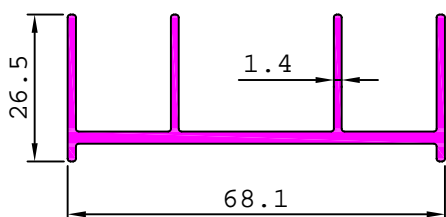

INDUSTRIAL

REFRIGERATION SECTION

26927

0.561 kg/m

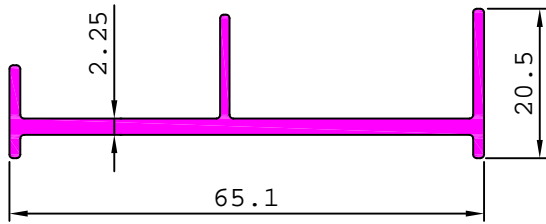

26928

0.561 kg/m

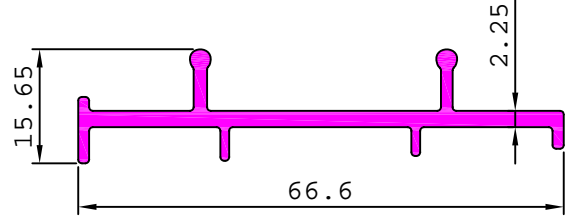

26929

0.709 kg/m

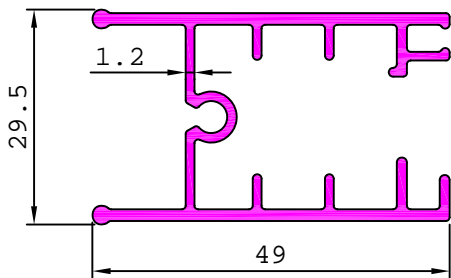

26930

0.344 kg/m

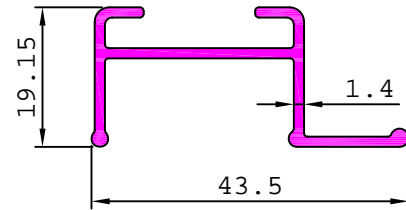

26931

0.279 kg/m

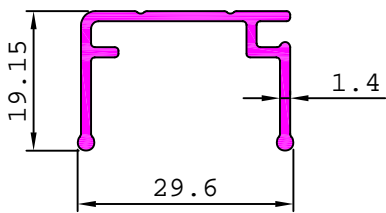

26934

0.377 kg/m

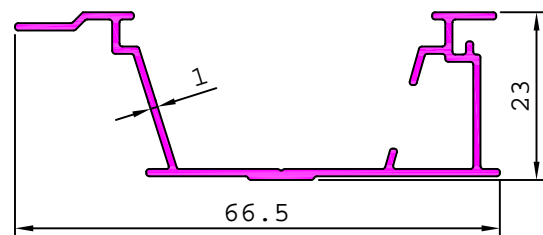

26932

0.510 kg/m

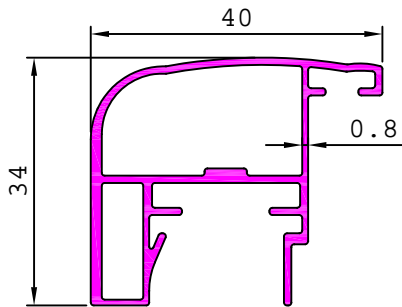

26933

0.673 kg/m

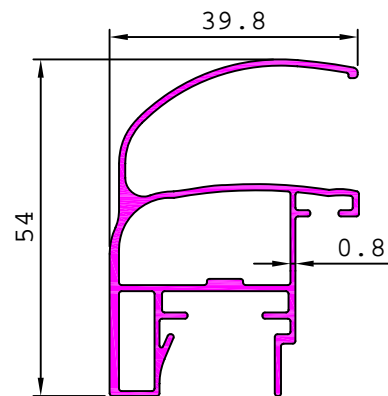

26935

0.949 kg/m

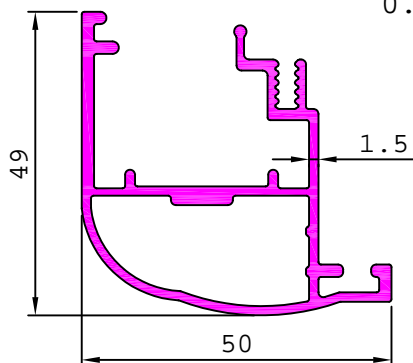

26936

0.658 kg/m

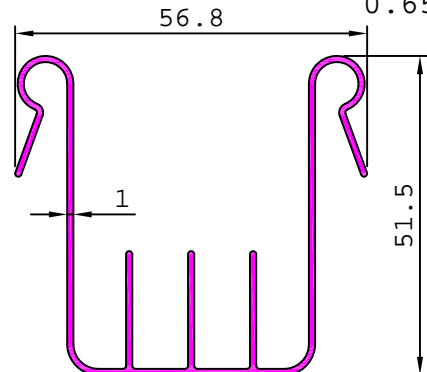

INDUSTRIAL

PUMP BODY AND ACTUATOR BODY

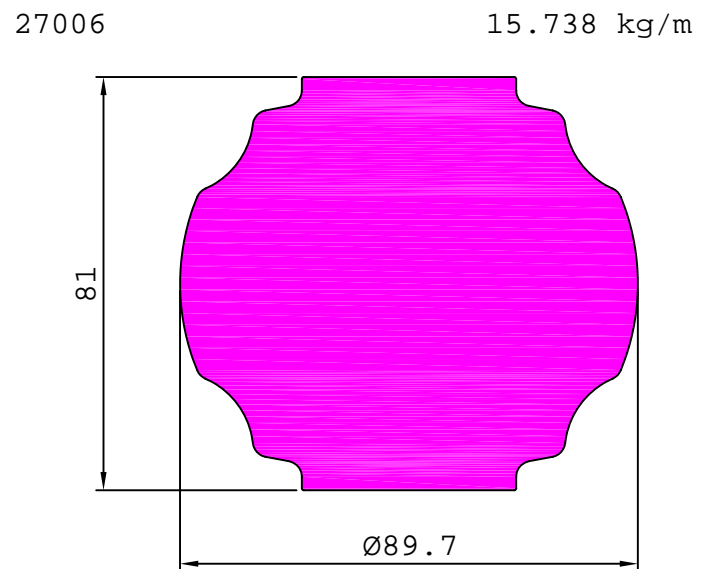
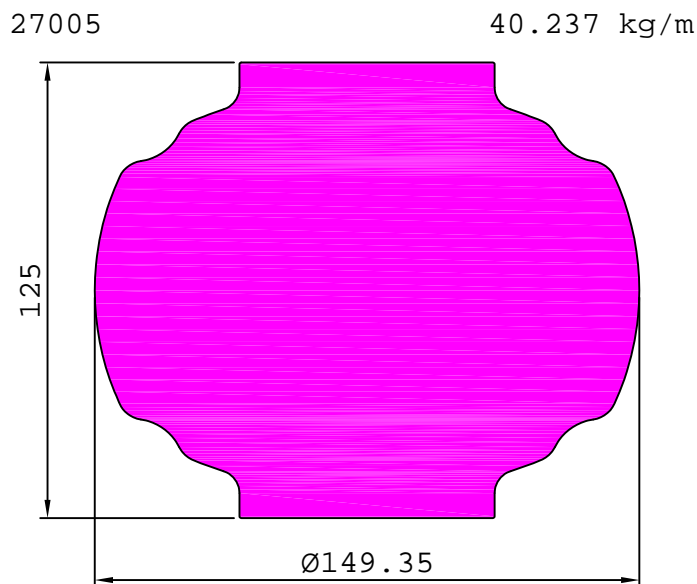
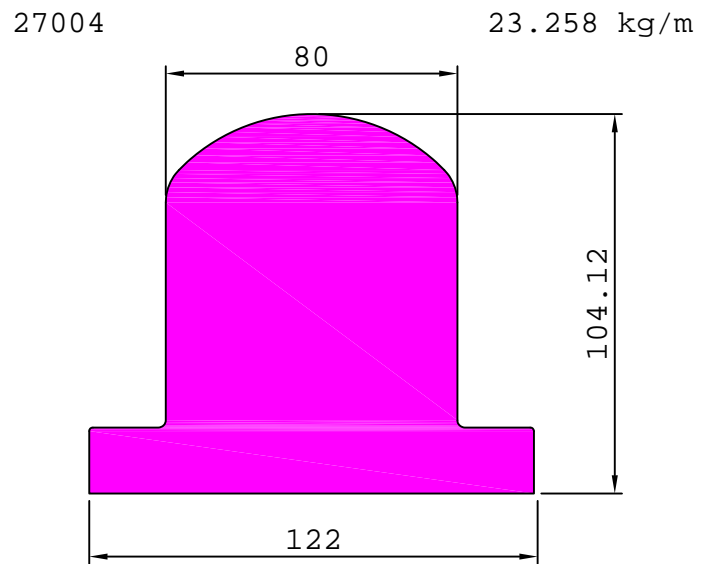
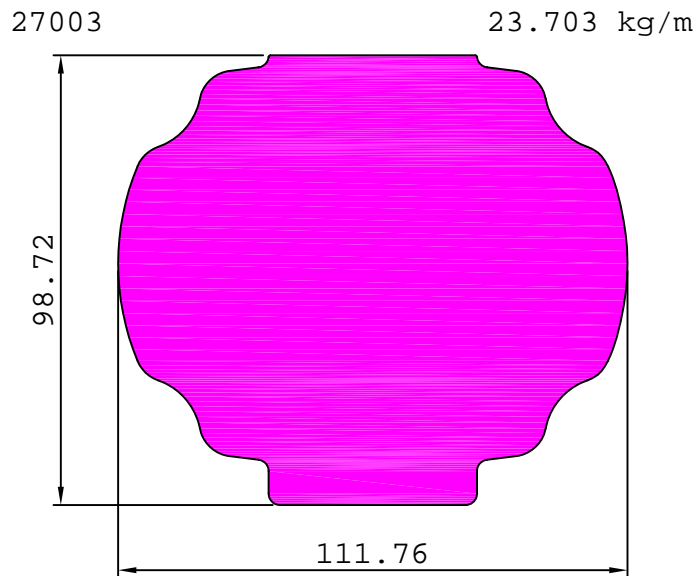
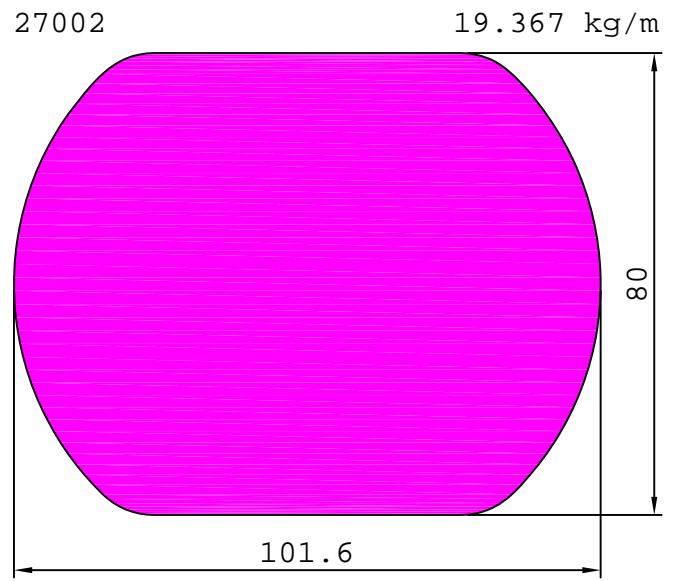
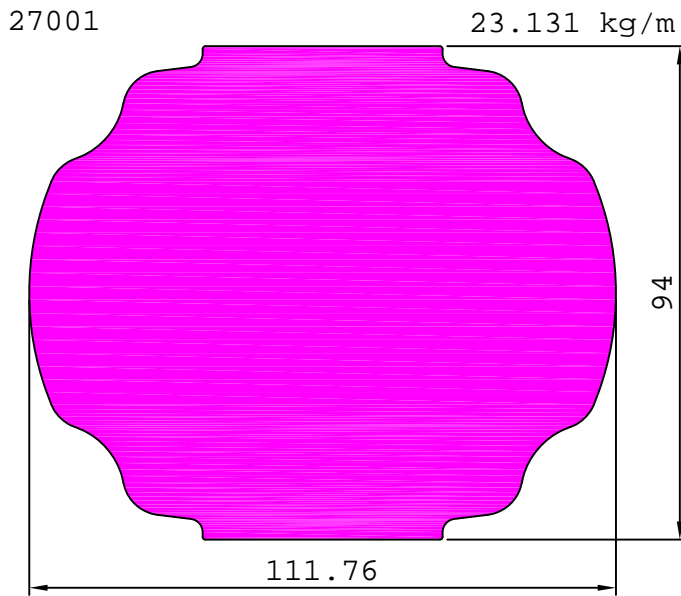

INDUSTRIAL

PUMP BODY AND ACTUATOR BODY

27007 20.000 kg/m

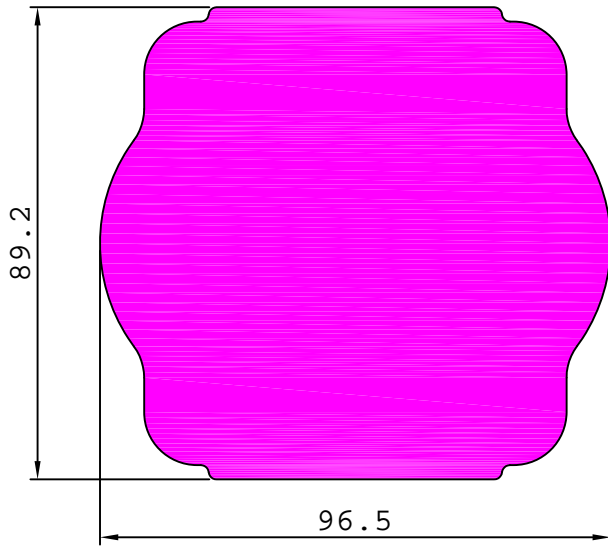

27009 10.162 kg/m

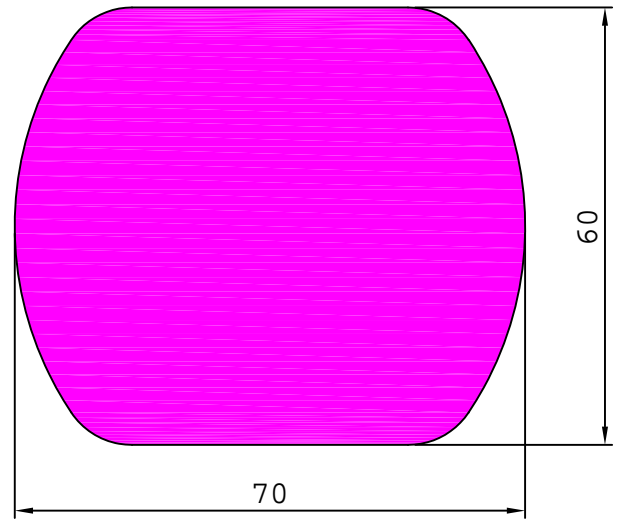

27011 11.371 kg/m

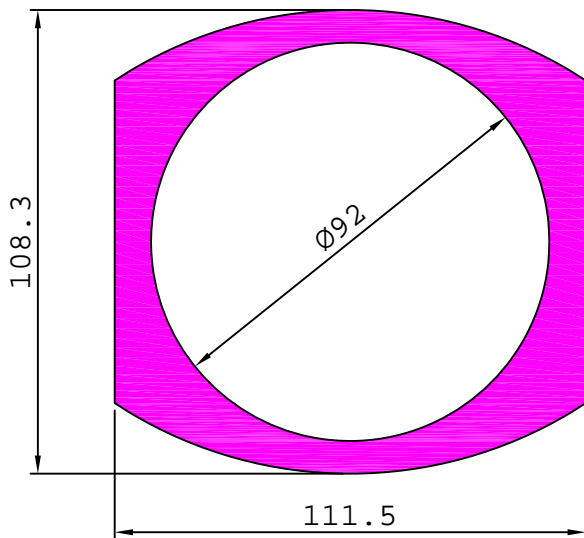

27012 20.000 kg/m

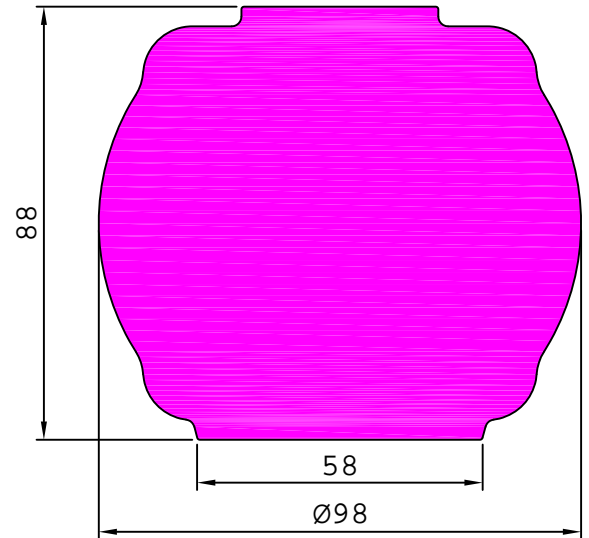

27013 59.222 kg/m

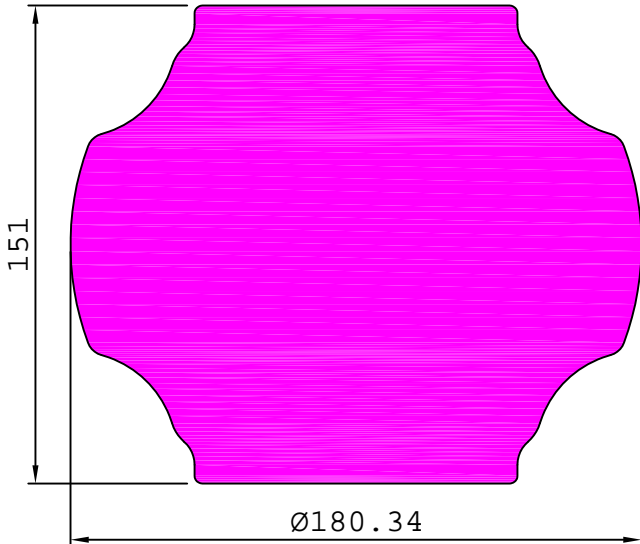

27014 14.927 kg/m

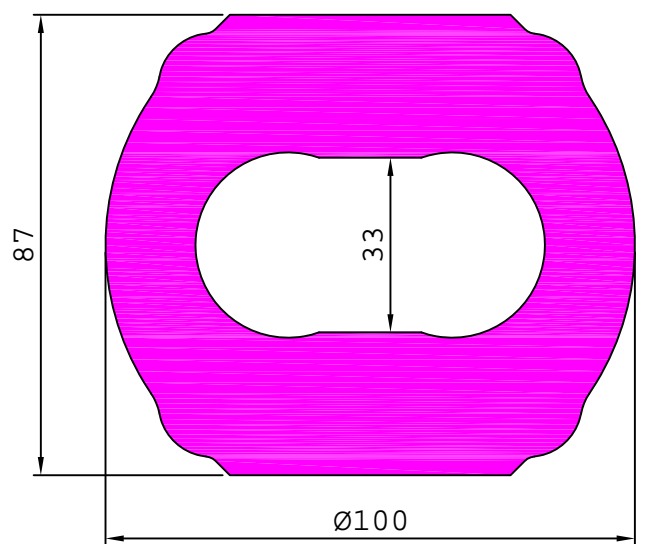

INDUSTRIAL

PUMP BODY AND ACTUATOR BODY

27016 16.635 kg/m

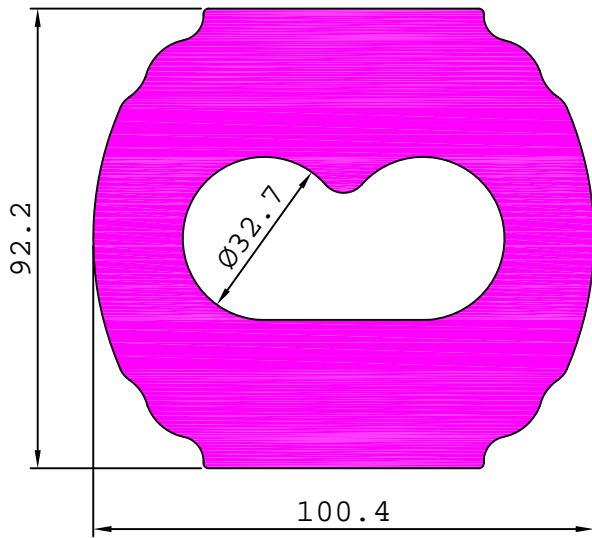

27017 20.418 kg/m

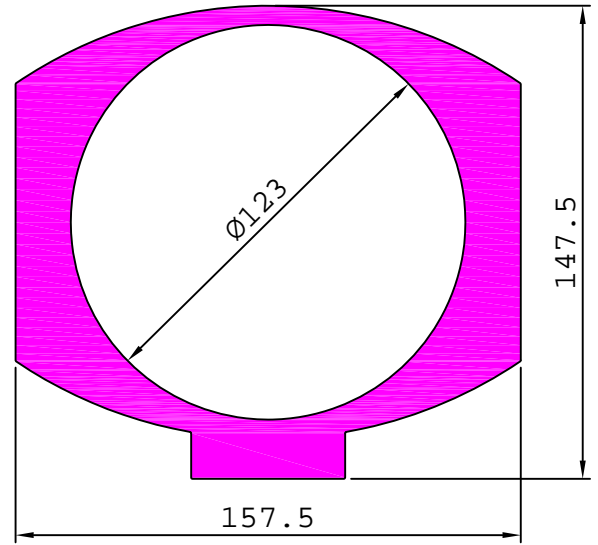

27018 30.136 kg/m

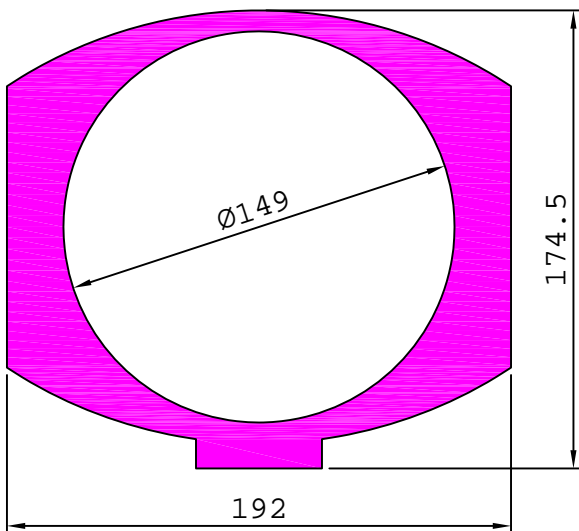

27019 21.513 kg/m

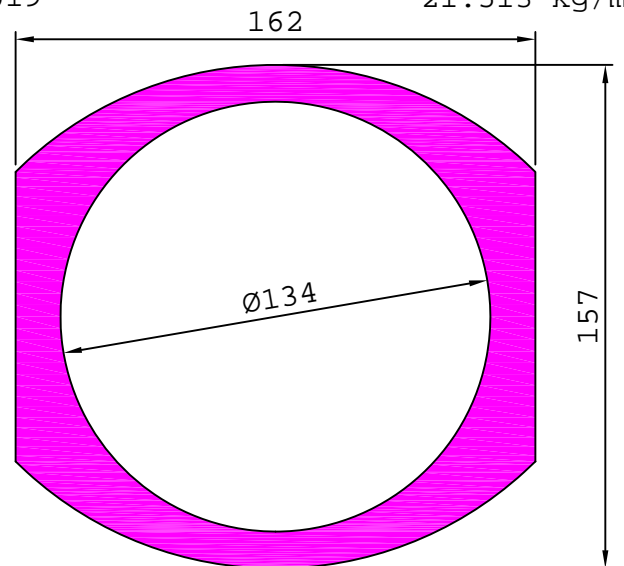

27021 11.525 kg/m

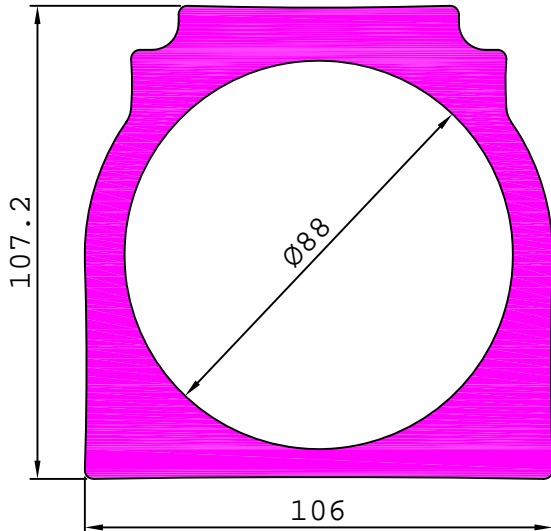

27022 7.885 kg/m

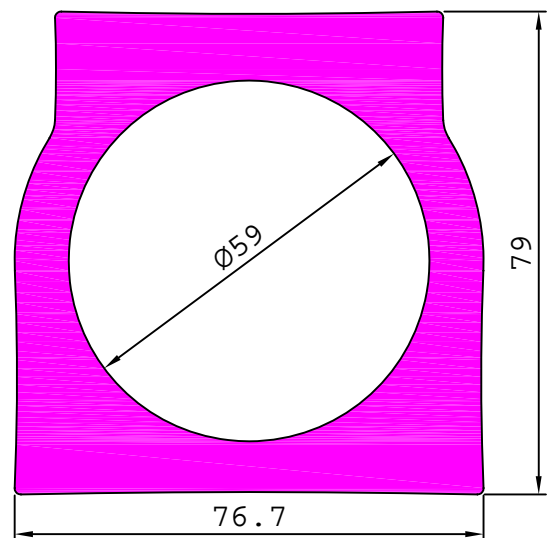

INDUSTRIAL

PUMP BODY AND ACTUATOR BODY

27020 17.077 kg/m

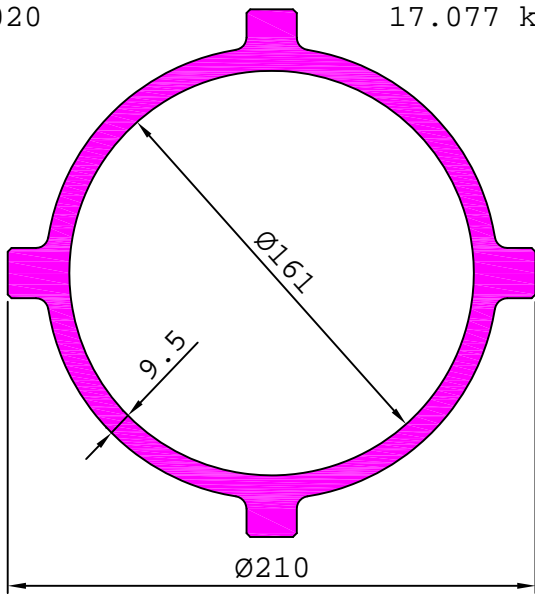

27024 15.030 kg/m

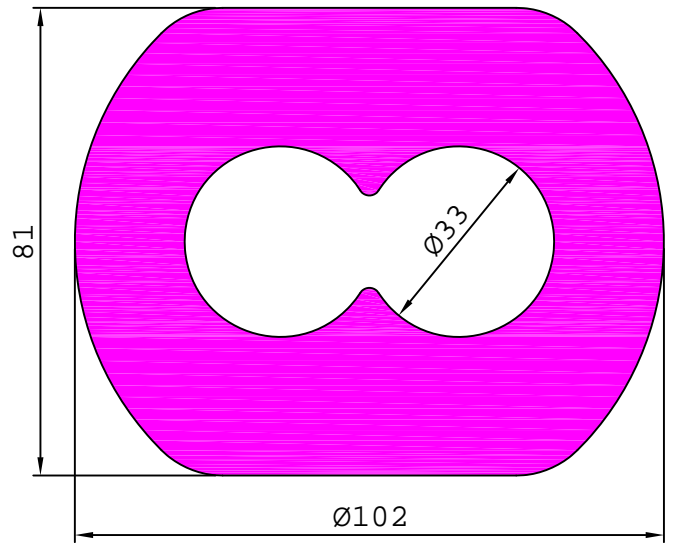

27028 21.660 kg/m

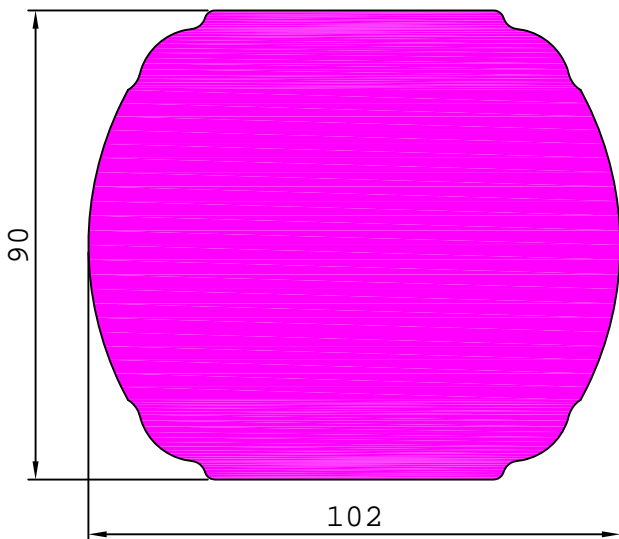

27029 16.201 kg/m

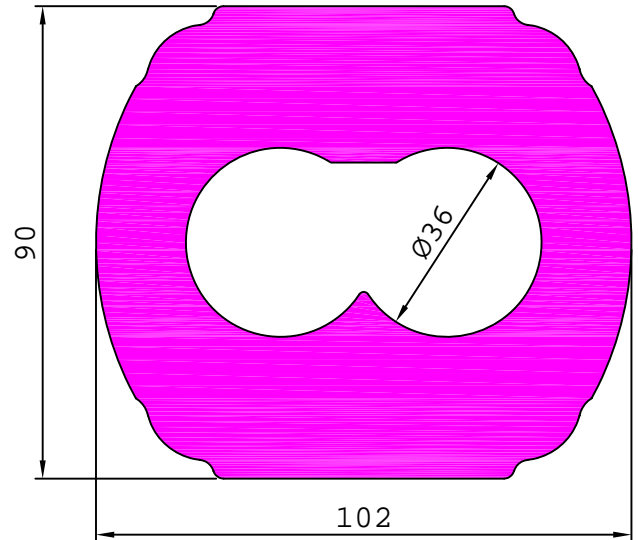

27031 14.397 kg/m

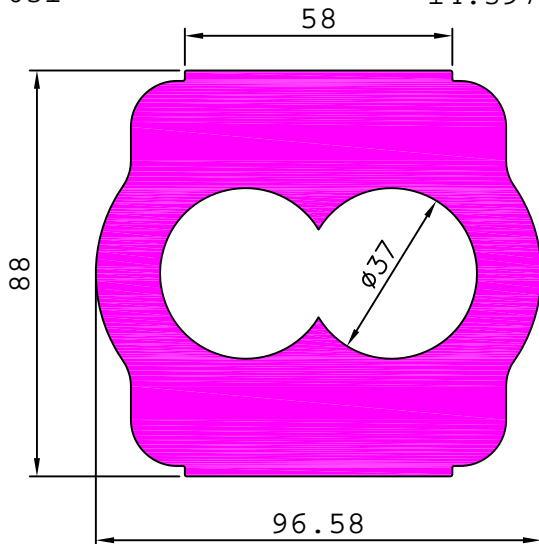

27035 22.898 kg/m

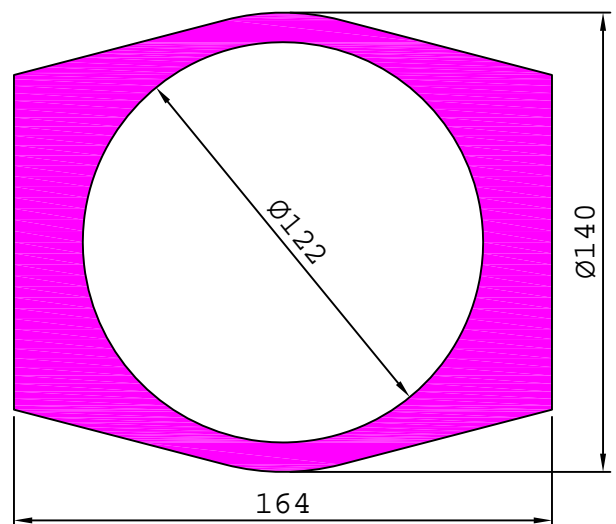

INDUSTRIAL

PUMP BODY AND ACTUATOR BODY

27036

20.311 kg/m

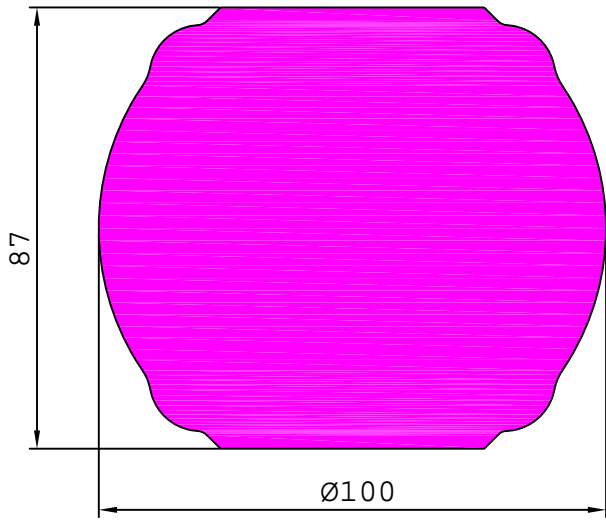

27037

35.514 kg/m

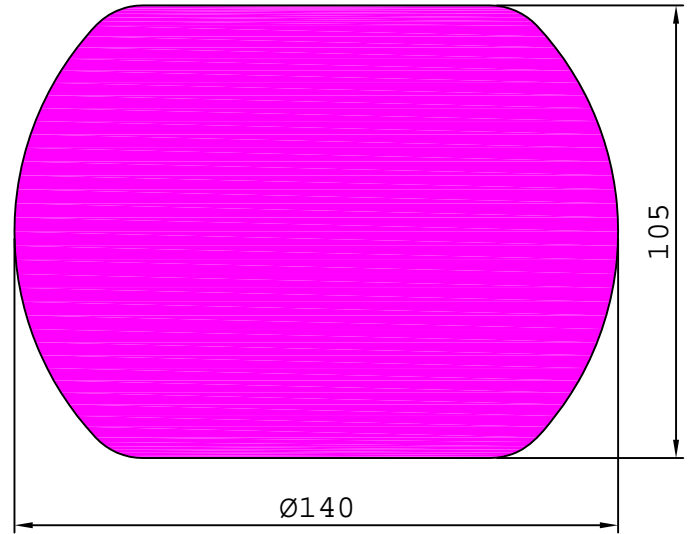

27039

16.904 kg/m

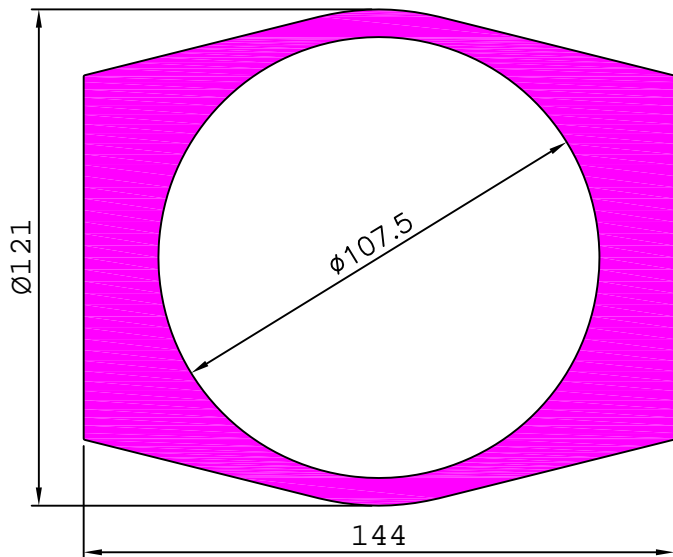

27041

11.246 kg/m

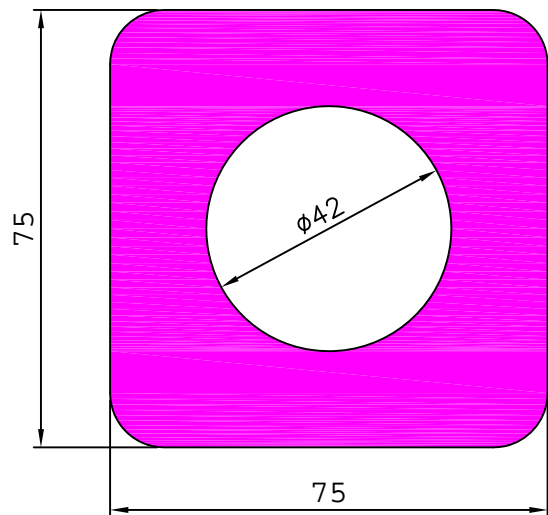

27043

8.956 kg/m

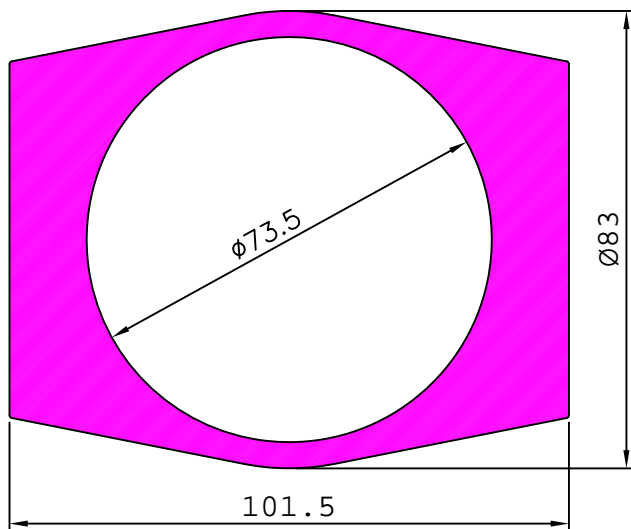

27044

10.574 kg/m

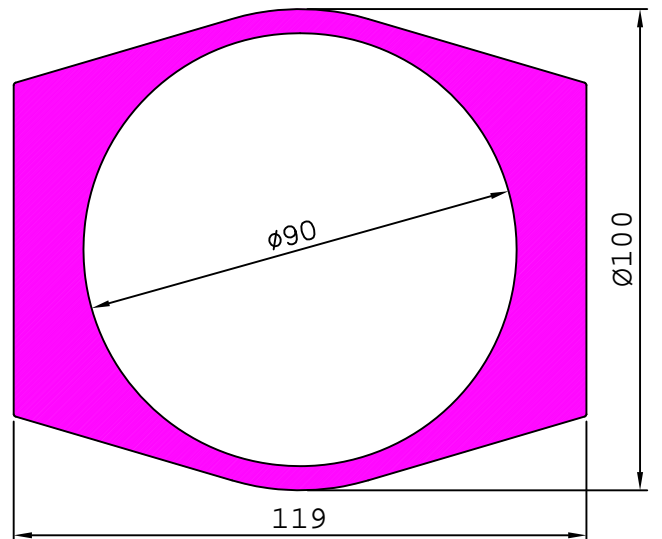

INDUSTRIAL

PUMP BODY AND ACTUATOR BODY

27045 9.431 kg/m

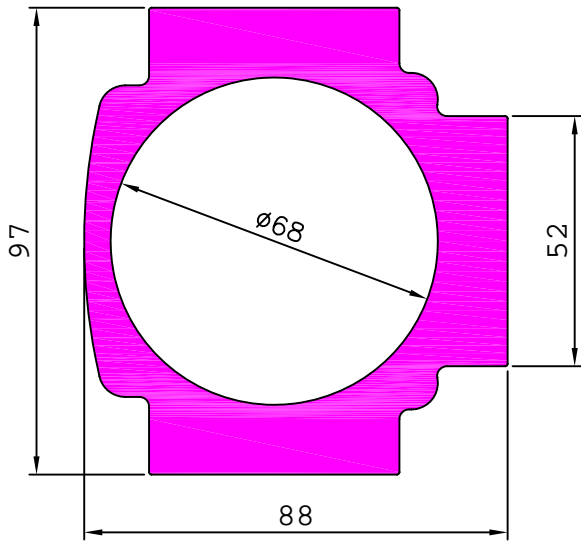

27046 12.740 kg/m

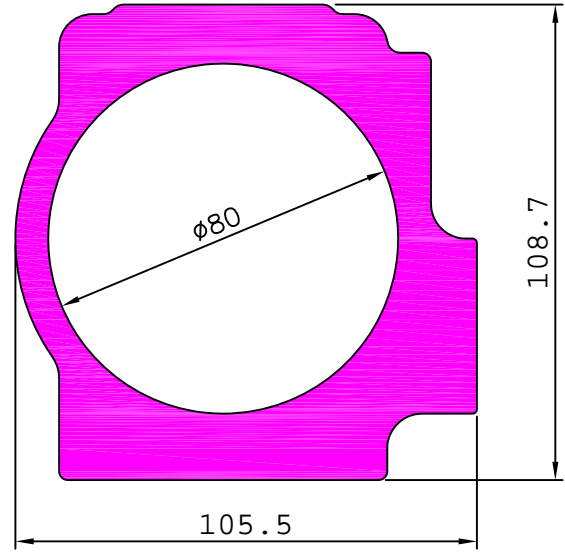

27047 16.016 kg/m

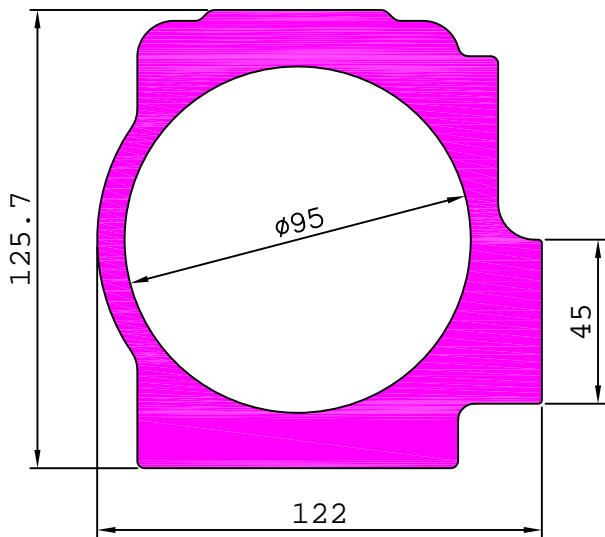

27052 11.612 kg/m

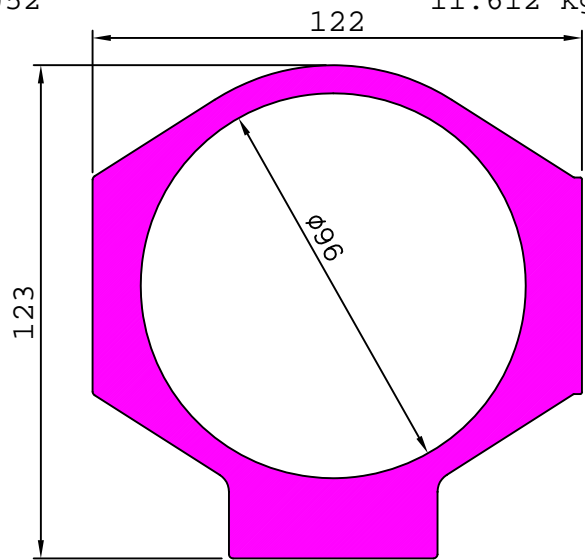

27053 7.856 kg/m

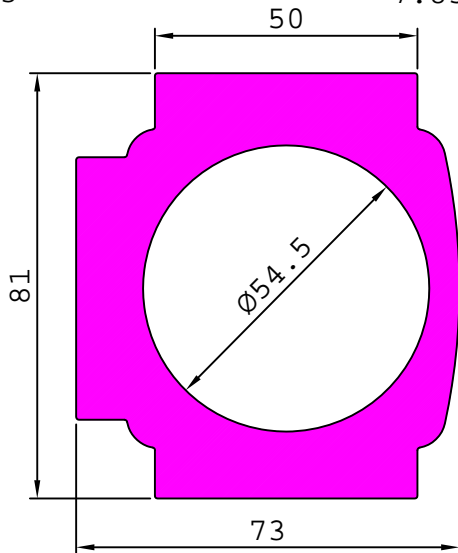

27054 22.303 kg/m

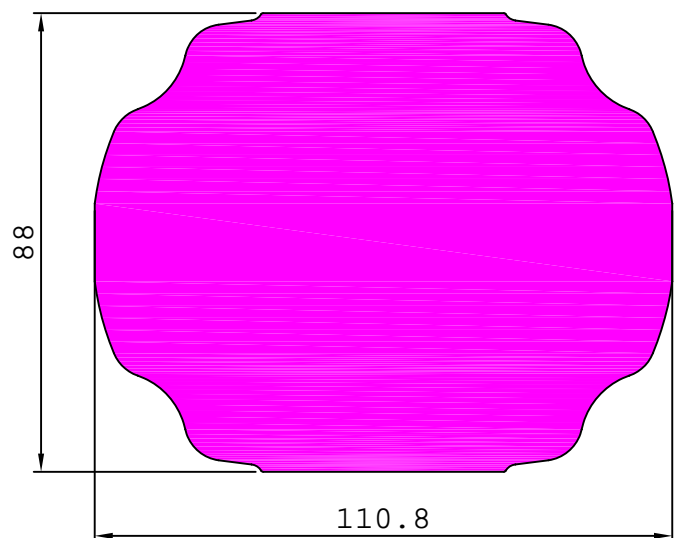

INDUSTRIAL

PUMP BODY AND ACTUATOR BODY

27057 33.495 kg/m

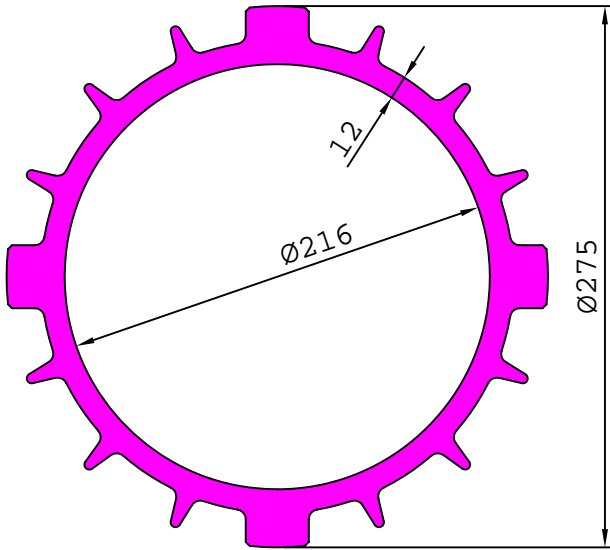

27058 14.519 kg/m

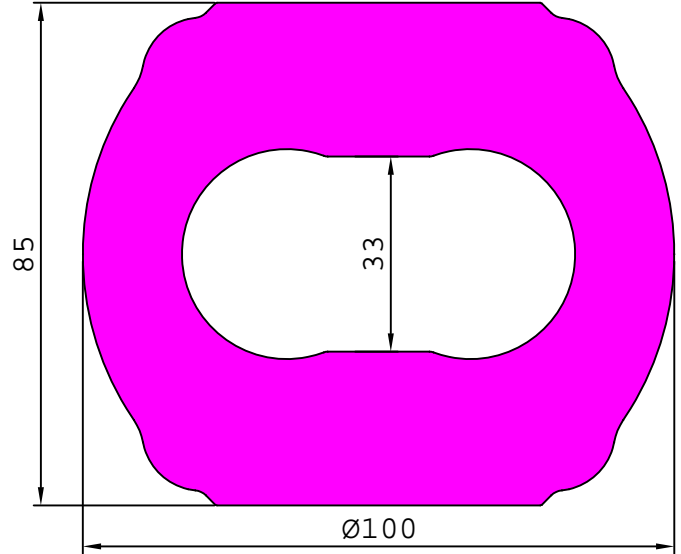

27061 14.402 kg/m

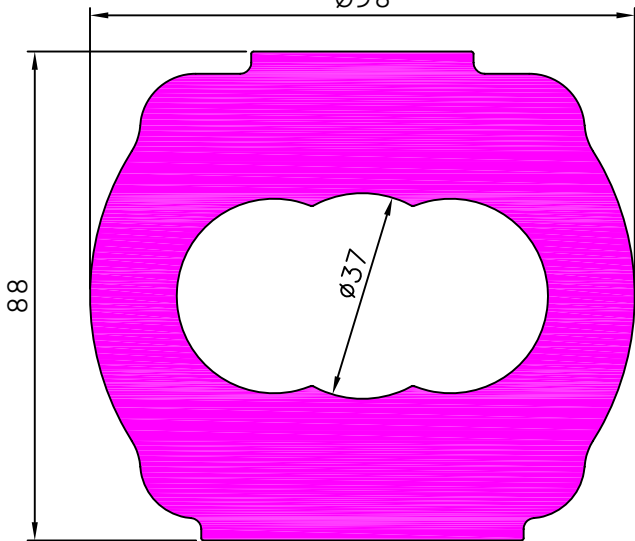

27062 19.810 kg/m

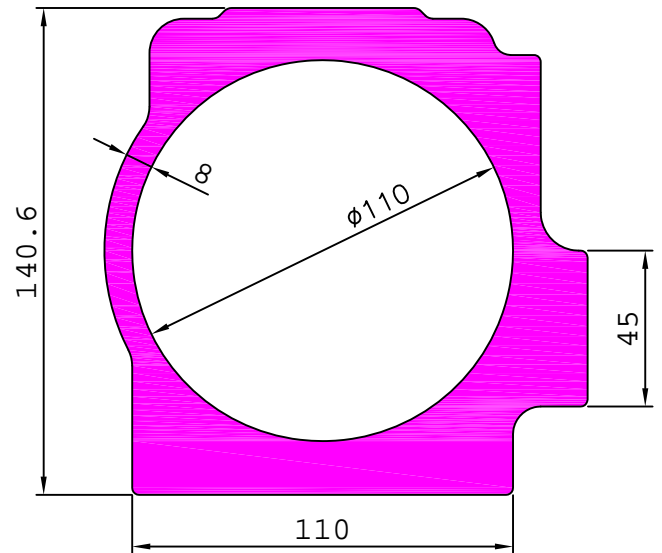

27065 39.094 kg/m

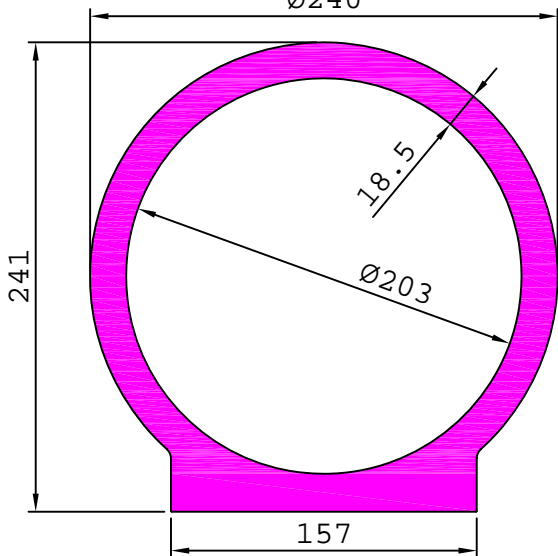

27067 16.926 kg/m

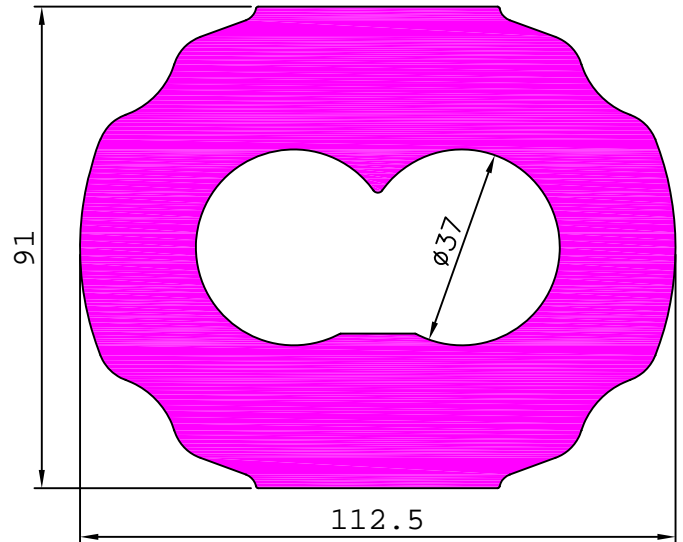

INDUSTRIAL

PUMP BODY AND ACTUATOR BODY

27068 36.351 kg/m

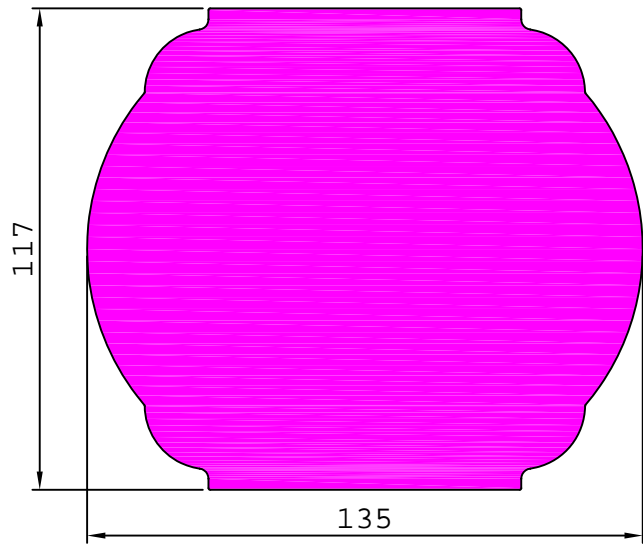

27069 21.244 kg/m

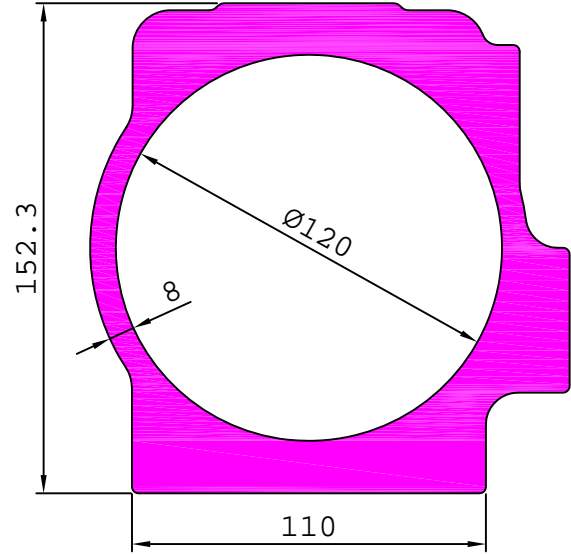

27070 46.544 kg/m

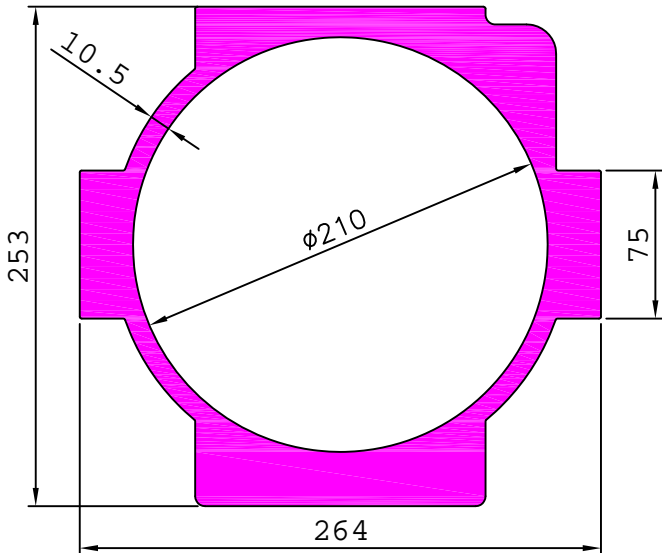

27071 23.574 kg/m

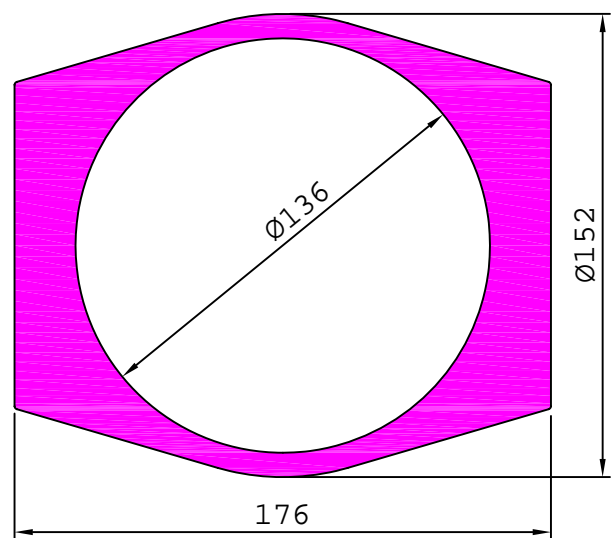

27072 32.065 kg/m

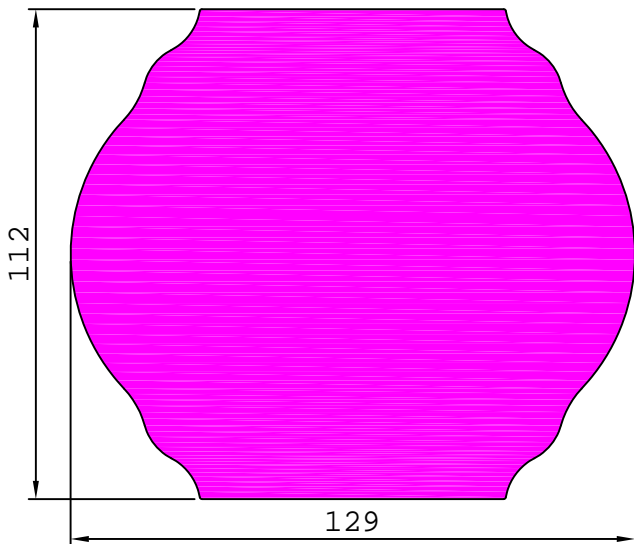

27074 49.276 kg/m

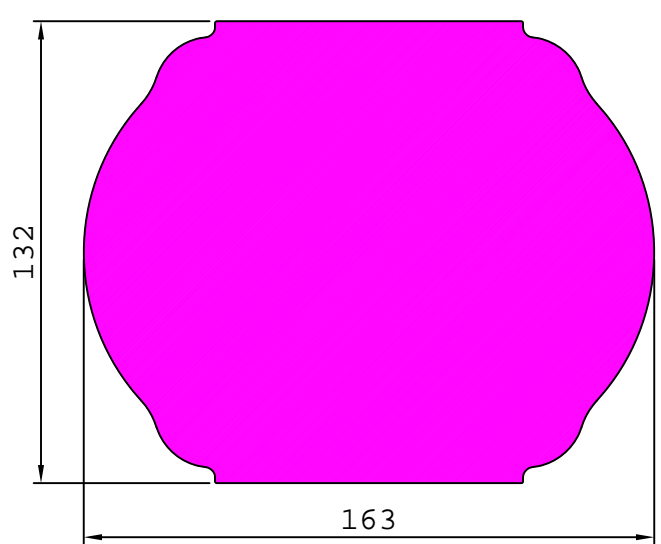

INDUSTRIAL

PUMP BODY AND ACTUATOR BODY

27075 9.297 kg/m

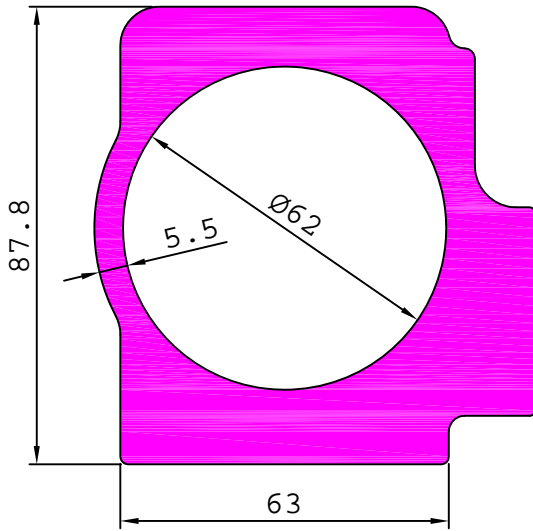

27076 9.985 kg/m

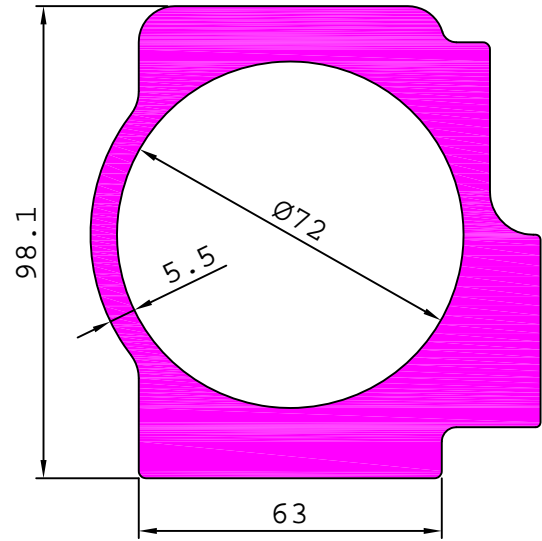

27077 15.138 kg/m

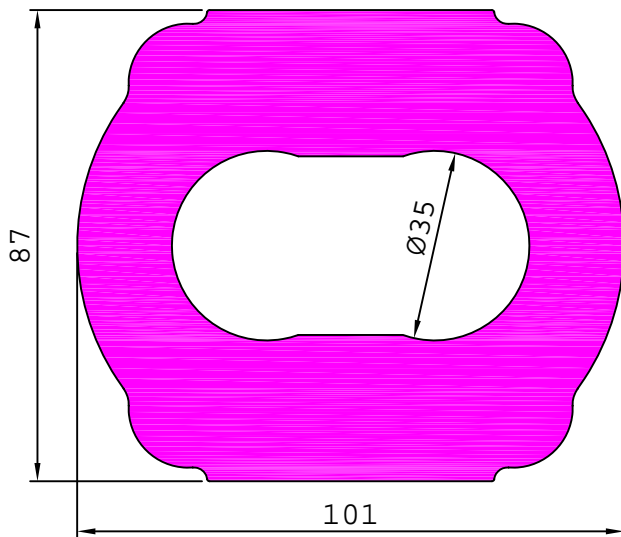

27078 28.507 kg/m

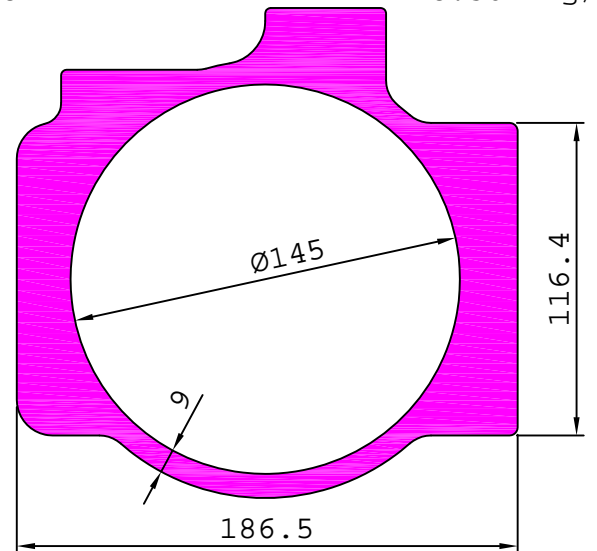

27079 9.773 kg/m

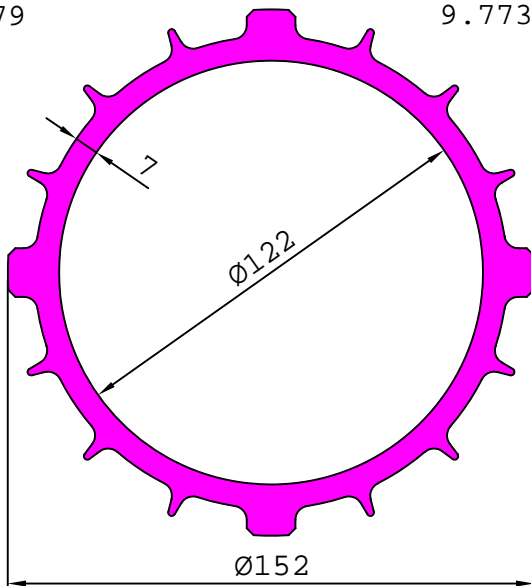

27080 17.829 kg/m

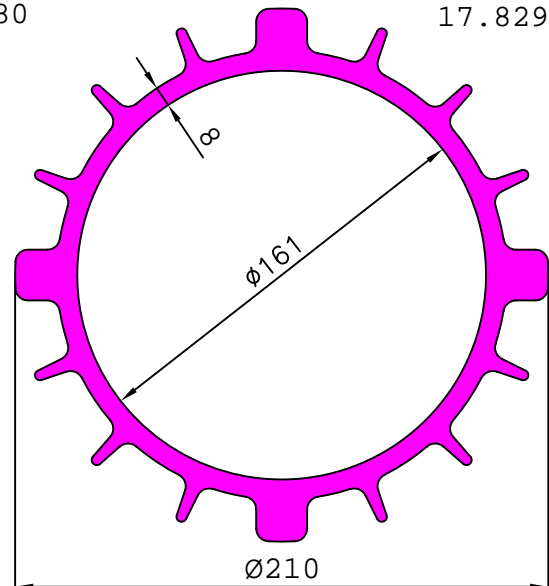

INDUSTRIAL

PUMP BODY AND ACTUATOR BODY

27081 13.529 kg/m

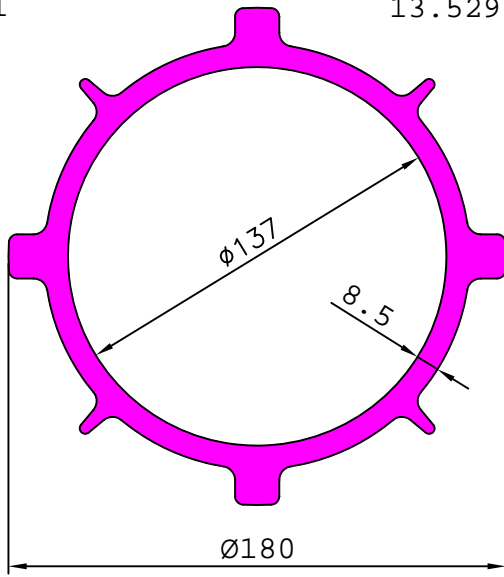

27082 36.225 kg/m

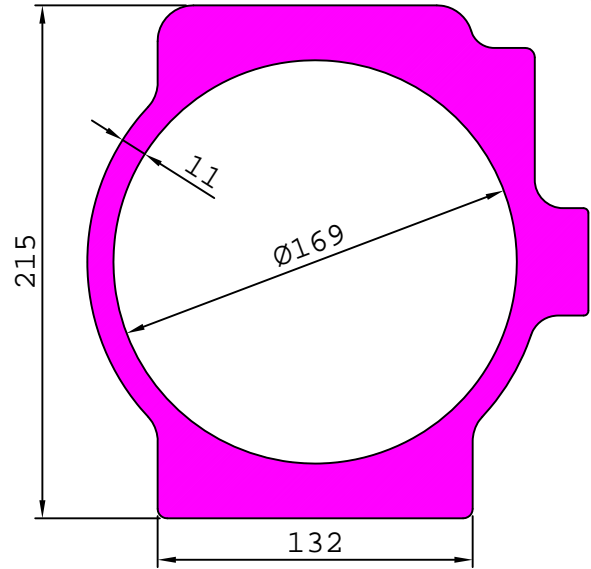

27083 47.807 kg/m

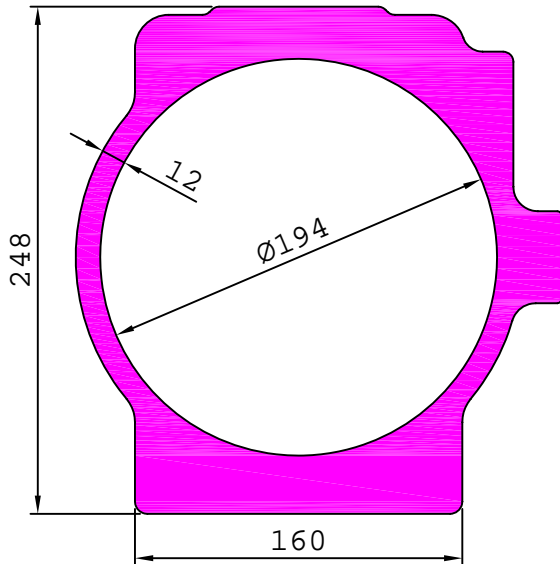

27084 26.306 kg/m

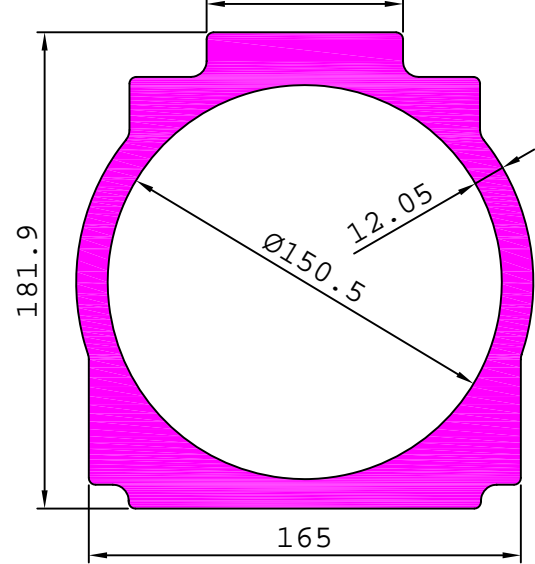

27085 32.964 kg/m

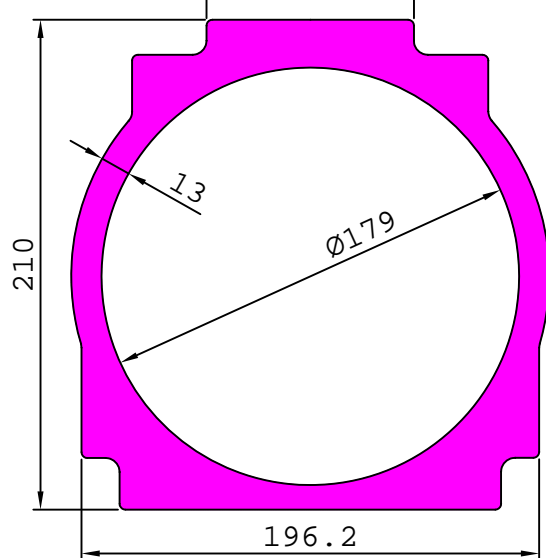

27086 15.511 kg/m

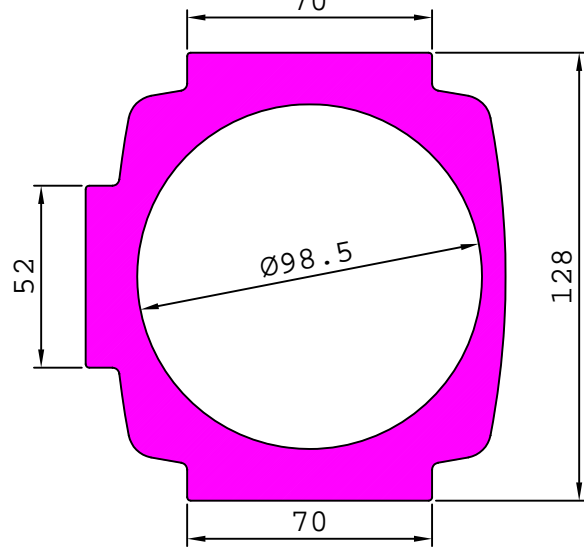

INDUSTRIAL

PUMP BODY AND ACTUATOR BODY

27088 75 11.526 kg/m

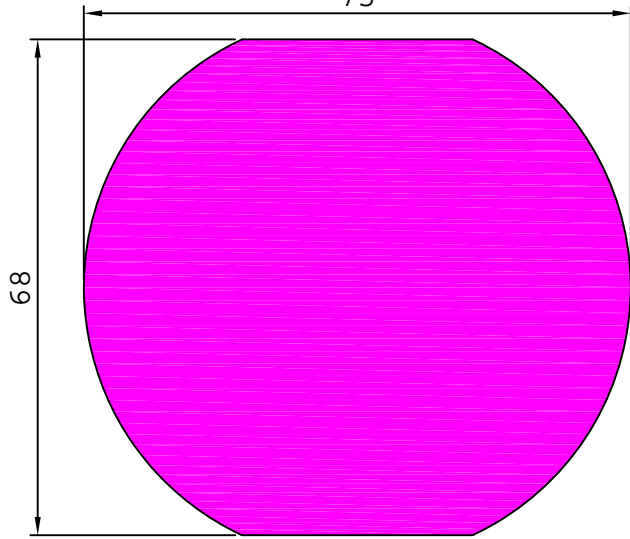

27089 20.691 kg/m

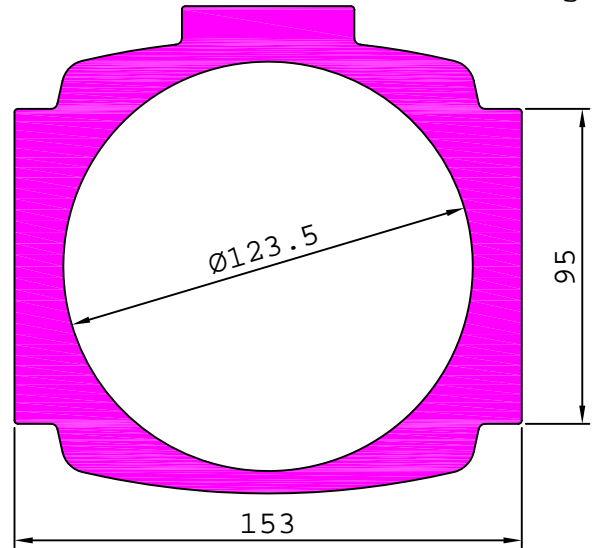

27090 22.066 kg/m

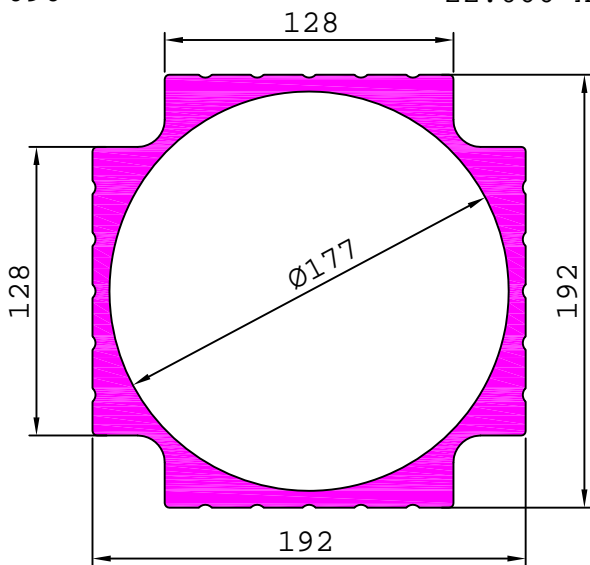

27091 22.536 kg/m

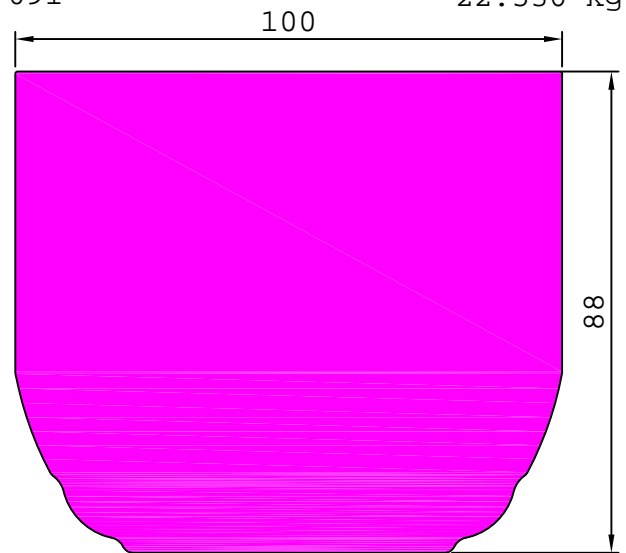

27092 19.703 kg/m

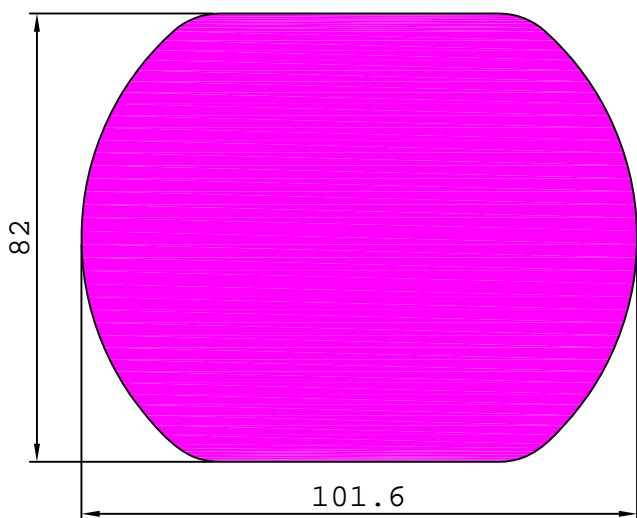

27093 20.425 kg/m

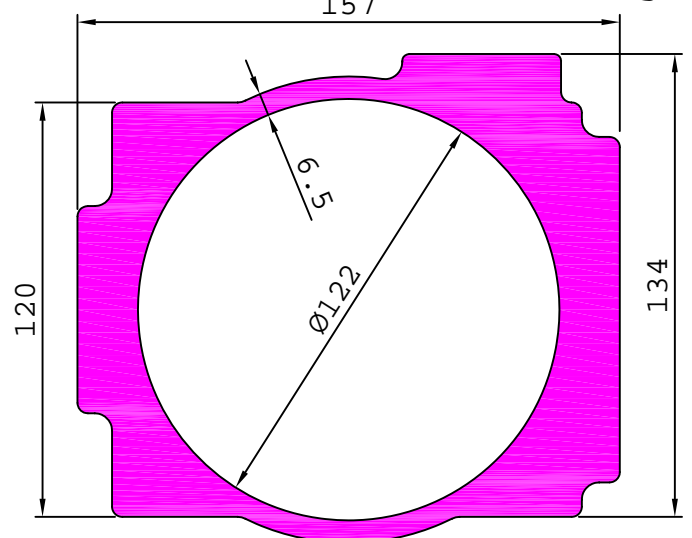

INDUSTRIAL

PUMP BODY AND ACTUATOR BODY

27094 22.219 kg/m

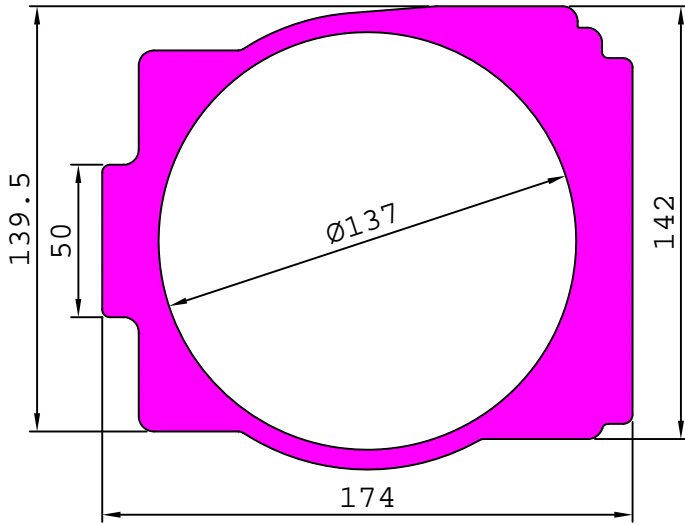

27095 16.295 kg/m

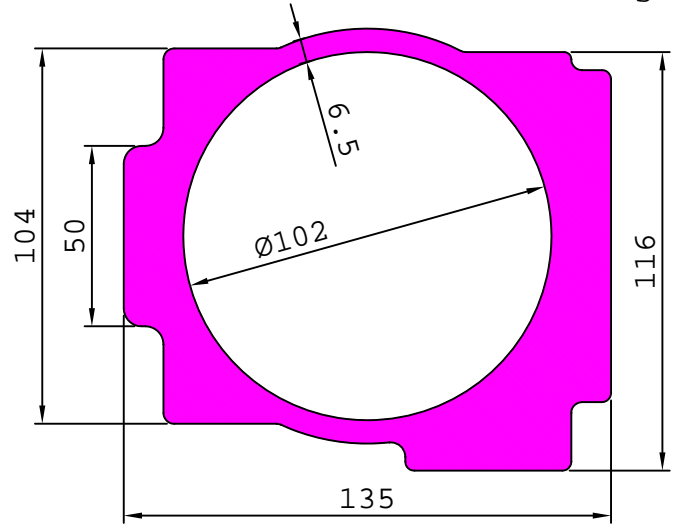

27096 39.604 kg/m

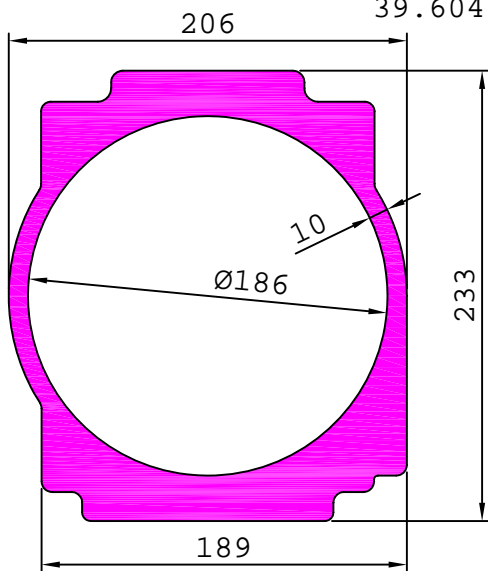

27097 28.980 kg/m

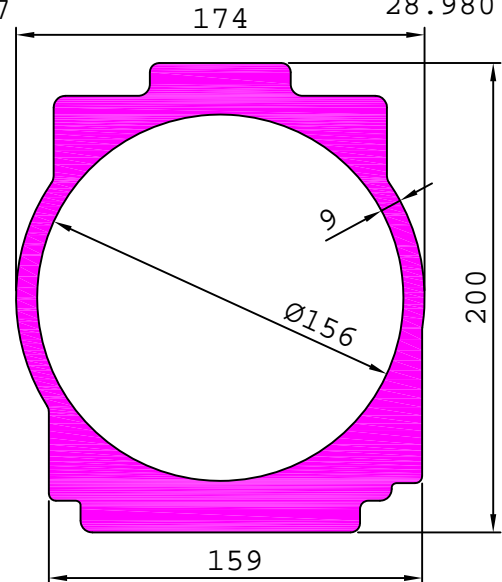

27098 47.180 kg/m

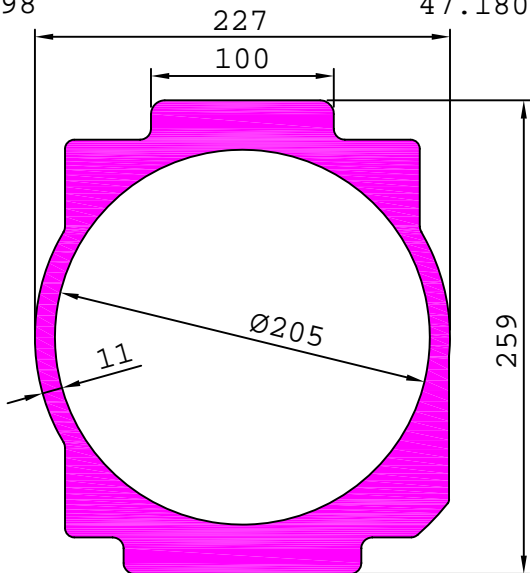

27099 6.523 kg/m

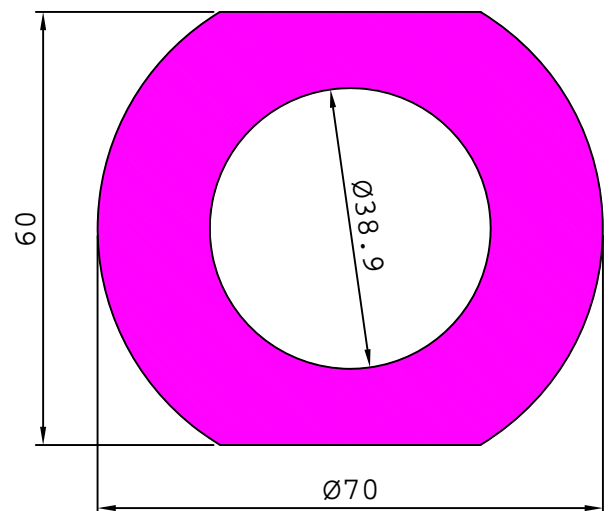

INDUSTRIAL

PUMP BODY AND ACTUATOR BODY

27100 22.548 kg/m

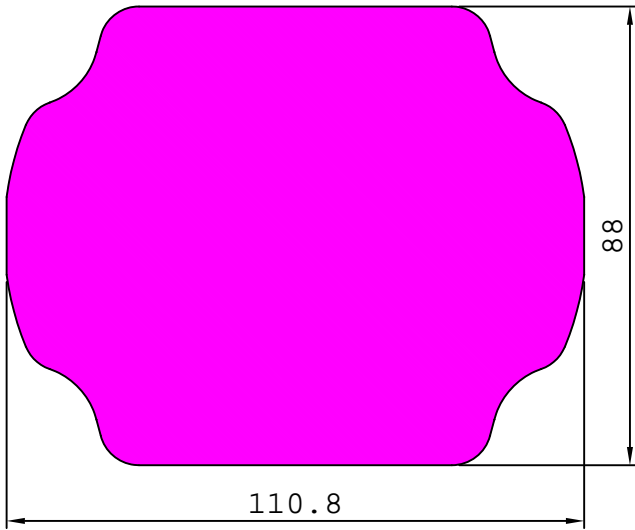

27101 4.680 kg/m

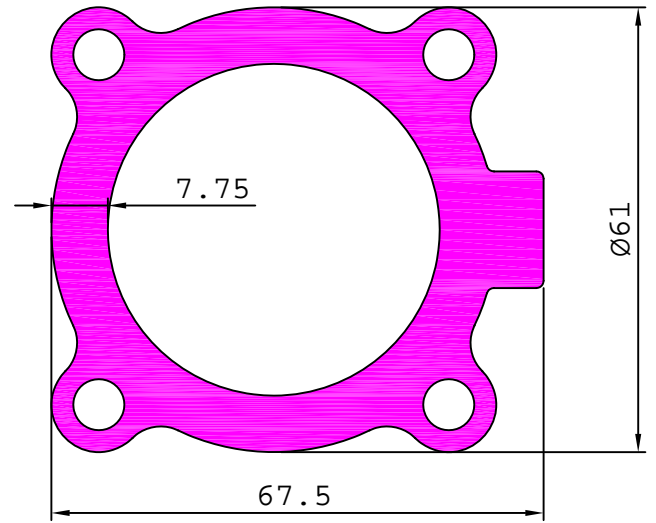

27102 5.361 kg/m

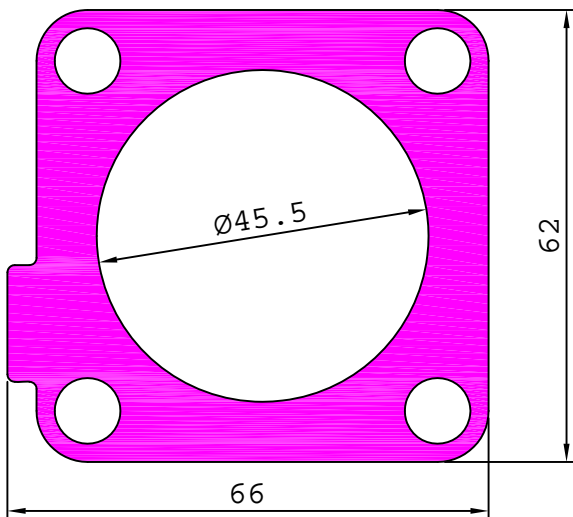

27103 8.147 kg/m

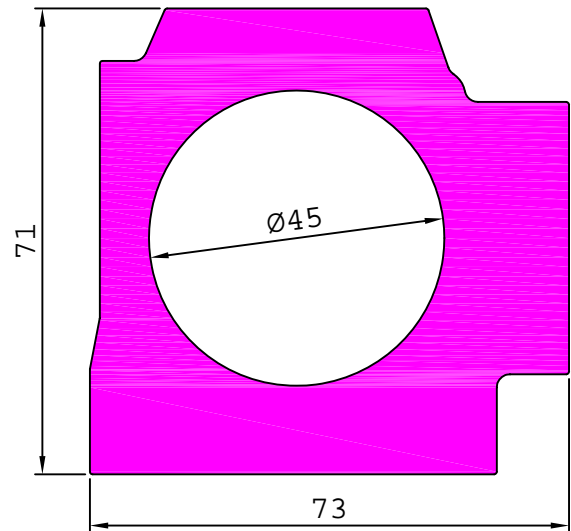

27104 10.366 kg/m

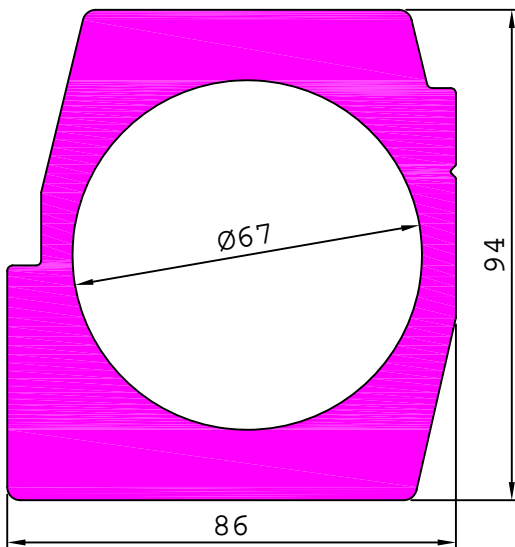

27105 11.050 kg/m

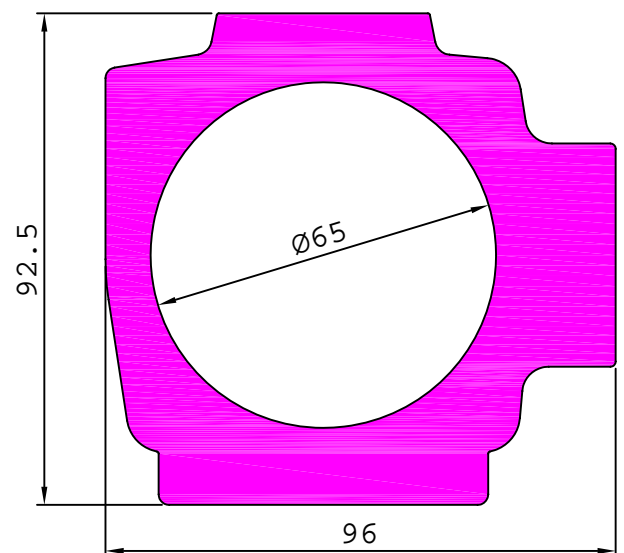

INDUSTRIAL

PUMP BODY AND ACTUATOR BODY

27106

73.151 kg/m

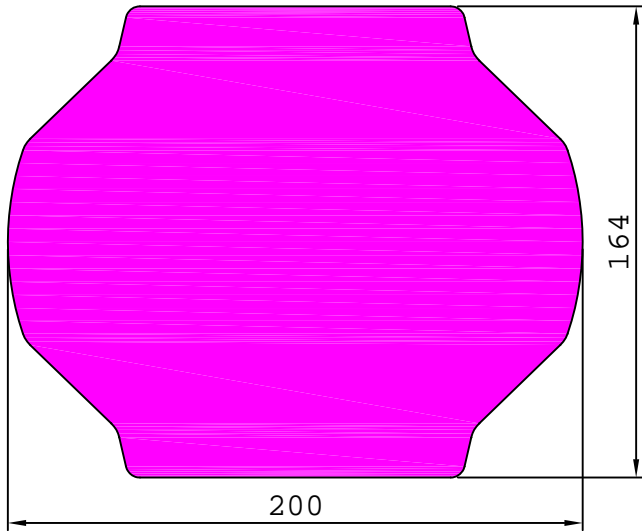

27107

4.770 kg/m

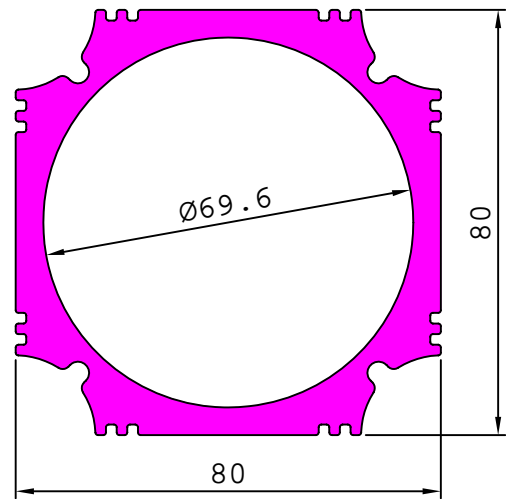

27108

3.717 kg/m

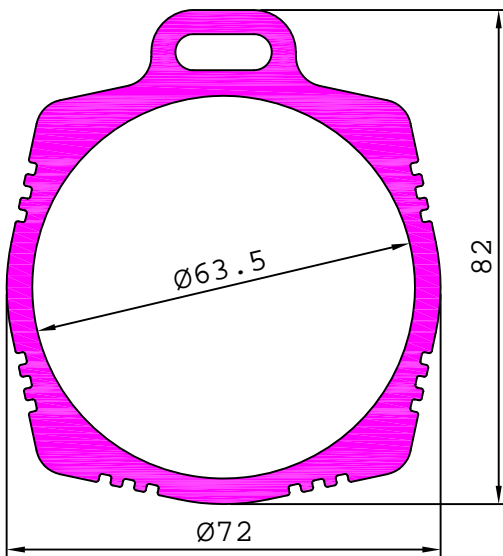

27109

5.362 kg/m

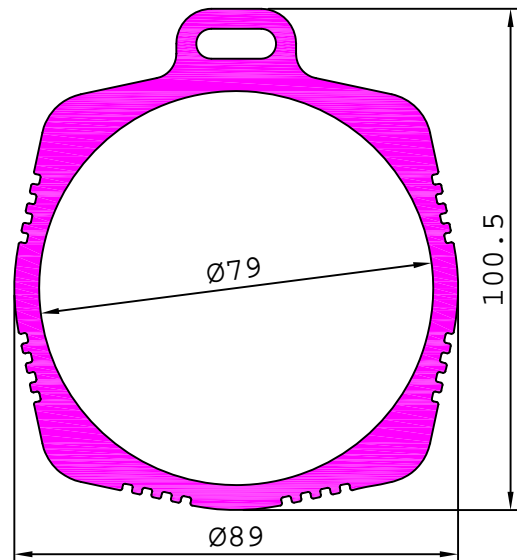

27110

12.123 kg/m

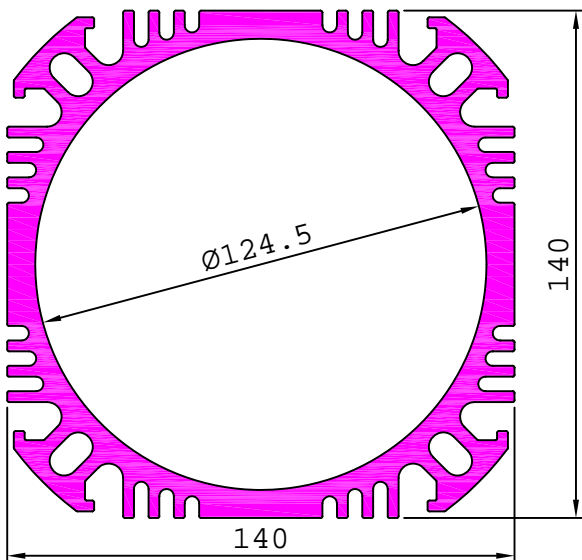

27111

6.022 kg/m

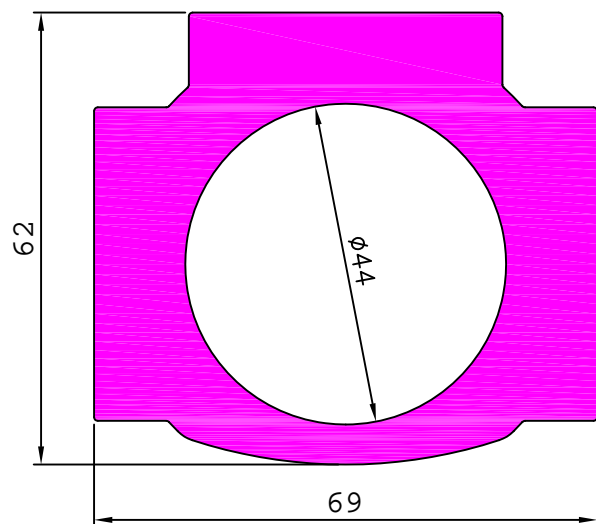

INDUSTRIAL

PUMP BODY AND ACTUATOR BODY

27112

11.910 kg/m

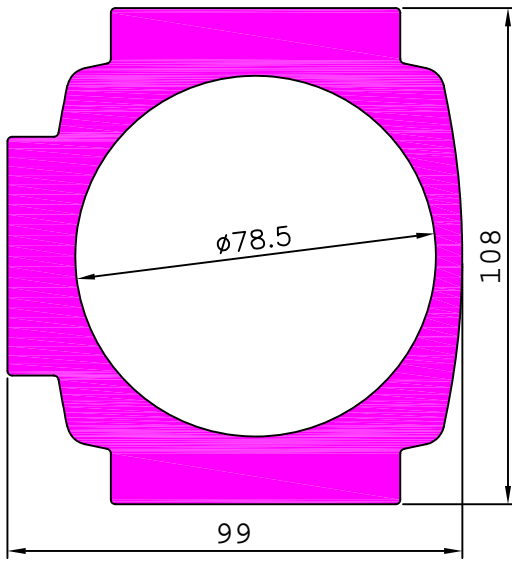

27114

20.211 kg/m

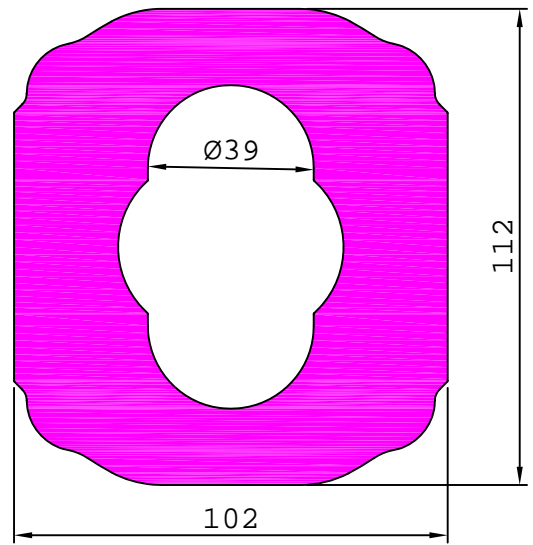

27115

32.875 kg/m

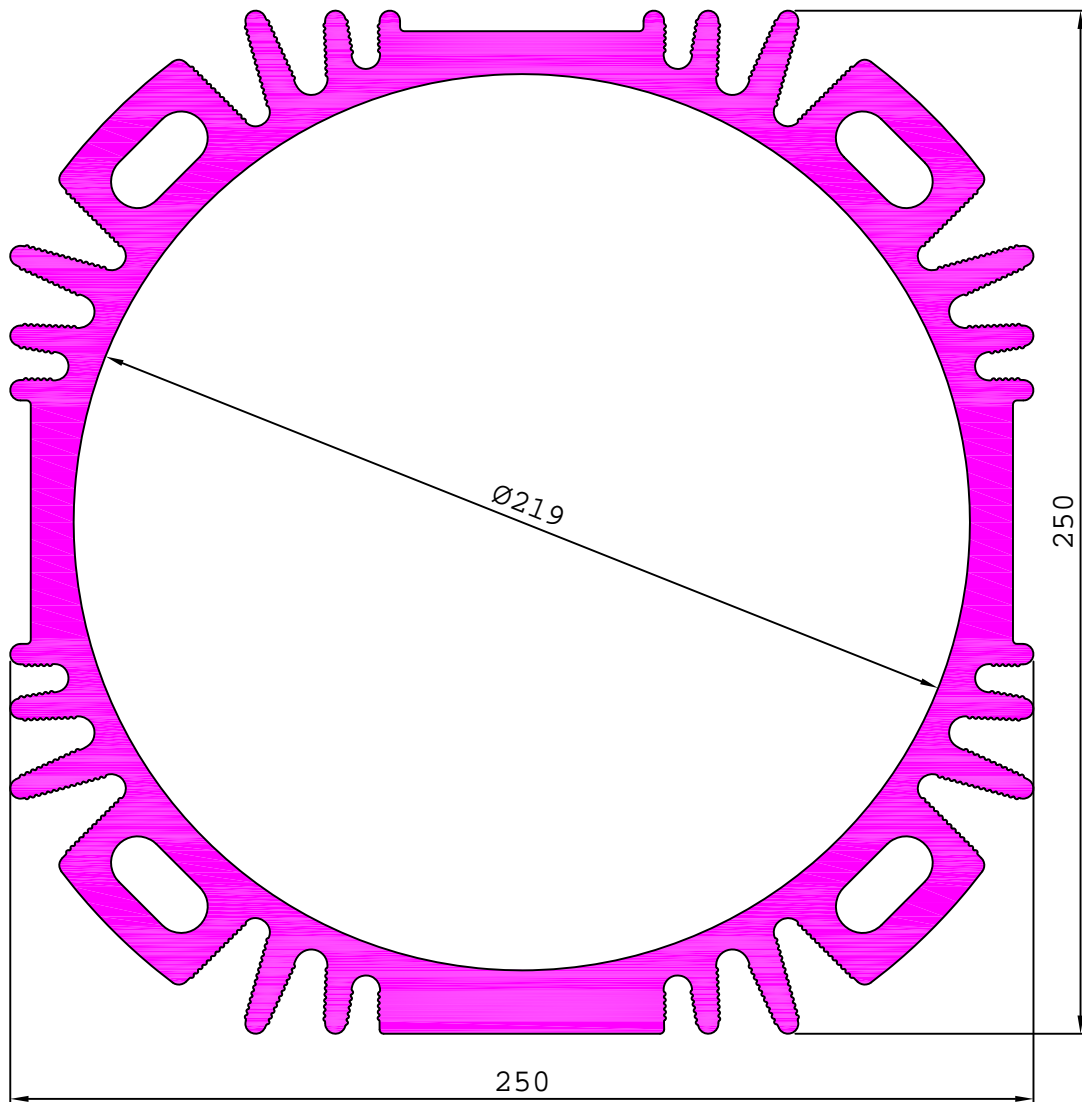

INDUSTRIAL

PUMP BODY AND ACTUATOR BODY

27116 24.069 kg/m

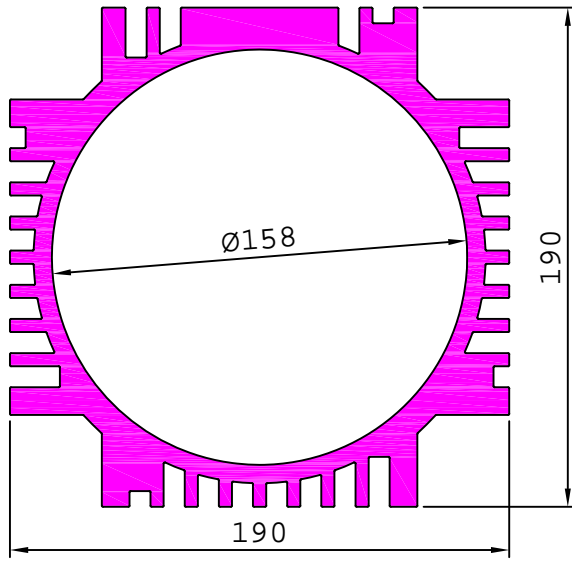

27117 21.785 kg/m

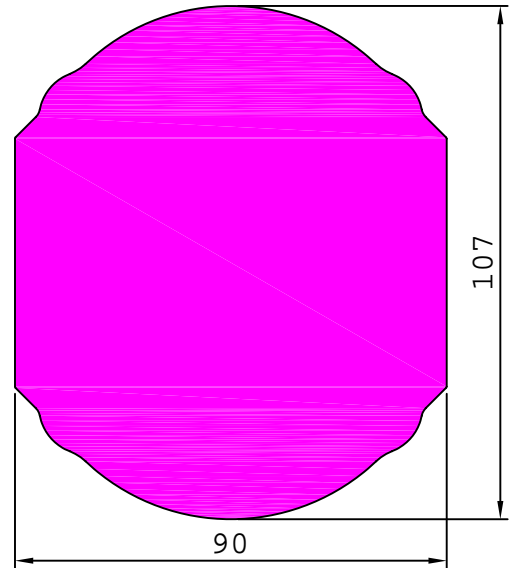

27118 7.598 kg/m

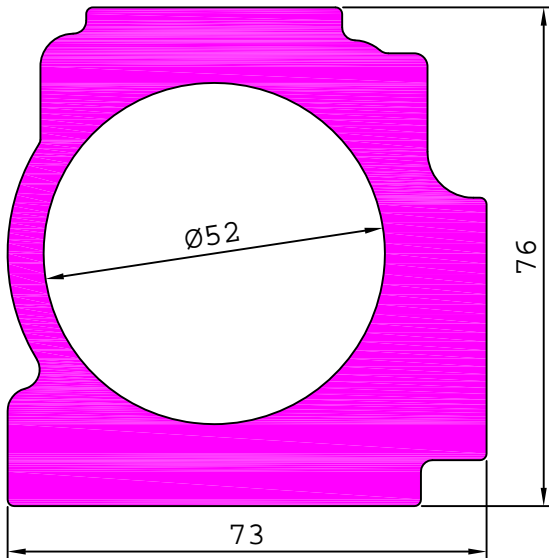

27119 17.105 kg/m

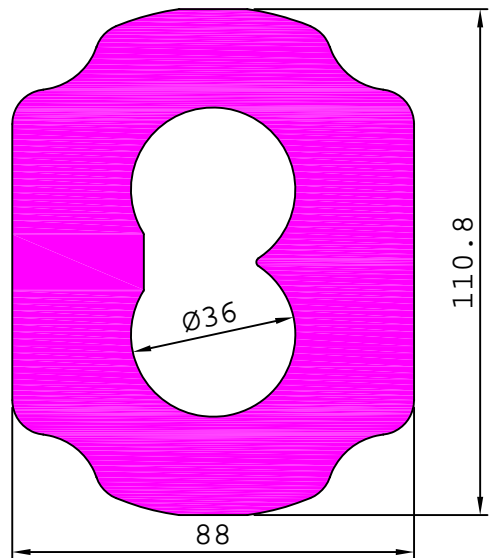

27120 5.335 kg/m

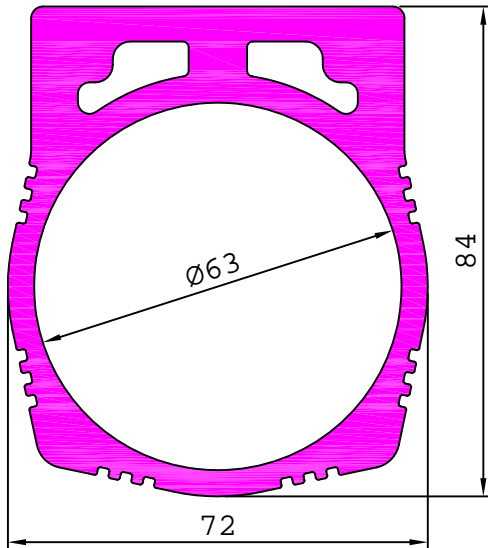

27121 7.342 kg/m

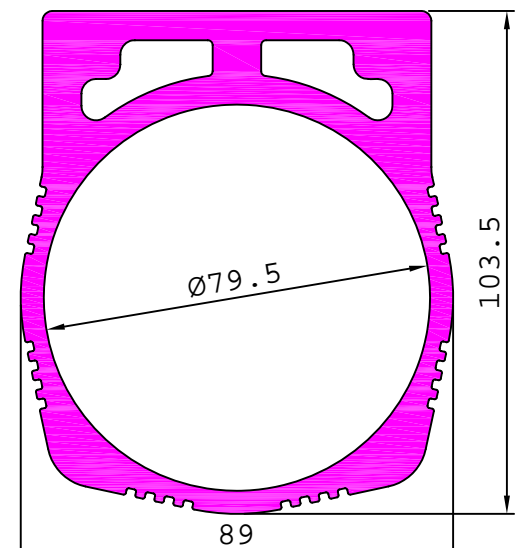

INDUSTRIAL

PUMP BODY AND ACTUATOR BODY

27122

2.825 kg/m

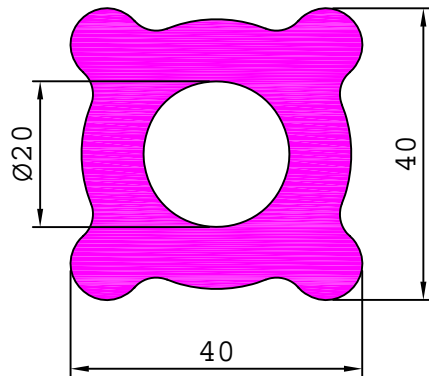

S4230

31.864 kg/m

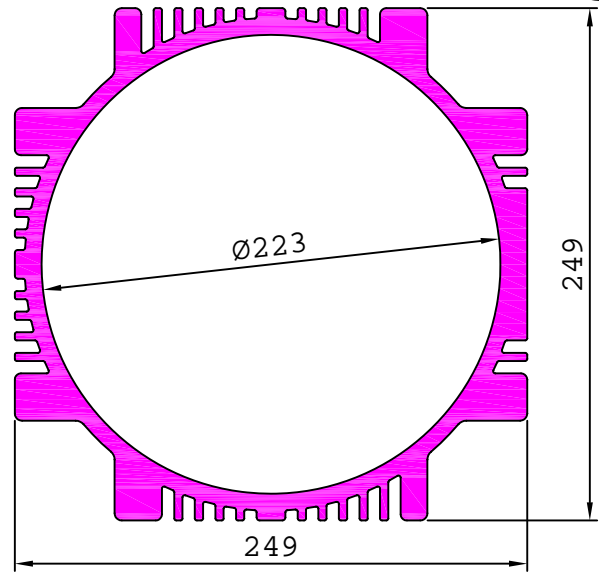

S4323

5.504 kg/m

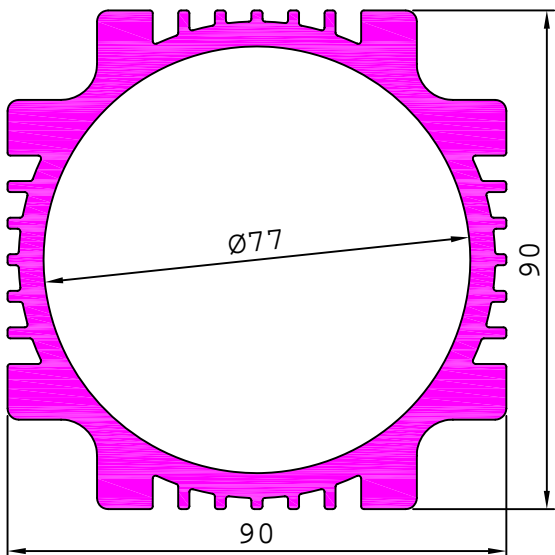

S4324

8.201 kg/m

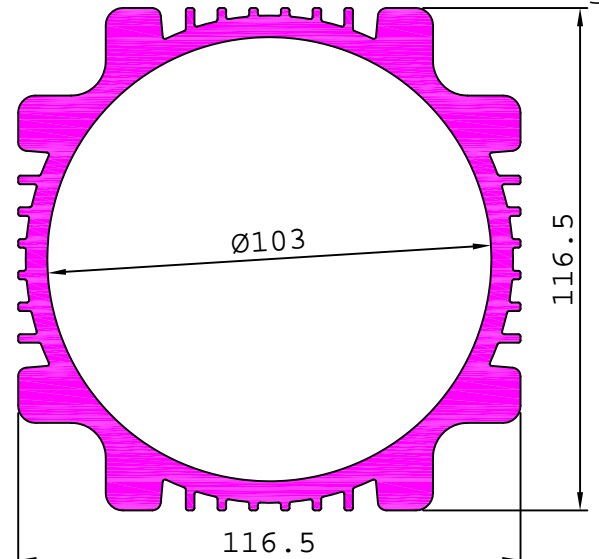

S4325

12.498 kg/m

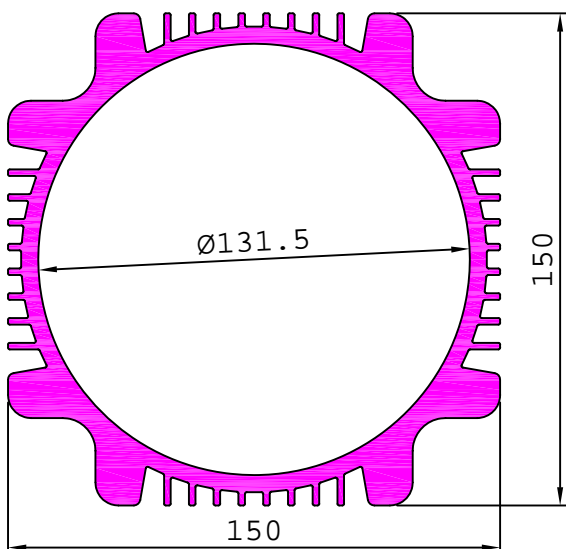

S4608

6.370 kg/m

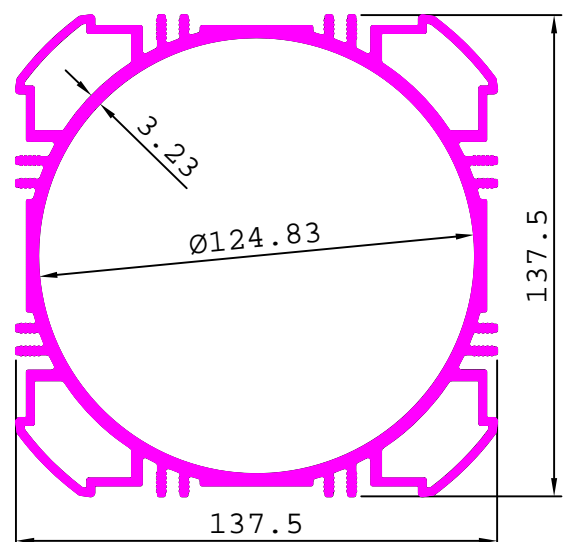

INDUSTRIAL

PUMP BODY AND ACTUATOR BODY

S4876 42.990 kg/m

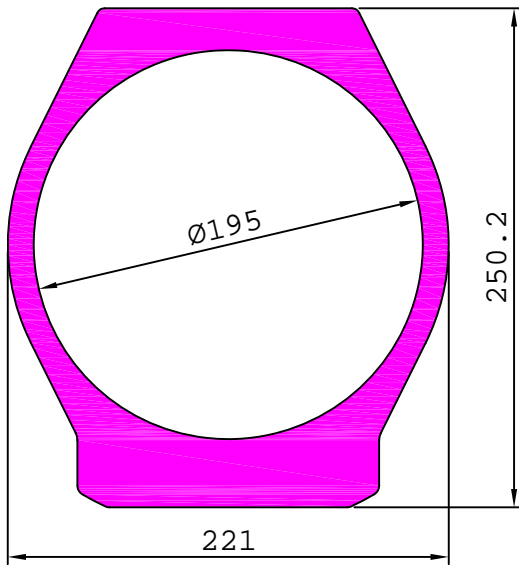

S4920 13.298 kg/m

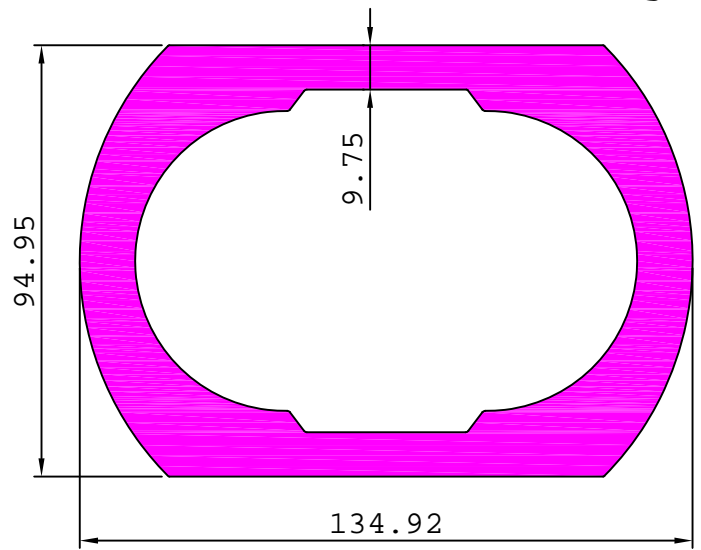

S4921 52.087 kg/m

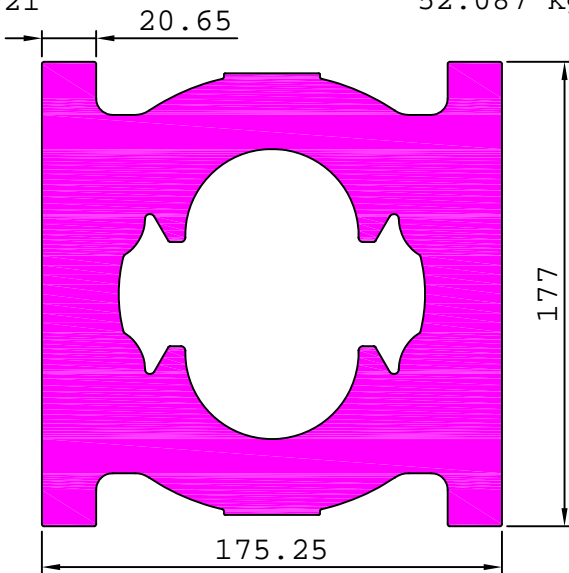

S5003 18.484 kg/m

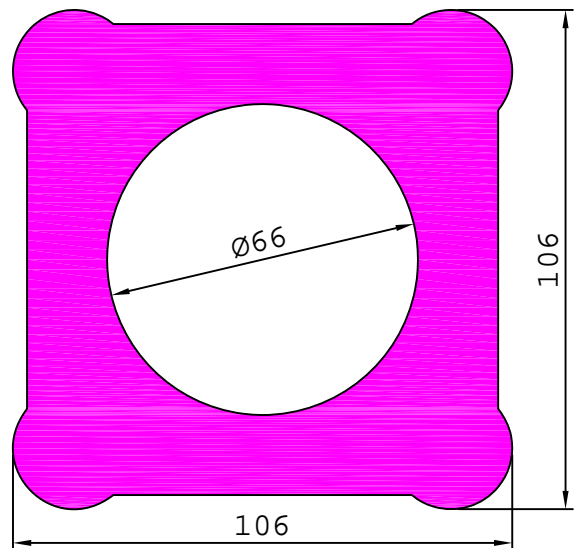

S5081 19.408 kg/m

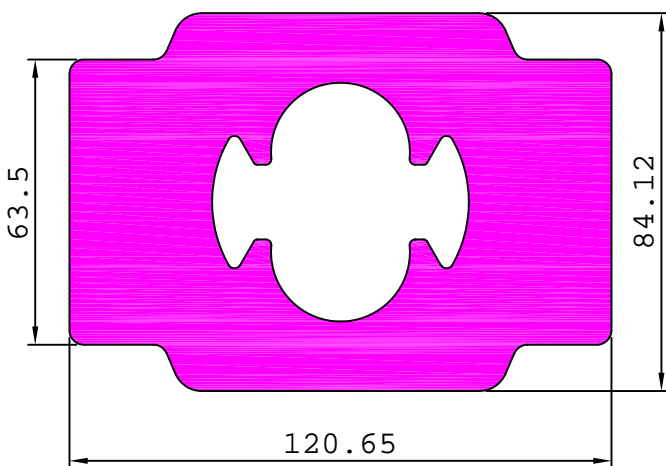

S5114 8.266 kg/m

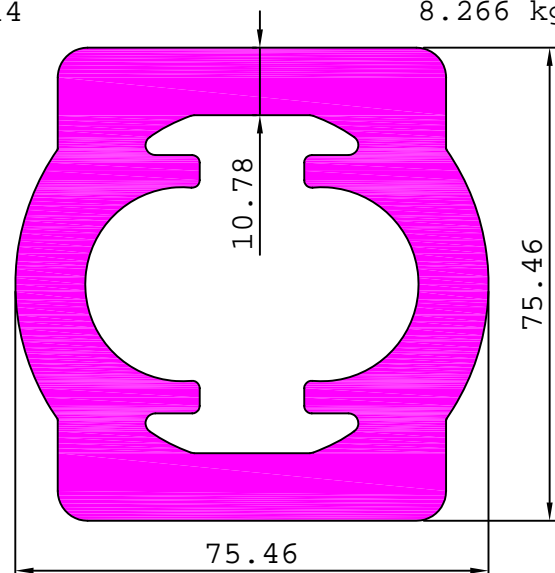

INDUSTRIAL

PUMP BODY AND ACTUATOR BODY

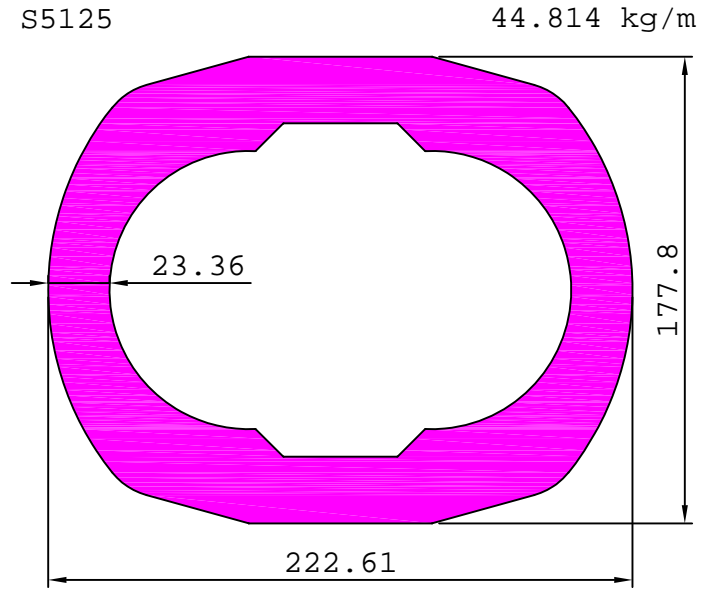
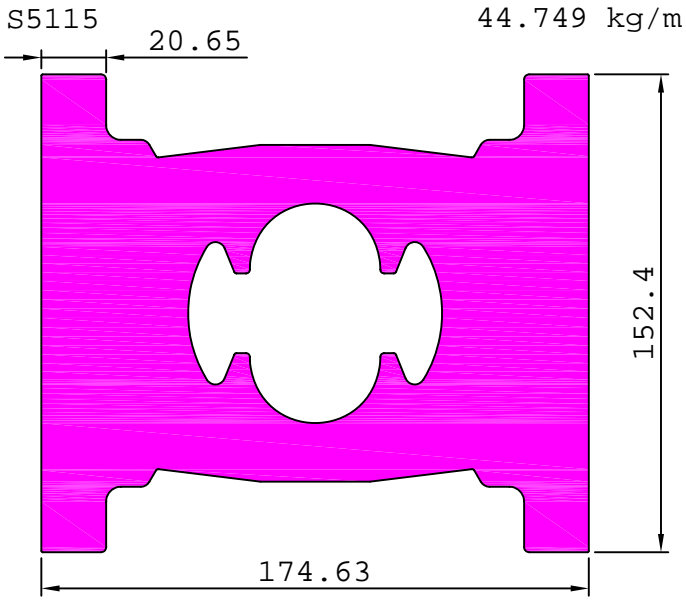

INDUSTRIAL

PUMP BODY AND ACTUATOR BODY

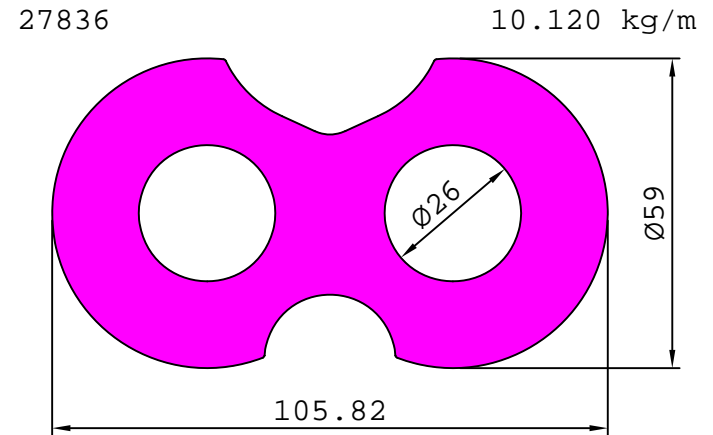
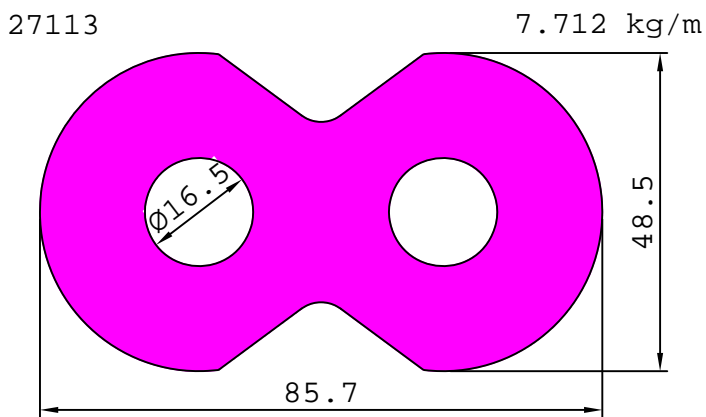
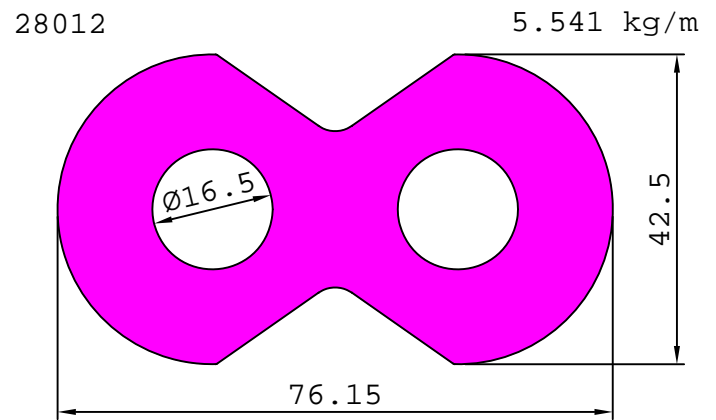
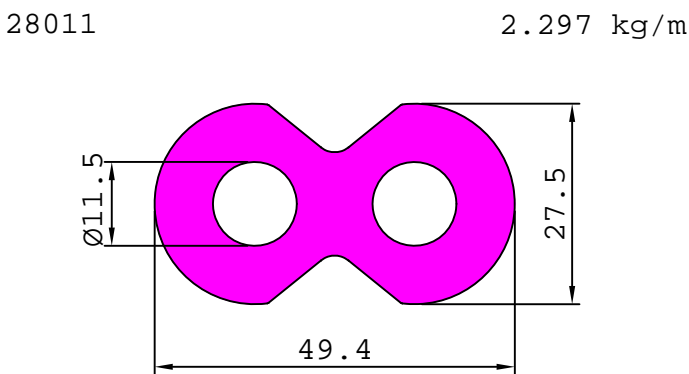
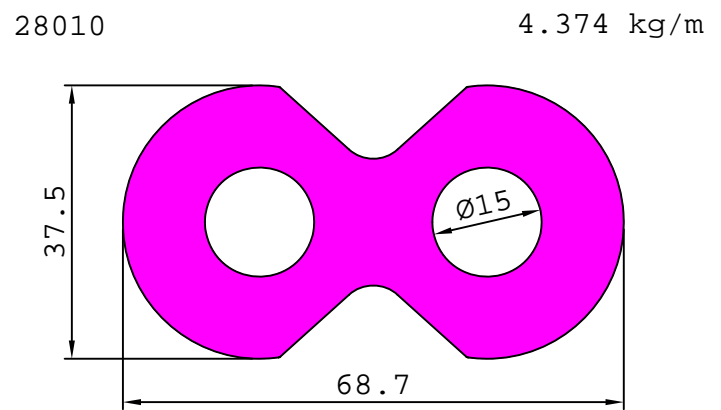
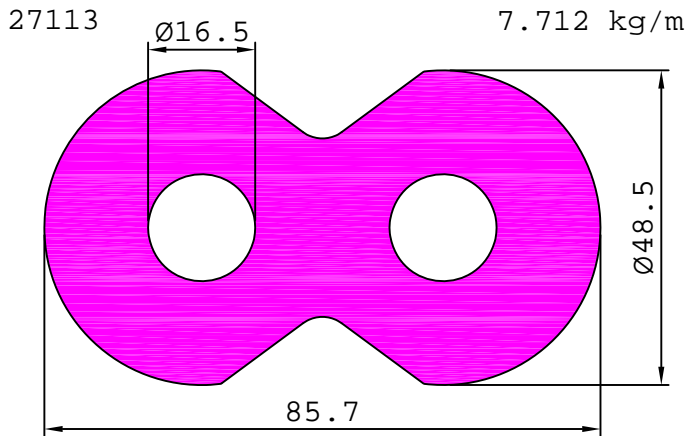

INDUSTRIAL

PUMP AND MOTOR BODY

27201

20.896 kg/m

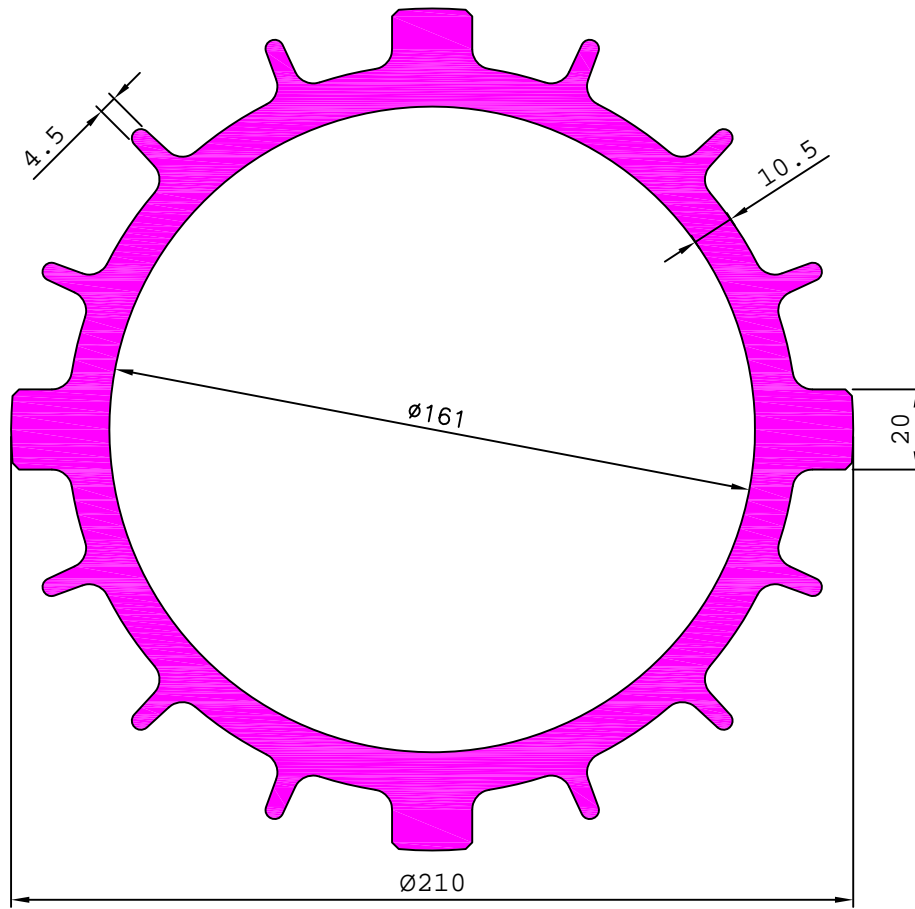

27206

5.669 kg/m

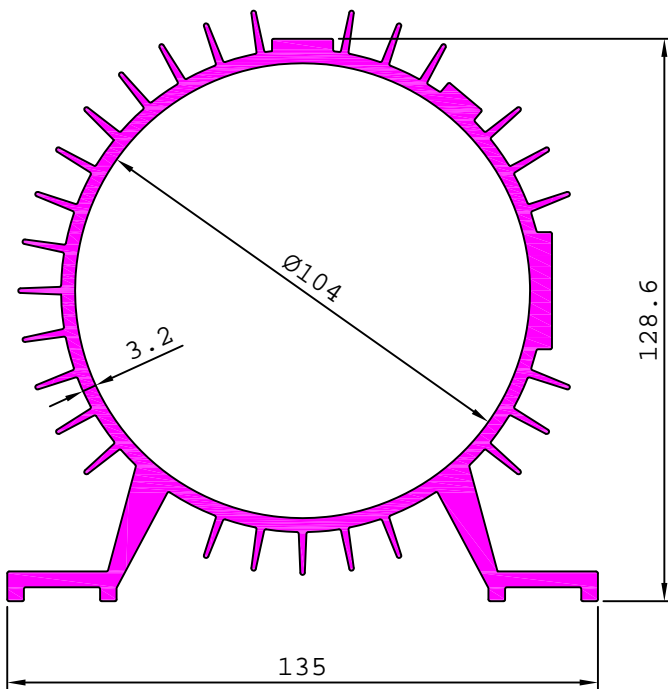

27207

12.714 kg/m

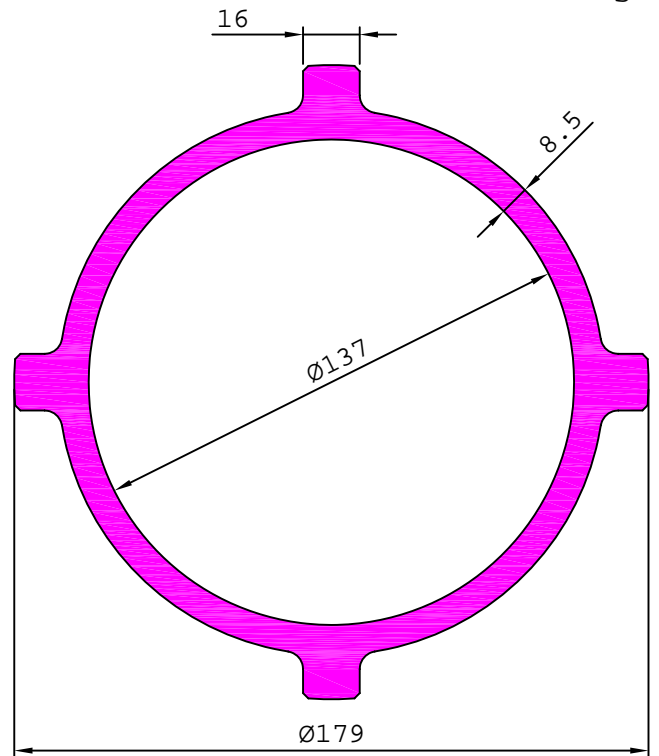

INDUSTRIAL

PUMP AND MOTOR BODY

27208 4.176 kg/m

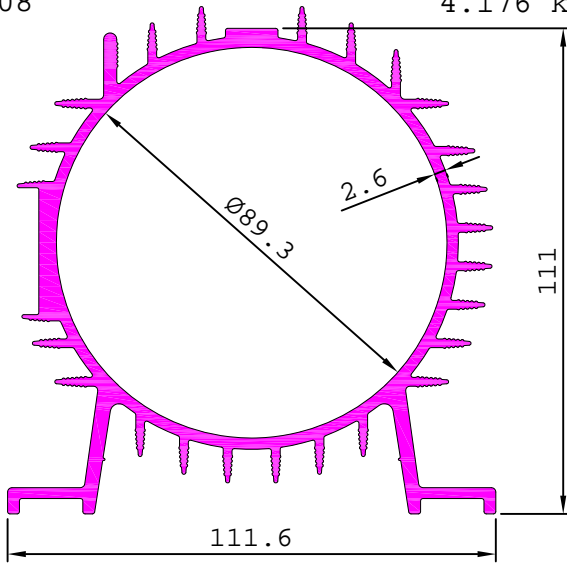

27209 4.612 kg/m

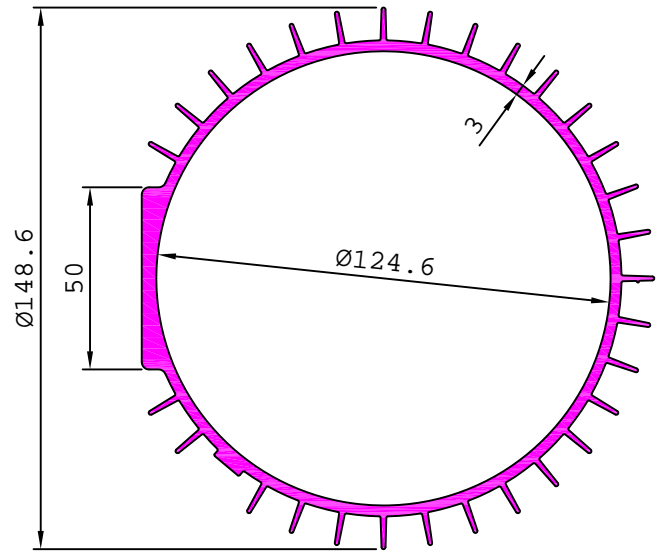

27211 4.317 kg/m

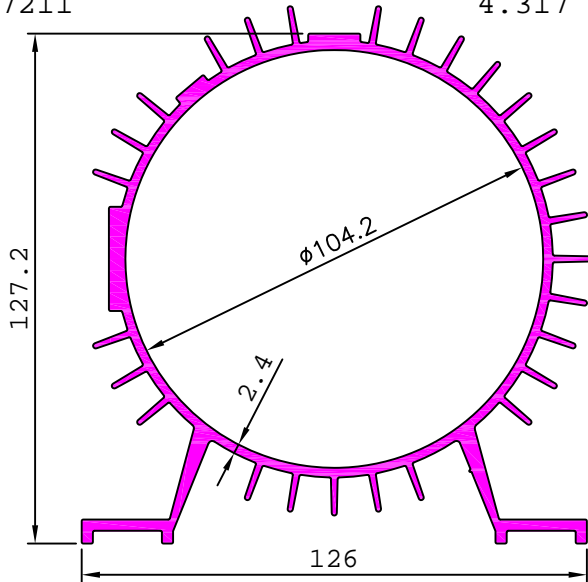

27213 4.840 kg/m

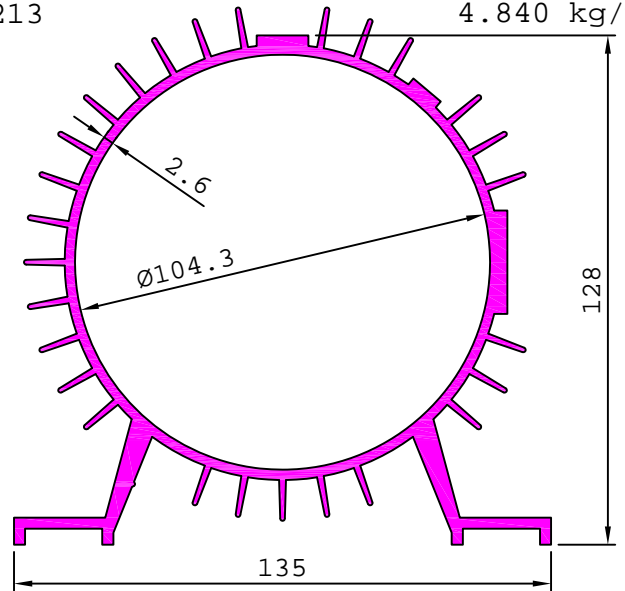

27214 3.813 kg/m

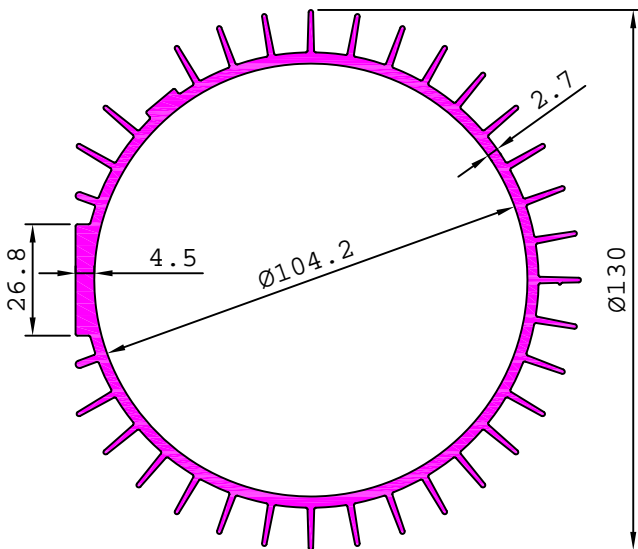

27215 4.162 kg/m

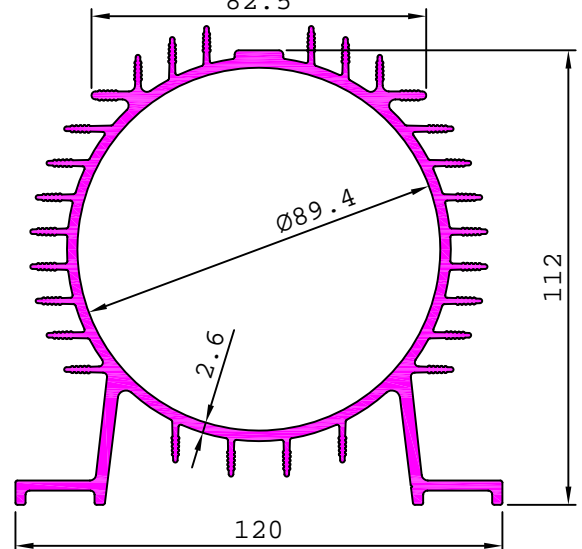

INDUSTRIAL

PUMP AND MOTOR BODY

27216 4.044 kg/m

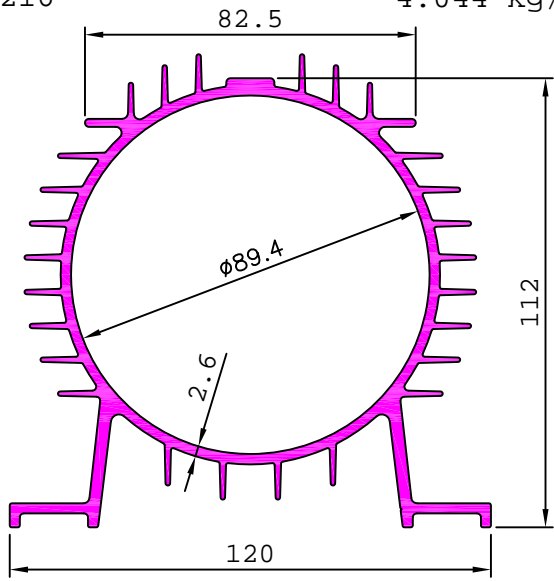

27217 4.865 kg/m

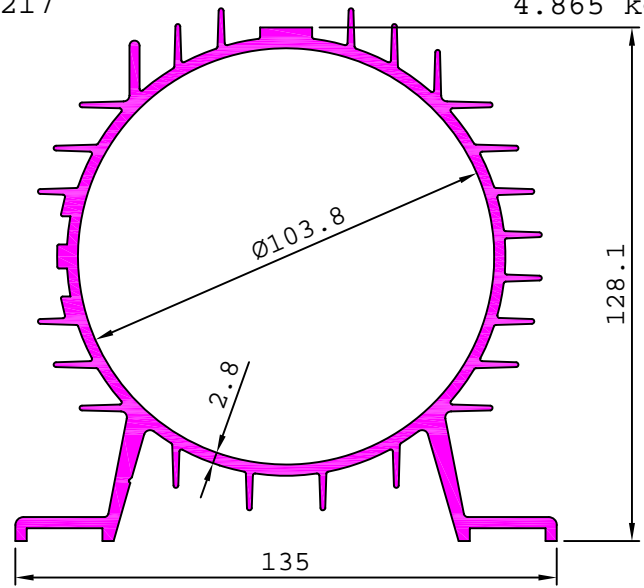

27218 3.101 kg/m

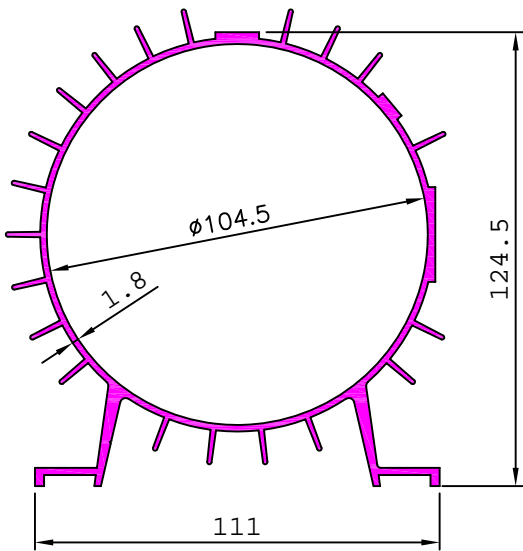

27219 3.886 kg/m

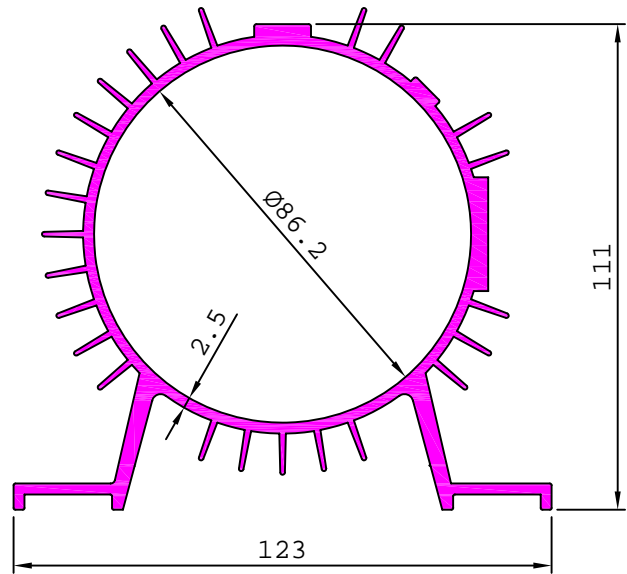

27220 4.426 kg/m

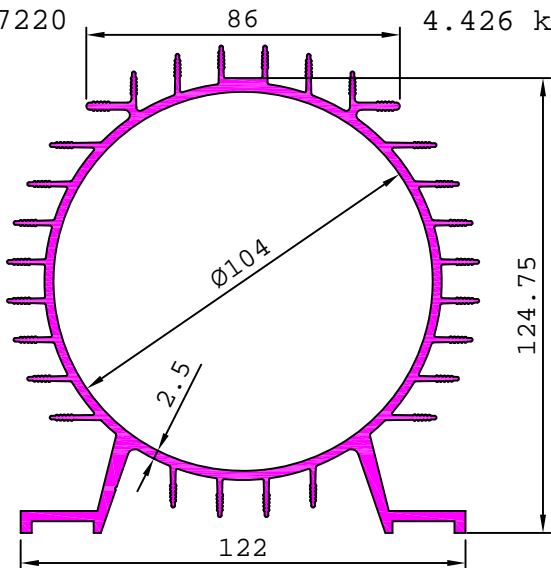

27221 3.449 kg/m

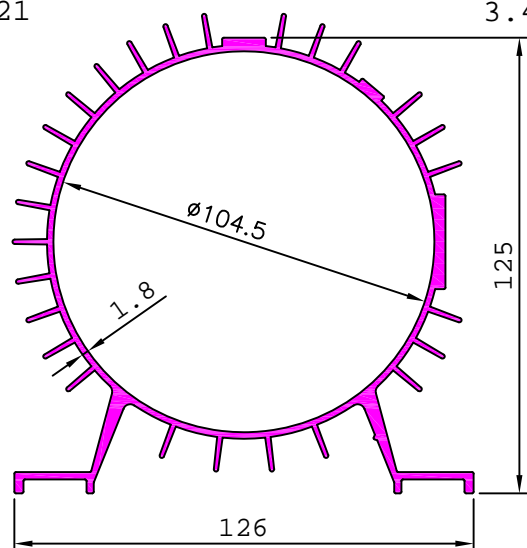

INDUSTRIAL

PUMP AND MOTOR BODY

27223

2.721 kg/m

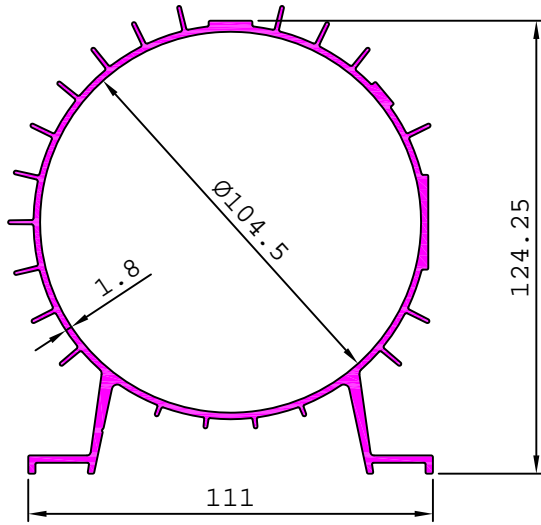

27224

4.648 kg/m

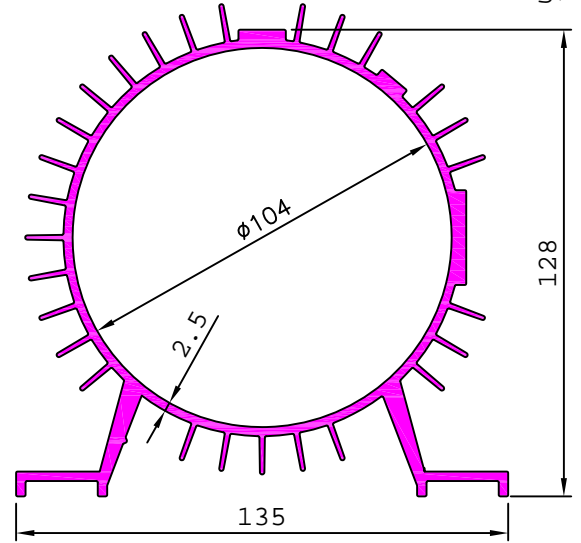

27225

3.397 kg/m

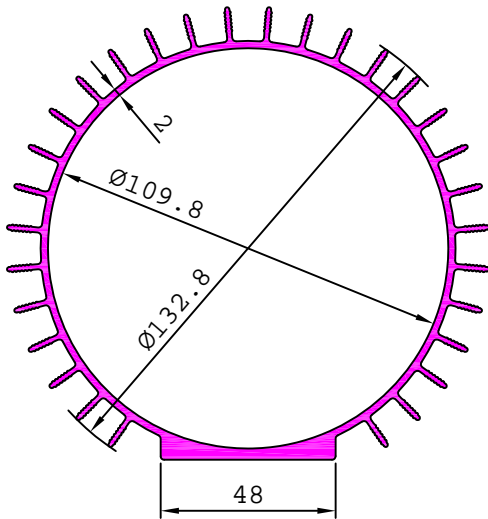

27226

3.948 kg/m

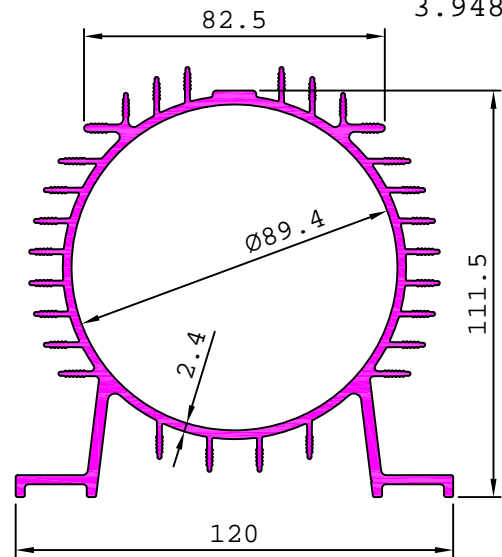

27227

4.442 kg/m

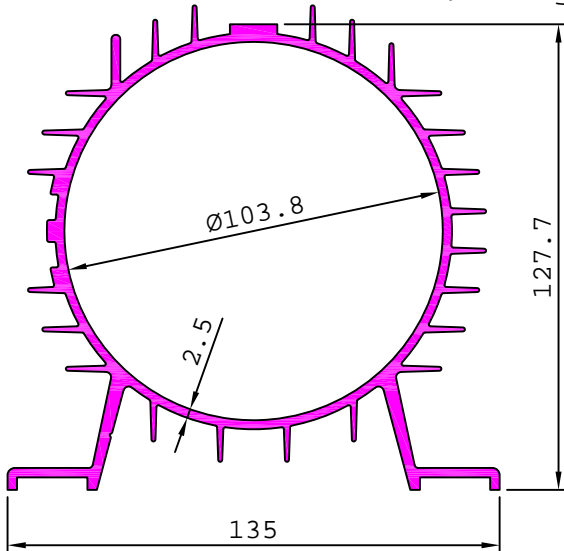

27228

2.856 kg/m

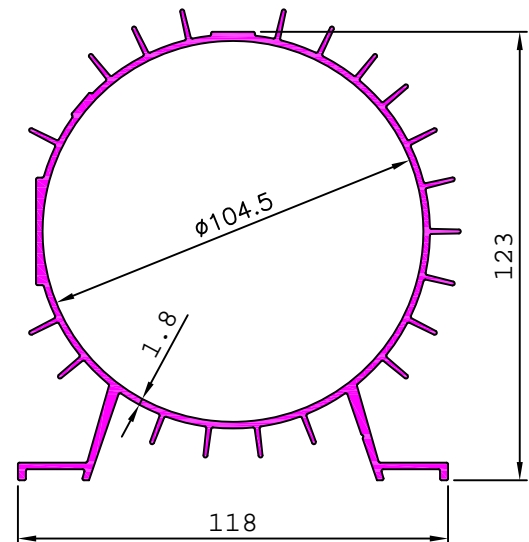

INDUSTRIAL

PUMP AND MOTOR BODY

27229 3.429 kg/m

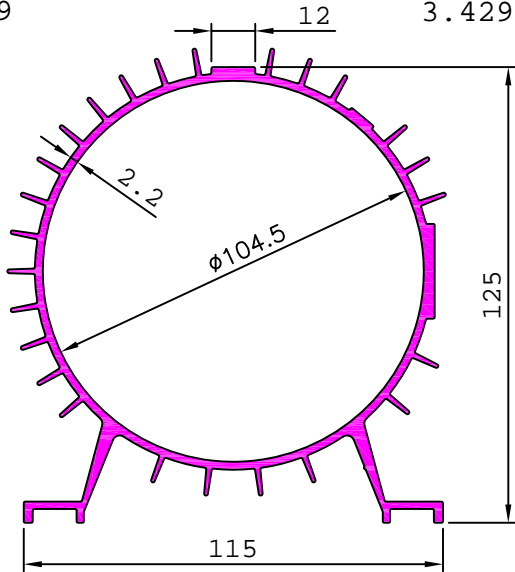

27230 3.640 kg/m

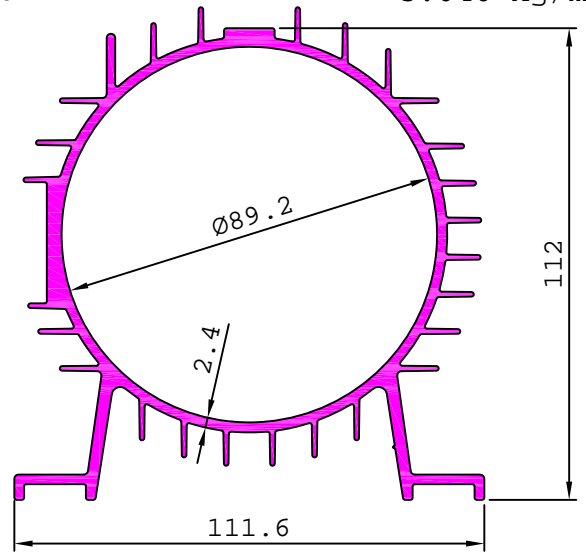

27231 4.332 kg/m

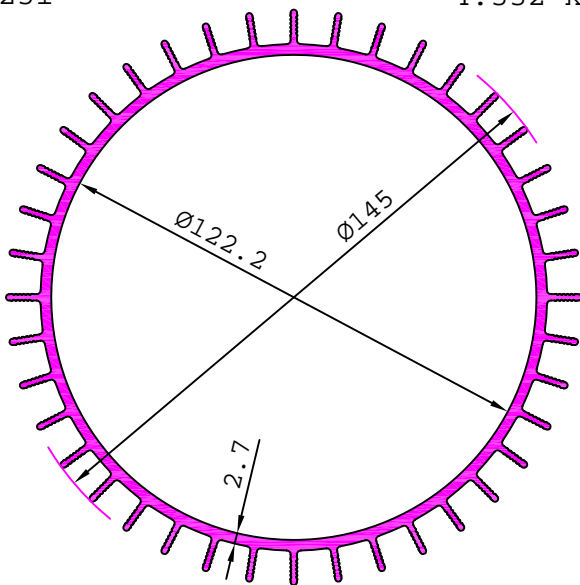

27234 4.485 kg/m

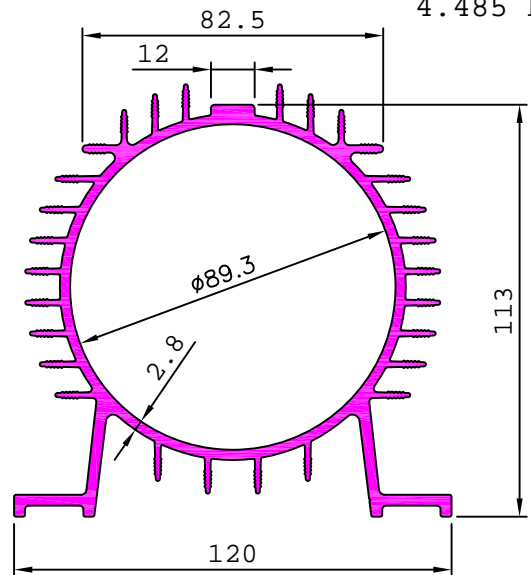

27236 4.076 kg/m

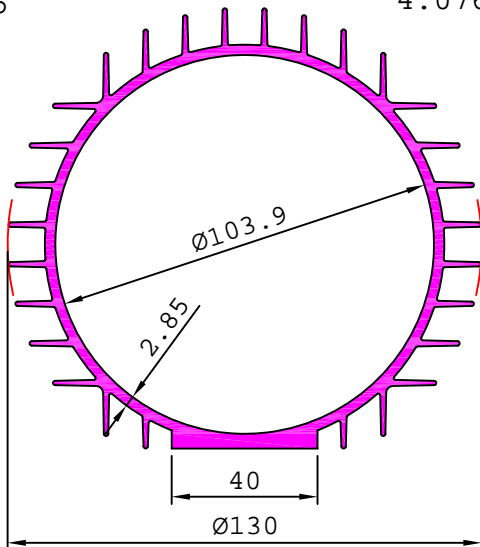

27237 8.409 kg/m

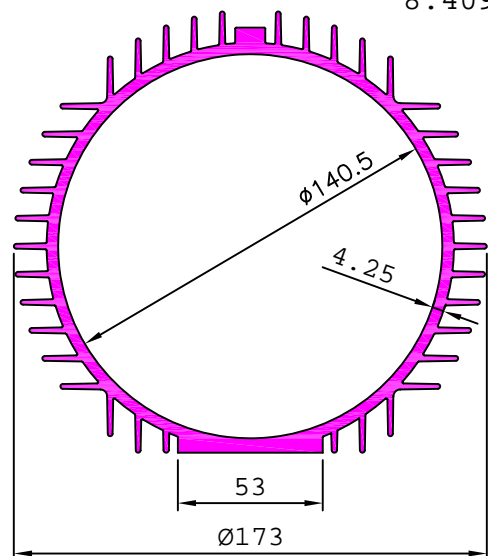

INDUSTRIAL

PUMP AND MOTOR BODY

27238

7.260 kg/m

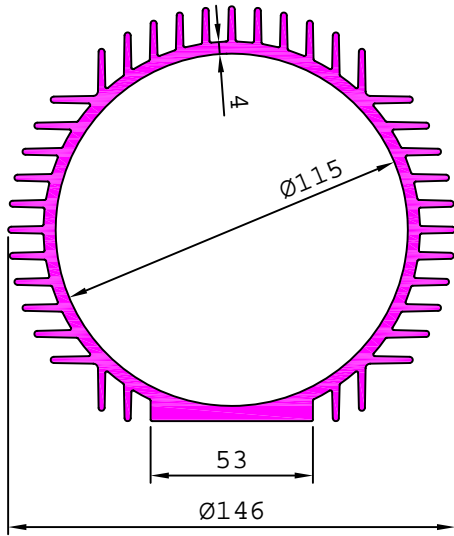

27239

3.705 kg/m

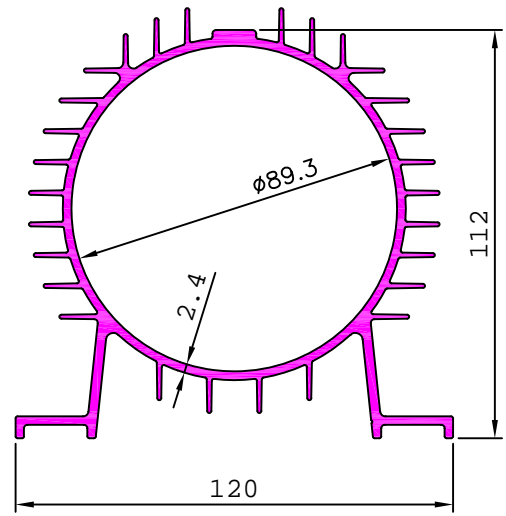

27240

2.565 kg/m

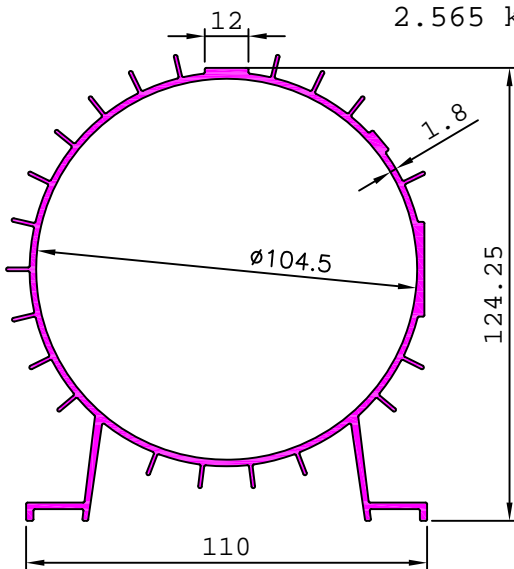

27241

4.330 kg/m

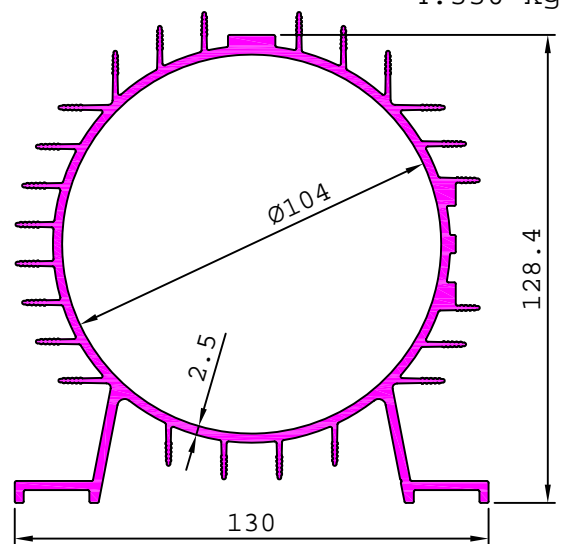

27242

3.686 kg/m

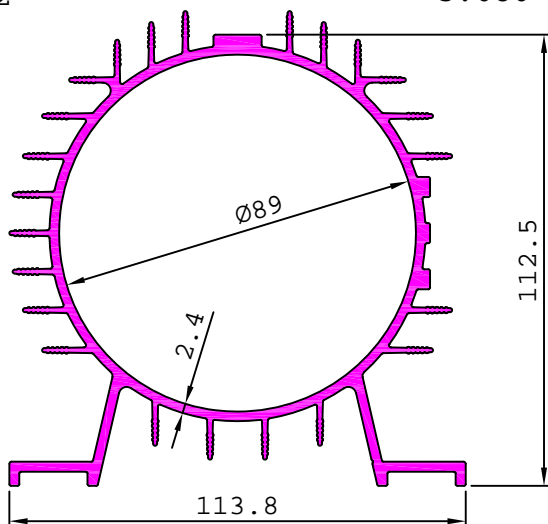

27243

2.331 kg/m

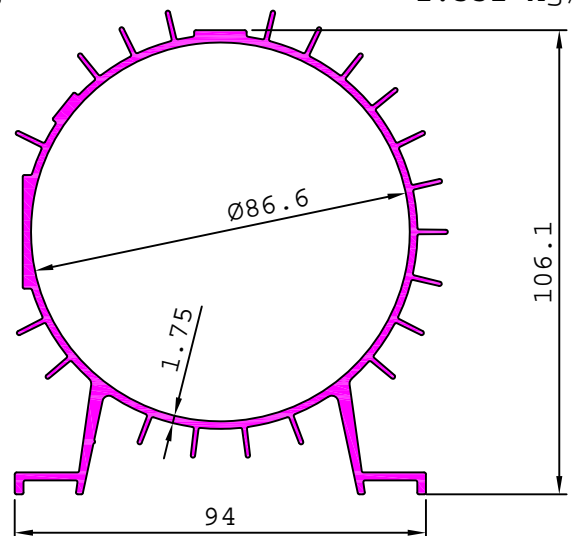

INDUSTRIAL

PUMP AND MOTOR BODY

27244

5.034 kg/m

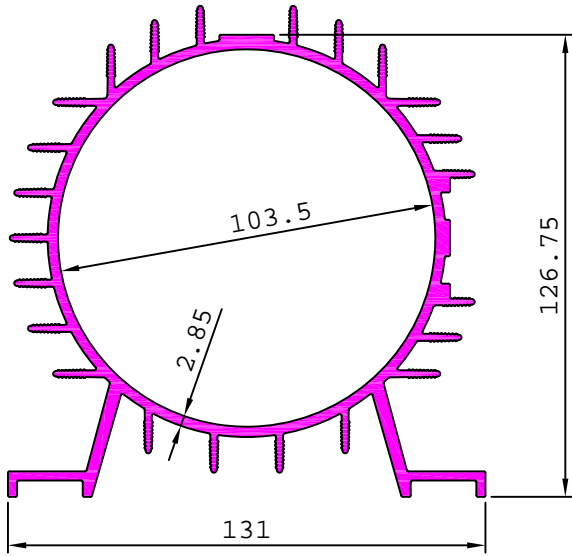

27245

3.292 kg/m

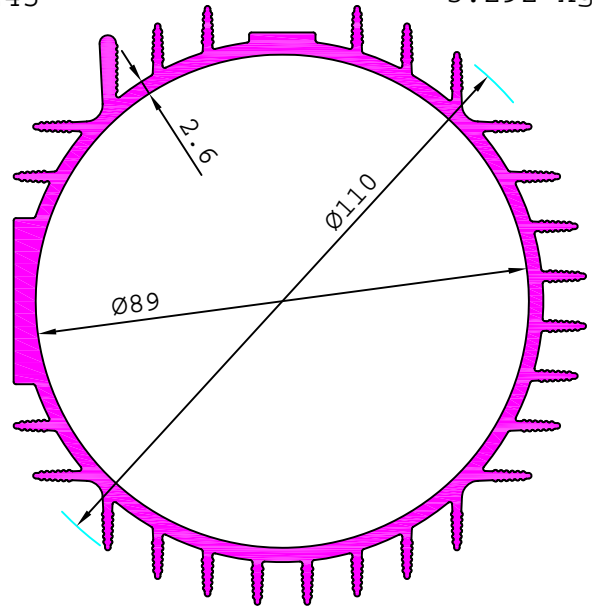

27246

21.605 kg/m

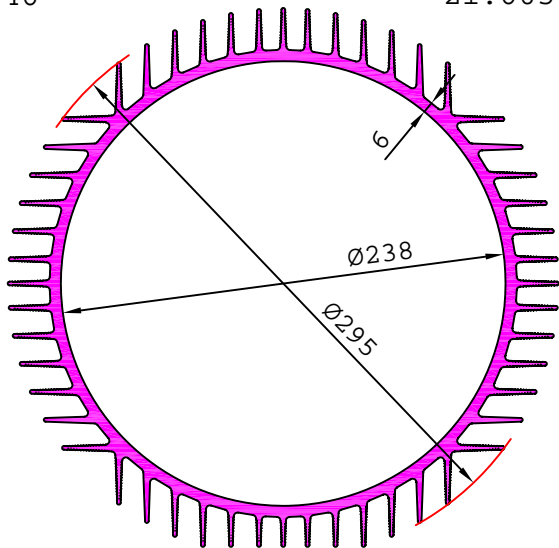

27247

2.666 kg/m

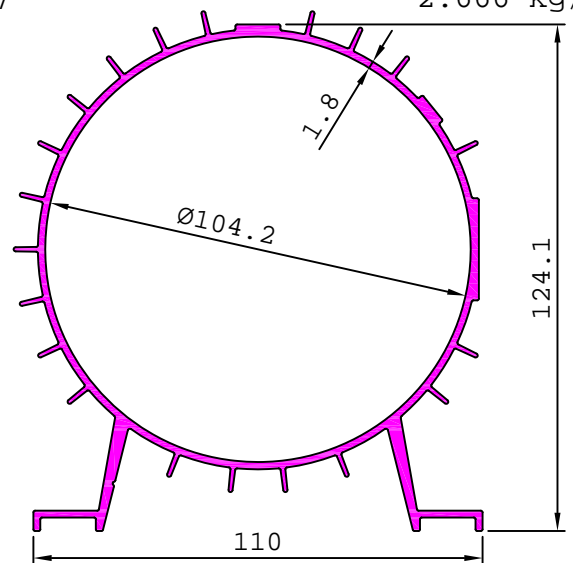

27248

14.603 kg/m

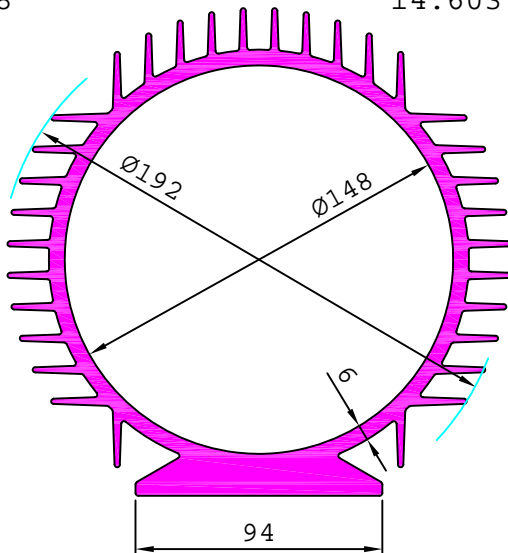

27249

4.654 kg/m

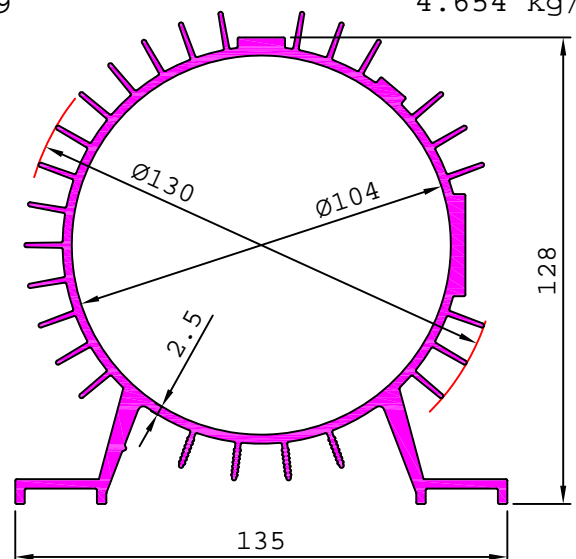

INDUSTRIAL

PUMP AND MOTOR BODY

27250

8.242 kg/m

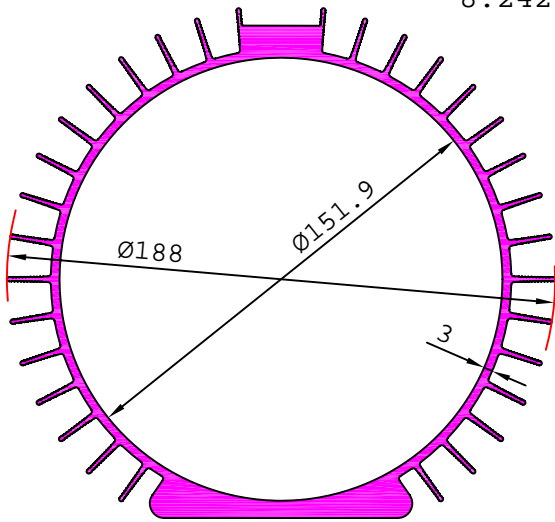

27251

2.290 kg/m

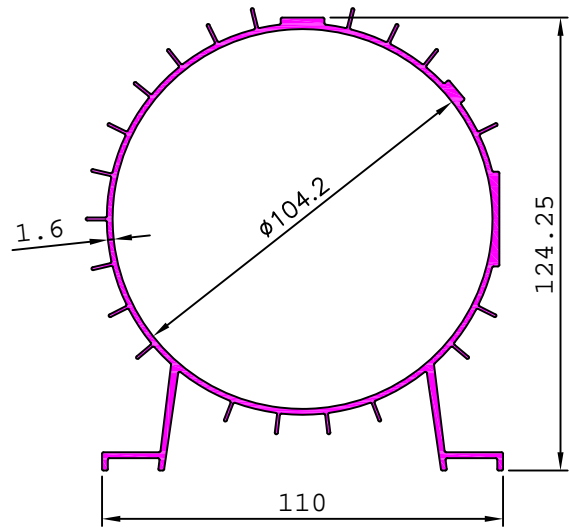

27252

6.305 kg/m

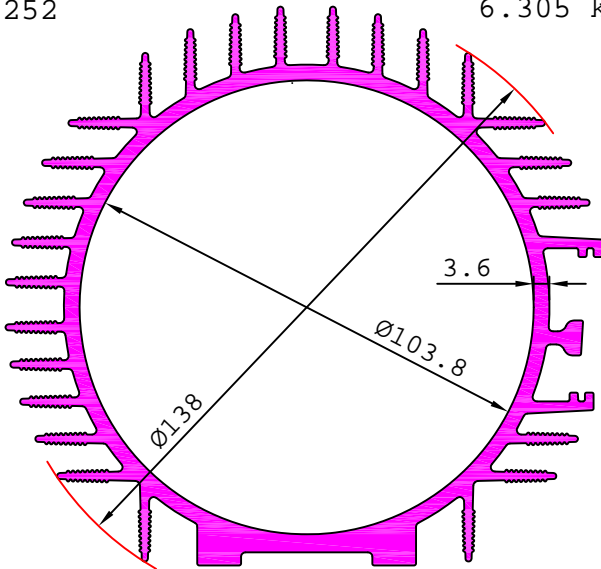

27253

7.367 kg/m

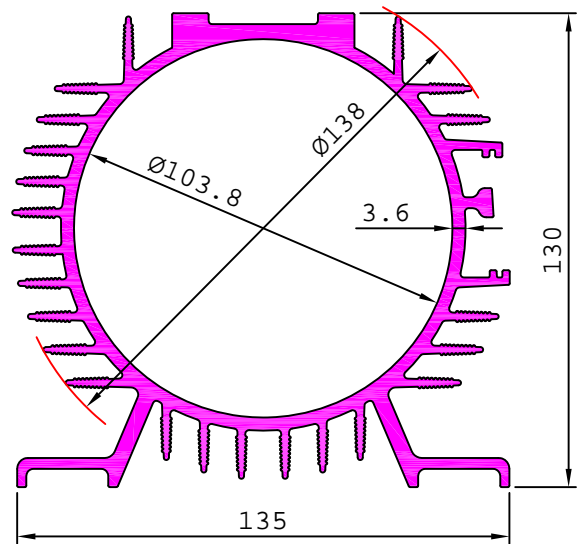

27254

5.616 kg/m

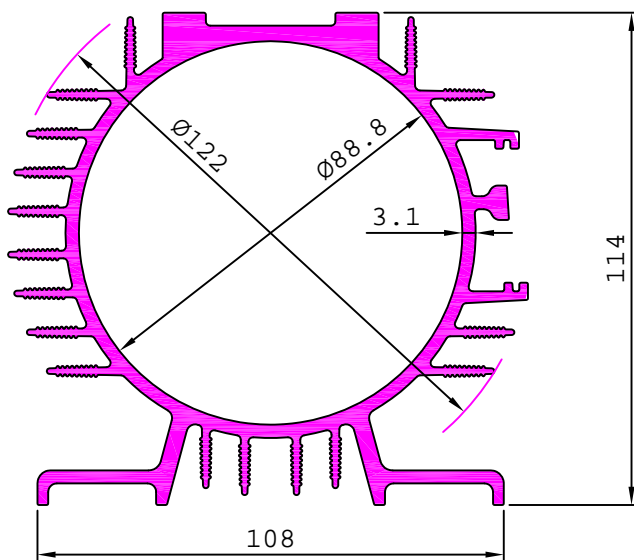

27255

5.822 kg/m

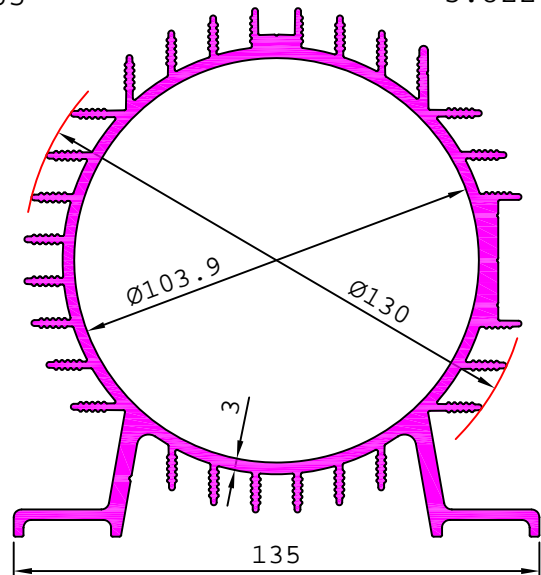

INDUSTRIAL

PUMP AND MOTOR BODY

27256 21.026 kg/m

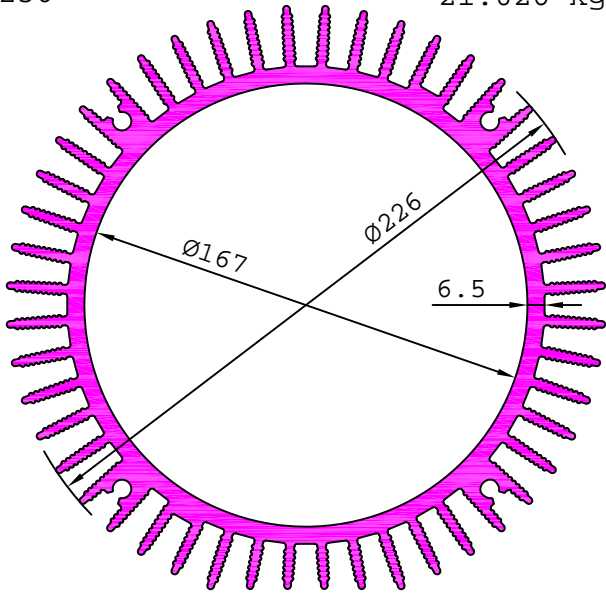

27257 3.906 kg/m

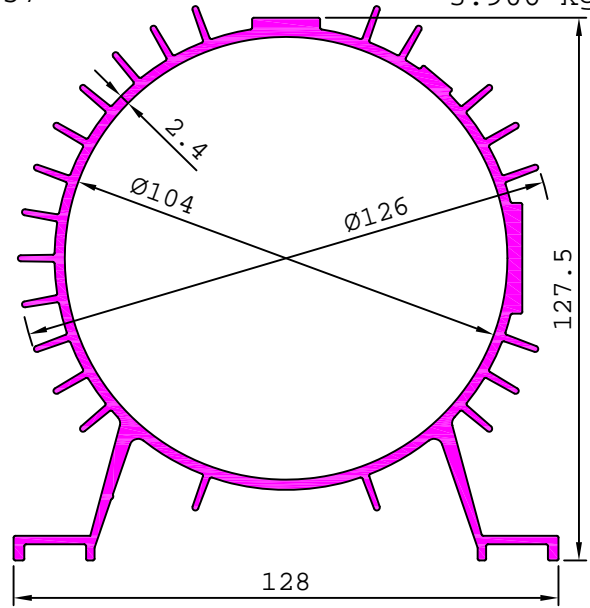

27258 3.636 kg/m

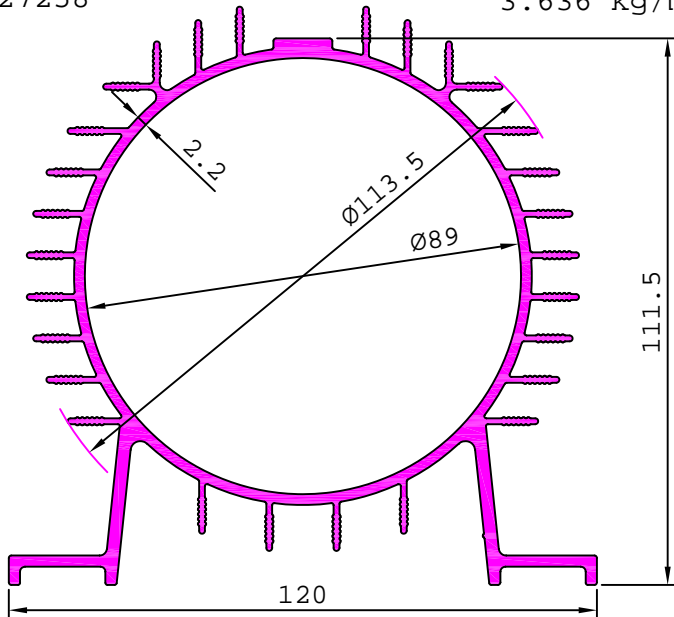

27259 4.553 kg/m

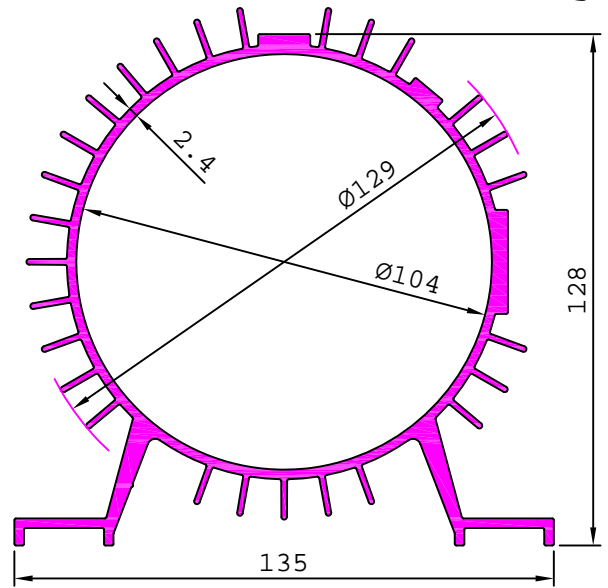

27260 6.111 kg/m

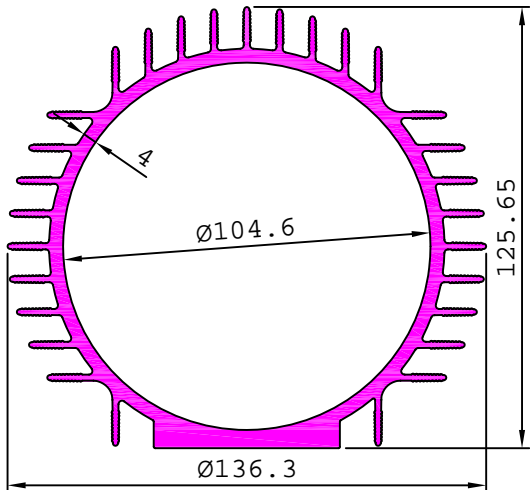

27261 7.384 kg/m

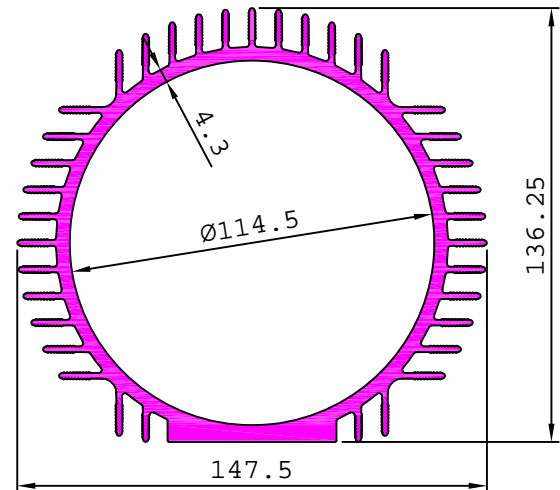

INDUSTRIAL

PUMP AND MOTOR BODY

27262 9.779 kg/m

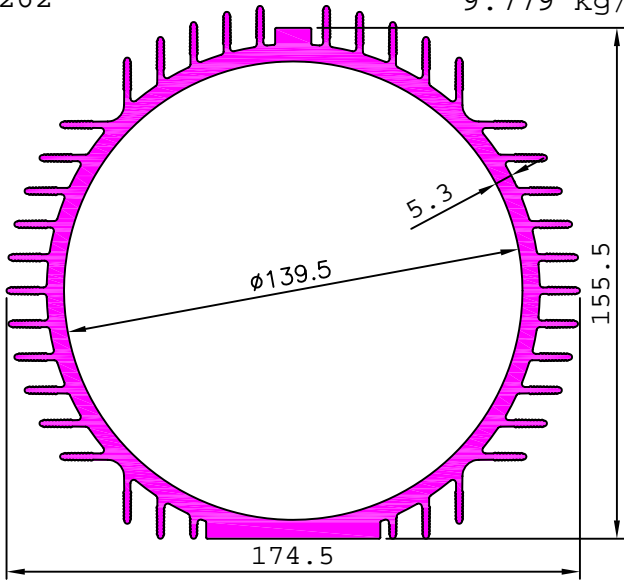

27263 6.416 kg/m

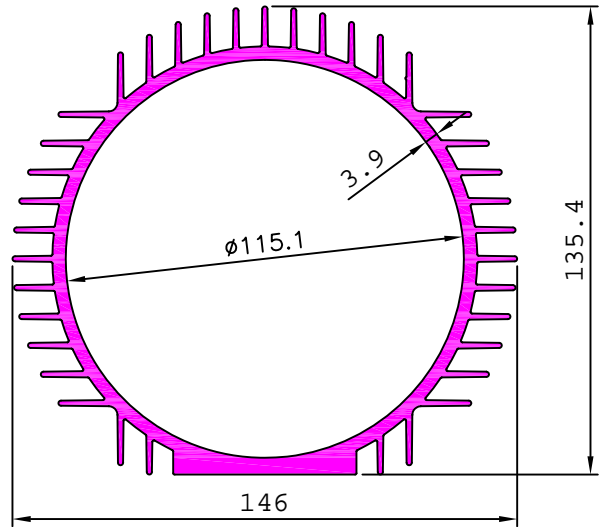

27264 4.805 kg/m

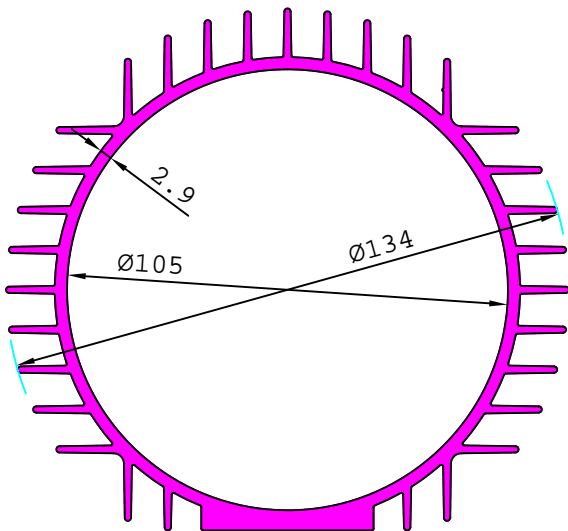

27265 5.658 kg/m

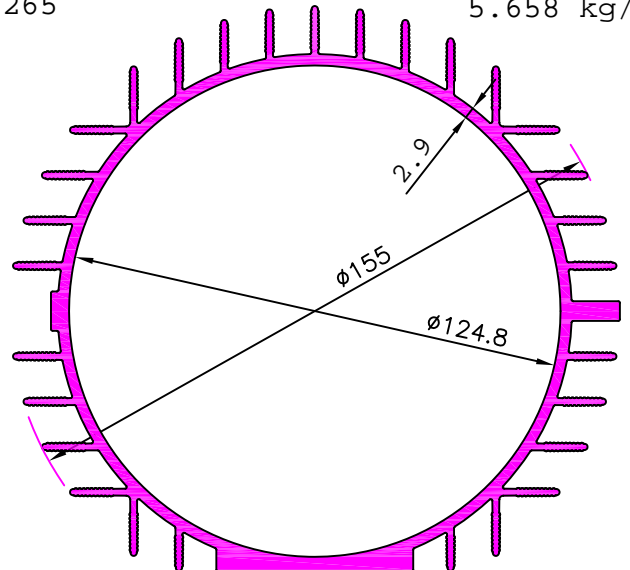

27266 3.600 kg/m

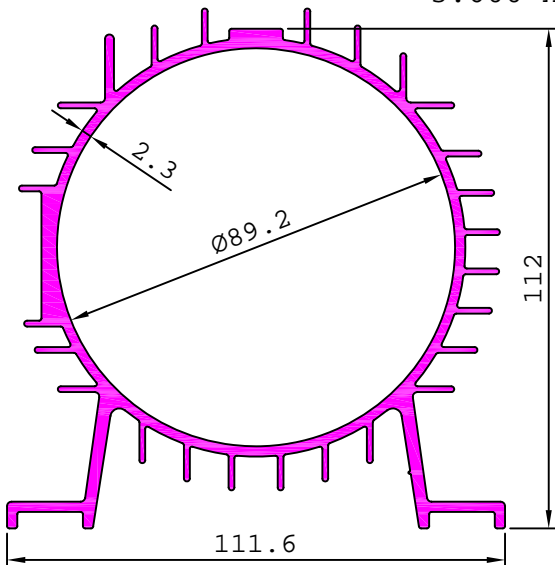

27267 3.948 kg/m

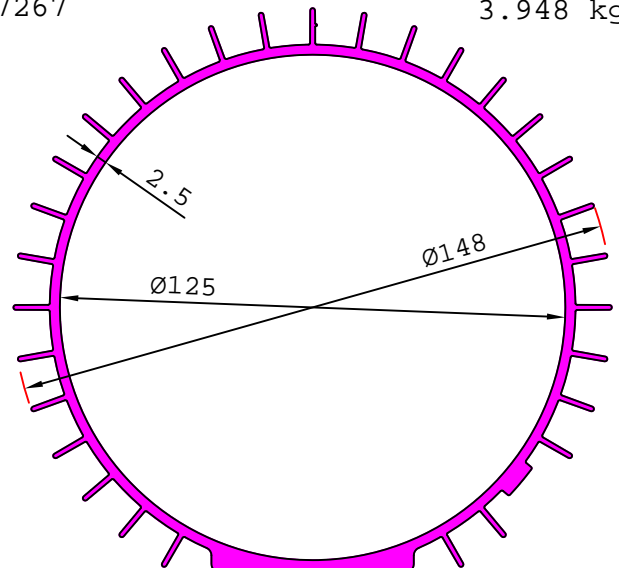

INDUSTRIAL

PUMP AND MOTOR BODY

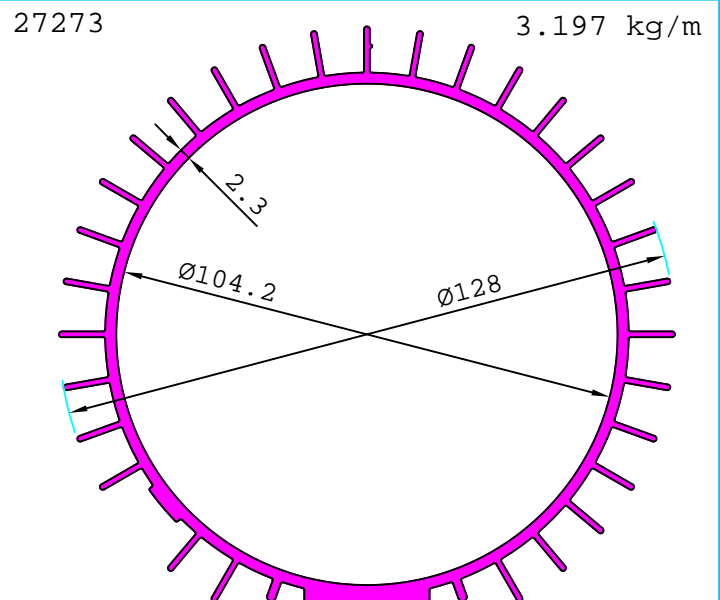
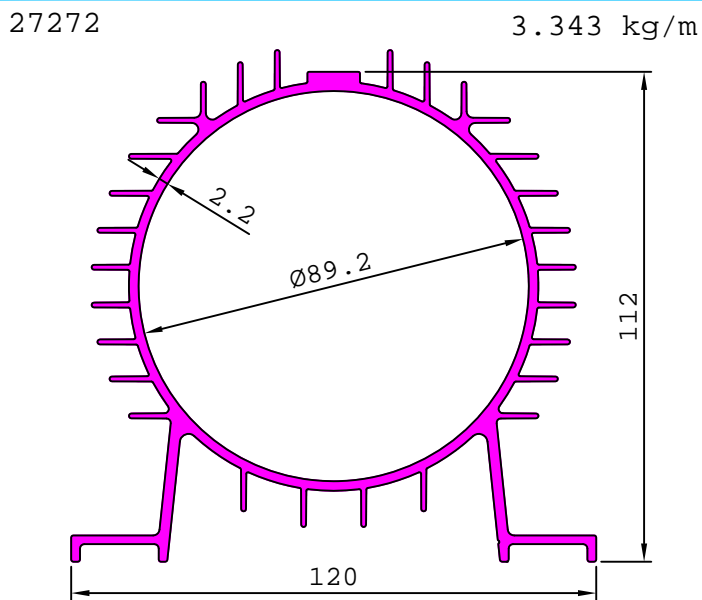
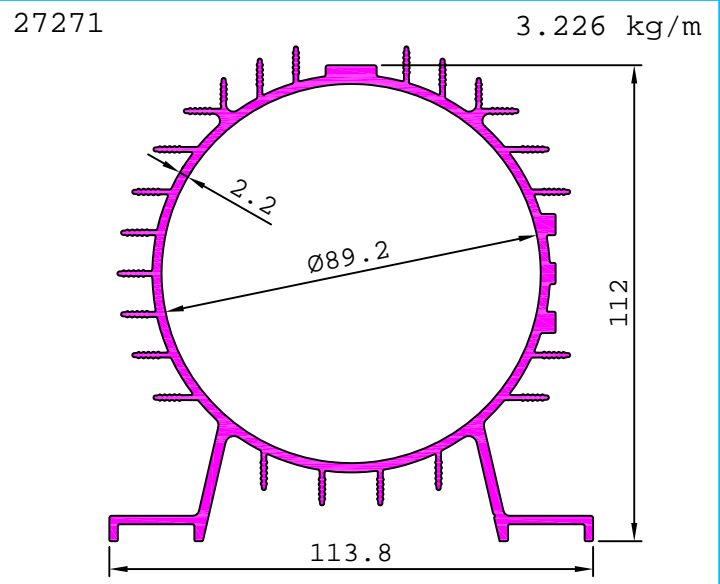
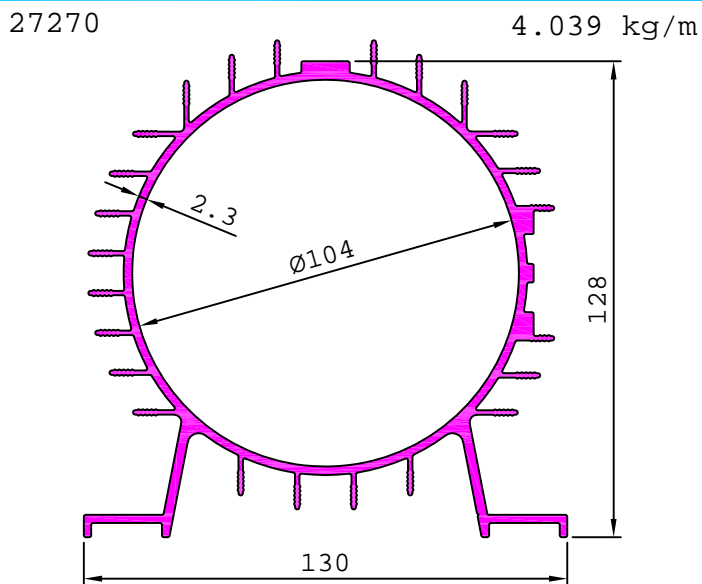
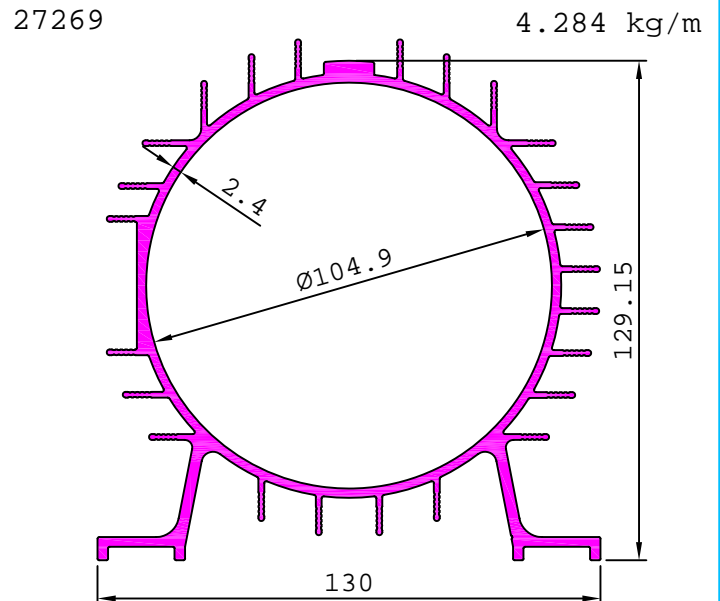
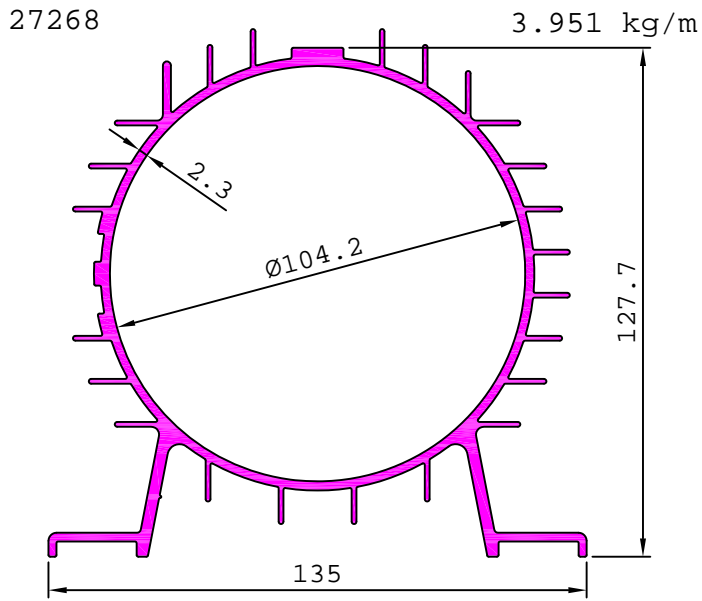

INDUSTRIAL

PUMP AND MOTOR BODY

27274 3.067 kg/m

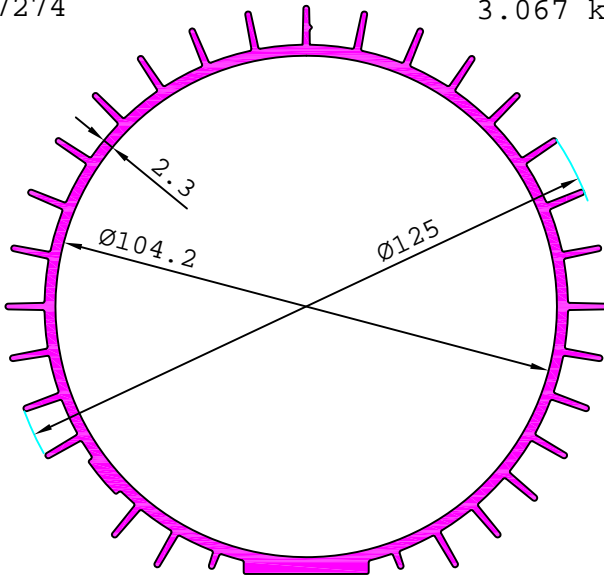

27275 4.023 kg/m

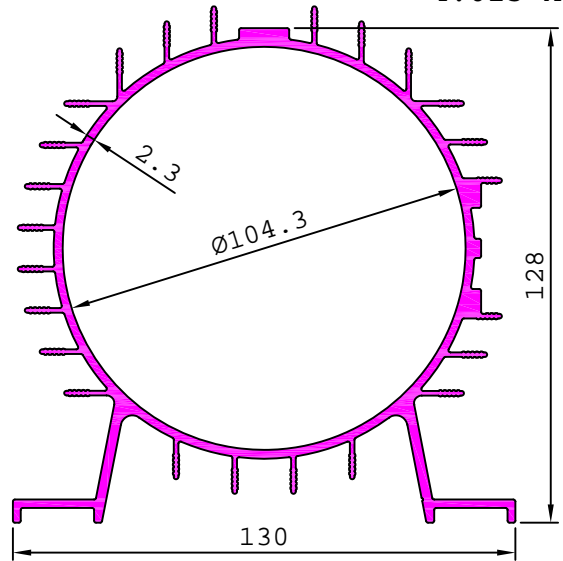

27276 4.300 kg/m

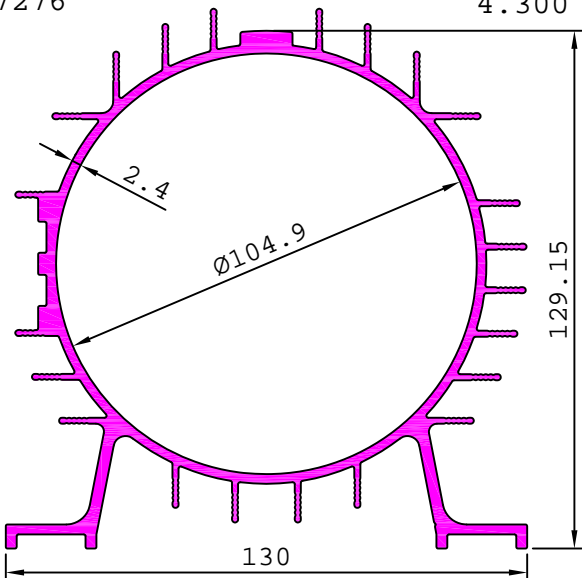

27277 2.428 kg/m

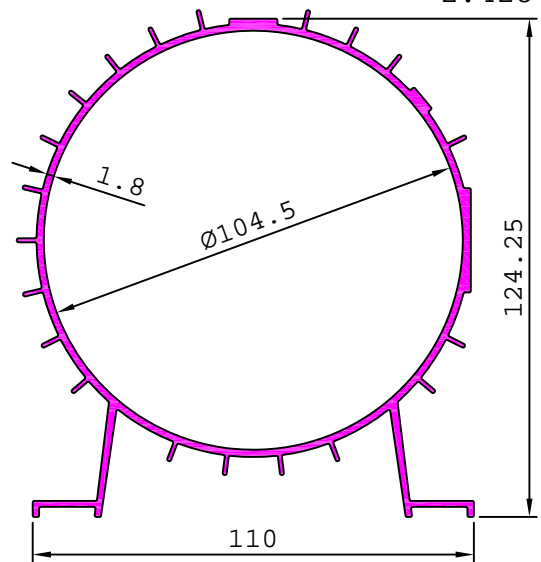

S4671 11.537 kg/m

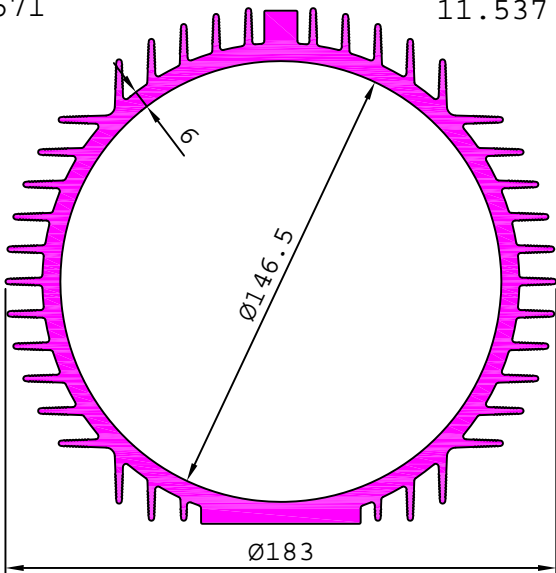

INDUSTRIAL

MISCELLANEOUS

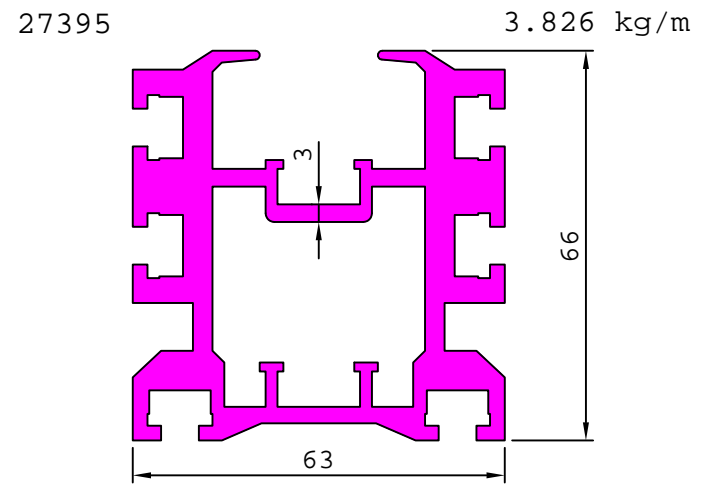
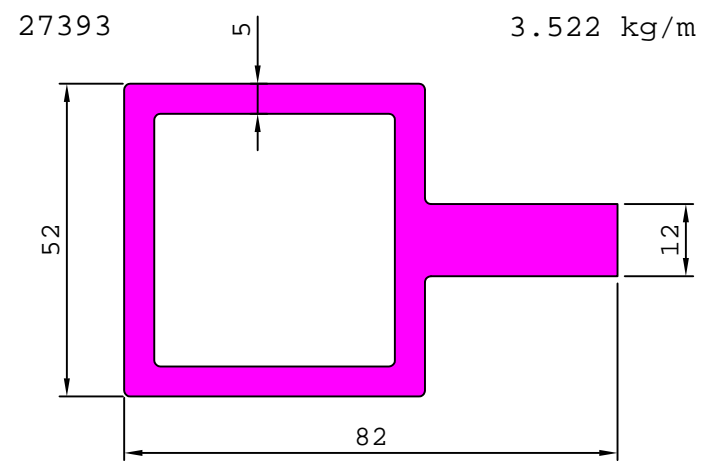
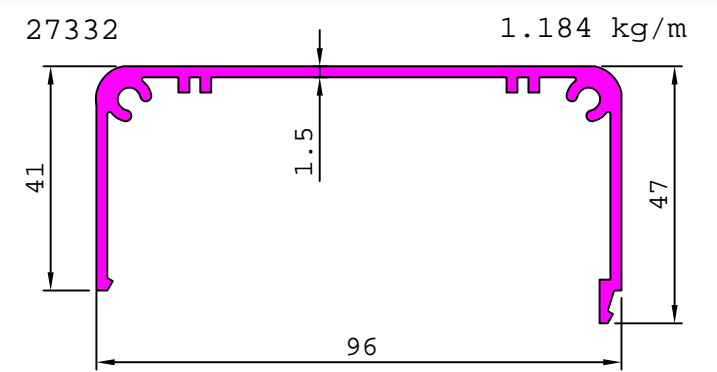
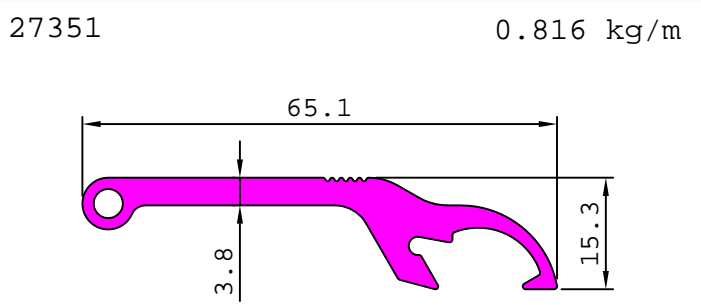
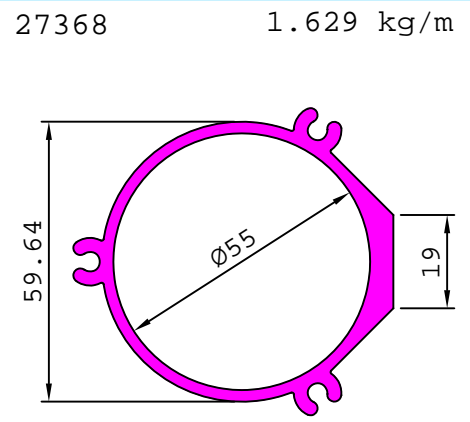
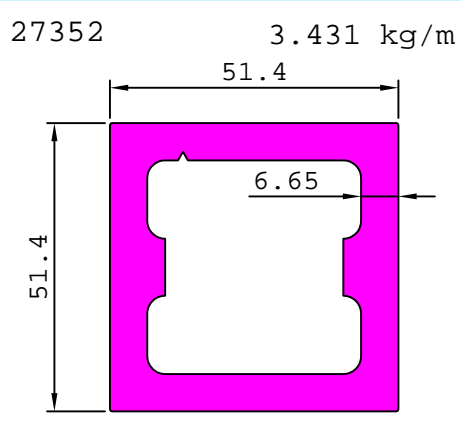
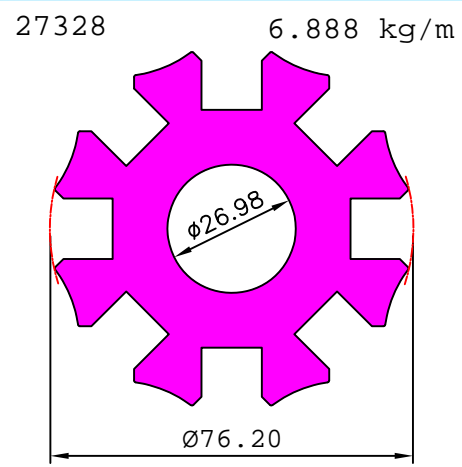
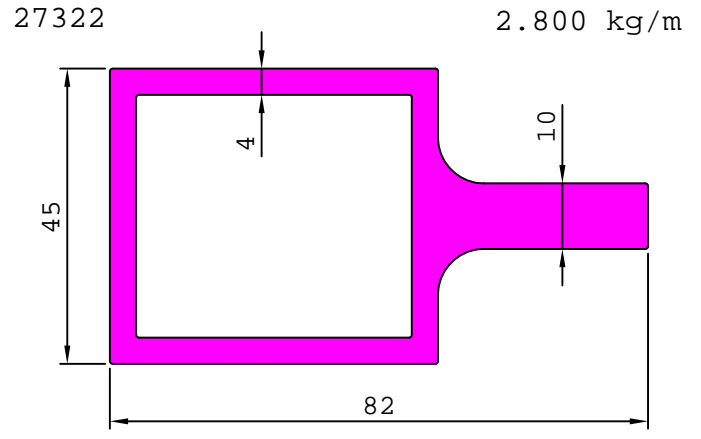
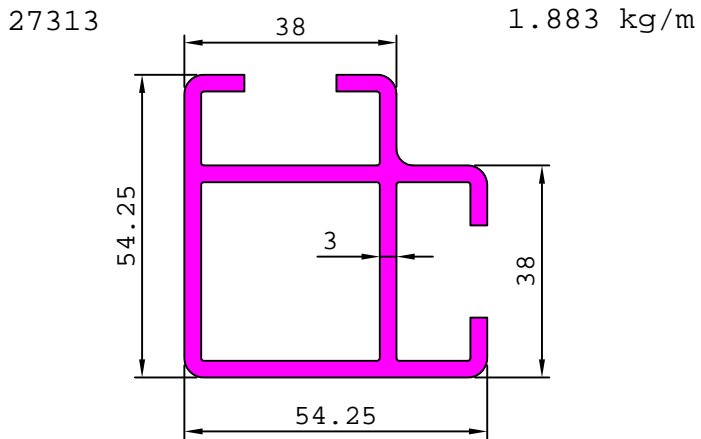

INDUSTRIAL

MISCELLANEOUS

27407 0.192 kg/m

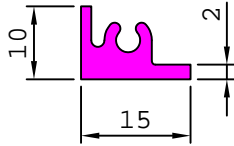

27408 0.305 kg/m

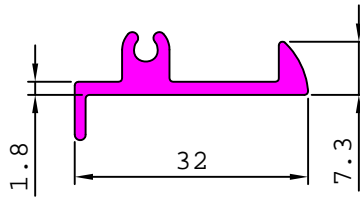

27415 0.081 kg/m

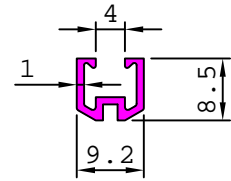

27414 0.398 kg/m

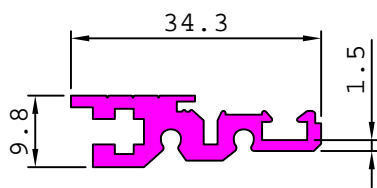

27432 2.596 kg/m

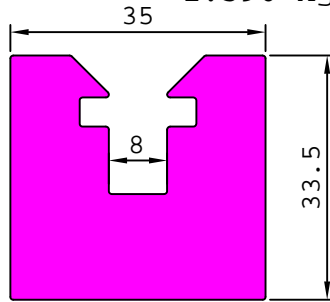

27439 8.077 kg/m

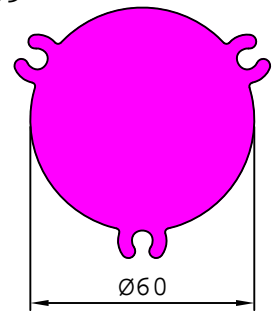

27419 1.501 kg/m

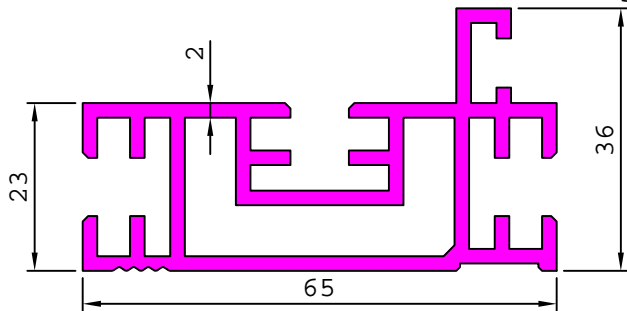

27451 1.157 kg/m

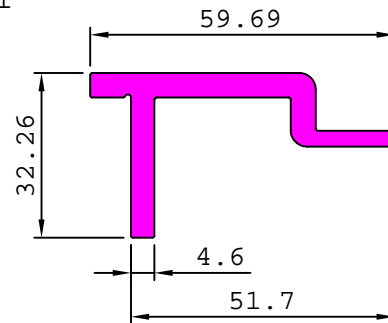

27452 4.948 kg/m

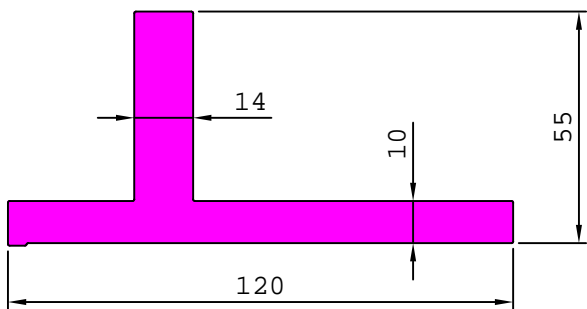

27453 1.205 kg/m

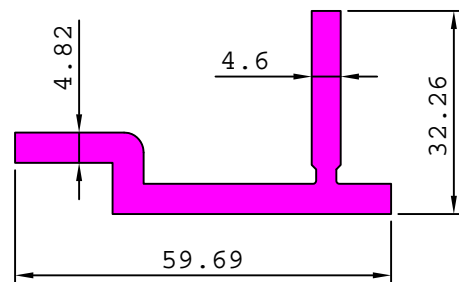

27456 1.547 kg/m

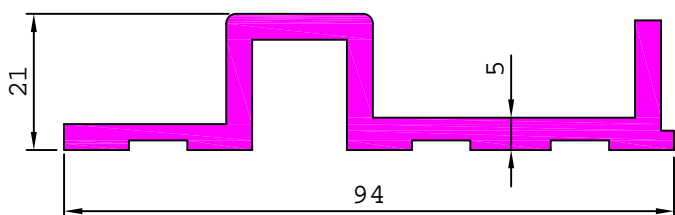

27461 1.888 kg/m

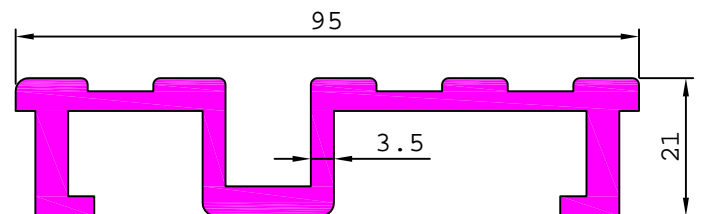

INDUSTRIAL

MISCELLANEOUS

27598 0.147 kg/m

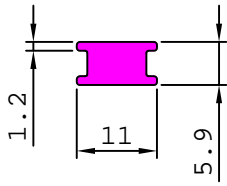

27599 0.297 kg/m

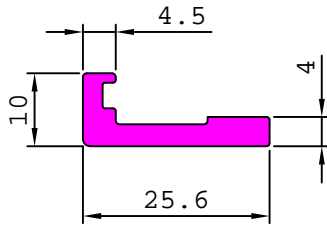

27600 1.205 kg/m

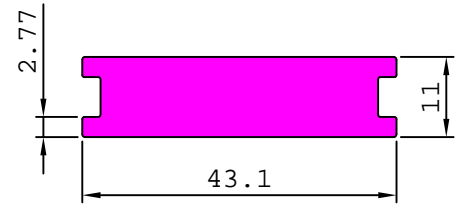

27473 0.214 kg/m

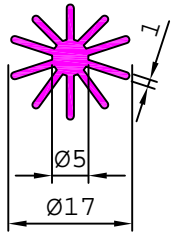

27479 0.458 kg/m

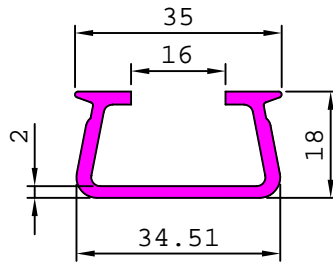

27486 0.202 kg/m

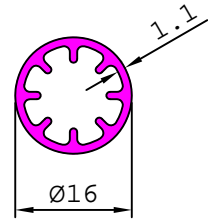

27501 0.428 kg/m

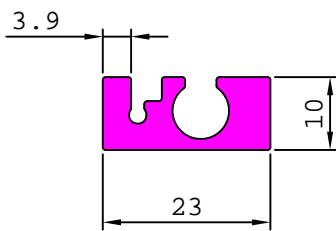

27553 0.612 kg/m

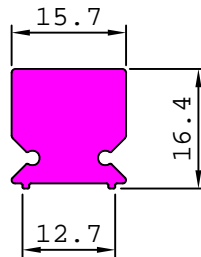

27554 0.193 kg/m

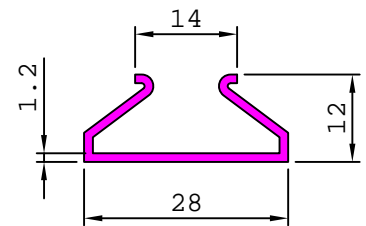

27510 1.397 kg/m

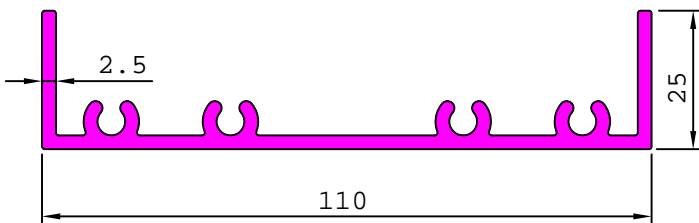

27533 1.499 kg/m

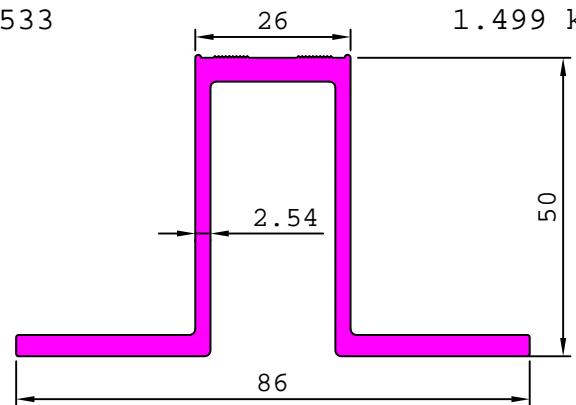

27538 0.467 kg/m

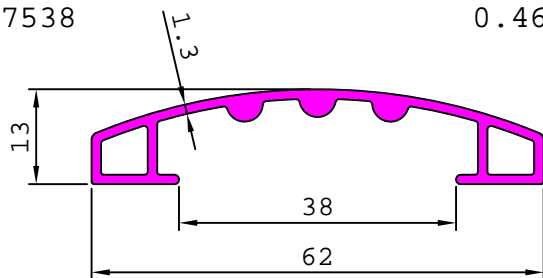

27542 0.661 kg/m

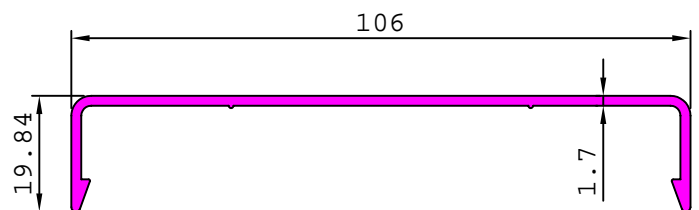

INDUSTRIAL

MISCELLANEOUS

27534 1.335 kg/m

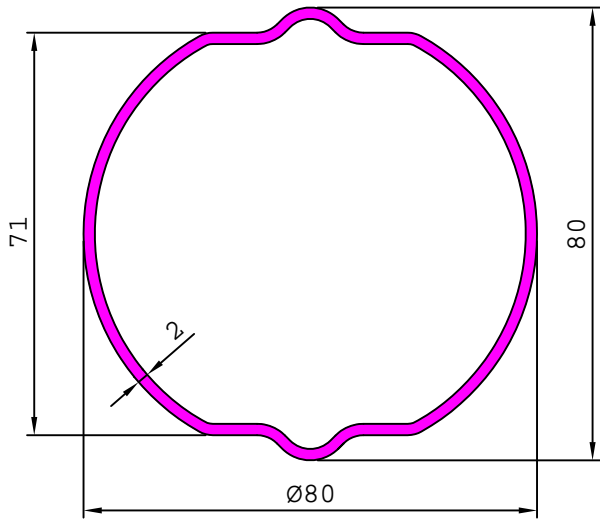

27543 3.780 kg/m

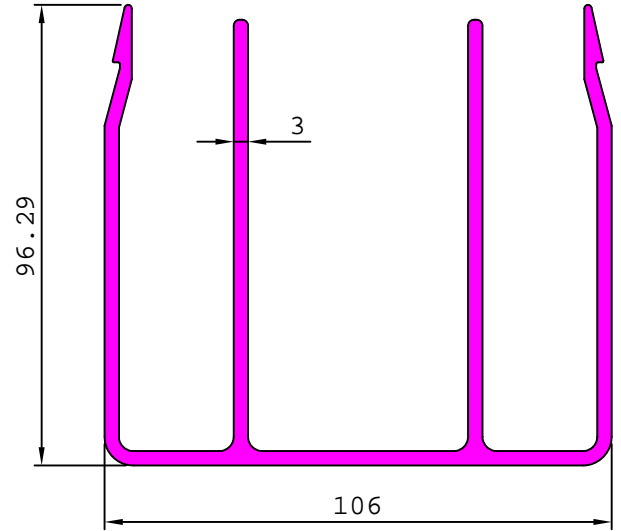

27555 2.134 kg/m

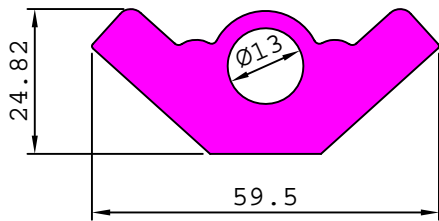

27560 0.416 kg/m

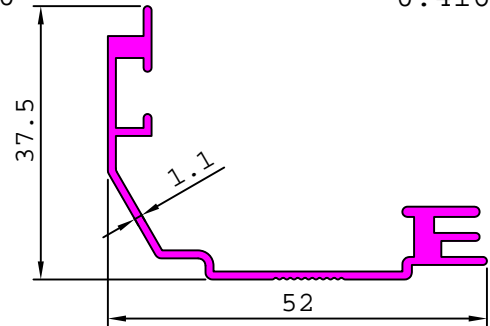

27574 0.713 kg/m

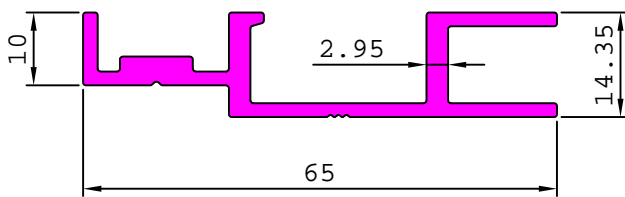

27580 3.962 kg/m

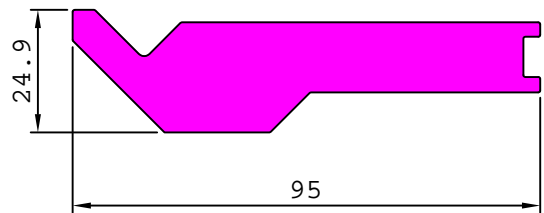

27578 14.545 kg/m

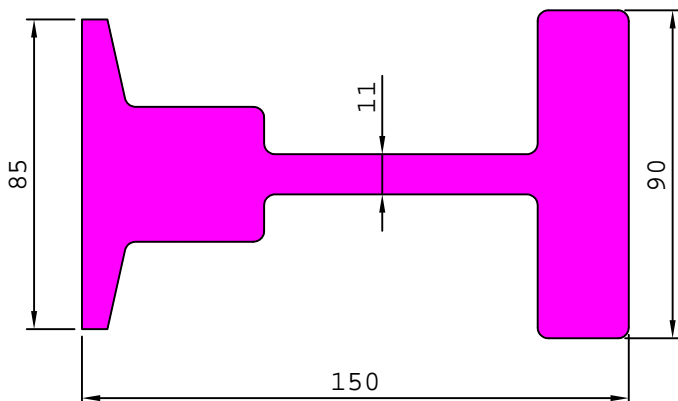

27579 6.126 kg/m

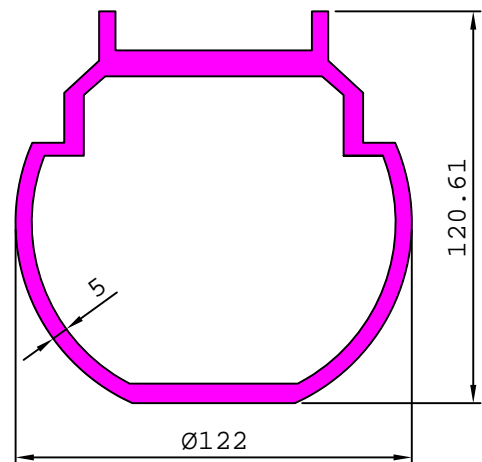

INDUSTRIAL

MISCELLANEOUS

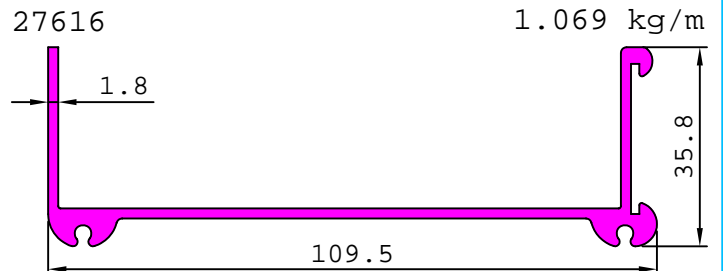
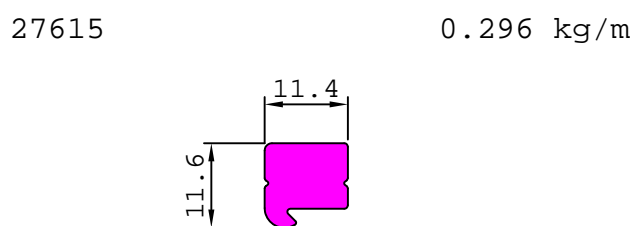
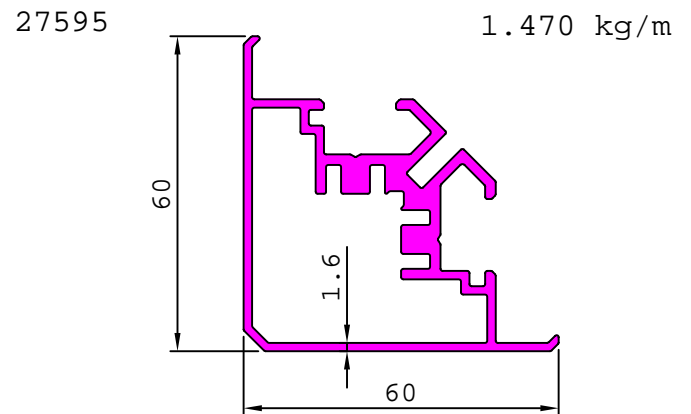
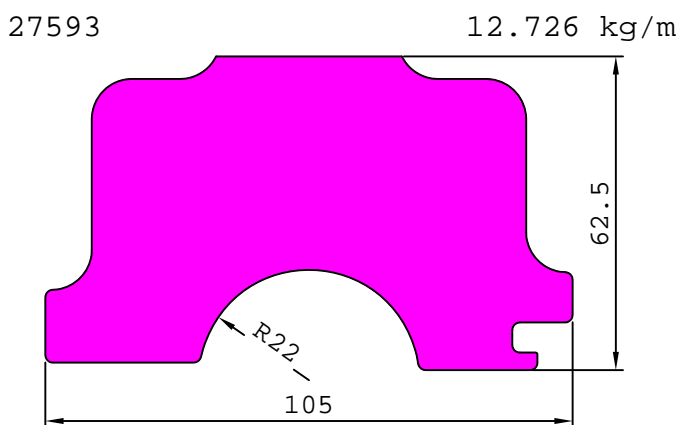
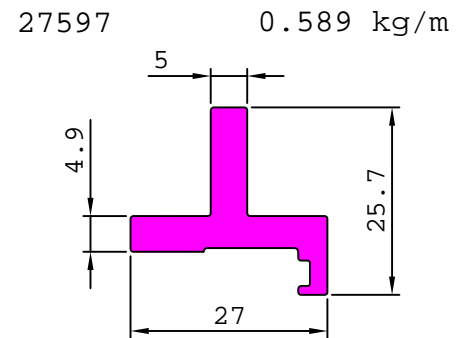
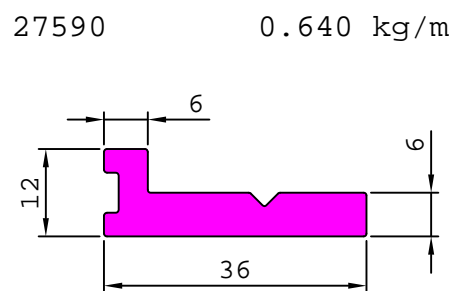
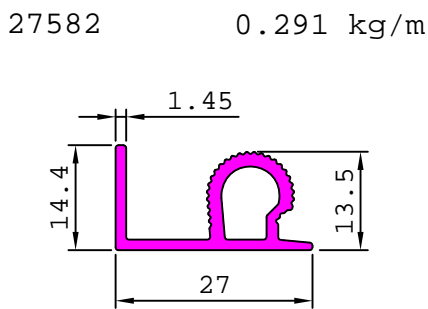
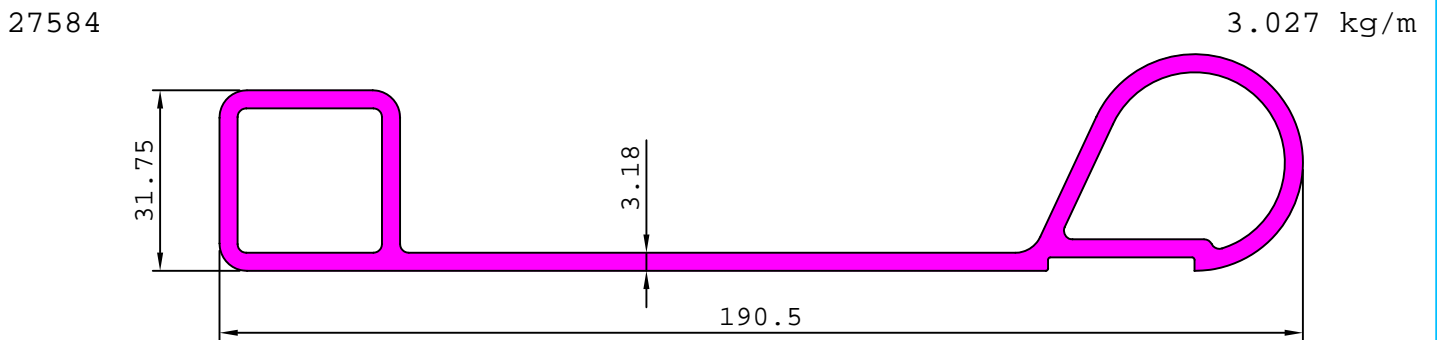
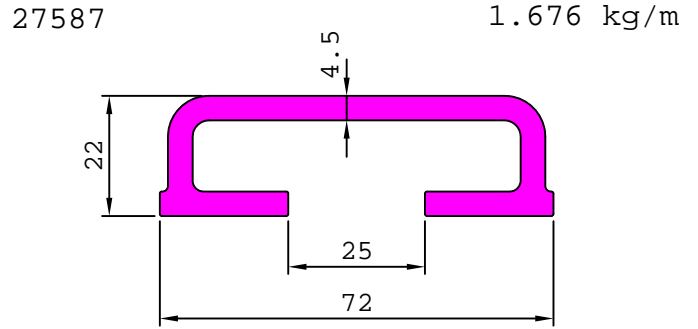
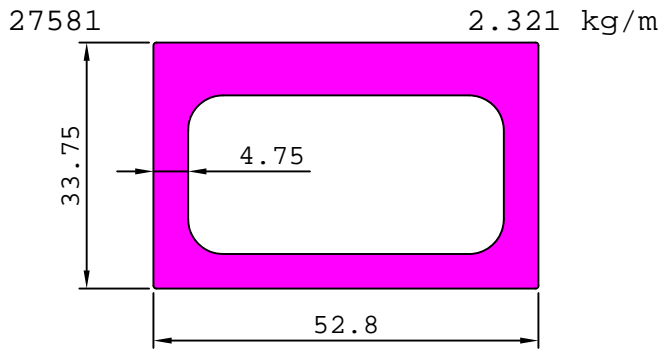

INDUSTRIAL

MISCELLANEOUS

27601

12.261 kg/m

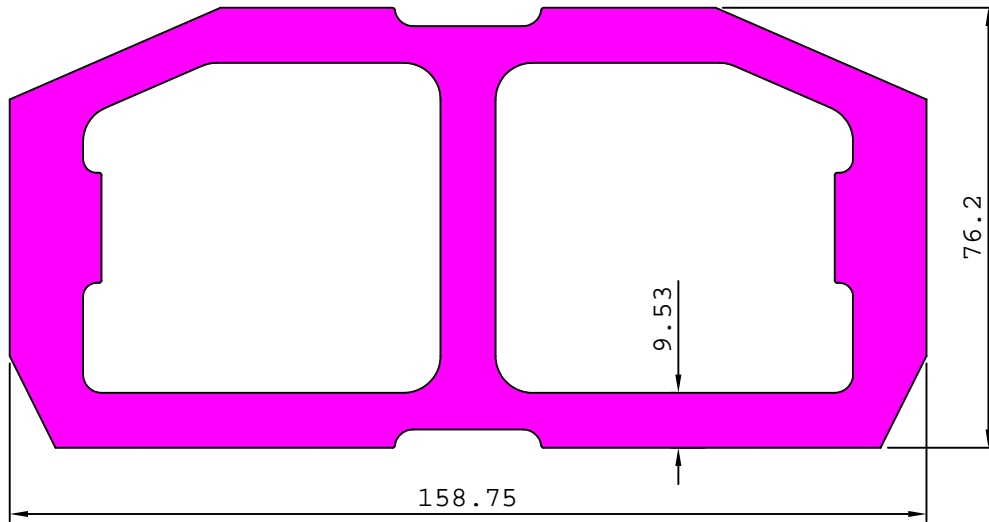

27611

2.256 kg/m

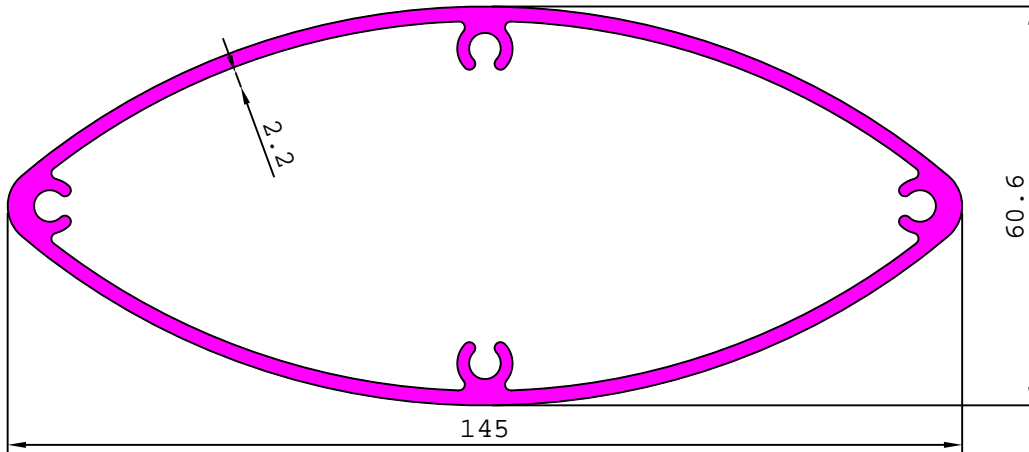

27623

1.295 kg/m

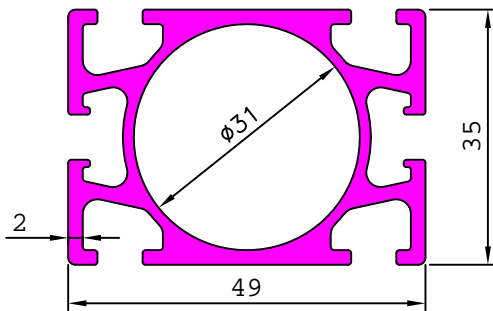

27637

1.345 kg/m

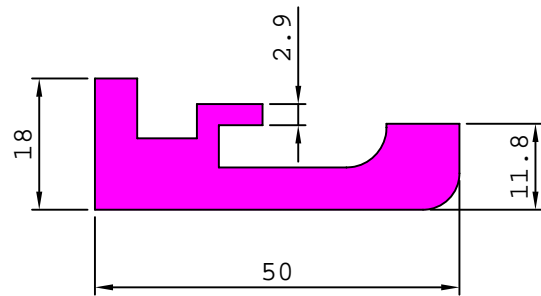

27624

0.897 kg/m

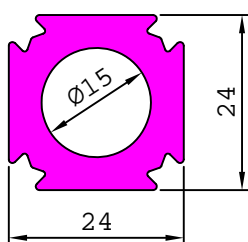

27625

0.439 kg/m

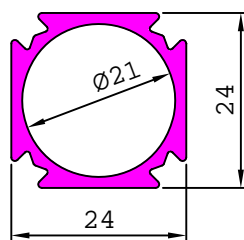

27626

0.576 kg/m

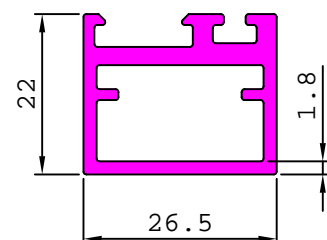

INDUSTRIAL

MISCELLANEOUS

28181

4.373 kg/m

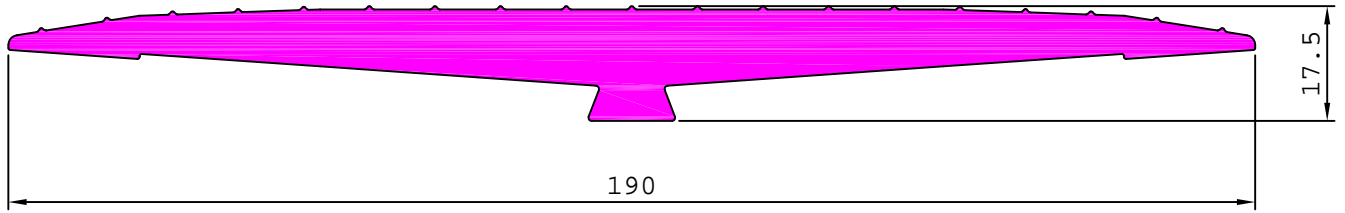

27638

4.860 kg/m

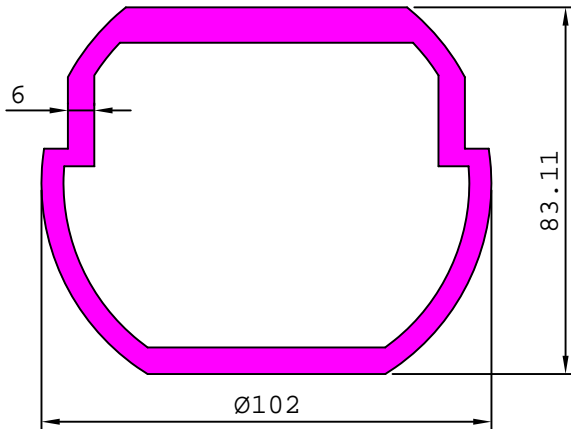

27677

8.176 kg/m

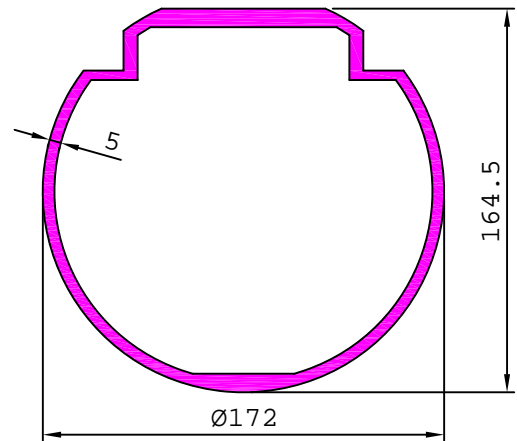

27648

0.340 kg/m

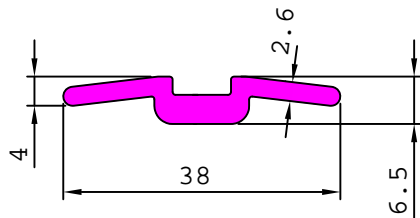

27643

1.308 kg/m

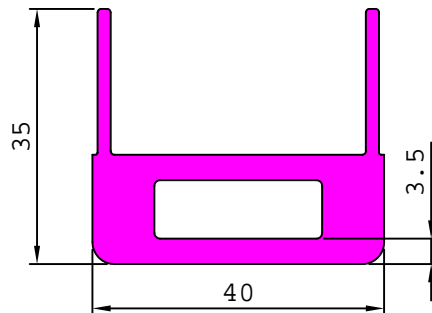

27710

0.719 kg/m

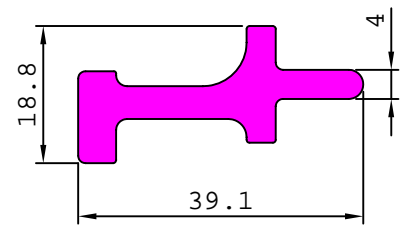

27651

12.893 kg/m

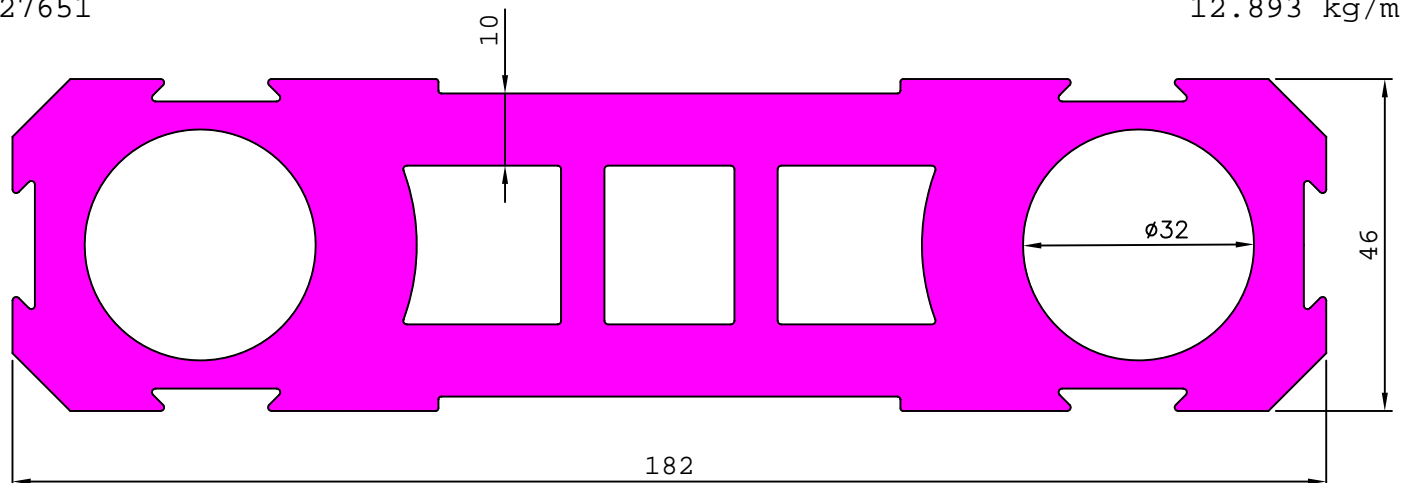

INDUSTRIAL

MISCELLANEOUS

27669

3.960 kg/m

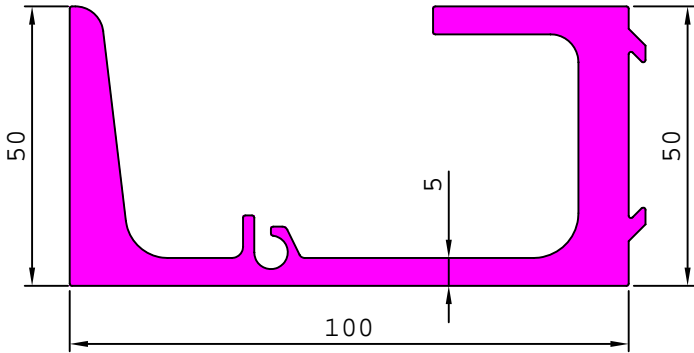

27706

2.774 kg/m

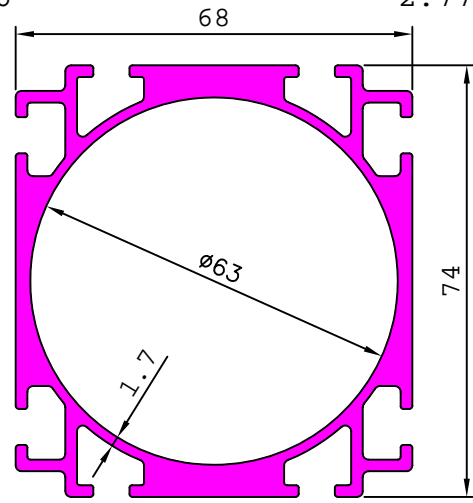

27707

37.462 kg/m

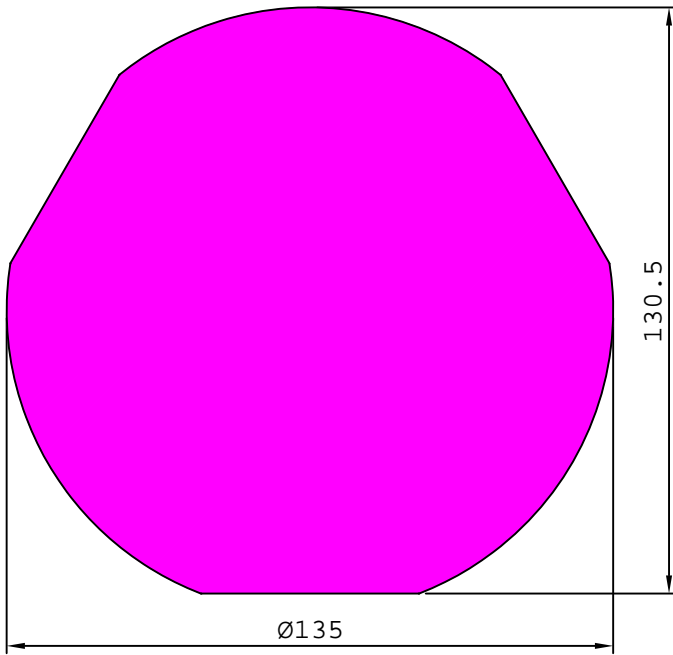

27711

0.801 kg/m

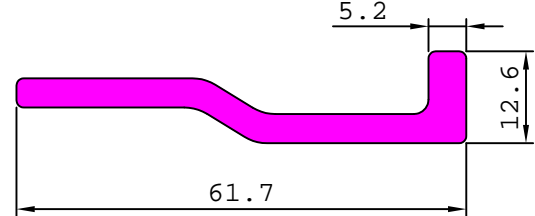

27716

2.861 kg/m

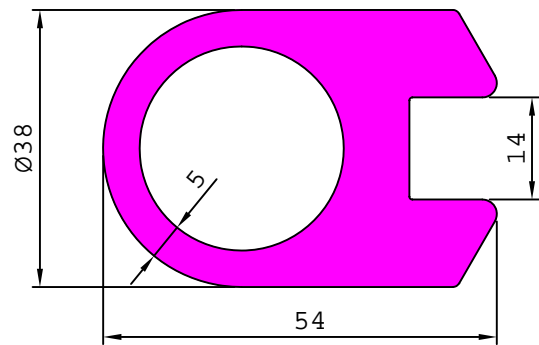

27717

1.082 kg/m

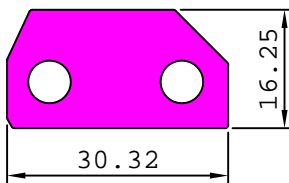

27715

0.187 kg/m

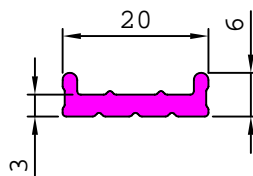

27713

1.892 kg/m

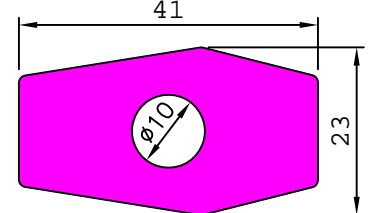

27724

0.694 kg/m

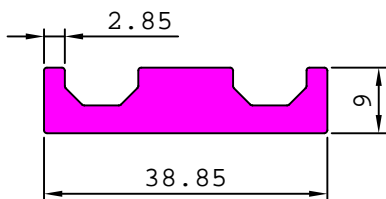

27731

0.153 kg/m

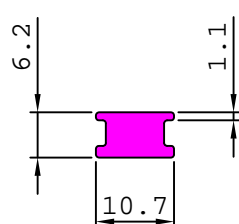

27733

0.159 kg/m

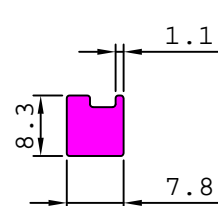

INDUSTRIAL

MISCELLANEOUS

27727

1.118 kg/m

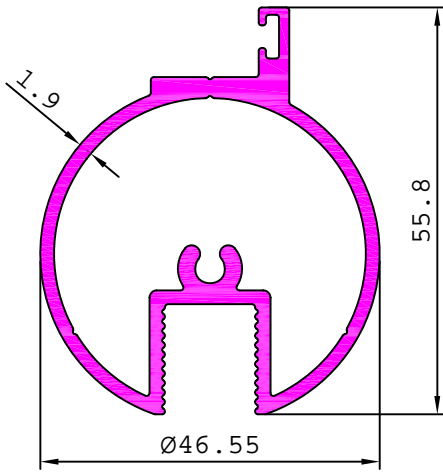

27730

1.017 kg/m

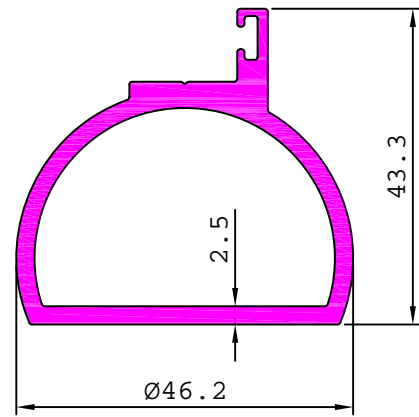

27728

7.724 kg/m

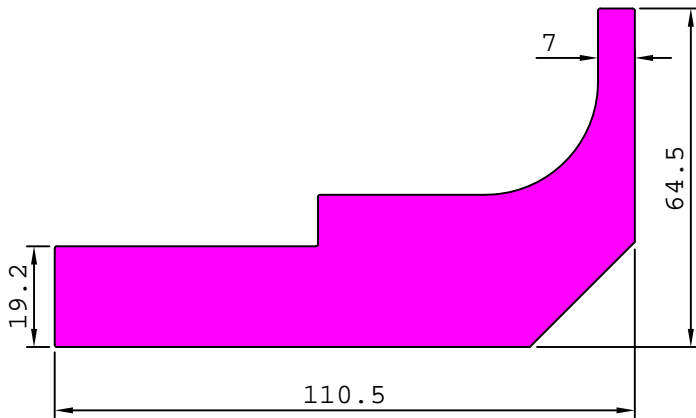

27734

2.120 kg/m

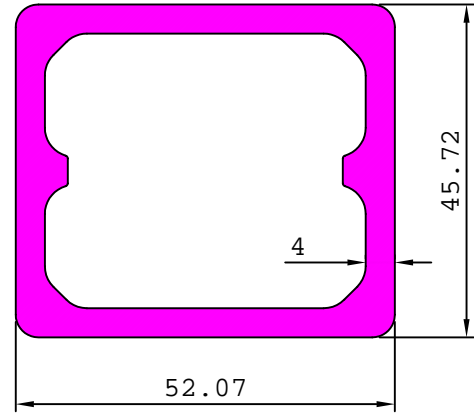

27744

0.260 kg/m

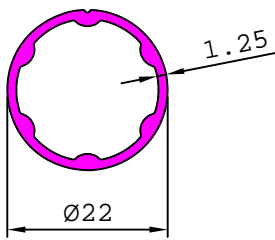

27750

1.081 kg/m

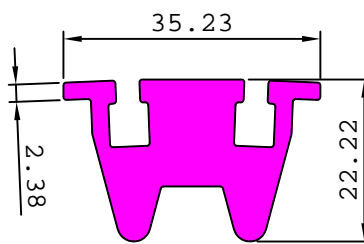

27762

1.029 kg/m

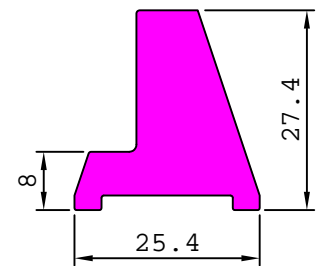

27745

1.382 kg/m

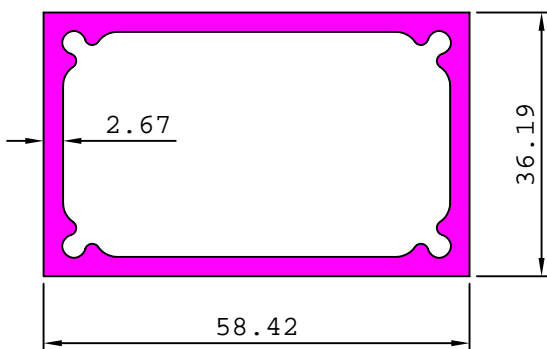

27754

2.653 kg/m

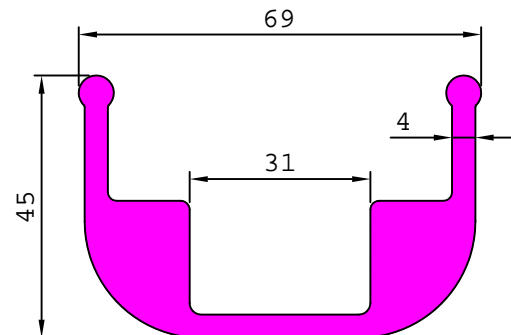

INDUSTRIAL

MISCELLANEOUS

27749 3.608 kg/m

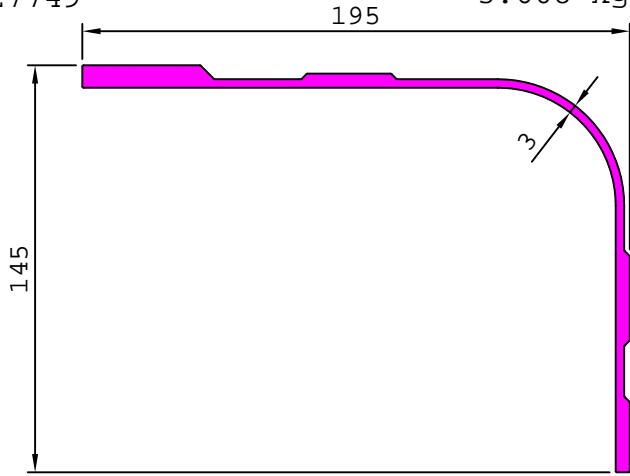

27760 0.458 kg/m

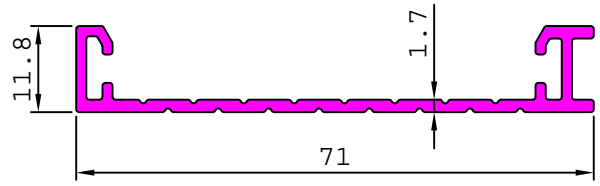

27765 1.506 kg/m

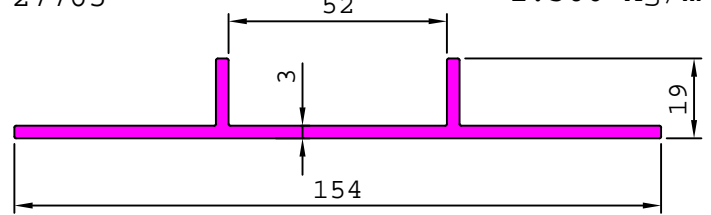

27772 0.301 kg/m

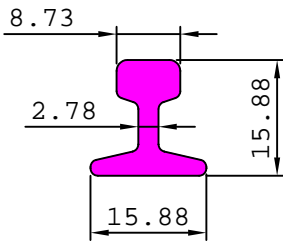

27774 0.224 kg/m

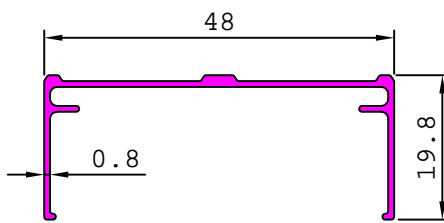

27777 0.143 kg/m

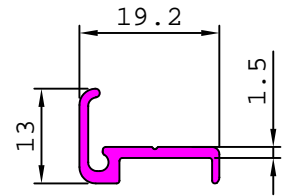

27775

3.987 kg/m

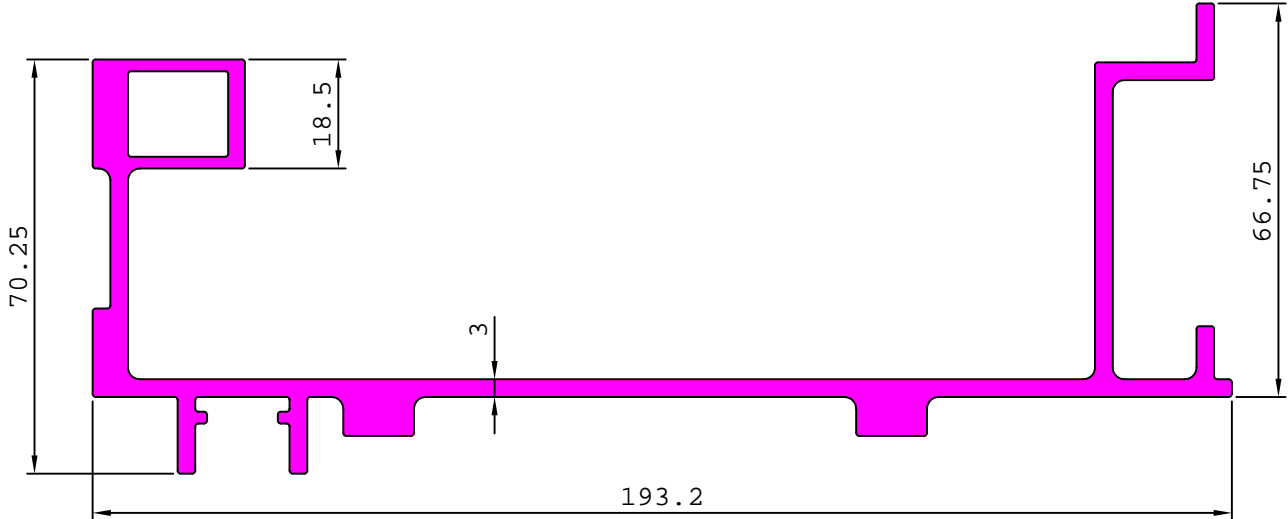

27778 0.343 kg/m

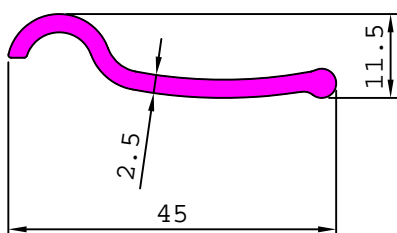

27779 0.431 kg/m

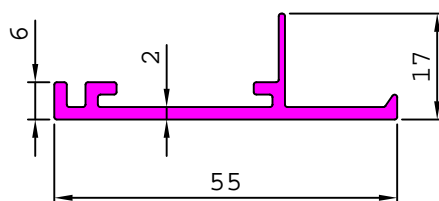

27783 0.083 kg/m

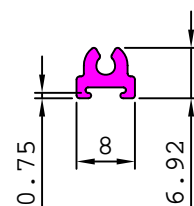

INDUSTRIAL

MISCELLANEOUS

27780

1.195 kg/m

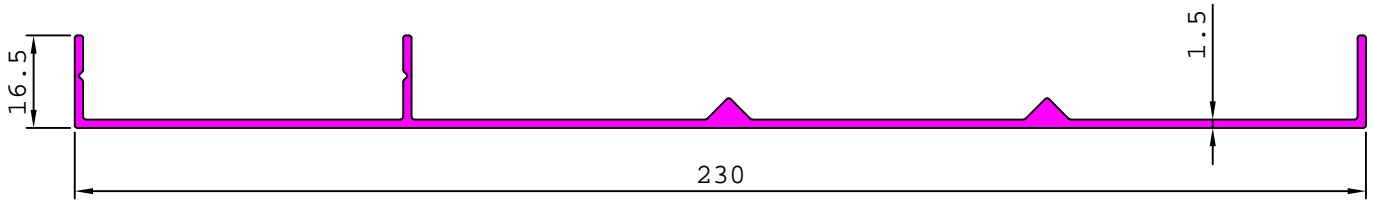

27784

0.979 kg/m

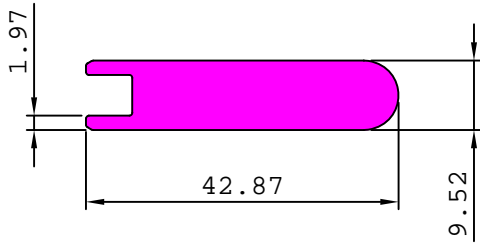

27788

0.264 kg/m

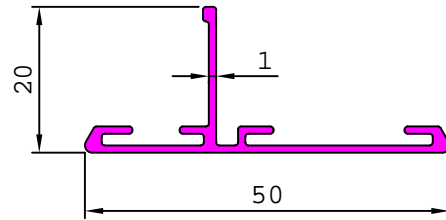

27785

2.107 kg/m

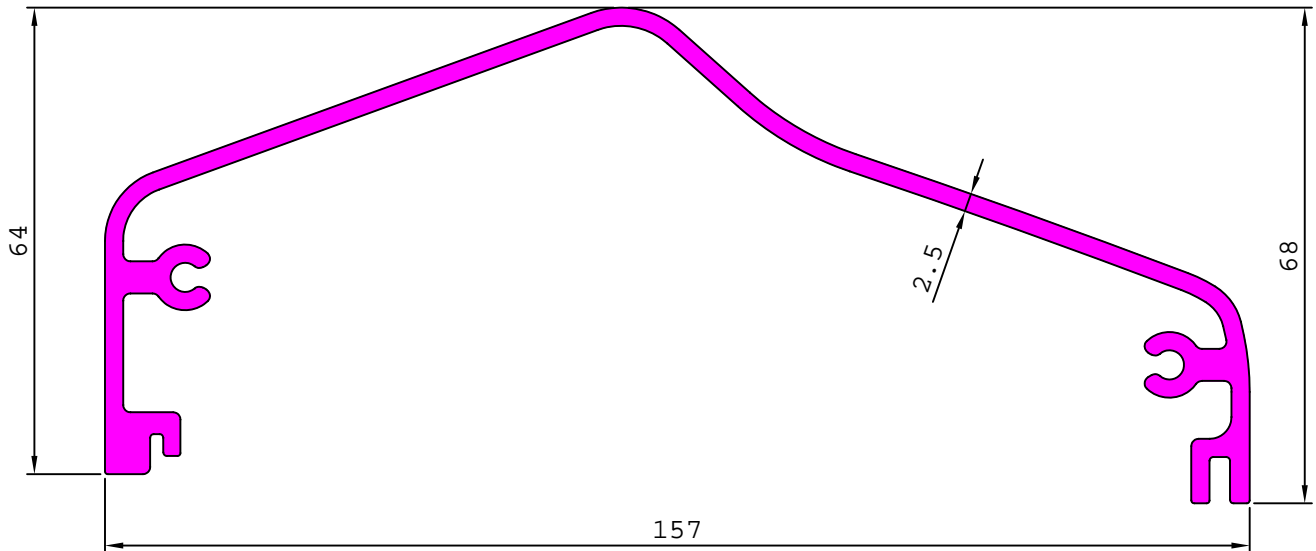

27786

1.139 kg/m

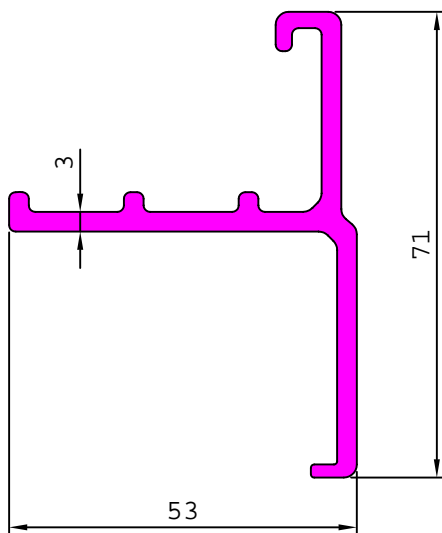

27787

0.631 kg/m

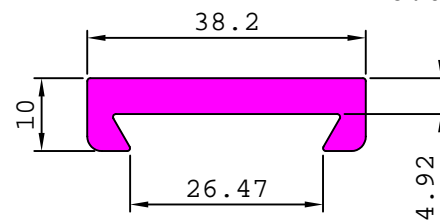

27799

0.492 kg/m

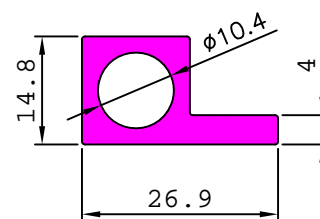

INDUSTRIAL

MISCELLANEOUS

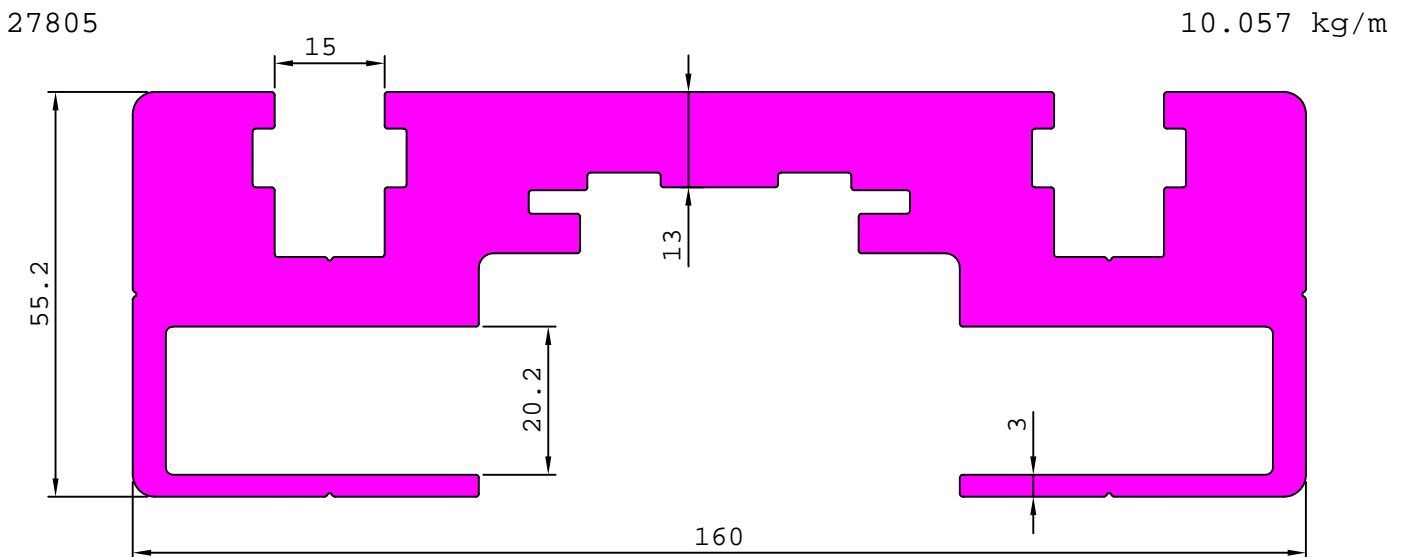
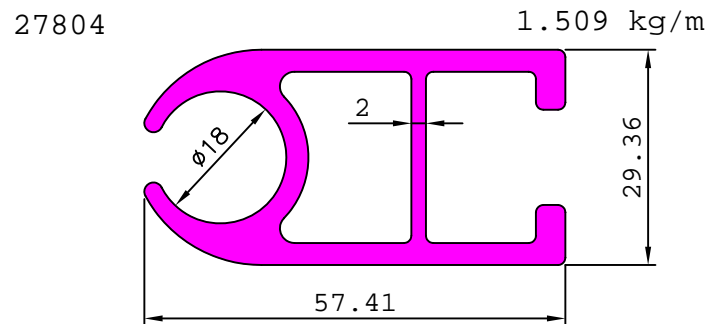
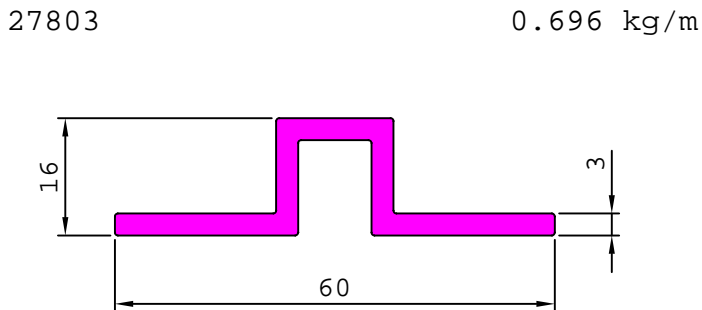
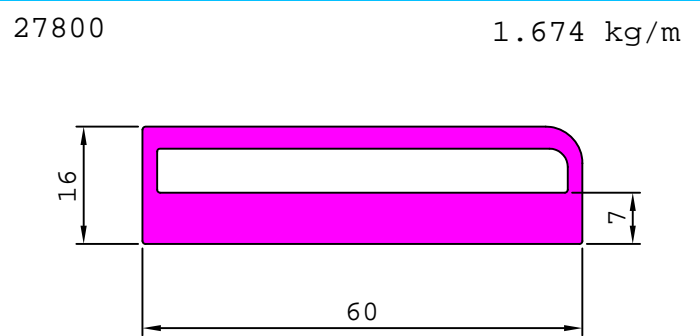
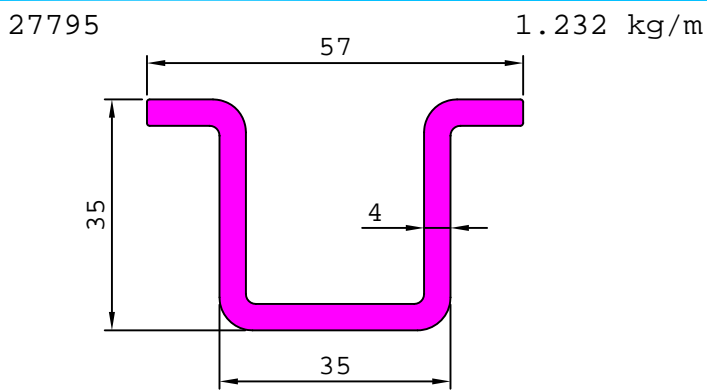
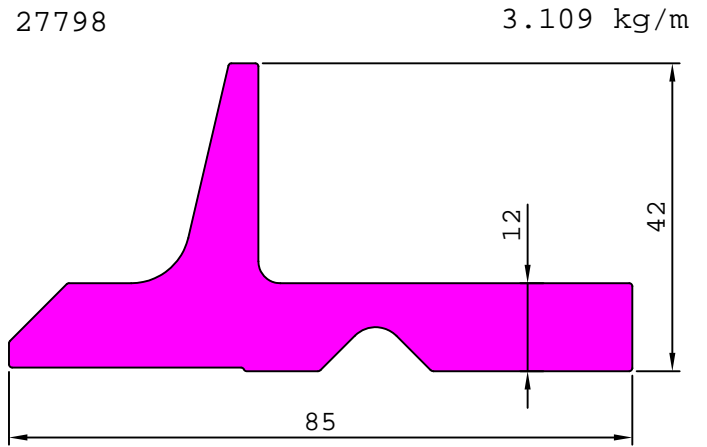
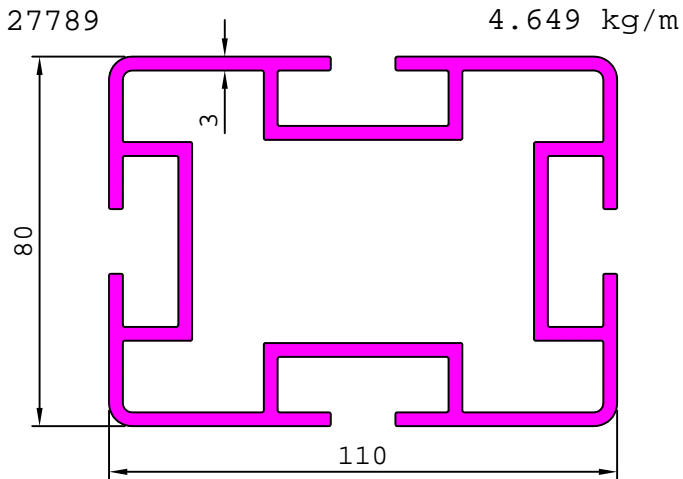

INDUSTRIAL

MISCELLANEOUS

27806 0.306 kg/m

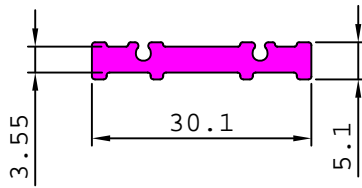

27809 0.312 kg/m

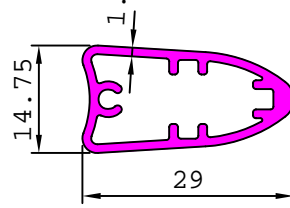

27838 0.816 kg/m

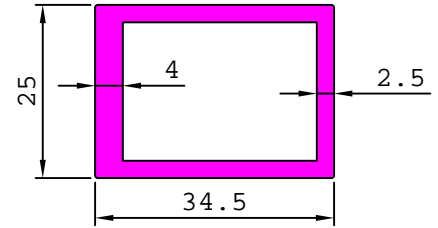

27812 0.706 kg/m

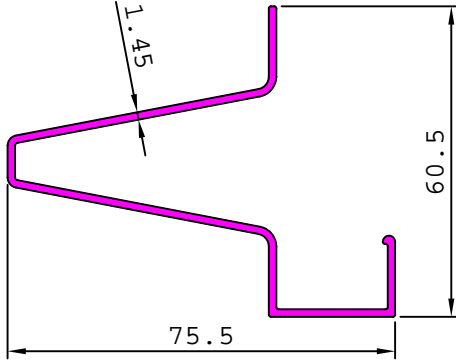

27813 1.155 kg/m

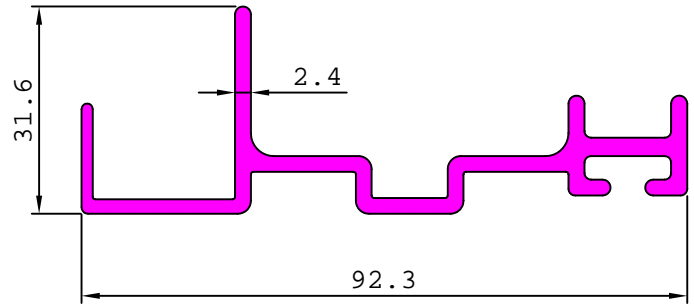

27815

12.930 kg/m

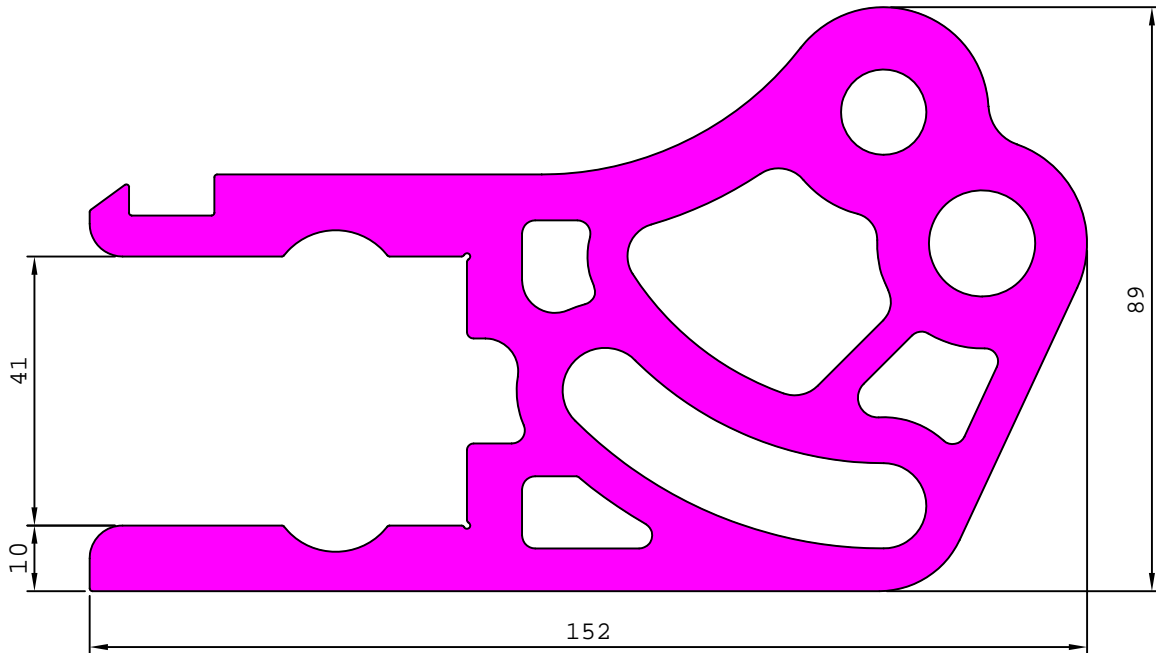

27816

2.641 kg/m

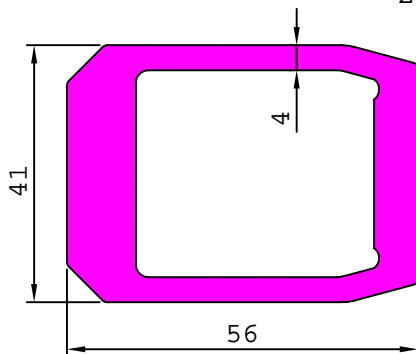

27817

9.128 kg/m

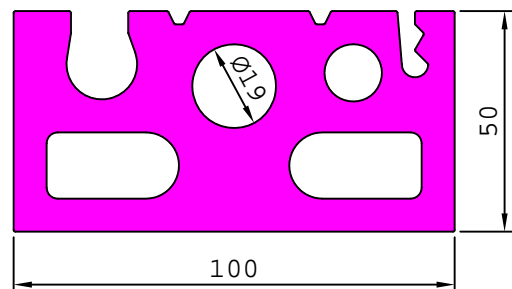

INDUSTRIAL

MISCELLANEOUS

27827

5.984 kg/m

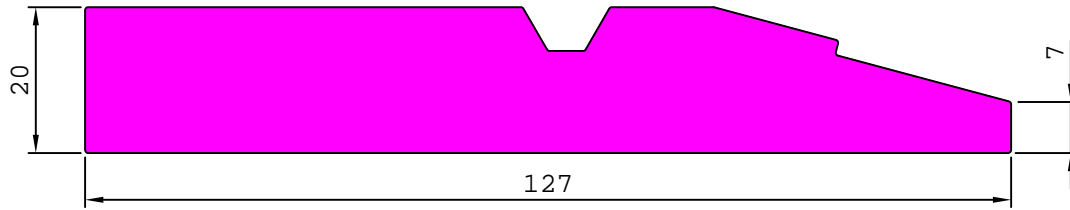

27831

2.938 kg/m

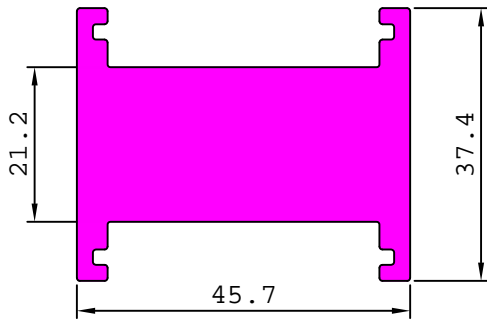

27844

0.813 kg/m

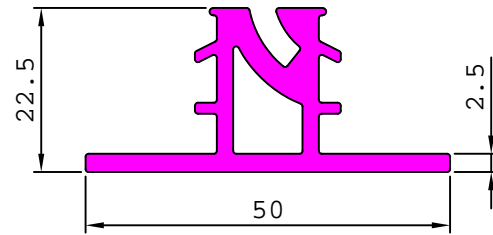

27845

4.082 kg/m

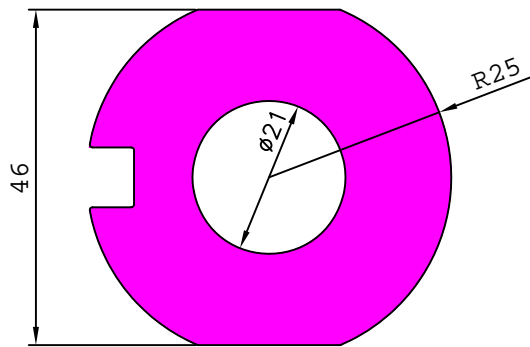

27847

1.285 kg/m

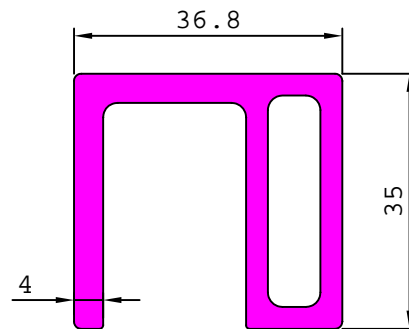

27848

2.010 kg/m

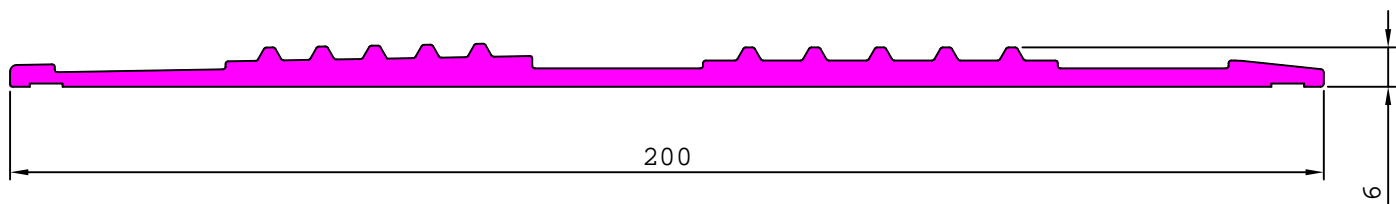

27851

1.494 kg/m

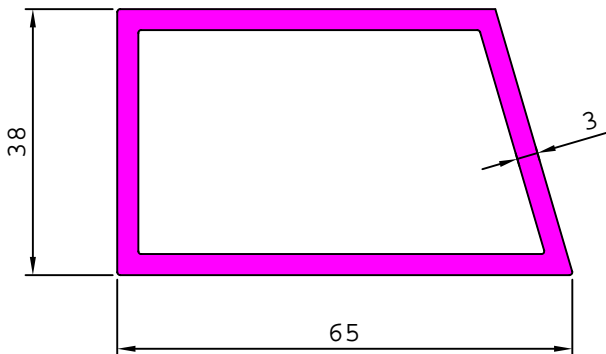

27853

2.025 kg/m

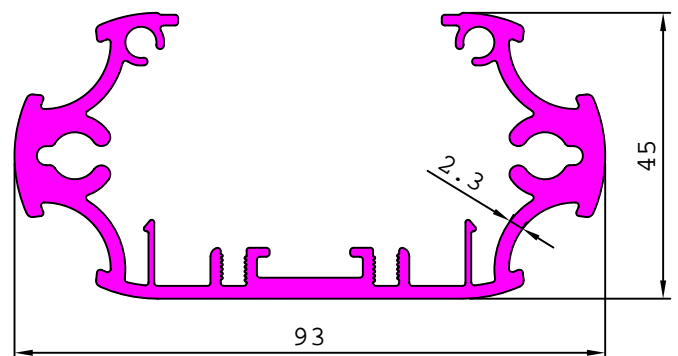

INDUSTRIAL

MISCELLANEOUS

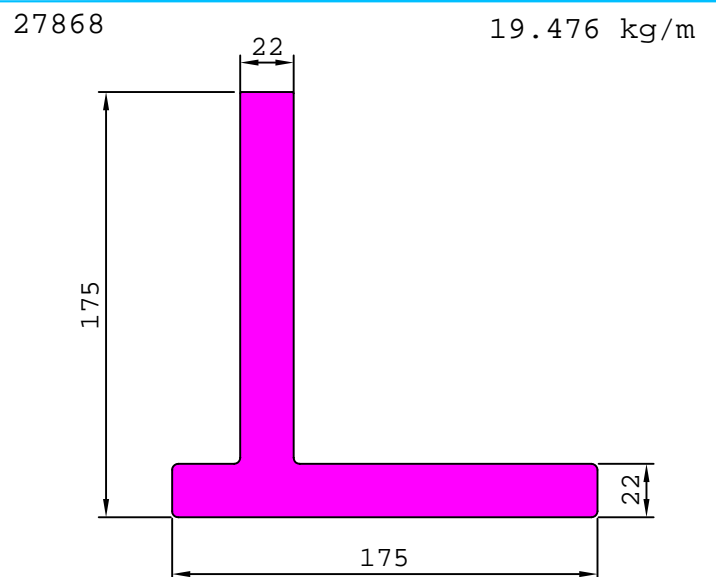
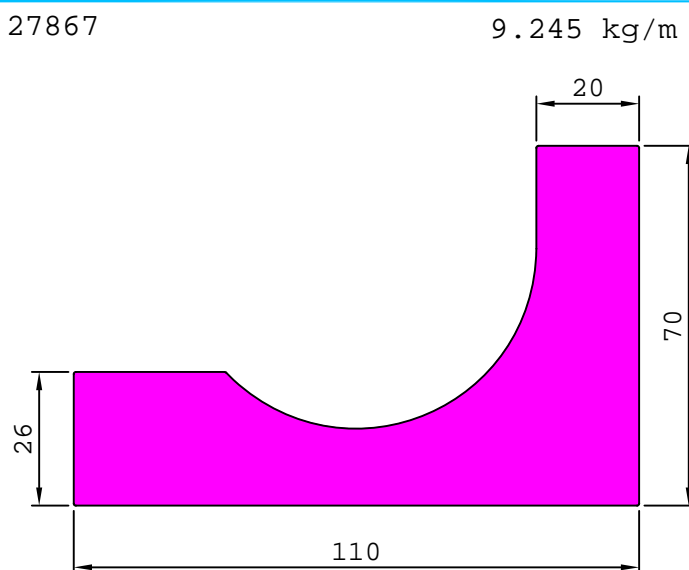
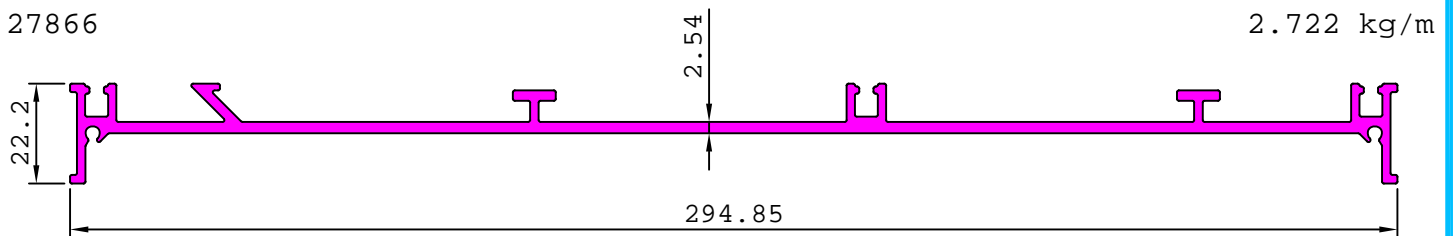
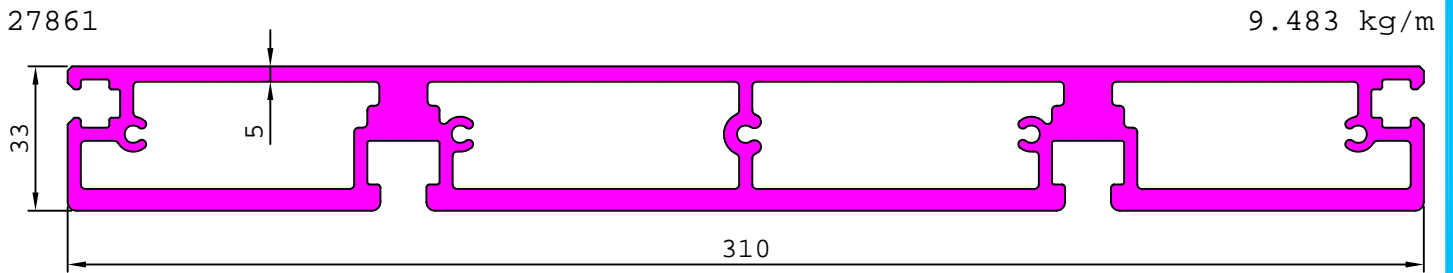
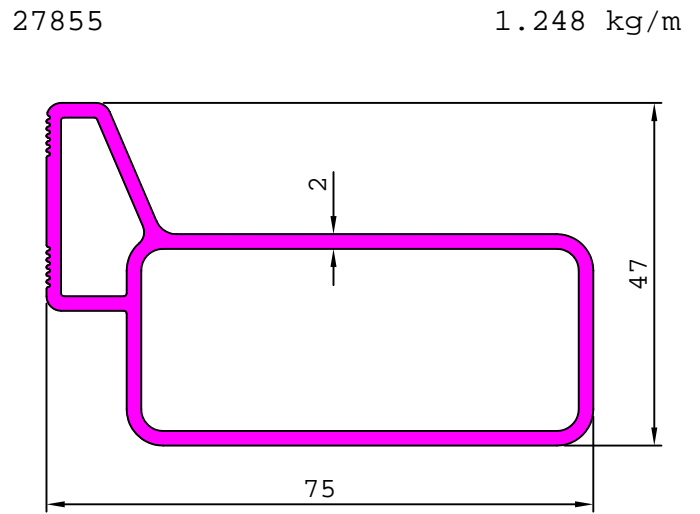
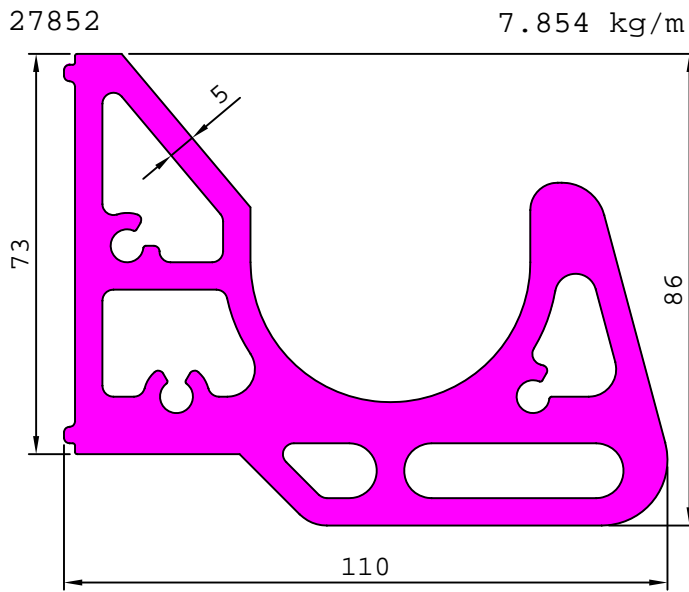

INDUSTRIAL

MISCELLANEOUS

27870

2.097 kg/m

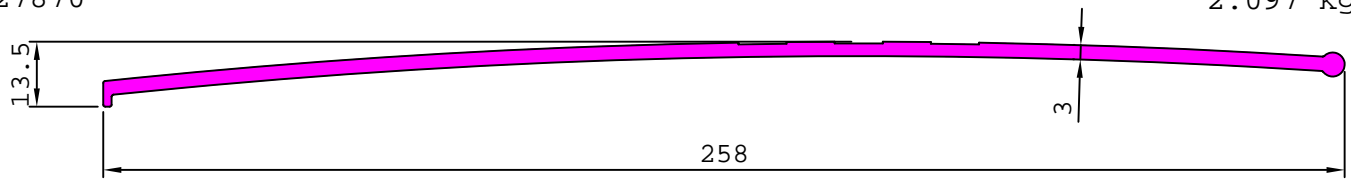

27875

0.999 kg/m

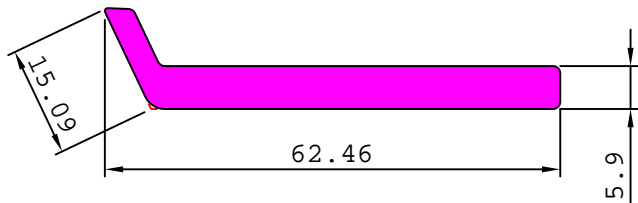

27877

5.789 kg/m

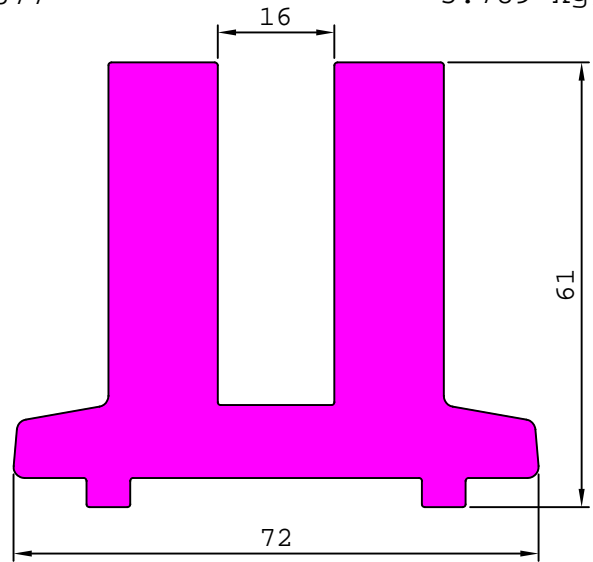

27880

5.278 kg/m

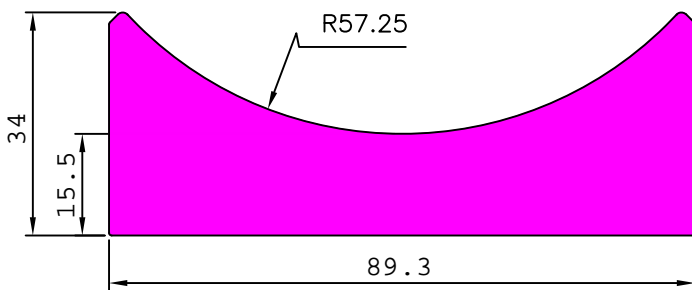

27881

1.831 kg/m

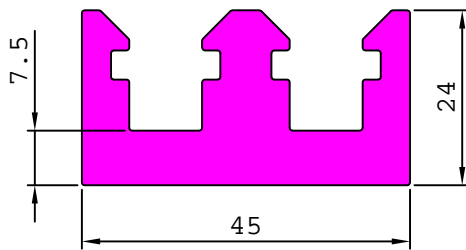

27885

10.099 kg/m

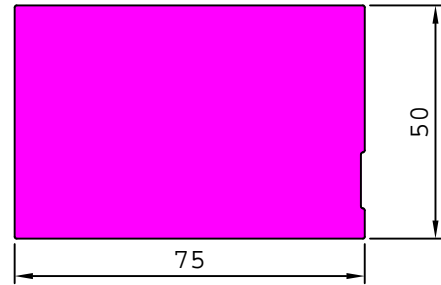

27886

3.401 kg/m

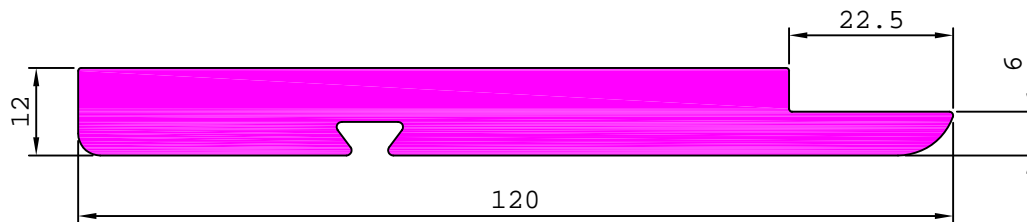

27887

6.435 kg/m

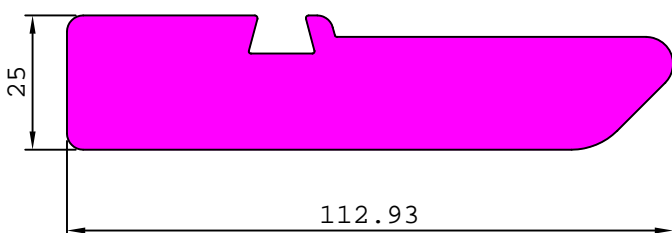

27895

3.297 kg/m

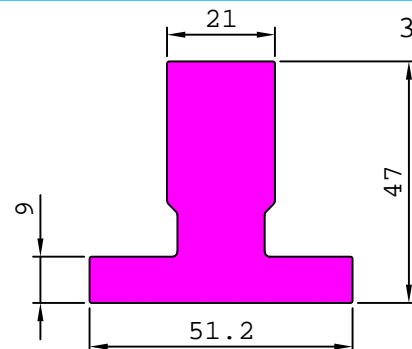

INDUSTRIAL

MISCELLANEOUS

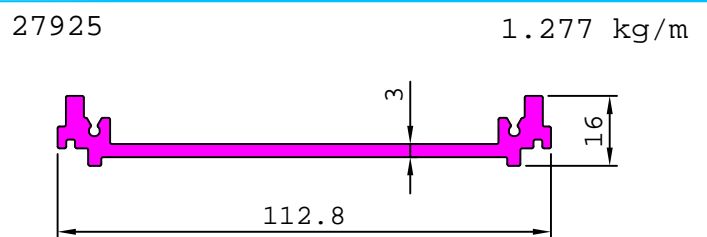
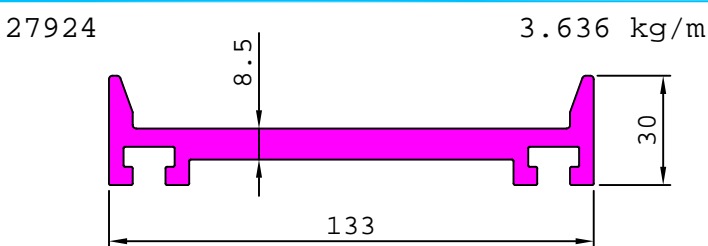
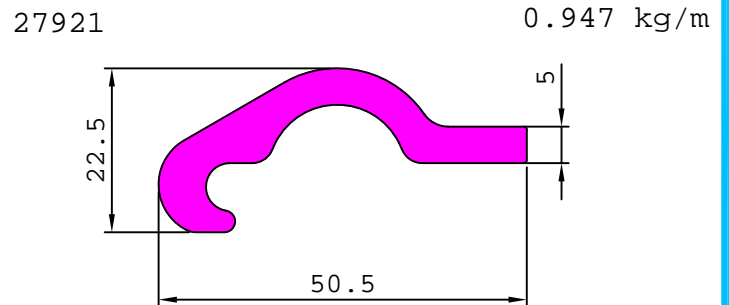
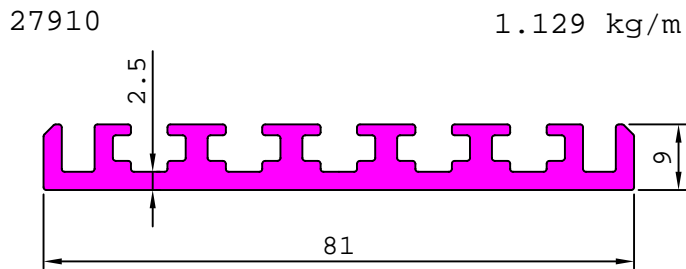
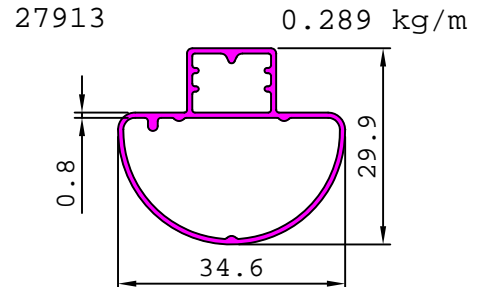
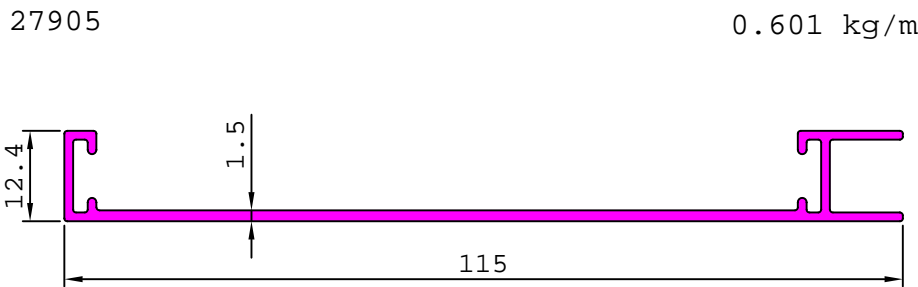
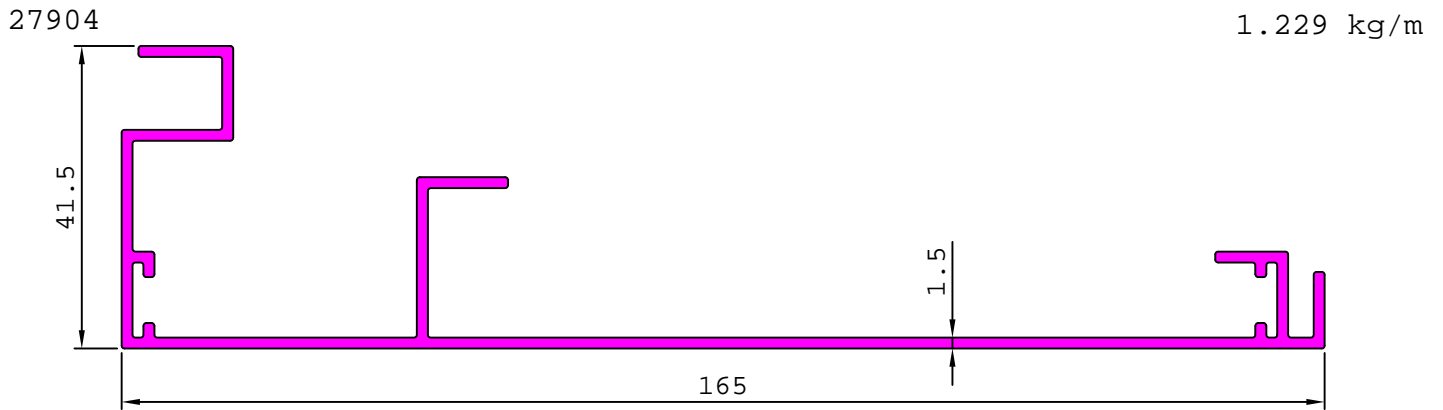
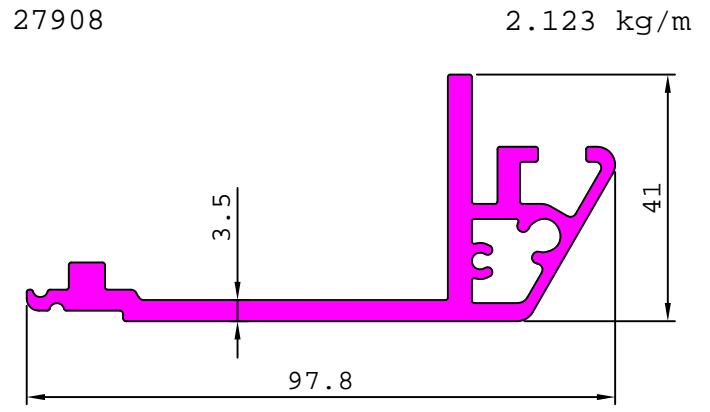
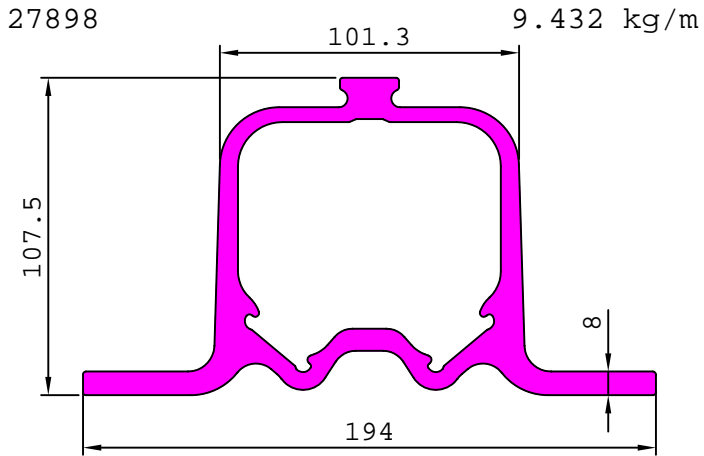

INDUSTRIAL

MISCELLANEOUS

27912

2.482 kg/m

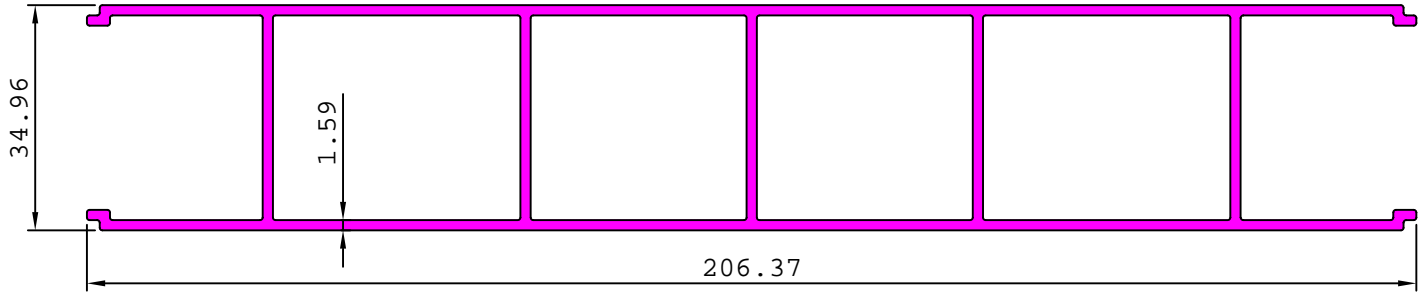

27914

3.691 kg/m

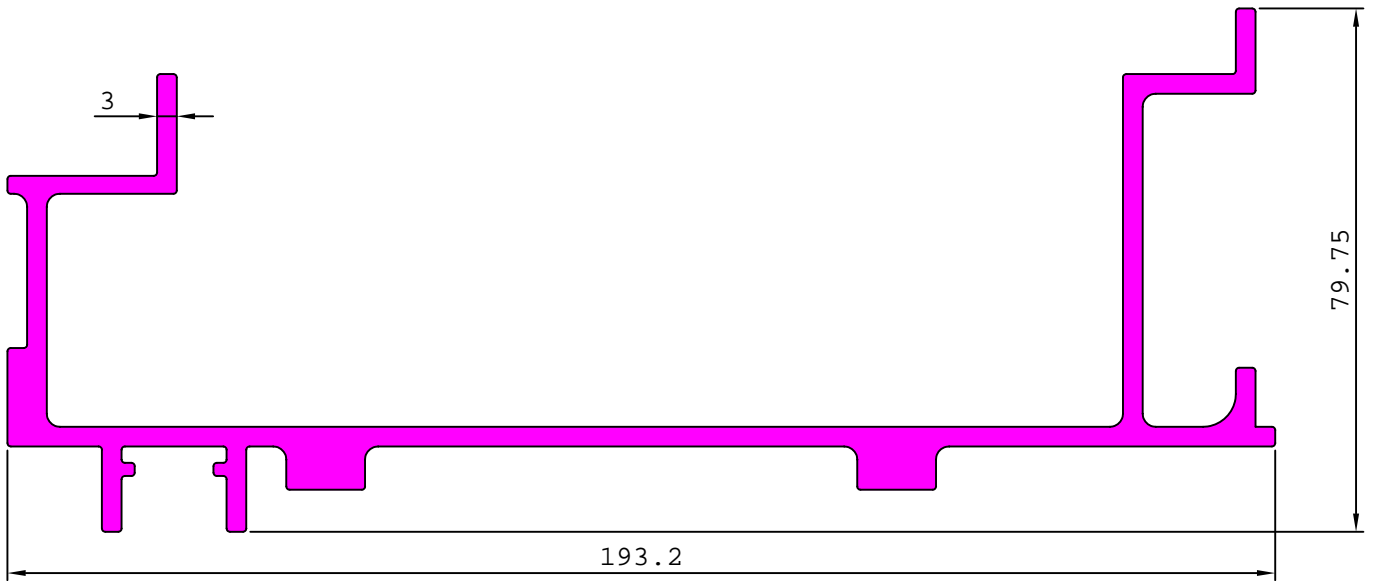

27920

31.644 kg/m

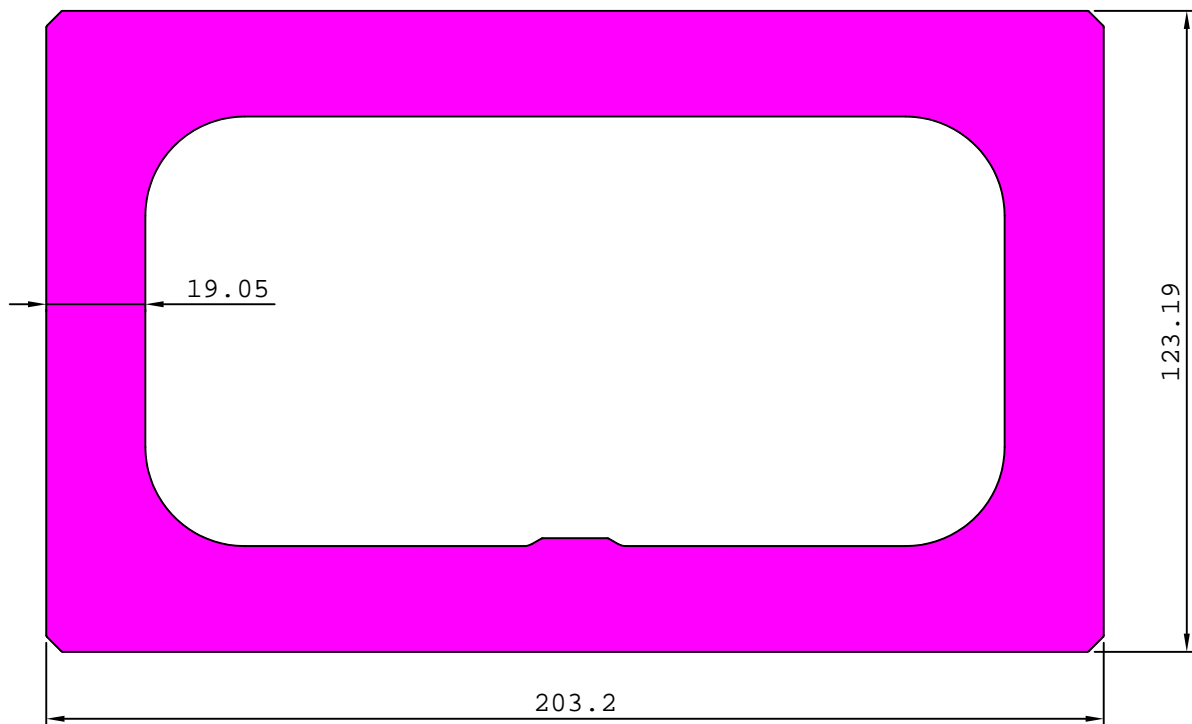

INDUSTRIAL

MISCELLANEOUS

27926 30.340 kg/m

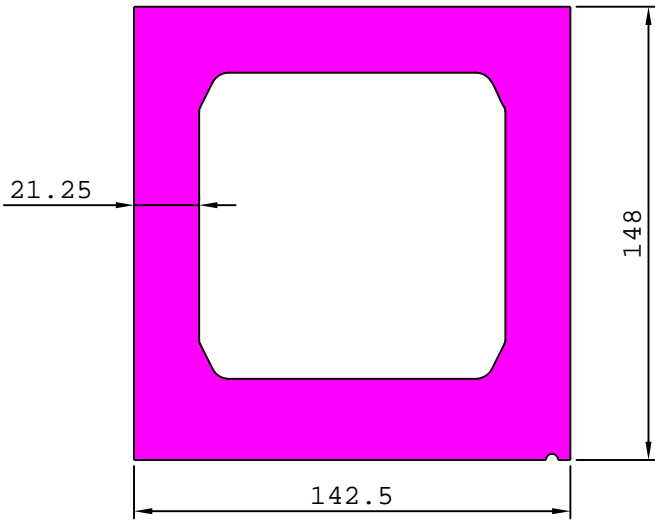

27928 5.604 kg/m

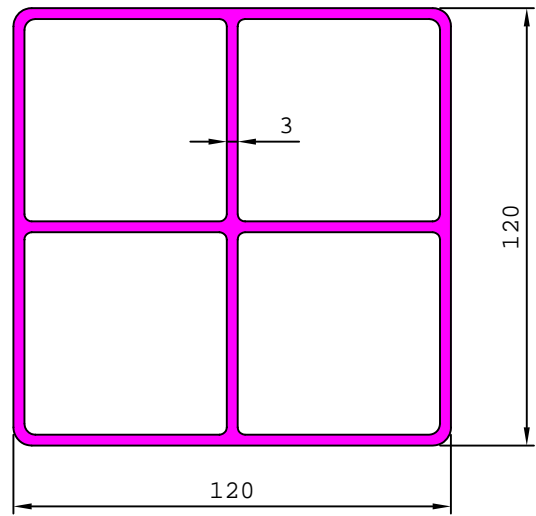

27929 1.015 kg/m

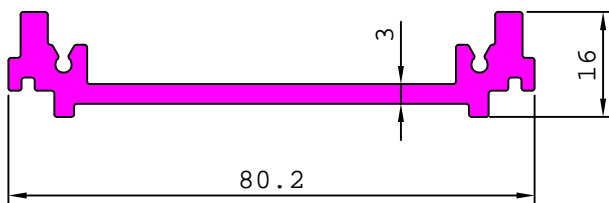

27935 $\varnothing 10.5$ 1.479 kg/m

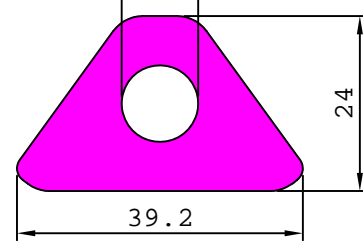

27932 1.459 kg/m

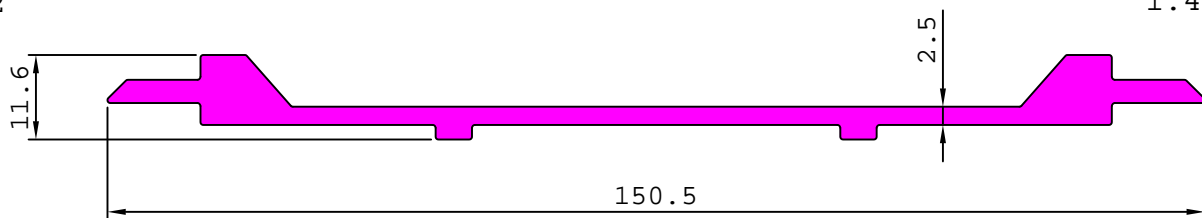

27936 2.665 kg/m

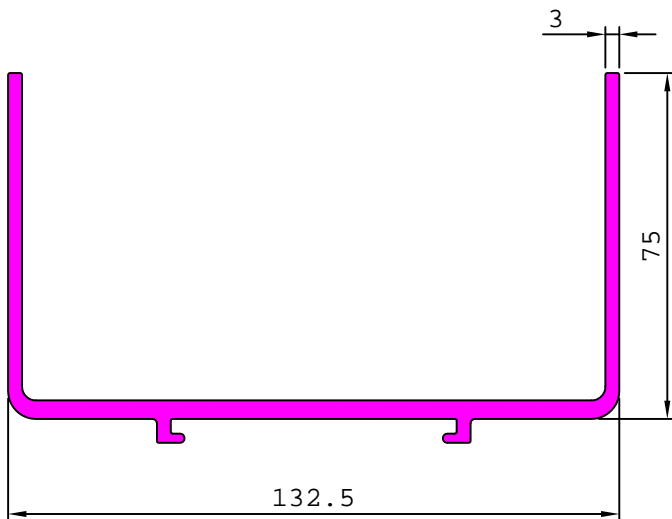

27941 3.966 kg/m

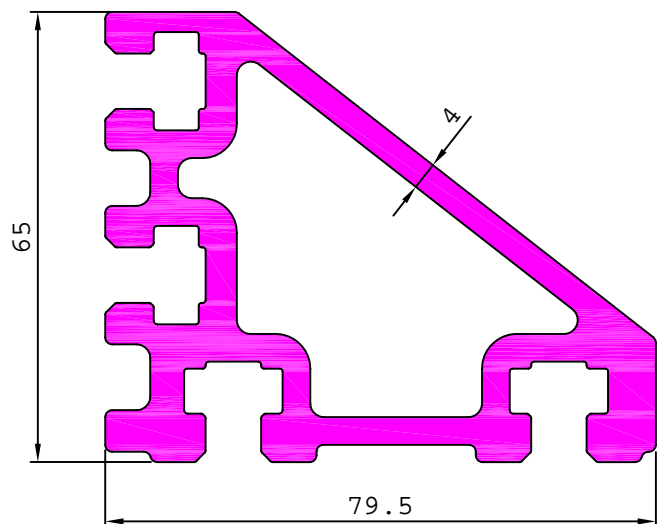

INDUSTRIAL

MISCELLANEOUS

27939 2.779 kg/m

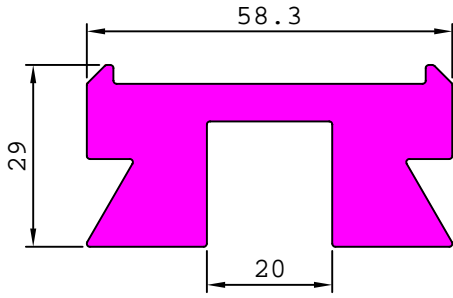

27937 4.974 kg/m

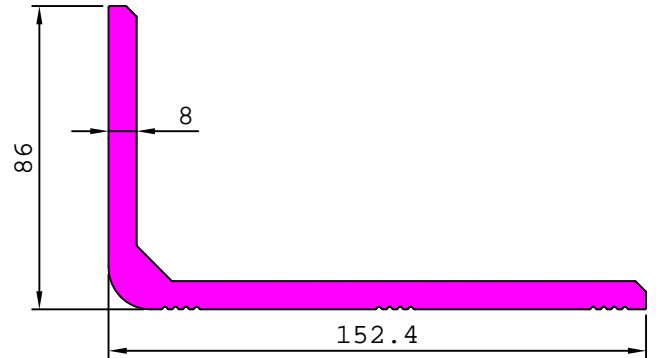

27943 0.449 kg/m

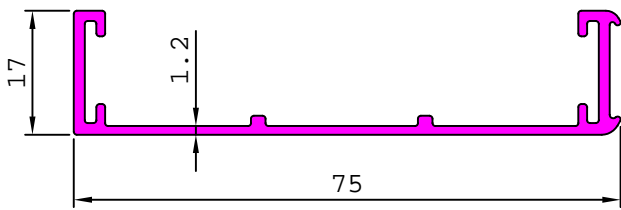

27953 0.418 kg/m

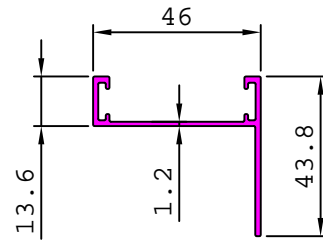

27947 15.581 kg/m

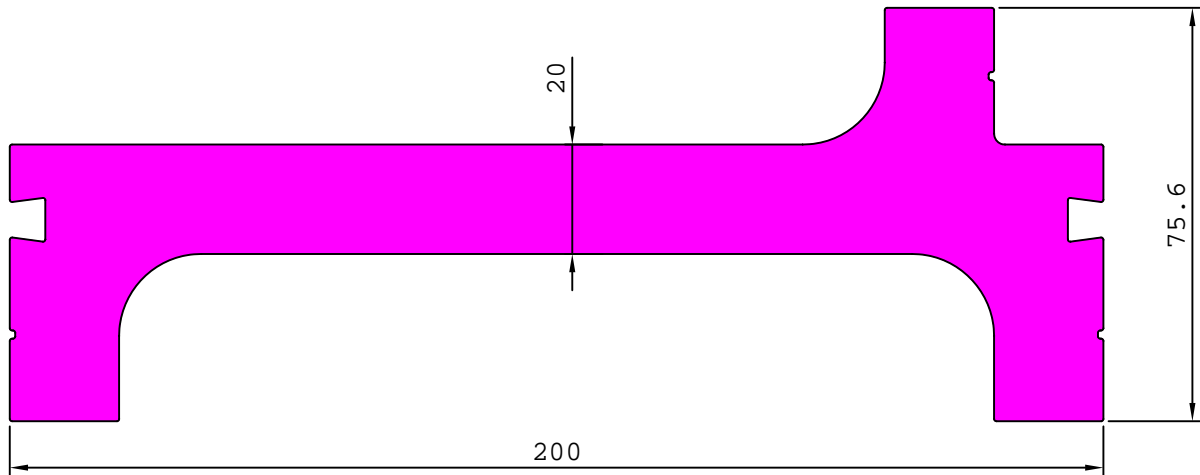

27948 3.522 kg/m

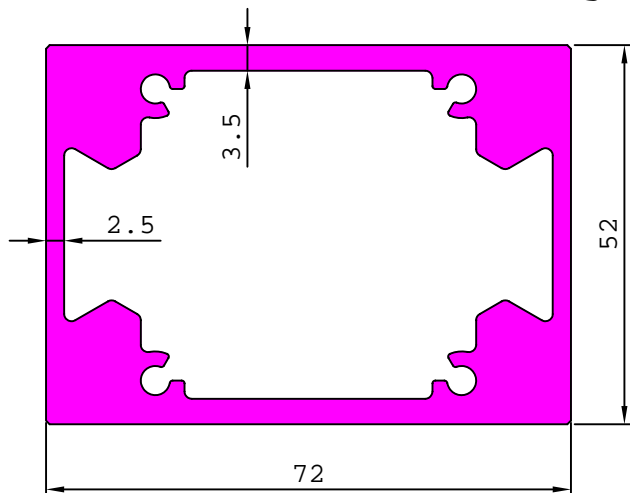

27958 0.270 kg/m

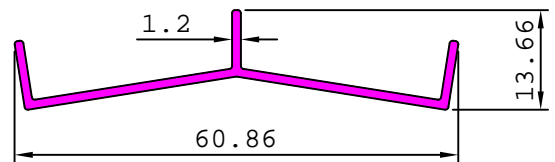

27970 1.116 kg/m

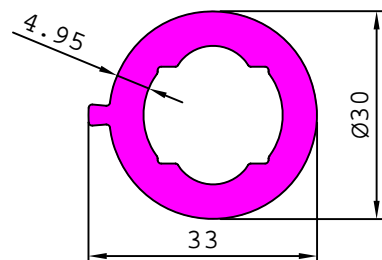

INDUSTRIAL

MISCELLANEOUS

27952

1.056 kg/m

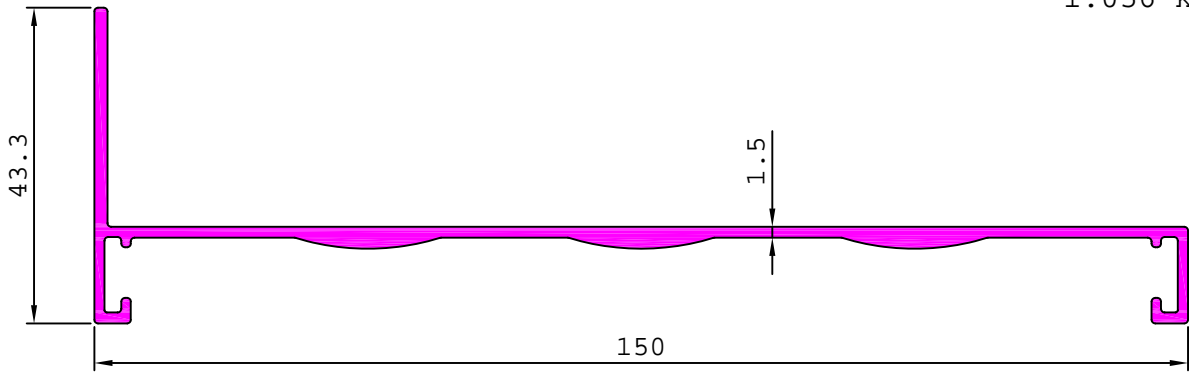

27965

4.309 kg/m

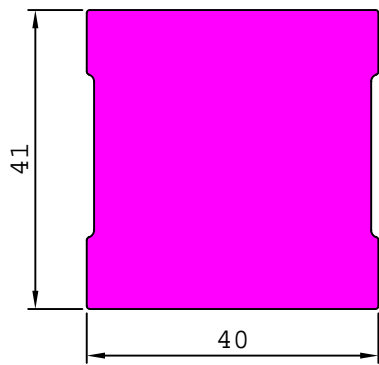

27968

8.256 kg/m

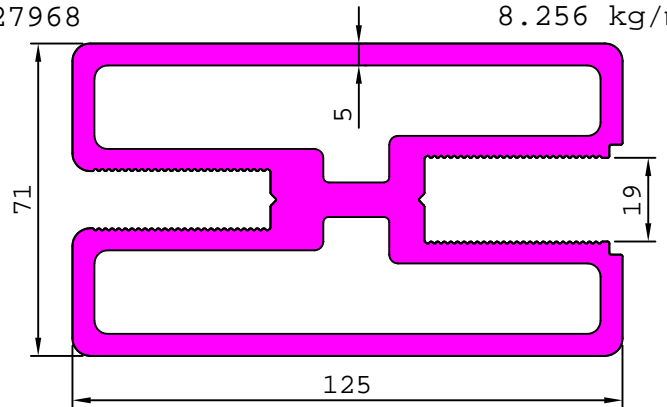

27971

0.697 kg/m

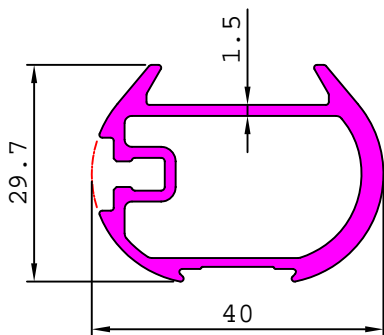

27973

4.825 kg/m

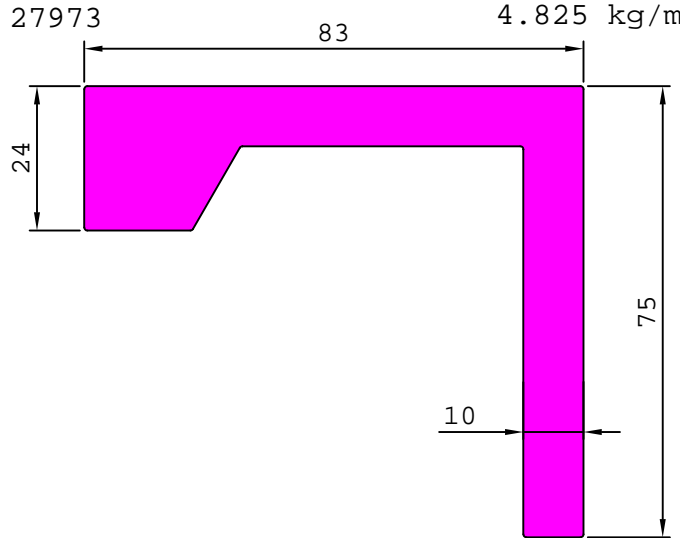

27977

9.949 kg/m

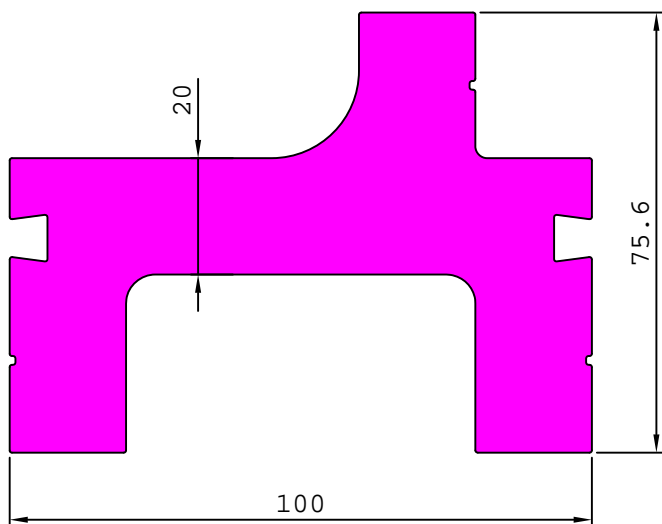

27997

2.383 kg/m

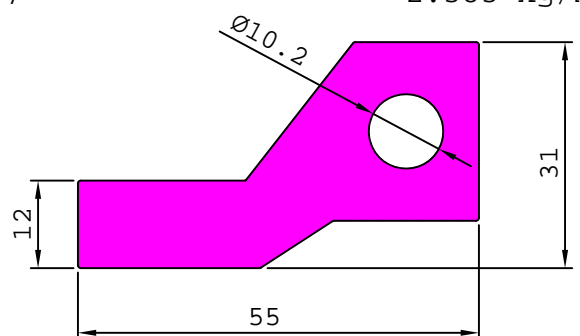

INDUSTRIAL

MISCELLANEOUS

27976

18.549 kg/m

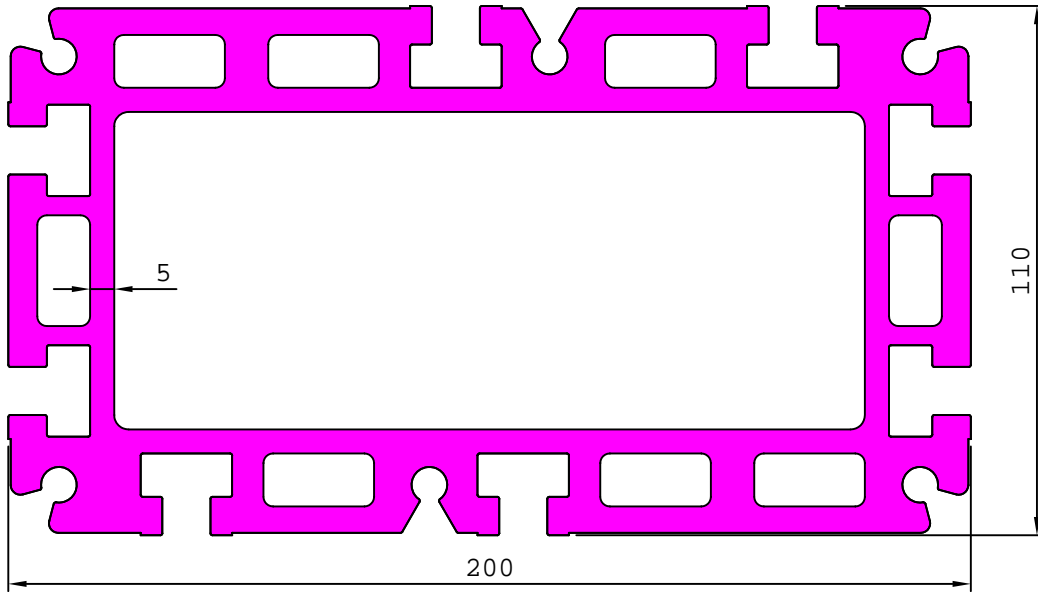

27978

2.126 kg/m

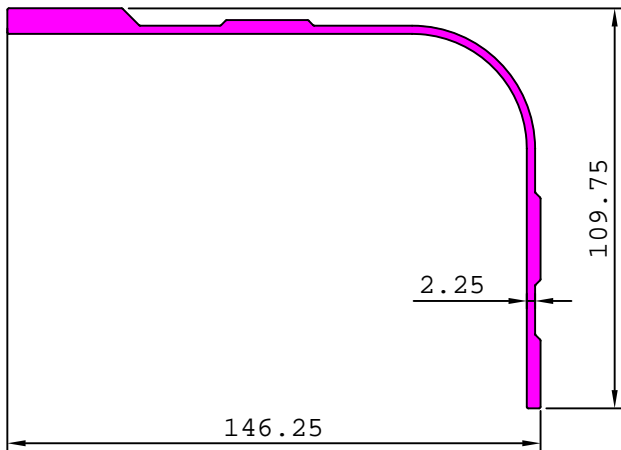

27988

25.276 kg/m

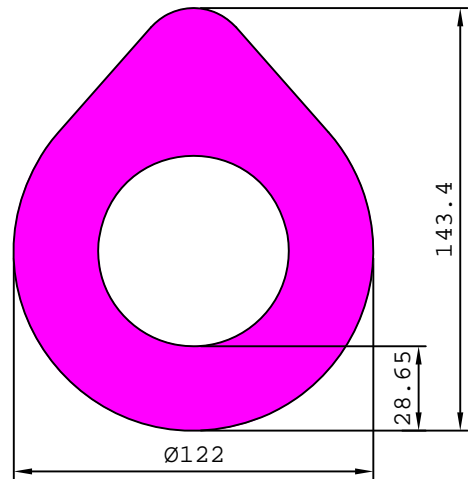

27992

18.530 kg/m

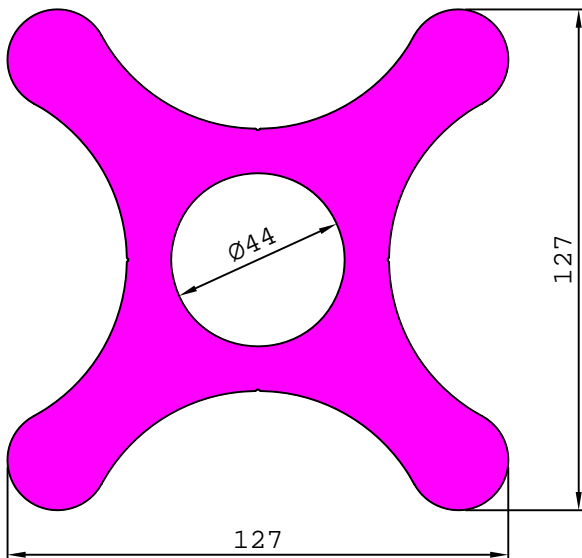

27996

28.491 kg/m

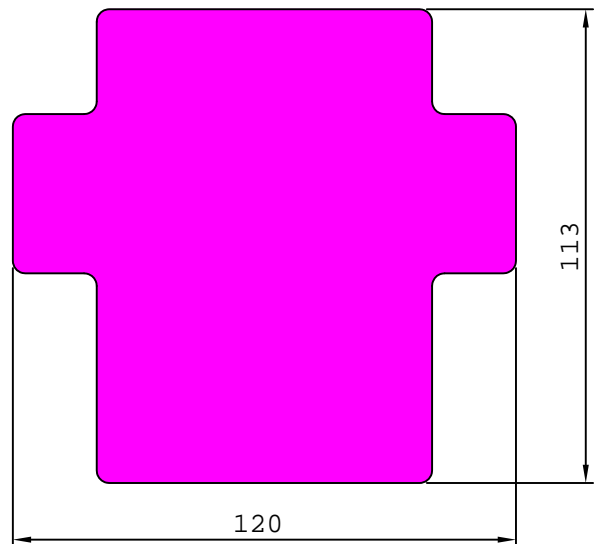

INDUSTRIAL

MISCELLANEOUS

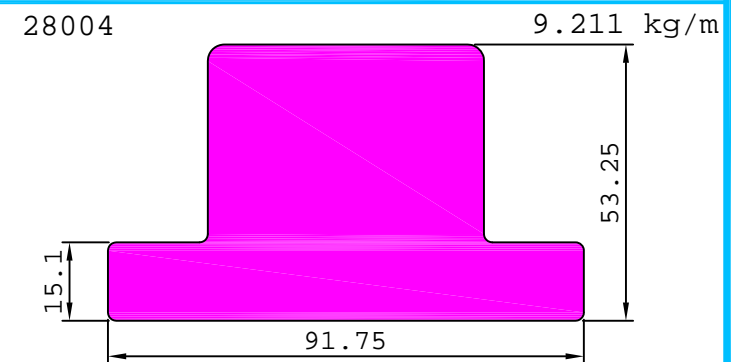
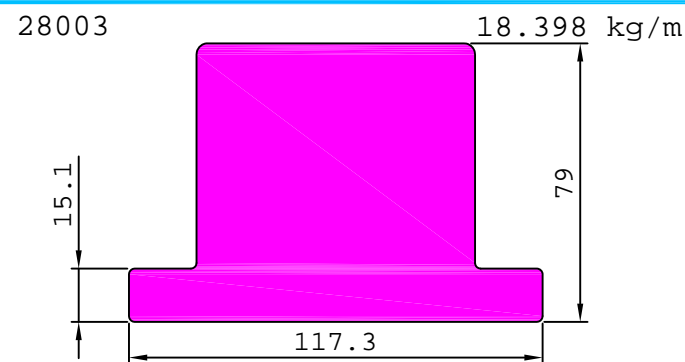
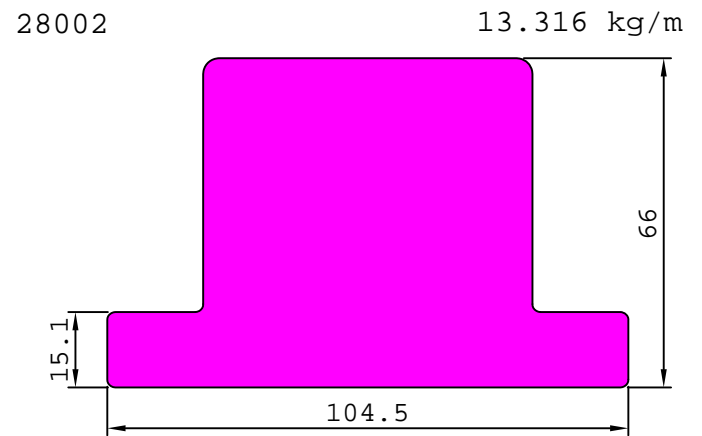
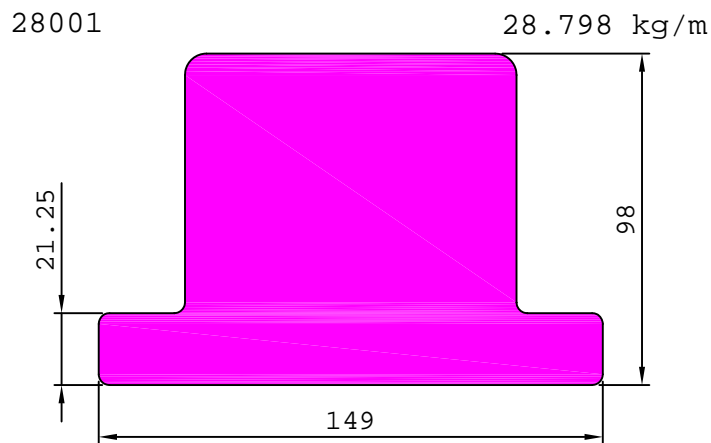
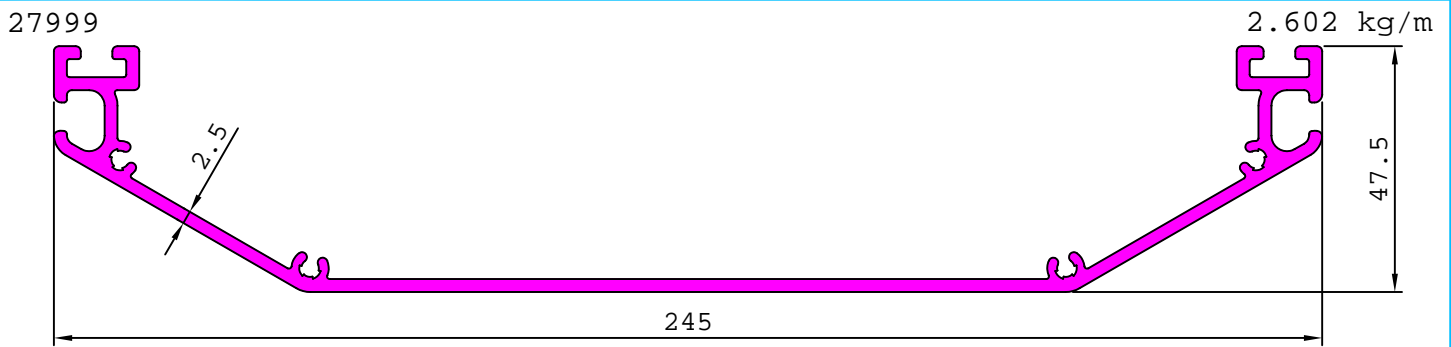
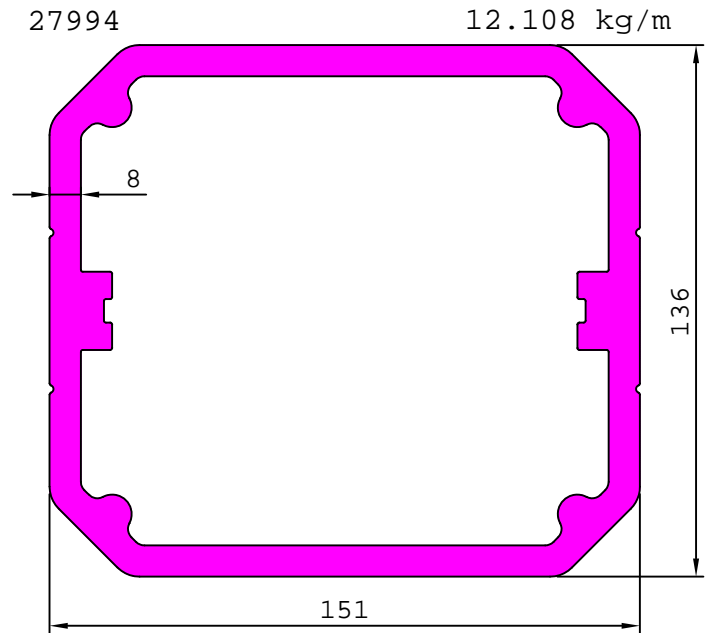
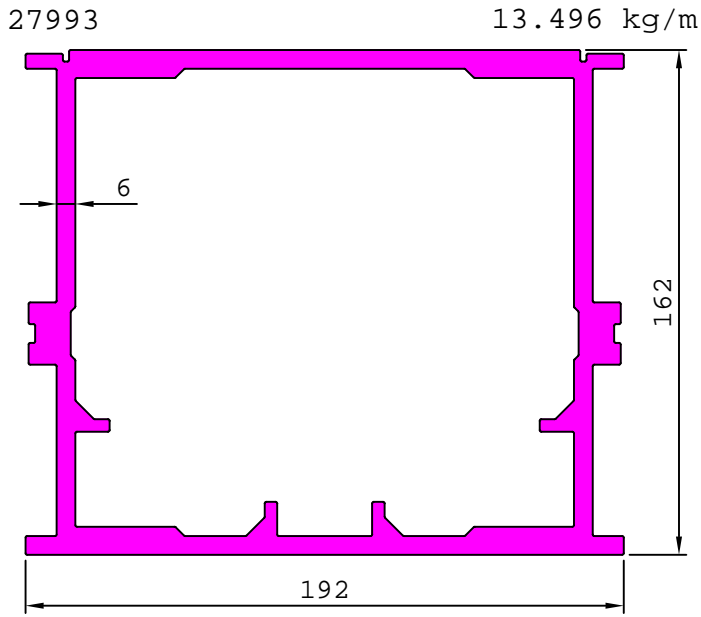

INDUSTRIAL

MISCELLANEOUS

28005

39.868 kg/m

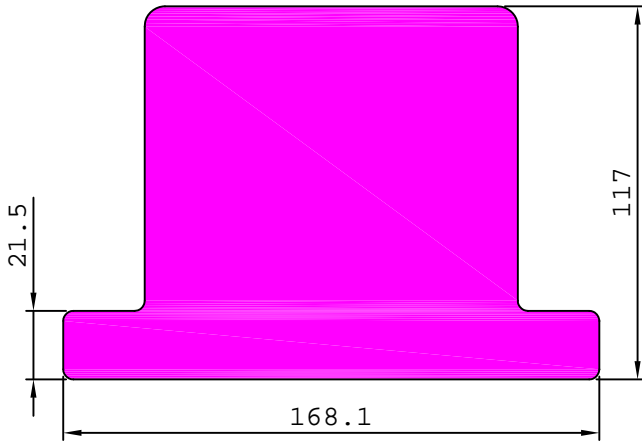

28007

1.871 kg/m

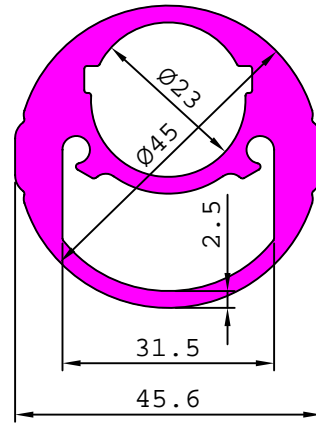

28013

2.820 kg/m

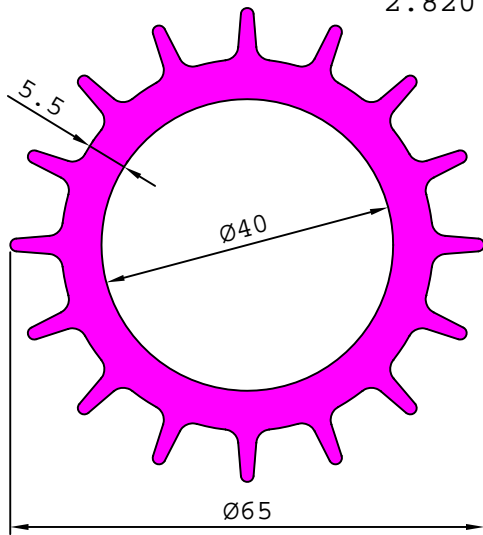

28019

6.951 kg/m

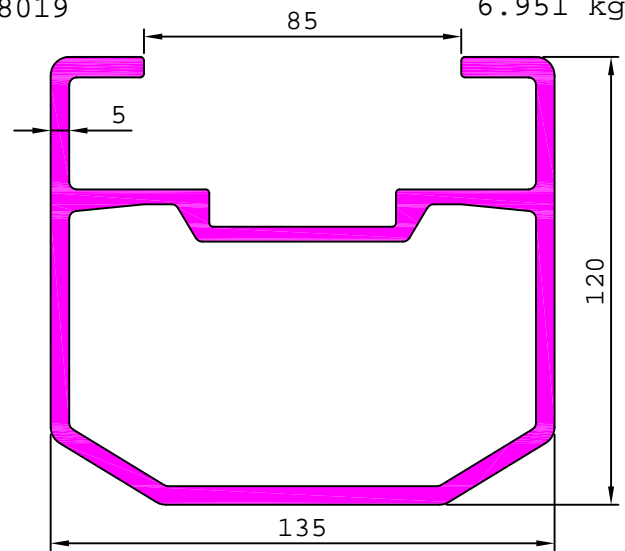

28208

3.448 kg/m

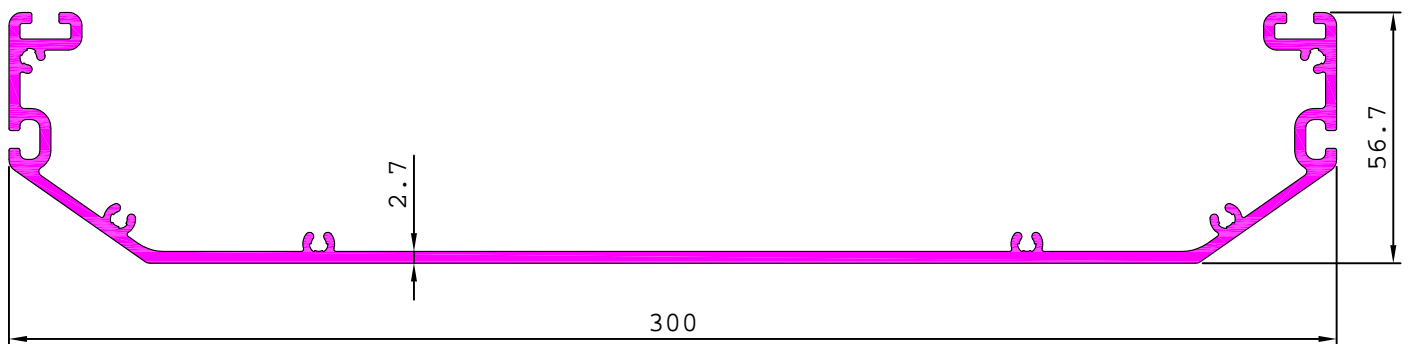

28020

1.753 kg/m

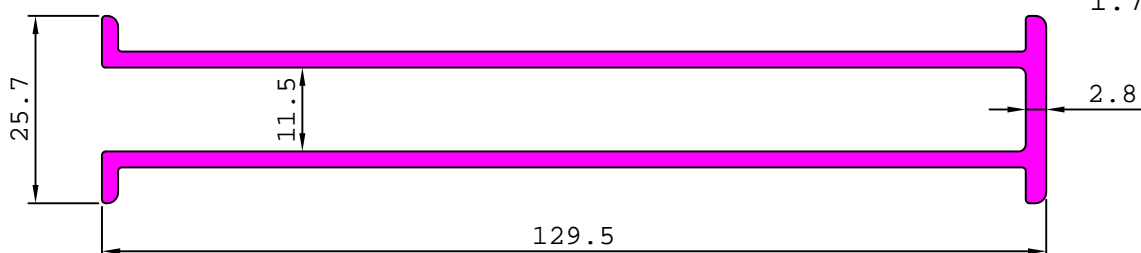

INDUSTRIAL

MISCELLANEOUS

28021 0.410 kg/m

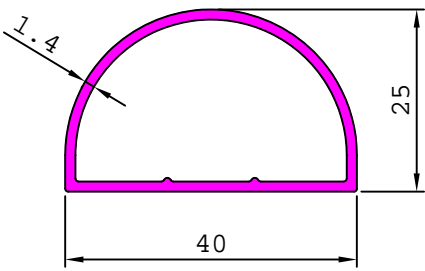

28025 0.343 kg/m

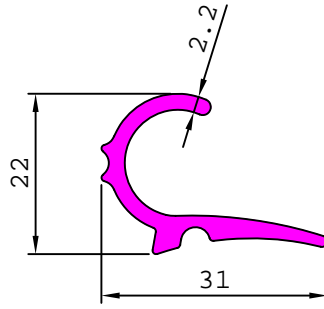

28026 0.348 kg/m

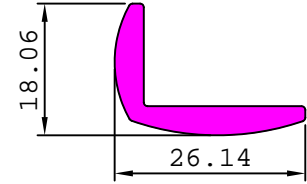

28029 40.785 kg/m

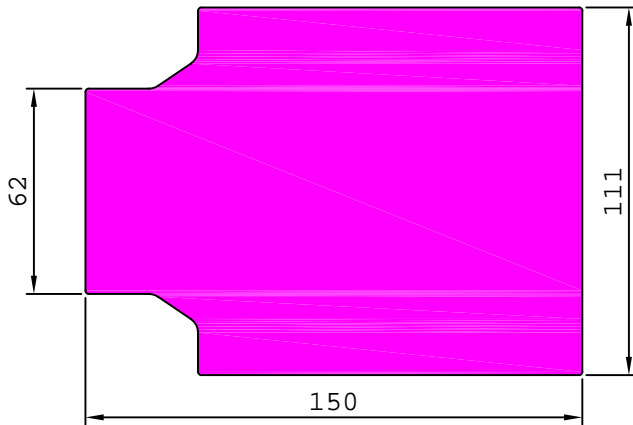

28031 7.016 kg/m

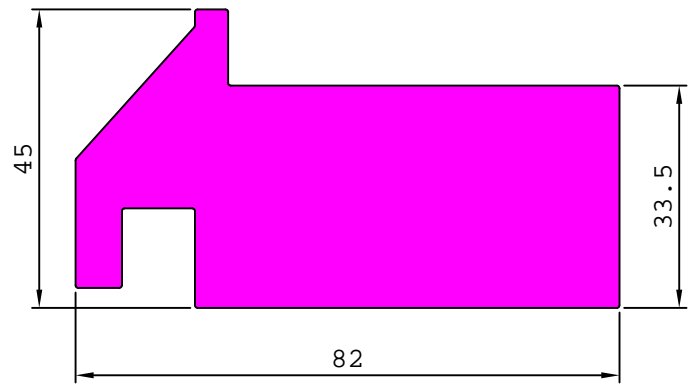

28033 19.322 kg/m

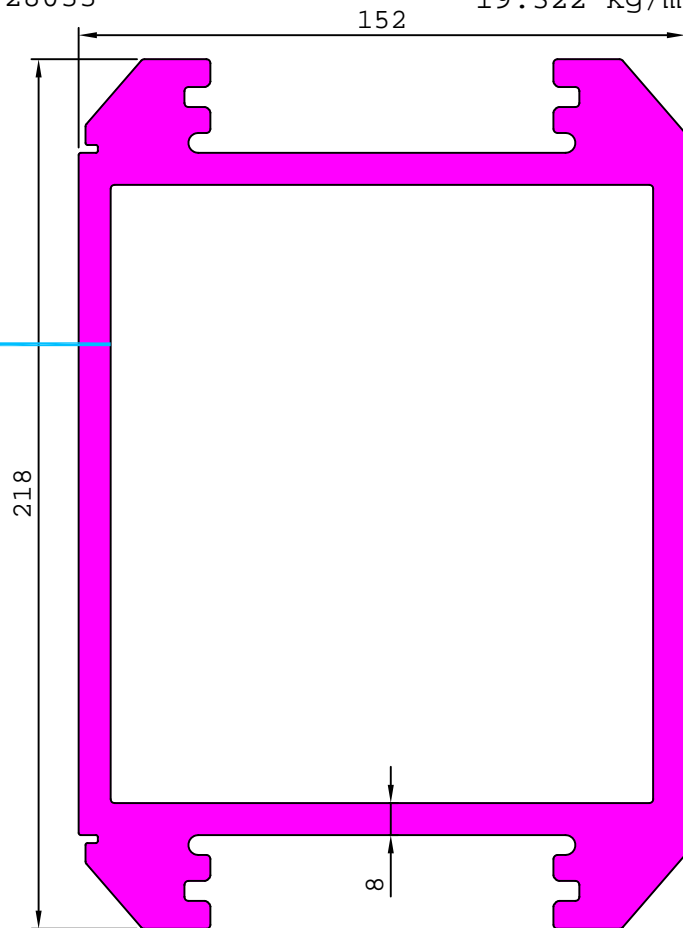

28043 3.406 kg/m

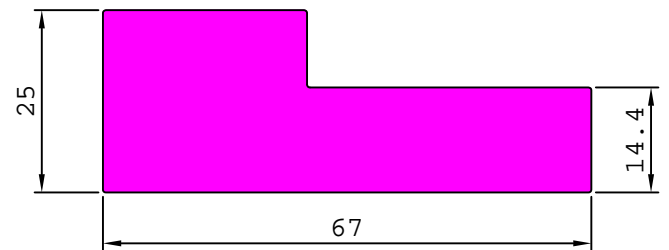

28046 3.643 kg/m

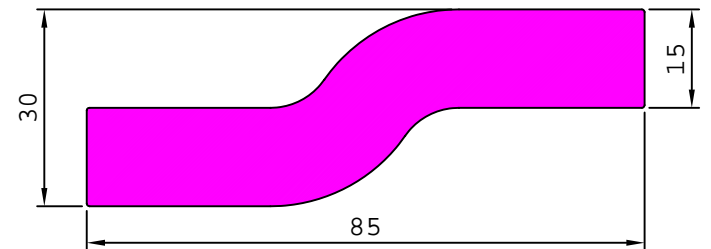

28057 2.781 kg/m

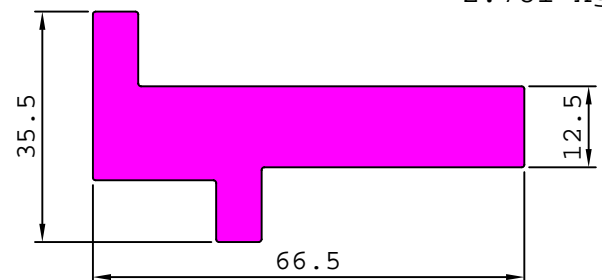

INDUSTRIAL

MISCELLANEOUS

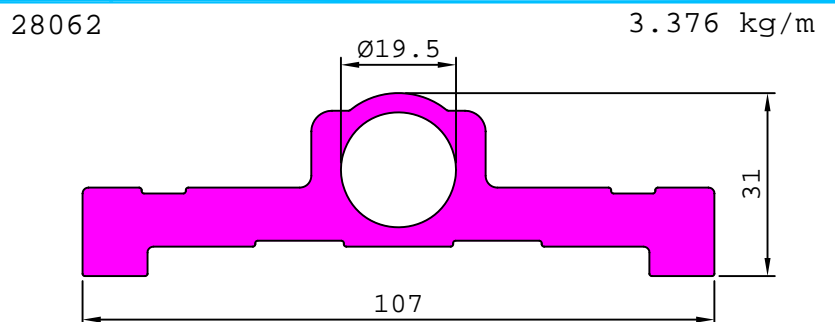
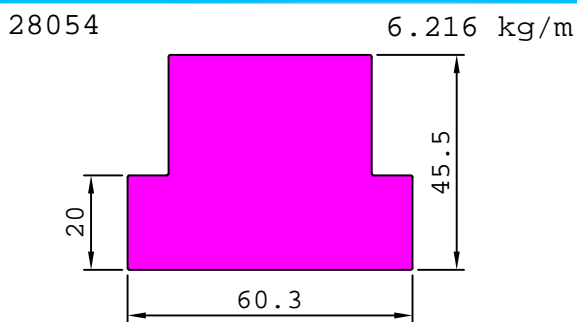
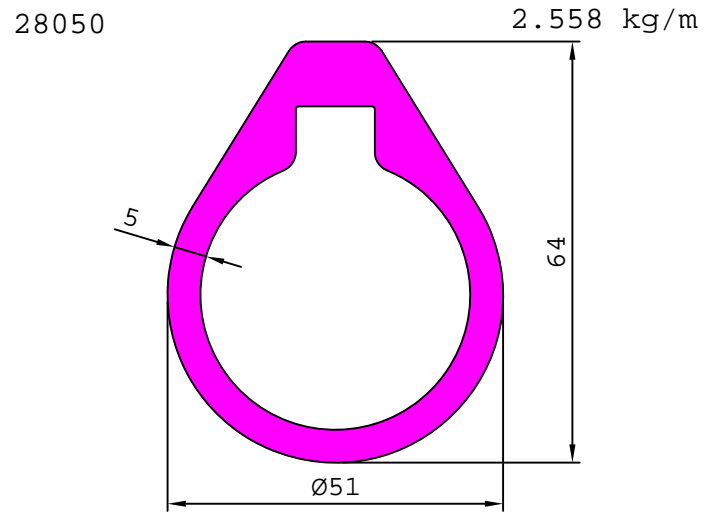
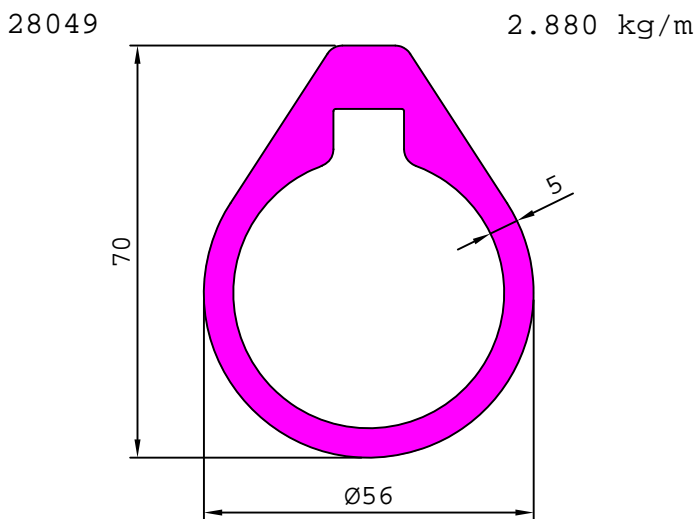
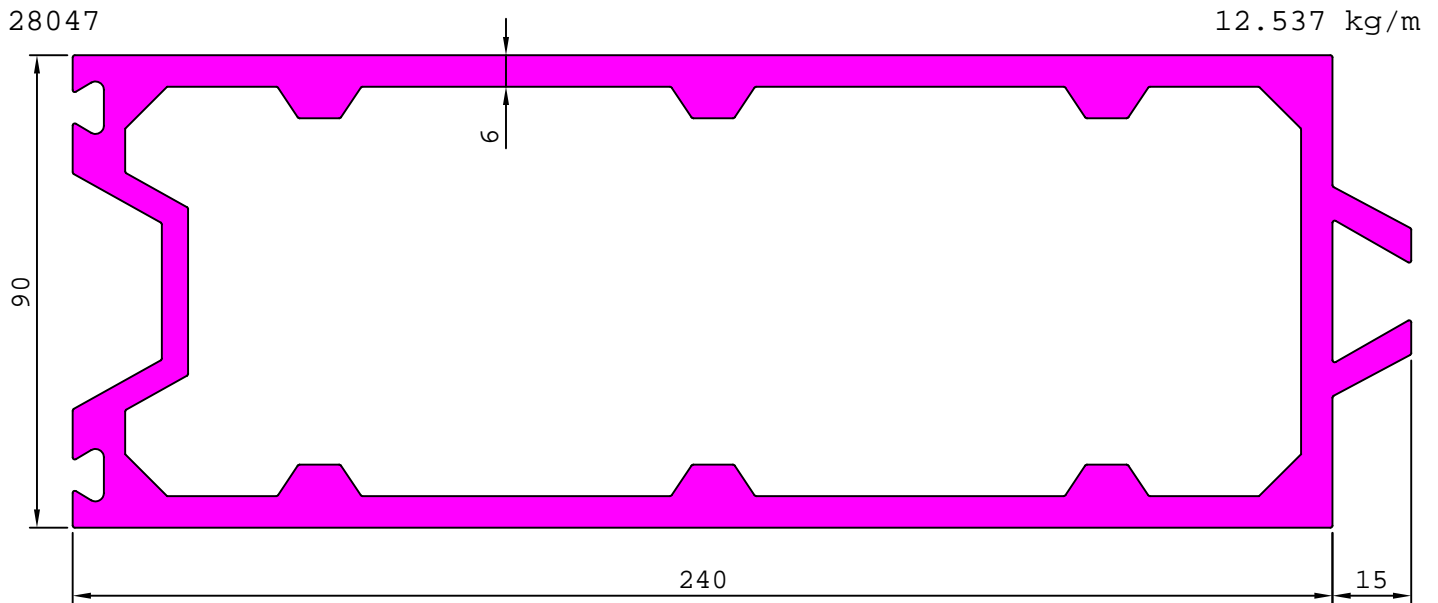
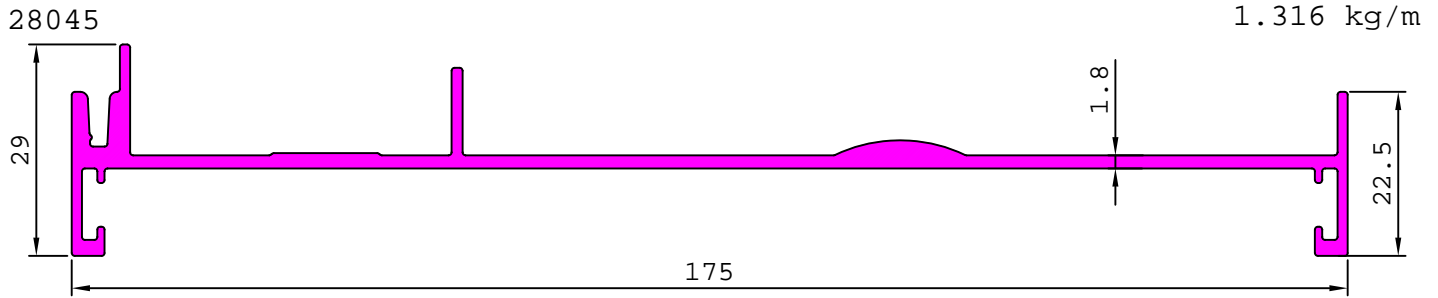

INDUSTRIAL

MISCELLANEOUS

28063

1.174 kg/m

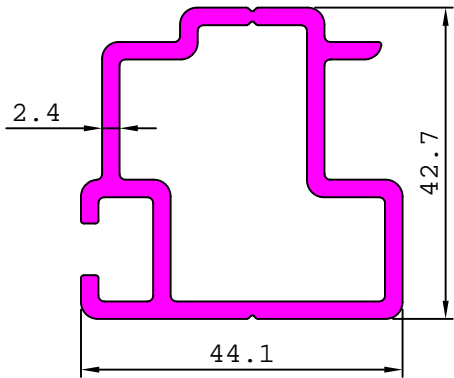

28064

0.639 kg/m

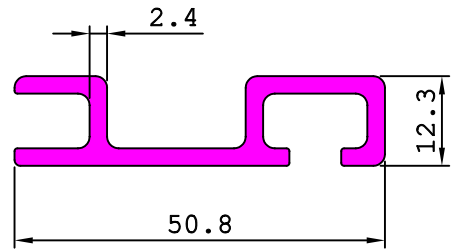

28066

5.340 kg/m

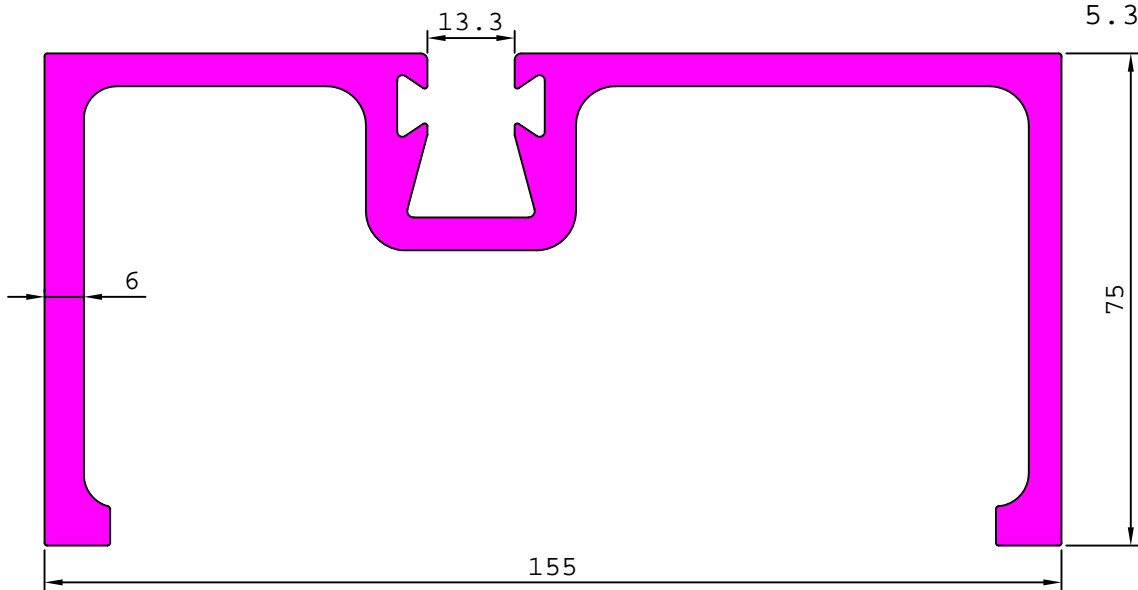

28068

6.057 kg/m

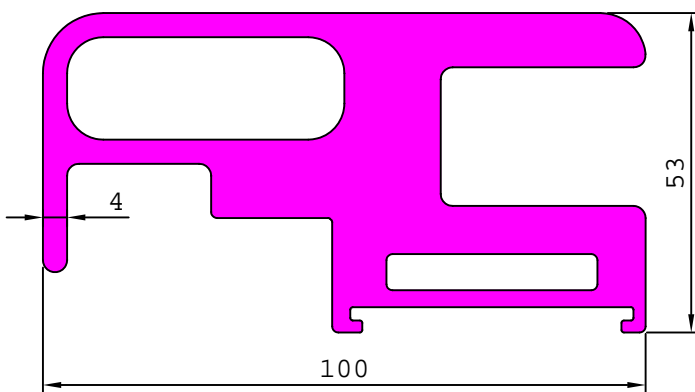

28088

6.265 kg/m

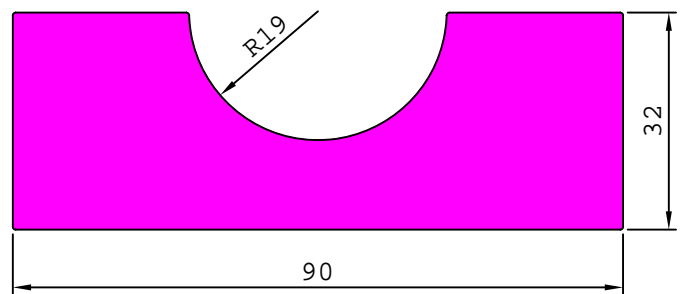

28079

2.337 kg/m

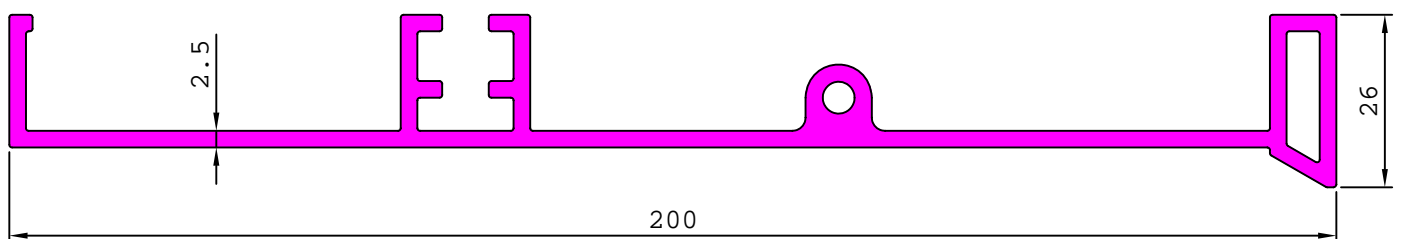

INDUSTRIAL

MISCELLANEOUS

28078 0.387 kg/m

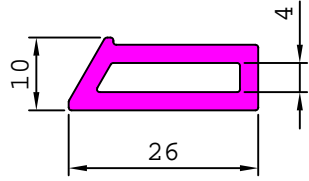

28080

1.013 kg/m

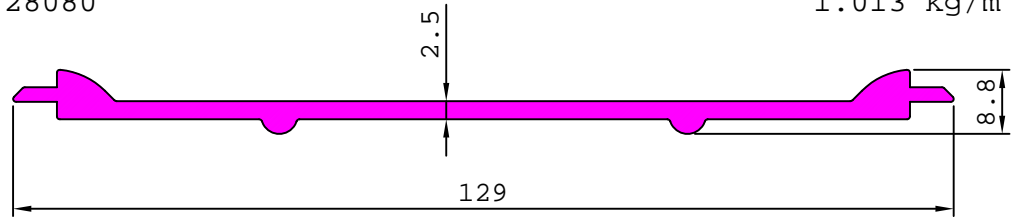

28085

6.932 kg/m

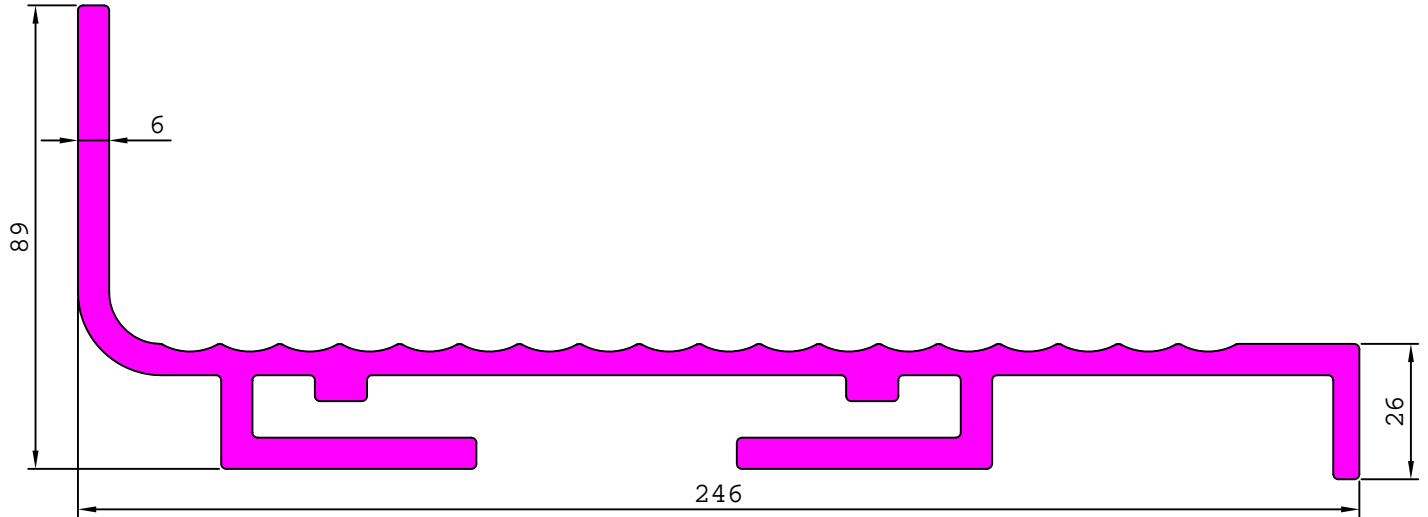

28089

1.791 kg/m

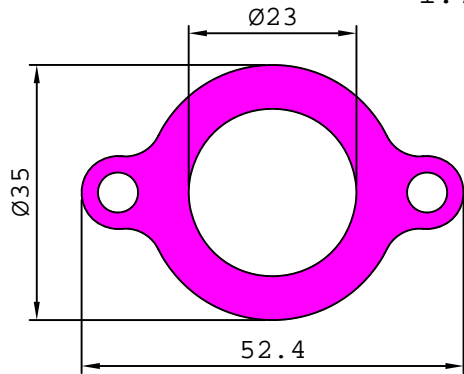

28123

2.162 kg/m

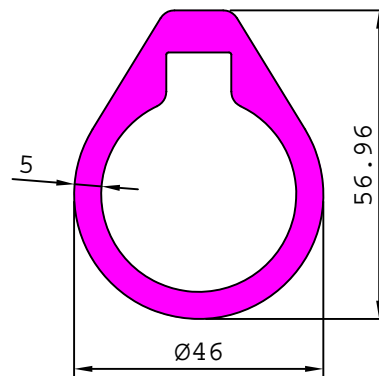

28120

10.588 kg/m

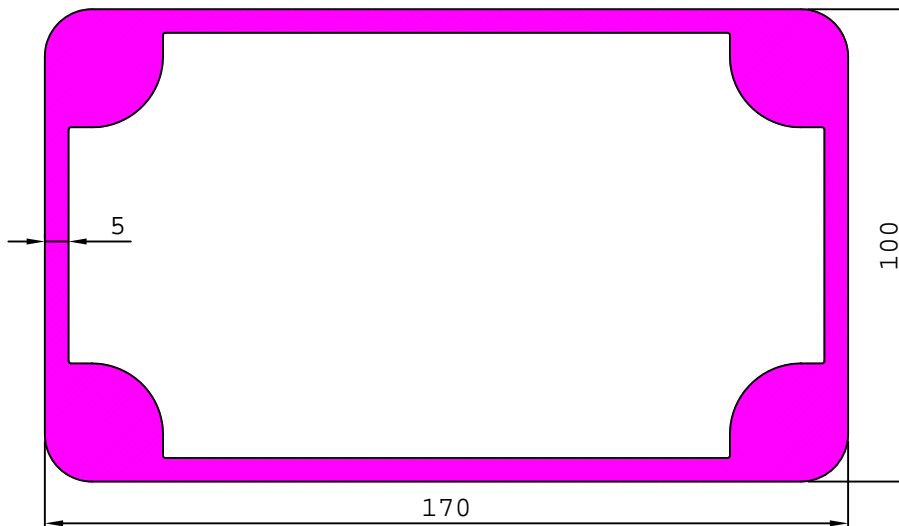

INDUSTRIAL

MISCELLANEOUS

28095

4.108 kg/m

28119

16.047 kg/m

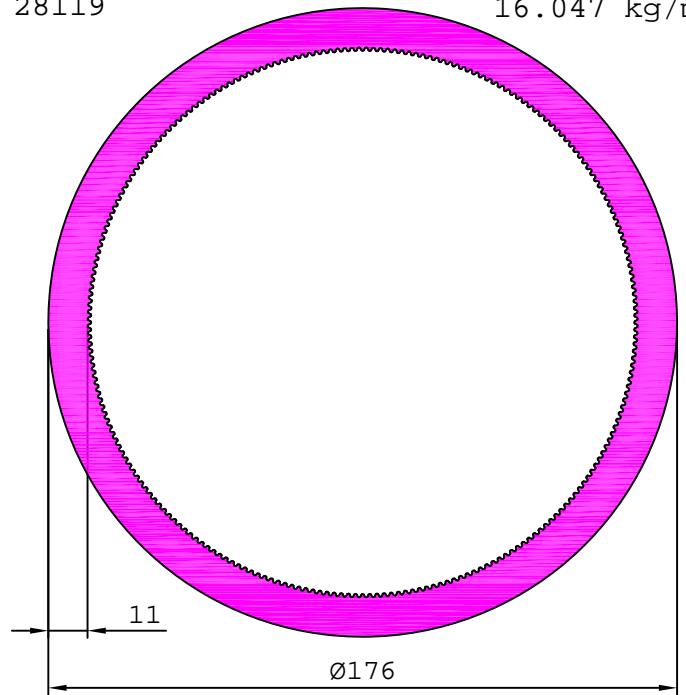
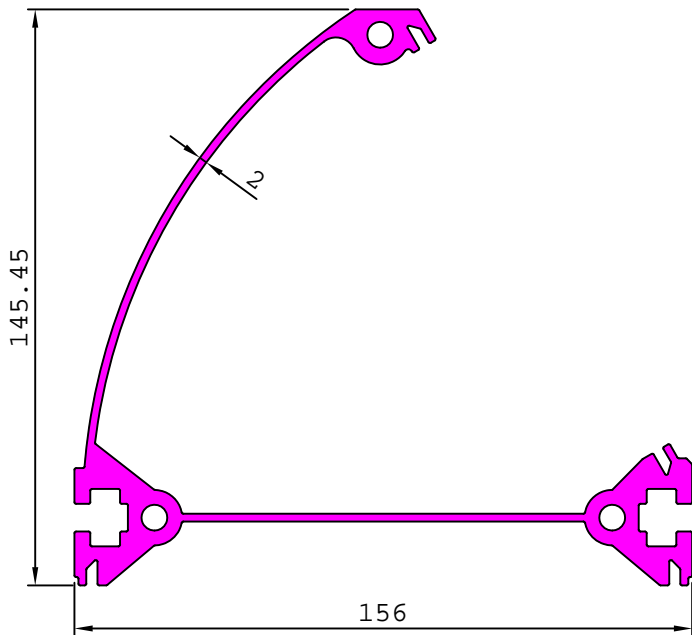

28096

0.140 kg/m

28098

0.996 kg/m

28114

3.133 kg/m

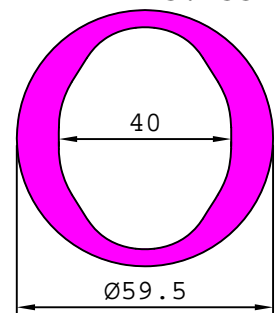
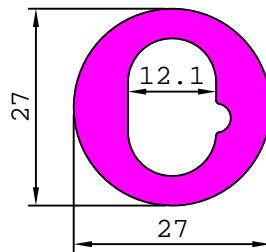
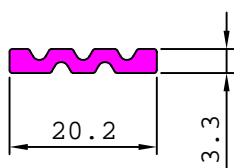

28127

6.692 kg/m

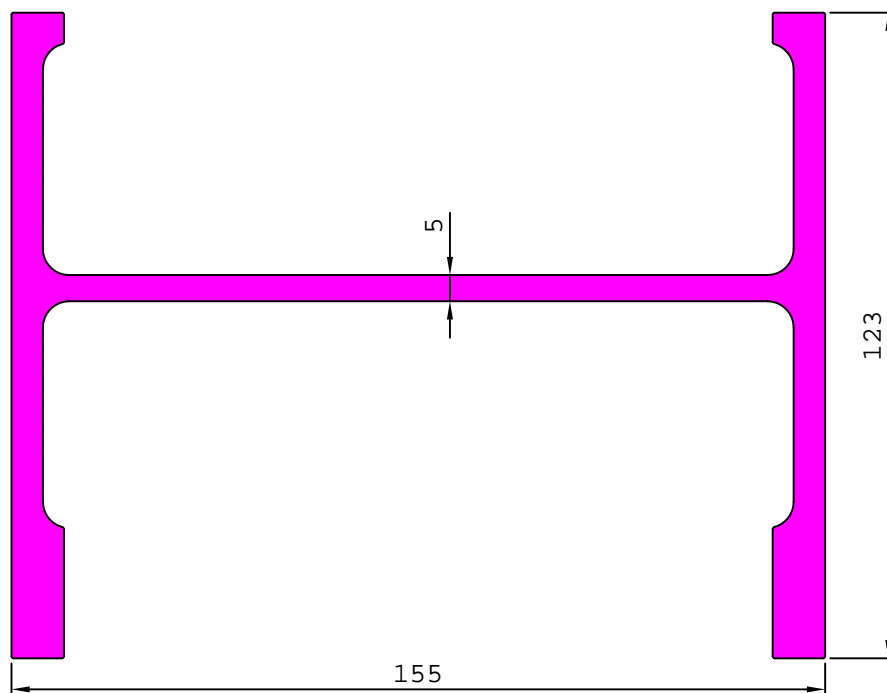

INDUSTRIAL

MISCELLANEOUS

28112

11.195 kg/m

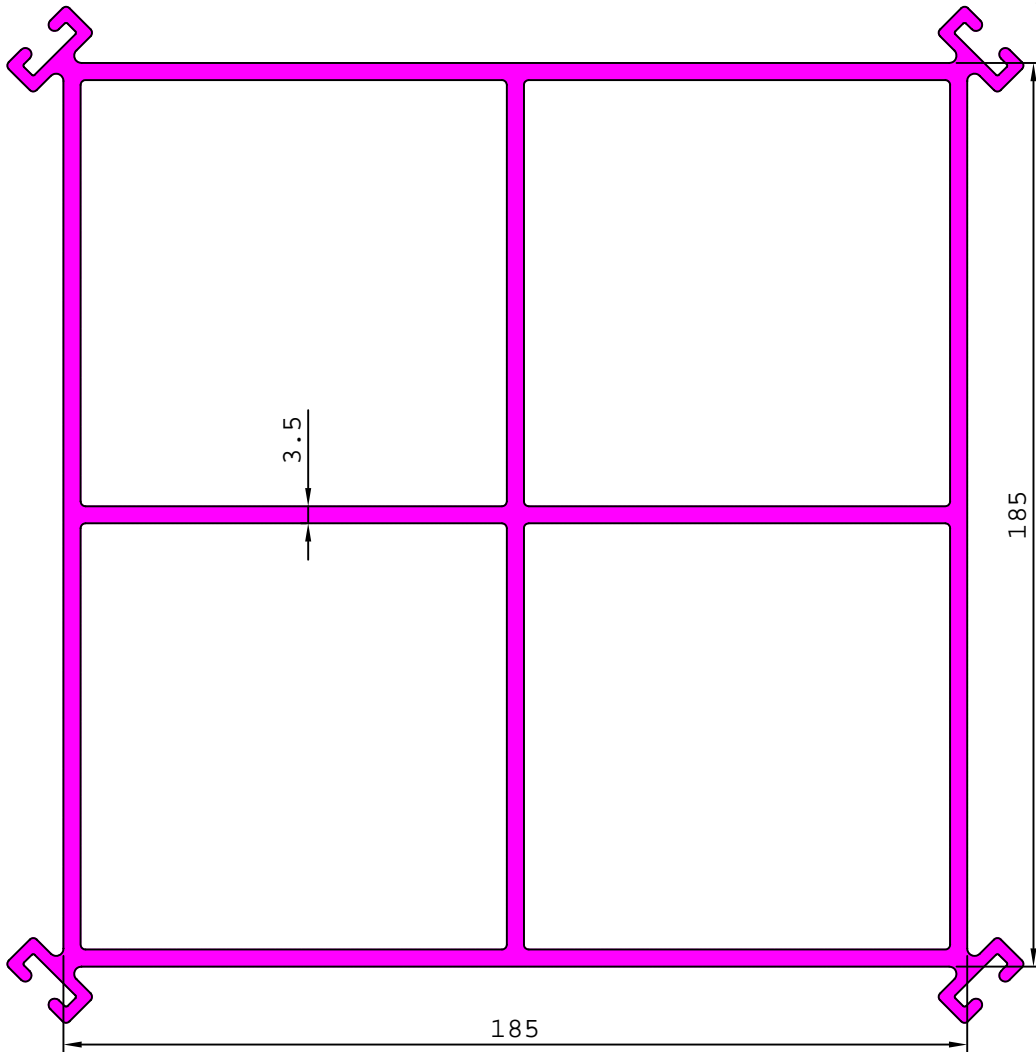

28113

4.657 kg/m

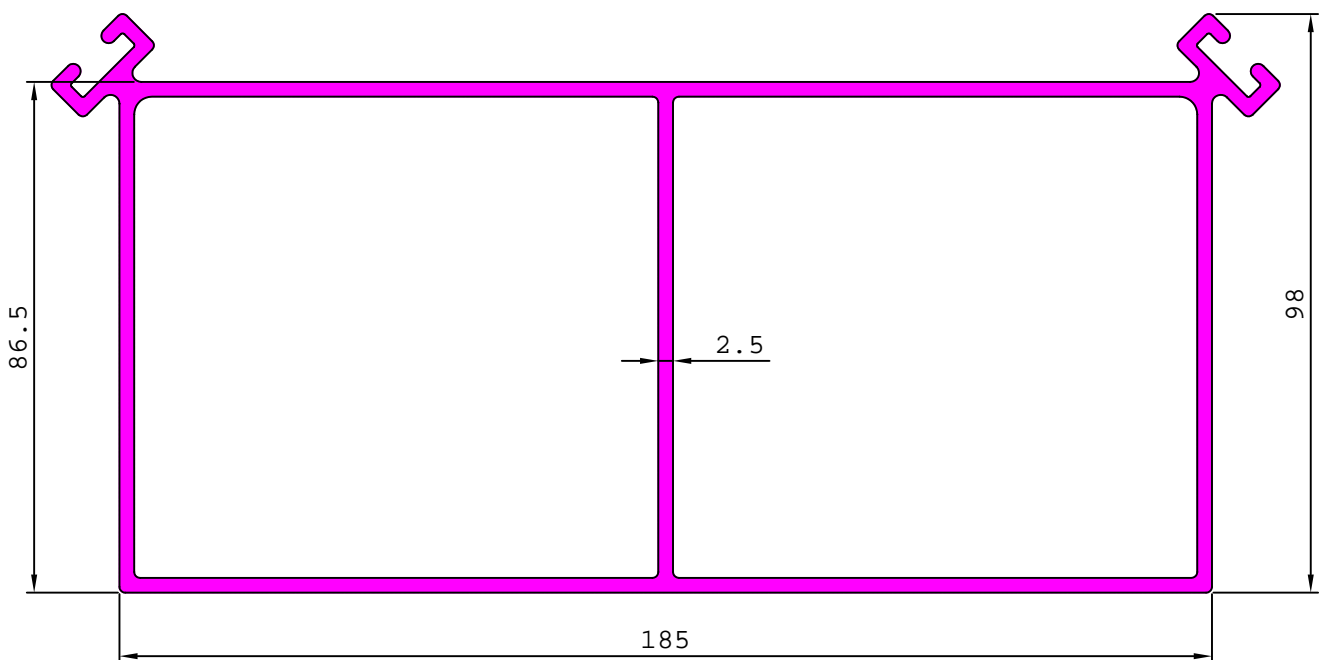

INDUSTRIAL

MISCELLANEOUS

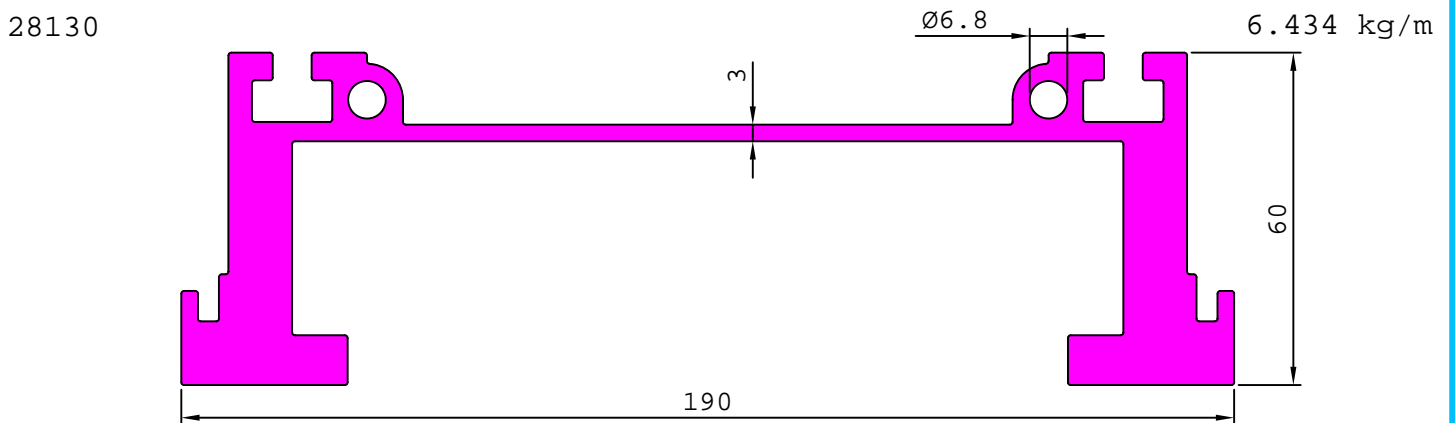
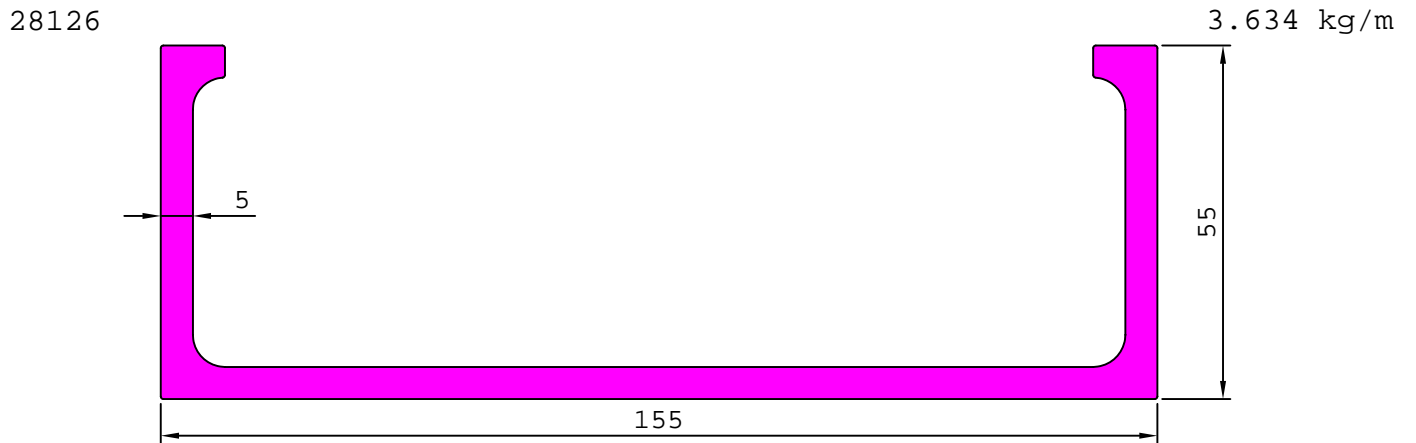
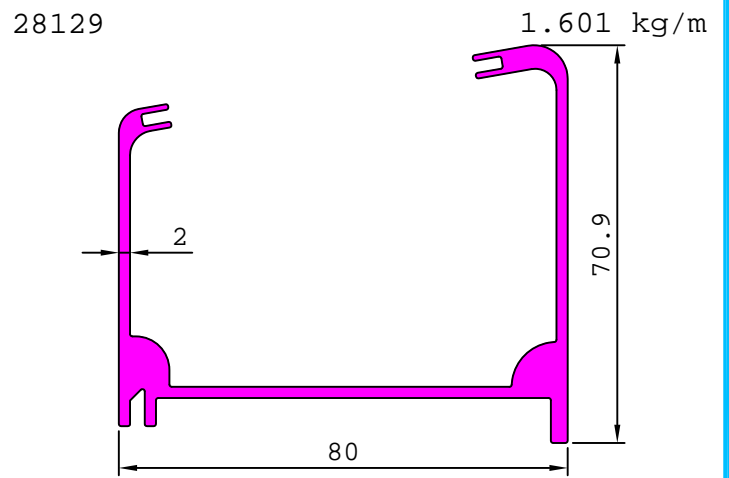
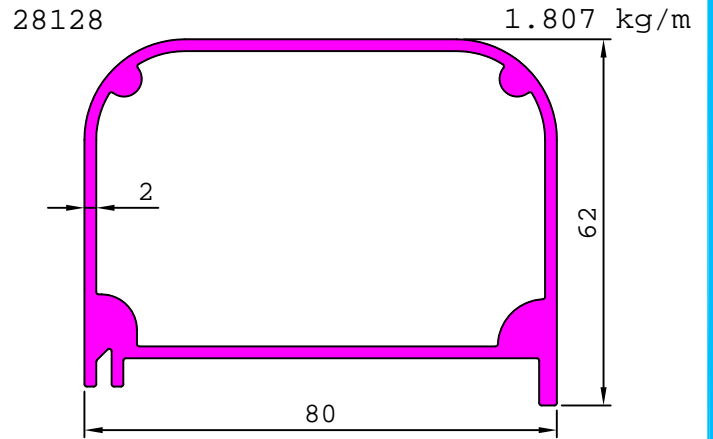
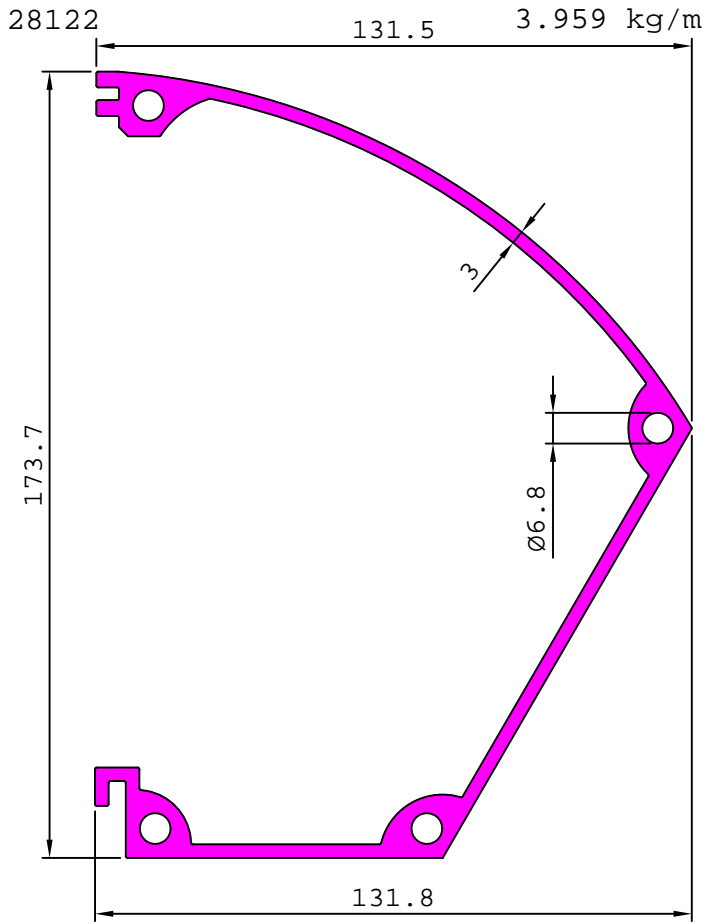

INDUSTRIAL

MISCELLANEOUS

28134

13.890 kg/m

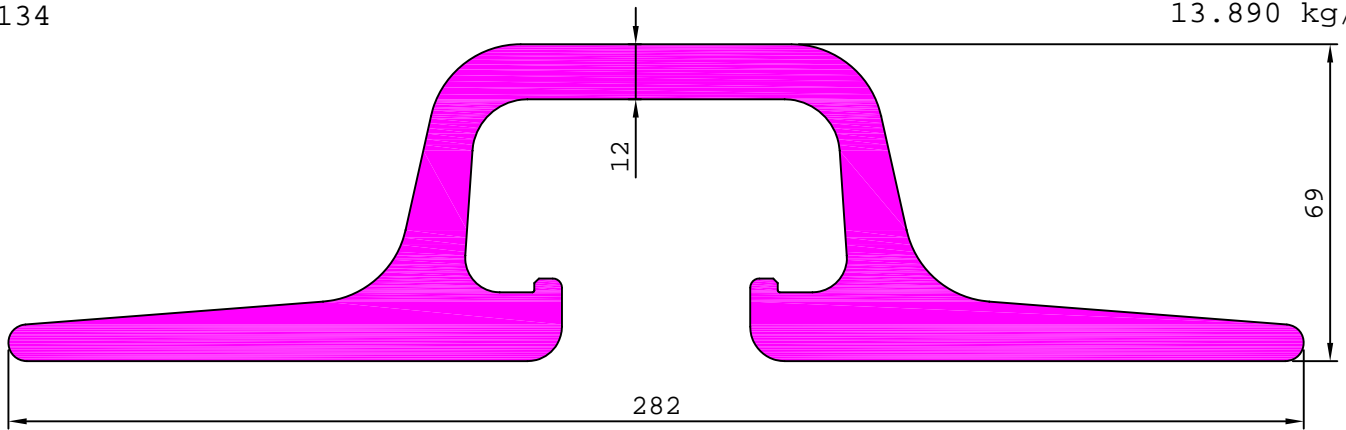

28142

12.896 kg/m

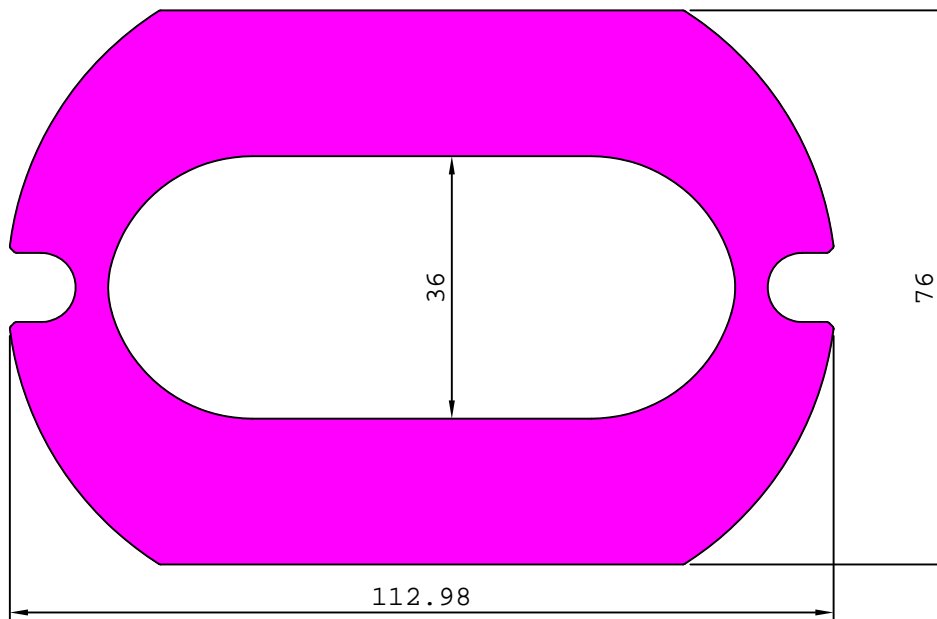

28151

9.126 kg/m

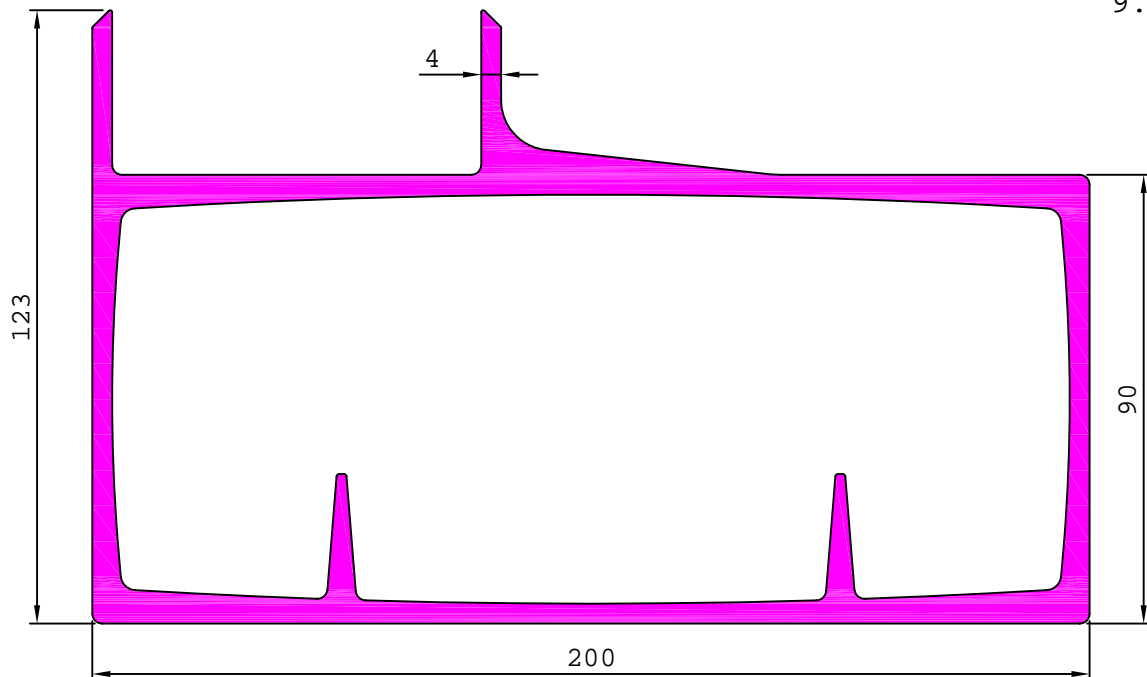

INDUSTRIAL

MISCELLANEOUS

28146

1.243 kg/m

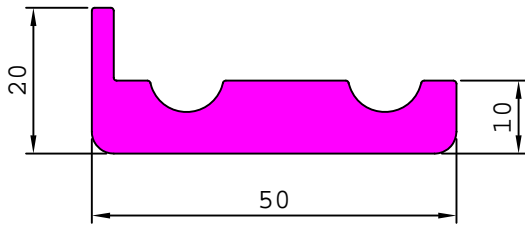

28154

2.529 kg/m

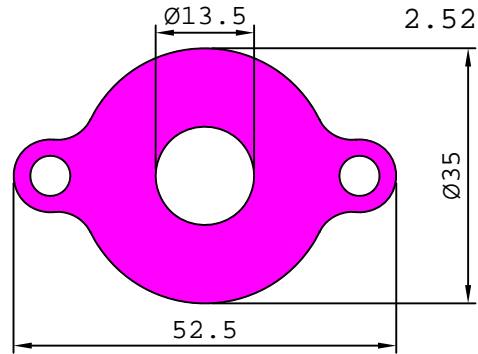

28160

46.507 kg/m

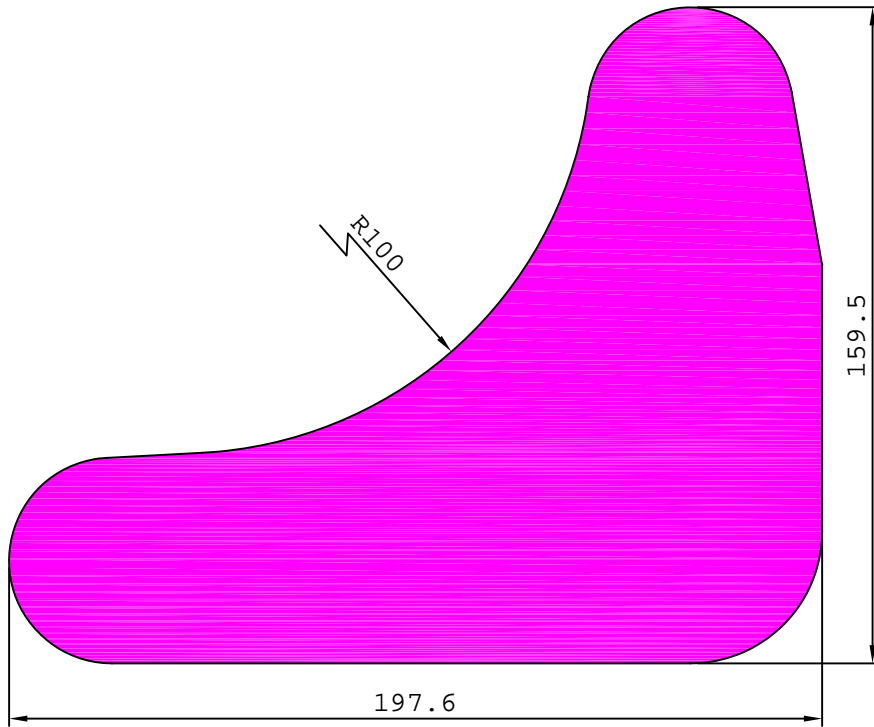

28165

34.323 kg/m

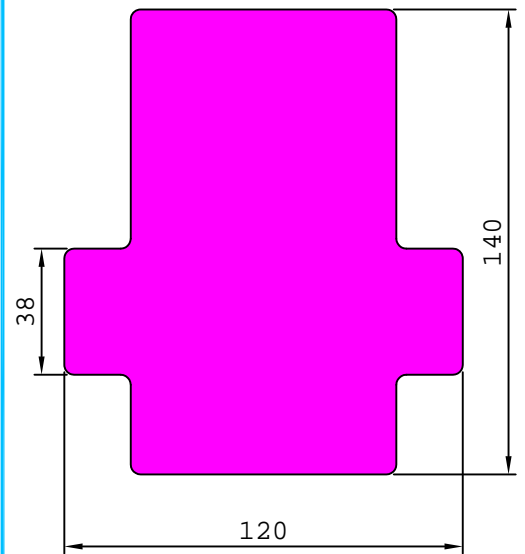

28161

1.689 kg/m

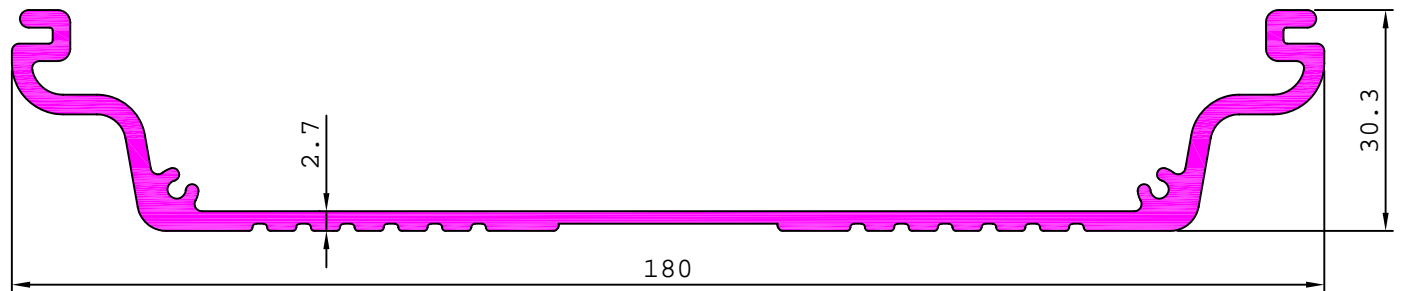

28163

1.493 kg/m

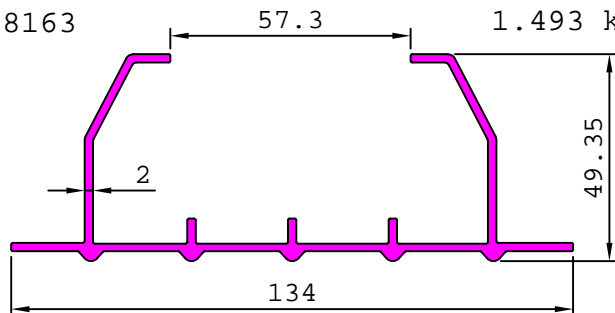

28164

1.180 kg/m

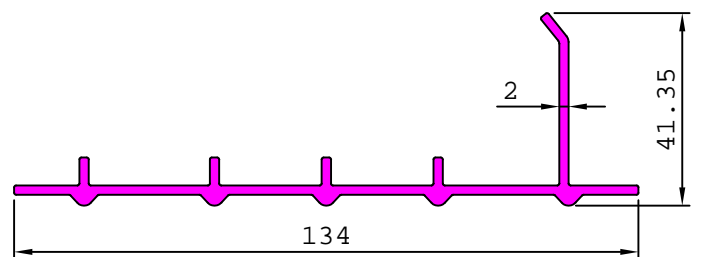

INDUSTRIAL

MISCELLANEOUS

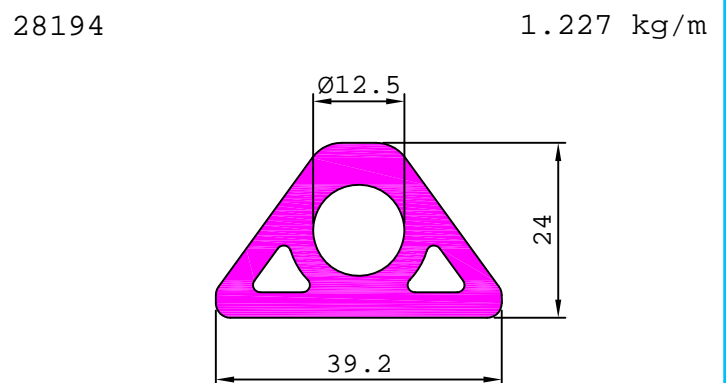
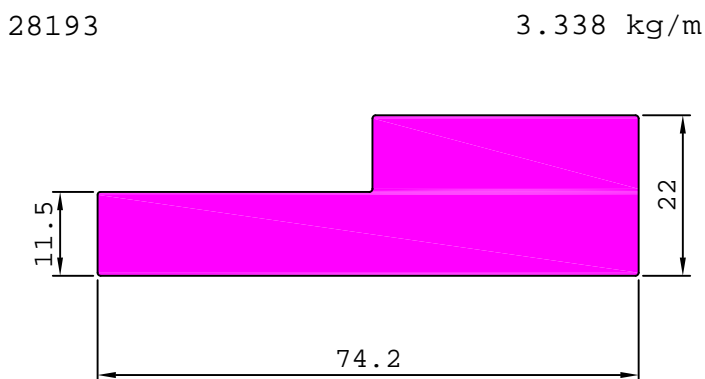
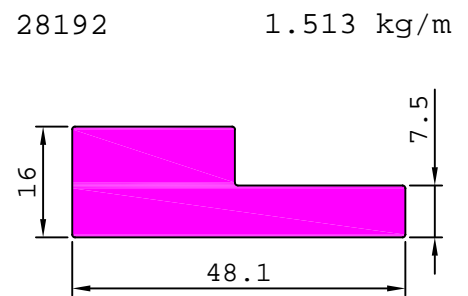
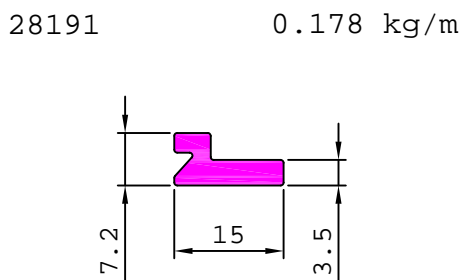
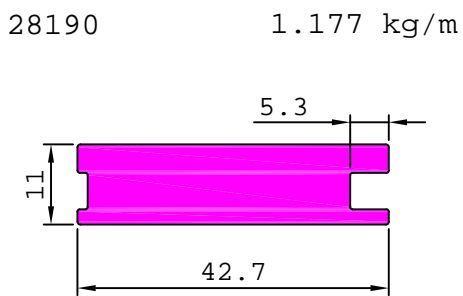
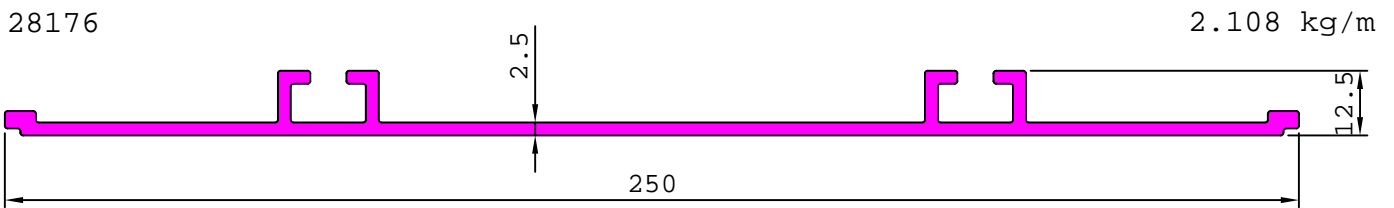
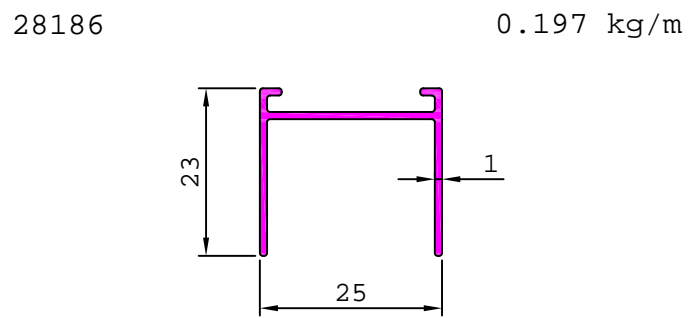
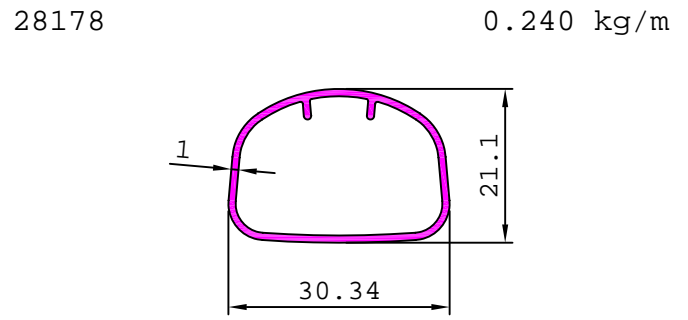
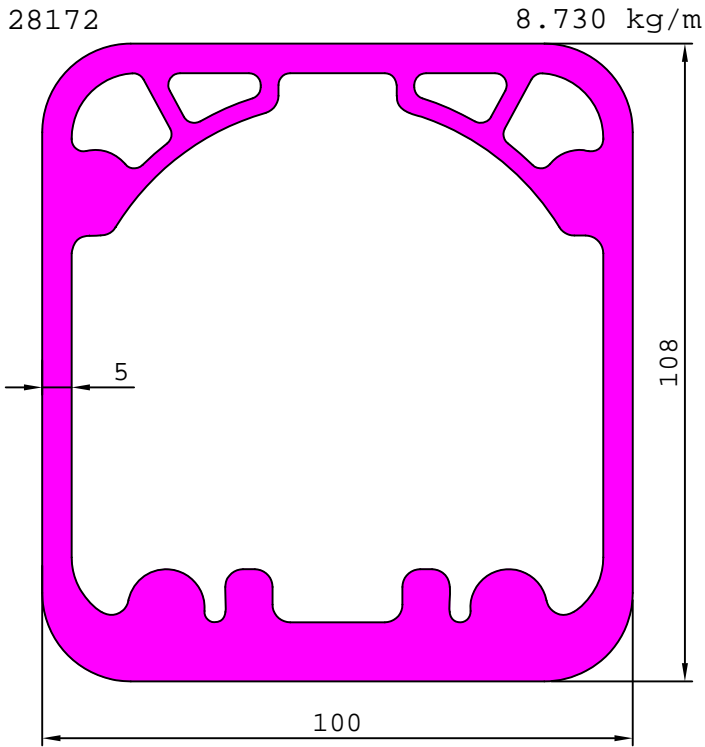

INDUSTRIAL

MISCELLANEOUS

28197

27.850 kg/m

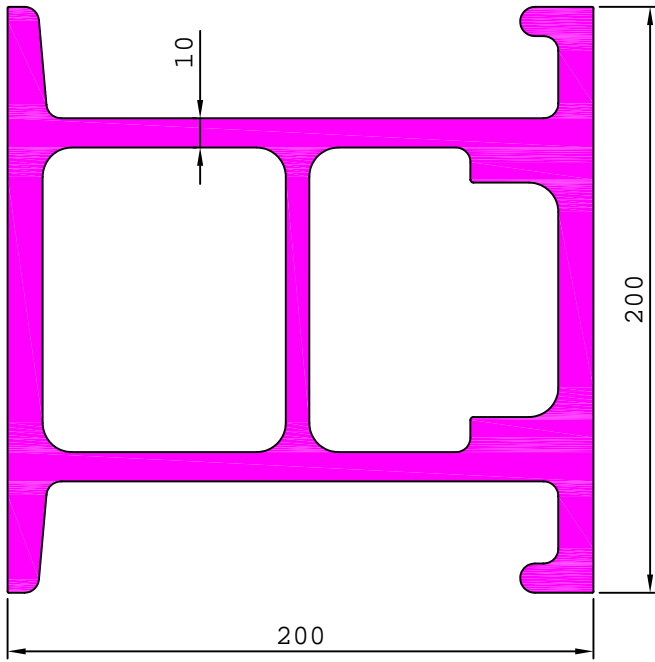

28198

5.744 kg/m

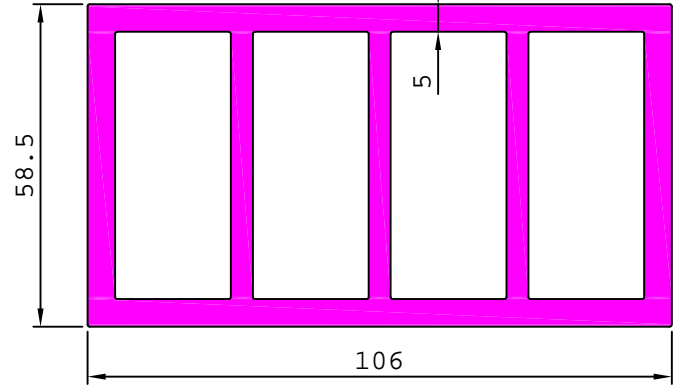

28202

0.313 kg/m

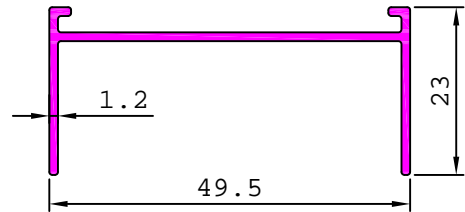

28203

0.748 kg/m

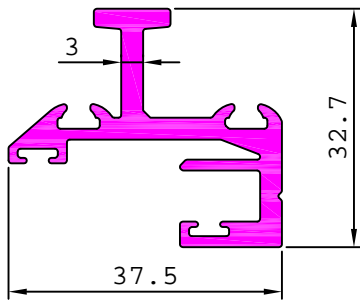

28205

0.973 kg/m

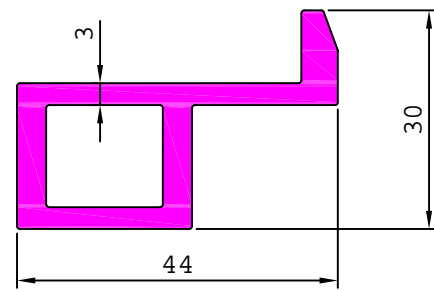

28206

1.256 kg/m

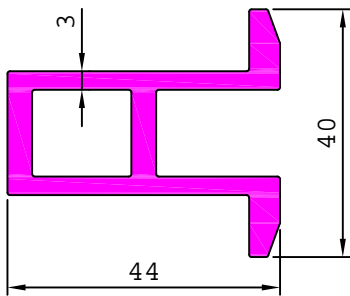

28217

0.675 kg/m

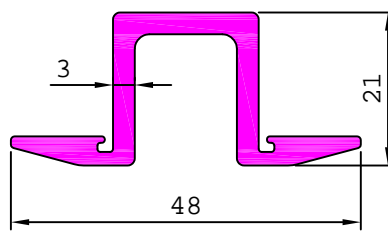

28218

0.418 kg/m

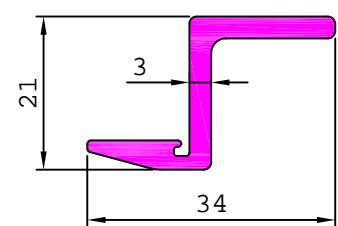

28214

4.587 kg/m

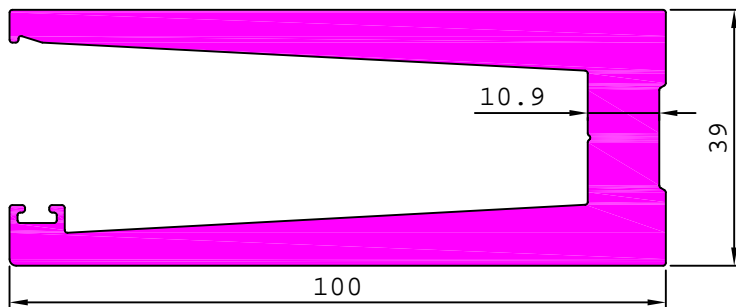

28219

0.926 kg/m

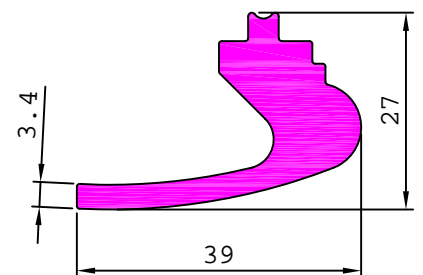

INDUSTRIAL

MISCELLANEOUS

28223

6.264 kg/m

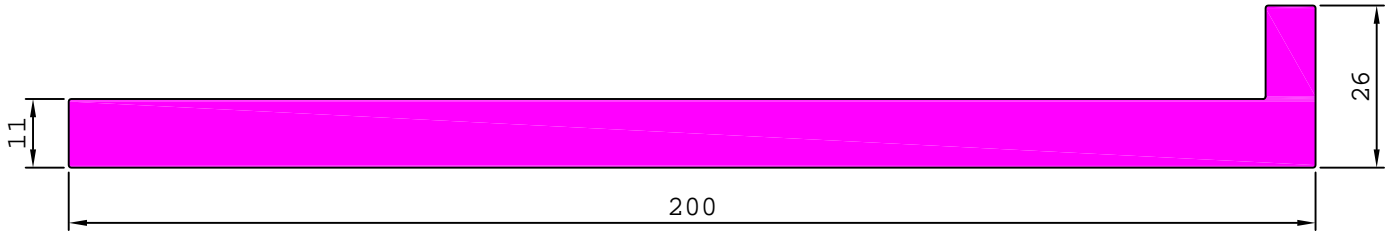

28224

0.081 kg/m

28225

5.062 kg/m

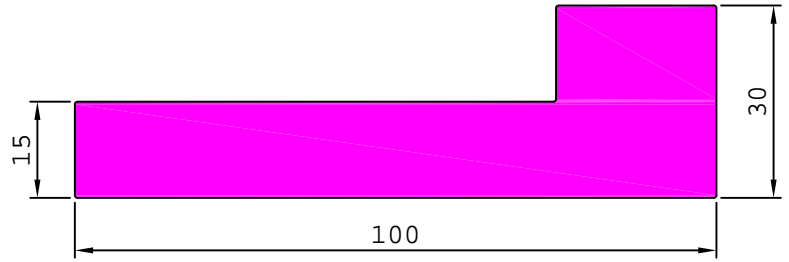
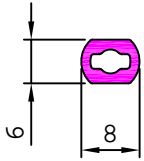

28226

214

3.726 kg/m

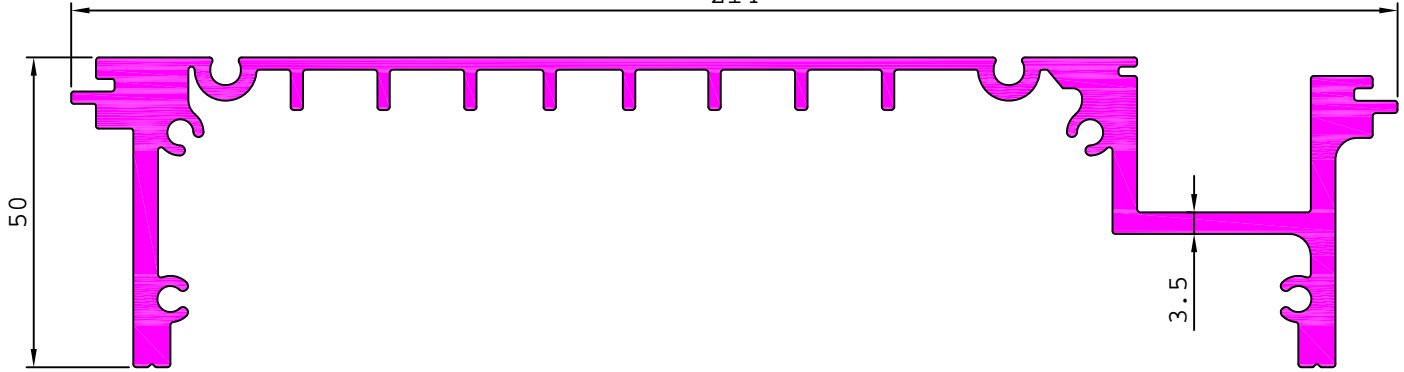

28227

2.099 kg/m

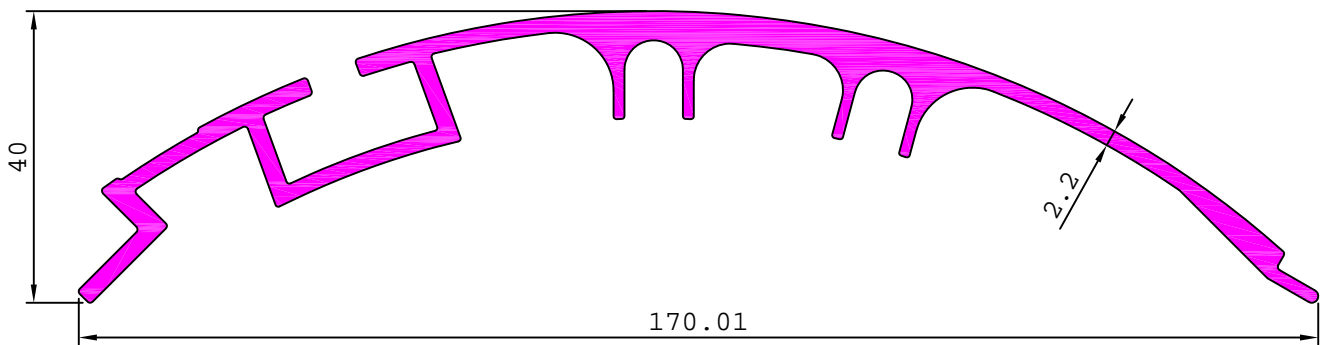

28238

0.337 kg/m

28241

0.461 kg/m

28252

0.320 kg/m

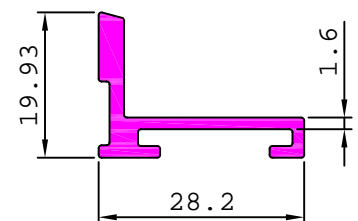
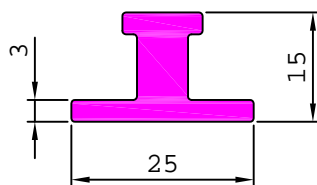
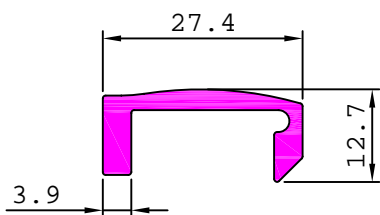

INDUSTRIAL

MISCELLANEOUS

28239

6.191 kg/m

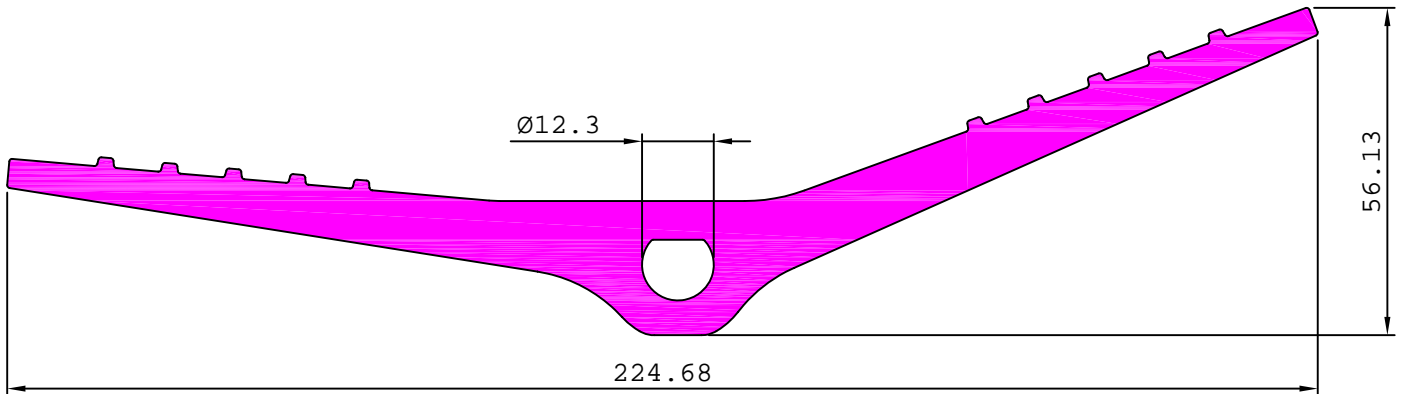

28240

4.957 kg/m

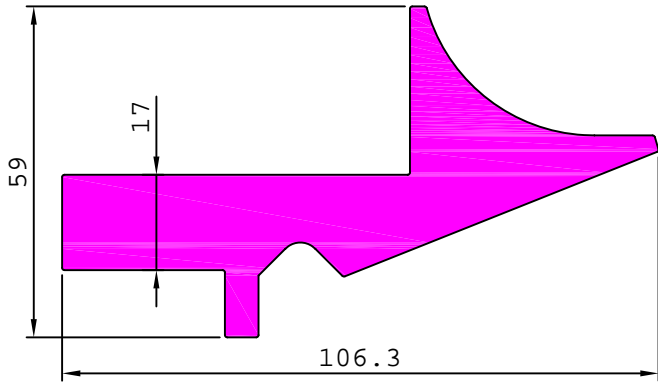

28243

10.835 kg/m

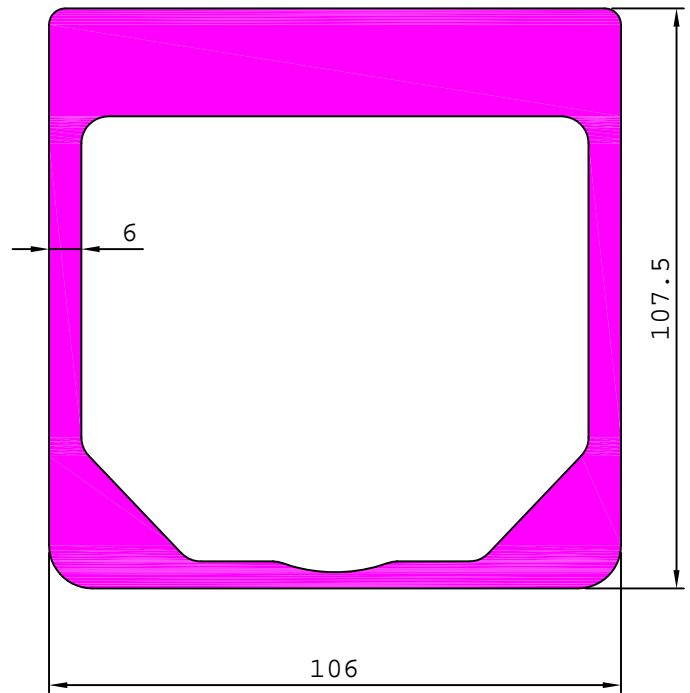

28251

0.289 kg/m

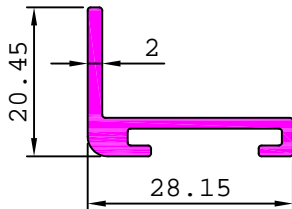

28256

20.448 kg/m

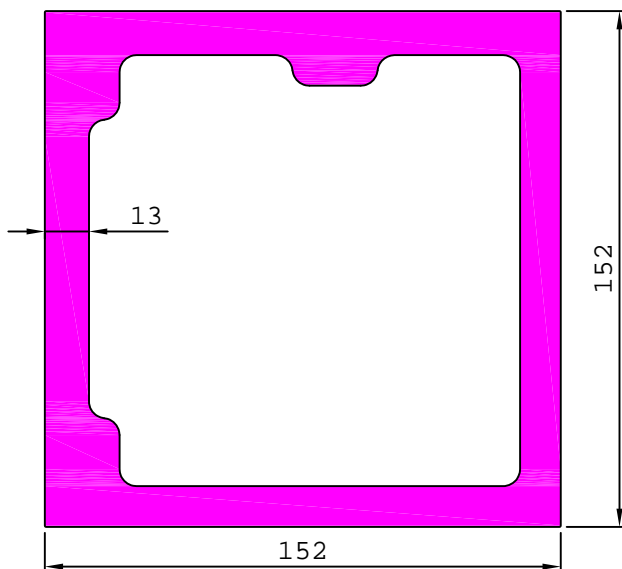

28253

2.711 kg/m

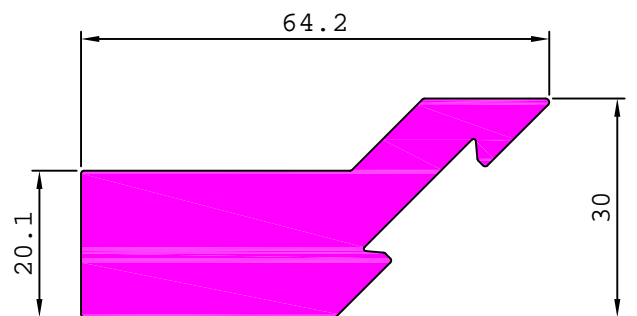

INDUSTRIAL

MISCELLANEOUS

28257 3.990 kg/m

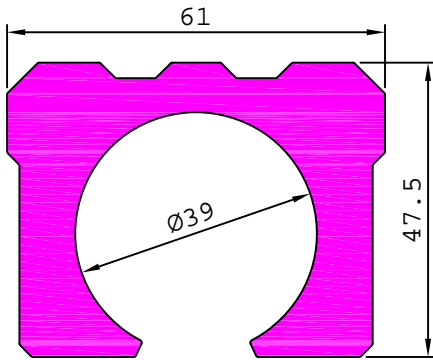

28258 2.692 kg/m

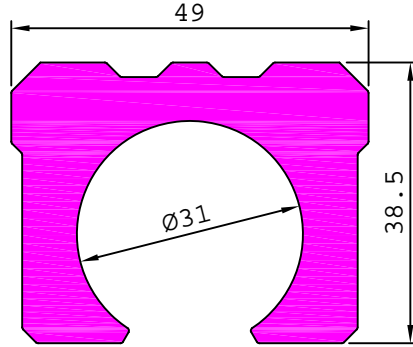

28259 2.178 kg/m

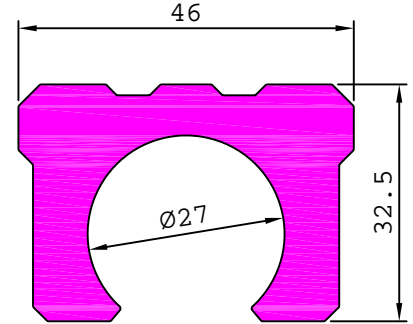

28262 4.584 kg/m

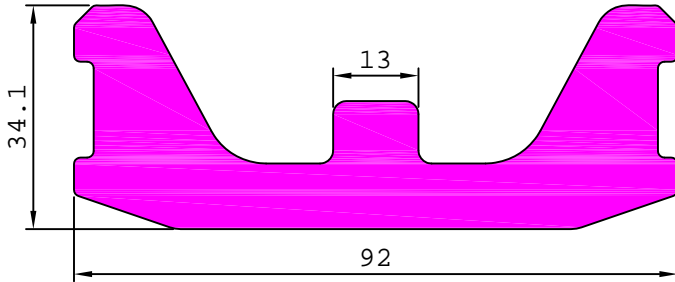

28263 9.030 kg/m

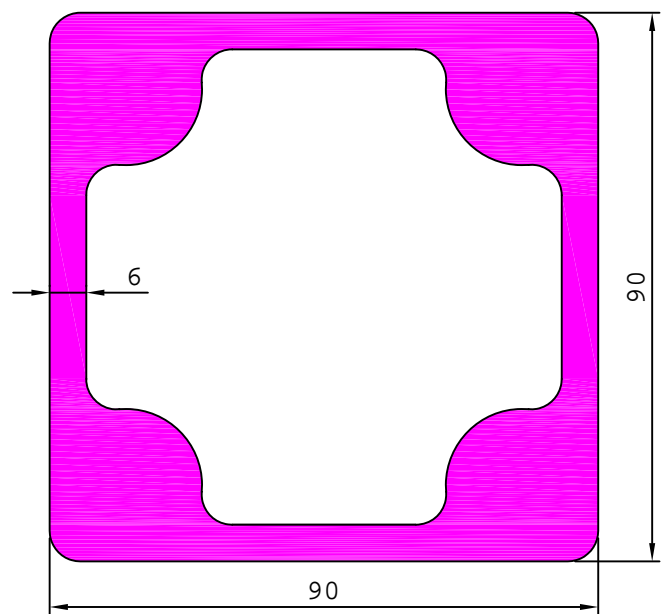

28267 0.686 kg/m

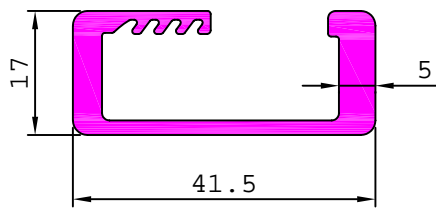

28268 34.323 kg/m

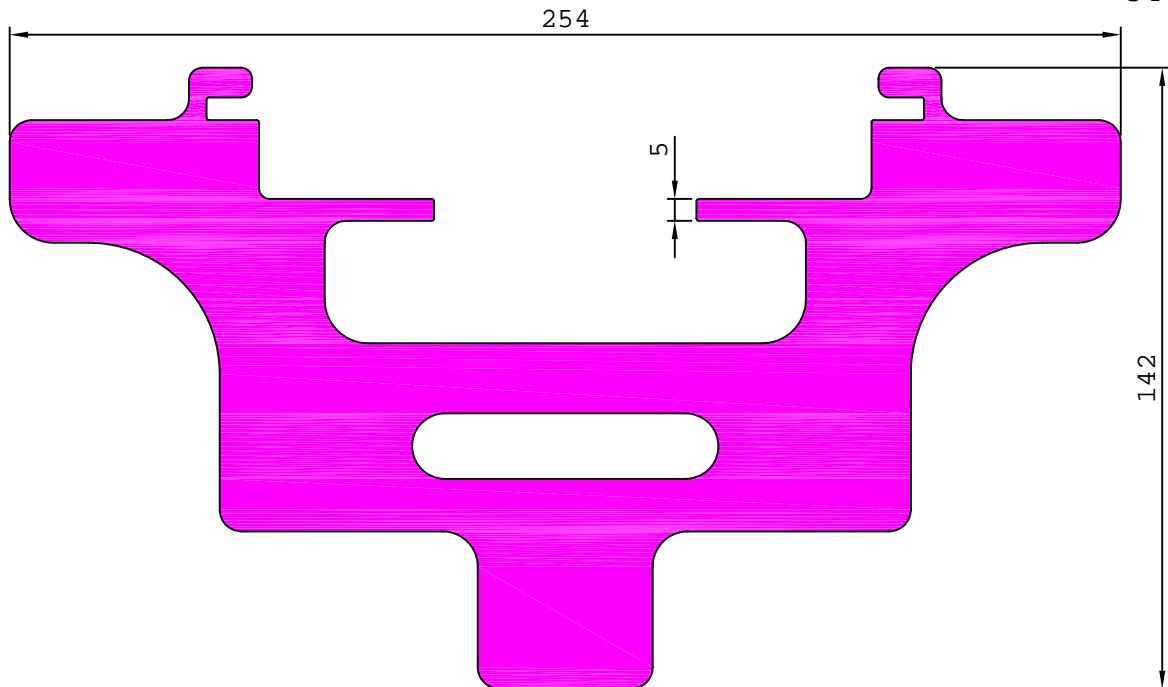

INDUSTRIAL

MISCELLANEOUS

28264 56 3.318 kg/m

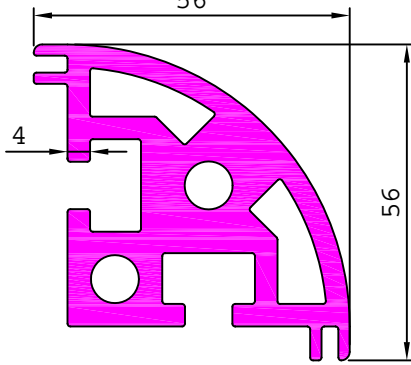

28271 5.198 kg/m

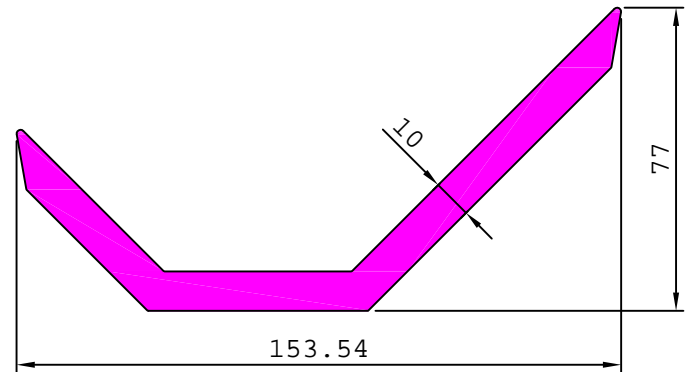

28272 5.720 kg/m

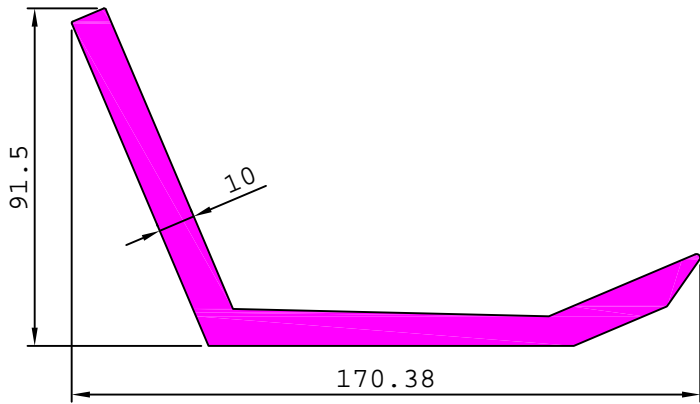

28273 7.069 kg/m

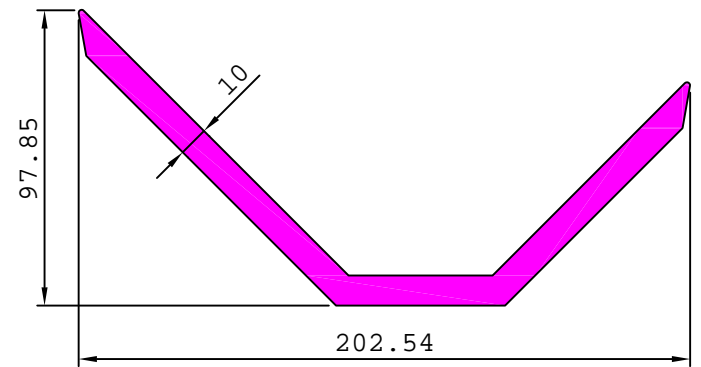

28275 8.341 kg/m

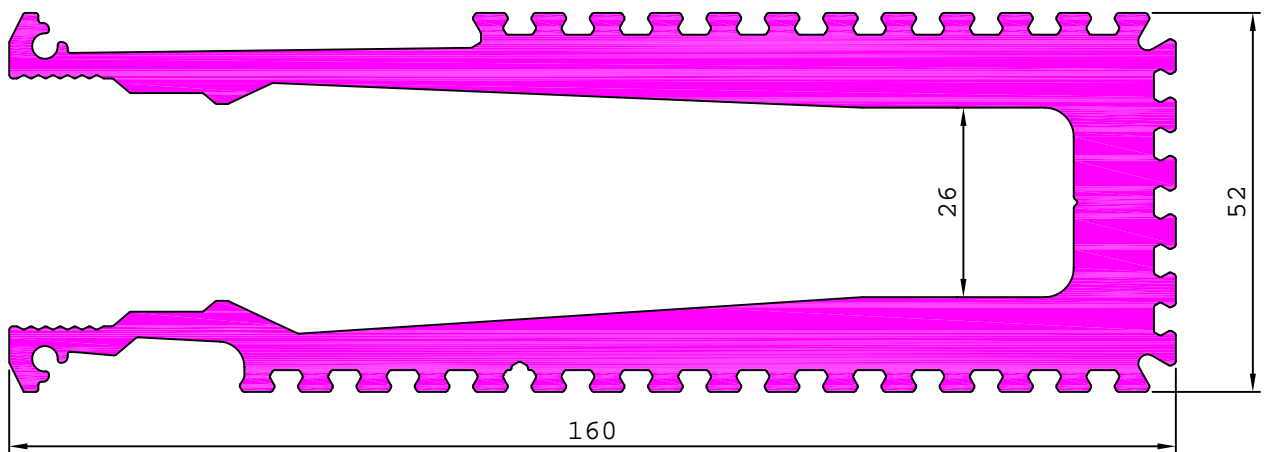

28276 2.748 kg/m

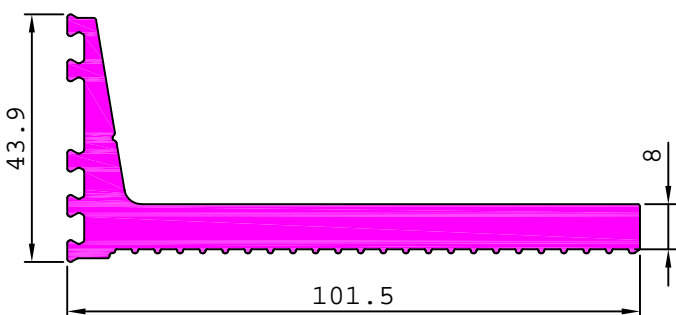

28277 6.990 kg/m

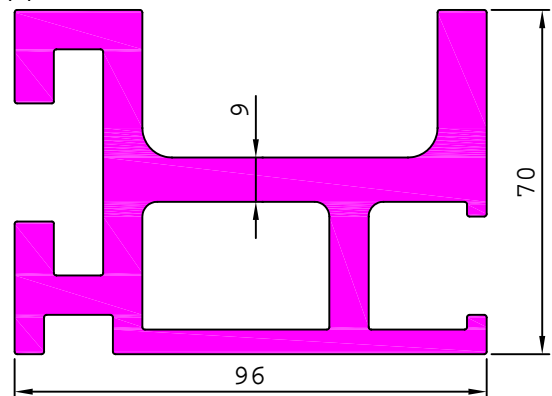

INDUSTRIAL

MISCELLANEOUS

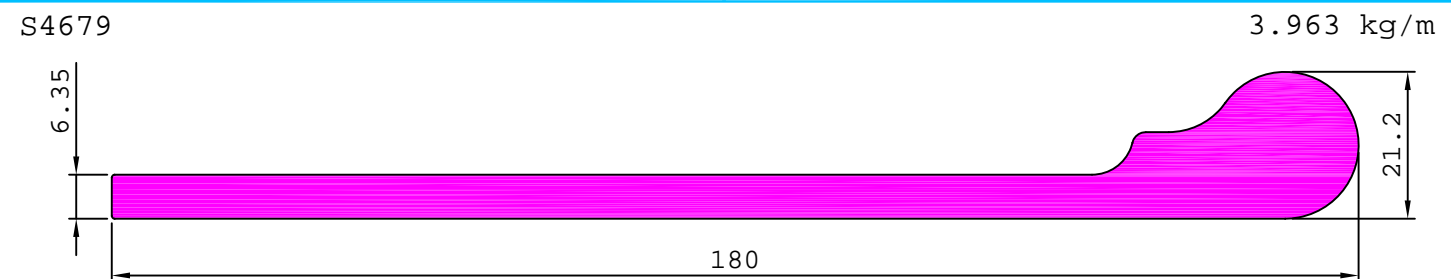
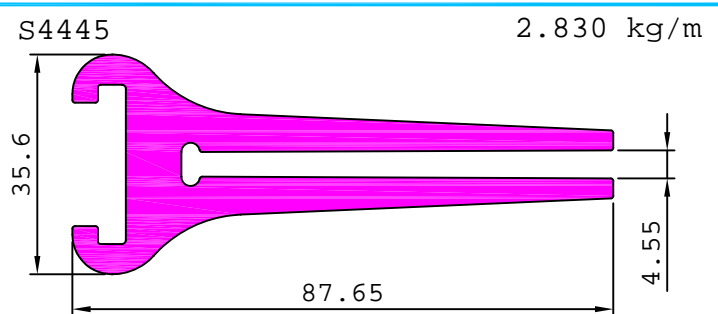
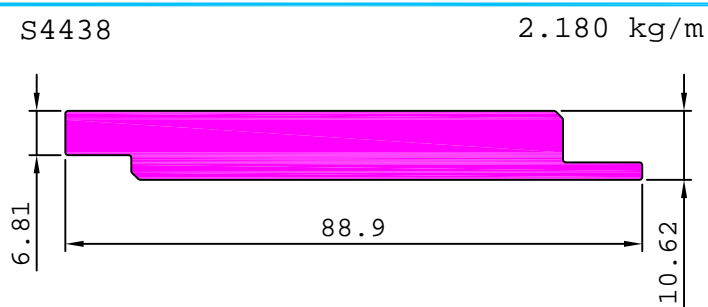
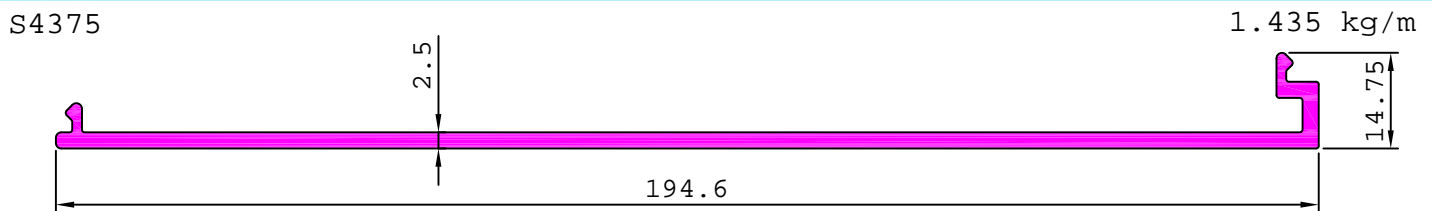
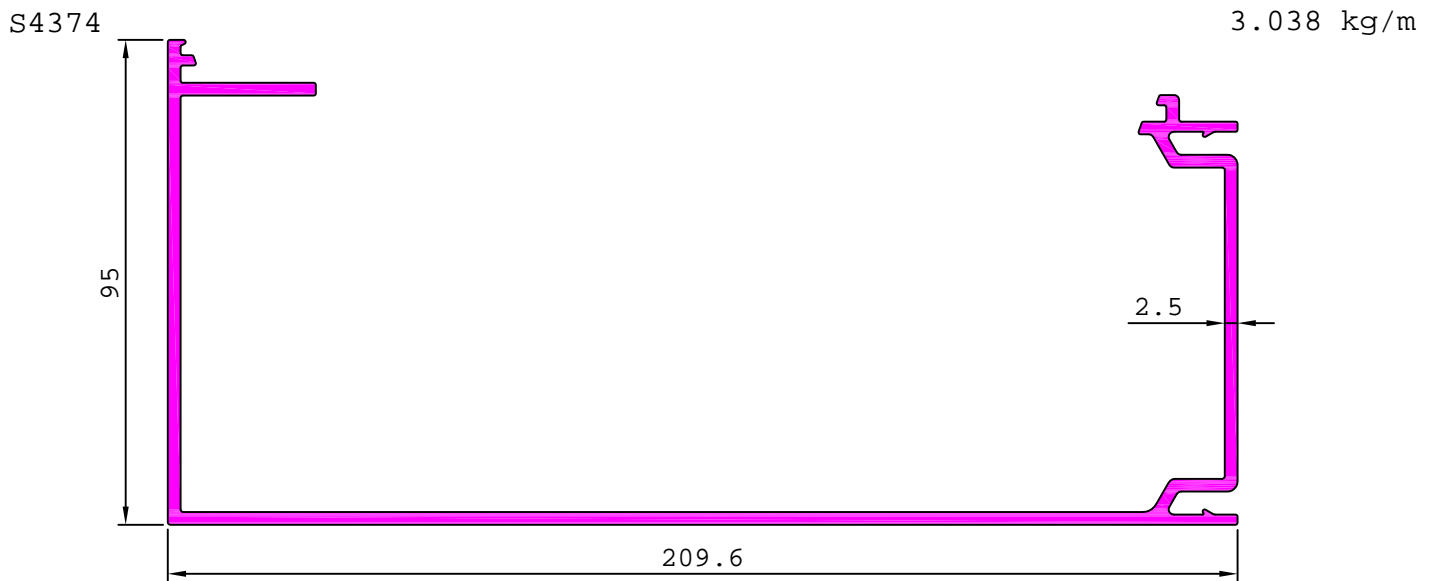
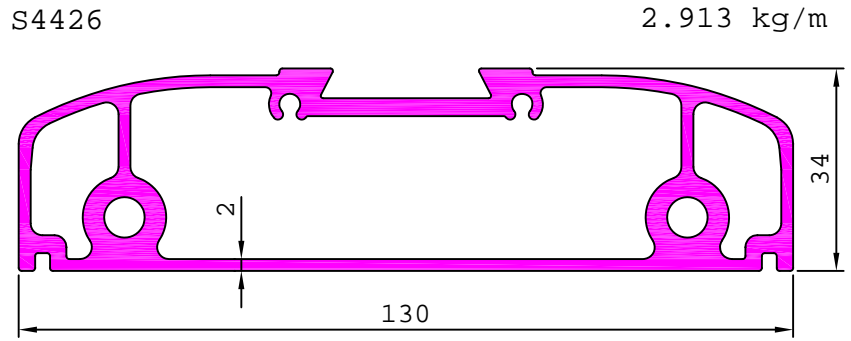
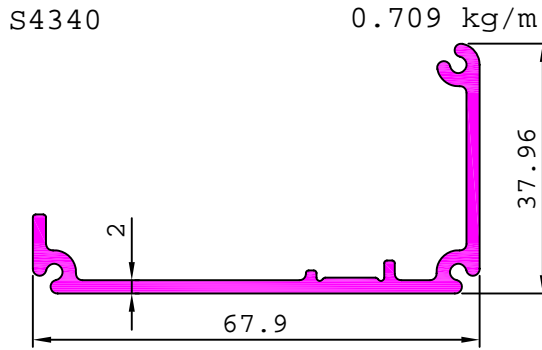

INDUSTRIAL

MISCELLANEOUS

S4456 3.036 kg/m

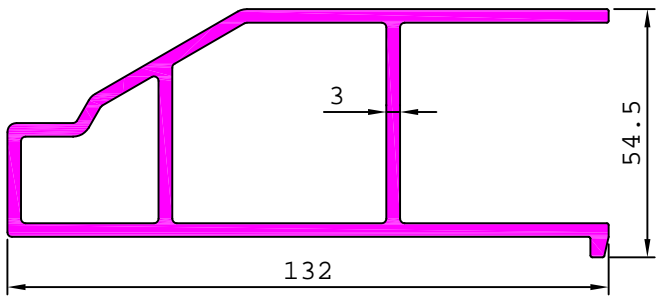

S4553 0.892 kg/m

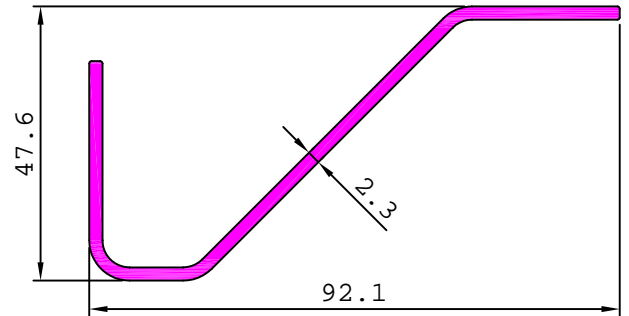

S4624 5.653 kg/m

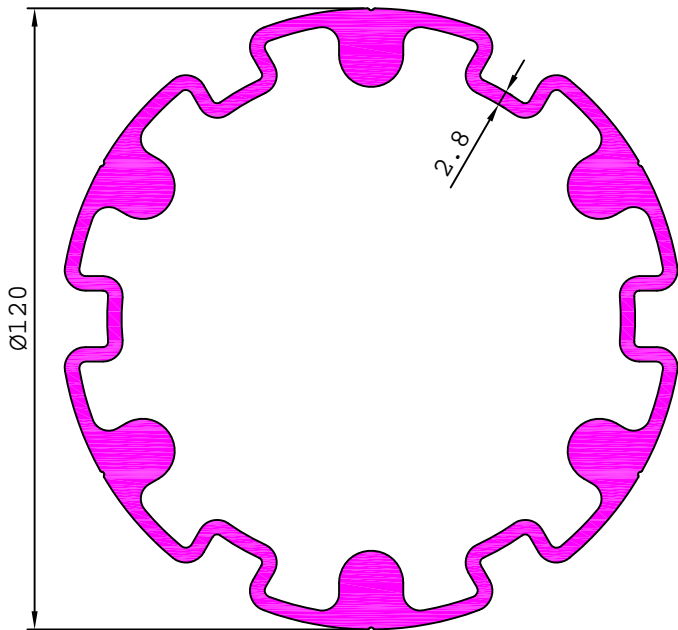

S4632 0.405 kg/m

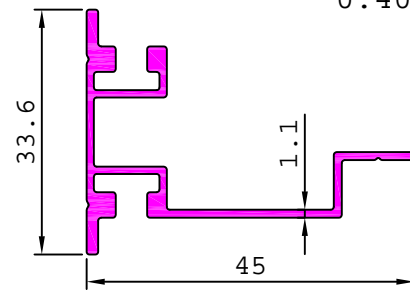

S4633 0.259 kg/m

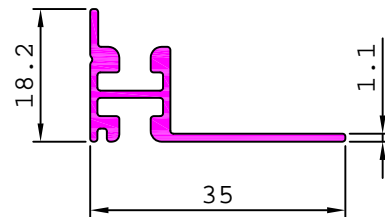

S4672 5.804 kg/m

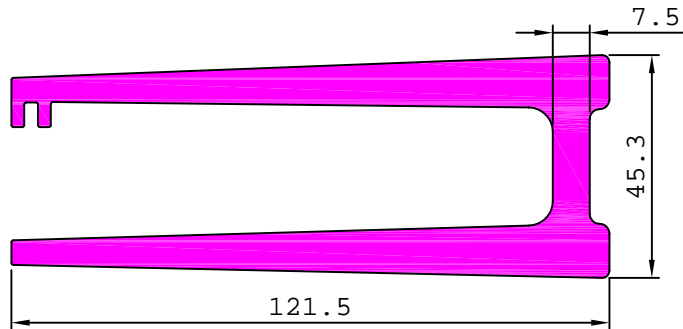

S4680 4.467 kg/m

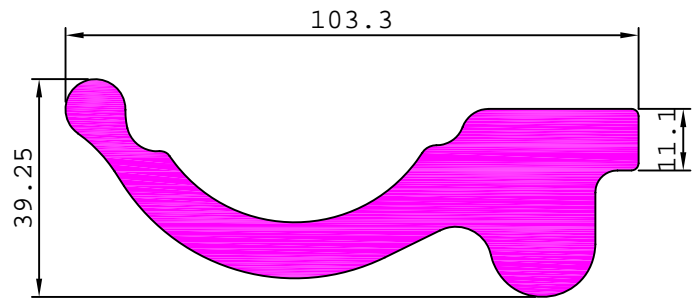

S4681 3.276 kg/m

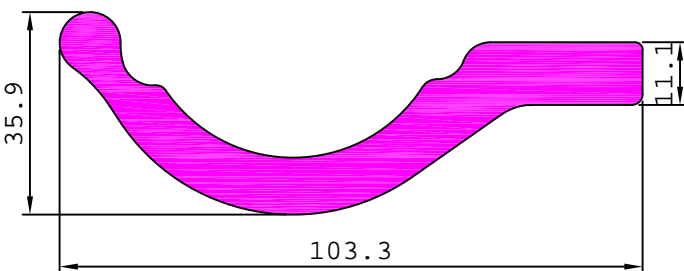

S4752 2.077 kg/m

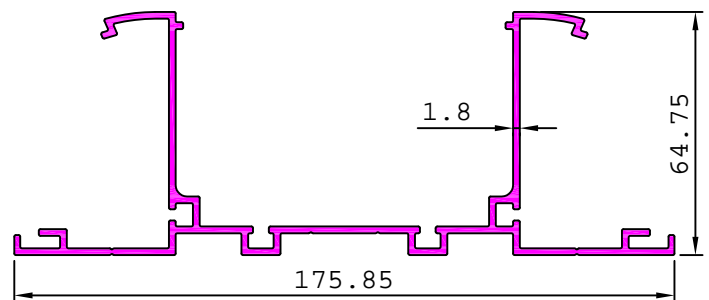

INDUSTRIAL

MISCELLANEOUS

S4740

2.910 kg/m

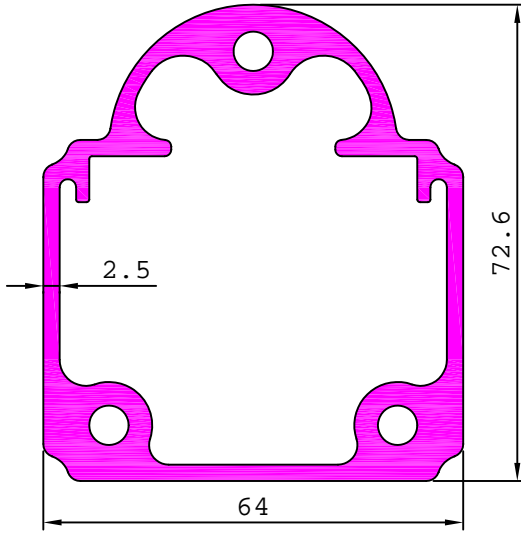

S4741

1.481 kg/m

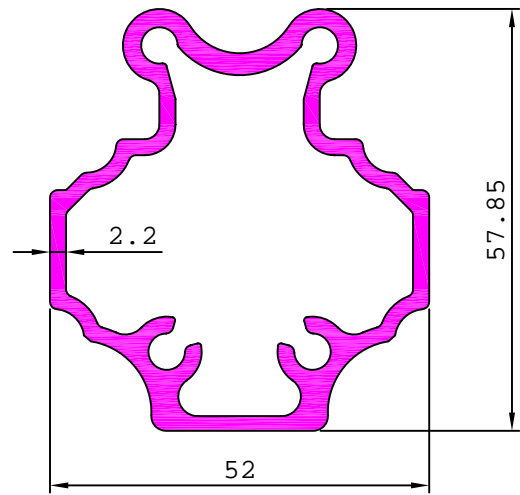

S4742

6.779 kg/m

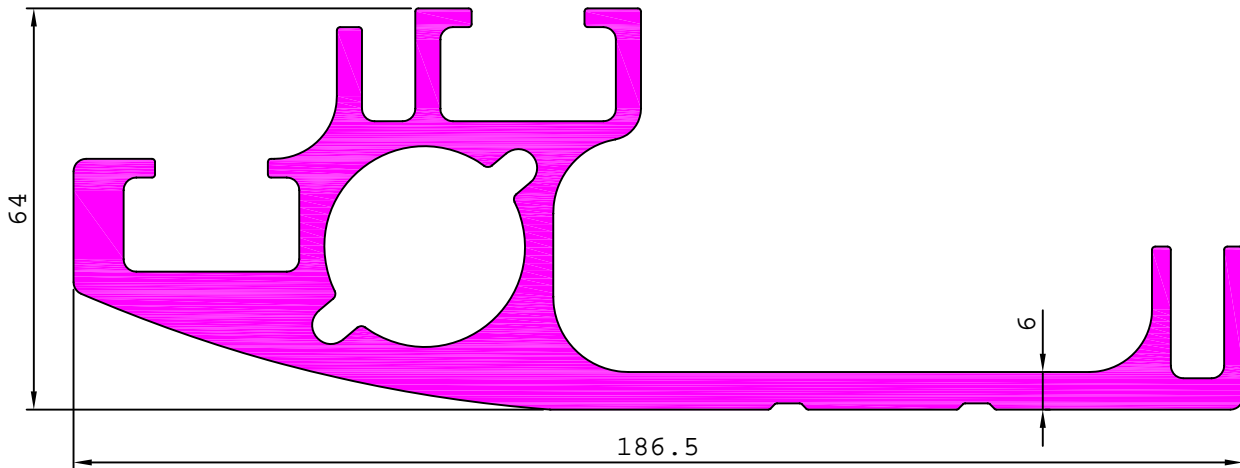

S4753

0.398 kg/m

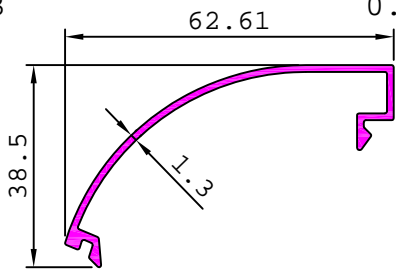

S4754

0.367 kg/m

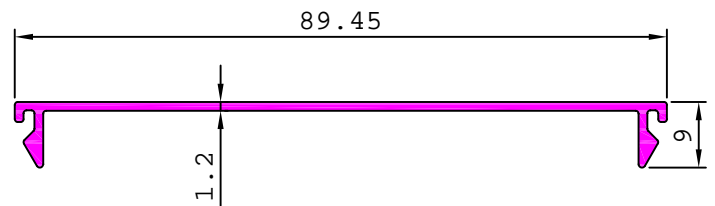

S4806

2.652 kg/m

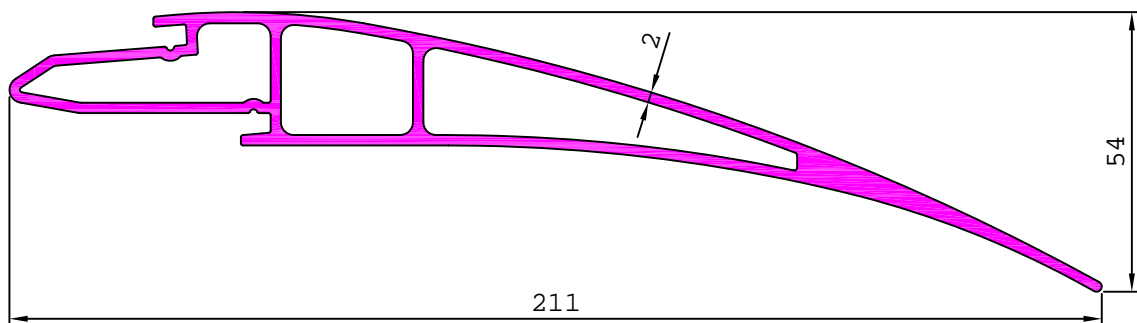

INDUSTRIAL

MISCELLANEOUS

S4763

4.907 kg/m

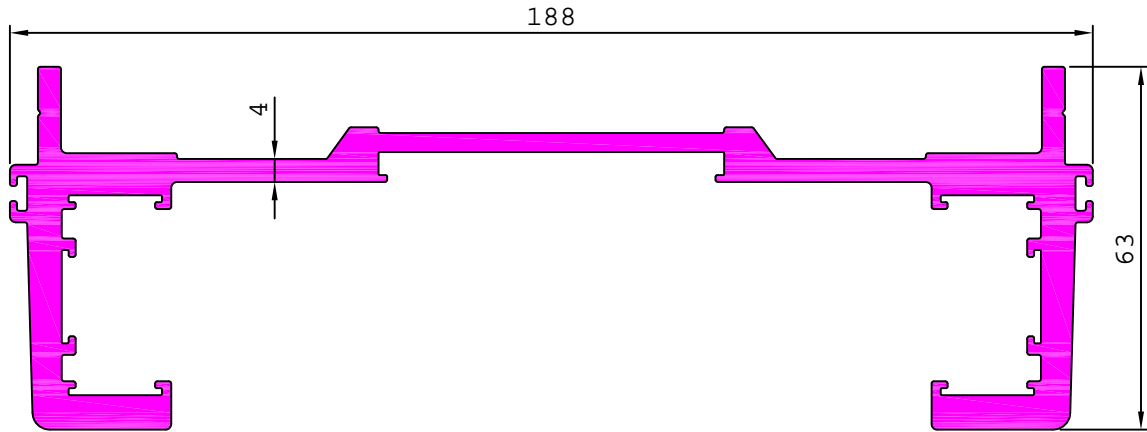

S4814

24.213 kg/m

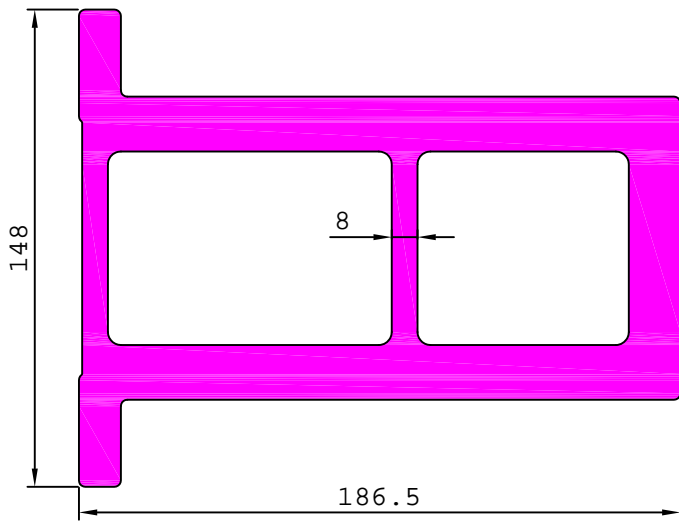

S4821

1.671 kg/m

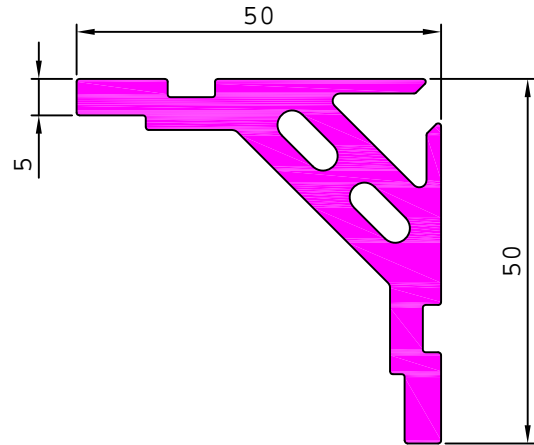

S4869

0.309 kg/m

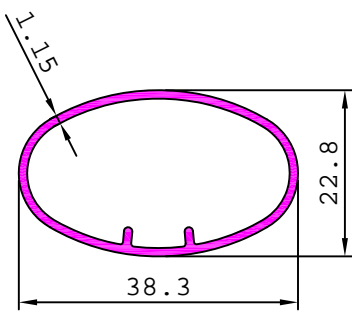

S4870

0.318 kg/m

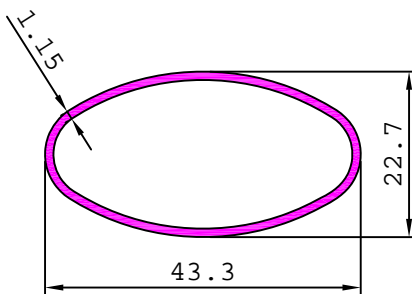

S4871

0.314 kg/m

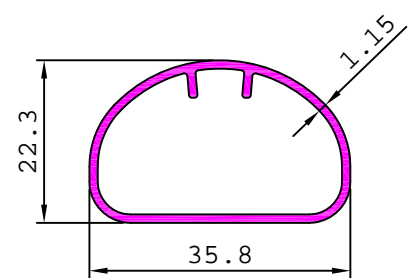

S4872

0.182 kg/m

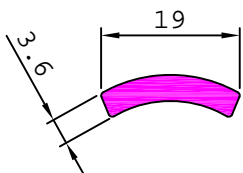

S4873

0.359 kg/m

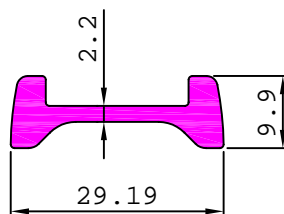

S4905

0.625 kg/m

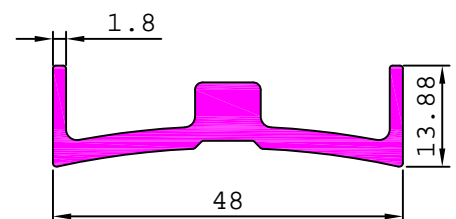

INDUSTRIAL

MISCELLANEOUS

S4983

4.887 kg/m

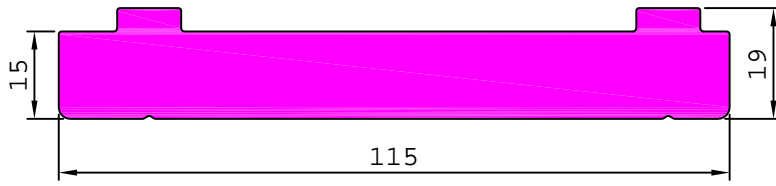

S4985

0.289 kg/m

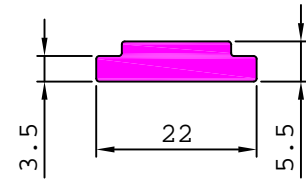

29645

5.565 kg/m

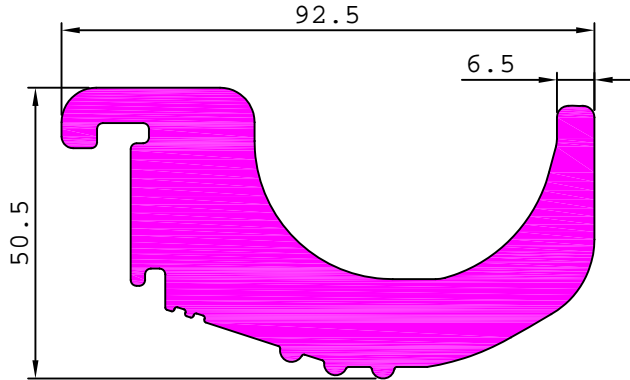

29646

5.261 kg/m

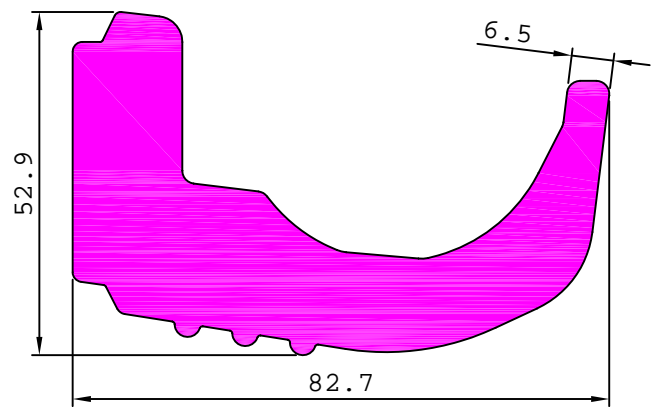

S5067

2.142 kg/m

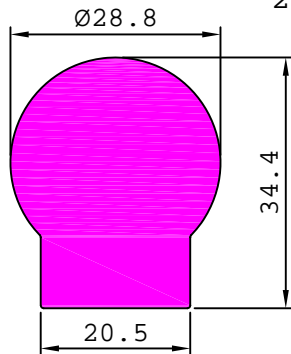

S5069

1.032 kg/m

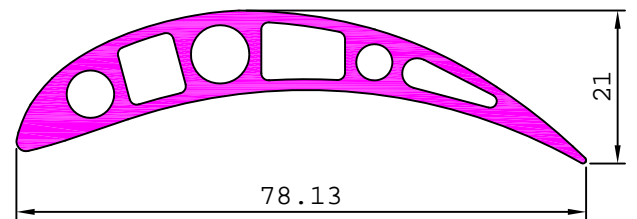

29325

0.924 kg/m

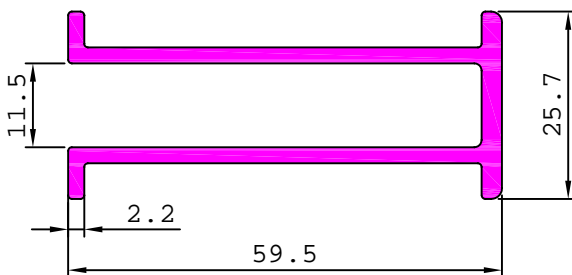

28655

3.226 kg/m

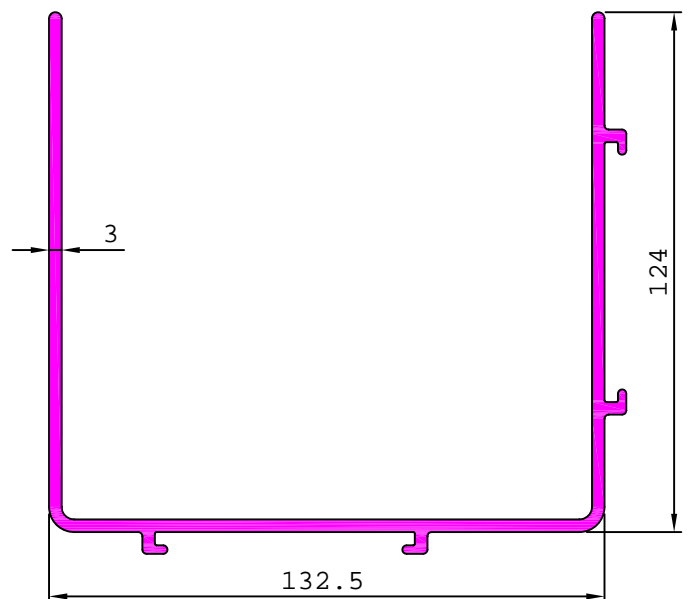

27585

1.845 kg/m

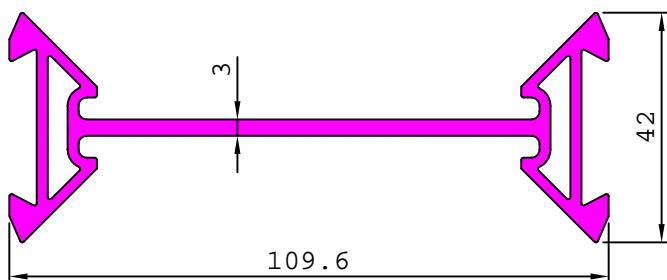

INDUSTRIAL

MISCELLANEOUS

29421

2.914 kg/m

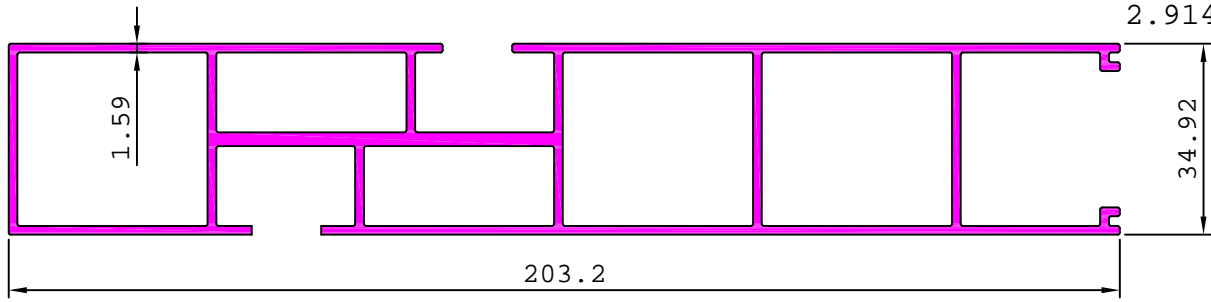

S4705

4.150 kg/m

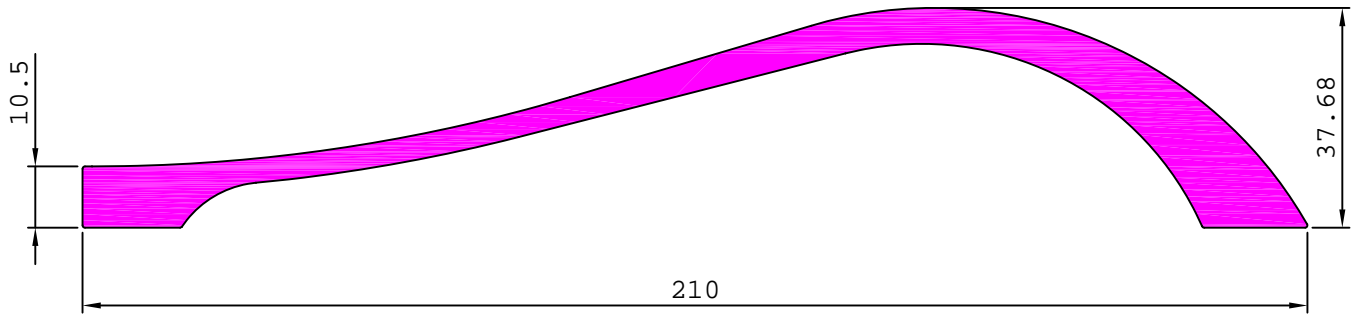

S5096

22.000 kg/m

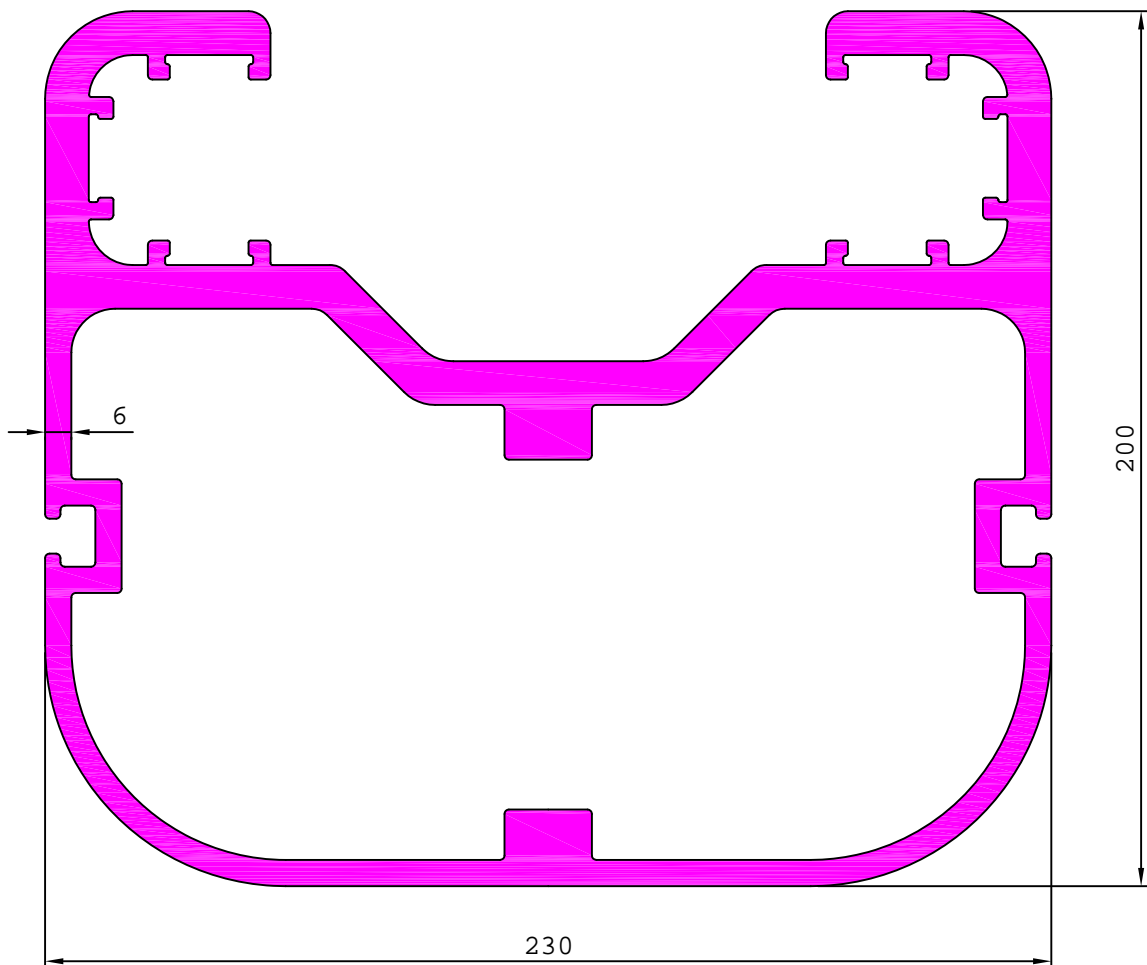

INDUSTRIAL

MISCELLANEOUS

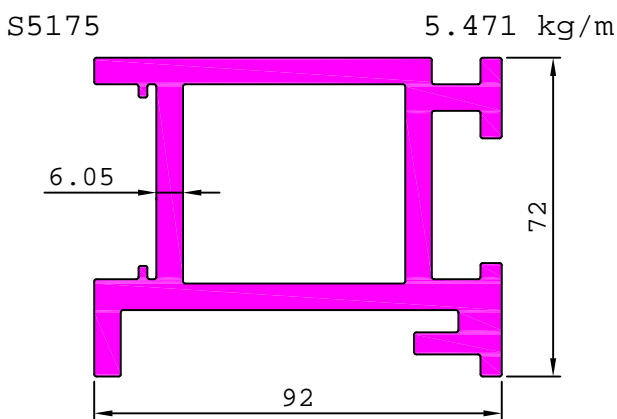
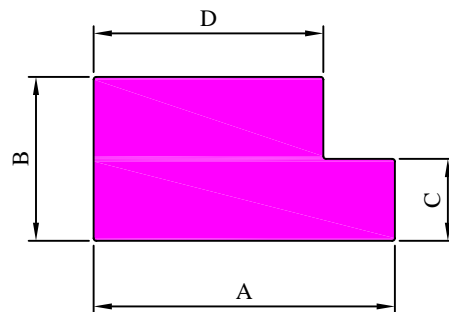
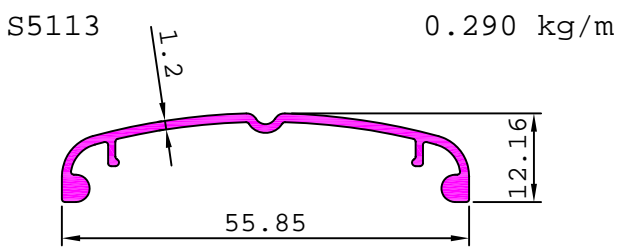
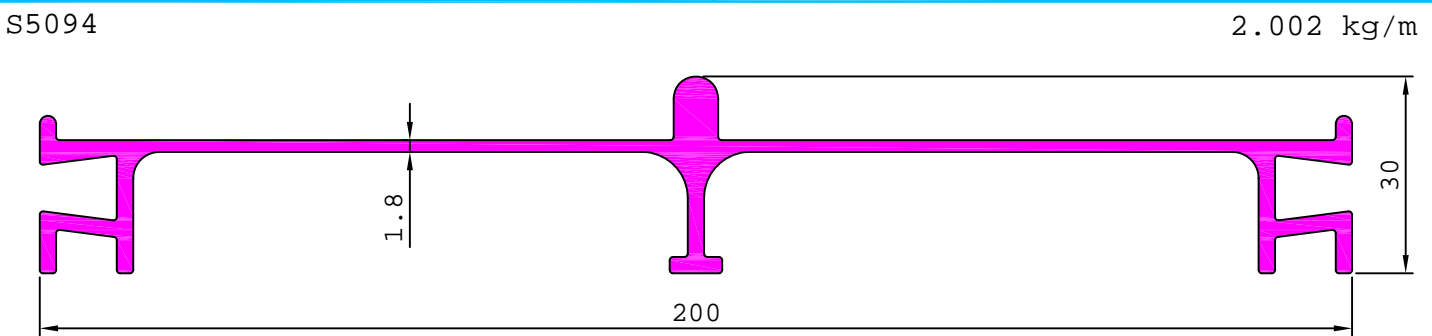
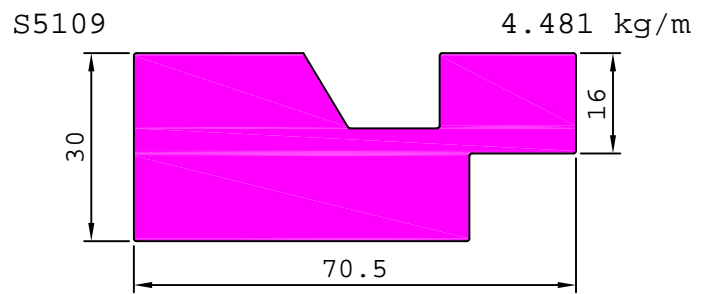
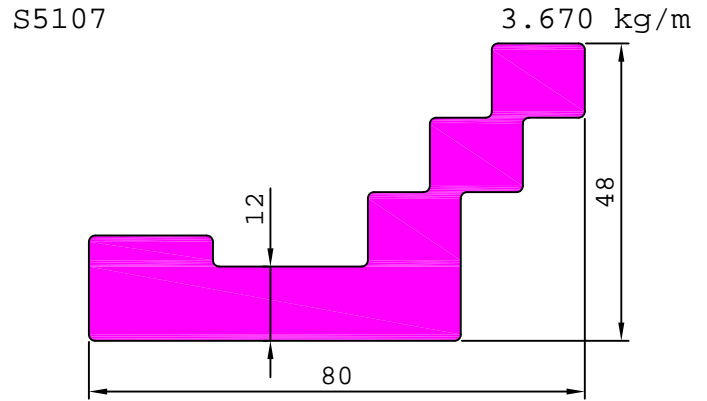
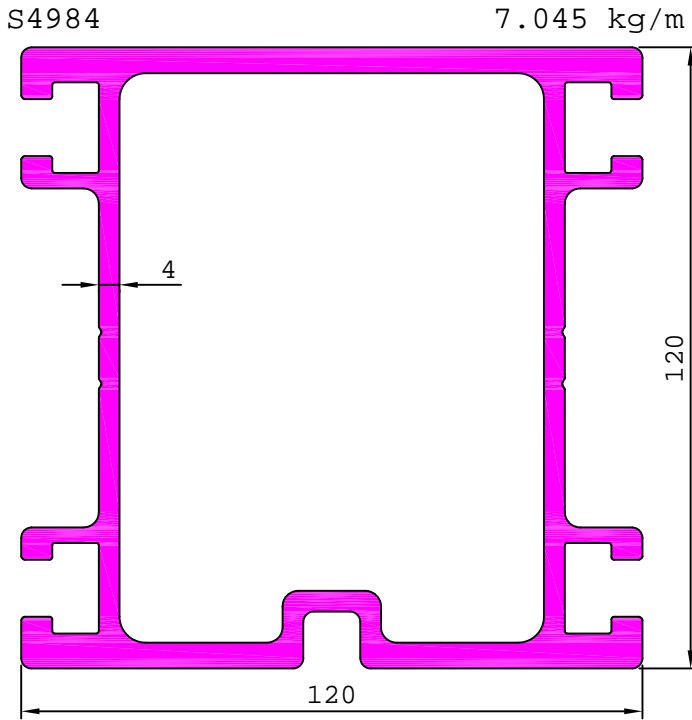

SL No	SECTION No	A	B	C	D	WEIGHT kg/m
1	S5111	45.90	25.00	12.50	35.00	2.730
2	S5110	55.50	30.00	16.00	38.50	3.853
3	S5108	70.50	35.00	21.00	53.50	6.019

INDUSTRIAL

MISCELLANEOUS

S5210

3.658 kg/m

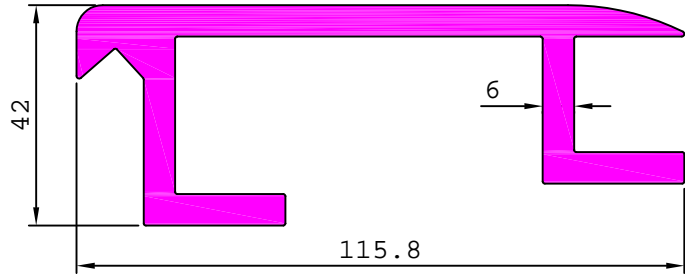

S5222

0.396 kg/m

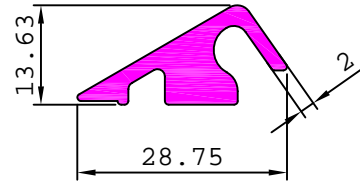

INDUSTRIAL

MISCELLANEOUS

S4906

7.241 kg/m

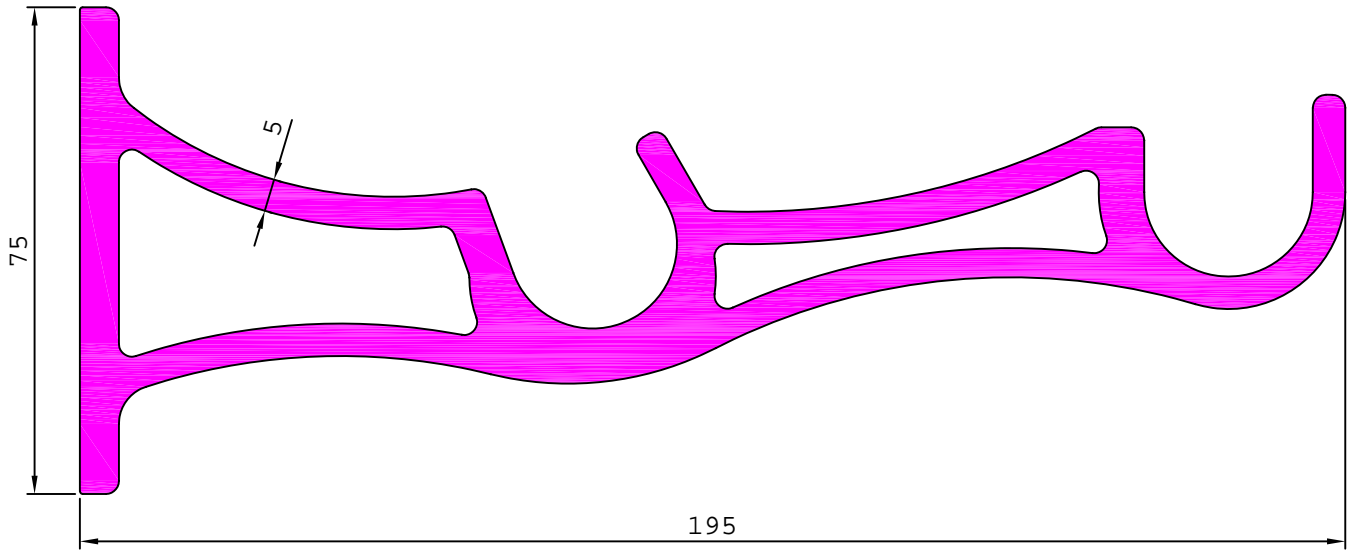

28039

11.066 kg/m

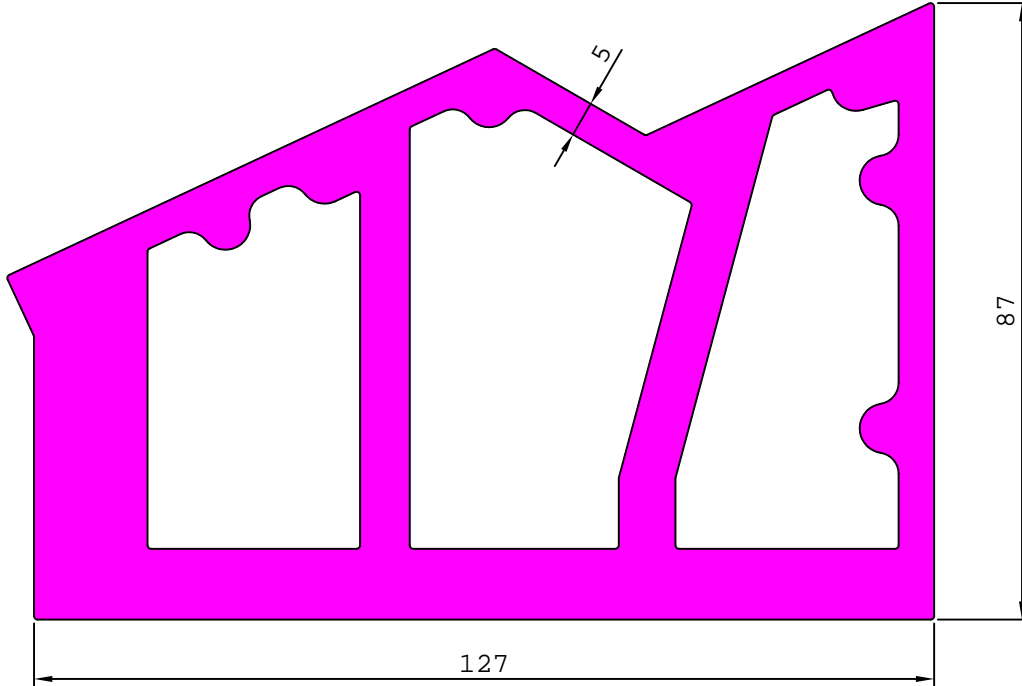

INDUSTRIAL

MISCELLANEOUS

27814

26.108 kg/m

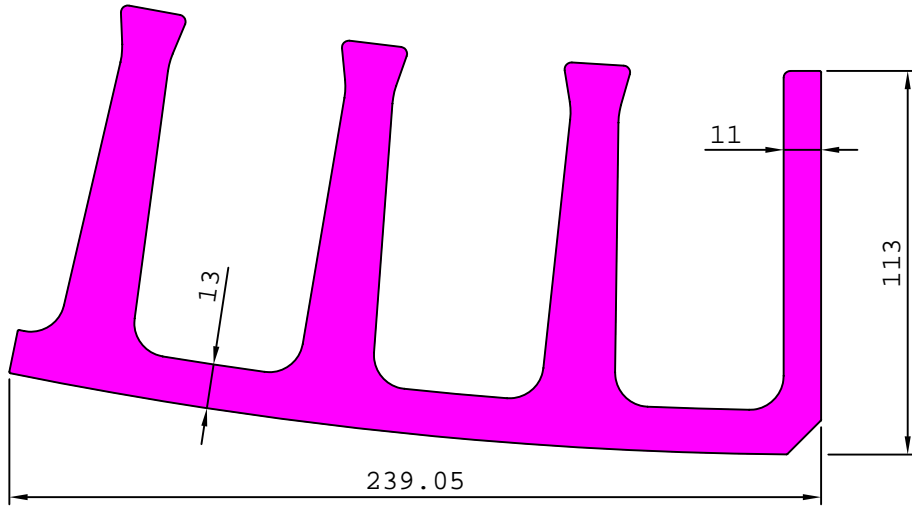

27840

25.769 kg/m



27864

26.350 kg/m

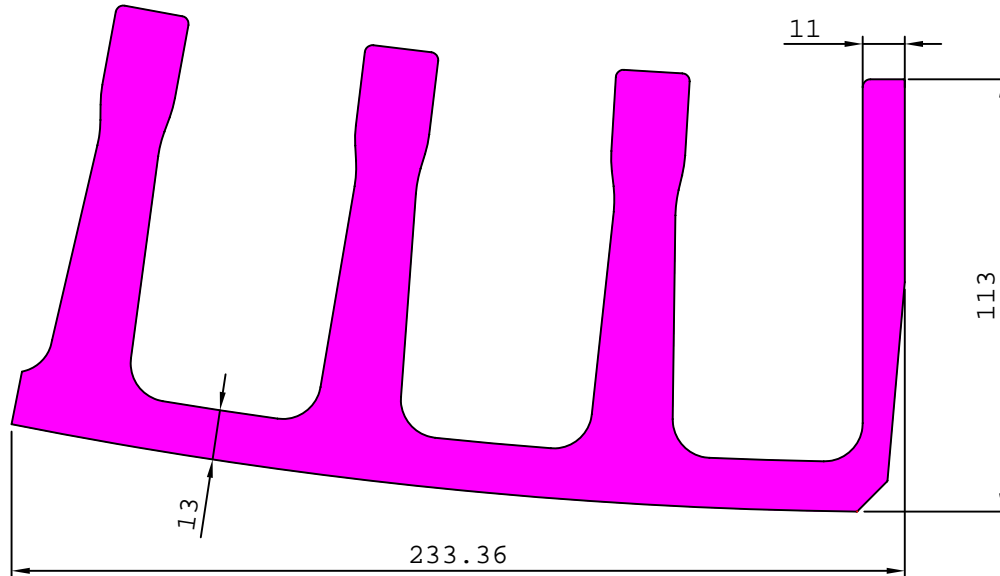

INDUSTRIAL

MISCELLANEOUS

27672 1.668 kg/m

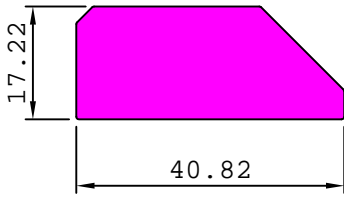

27843 0.310 kg/m

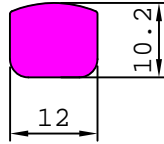

27846 0.622 kg/m

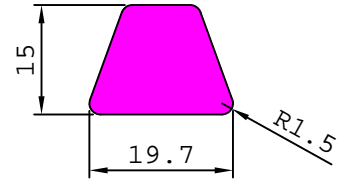

27856 0.466 kg/m

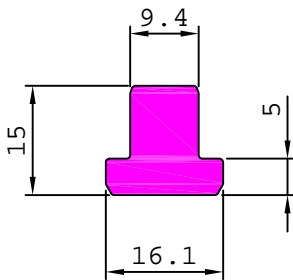

27869 0.866 kg/m

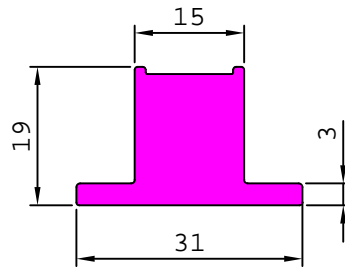

27872 0.268 kg/m

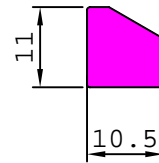

27888 0.480 kg/m

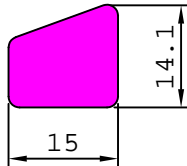

27922 0.229 kg/m

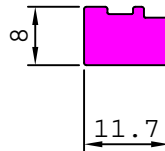

27934 0.249 kg/m

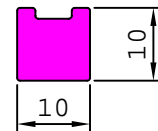

27940 0.247 kg/m

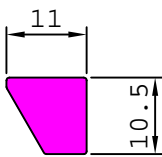

27950 0.363 kg/m

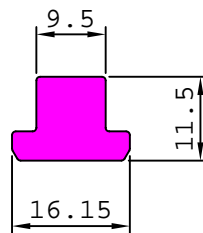

28077 0.168 kg/m

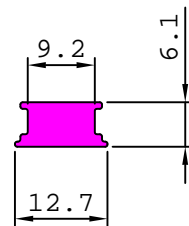

28228 0.162 kg/m

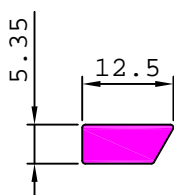

28265 0.218 kg/m

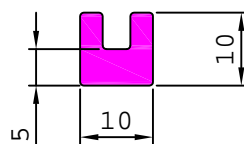

S4307 0.124 kg/m

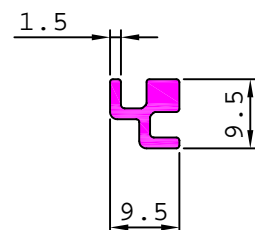

INDUSTRIAL

MISCELLANEOUS

S4384 0.206 kg/m

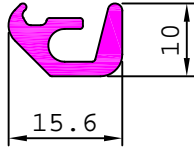

S4443 0.612 kg/m

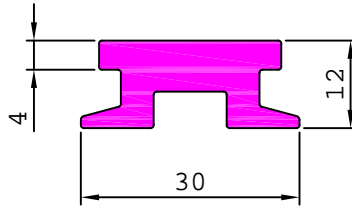

S4444 0.570 kg/m

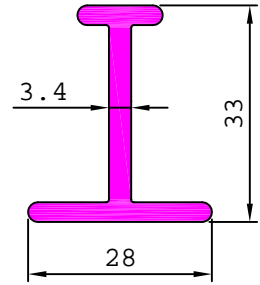

S4568 0.245 kg/m

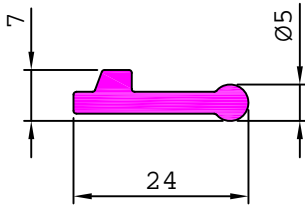

S4573 0.345 kg/m

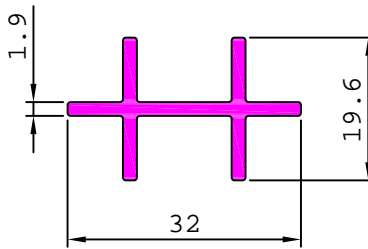

S4750 0.487 kg/m

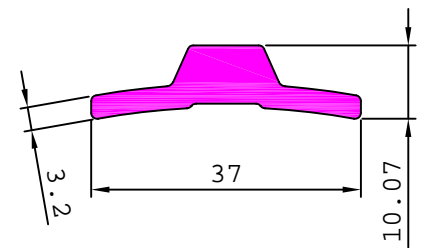

S4751 0.606 kg/m

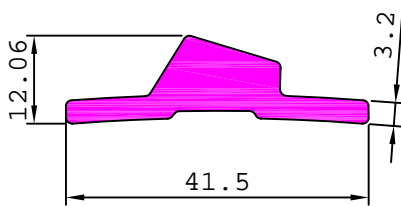

S4820 0.438 kg/m

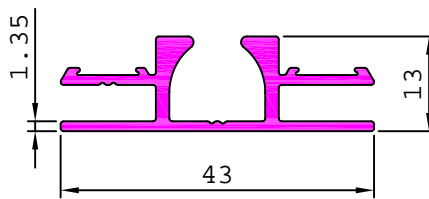

29037 0.146 kg/m

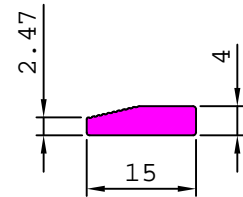

29651 1.267 kg/m

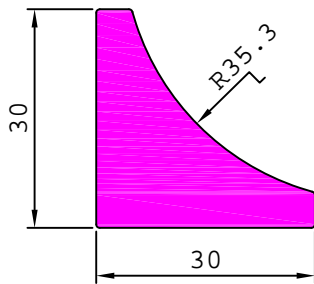

S4543 1.959 kg/m

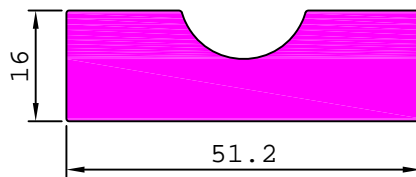

S5093 0.087 kg/m

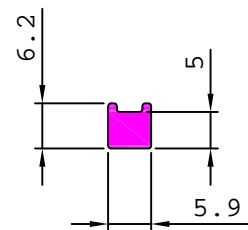

S5089 0.081 kg/m

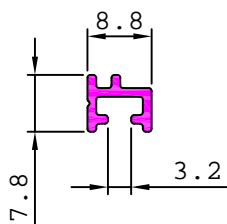

INDUSTRIAL

MISCELLANEOUS

27469 1.394 kg/m

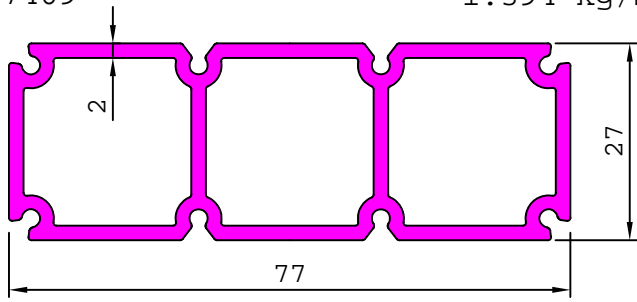

27472 1.803 kg/m

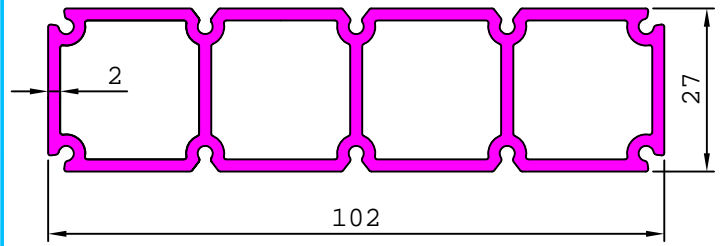

27594 1.337 kg/m

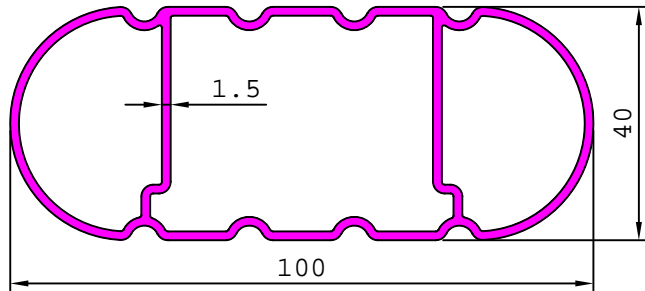

27776 0.827 kg/m

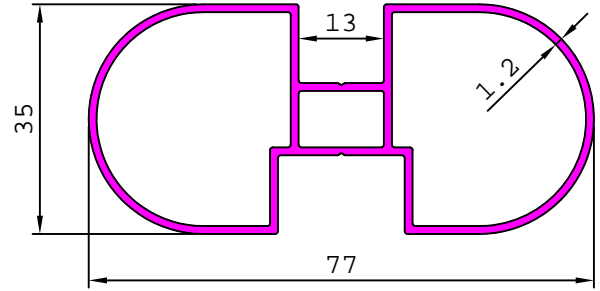

27818 2.461 kg/m

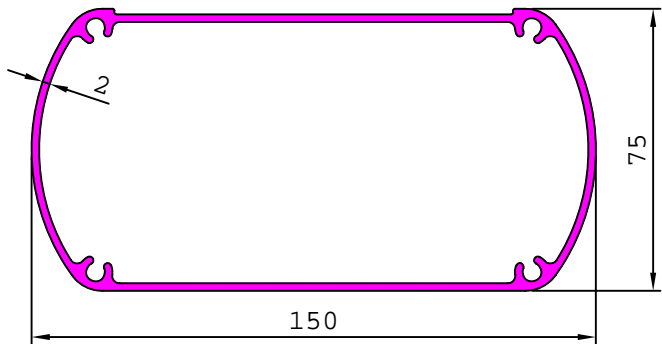

27990 5.914 kg/m

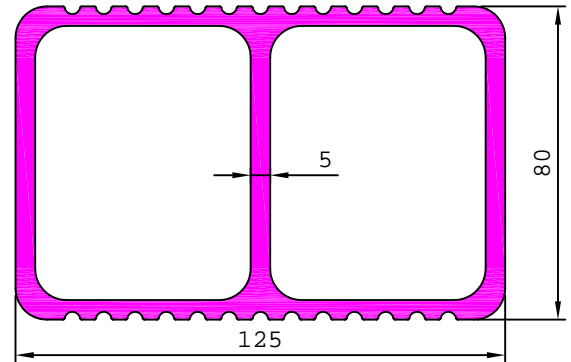

28144 4.240 kg/m

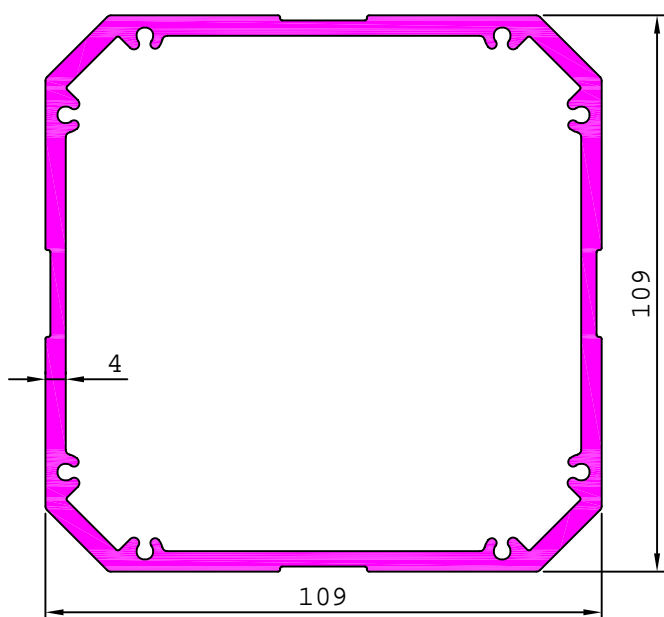

INDUSTRIAL

MISCELLANEOUS

28027

11.619 kg/m

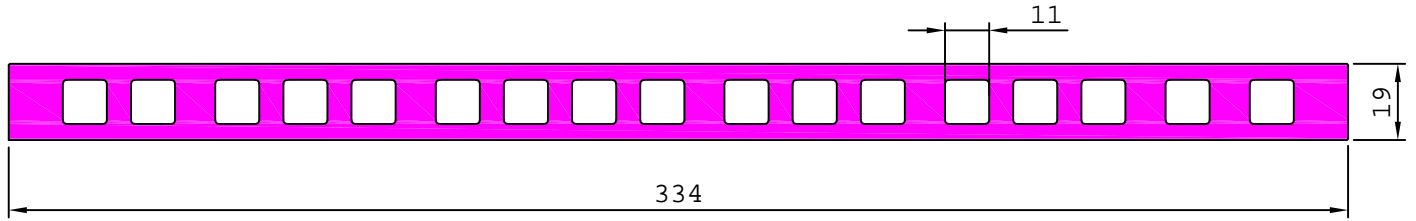

28070

10.289 kg/m

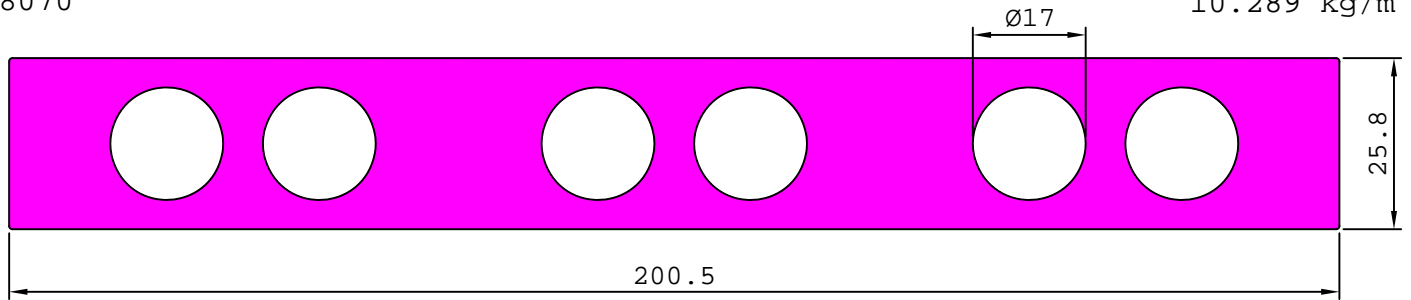

S4277

13.307 kg/m

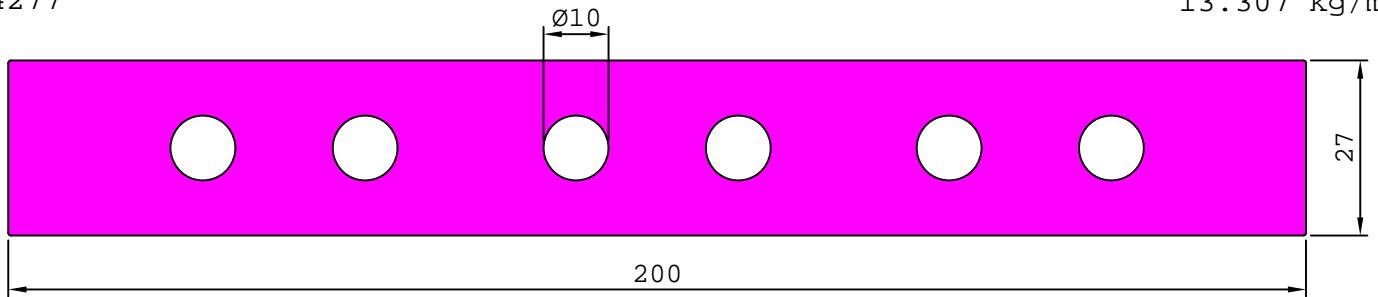

28722

5.939 kg/m

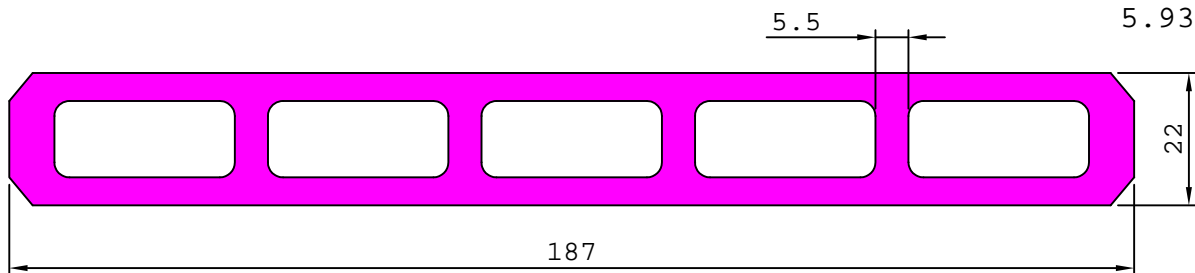

29198

8.532 kg/m

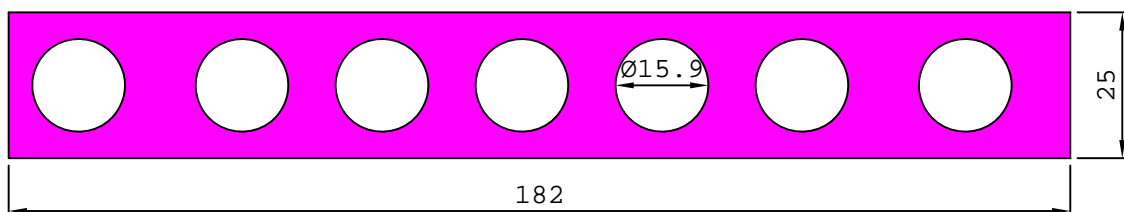

INDUSTRIAL

MISCELLANEOUS

29636

7.782 kg/m

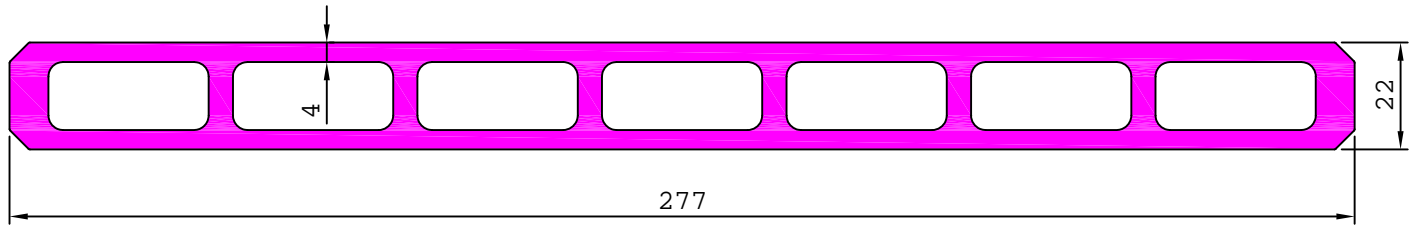

S5068

2.800 kg/m

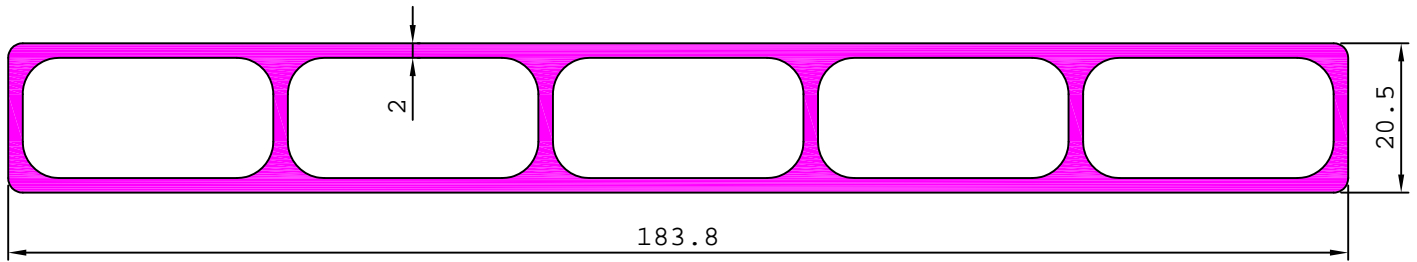

28736

4.326 kg/m

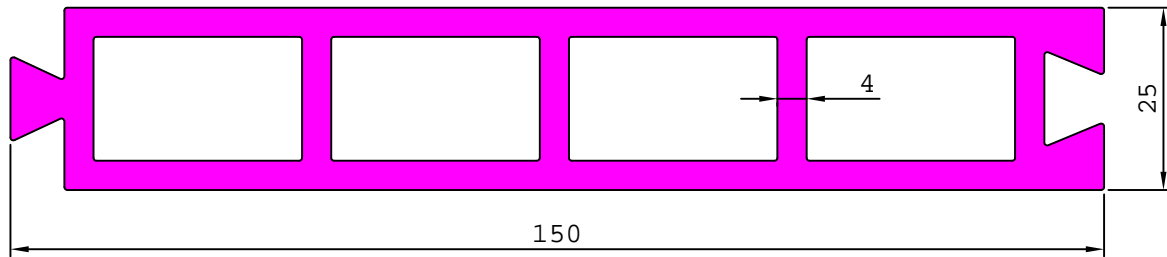

28834

5.750 kg/m

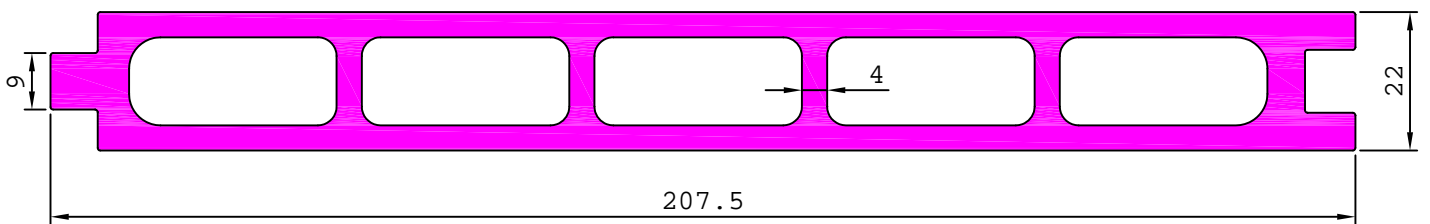

28733

5.772 kg/m

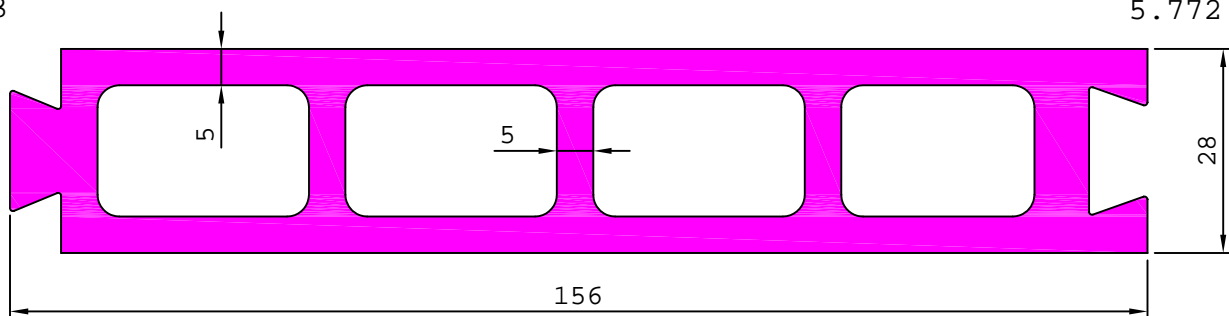

INDUSTRIAL

MISCELLANEOUS

28028

2.896 kg/m

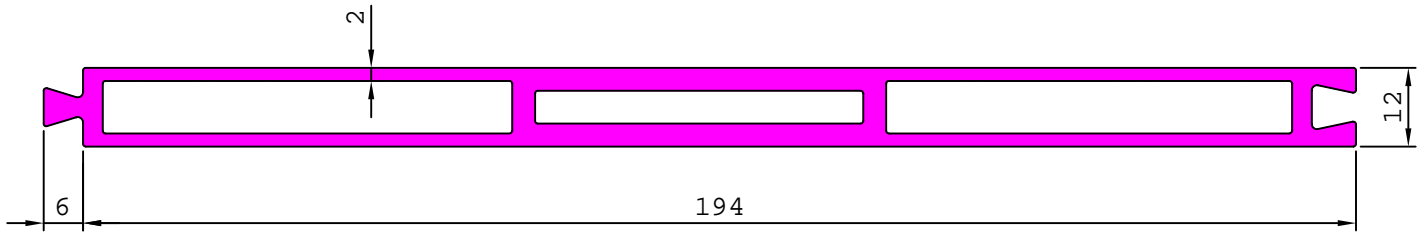

29641

4.113 kg/m

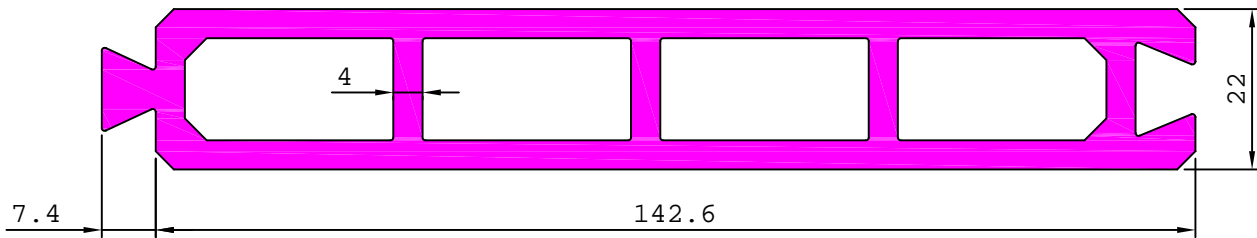

29642

3.296 kg/m

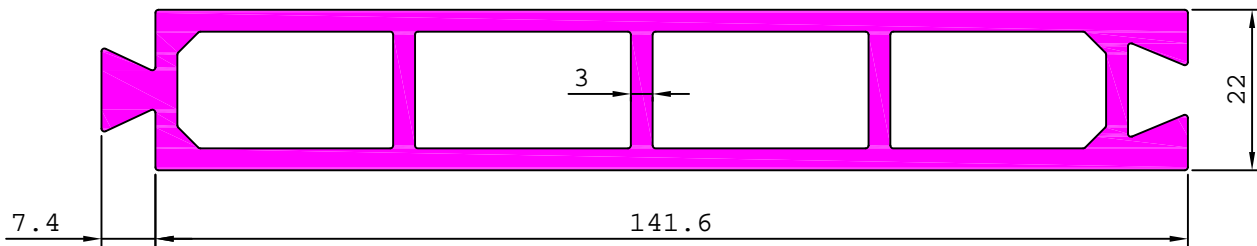

28719

4.146 kg/m

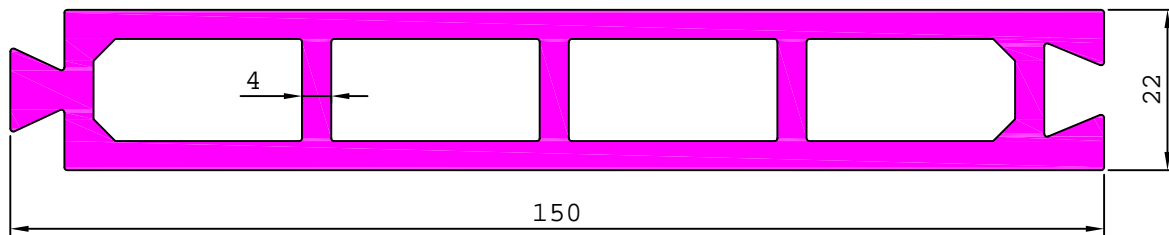

INDUSTRIAL

MISCELLANEOUS

27636

10.227 kg/m

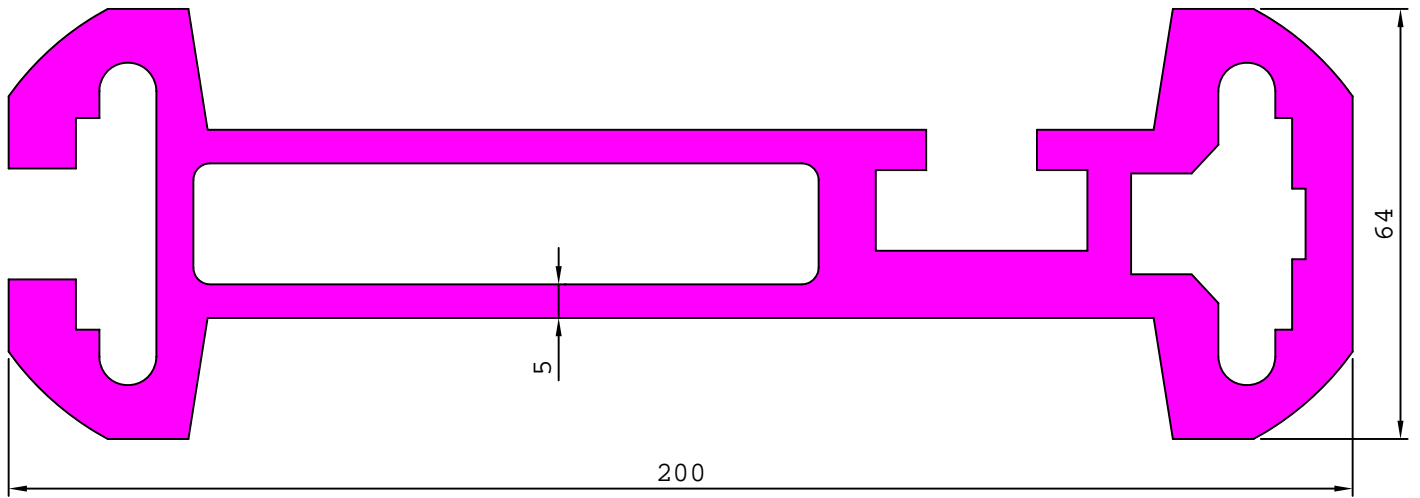

28017

5.881 kg/m

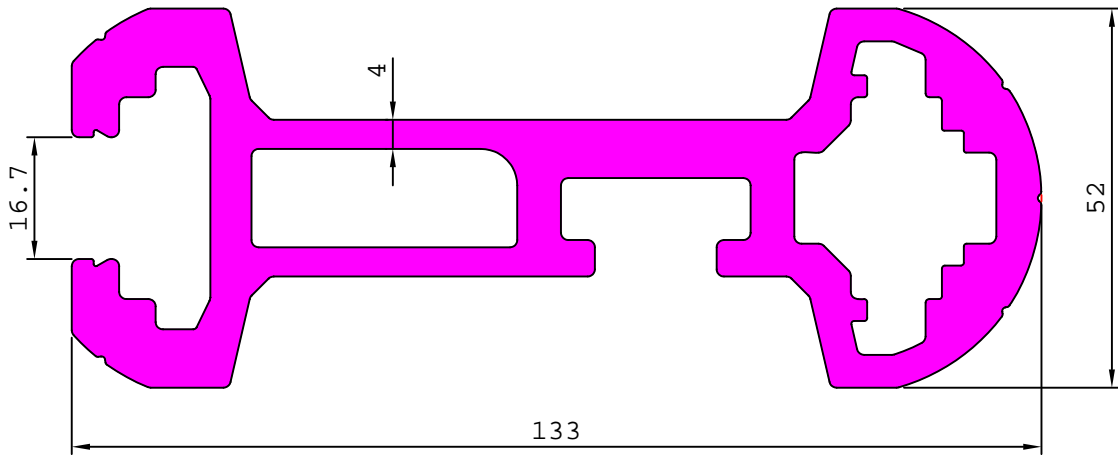

28179

6.854 kg/m

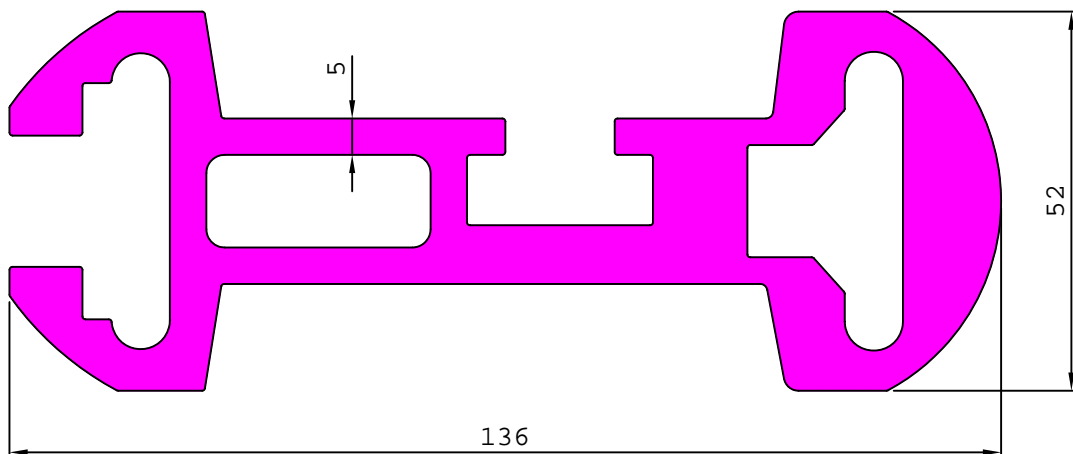

INDUSTRIAL

MISCELLANEOUS

28185

6.237 kg/m

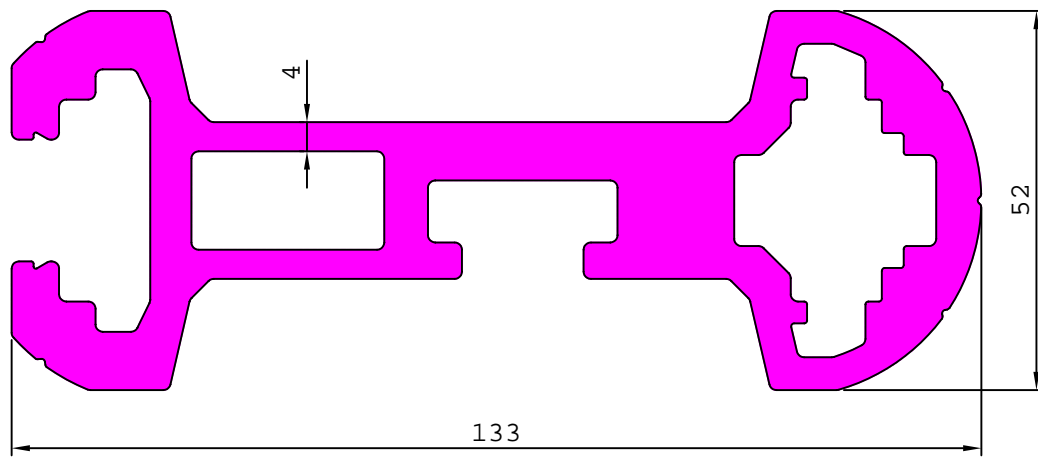

INDUSTRIAL

MISCELLANEOUS

28230

3.483 kg/m

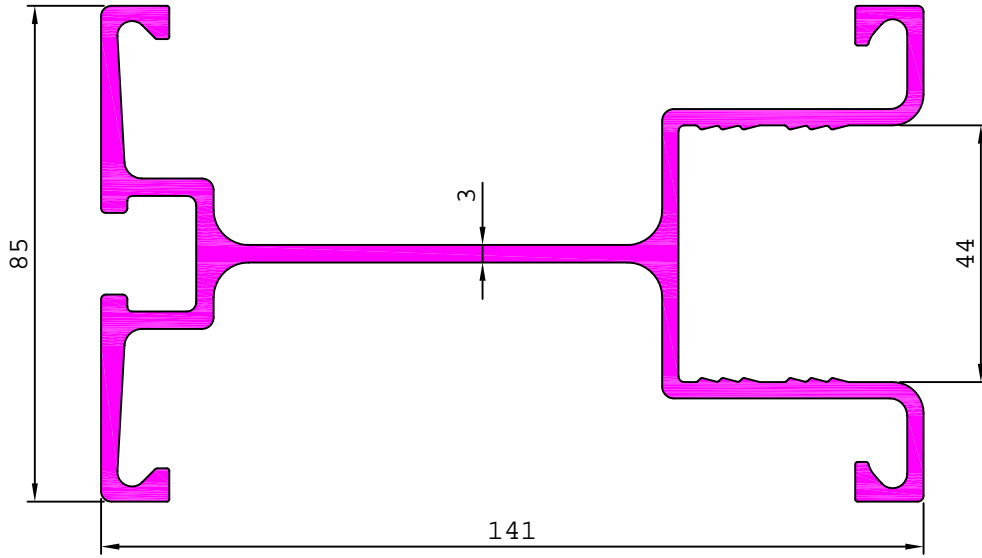

29605

4.743 kg/m

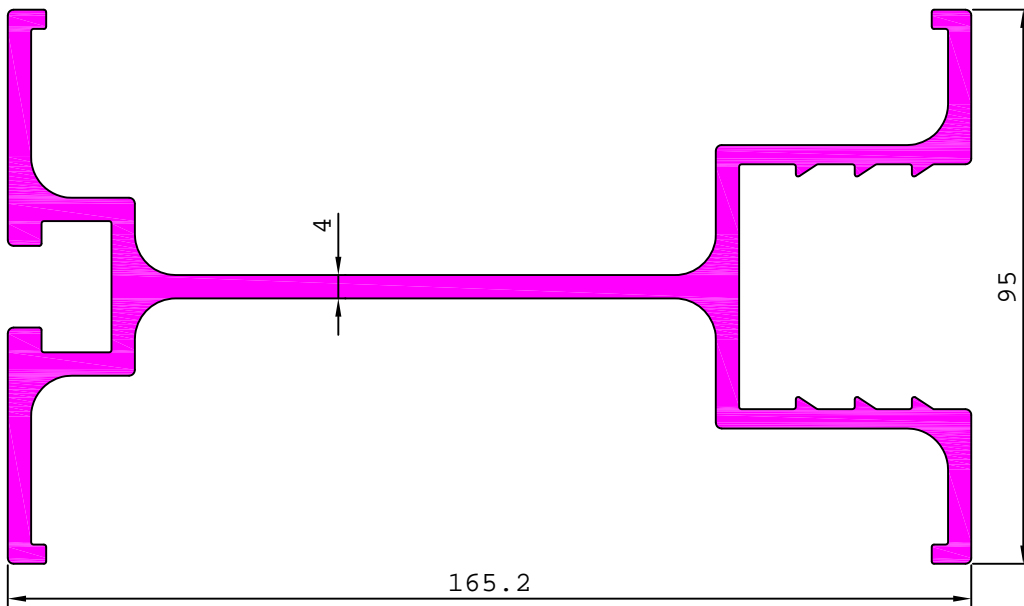

29077

3.056 kg/m

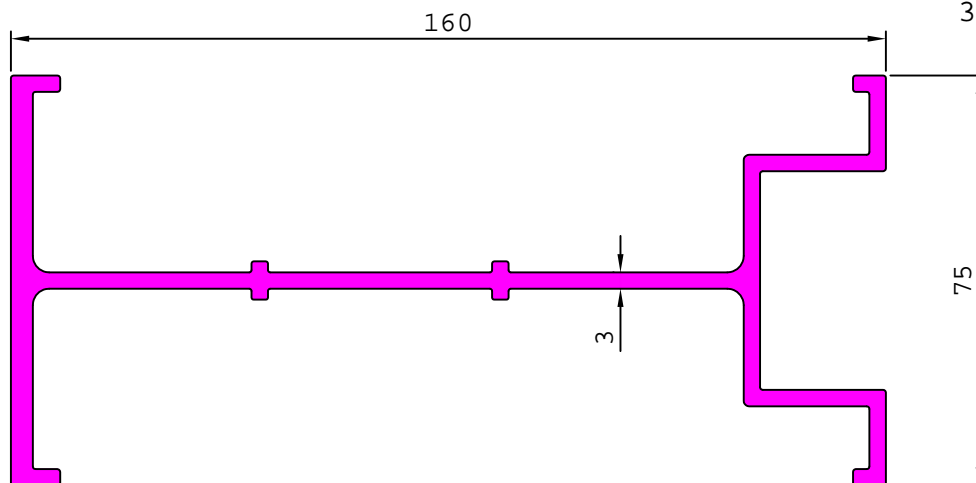

INDUSTRIAL

MISCELLANEOUS

29052

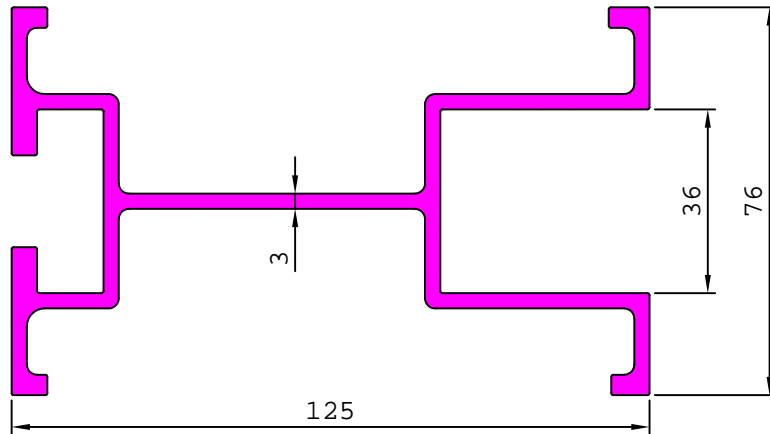

3.137 kg/m

29021

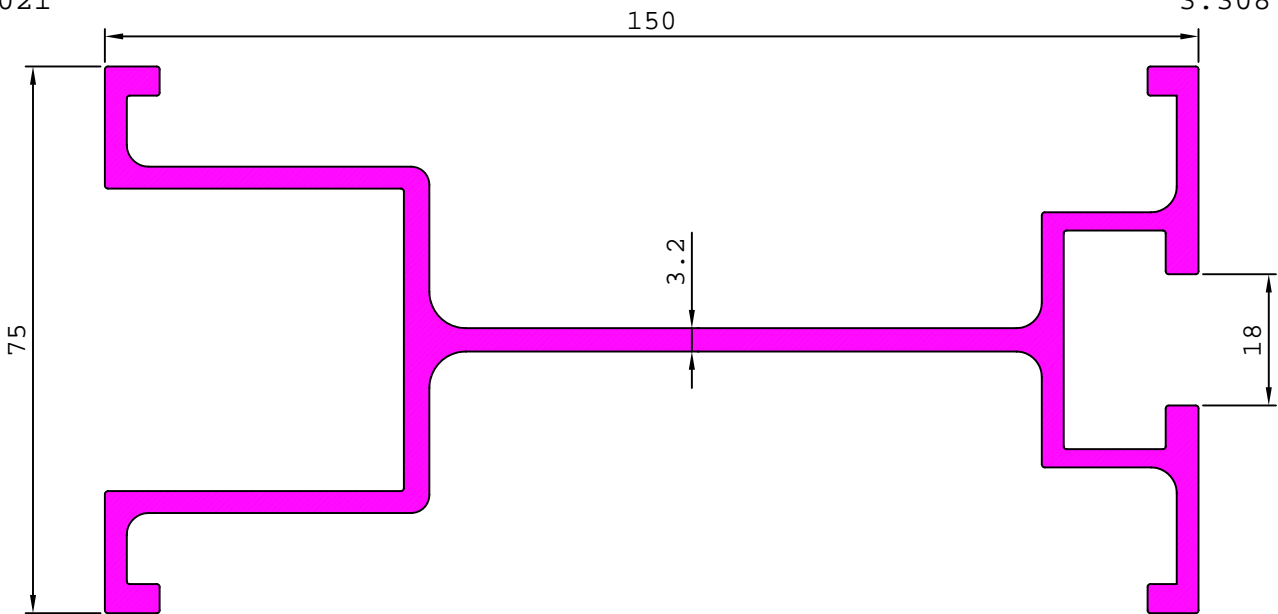

3.308 kg/m

29348

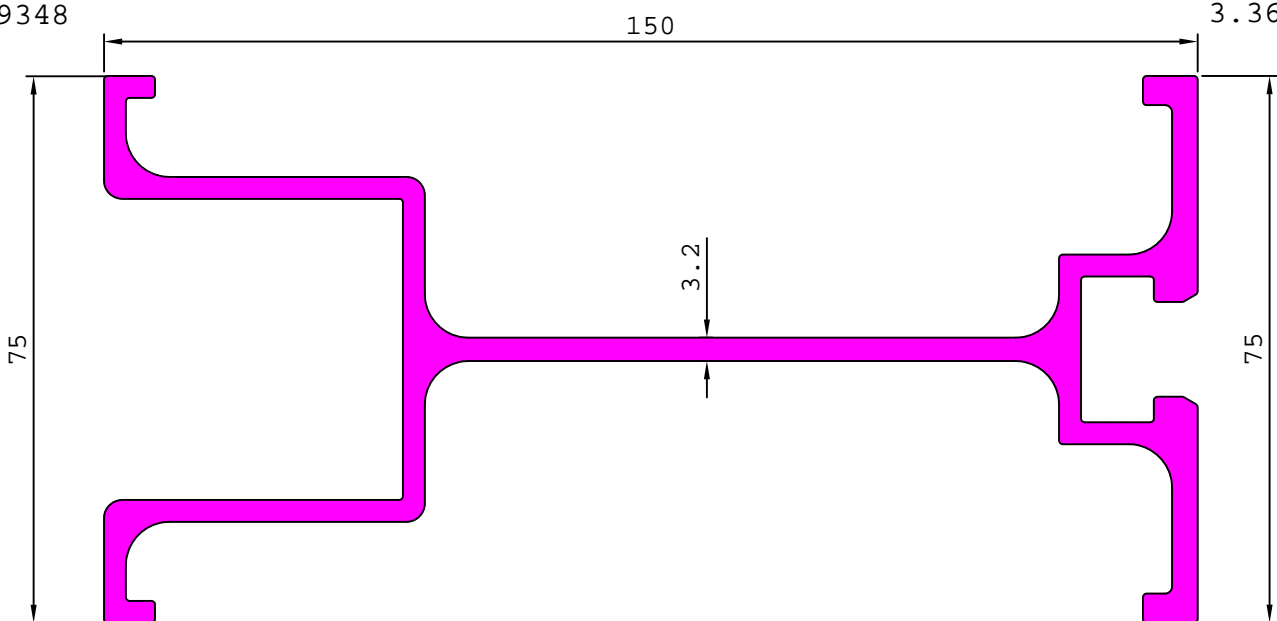

3.367 kg/m

INDUSTRIAL

MISCELLANEOUS

29542

2.916 kg/m

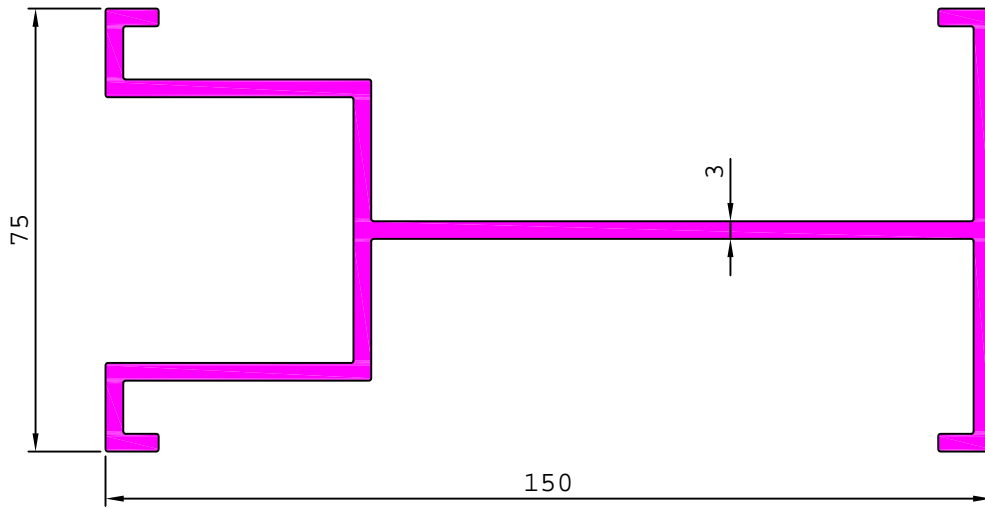

29291

6.167 kg/m

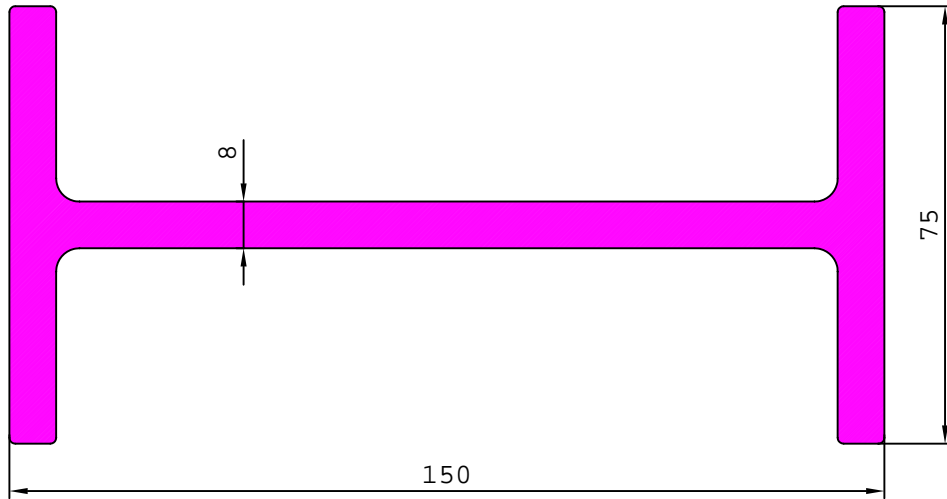

27954

7.942 kg/m

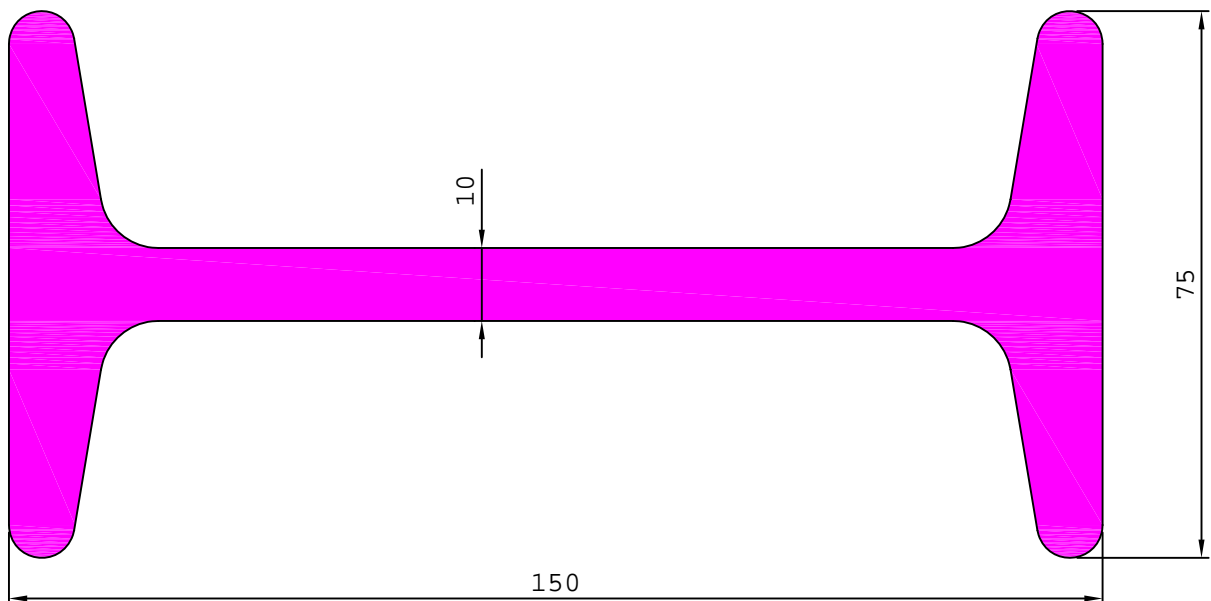

INDUSTRIAL

MISCELLANEOUS

28937

6.710 kg/m

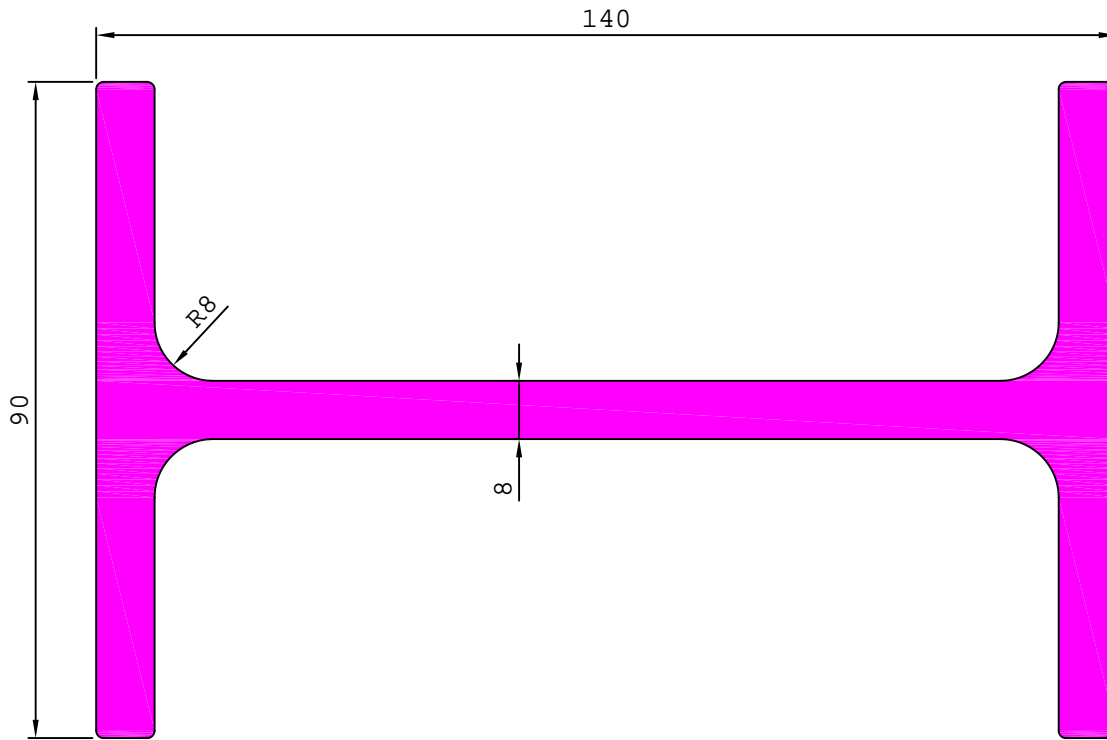

INDUSTRIAL

MISCELLANEOUS

27489

2.503 kg/m

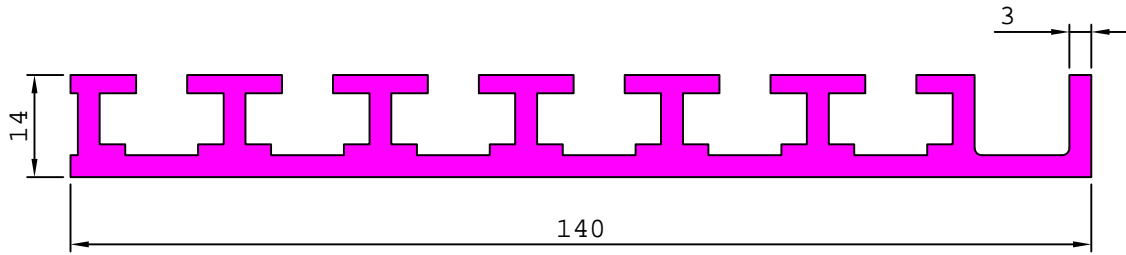

27503

3.316 kg/m

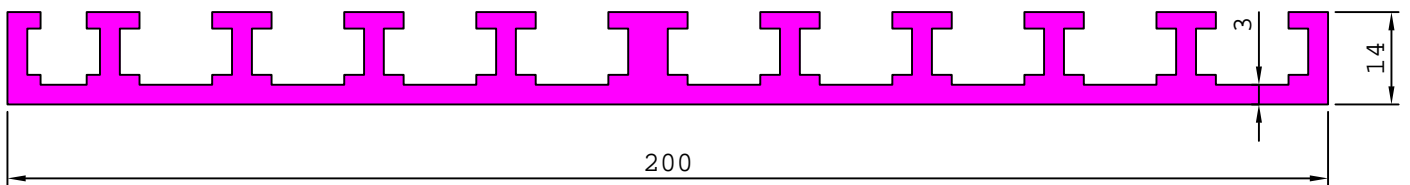

27504

2.153 kg/m

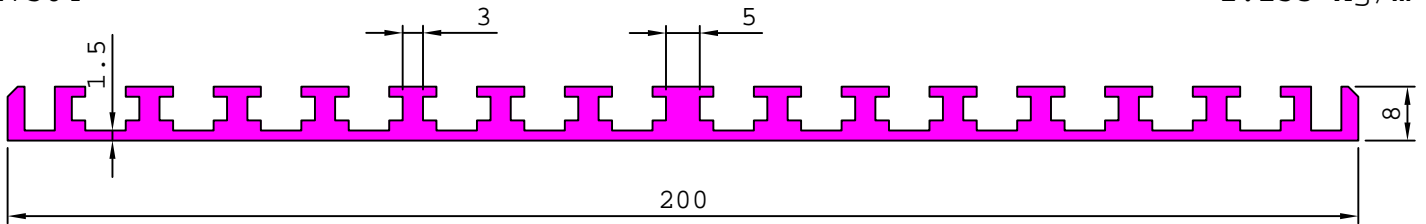

INDUSTRIAL

MISCELLANEOUS

27499

6.963 kg/m

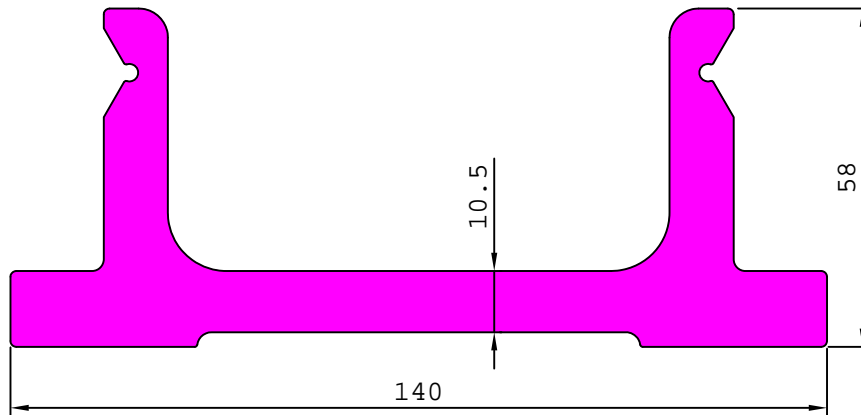

27530

2.440 kg/m

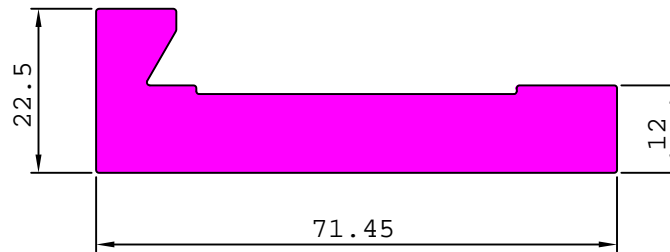

27571

20.082 kg/m

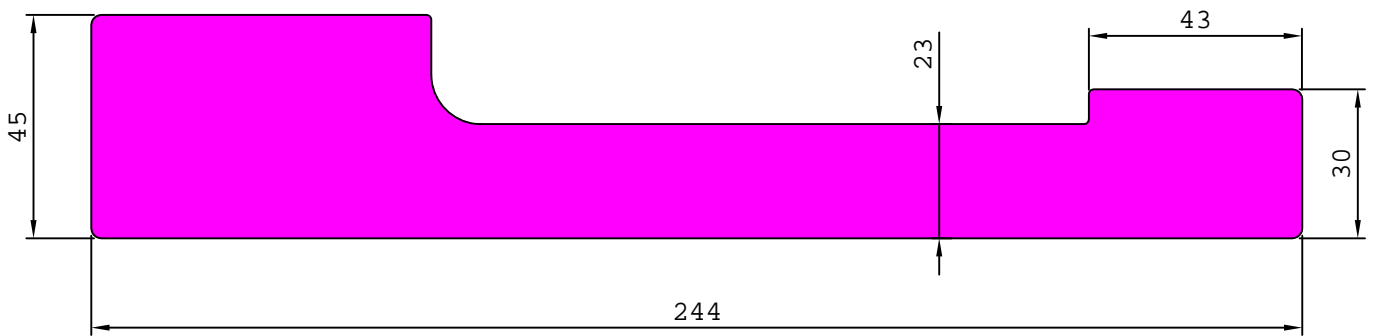

27698

12.061 kg/m

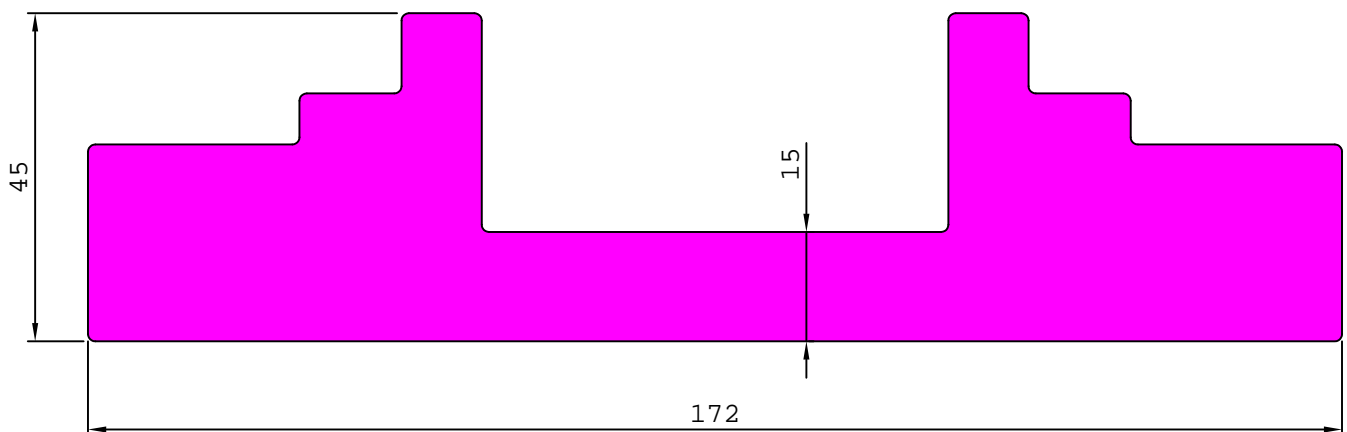

INDUSTRIAL

MISCELLANEOUS

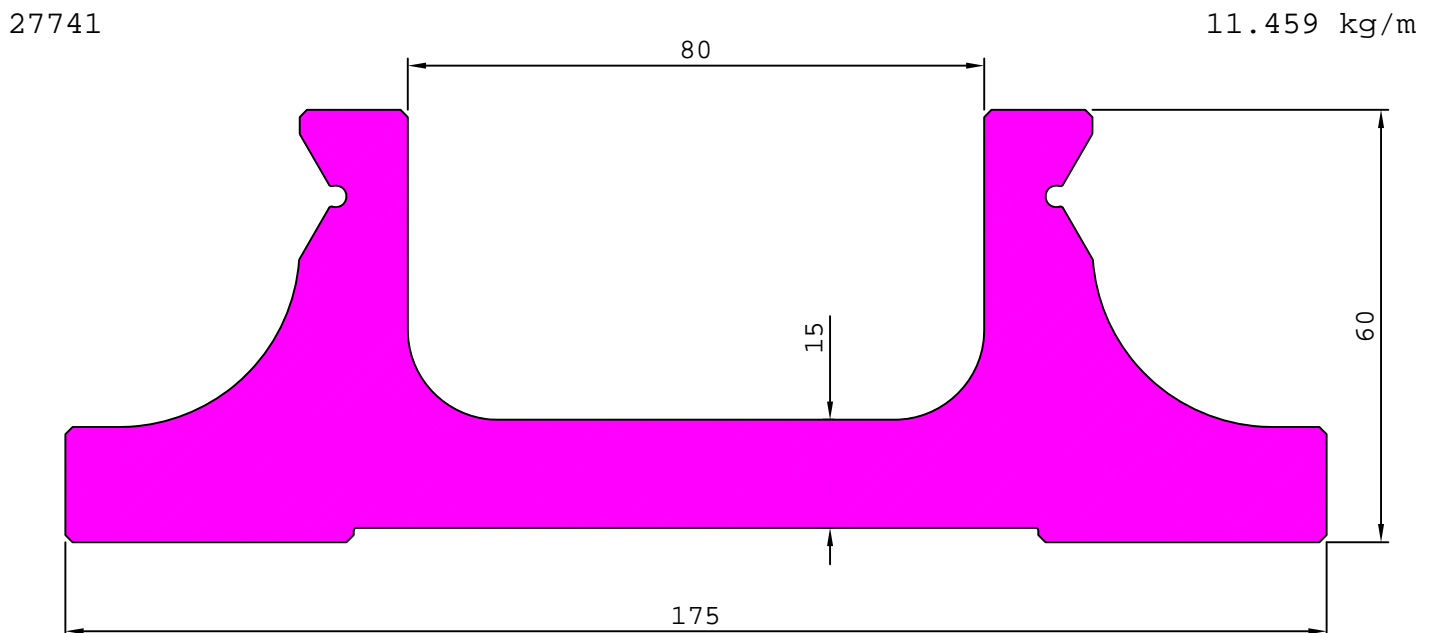
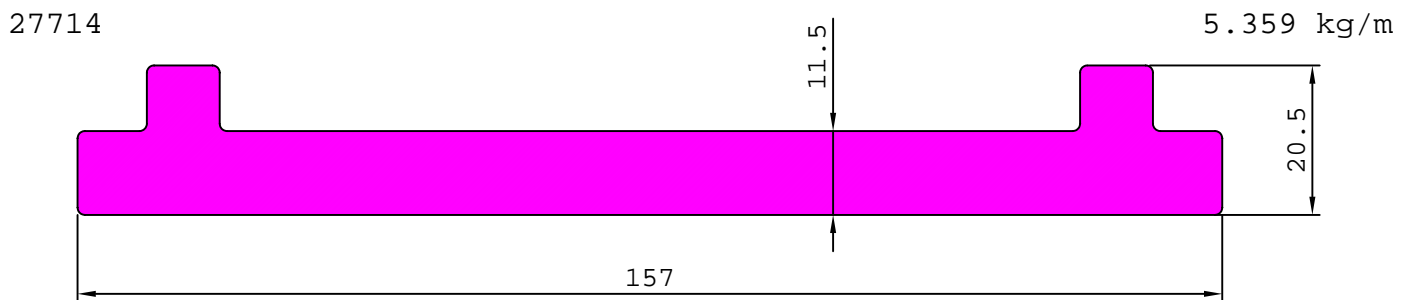
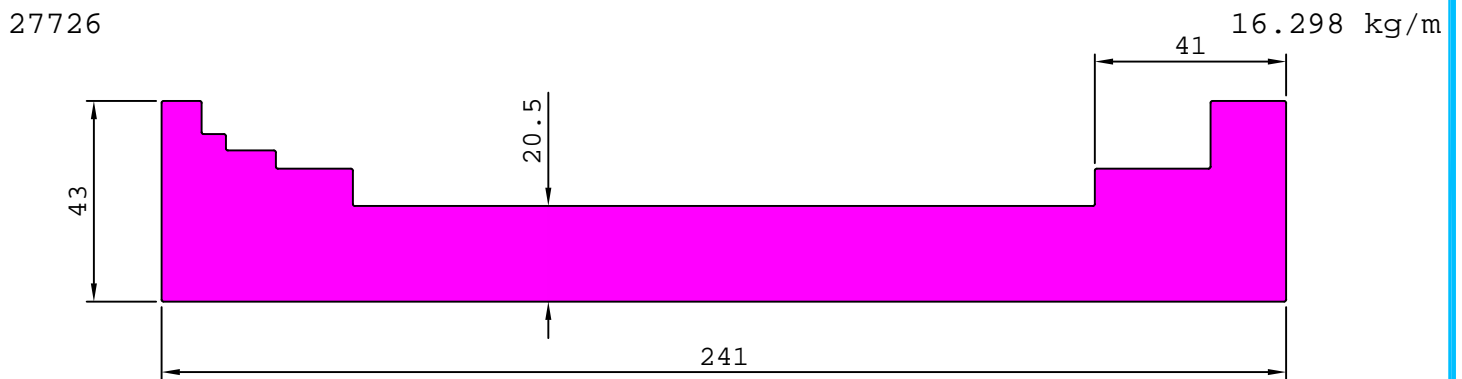
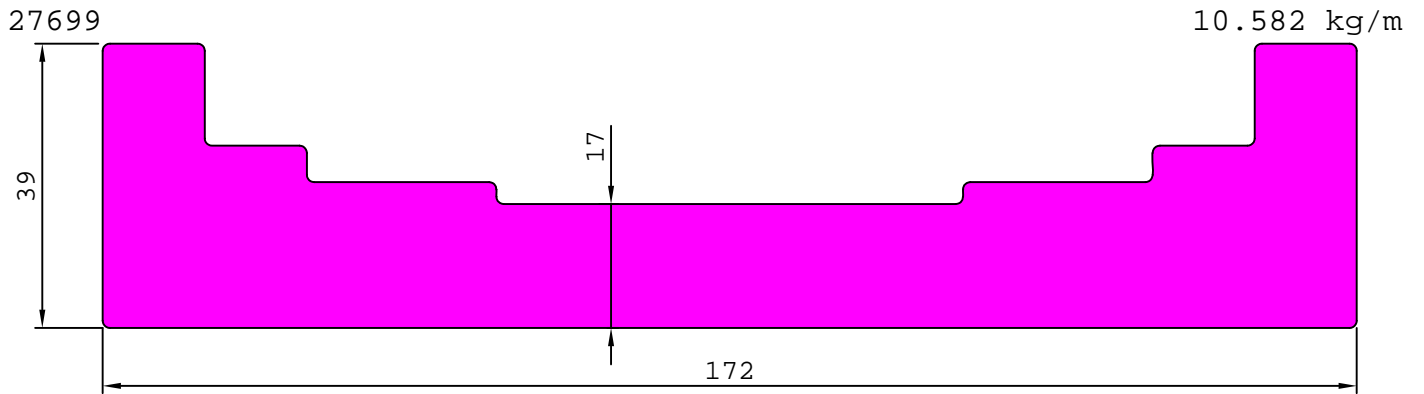

INDUSTRIAL

MISCELLANEOUS

27742

7.774 kg/m

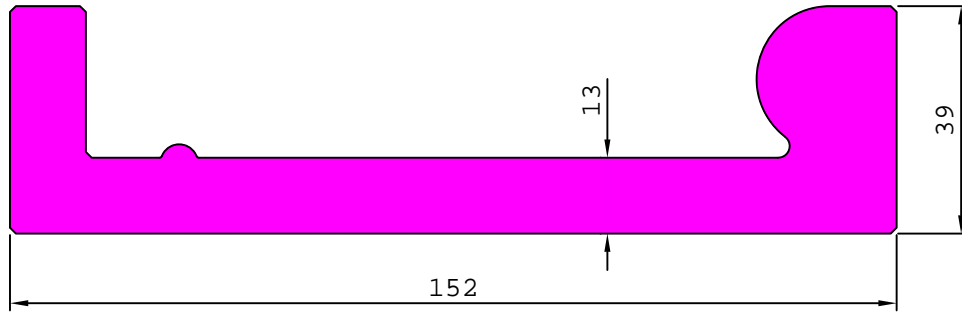

27796

11.156 kg/m

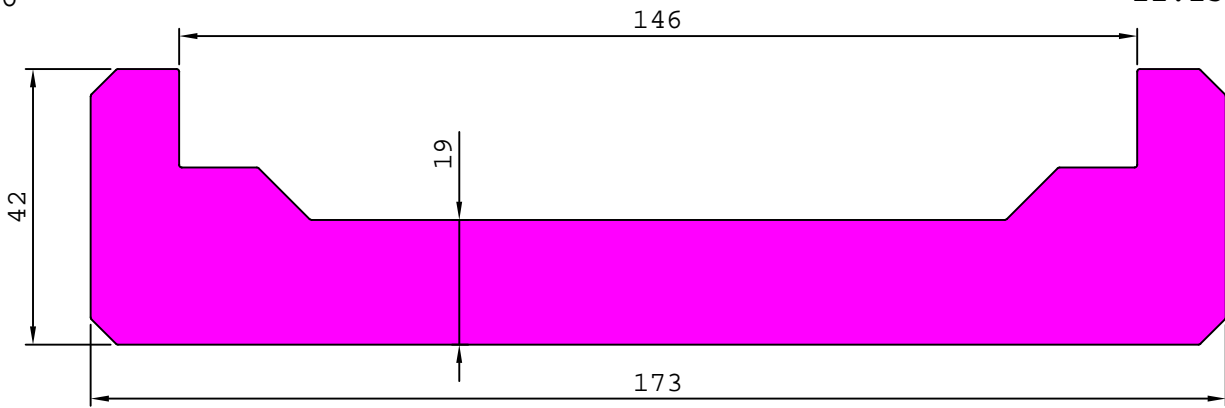

27797

11.380 kg/m

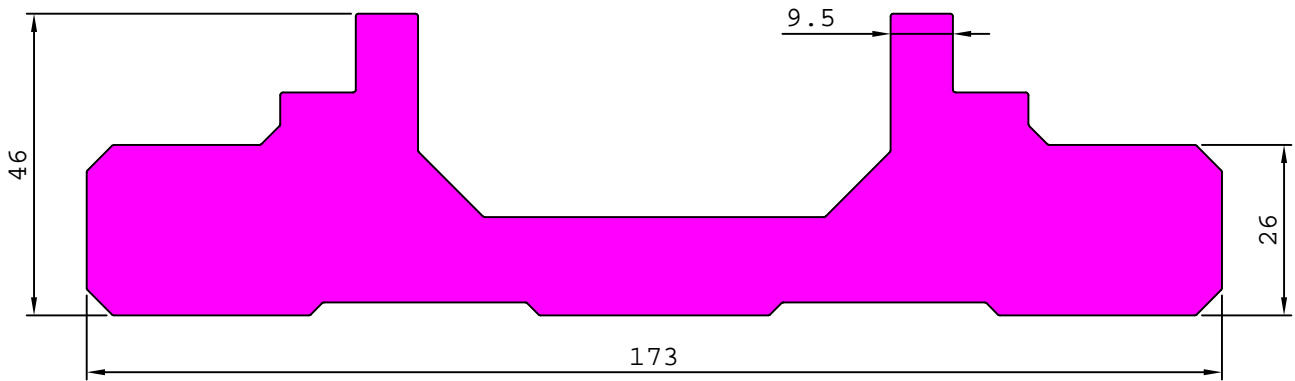

27801

14.902 kg/m

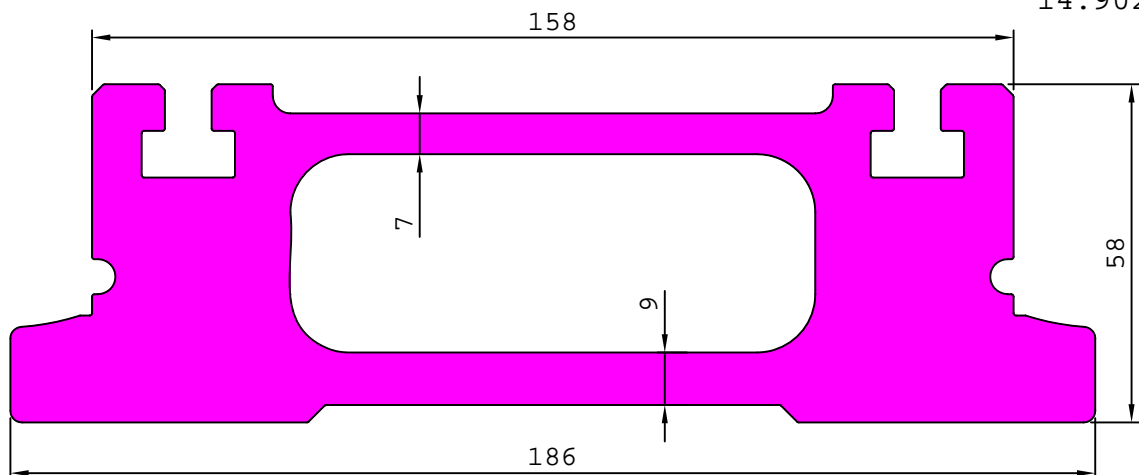

INDUSTRIAL

MISCELLANEOUS

27810

118.5

15.036 kg/m

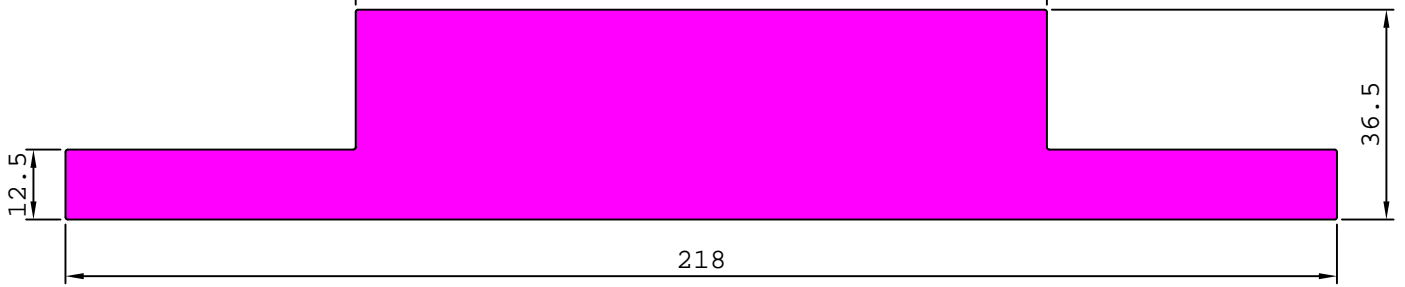

27871

17.054 kg/m

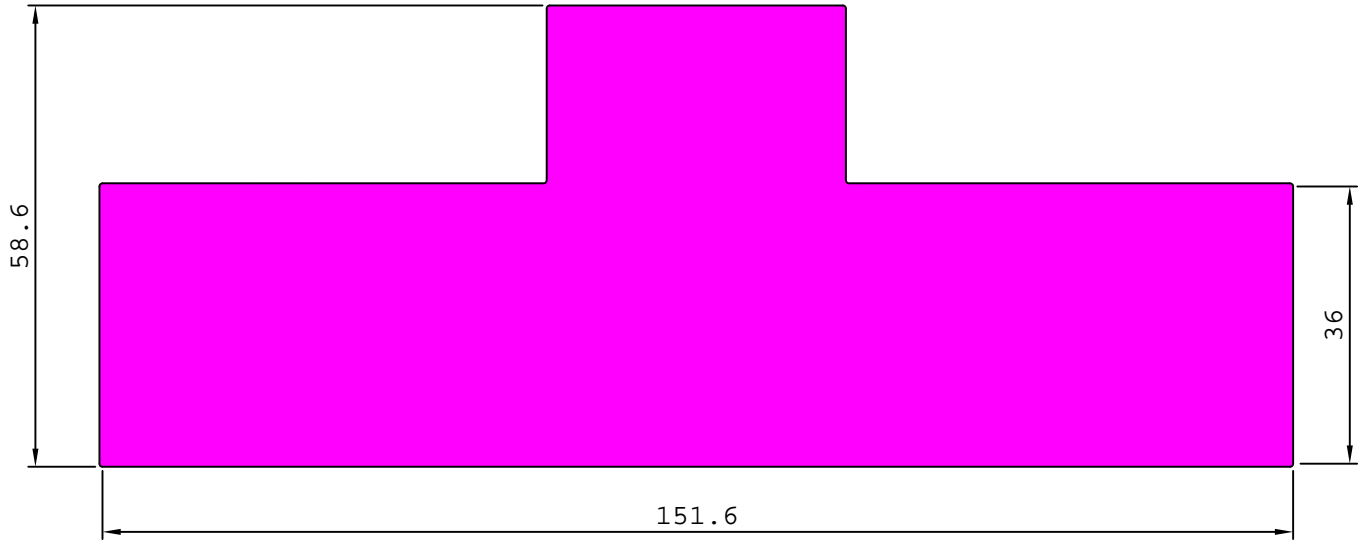

27911

51.122 kg/m

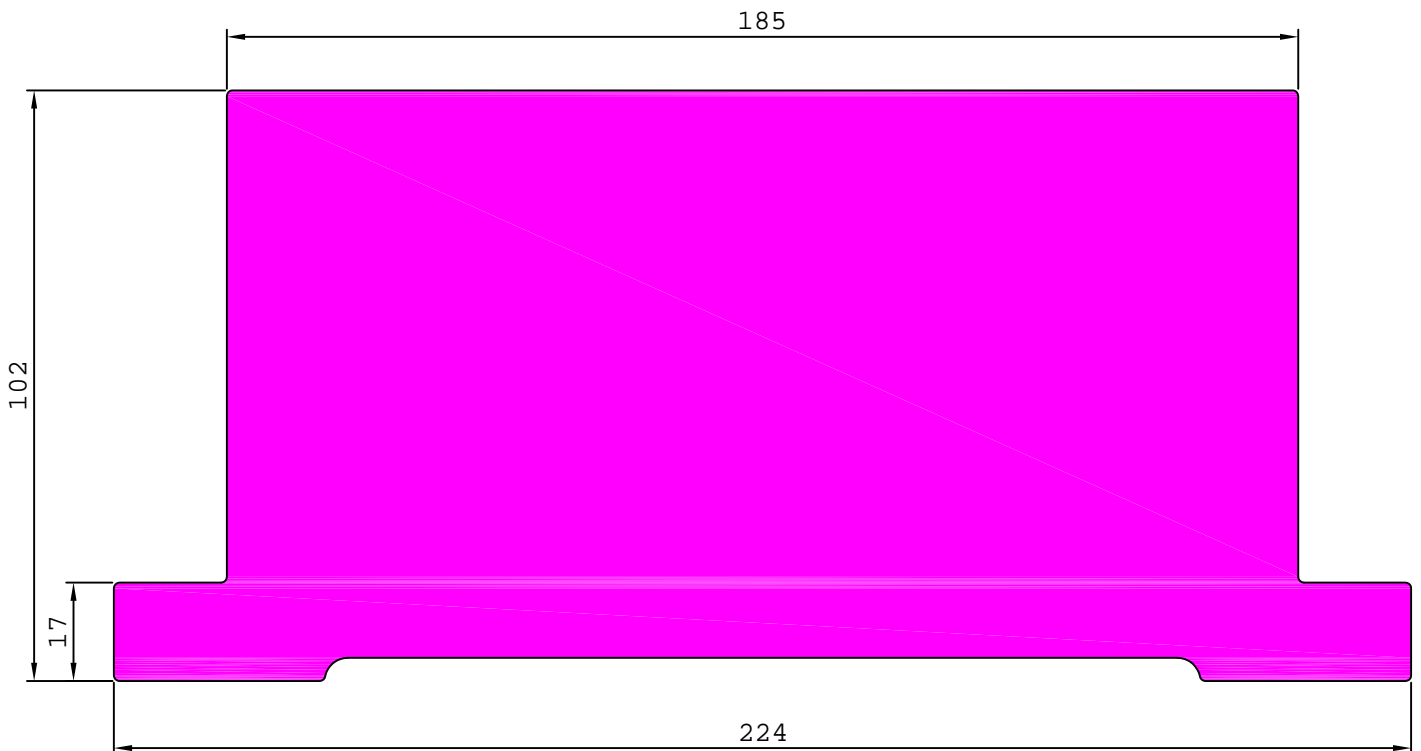

INDUSTRIAL

MISCELLANEOUS

28155

12.171 kg/m

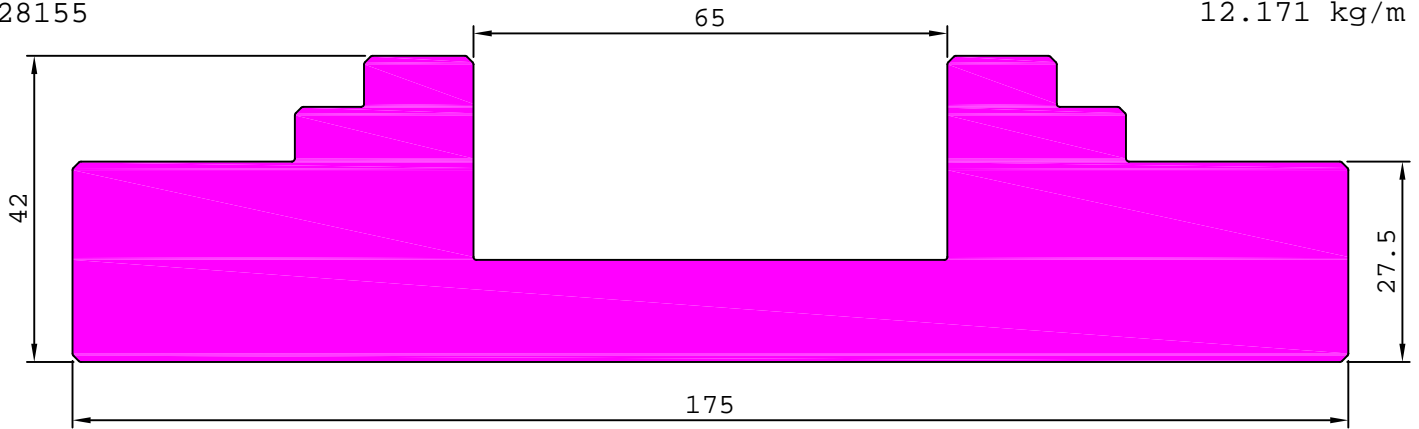

28166

9.896 kg/m

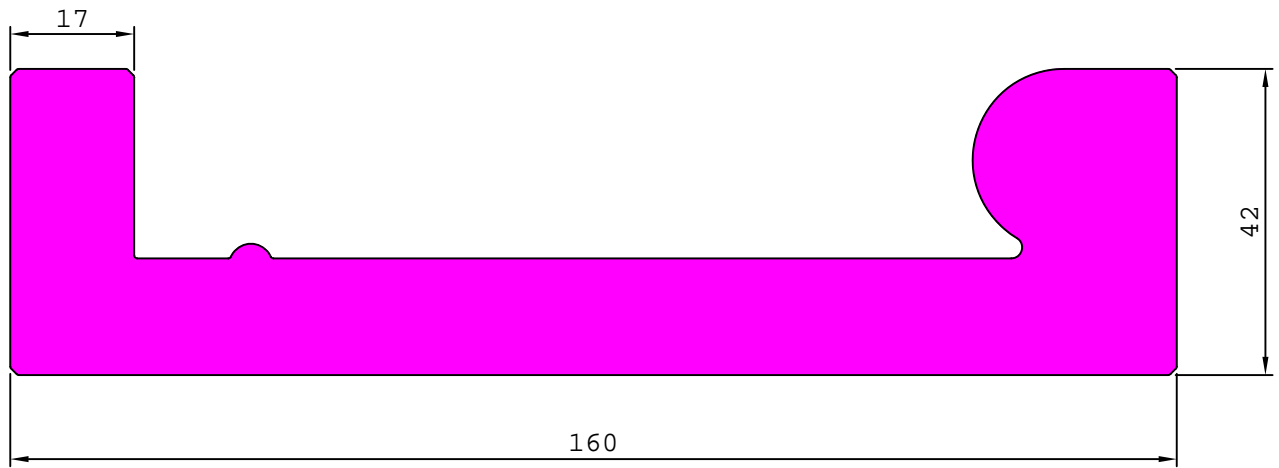

28168

11.301 kg/m

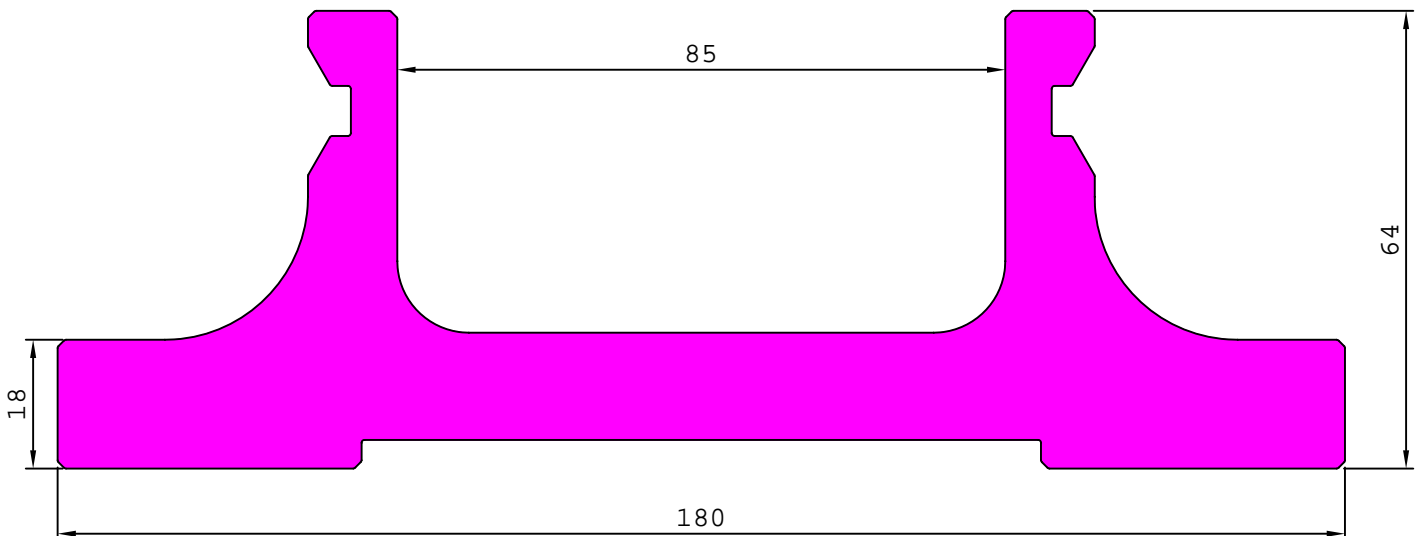

INDUSTRIAL

MISCELLANEOUS

28167

12.518 kg/m

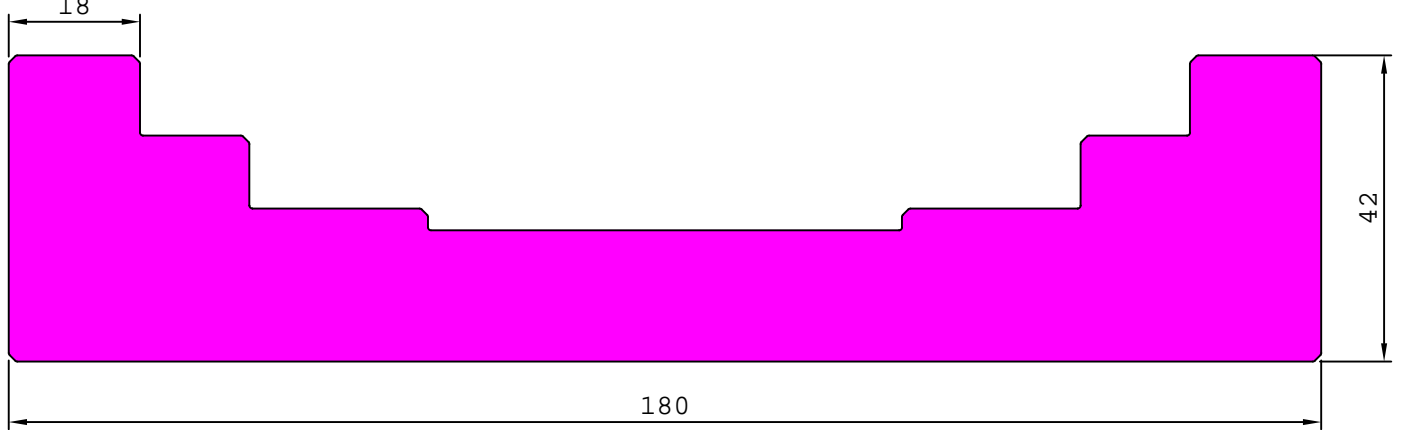

S3865

20.875 kg/m

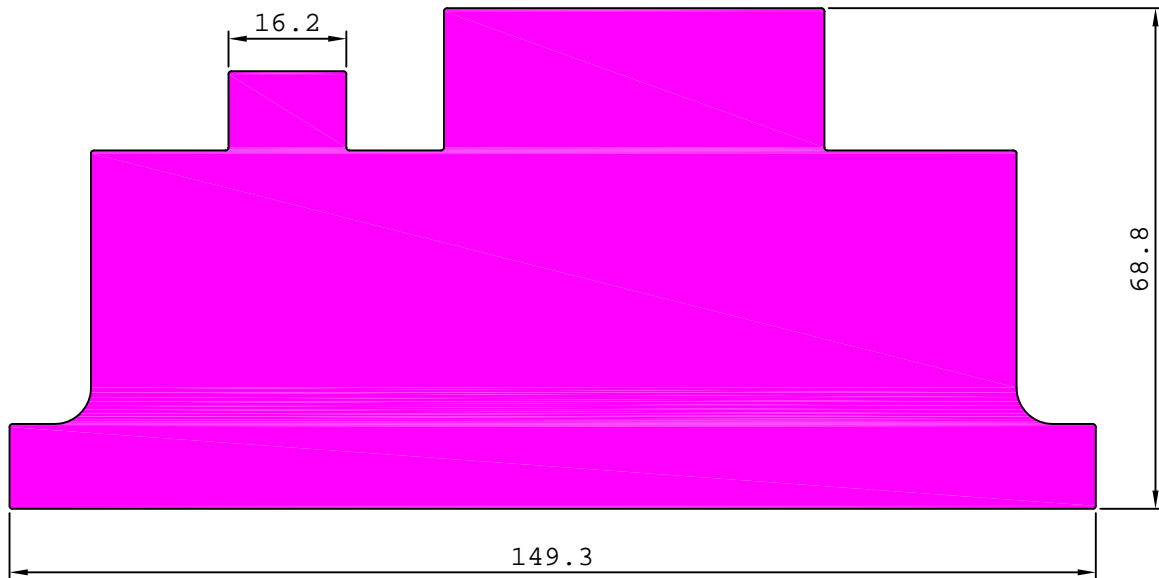

S4308

14.681 kg/m

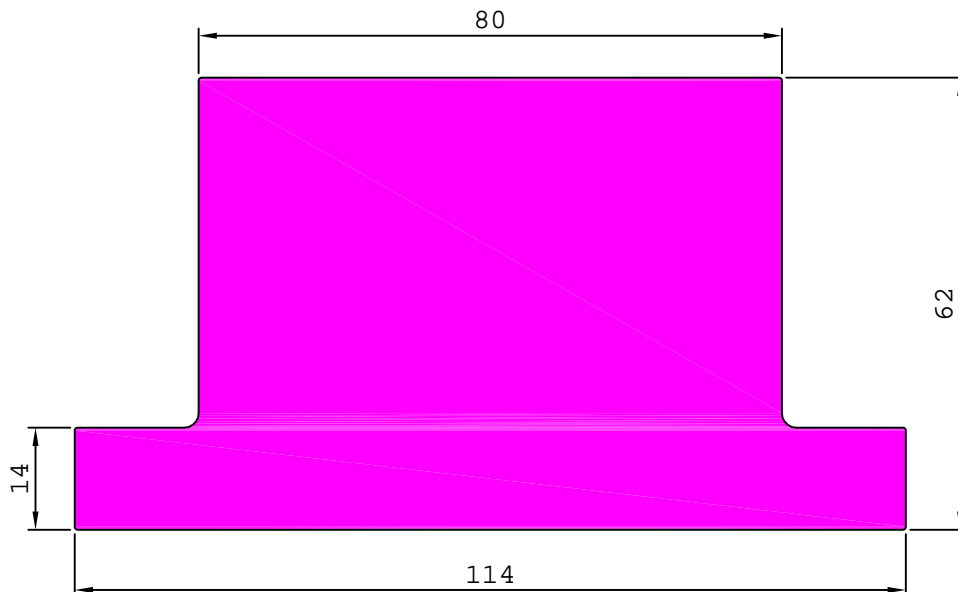

INDUSTRIAL

MISCELLANEOUS

S4465

11.244 kg/m

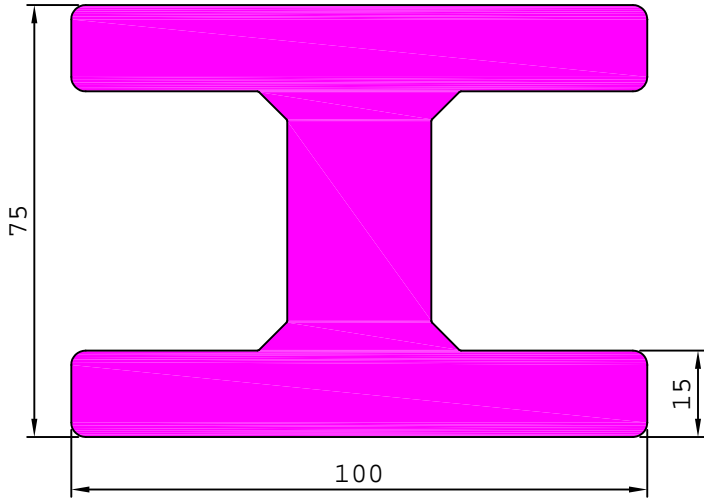

S4765

7.592 kg/m

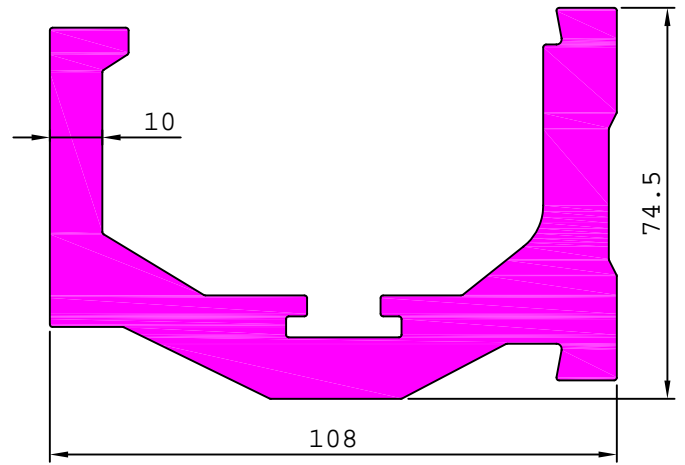

S4552

12.062 kg/m

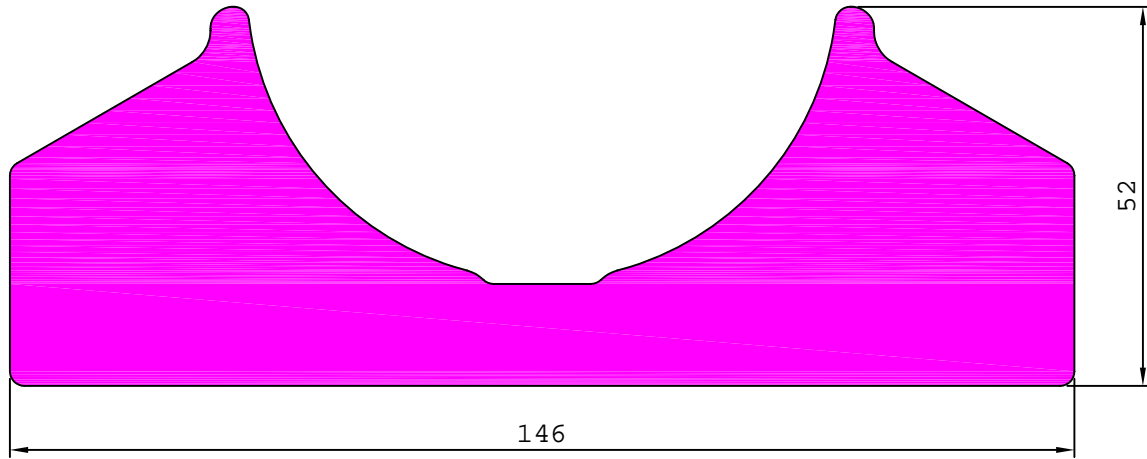

S4886

11.900 kg/m

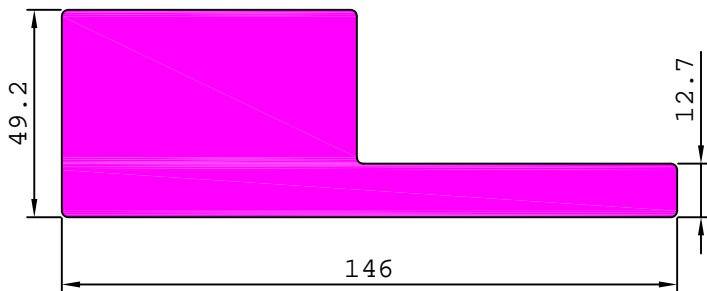

INDUSTRIAL

MISCELLANEOUS

27652 1.550 kg/m

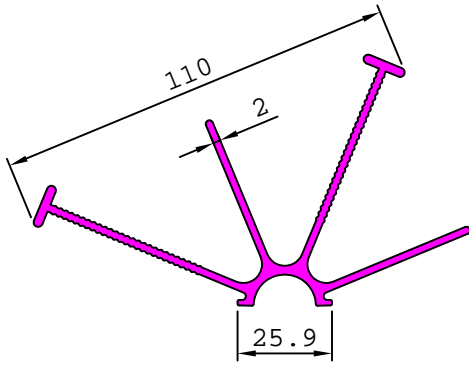

27830 4.246 kg/m

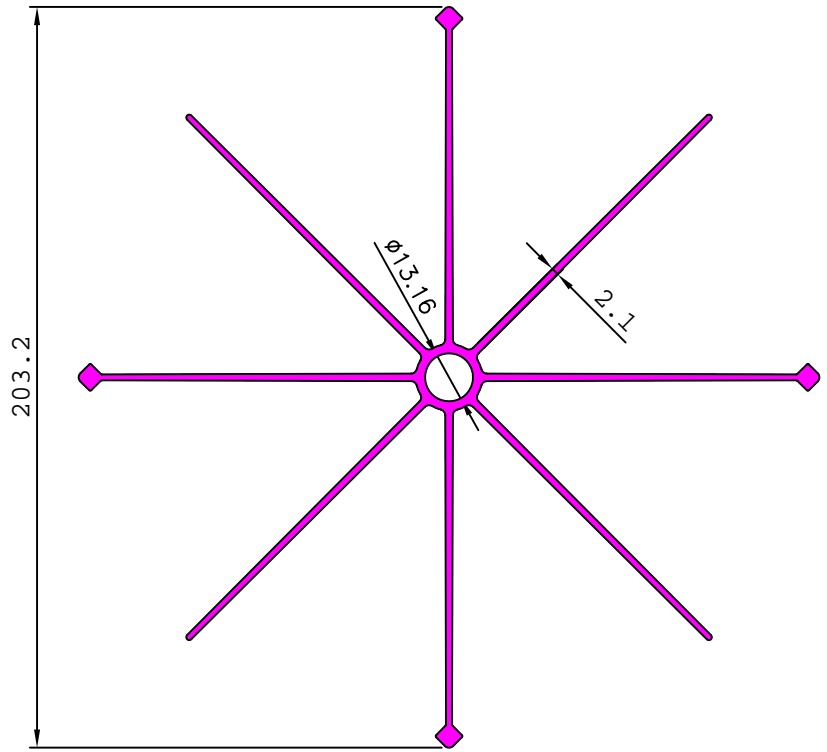

29119 0.587 kg/m

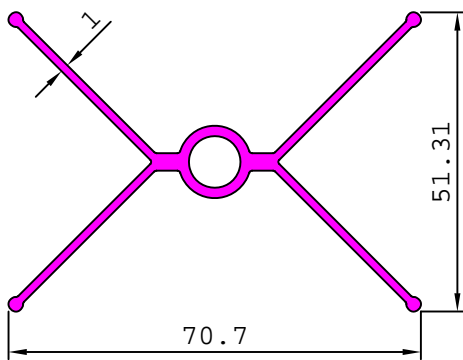

INDUSTRIAL

MISCELLANEOUS

27863

11.327 kg/m

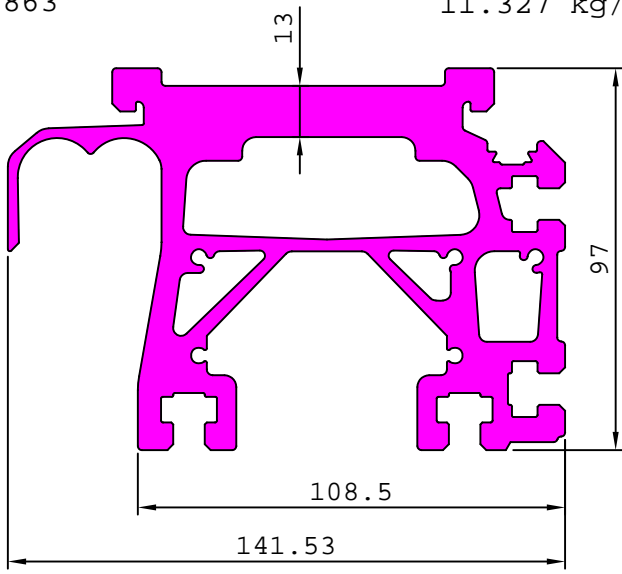

28108

8.000 kg/m

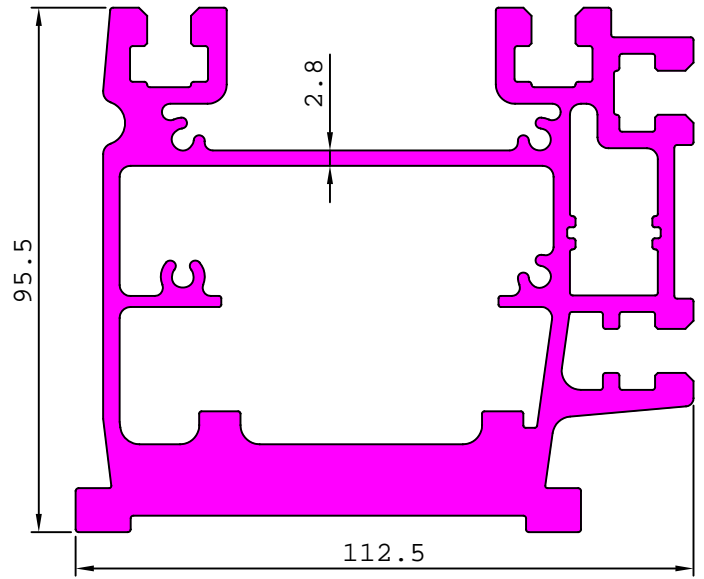

27930

2.620 kg/m

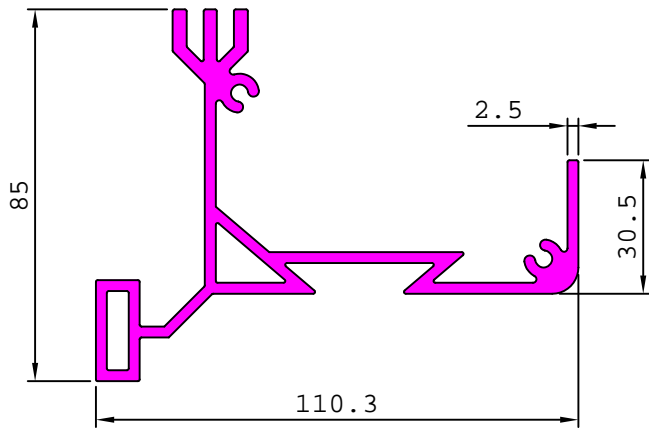

27931

1.914 kg/m

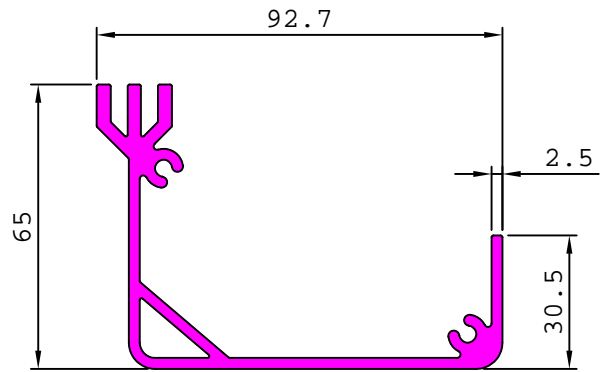

INDUSTRIAL

MISCELLANEOUS

28147

3.536 kg/m

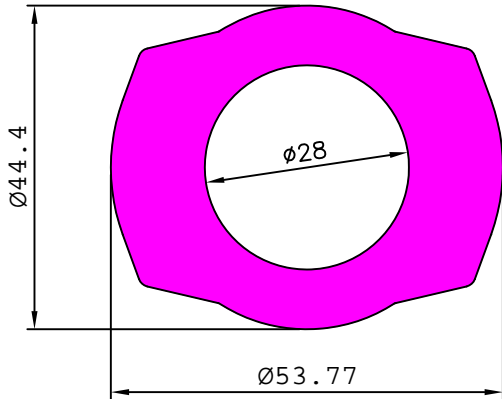

28152

3.407 kg/m

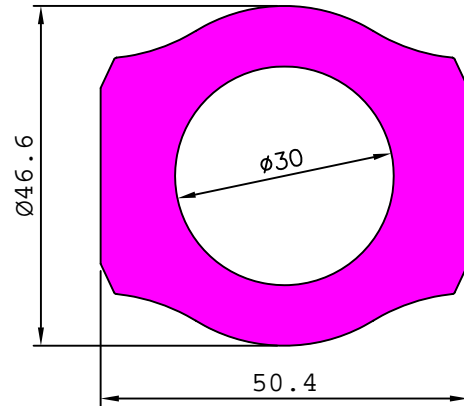

28221

2.933 kg/m

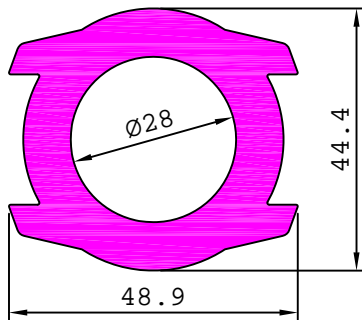

28222

4.074 kg/m

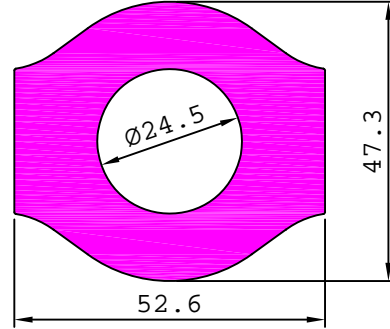

28220

3.072 kg/m

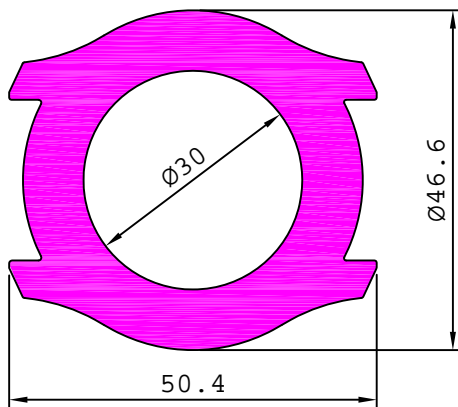

INDUSTRIAL

CHUTE SECTIONS

27712

7.221 kg/m

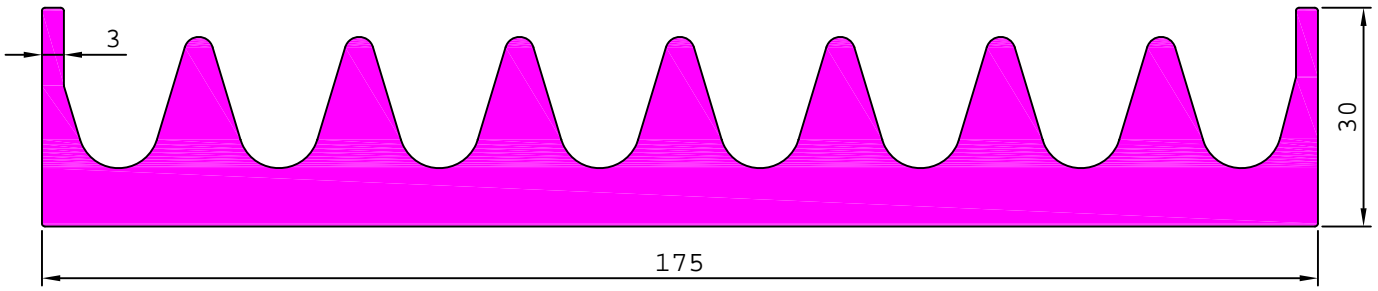

27729

3.382 kg/m

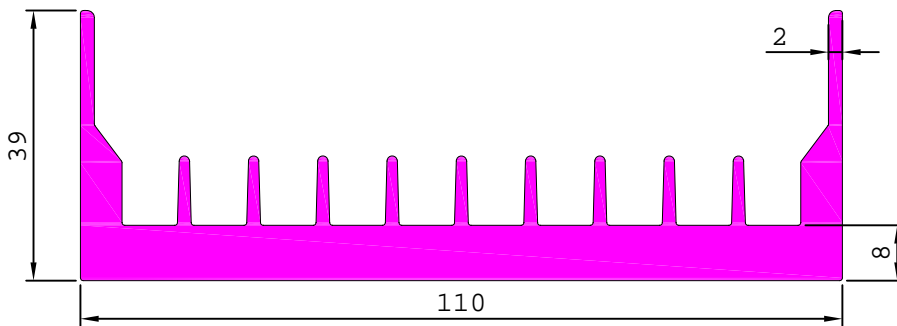

27883

5.113 kg/m

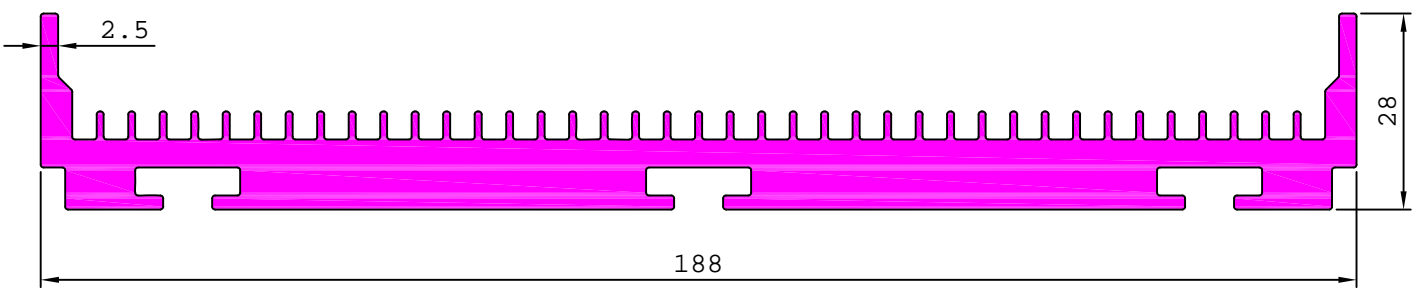

27923

3.903 kg/m

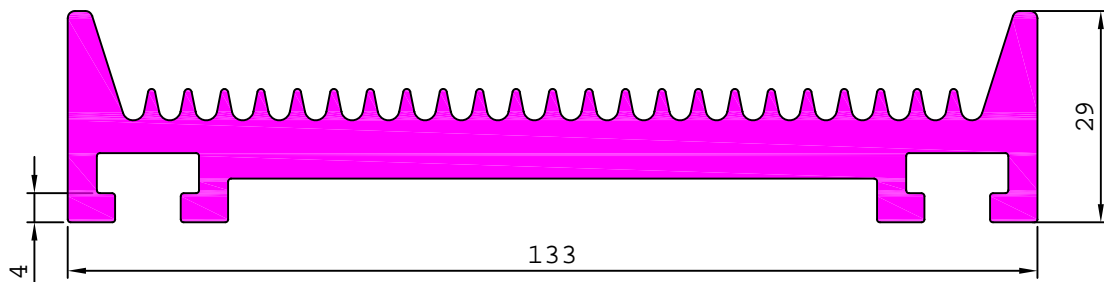

28014

6.378 kg/m

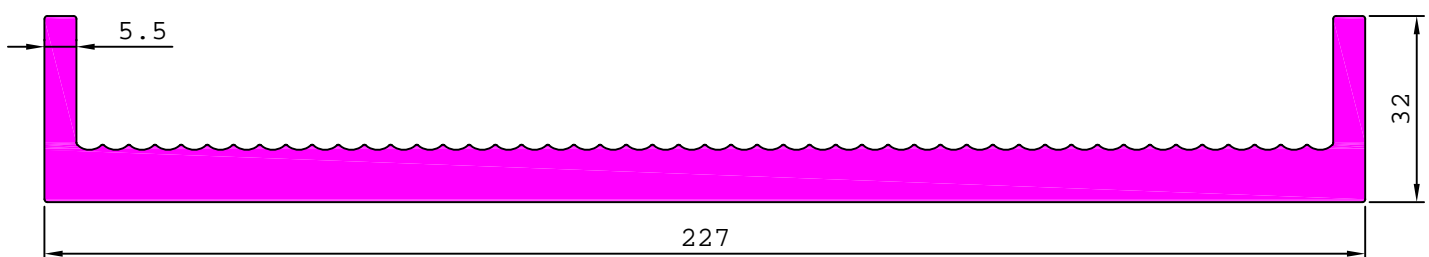

INDUSTRIAL

CHUTE SECTIONS

27951

11.499 kg/m

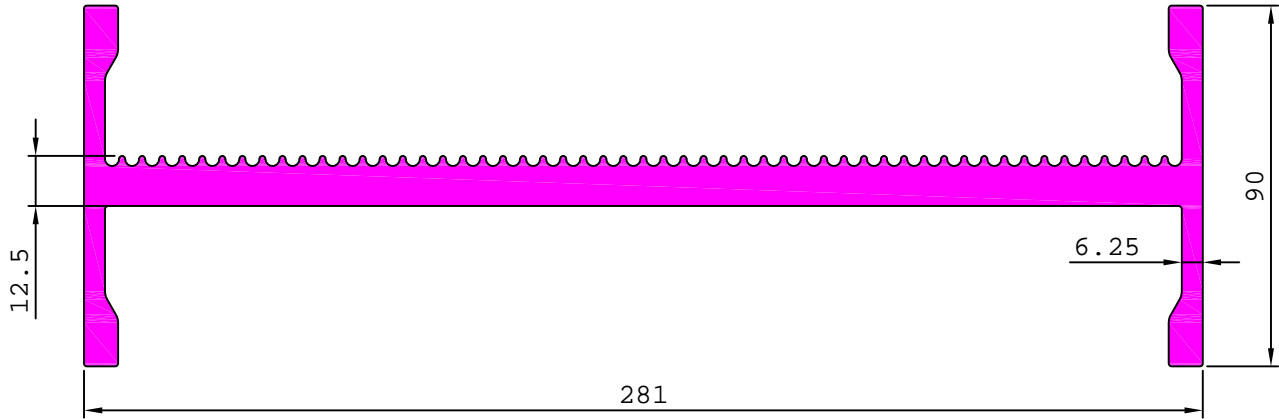

27969

9.254 kg/m

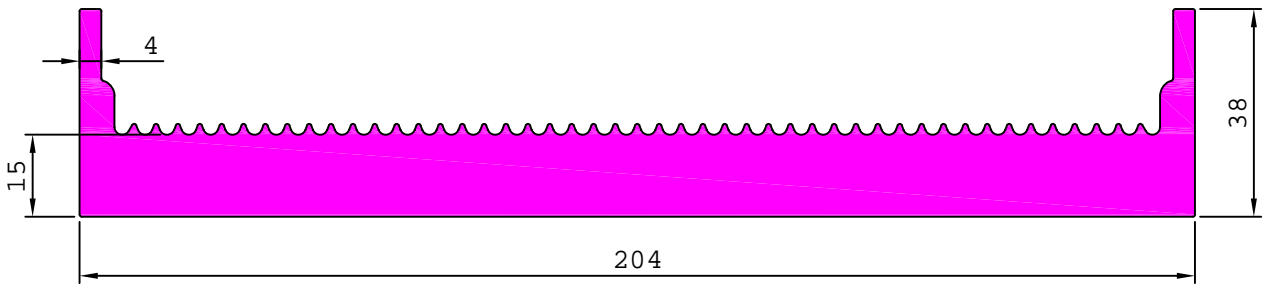

28042

3.586 kg/m

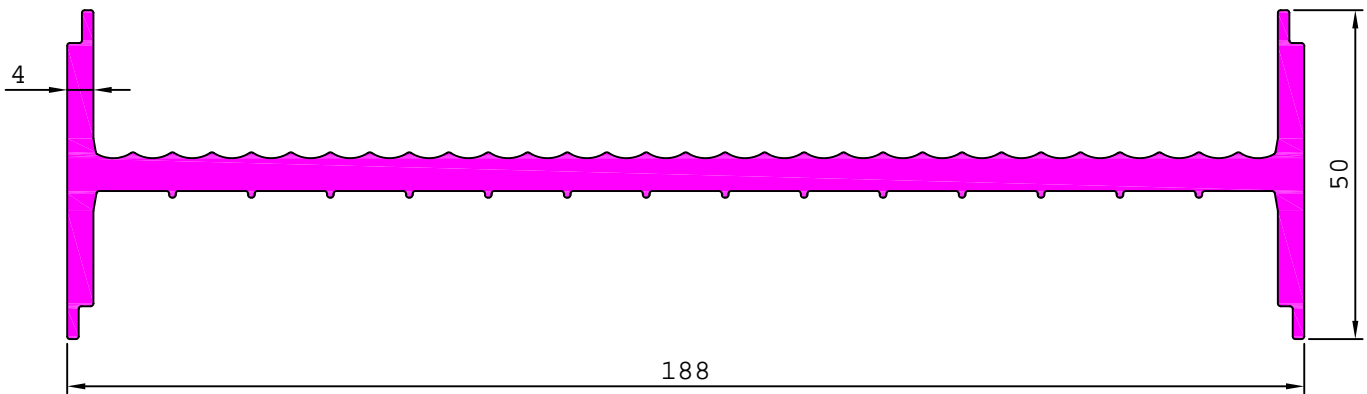

28067

8.304 kg/m

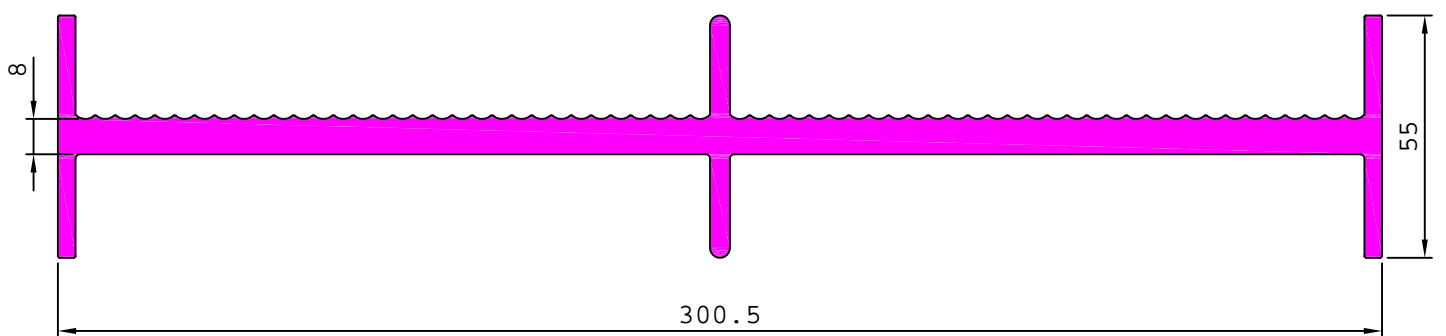

INDUSTRIAL

CHUTE SECTIONS

28071

6.288 kg/m

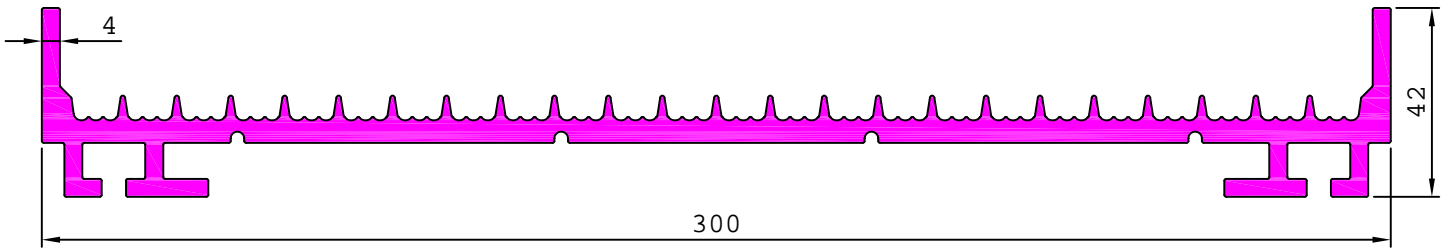

28087

5.246 kg/m

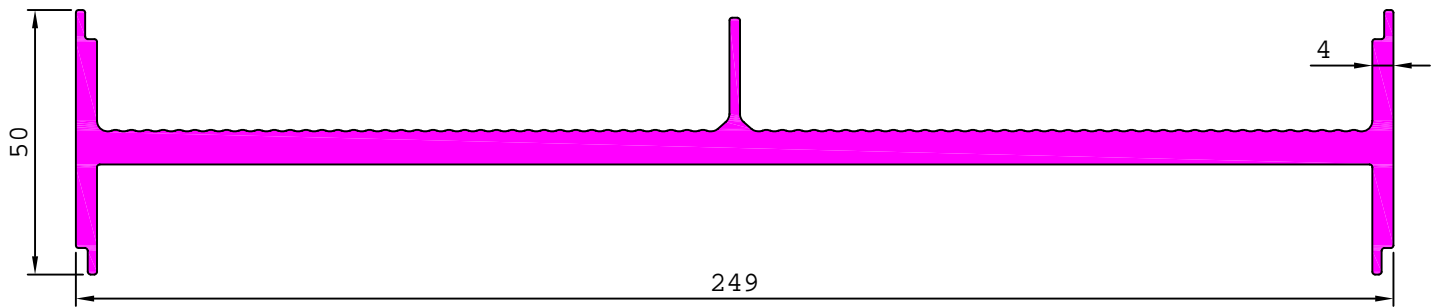

28102

3.451 kg/m

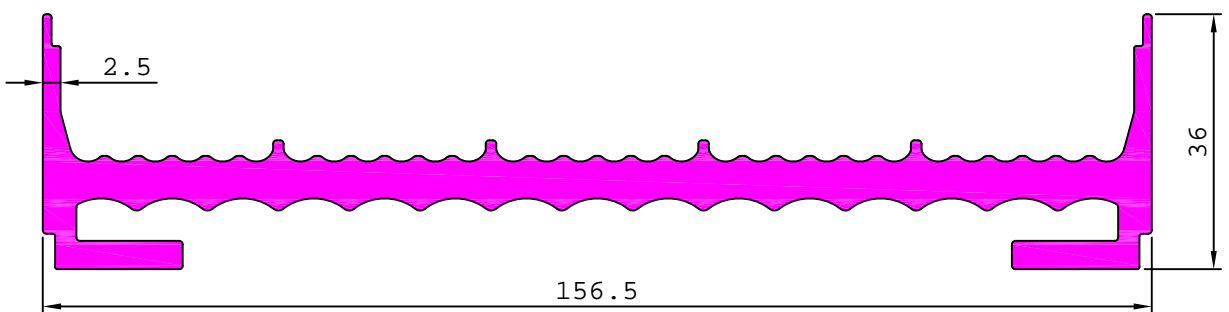

28104

3.869 kg/m

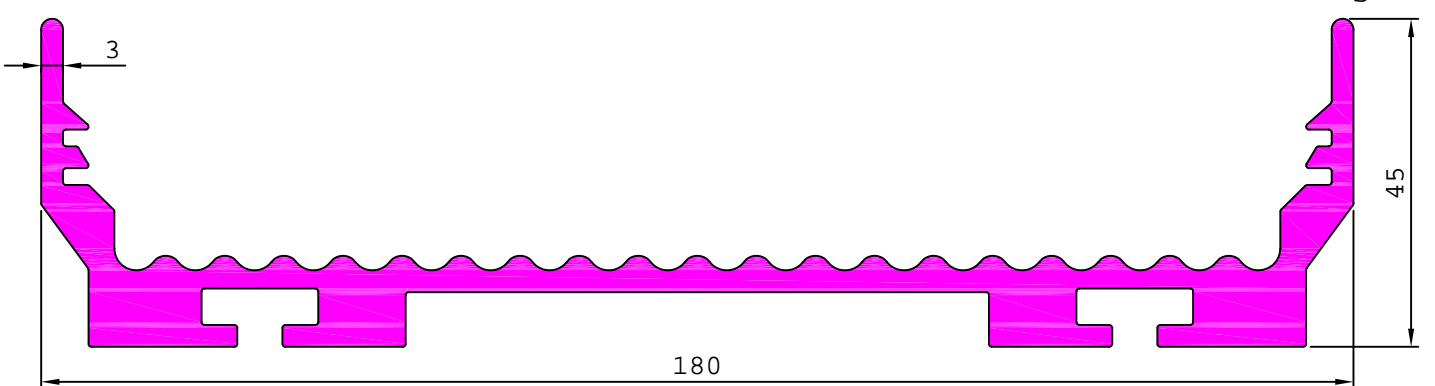

28041

3.756 kg/m

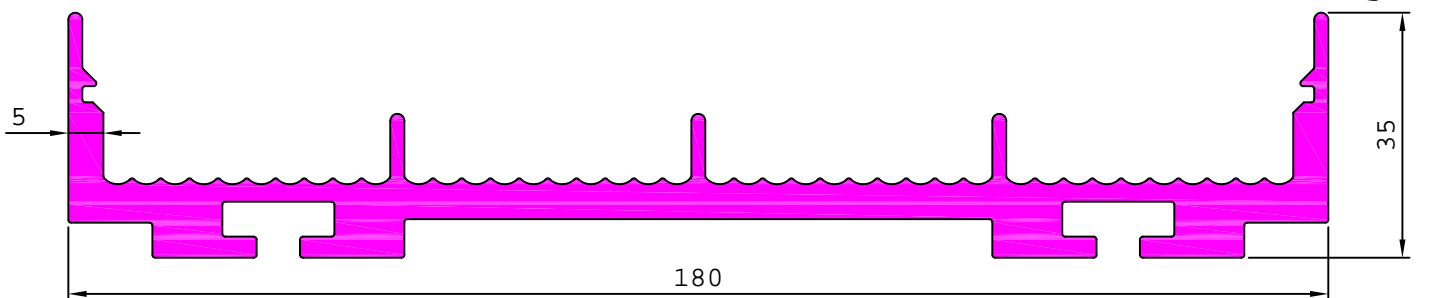

INDUSTRIAL

CHUTE SECTIONS

28105

3.997 kg/m

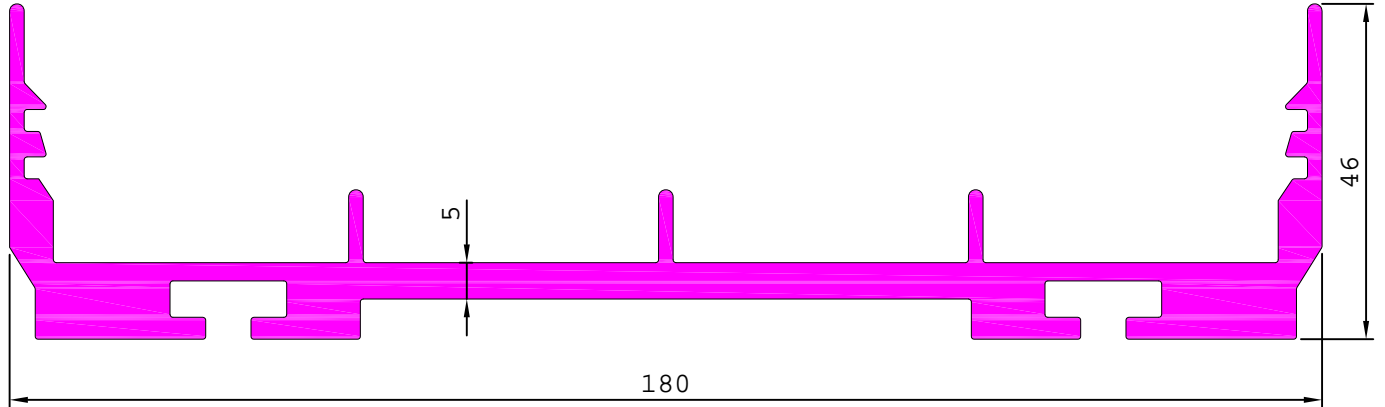

28106

4.932 kg/m

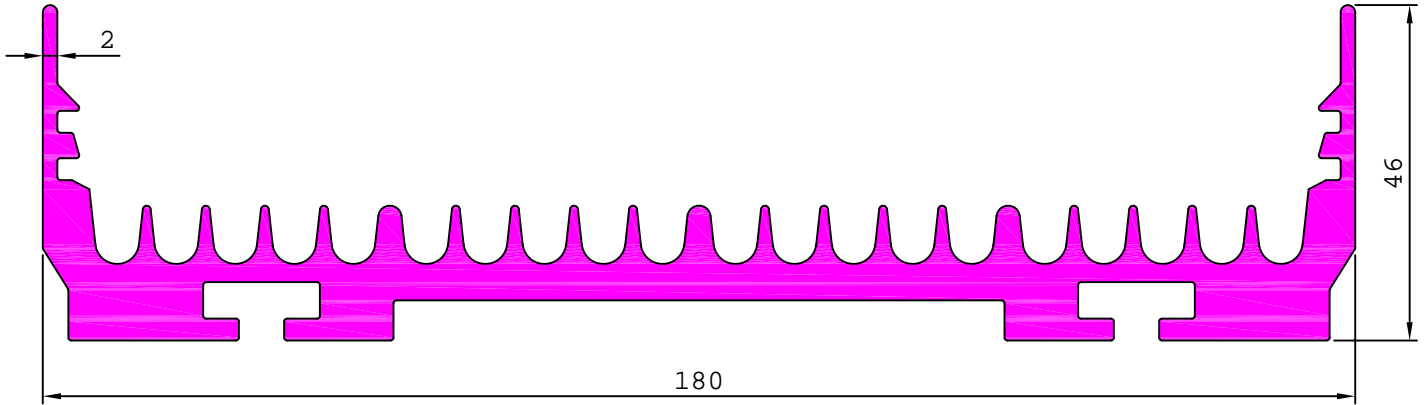

28107

5.082 kg/m

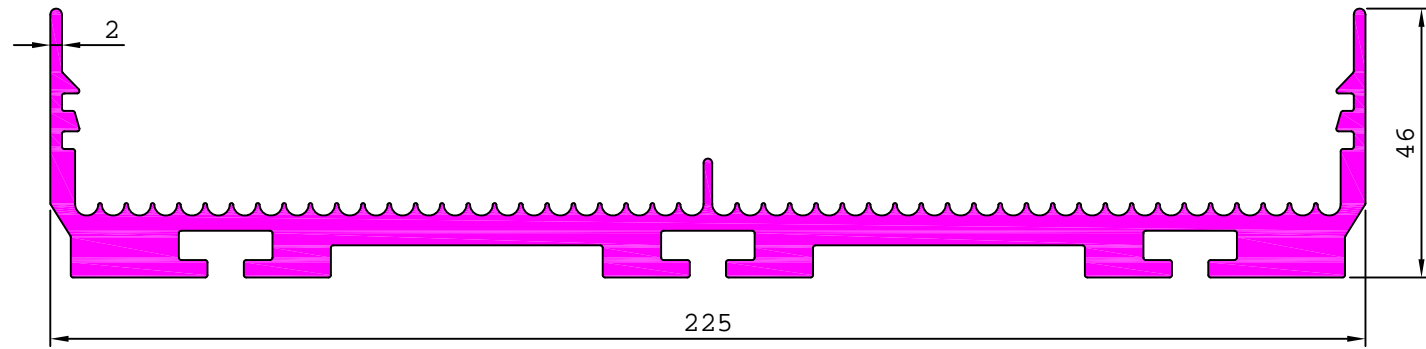

28103

5.350 kg/m

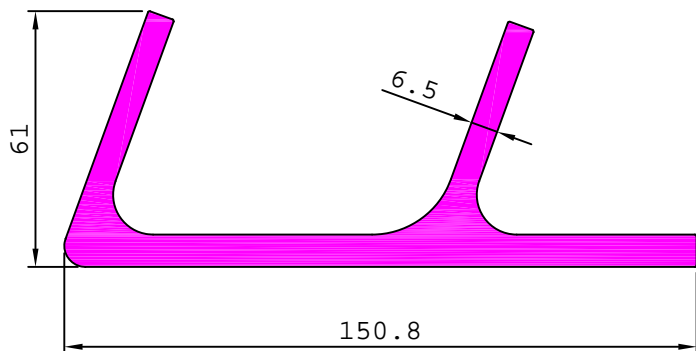

28182

3.204 kg/m

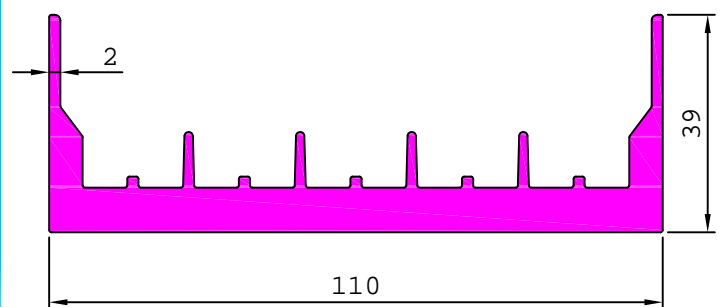

INDUSTRIAL

CHUTE SECTIONS

28247

5.764 kg/m

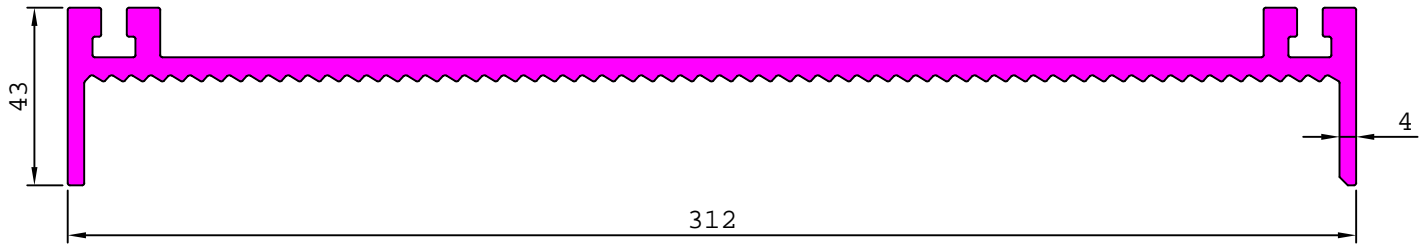

28162

5.108 kg/m

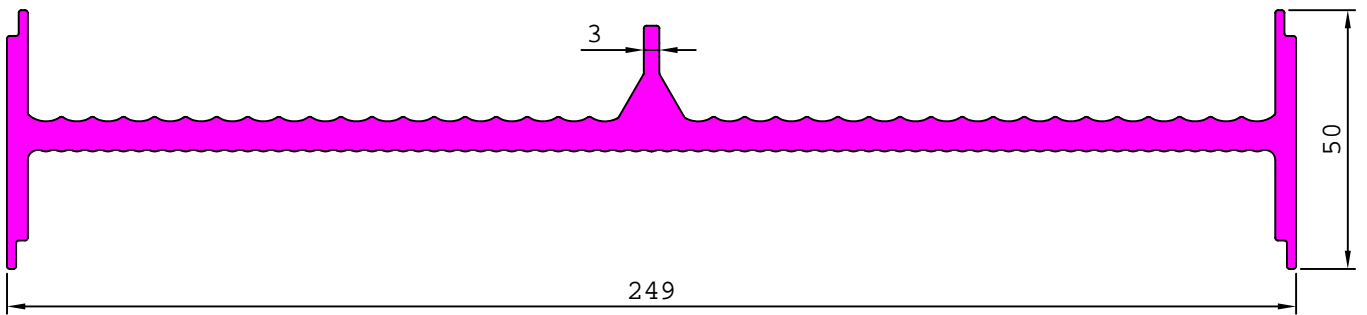

28180

7.448 kg/m

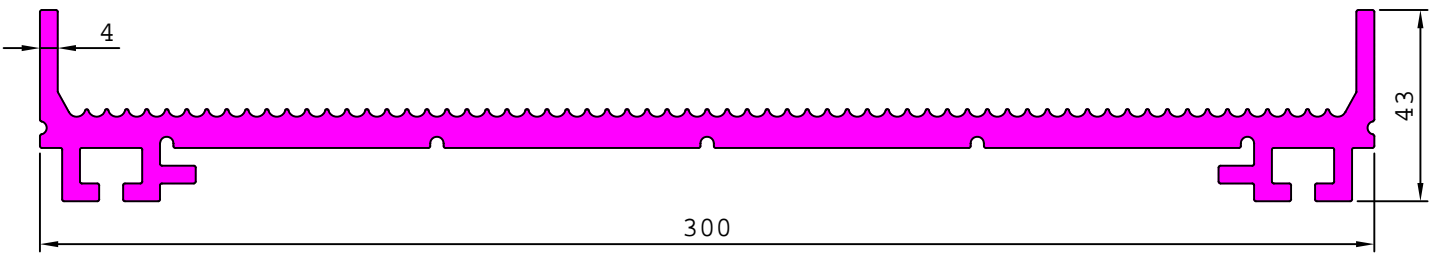

28210

5.197 kg/m

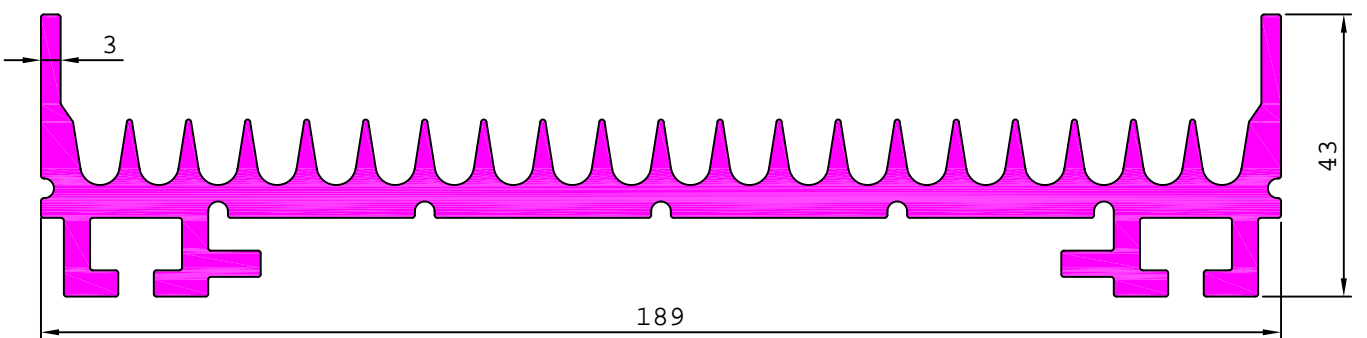

28967

5.304 kg/m

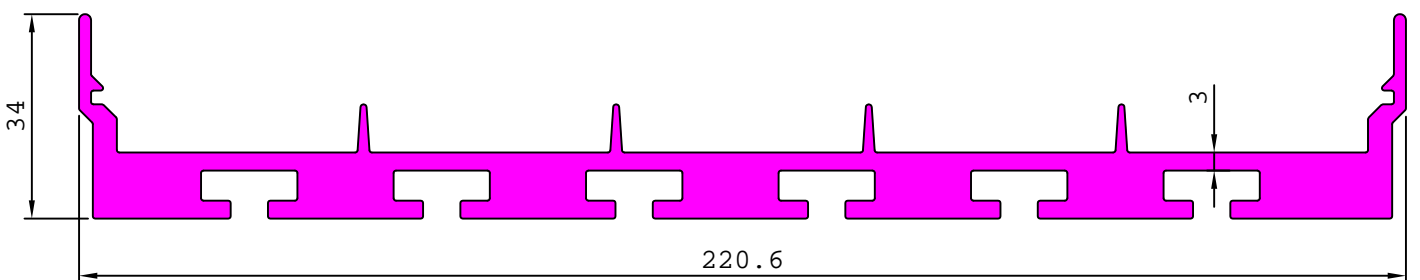

INDUSTRIAL

CHUTE SECTIONS

28968

6.460 kg/m

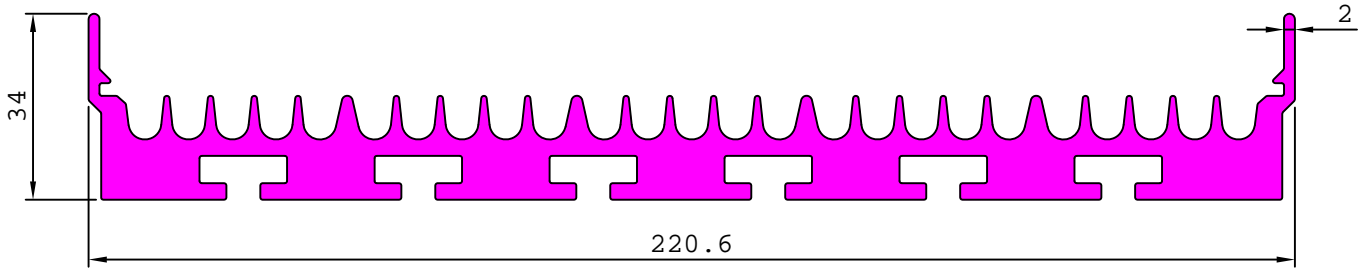

29527

5.510 kg/m

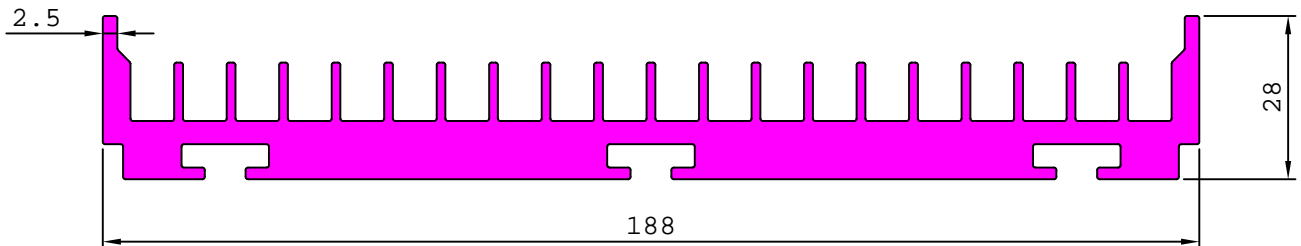

29528

6.643 kg/m

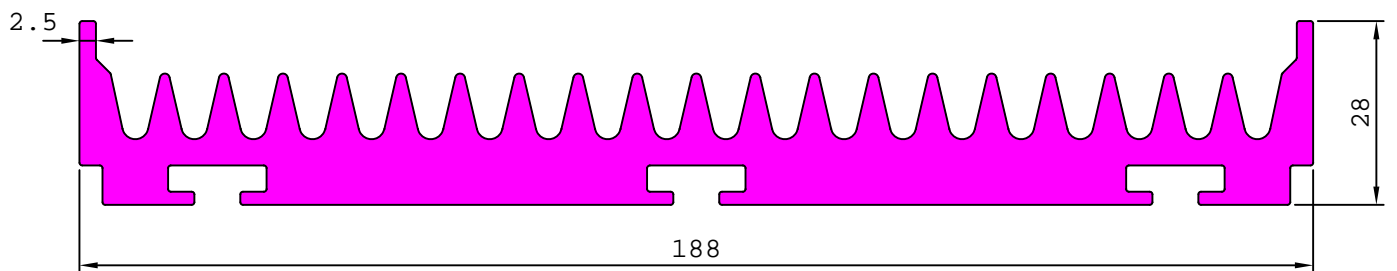

29322

3.590 kg/m

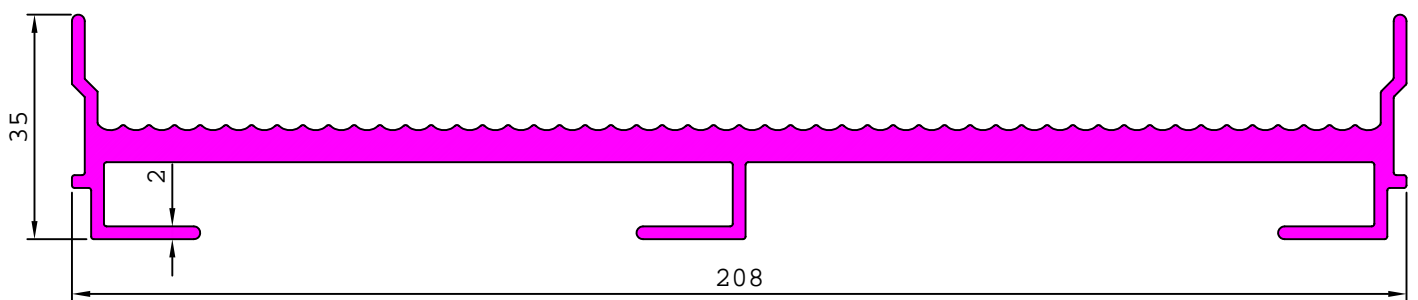

29345

4.475 kg/m

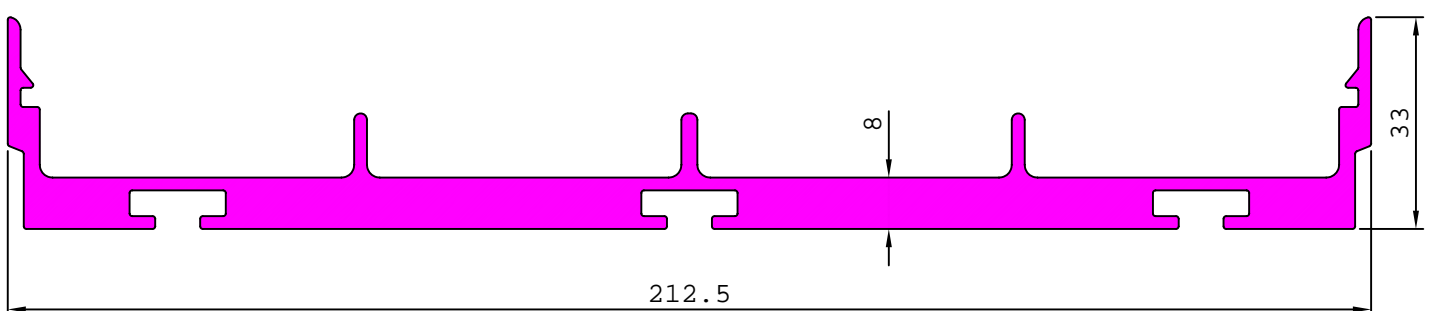

INDUSTRIAL

CHUTE SECTIONS

28201

5.473 kg/m

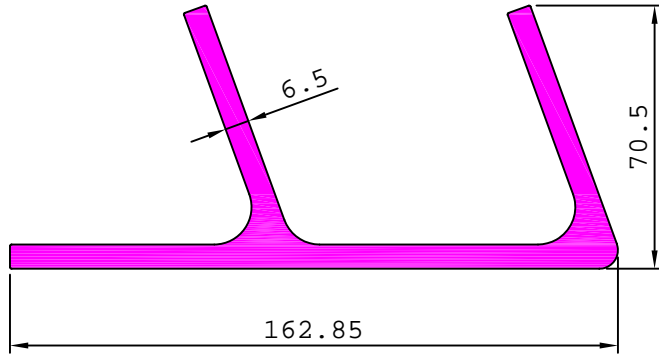

29367

2.548 kg/m

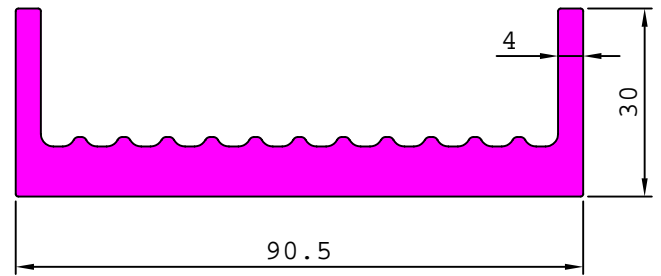

29369

3.518 kg/m

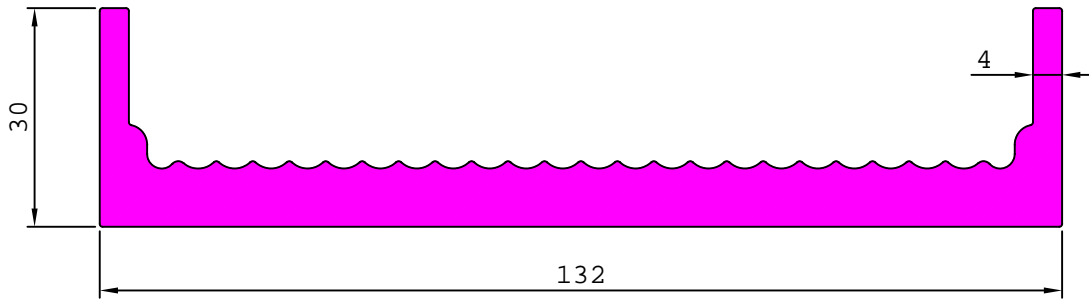

27896

9.019 kg/m

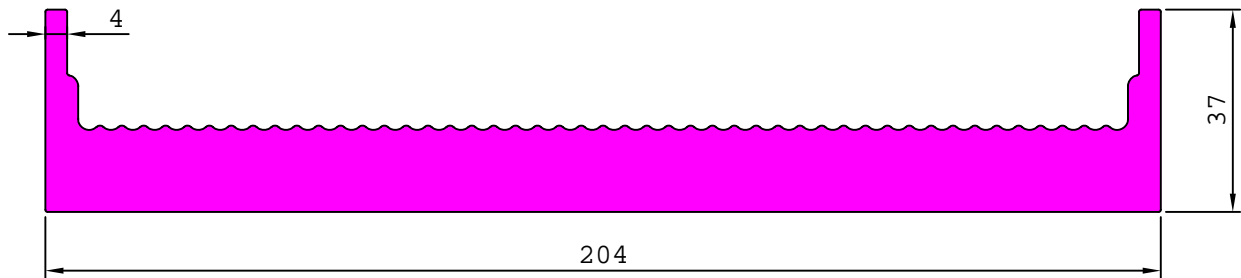

27984

4.888 kg/m

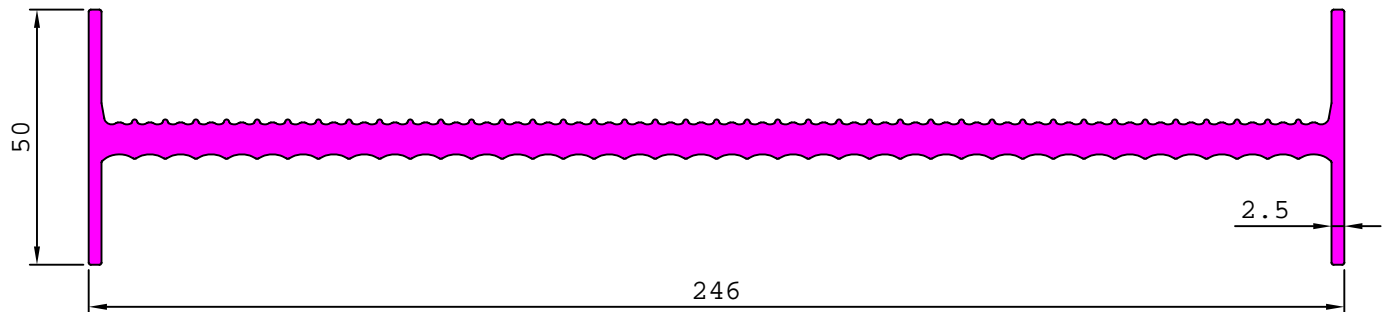

28274

5.791 kg/m

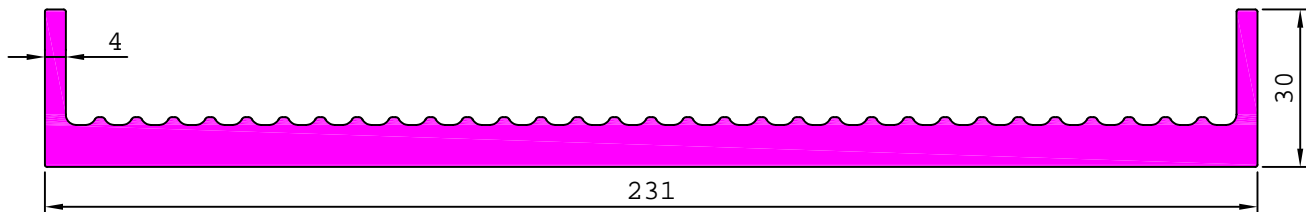

INDUSTRIAL

CHUTE SECTIONS

28086

5.523 kg/m

28209

8.786 kg/m

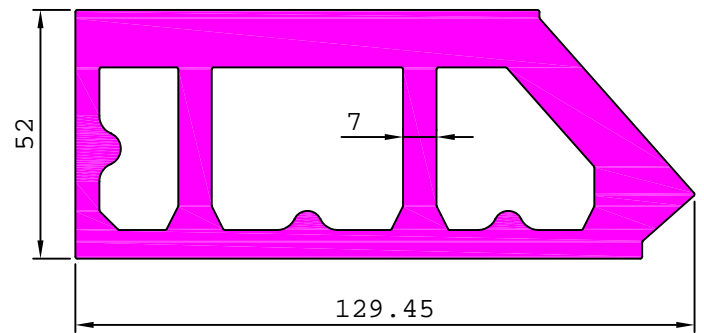
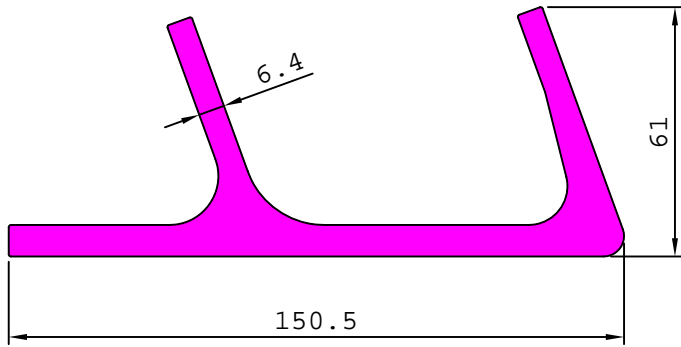

28216

6.873 kg/m

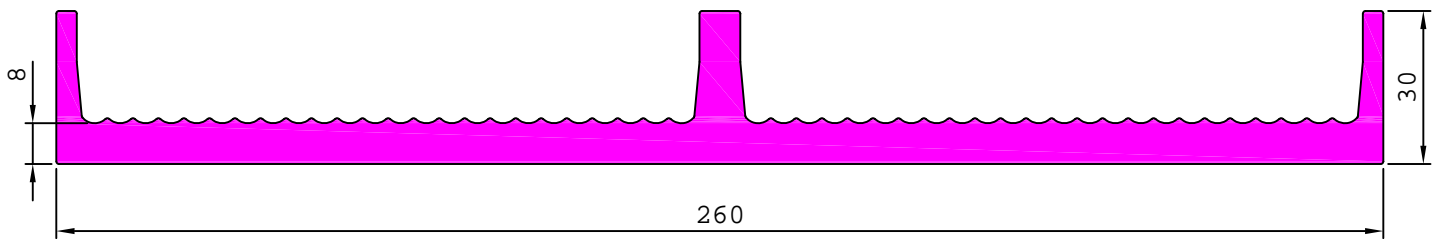

28237

4.253 kg/m

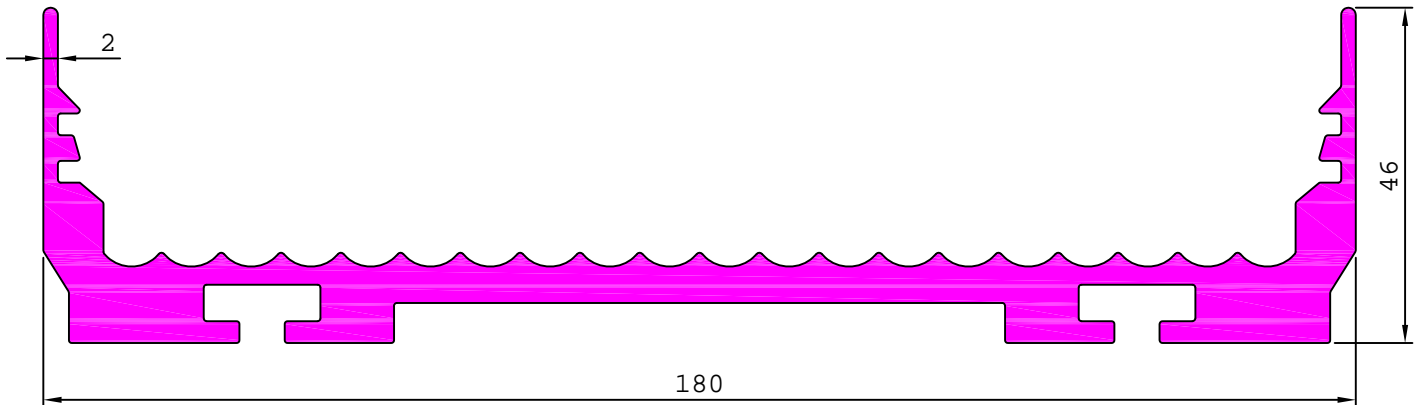

28246

3.337 kg/m

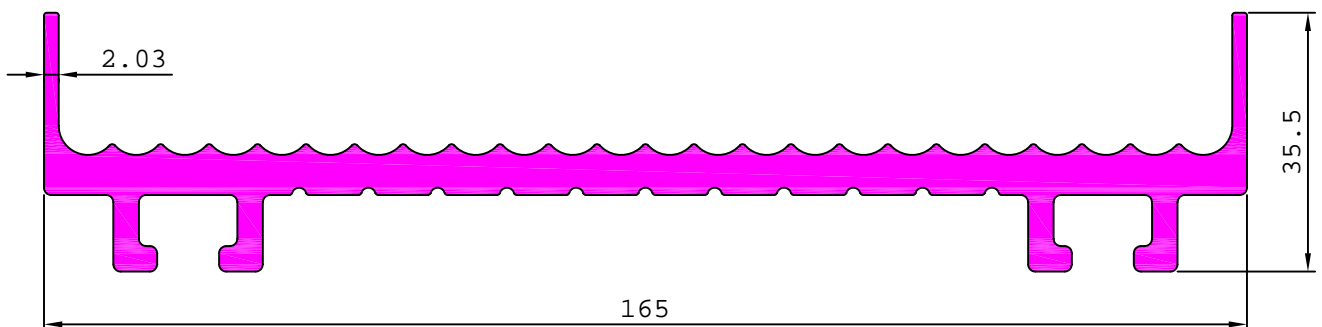

INDUSTRIAL

CHUTE SECTIONS

S4785

2.925 kg/m

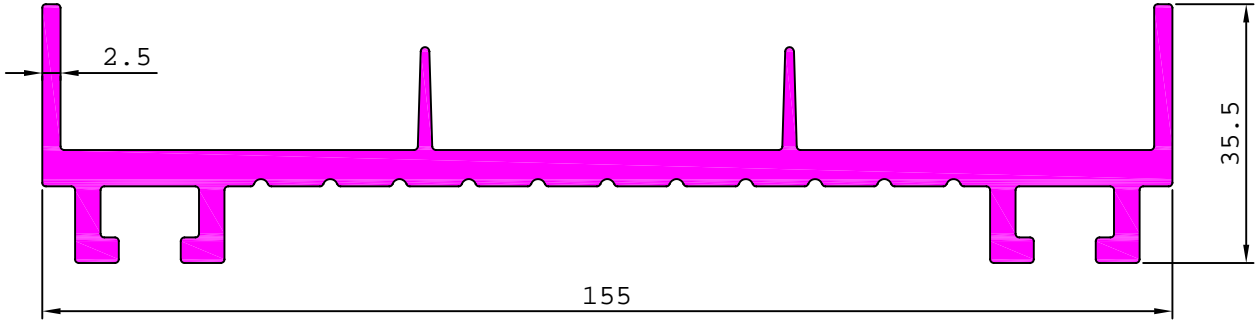

S4899

6.968 kg/m

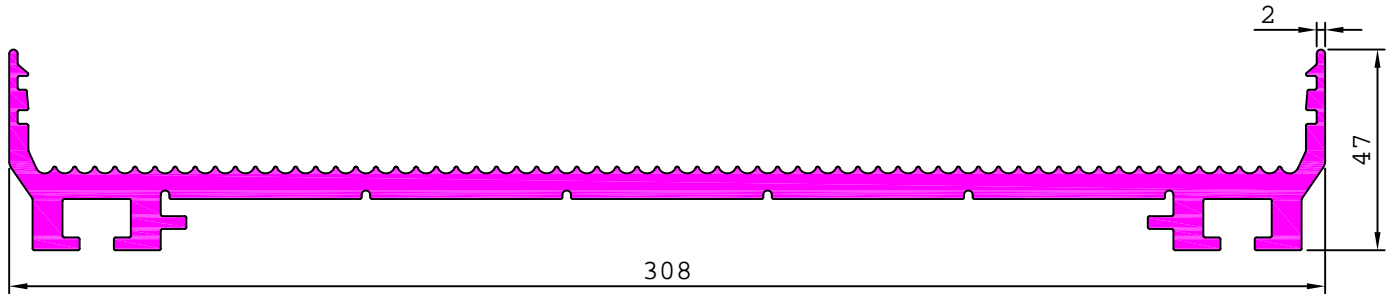

S4975

6.443 kg/m

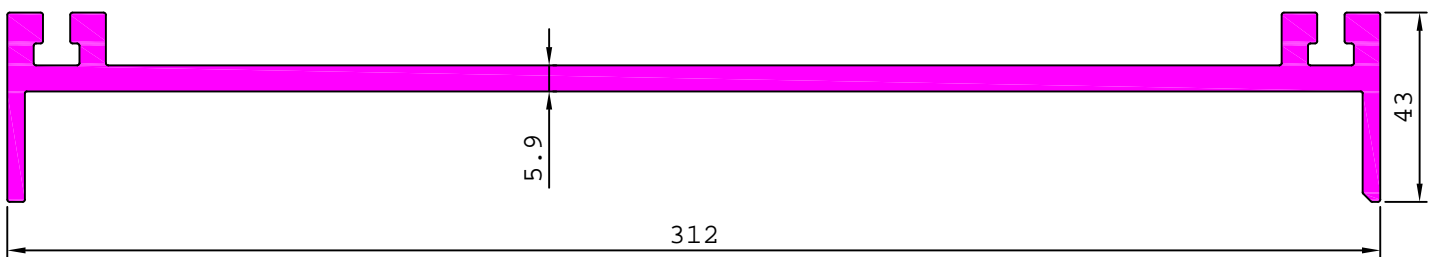

S4279

8.026 kg/m

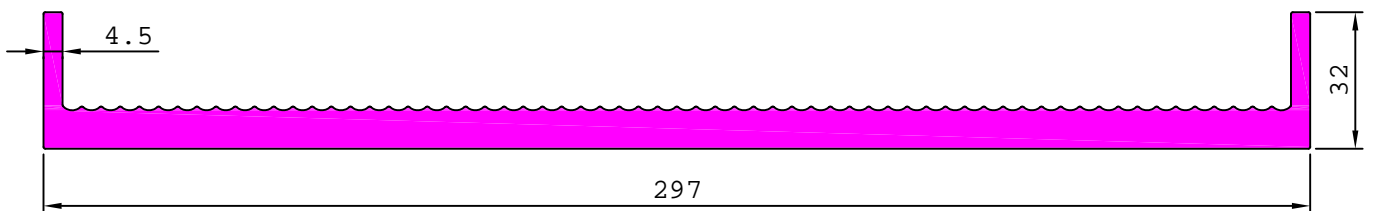

S4416

4.175 kg/m

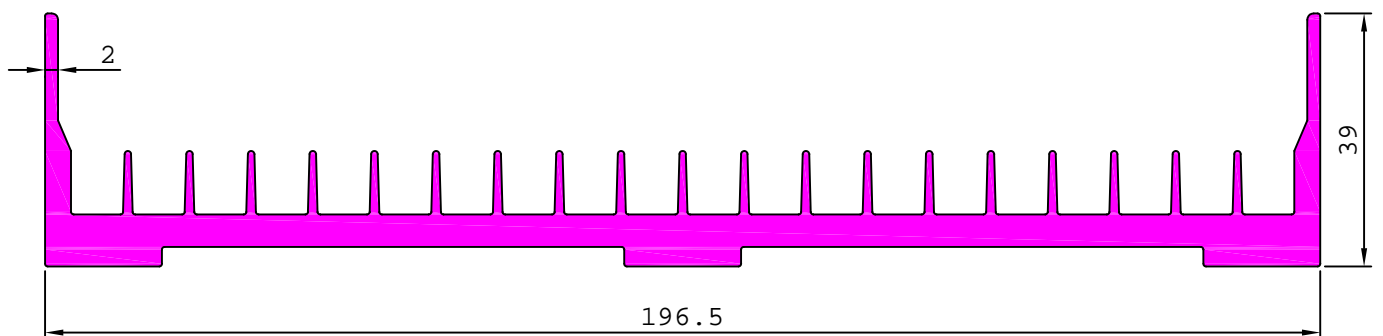

INDUSTRIAL

CHUTE SECTIONS

S5071

6.427 kg/m

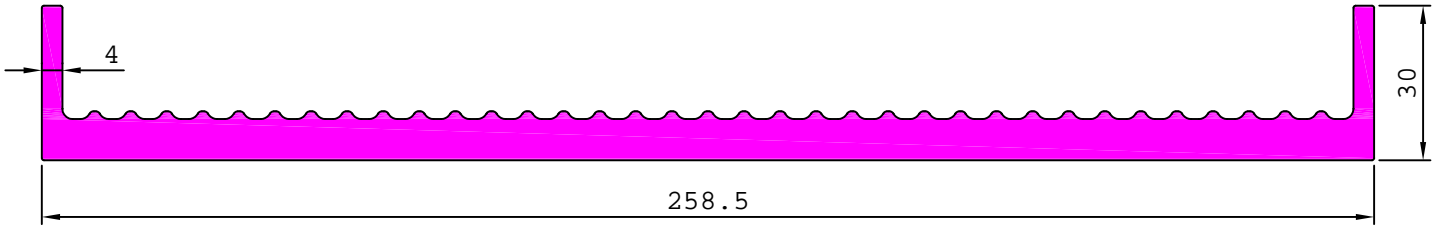

S5080

4.929 kg/m

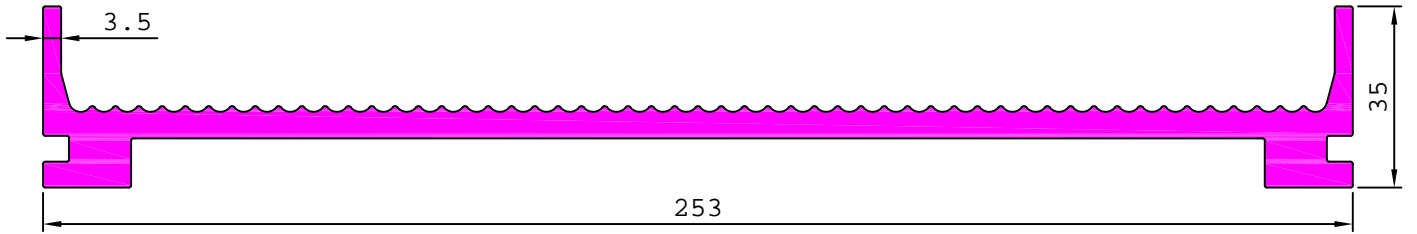

S5083

4.921 kg/m

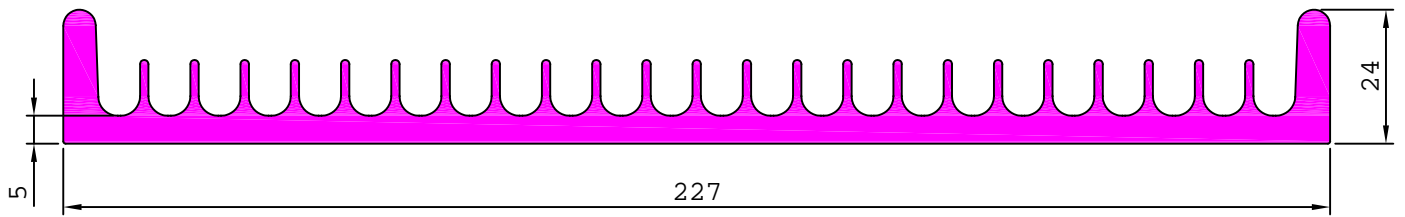

INDUSTRIAL

AUTOMOBILE SECTIONS

27490

1.677 kg/m

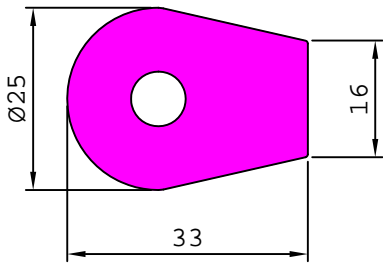

27535

2.761 kg/m

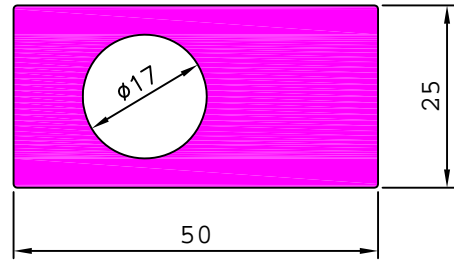

27633

2.128 kg/m

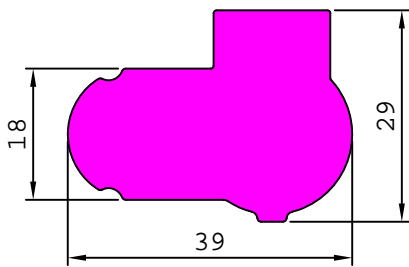

27634

1.838 kg/m

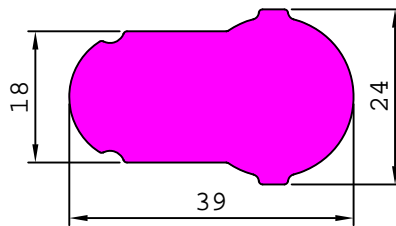

27641

1.955 kg/m

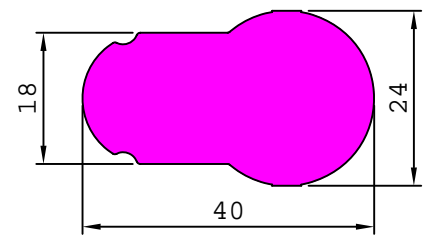

27644

4.123 kg/m

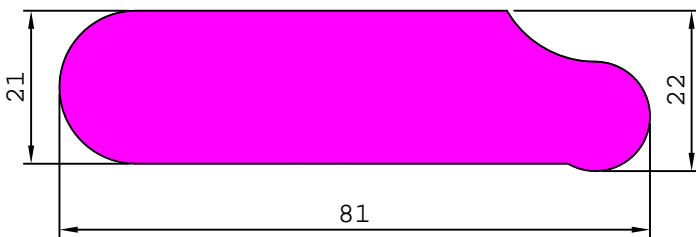

27695

3.321 kg/m

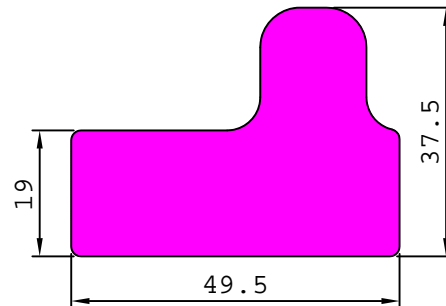

27649

1.222 kg/m

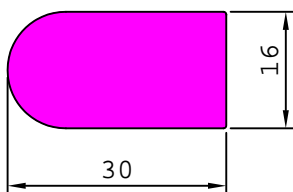

27650

1.439 kg/m

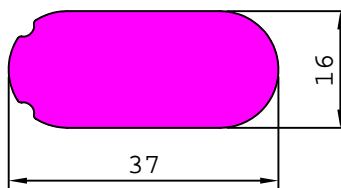

27664

2.143 kg/m

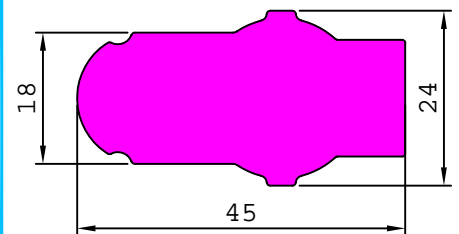

27682

2.548 kg/m

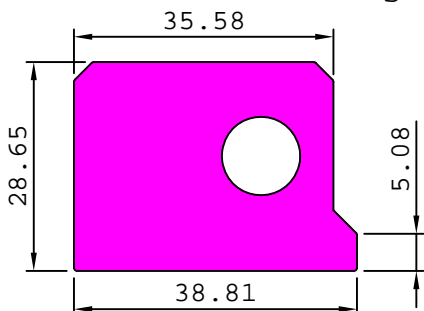

27684

1.137 kg/m

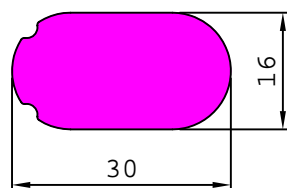

27685

1.851 kg/m

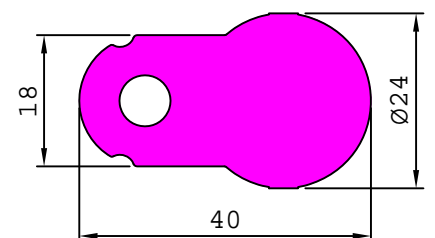

INDUSTRIAL

AUTOMOBILE SECTIONS

27703 1.305 kg/m

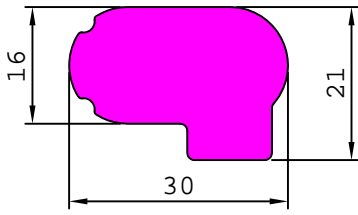

27708 1.162 kg/m

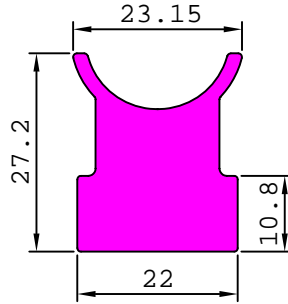

27709 0.704 kg/m

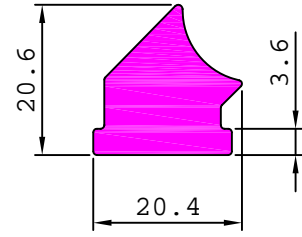

27738 1.341 kg/m

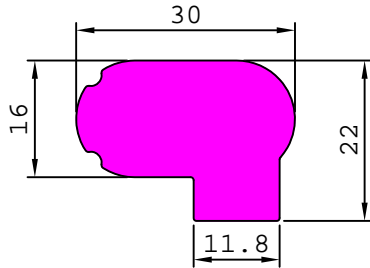

27748 2.269 kg/m

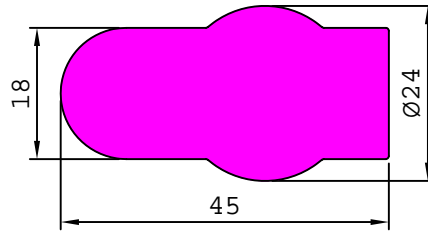

27764 1.656 kg/m

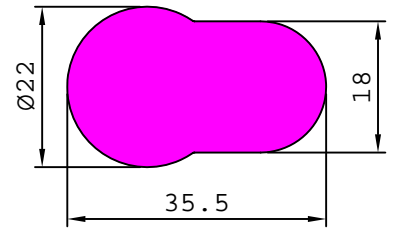

27751 1.736 kg/m

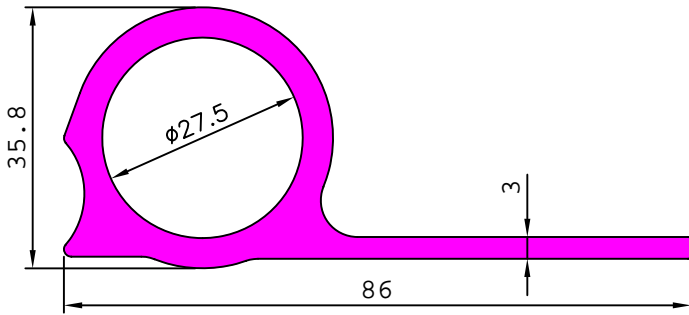

27769 1.274 kg/m

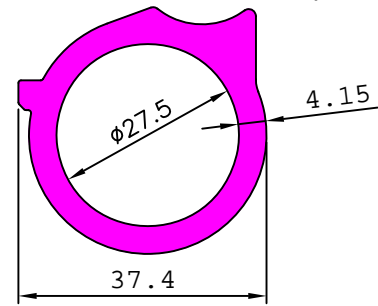

27756 6.142 kg/m

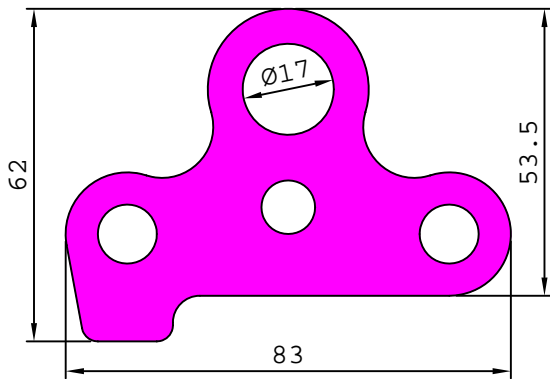

27782 3.545 kg/m

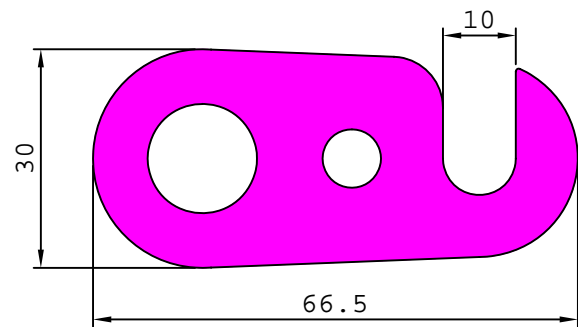

27768 2.468 kg/m

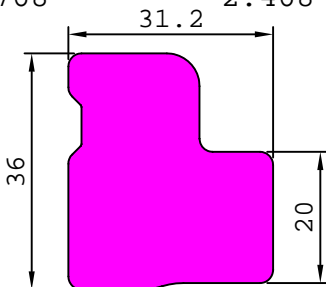

27770 2.960 kg/m

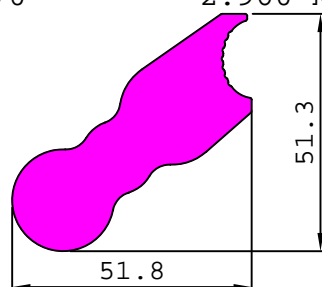

27854 1.297 kg/m

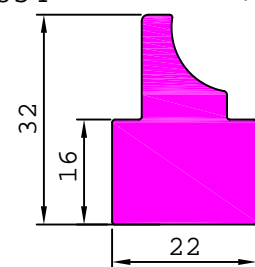

INDUSTRIAL

AUTOMOBILE SECTIONS

27771 4.472 kg/m

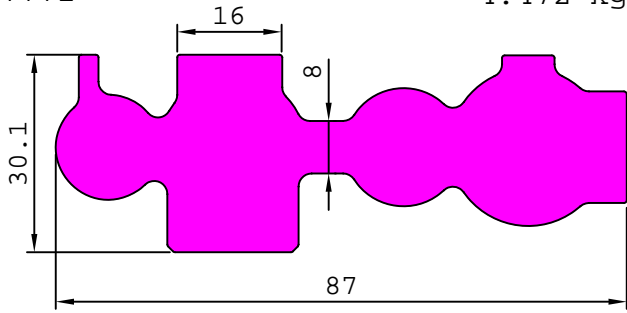

27773 6.694 kg/m

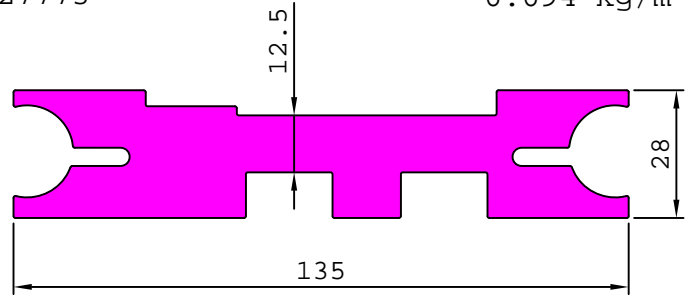

27790 1.420 kg/m

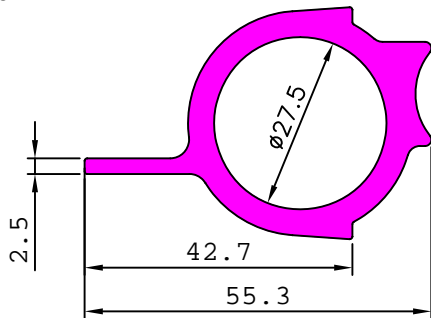

27793 6.297 kg/m

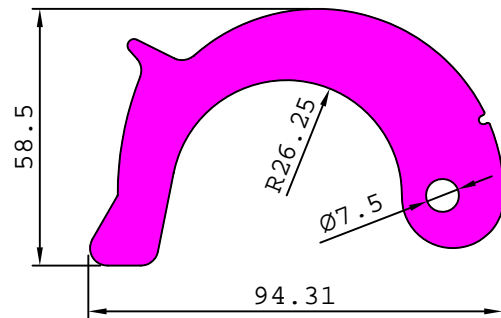

27791 0.896 kg/m

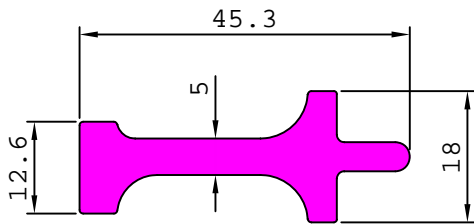

27792 4.294 kg/m

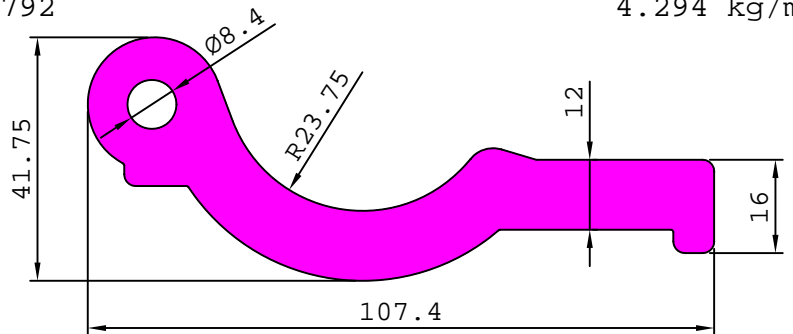

27794 6.638 kg/m

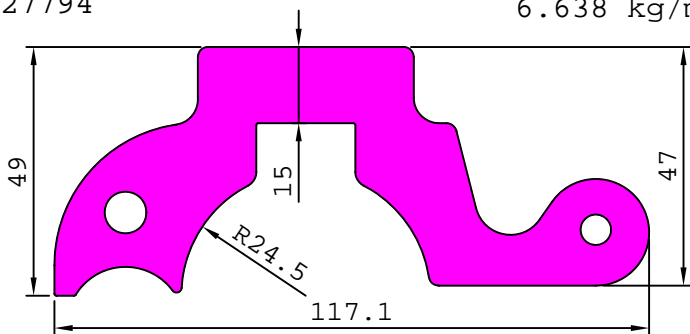

27829 5.416 kg/m

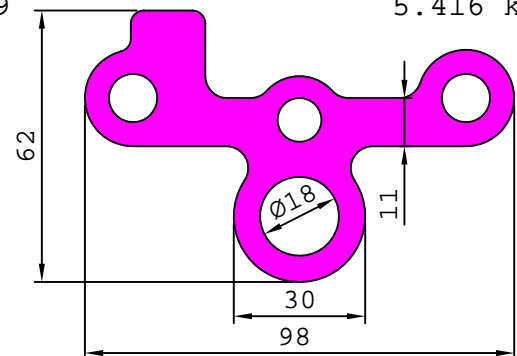

27865 1.228 kg/m

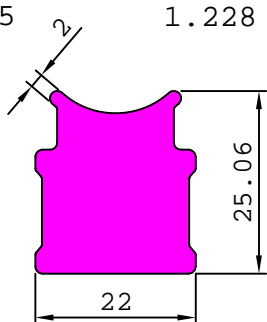

27857 0.823 kg/m

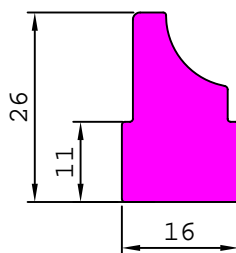

27858 0.570 kg/m

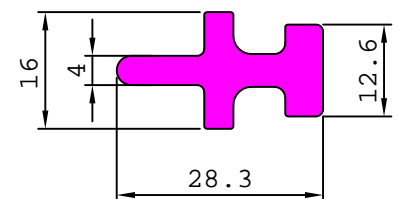

INDUSTRIAL

AUTOMOBILE SECTIONS

27862

2.540 kg/m

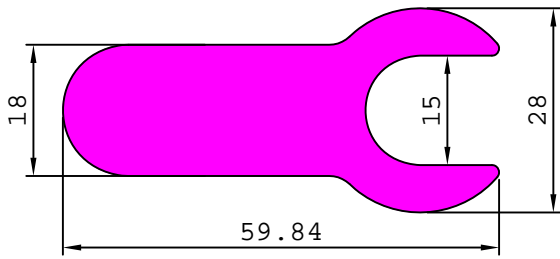

27900

2.346 kg/m

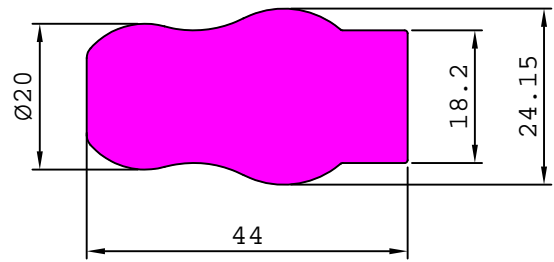

27873

1.349 kg/m

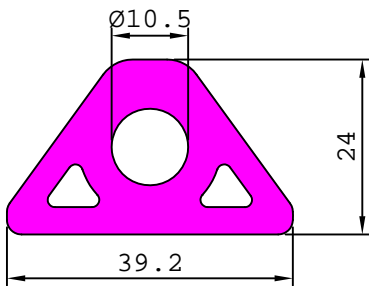

27874

1.434 kg/m

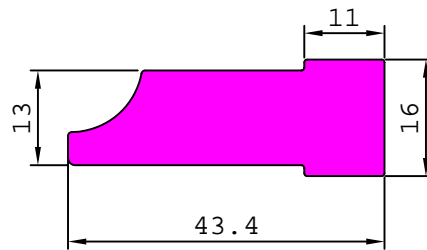

27876

1.231 kg/m

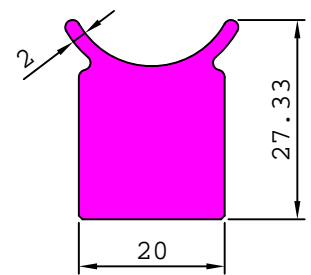

27878

1.213 kg/m

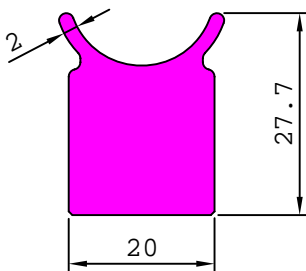

27879

0.991 kg/m

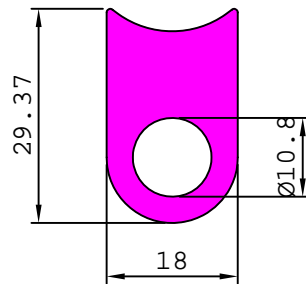

27889

2.524 kg/m

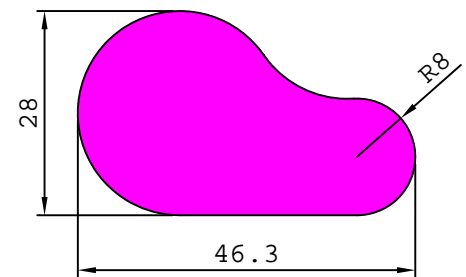

27890

2.183 kg/m

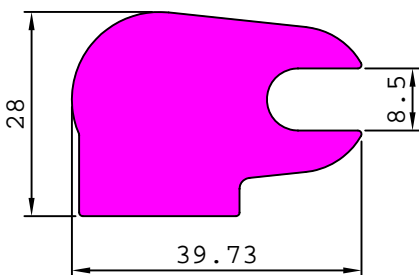

27892

1.558 kg/m

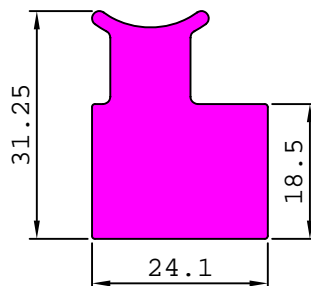

27901

2.291 kg/m

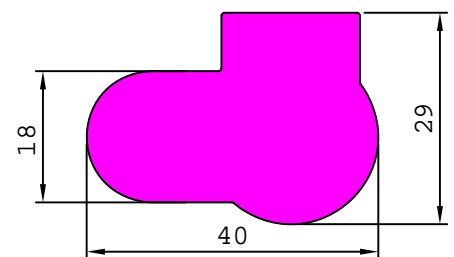

27906

1.172 kg/m

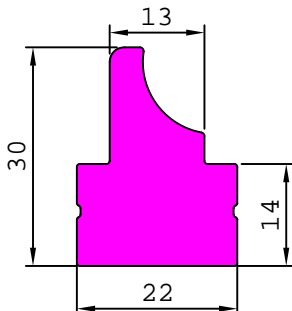

27917

0.757 kg/m

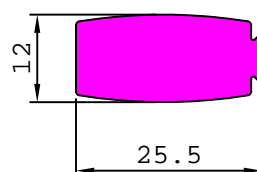

27933

2.632 kg/m

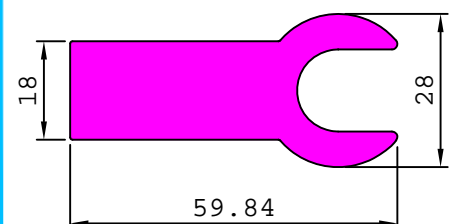

INDUSTRIAL

AUTOMOBILE SECTIONS

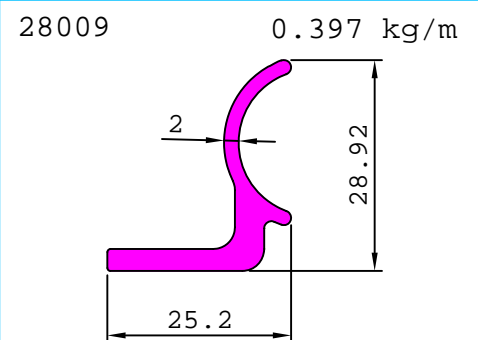
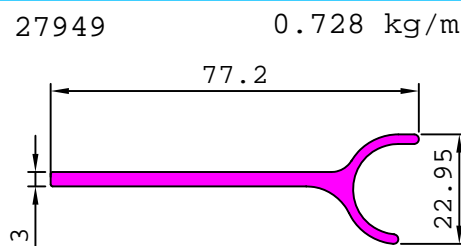
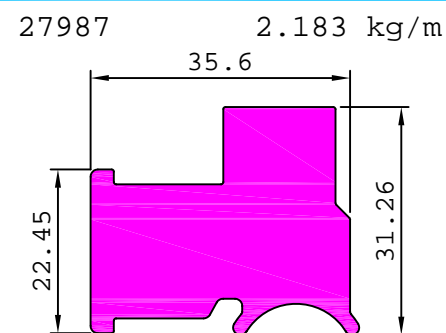
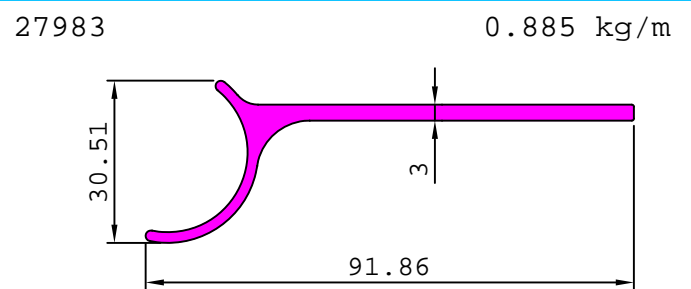
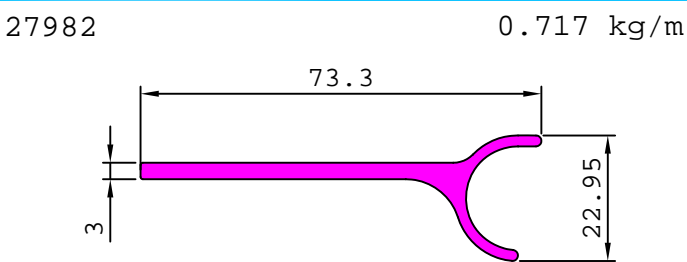
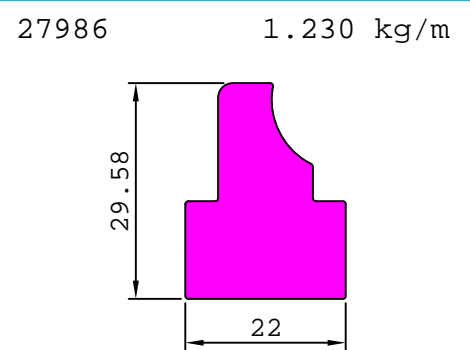
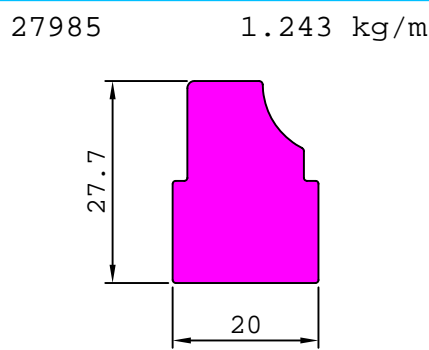
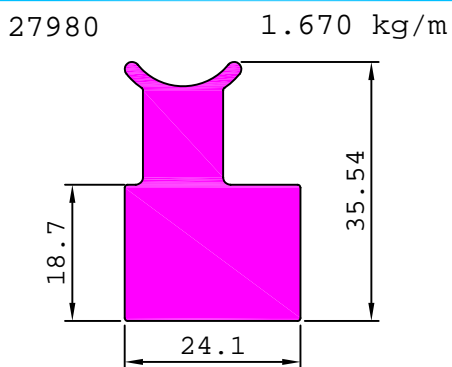
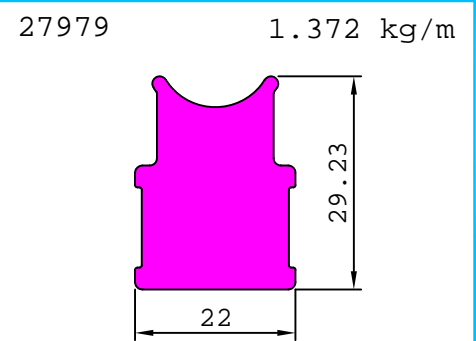
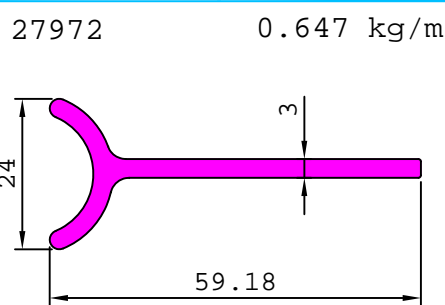
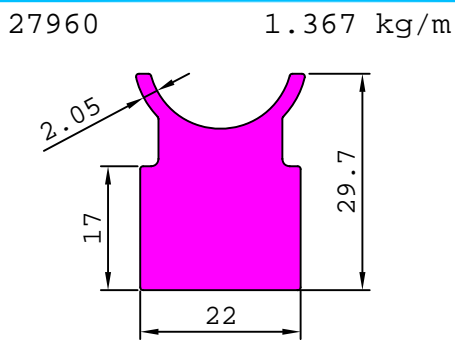
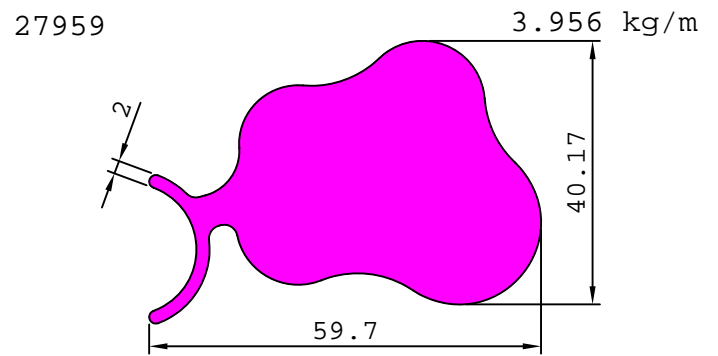
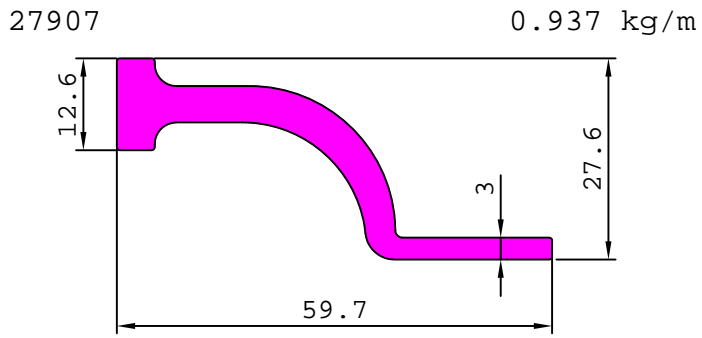

INDUSTRIAL

AUTOMOBILE SECTIONS

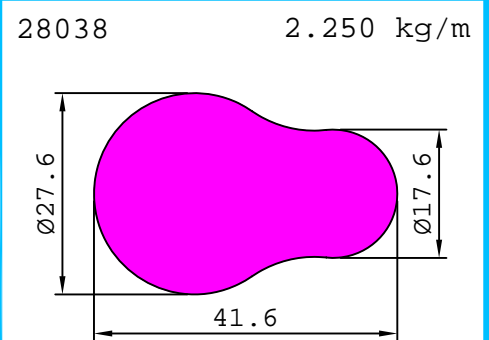
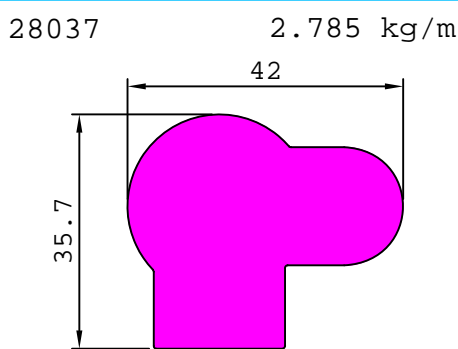
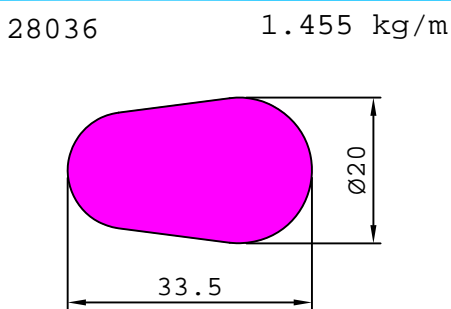
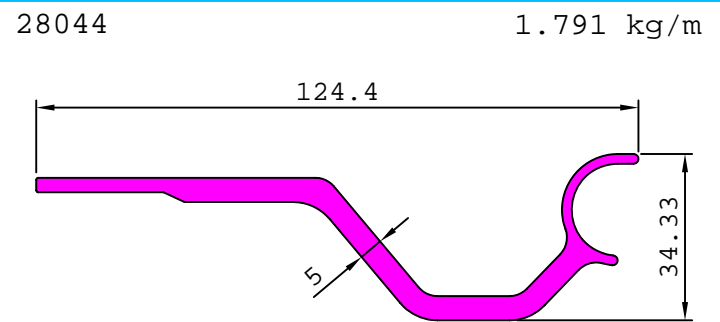
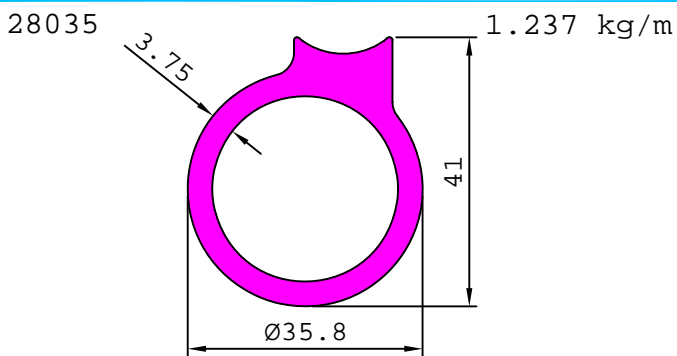
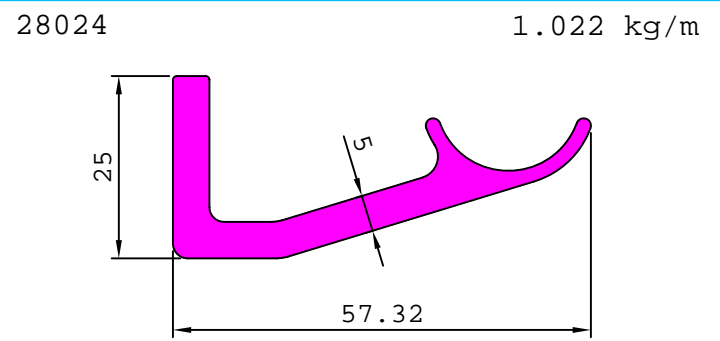
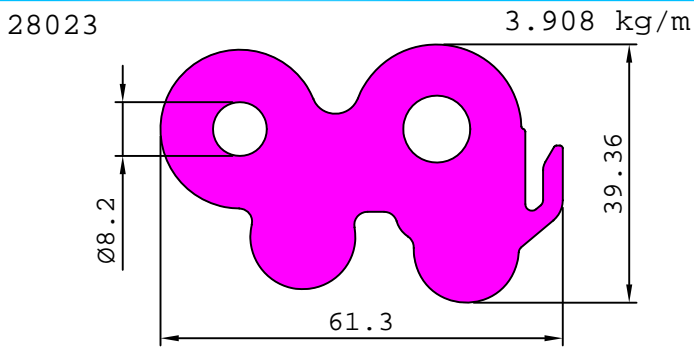
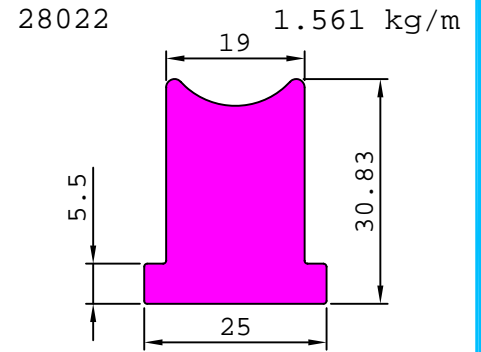
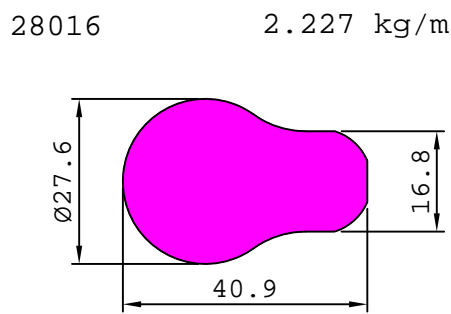
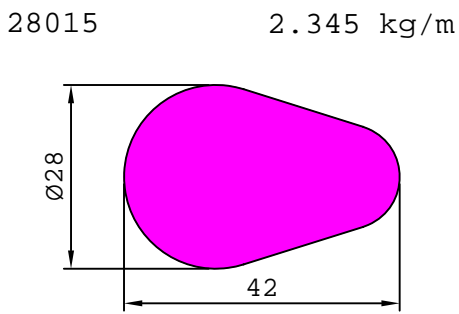
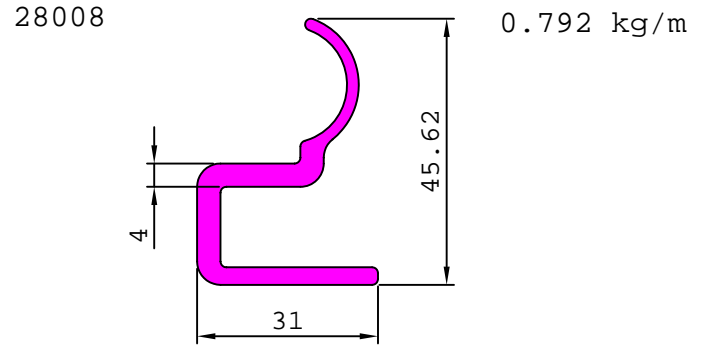
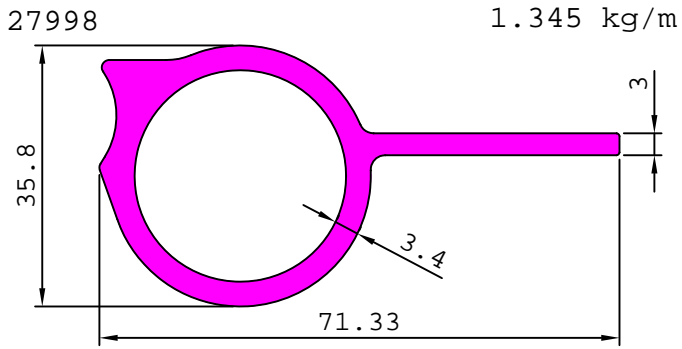

INDUSTRIAL

AUTOMOBILE SECTIONS

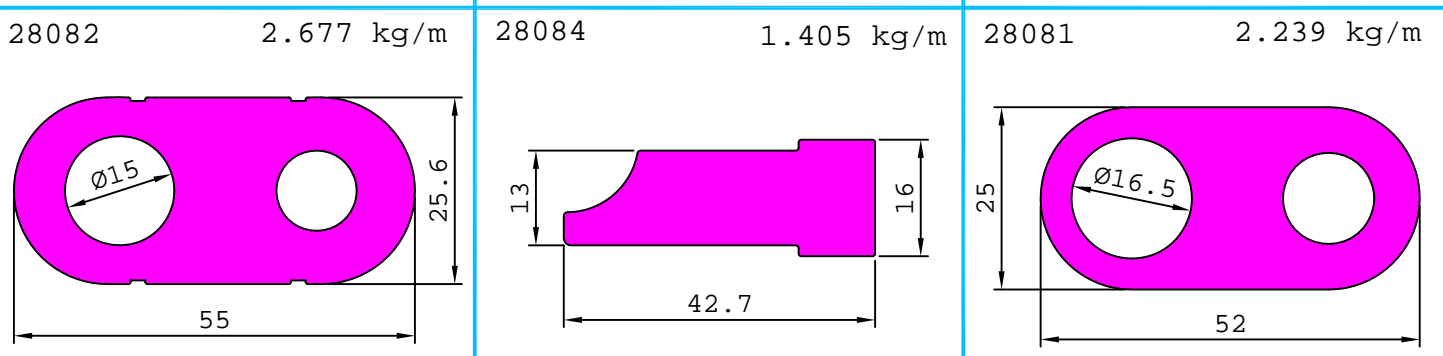
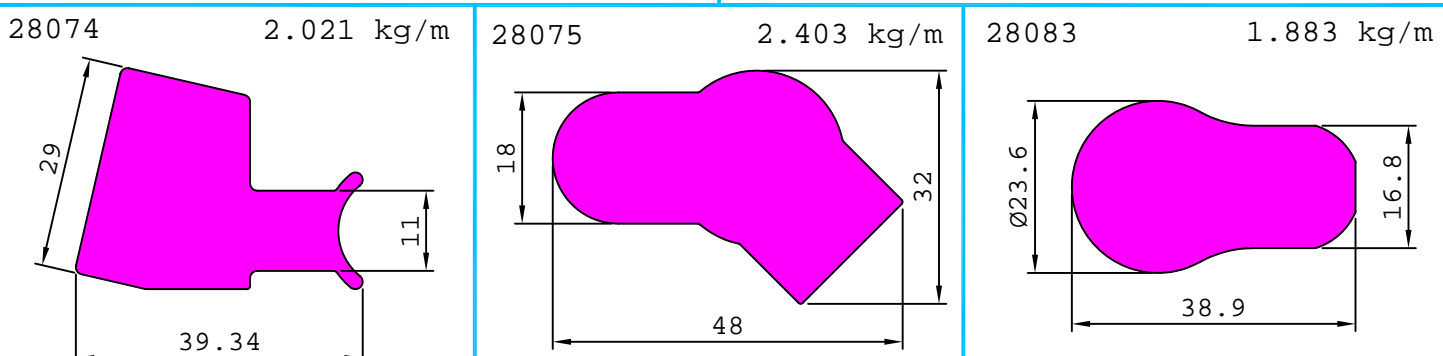
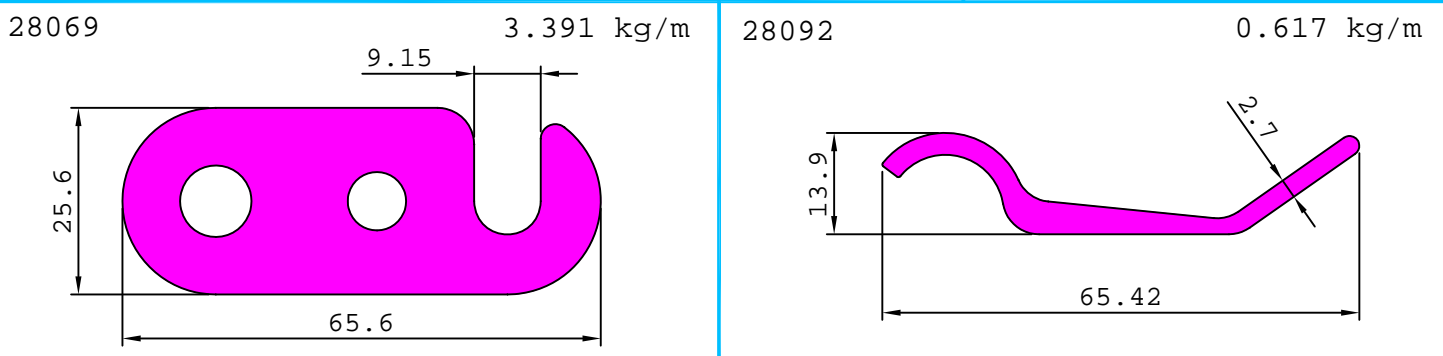
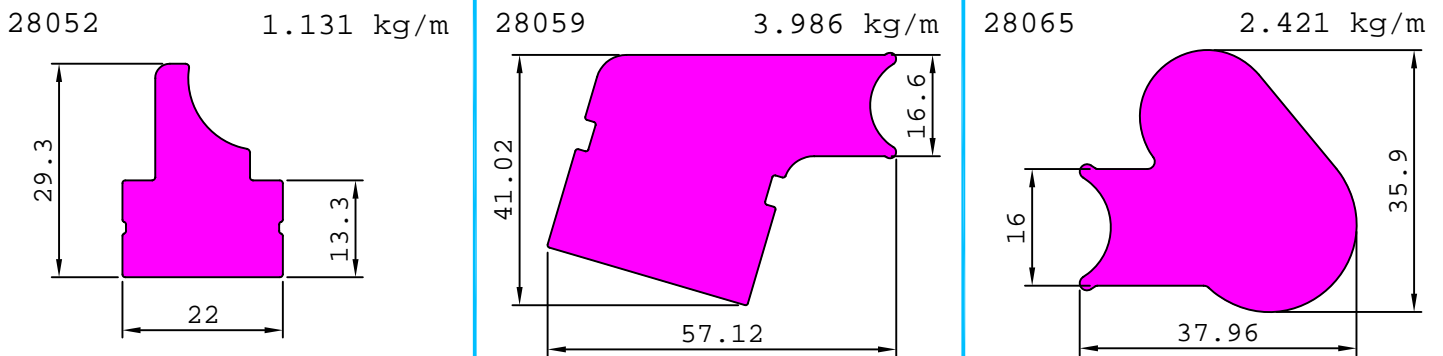
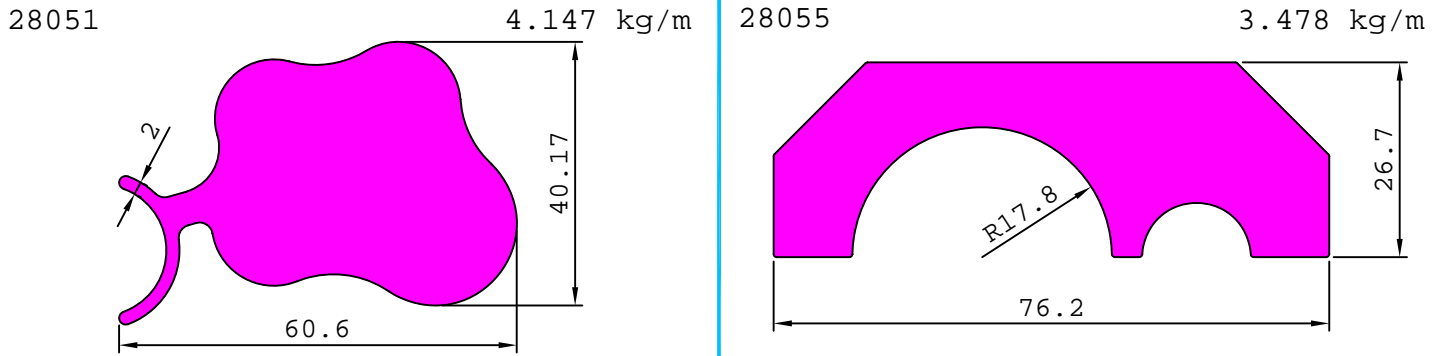

INDUSTRIAL

AUTOMOBILE SECTIONS

<p>28090 0.210 kg/m</p>	<p>28091 2.412 kg/m</p>	<p>28093 1.147 kg/m</p>
------------------------------	------------------------------	------------------------------

<p>28094 2.234 kg/m</p>	<p>28116 1.097 kg/m</p>
------------------------------	------------------------------

<p>28110 1.131 kg/m</p>	<p>28117 3.374 kg/m</p>	<p>28121 0.625 kg/m</p>
------------------------------	------------------------------	------------------------------

<p>28118 1.256 kg/m</p>	<p>28139 1.408 kg/m</p>	<p>28140 0.734 kg/m</p>
------------------------------	------------------------------	------------------------------

<p>28156 0.965 kg/m</p>	<p>28158 4.068 kg/m</p>
------------------------------	------------------------------

INDUSTRIAL

AUTOMOBILE SECTIONS

<p>28157 1.168 kg/m</p> <p>Ø17.6 31.2</p>	<p>28159 3.526 kg/m</p> <p>50.7 26.7</p>	<p>28133 1.313 kg/m</p> <p>3.5 22.5 27.52</p>
<p>28132 2.168 kg/m</p> <p>3.5 29.7 37.79</p>	<p>28174 2.840 kg/m</p> <p>30.6 40.97</p>	<p>28173 2.611 kg/m</p> <p>Ø29.4 43.4</p>
<p>28143 0.884 kg/m</p> <p>15 19 22.5</p>	<p>28175 1.873 kg/m</p> <p>Ø24 38.5</p>	<p>28169 2.358 kg/m</p> <p>Ø28 43.5</p>
<p>28195 2.652 kg/m</p> <p>4.5 59.72 37.1</p>	<p>28124 5.715 kg/m</p> <p>46.5 116.1 19</p>	
<p>28131 9.233 kg/m</p> <p>82.31 46.76</p>	<p>28211 4.309 kg/m</p> <p>32 64</p>	

INDUSTRIAL

AUTOMOBILE SECTIONS

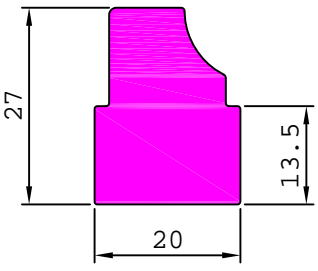
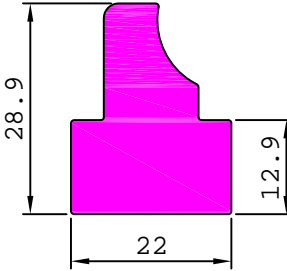
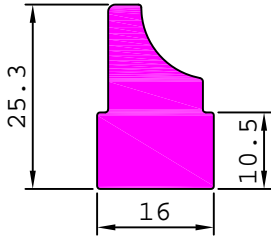
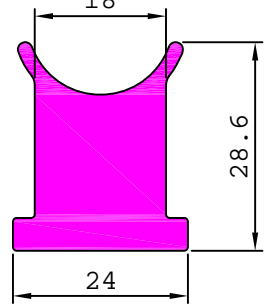
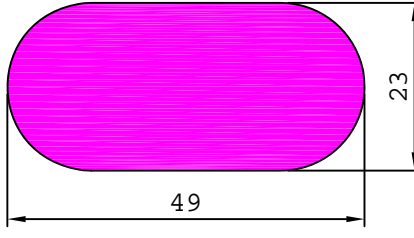
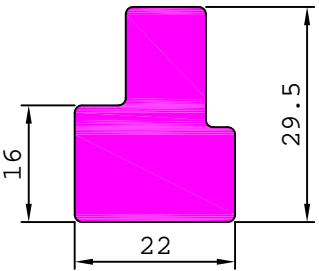
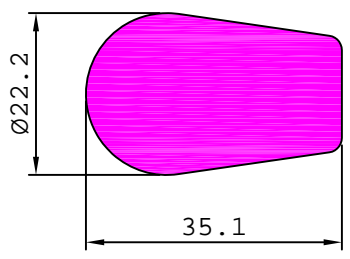
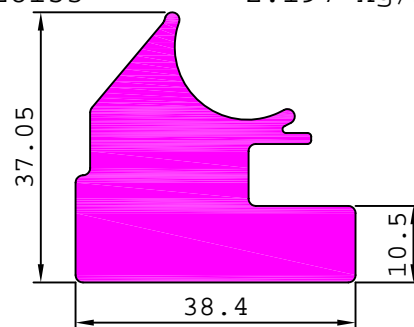
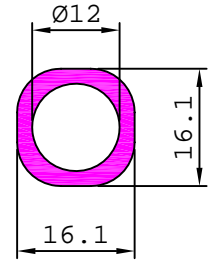
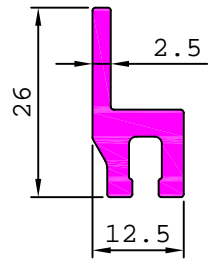
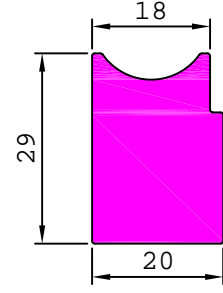
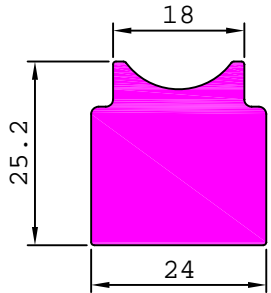
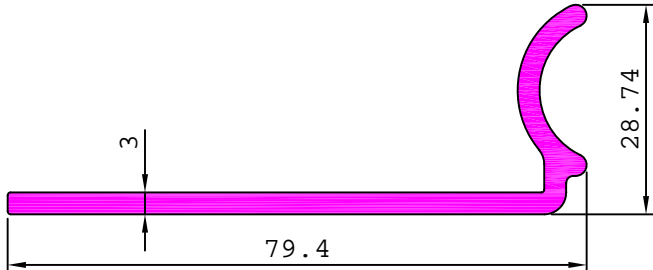
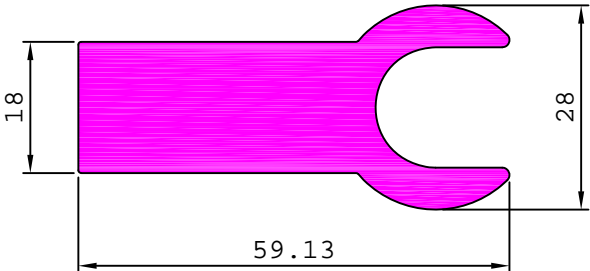
<p>28199 1.208 kg/m</p> 	<p>28200 1.193 kg/m</p> 	<p>28125 0.794 kg/m</p> 
<p>28207 1.230 kg/m</p> 	<p>28215 2.736 kg/m</p> 	<p>28170 1.317 kg/m</p> 
<p>28229 1.748 kg/m</p> 	<p>28153 2.197 kg/m</p> 	<p>28248 0.311 kg/m</p> 
<p>28249 0.372 kg/m</p> 	<p>28254 1.403 kg/m</p> 	<p>28255 1.426 kg/m</p> 
<p>28250 0.873 kg/m</p> 	<p>28260 2.534 kg/m</p> 	

INDUSTRIAL

AUTOMOBILE SECTIONS

29179 1.256 kg/m

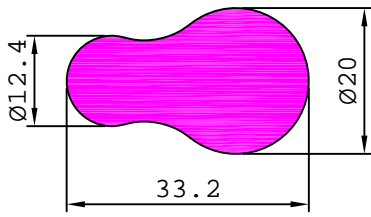

29321 1.966 kg/m

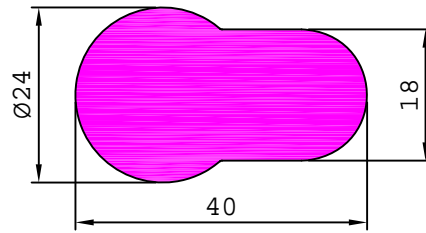

29402 2.053 kg/m

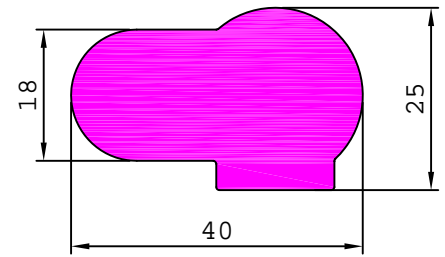

28961 4.826 kg/m

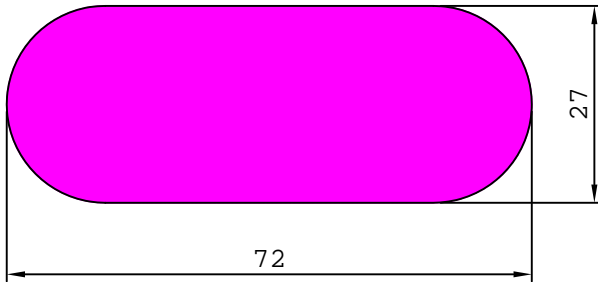

29032 3.145 kg/m

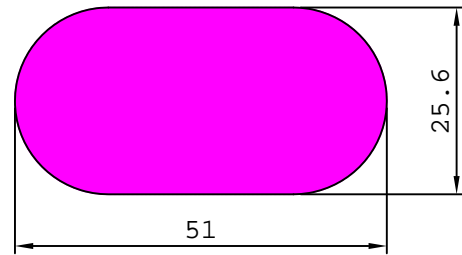

29340 0.726 kg/m

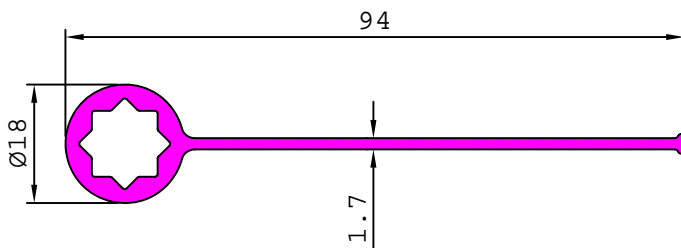

29358 1.069 kg/m

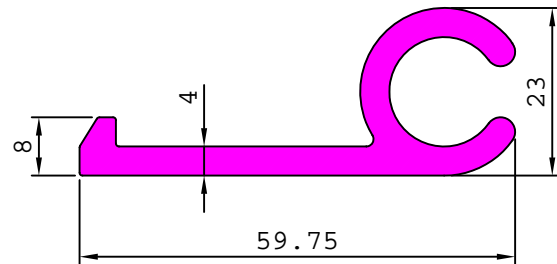

29359 1.638 kg/m

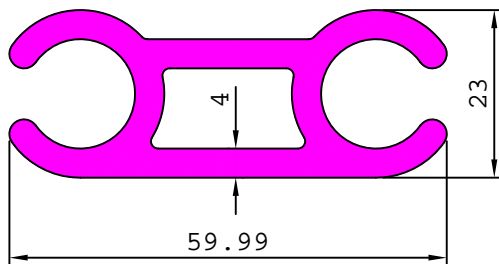

28148 0.408 kg/m

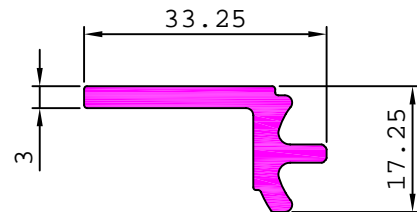

27849 1.254 kg/m

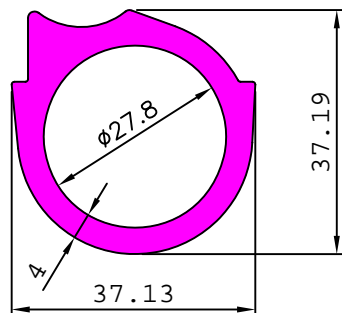

28149 0.514 kg/m

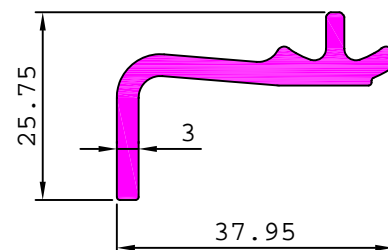

INDUSTRIAL

AUTOMOBILE SECTIONS

28188 1.881 kg/m

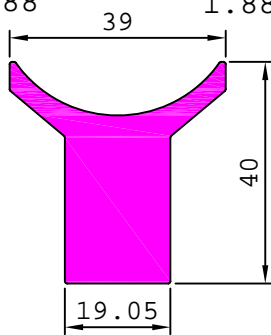

28189 3.070 kg/m

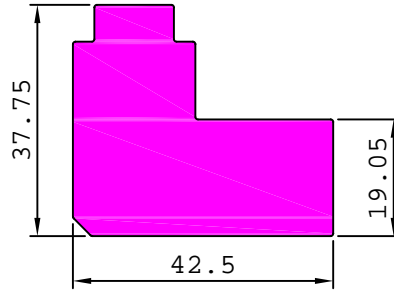

28232 2.108 kg/m

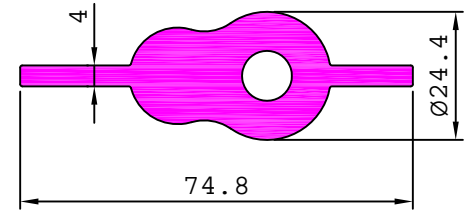

28233 2.068 kg/m

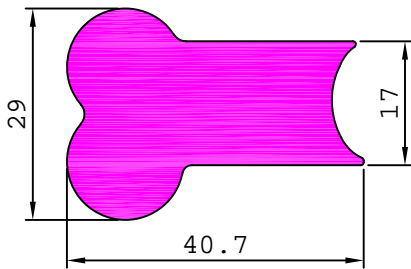

28234 0.944 kg/m

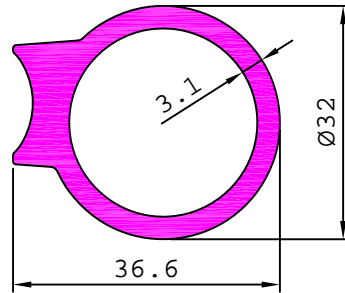

28235 0.668 kg/m

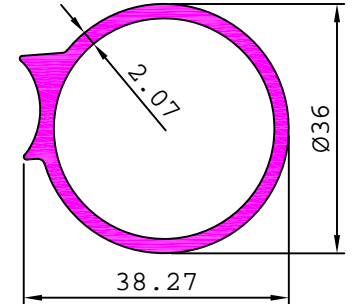

28244 0.728 kg/m

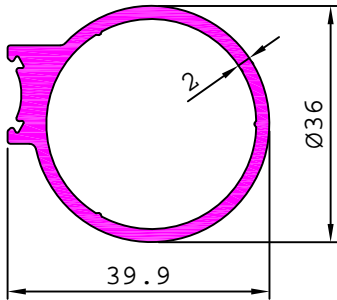

28245 1.096 kg/m

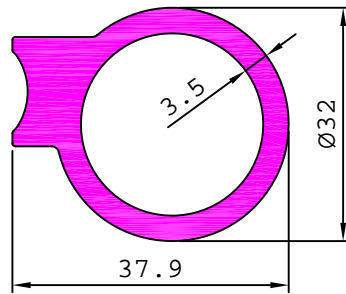

28261 1.548 kg/m

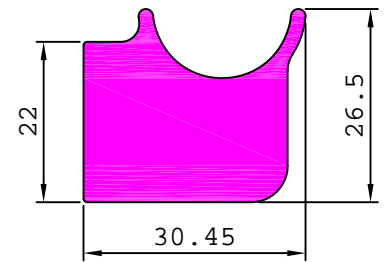

28266 1.685 kg/m

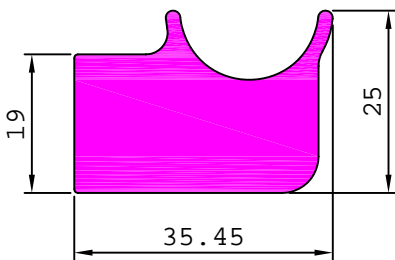

28269 0.987 kg/m

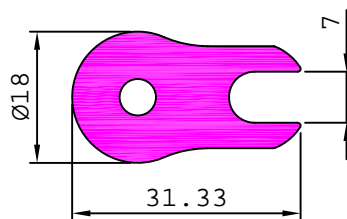

S4258 0.759 kg/m

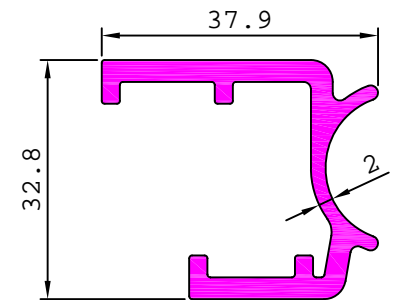

S4259 0.667 kg/m

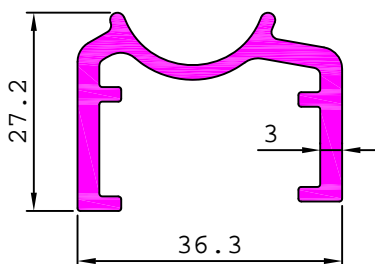

S4260 0.718 kg/m

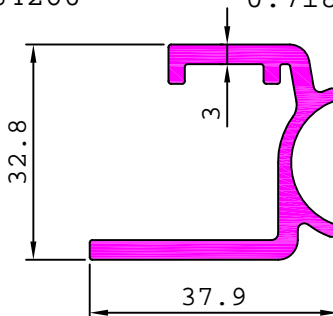

S4261 0.637 kg/m

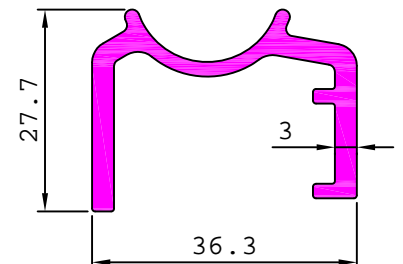

INDUSTRIAL

AUTOMOBILE SECTIONS

S4267 2.149 kg/m

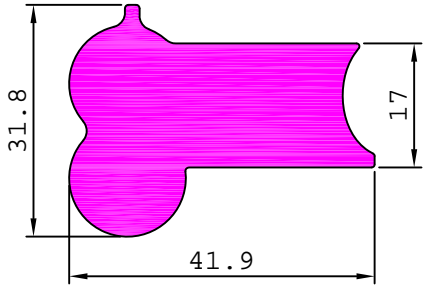

S4327 1.506 kg/m

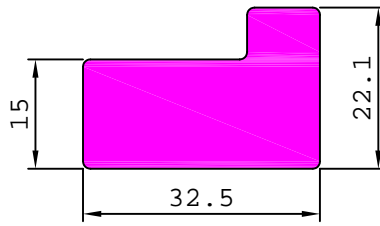

S4350 0.498 kg/m

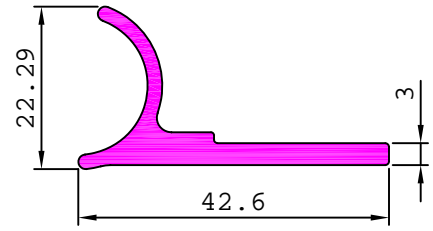

S4351 0.365 kg/m

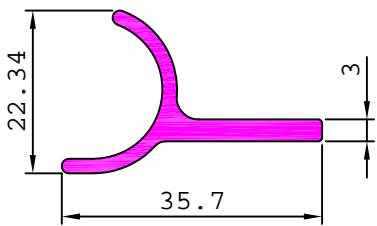

S4352 0.463 kg/m

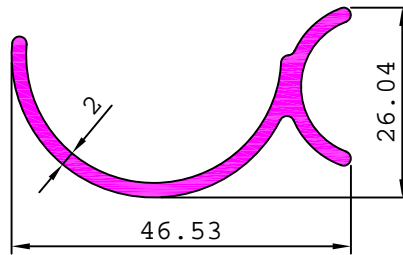

S4353 0.433 kg/m

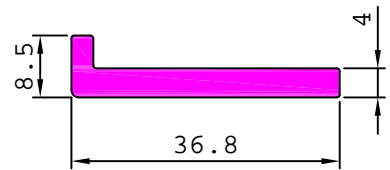

S4837 2.150 kg/m

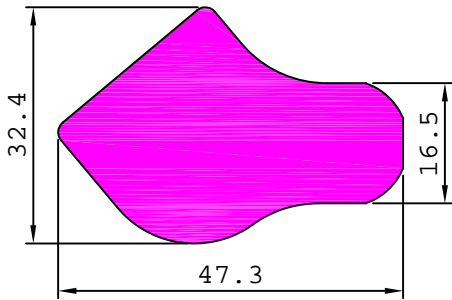

S4894 0.377 kg/m

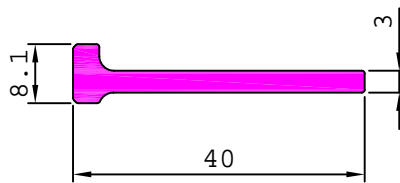

S4895 1.031 kg/m

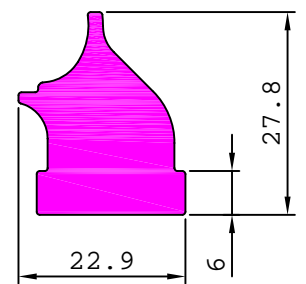

S4903 1.170 kg/m

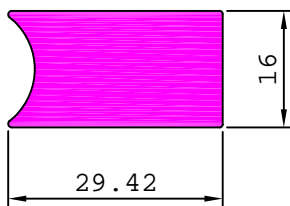

S4904 1.775 kg/m

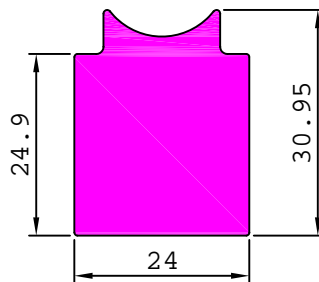

S4910 1.122 kg/m

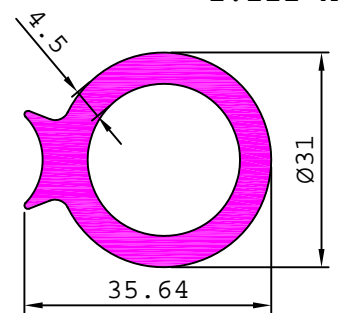

S4911 0.356 kg/m

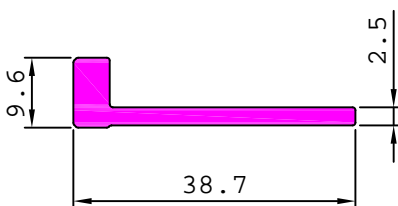

S4953 1.772 kg/m

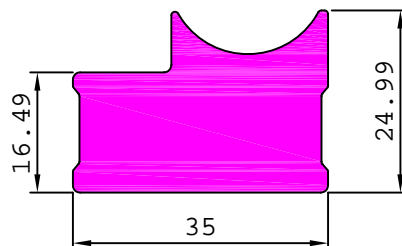

S4926 0.699 kg/m

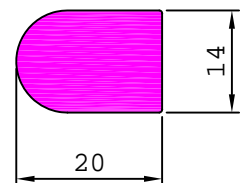

INDUSTRIAL

AUTOMOBILE SECTIONS

S4935

2.996 kg/m

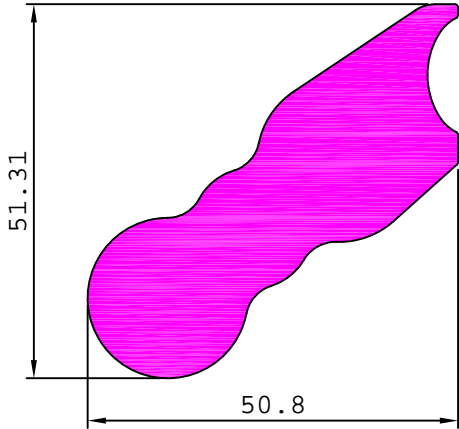

29122

2.019 kg/m

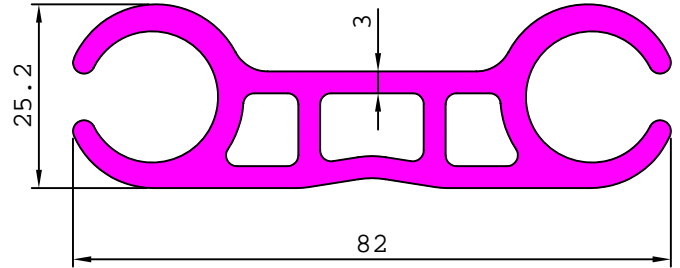

S4404

190.19

10.990 kg/m

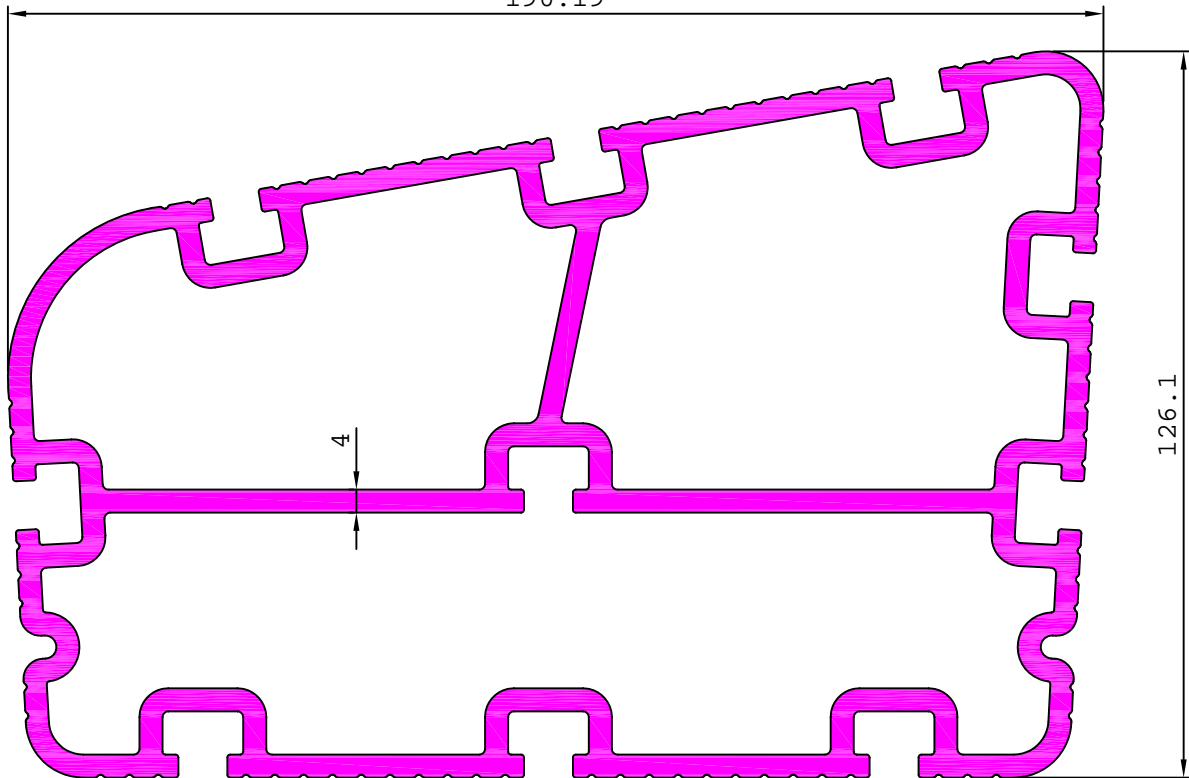

S5085

0.517 kg/m

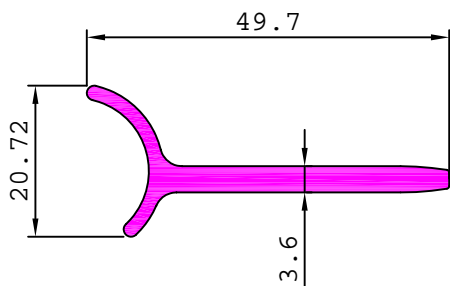

S5084

1.880 kg/m

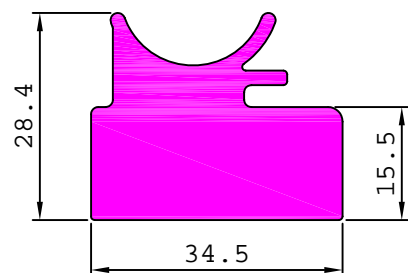

INDUSTRIAL

AUTOMOBILE SECTIONS

S5104

4.867 kg/m

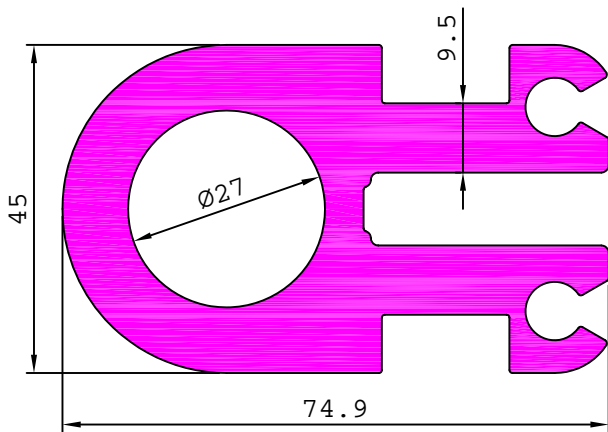

S5167

0.665 kg/m

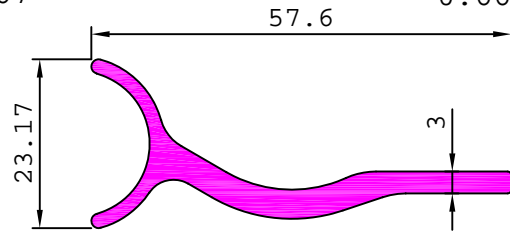

S5171

0.667 kg/m

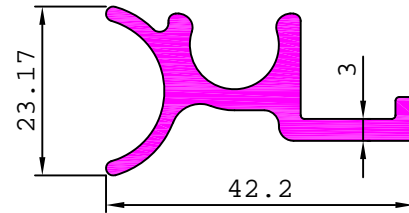

S5168

1.888 kg/m

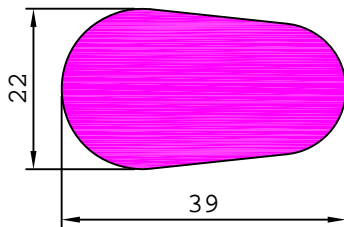

S5169

0.445 kg/m

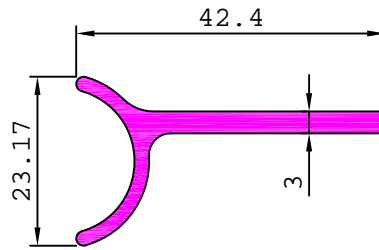

S5170

1.080 kg/m

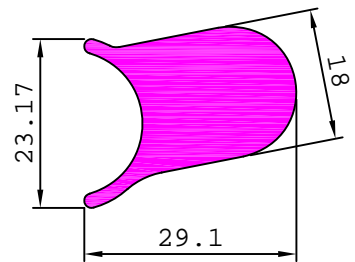

S5172

0.694 kg/m

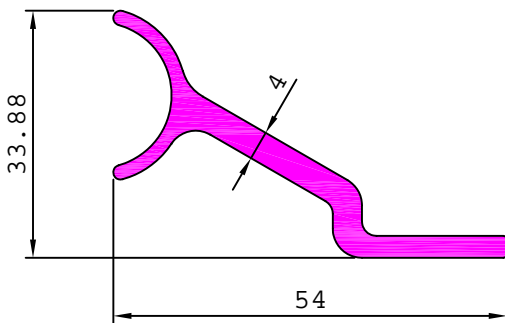

S5173

1.787 kg/m

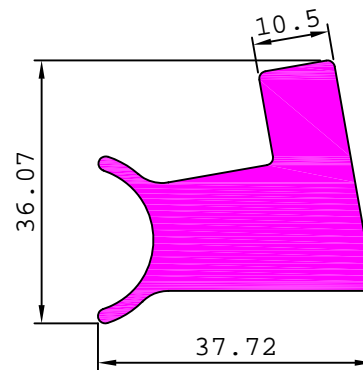

S5067

2.142 kg/m

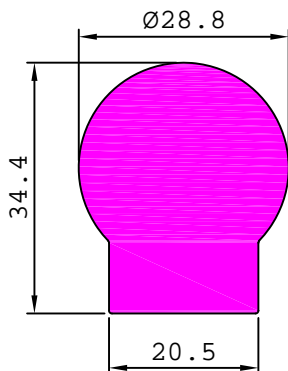

S5189

5.273 kg/m

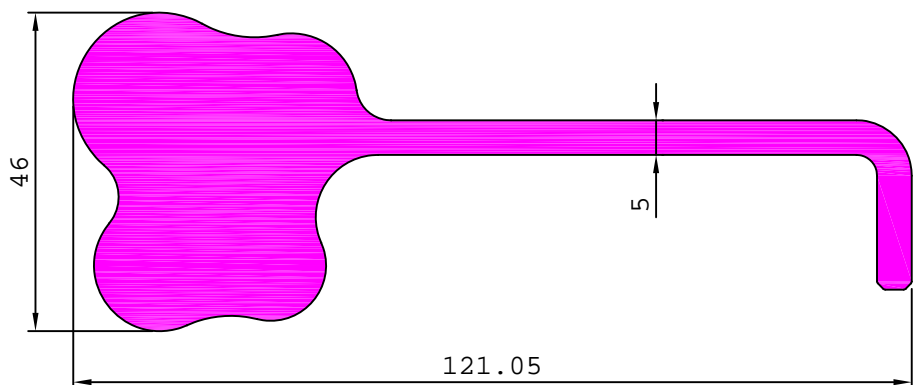

INDUSTRIAL

AUTOMOBILE SECTIONS

27860

10.506 kg/m

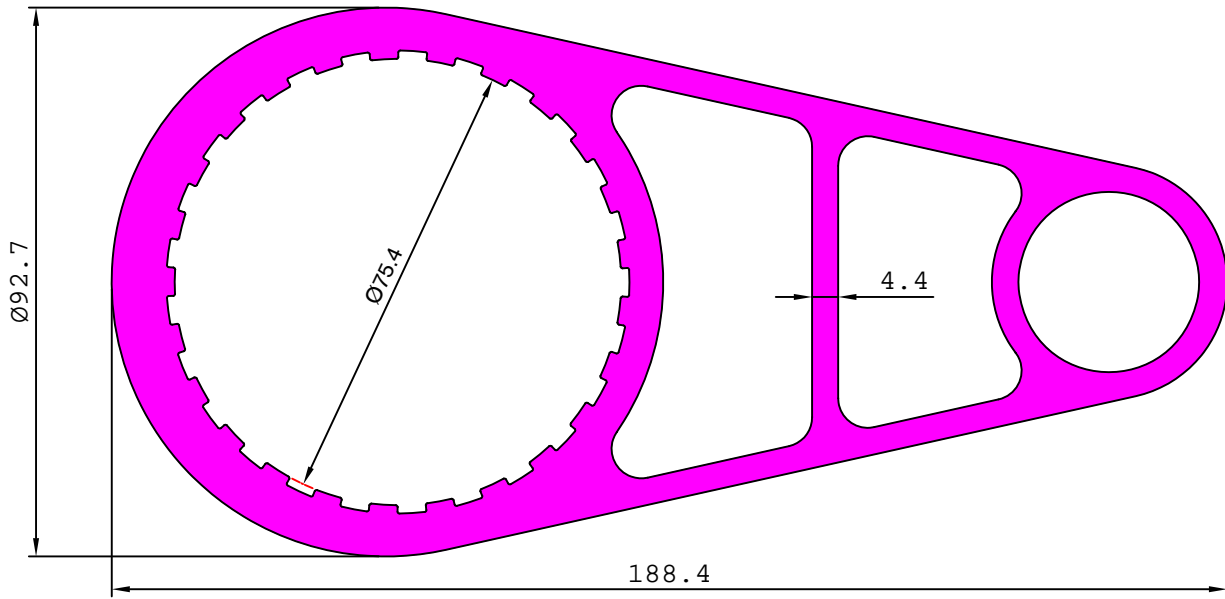

27893

9.279 kg/m

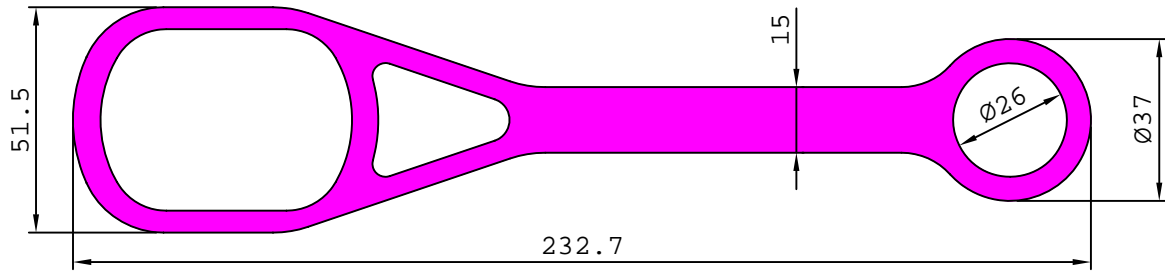

27894

13.445 kg/m

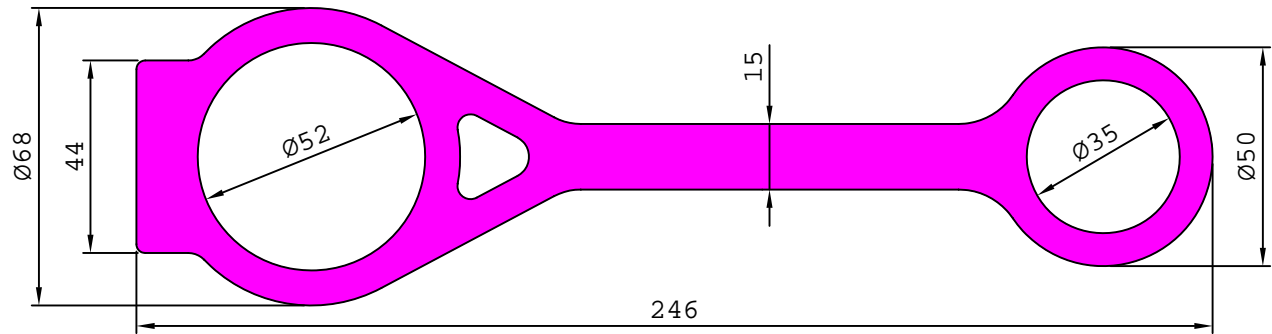

27897

8.293 kg/m

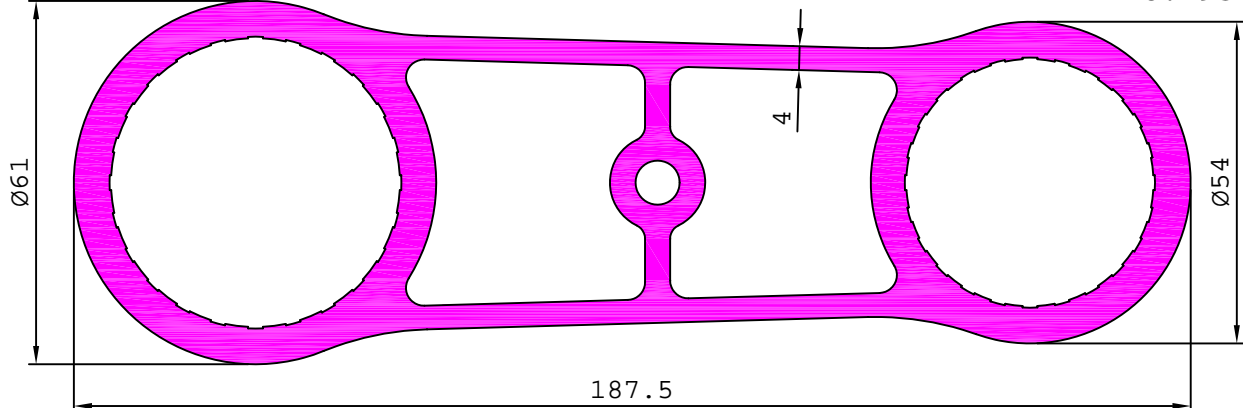

INDUSTRIAL

AUTOMOBILE SECTIONS

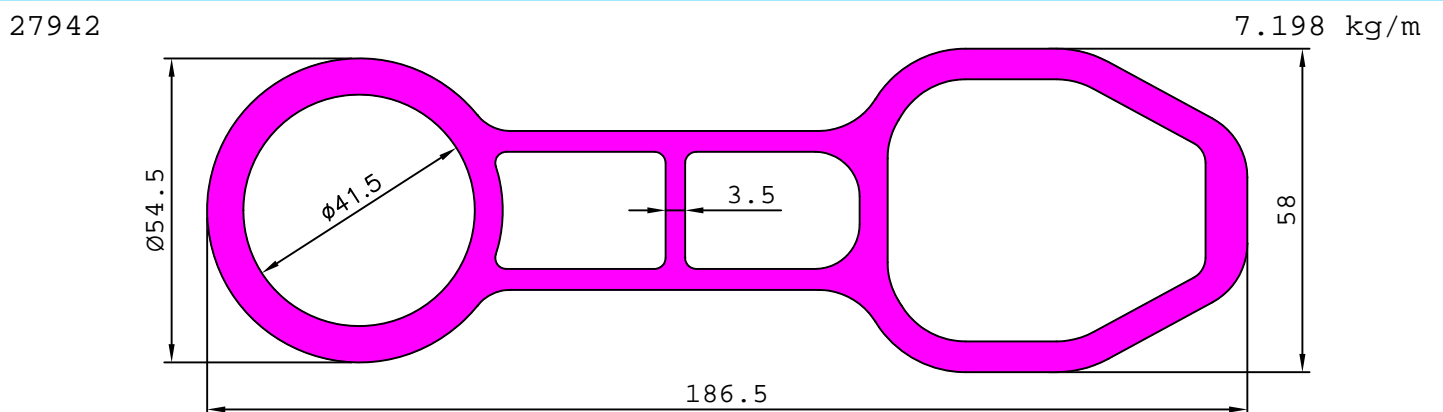
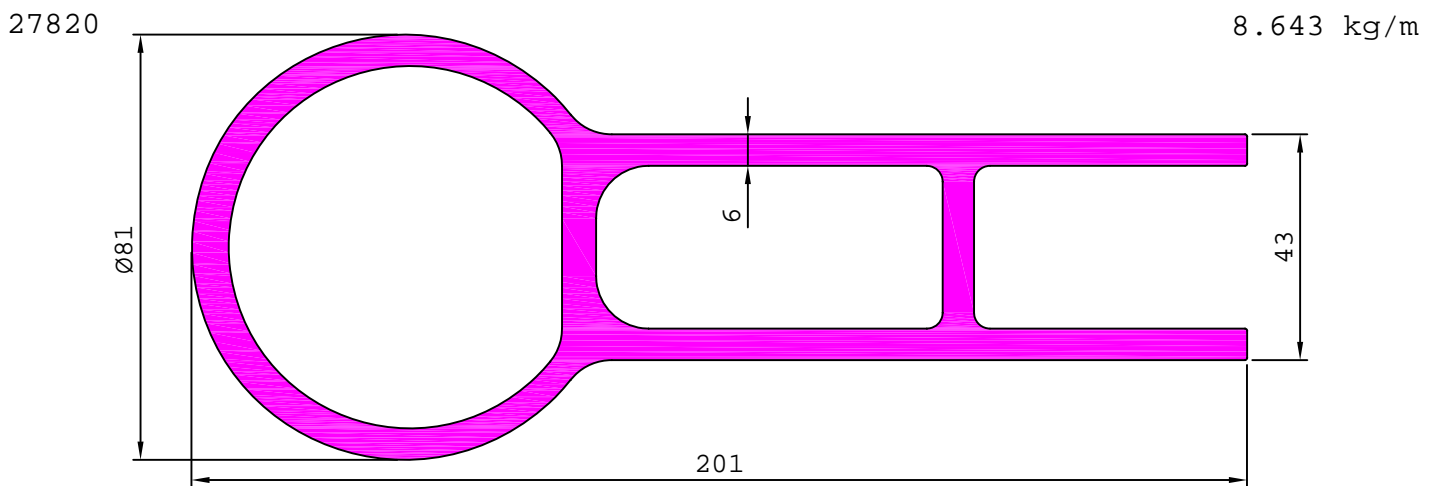
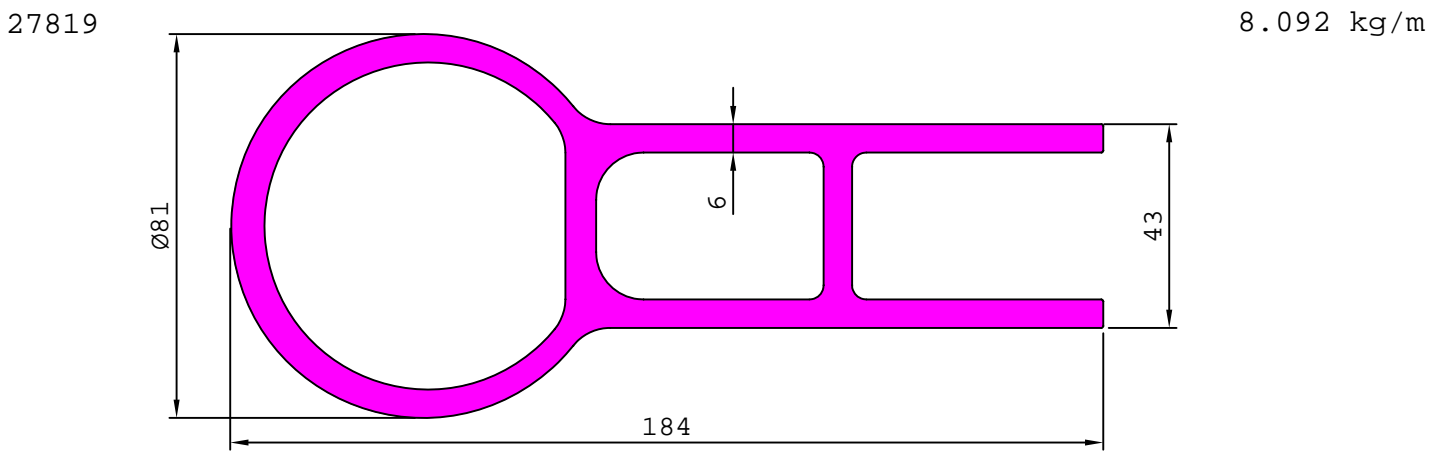
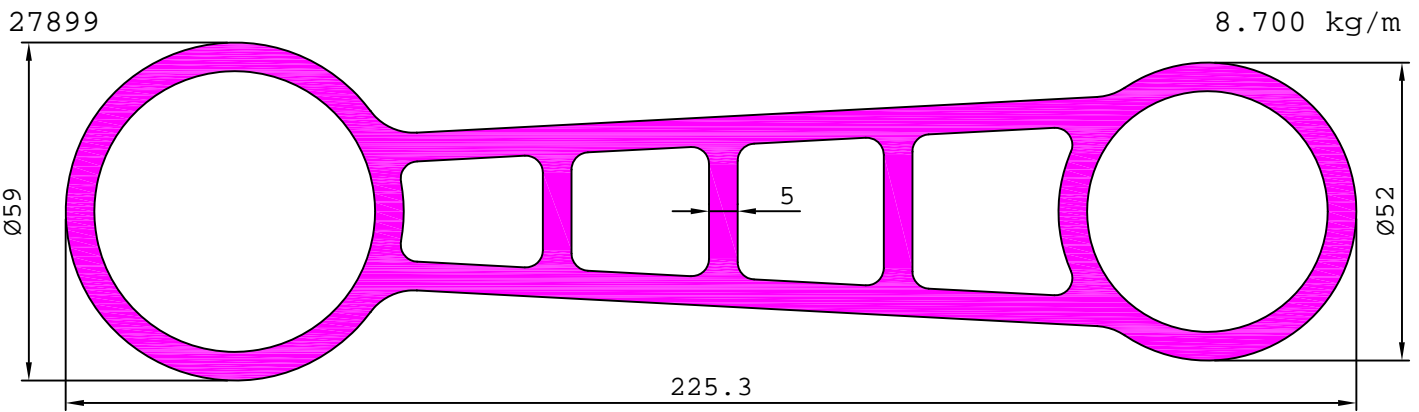

INDUSTRIAL

AUTOMOBILE SECTIONS

27981

14.844 kg/m

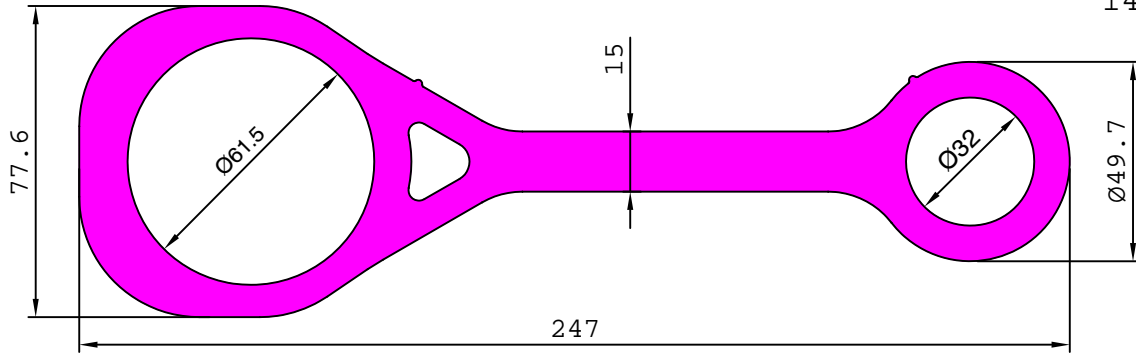

28018

8.423 kg/m

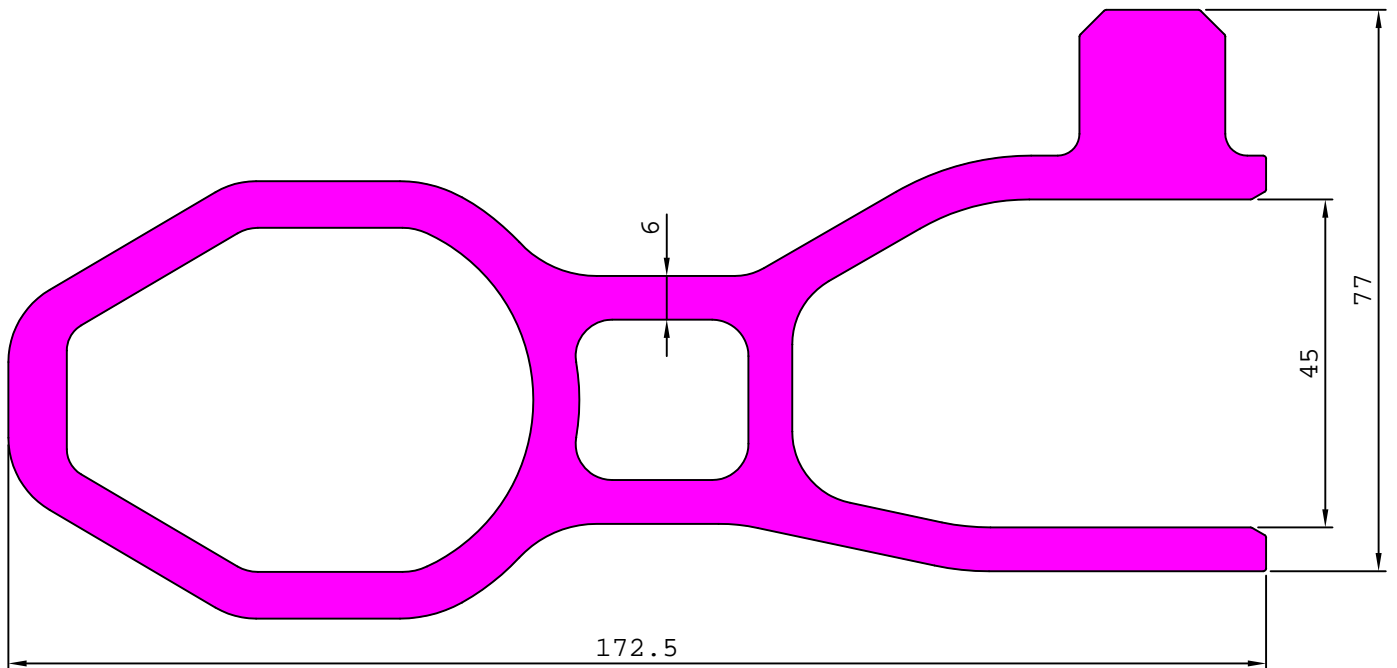

28034

13.496 kg/m

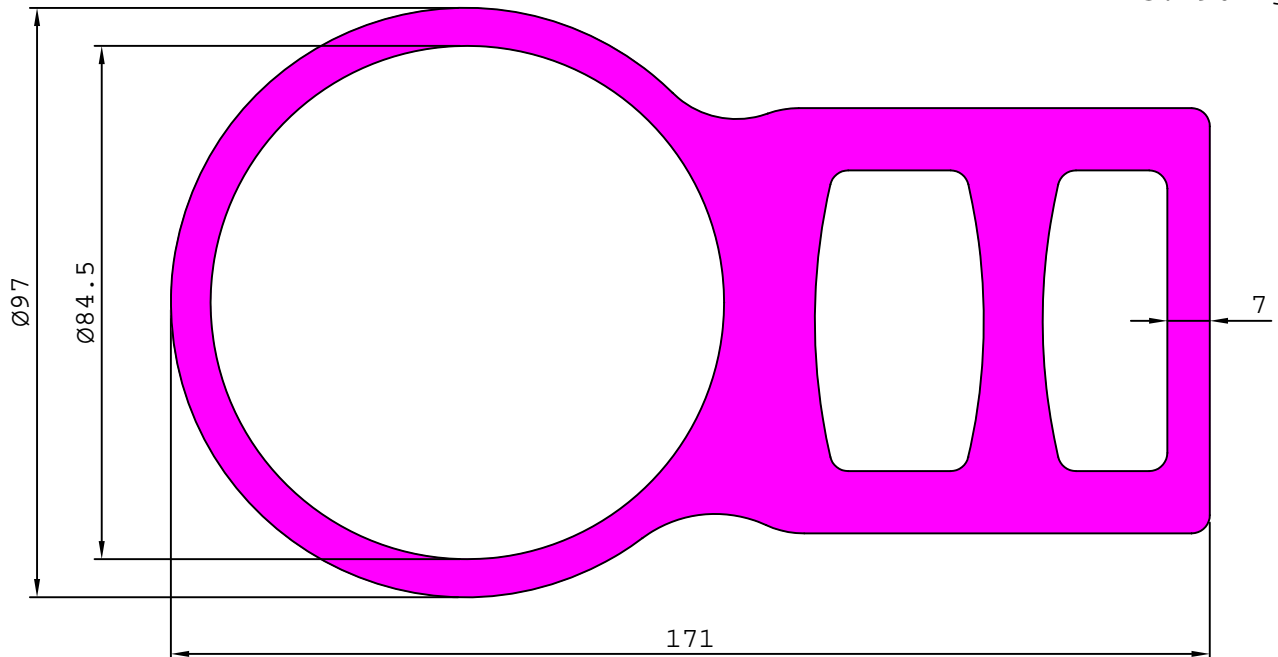

INDUSTRIAL

AUTOMOBILE SECTIONS

28030

8.370 kg/m

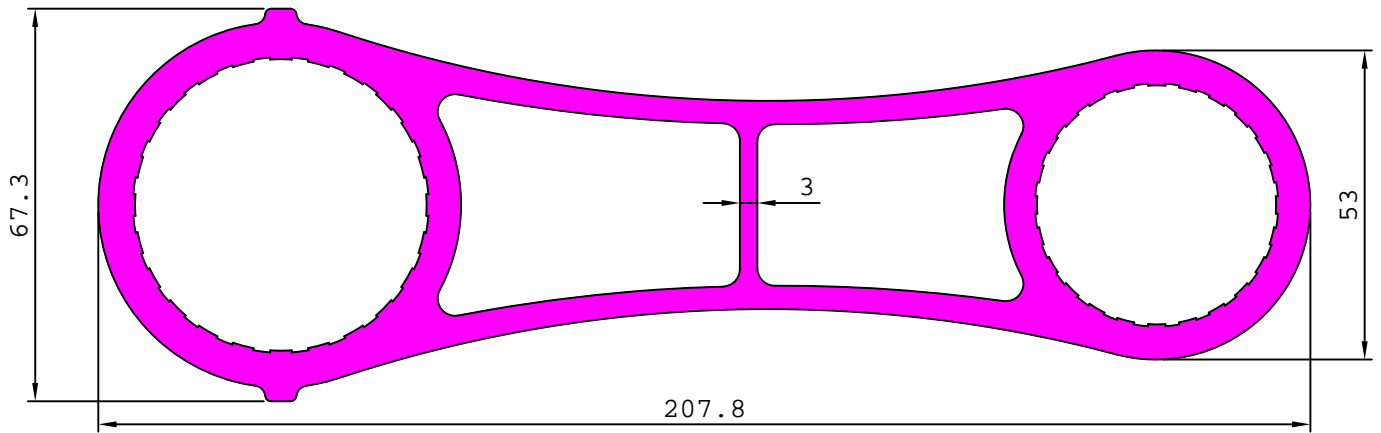

28032

14.882 kg/m

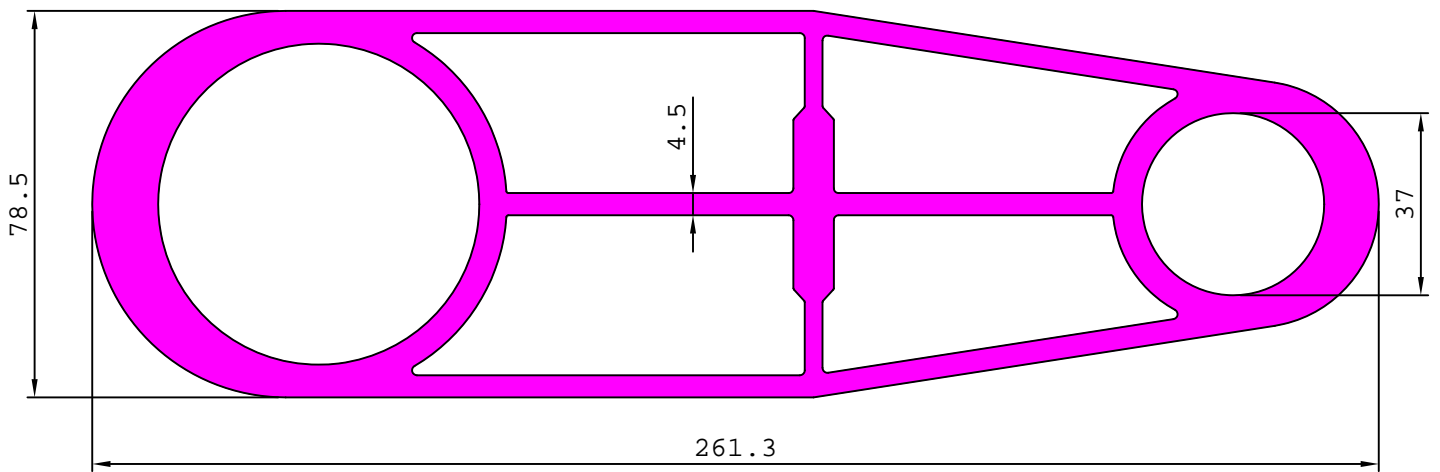

28135

10.799 kg/m

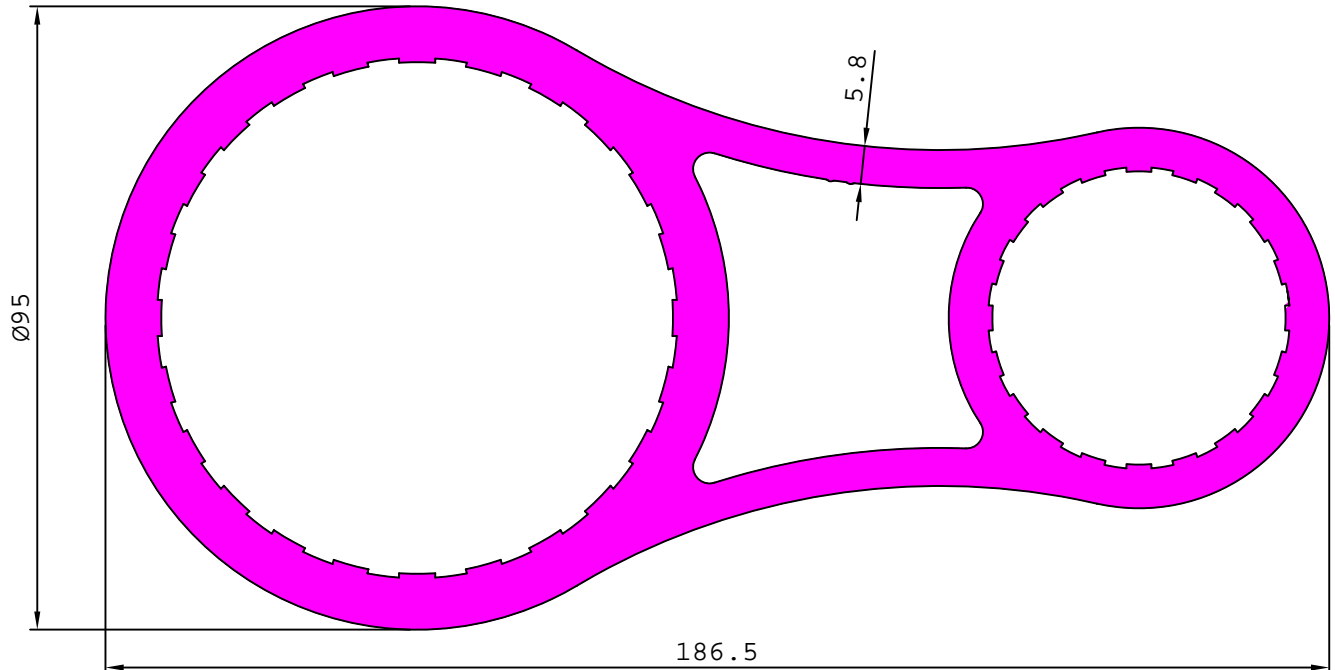

INDUSTRIAL

AUTOMOBILE SECTIONS

28040

9.371 kg/m

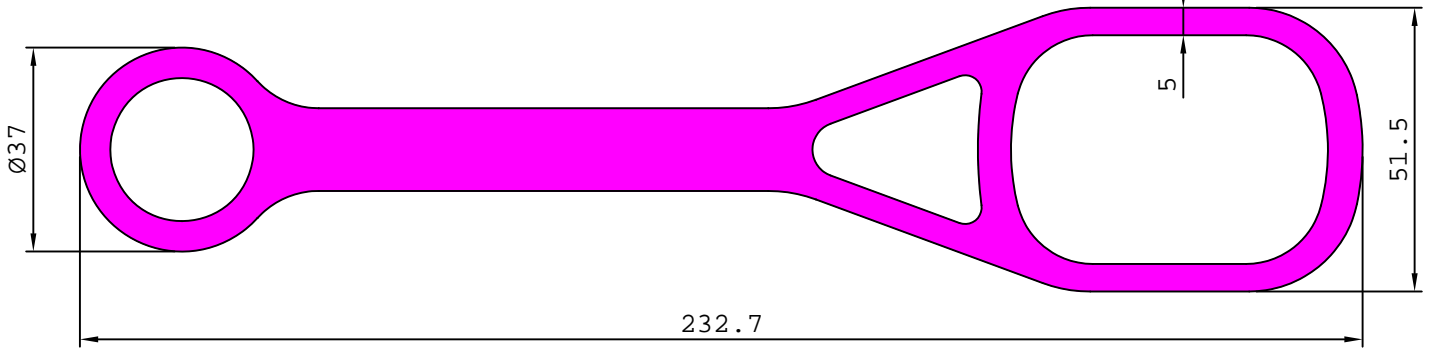

27945

7.272 kg/m

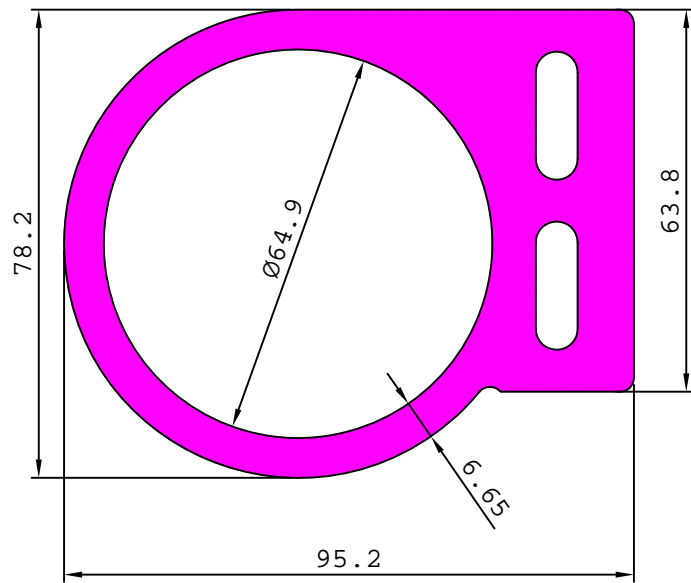

28212

9.137 kg/m

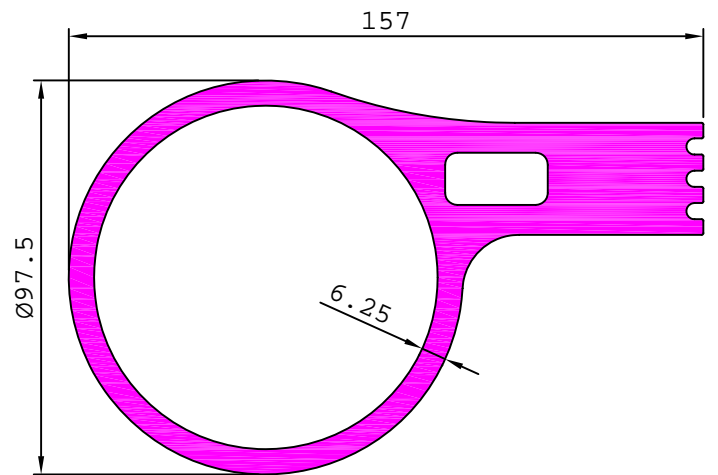

28183

9.129 kg/m

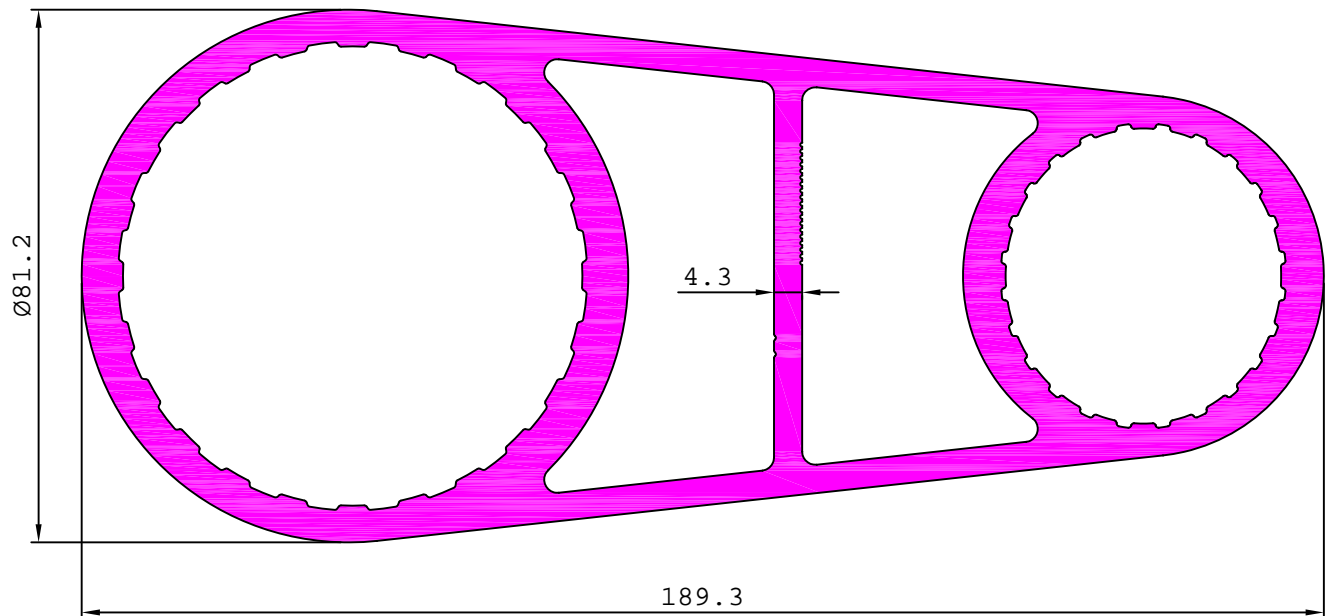

INDUSTRIAL

AUTOMOBILE SECTIONS

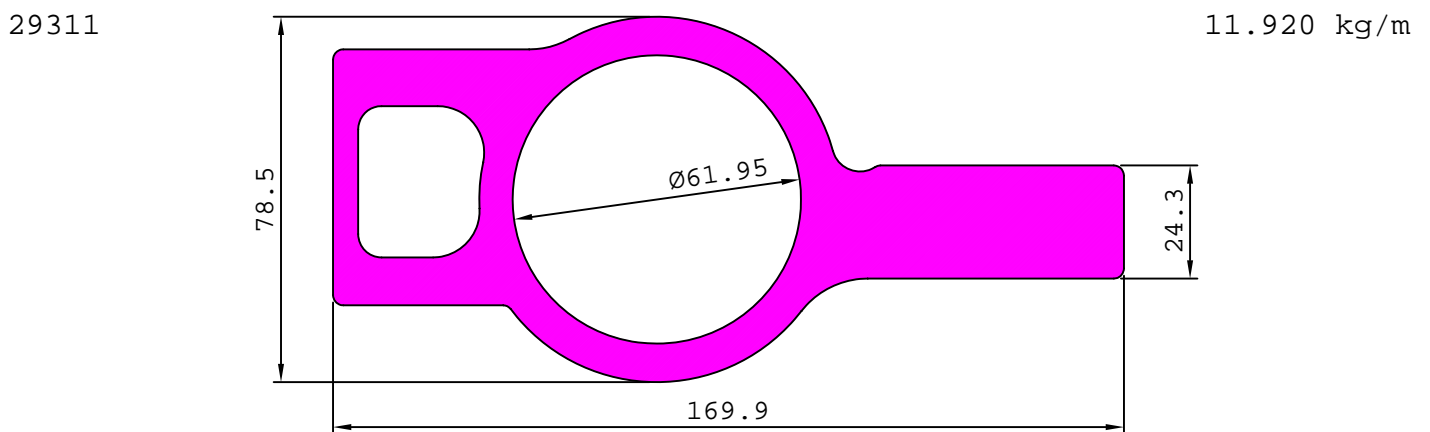
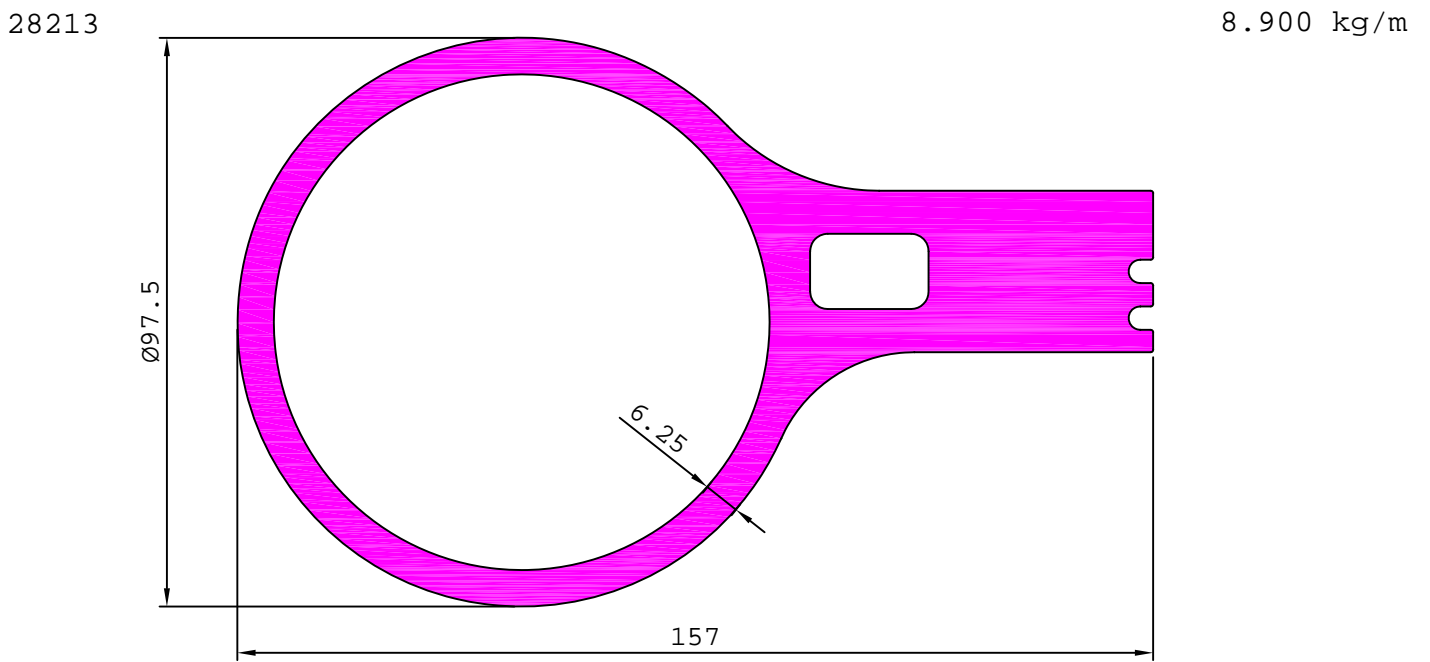
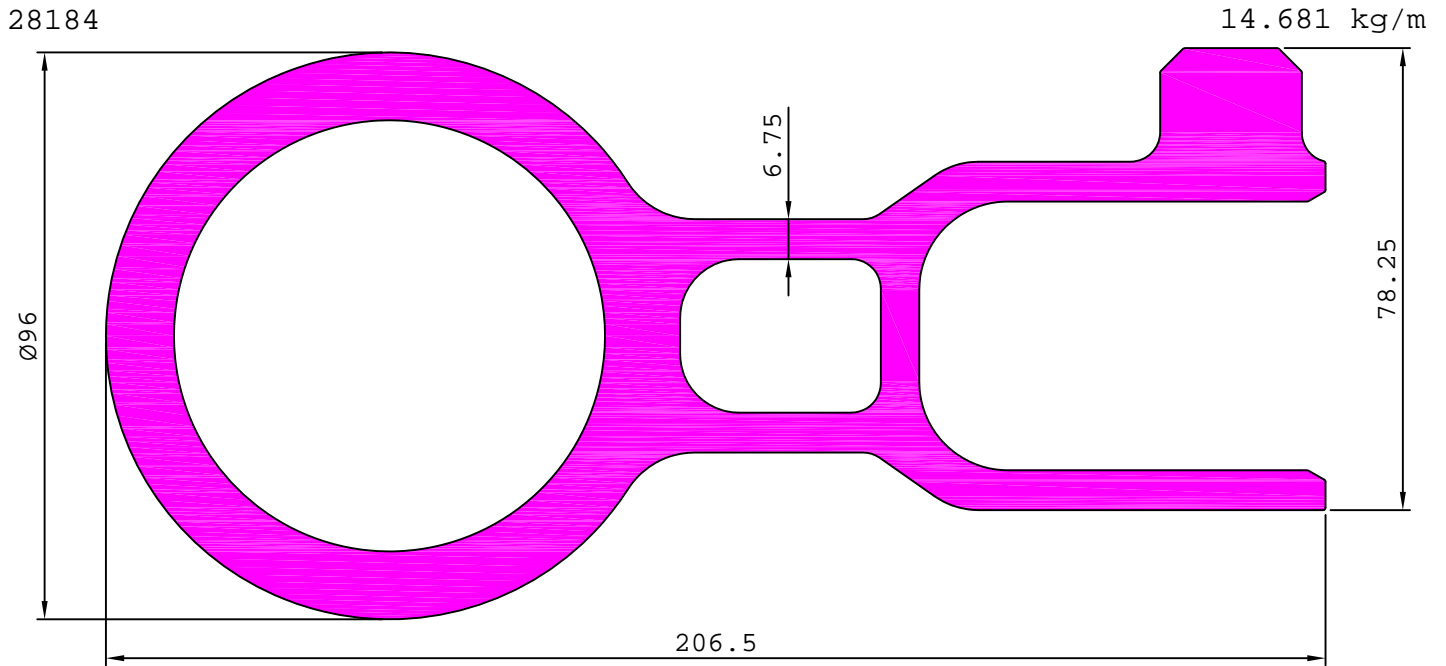

INDUSTRIAL

ELEVATOR SECTION

27456

1.547 kg/m

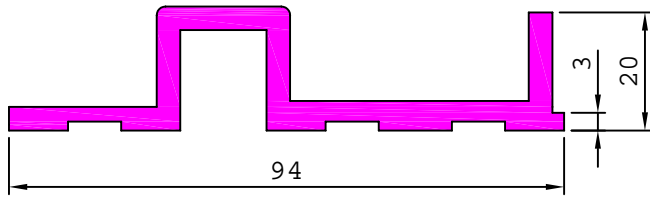

27461

1.888 kg/m

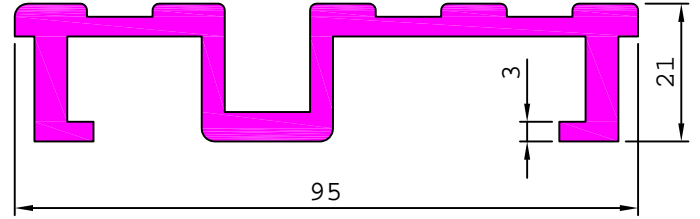

27607

3.997 kg/m

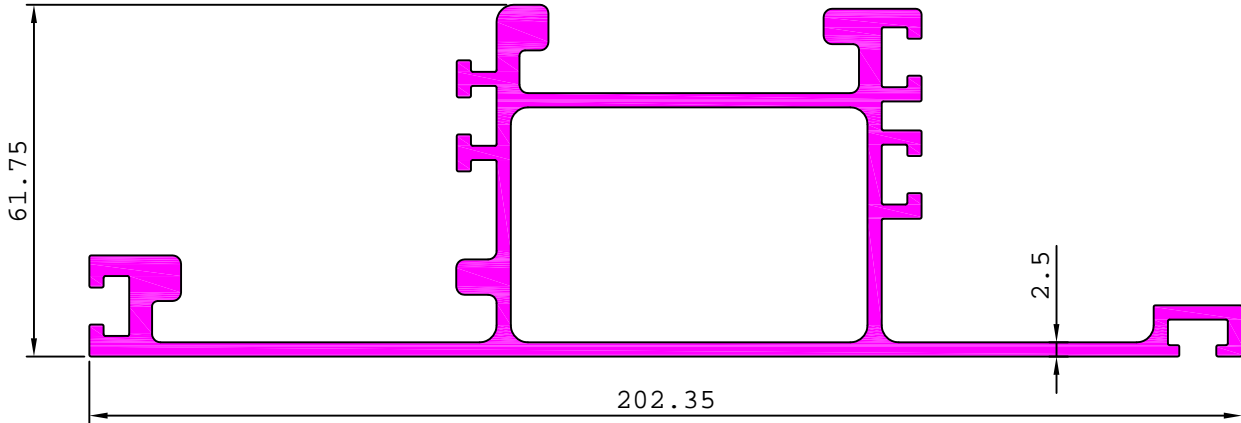

27608

2.795 kg/m

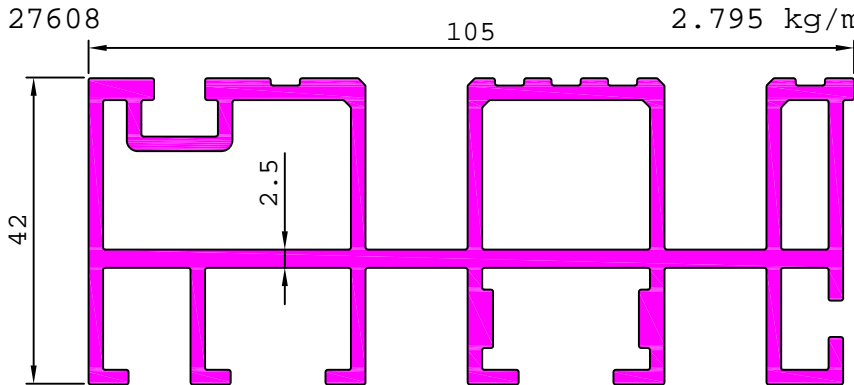

27609

2.168 kg/m

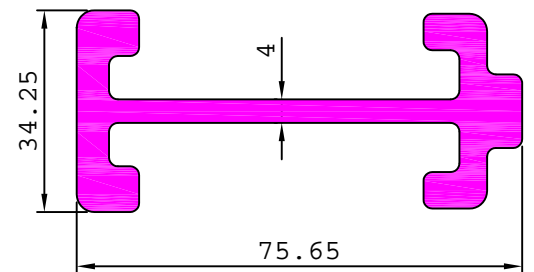

27642

0.478 kg/m

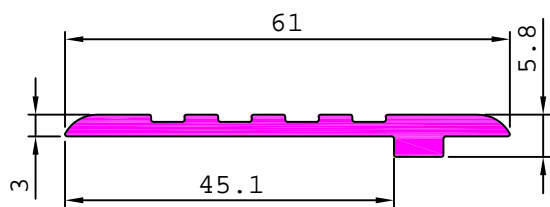

27659

1.703 kg/m

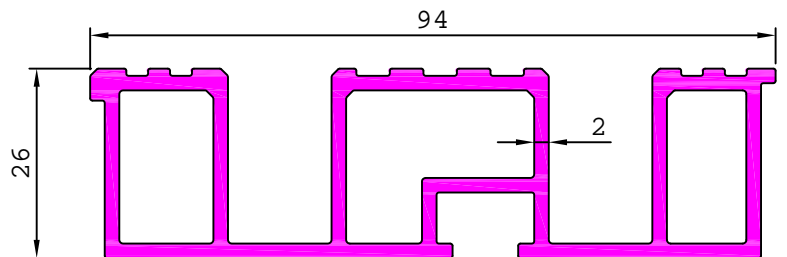

27824

0.299 kg/m

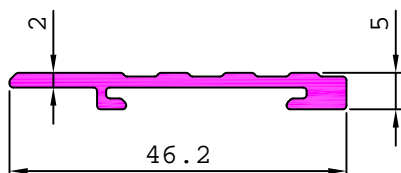

27826

0.197 kg/m

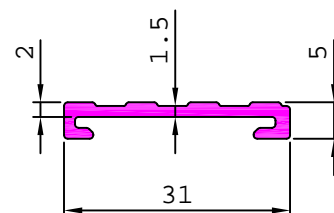

INDUSTRIAL

ELEVATOR SECTION

27681 0.463 kg/m

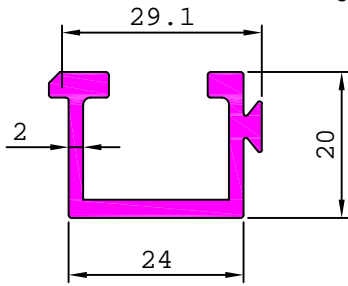

27821 2.642 kg/m

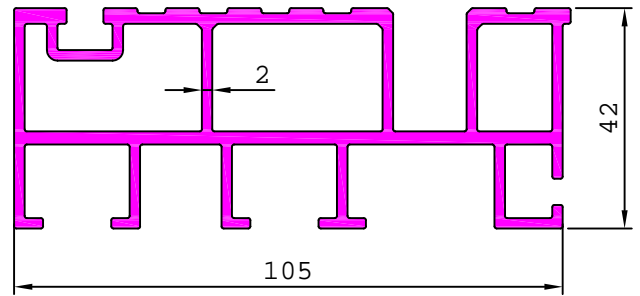

27822 3.140 kg/m

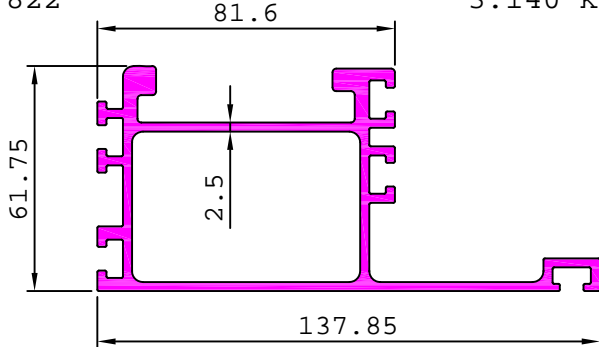

27823 0.919 kg/m

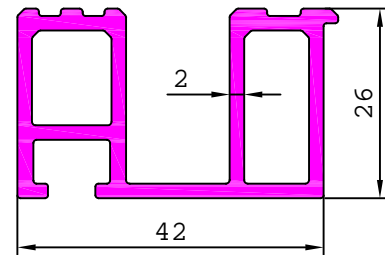

27903 1.651 kg/m

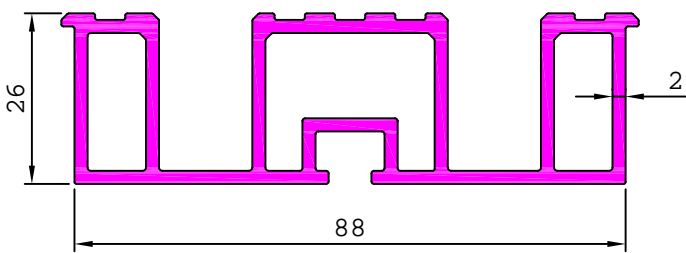

28270 1.592 kg/m

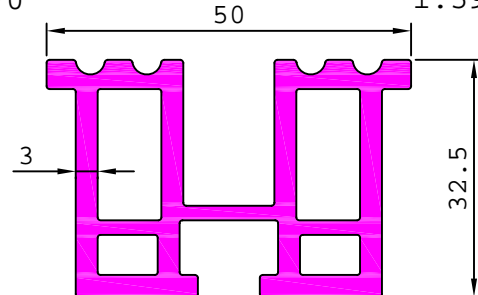

27825 1.258 kg/m

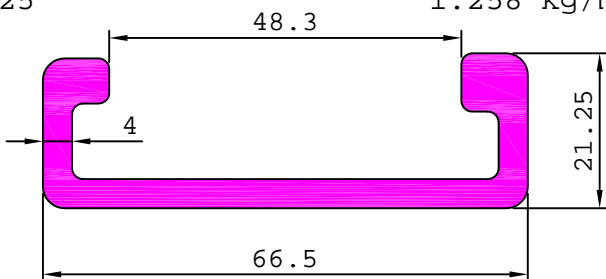

INDUSTRIAL

CONVEYOR SECTION

28601

0.532 kg/m

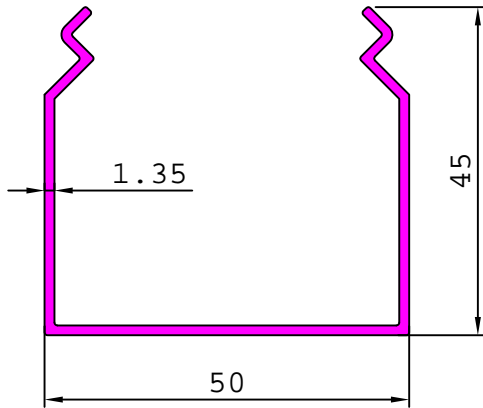

28602

0.284 kg/m

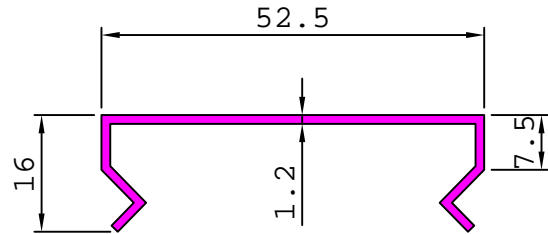

28603

3.495 kg/m

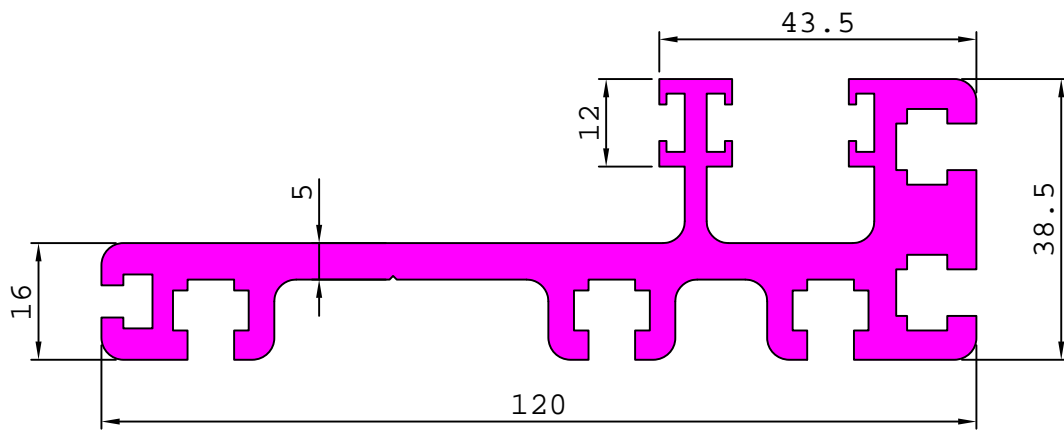

28604

1.394 kg/m

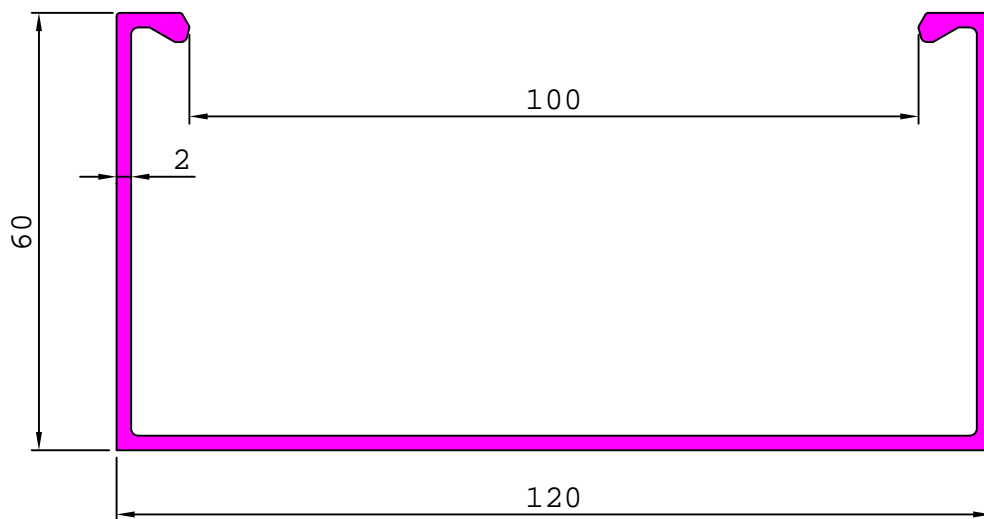

28605

0.830 kg/m

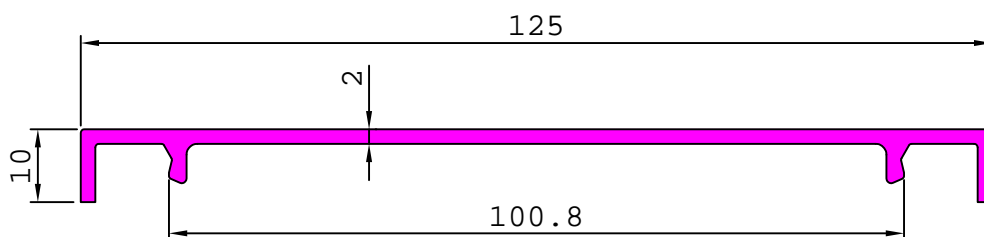

INDUSTRIAL

CONVEYOR SECTION

28606 3.856 kg/m

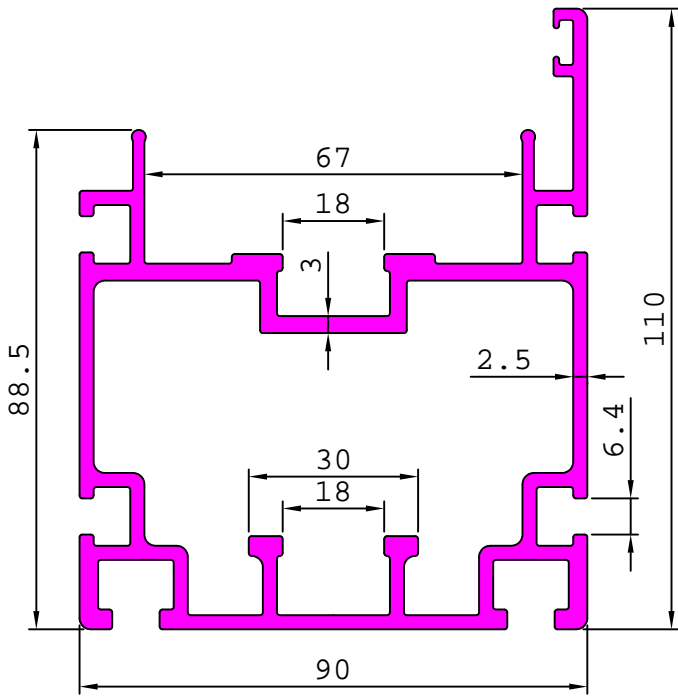

28609 3.615 kg/m

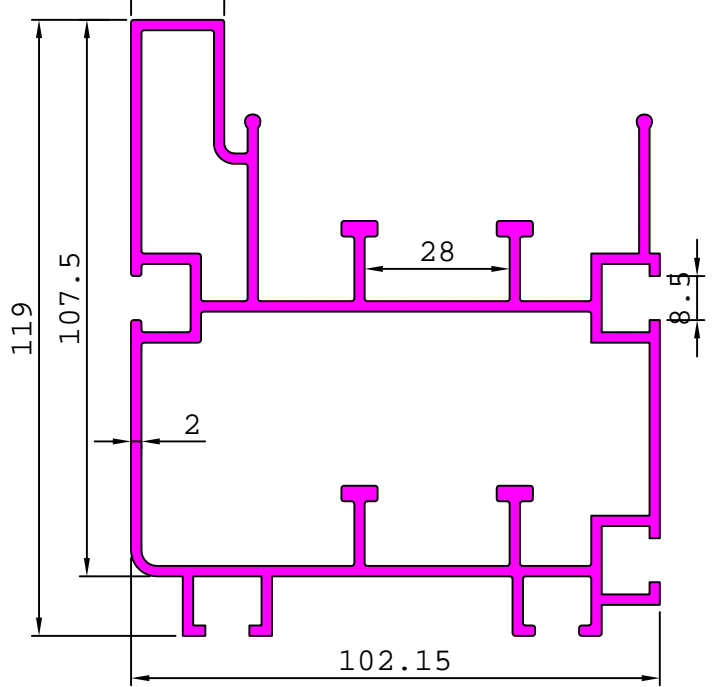

28608

3.057 kg/m

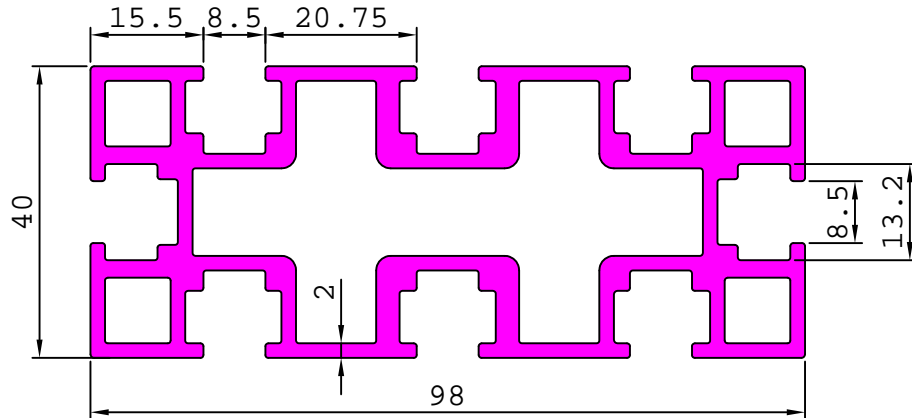

28614

4.300 kg/m

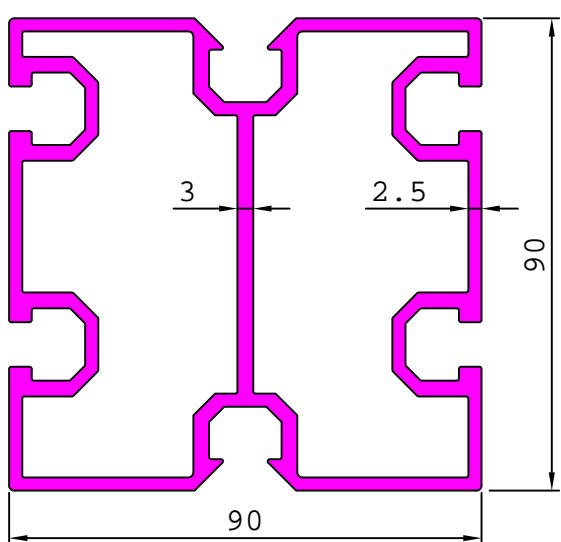

28615

5.360 kg/m

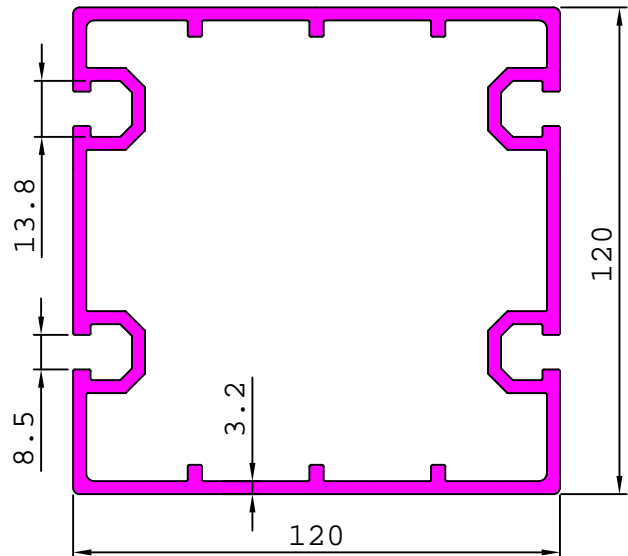

INDUSTRIAL

CONVEYOR SECTION

28611 3.096 kg/m

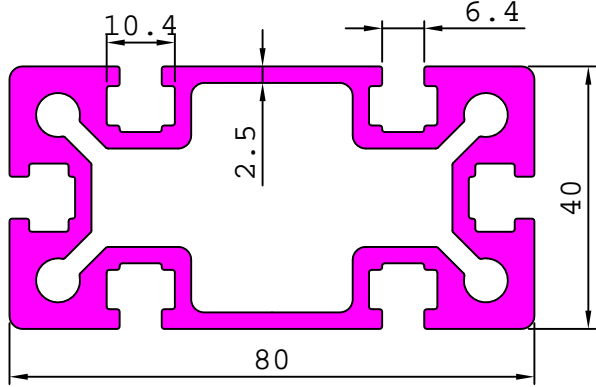

28612 1.298 kg/m

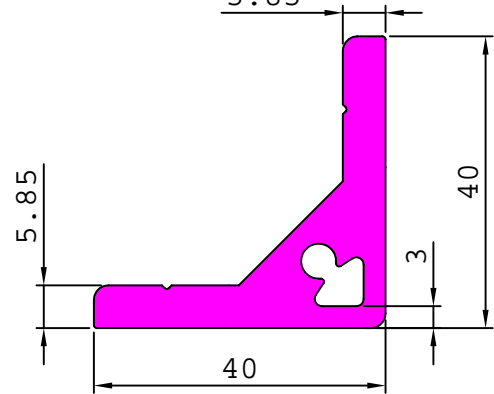

28616 2.648 kg/m

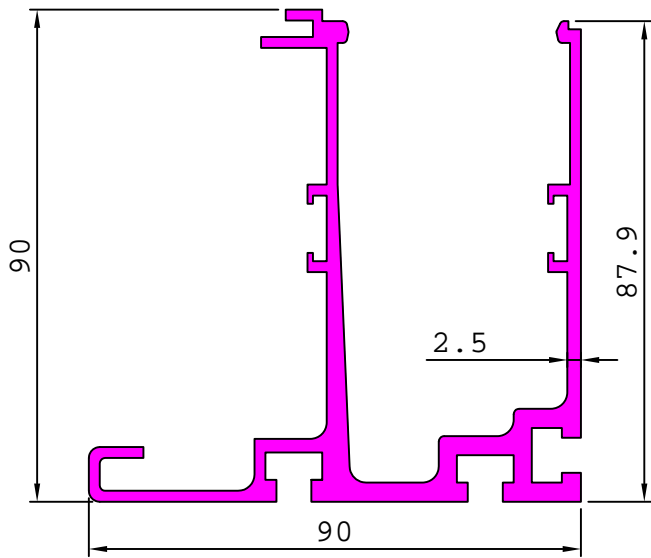

28620 1.070 kg/m

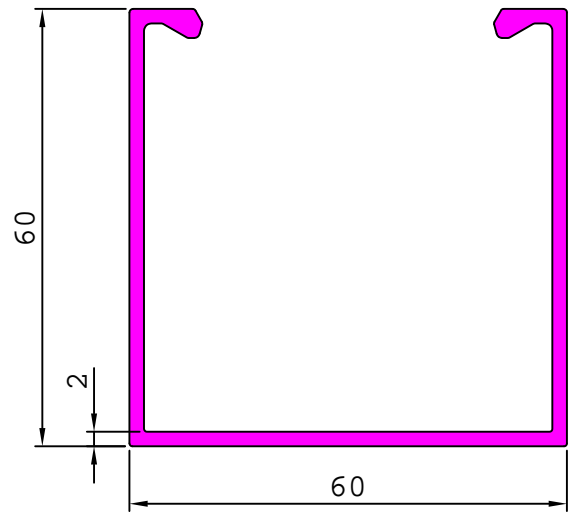

28617 0.226 kg/m

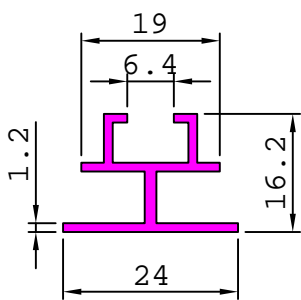

28618 1.733 kg/m

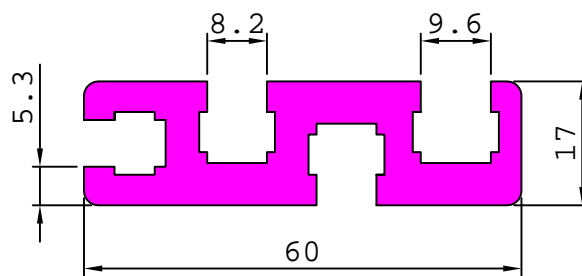

28619 1.506 kg/m

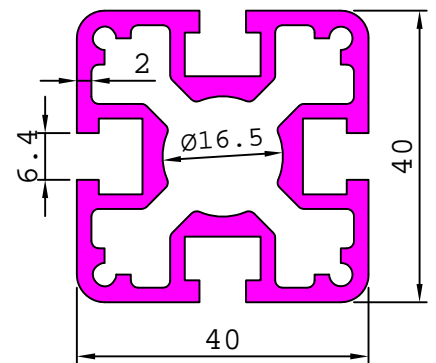

28621 0.504 kg/m

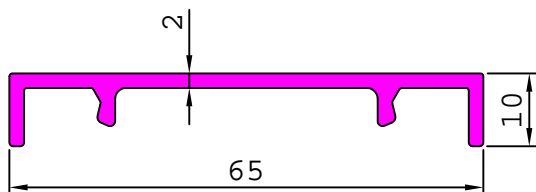

28634 1.899 kg/m

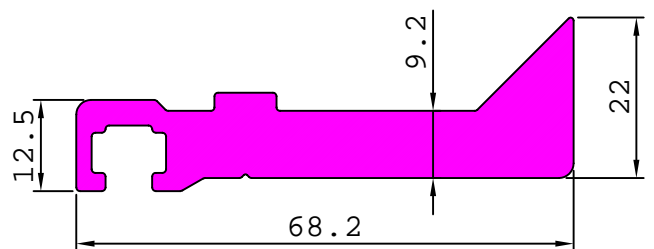

INDUSTRIAL

CONVEYOR SECTION

28622 3.878 kg/m

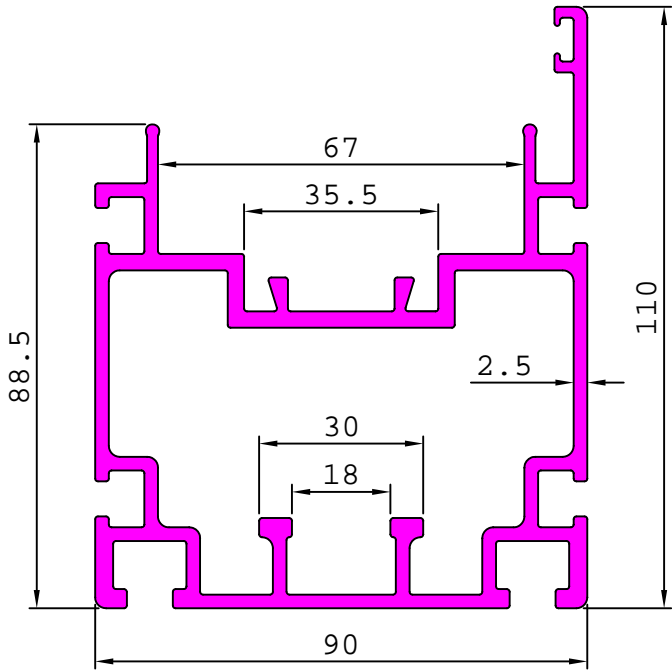

28623 5.953 kg/m

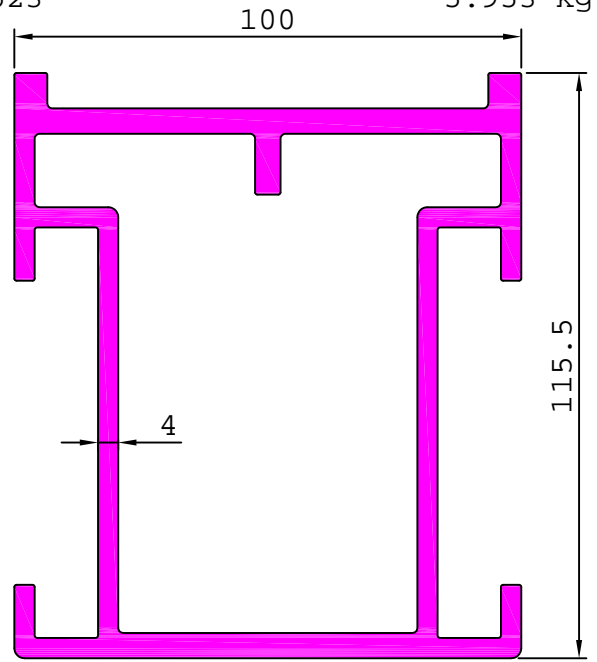

28626 6.119 kg/m

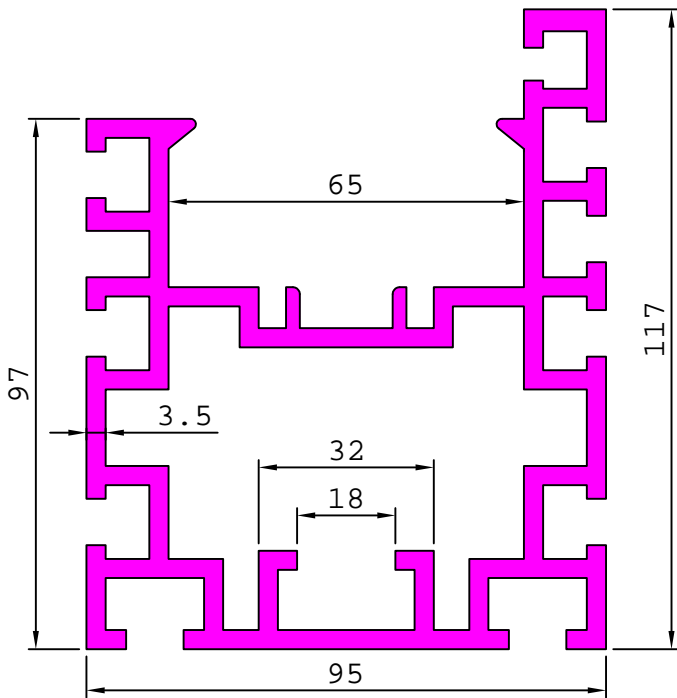

28627 4.094 kg/m

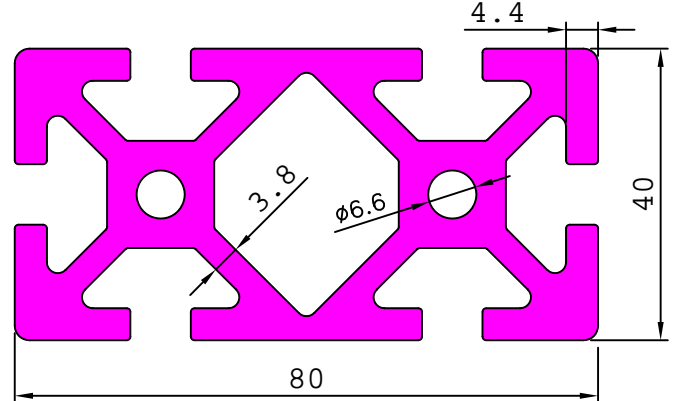

28628 1.553 kg/m

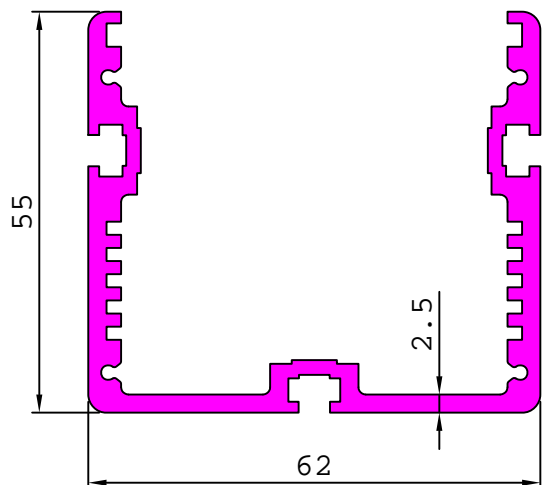

28632 0.997 kg/m

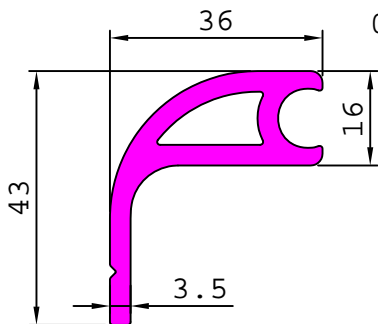

INDUSTRIAL

CONVEYOR SECTION

28630

7.368 kg/m

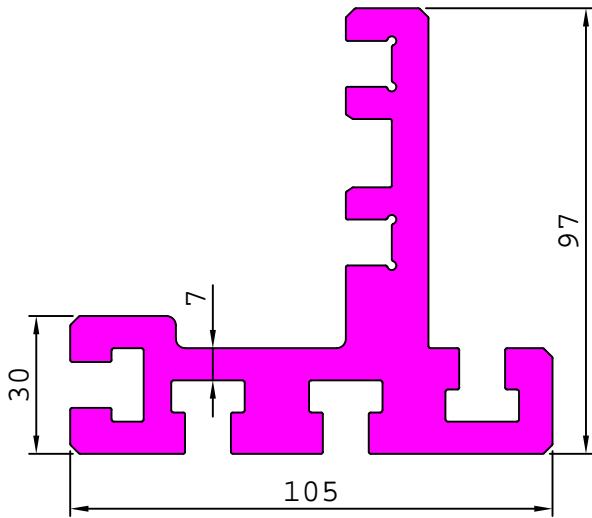

28631

5.942 kg/m

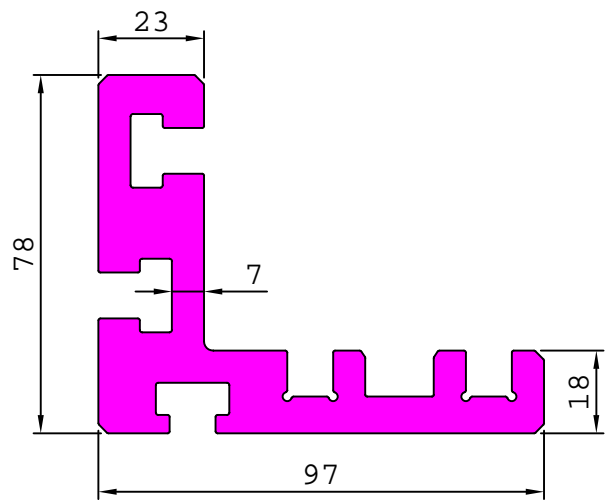

28633

2.631 kg/m

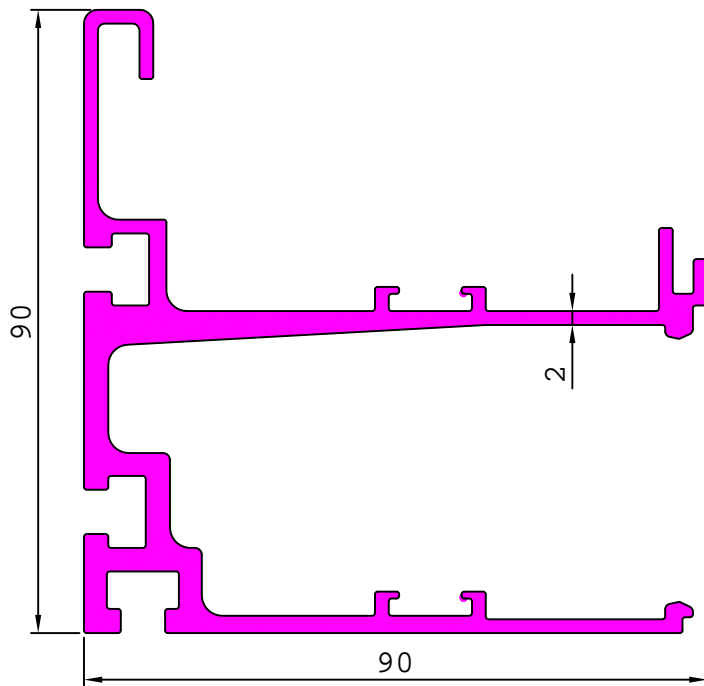

28635

7.717 kg/m

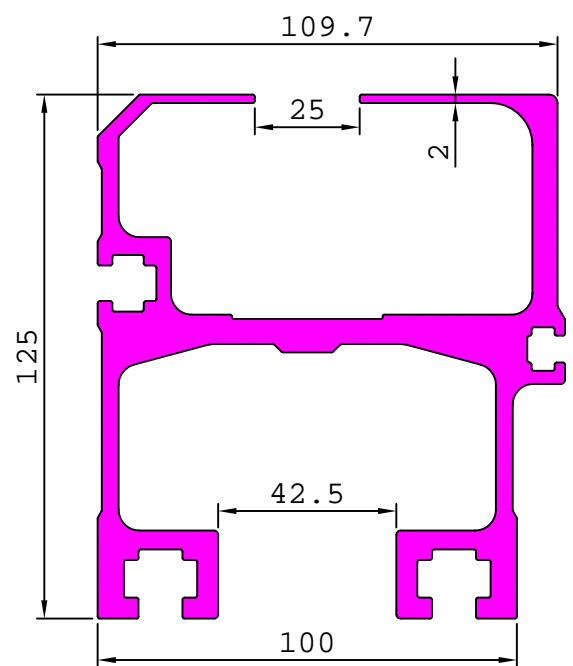

28636

2.124 kg/m

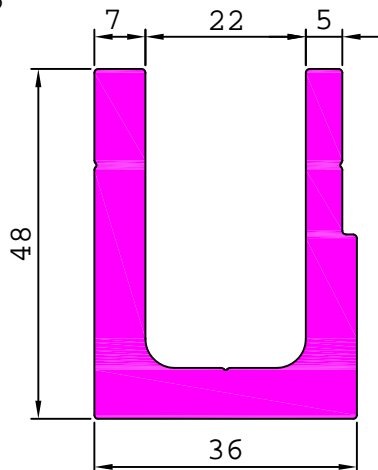

28638

1.964 kg/m

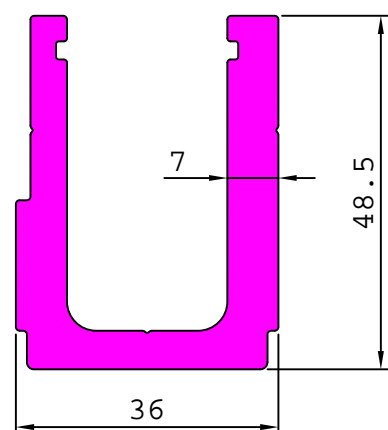

INDUSTRIAL

CONVEYOR SECTION

28637

0.986 kg/m

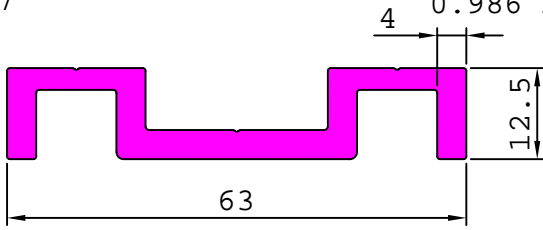

28641

0.657 kg/m

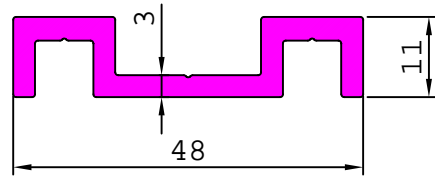

28639

7.483 kg/m

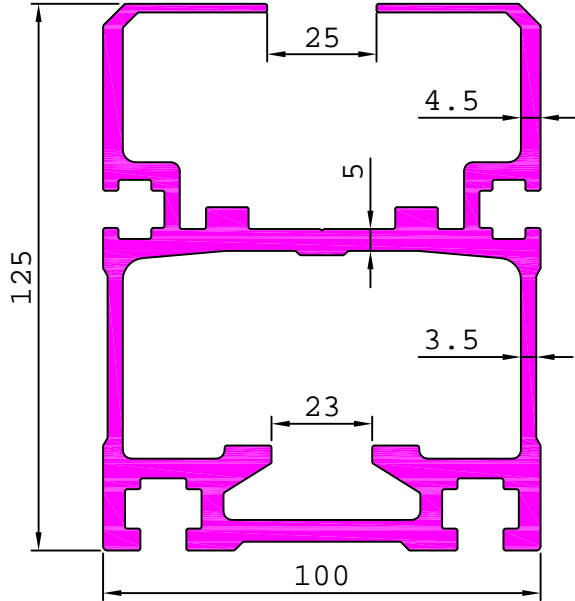

28640

4.480 kg/m

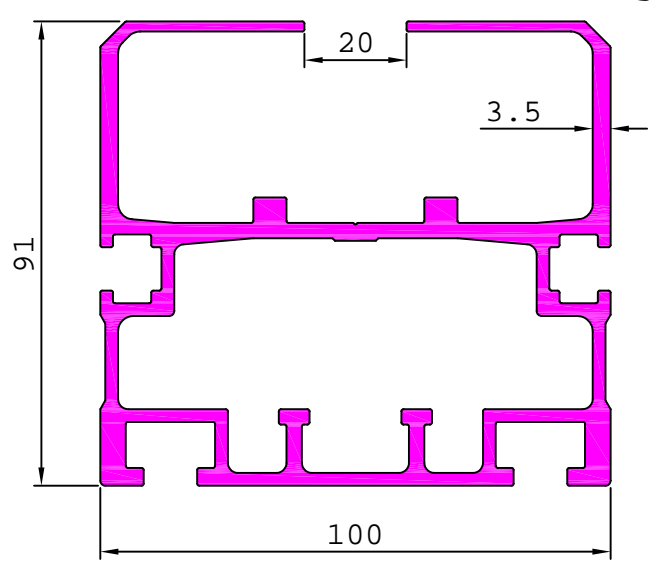

28642

6.012 kg/m

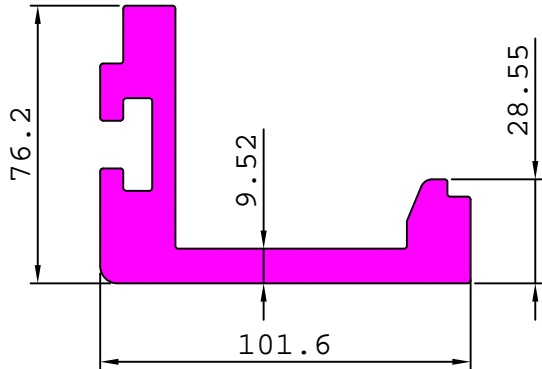

28643

0.703 kg/m

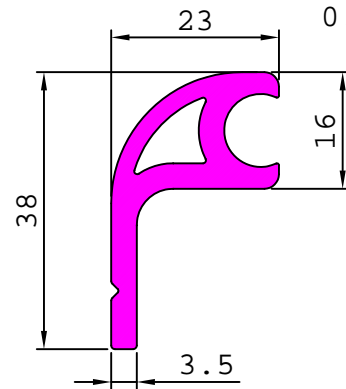

28644

7.972 kg/m

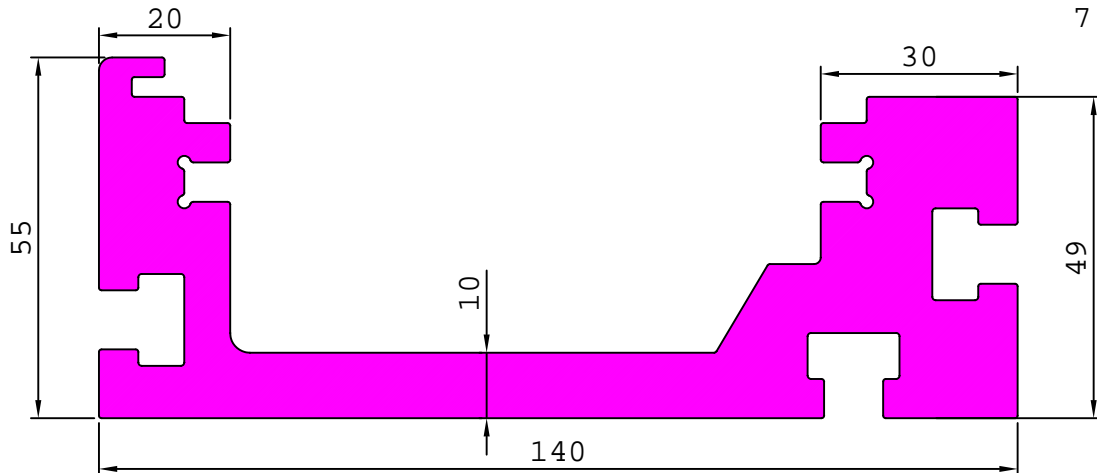

INDUSTRIAL

CONVEYOR SECTION

28645 3.677 kg/m

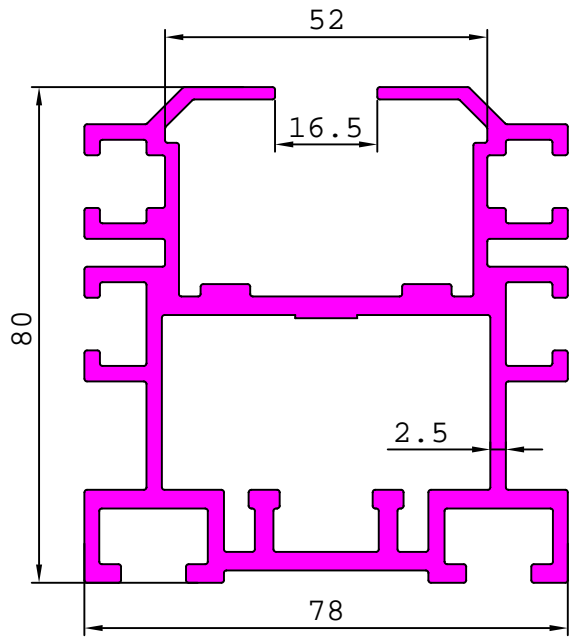

28647 5.329 kg/m

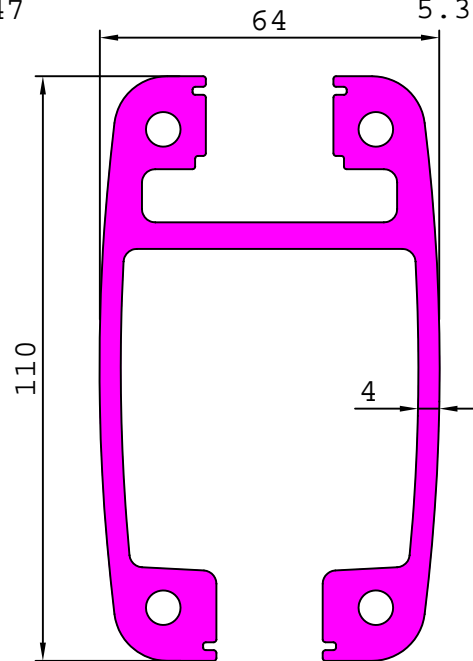

28650 6.982 kg/m

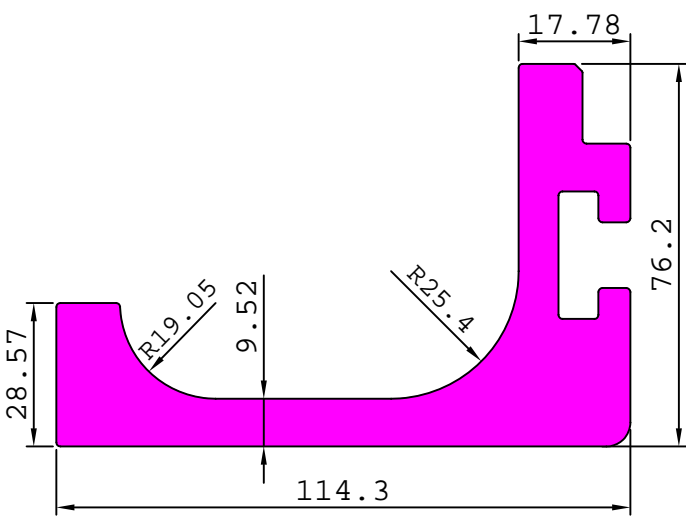

28648 4.957 kg/m

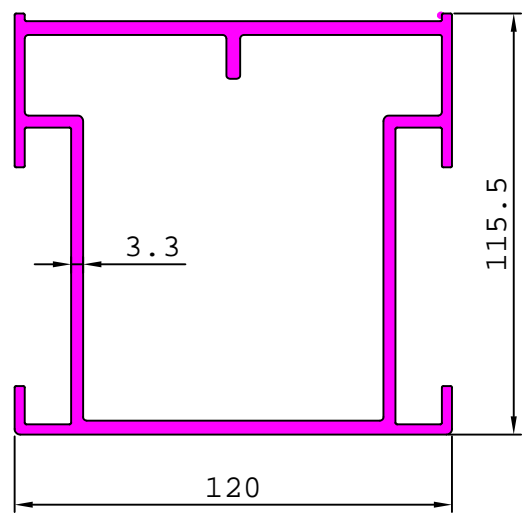

28649 12.173 kg/m

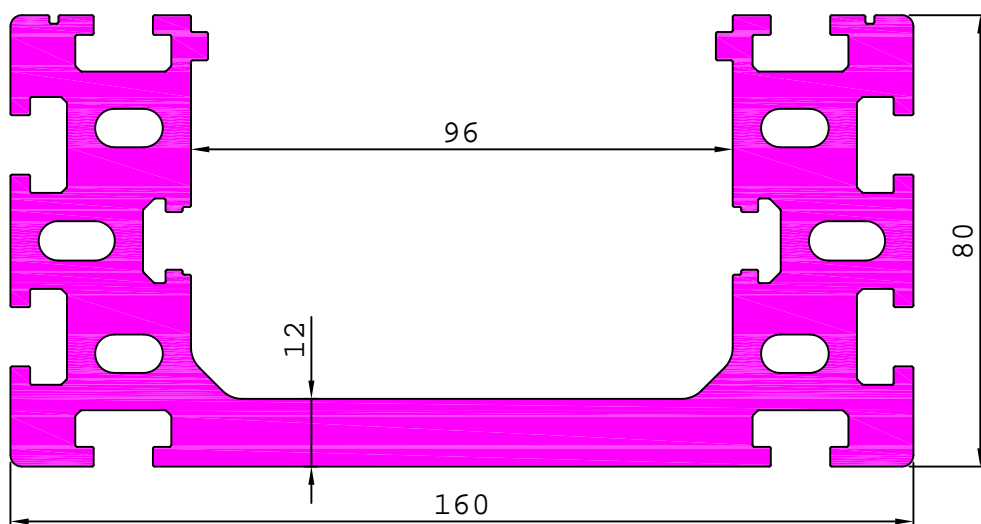

INDUSTRIAL

CONVEYOR SECTION

28646 0.421 kg/m

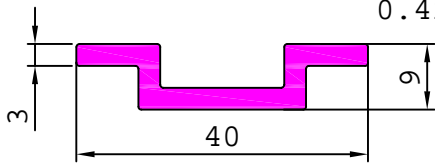

28652 5.647 kg/m

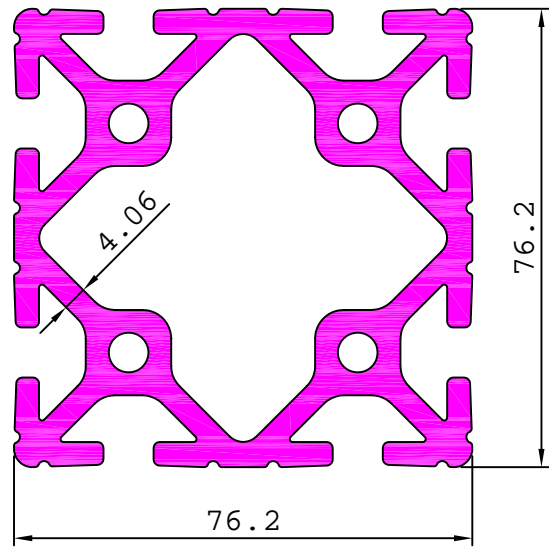

28651 1.575 kg/m

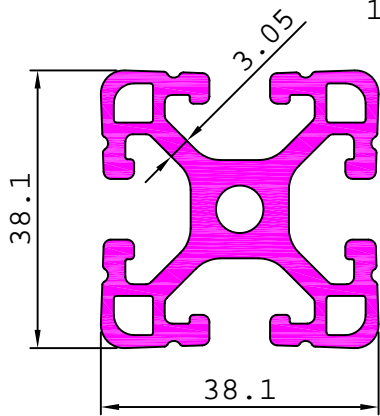

28653 5.775 kg/m

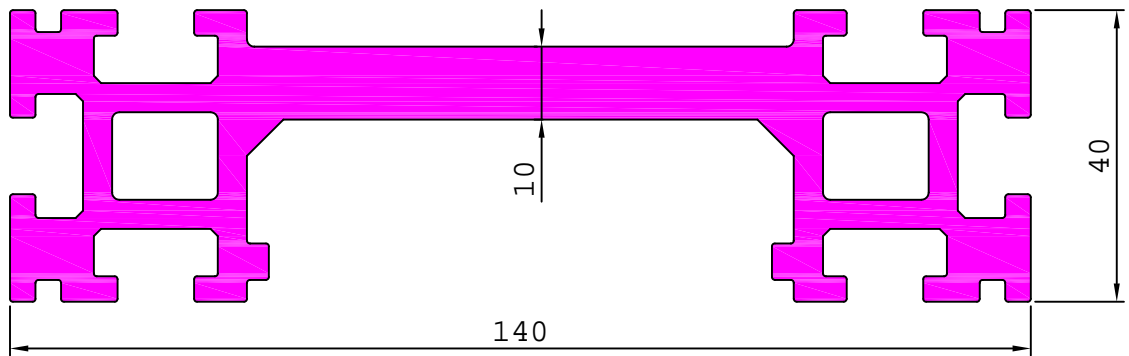

28656 6.205 kg/m

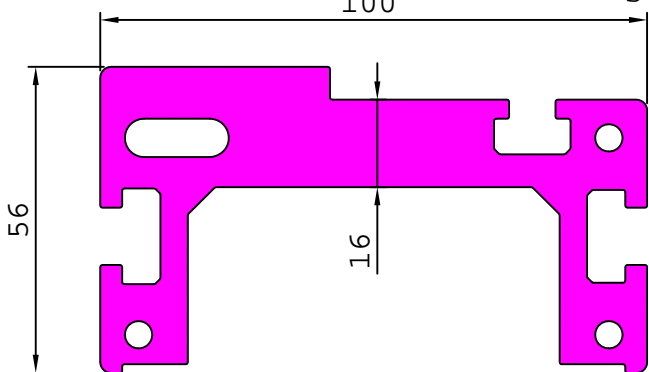

28657 4.883 kg/m

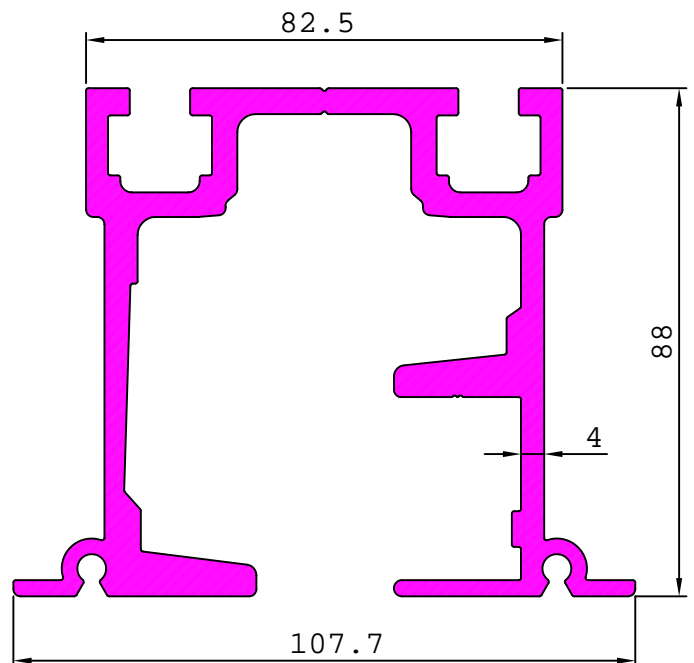

29466 0.425 kg/m

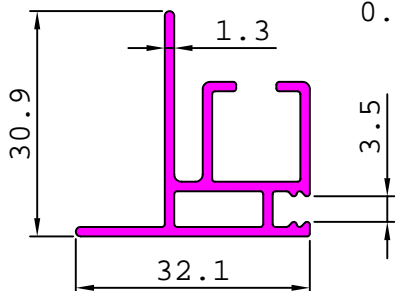

INDUSTRIAL

CONVEYOR SECTION

28658

3.973 kg/m

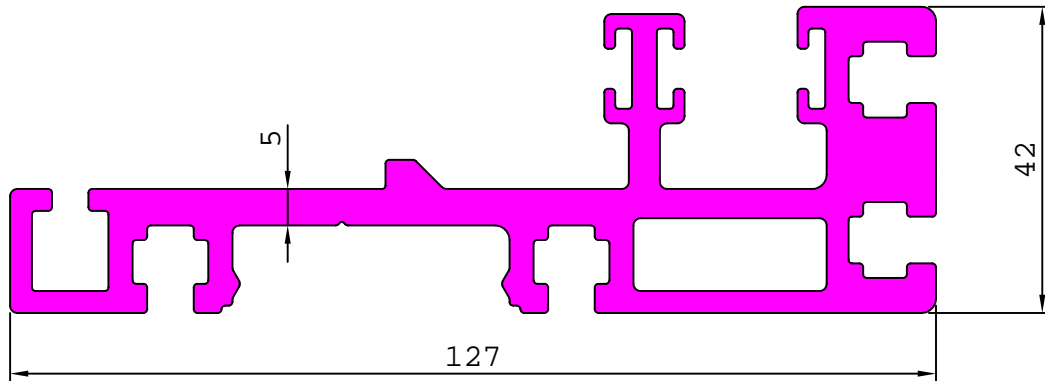

28659

10.541 kg/m

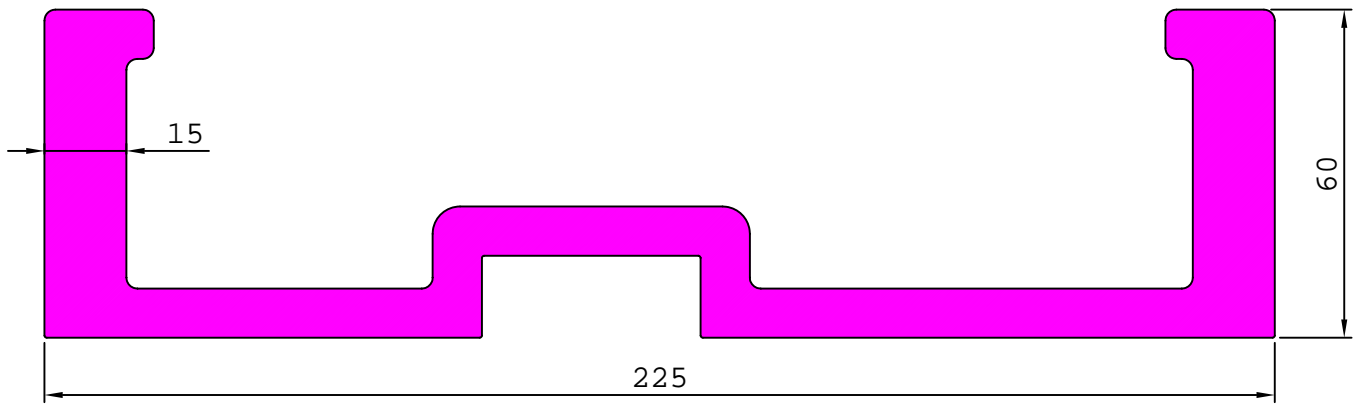

28660

2.971 kg/m

28661

2.805 kg/m

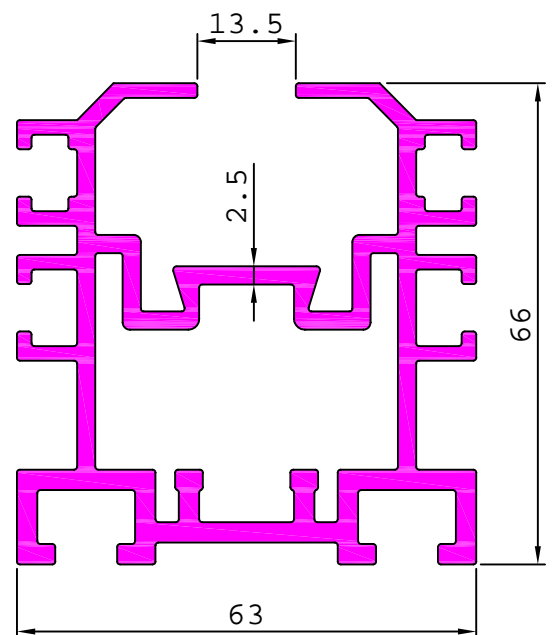
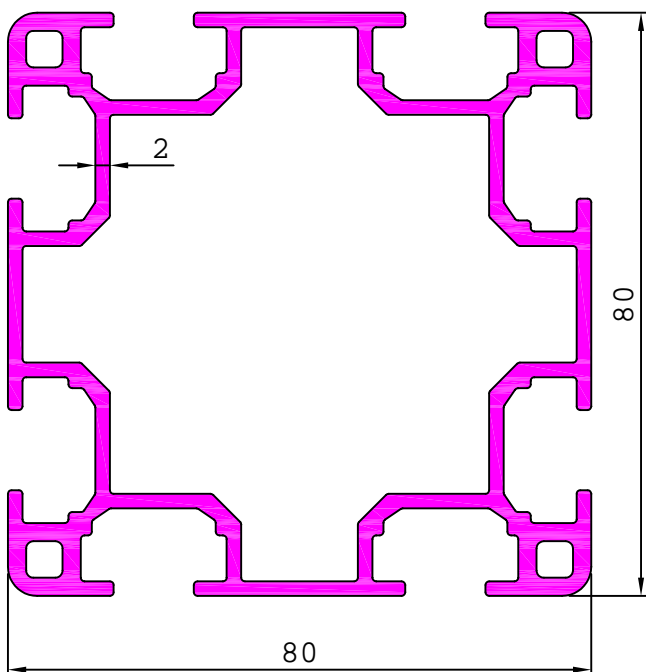

INDUSTRIAL

CONVEYOR SECTION

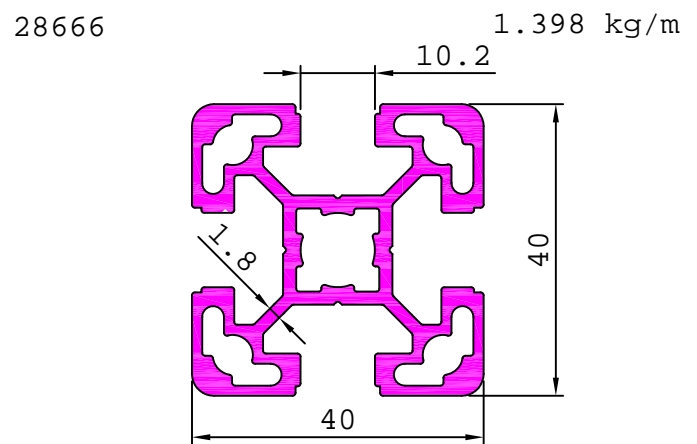
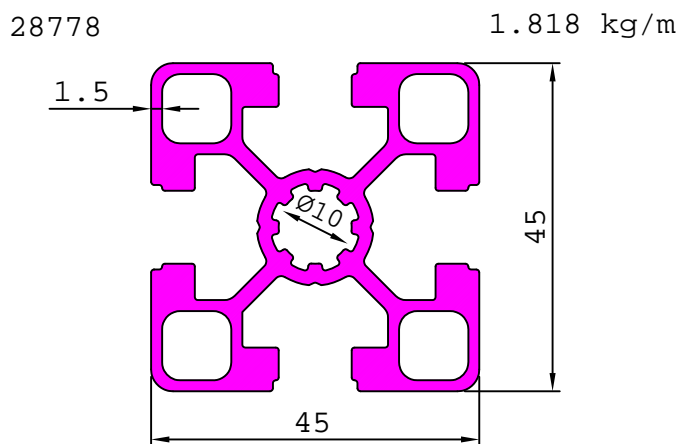
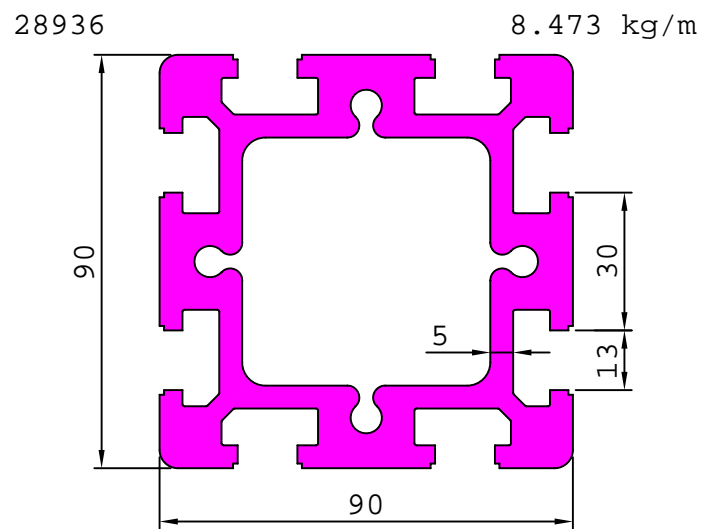
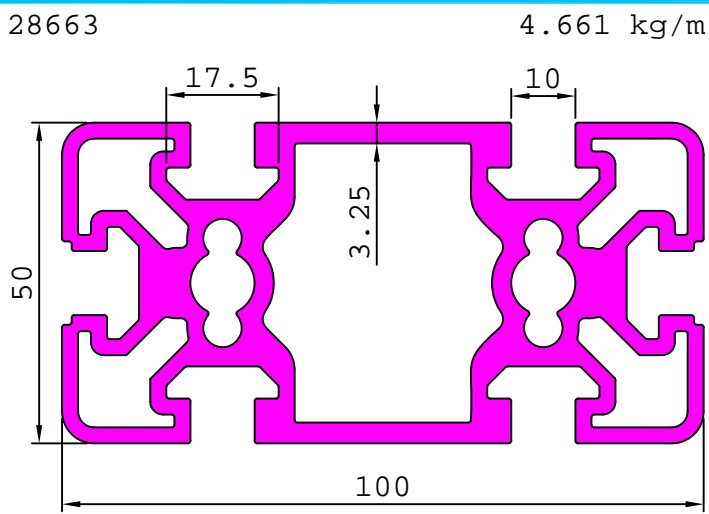
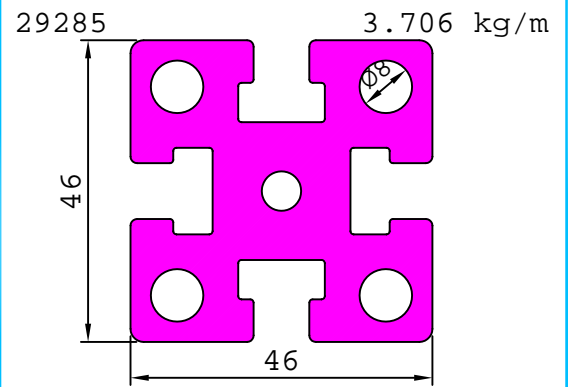
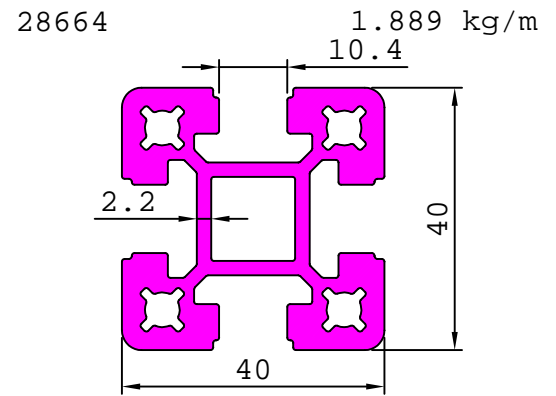
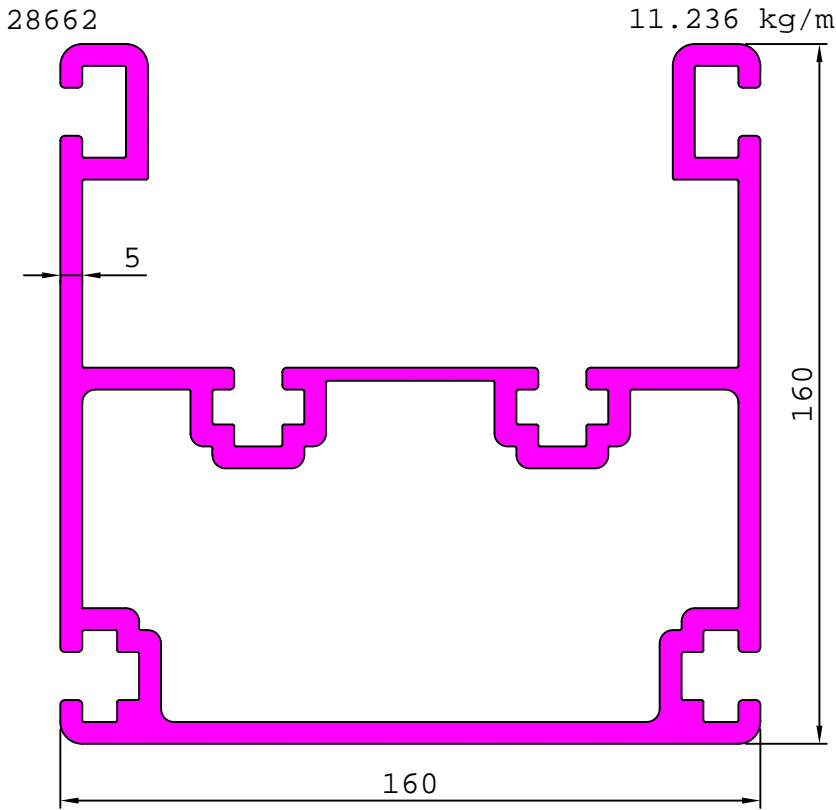

INDUSTRIAL

CONVEYOR SECTION

28665

10.009 kg/m

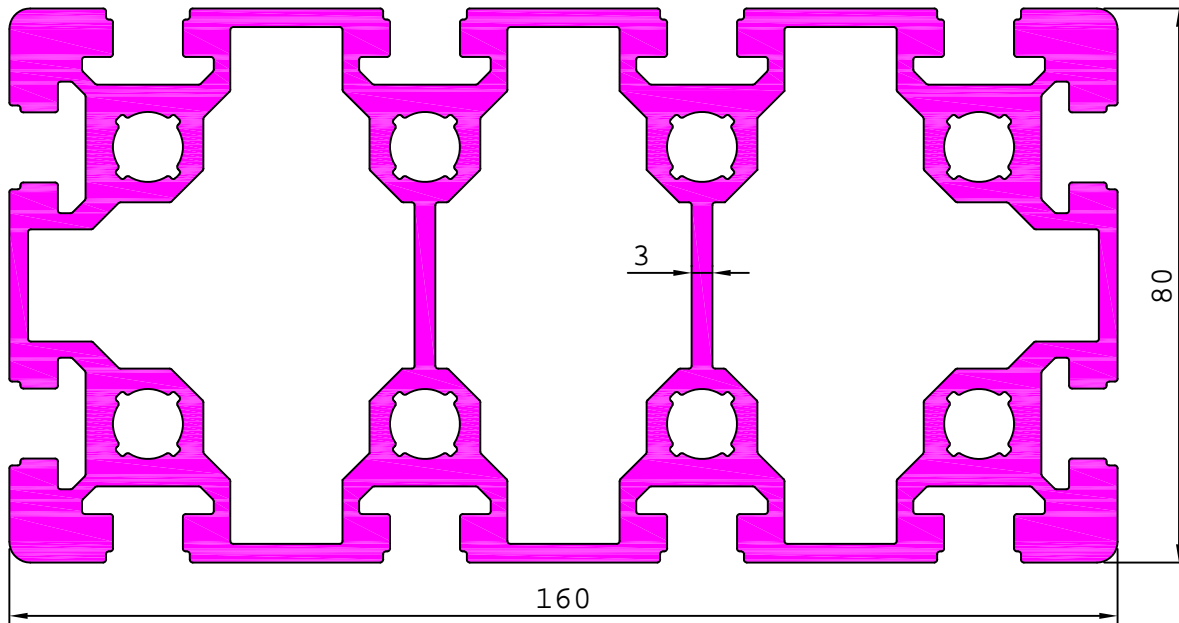

28667

13.329 kg/m

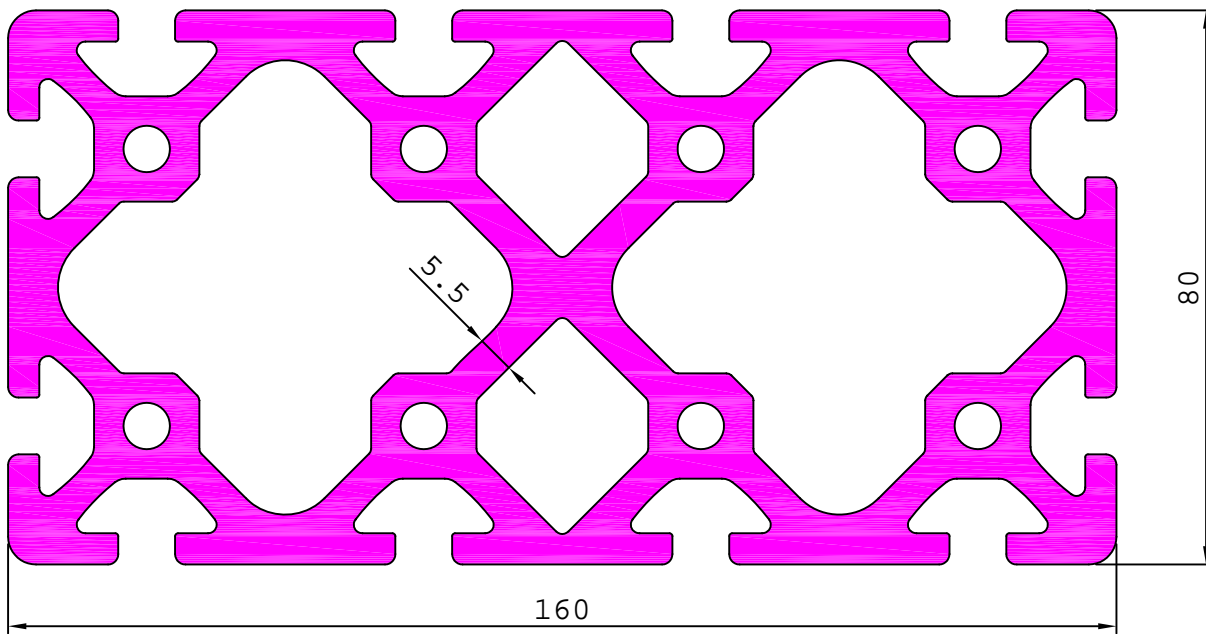

28668

3.903 kg/m

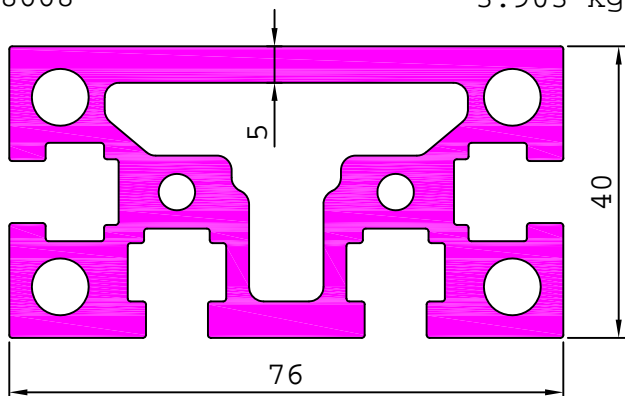

28669

5.509 kg/m

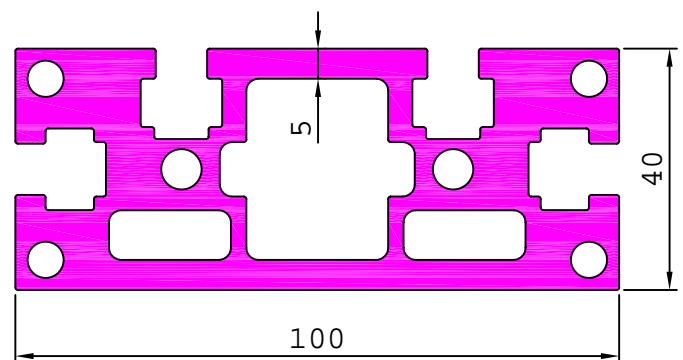

INDUSTRIAL

CONVEYOR SECTION

28671

13.108 kg/m

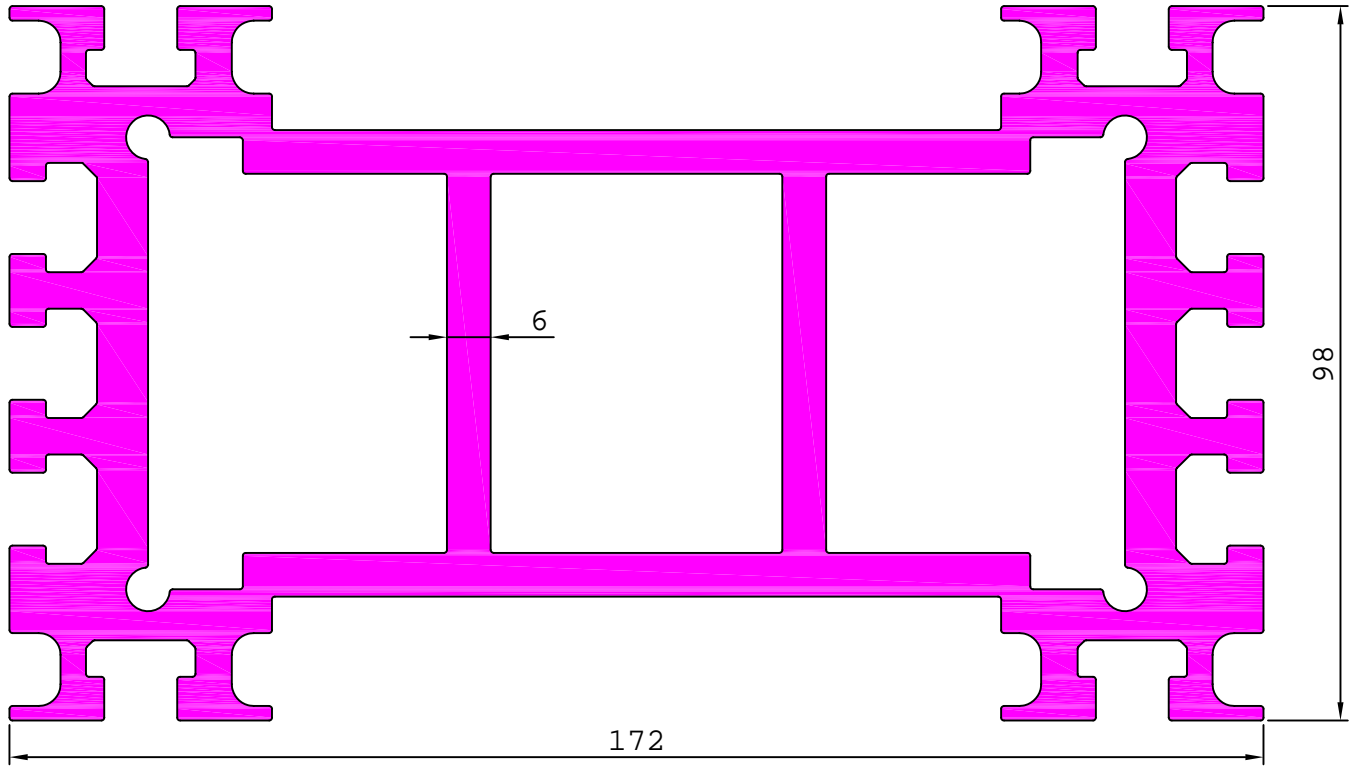

28670

8.148 kg/m

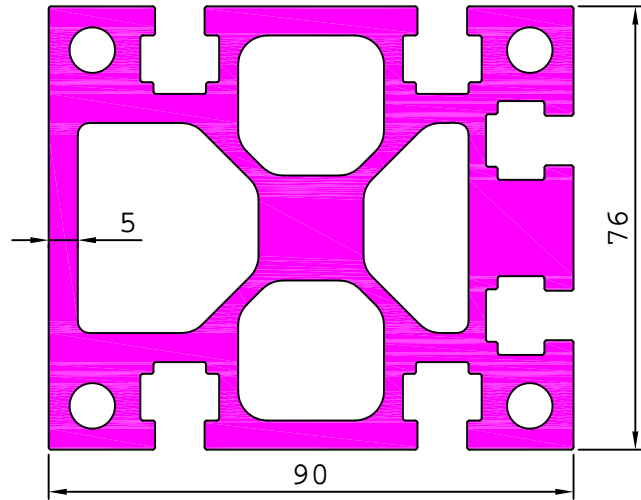

27842

13.187 kg/m

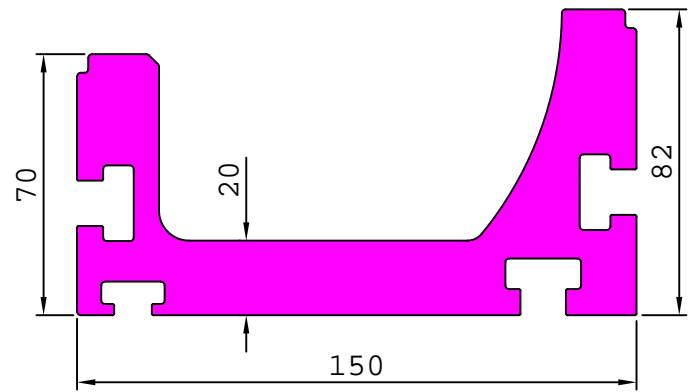

27808

7.106 kg/m

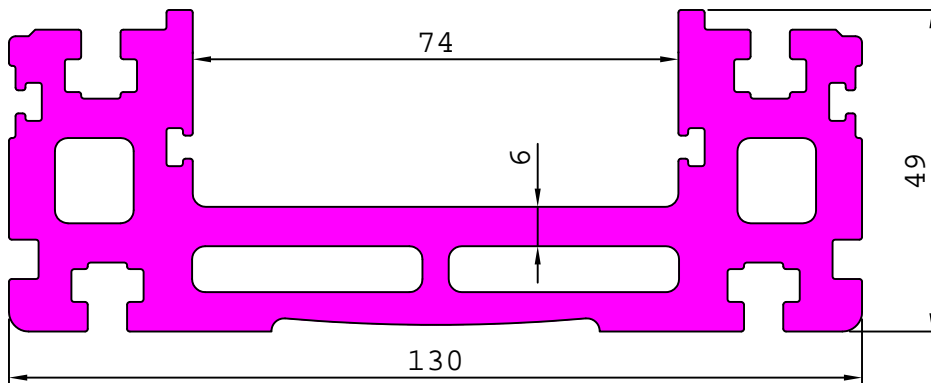

INDUSTRIAL

CONVEYOR SECTION

27835

13.512 kg/m

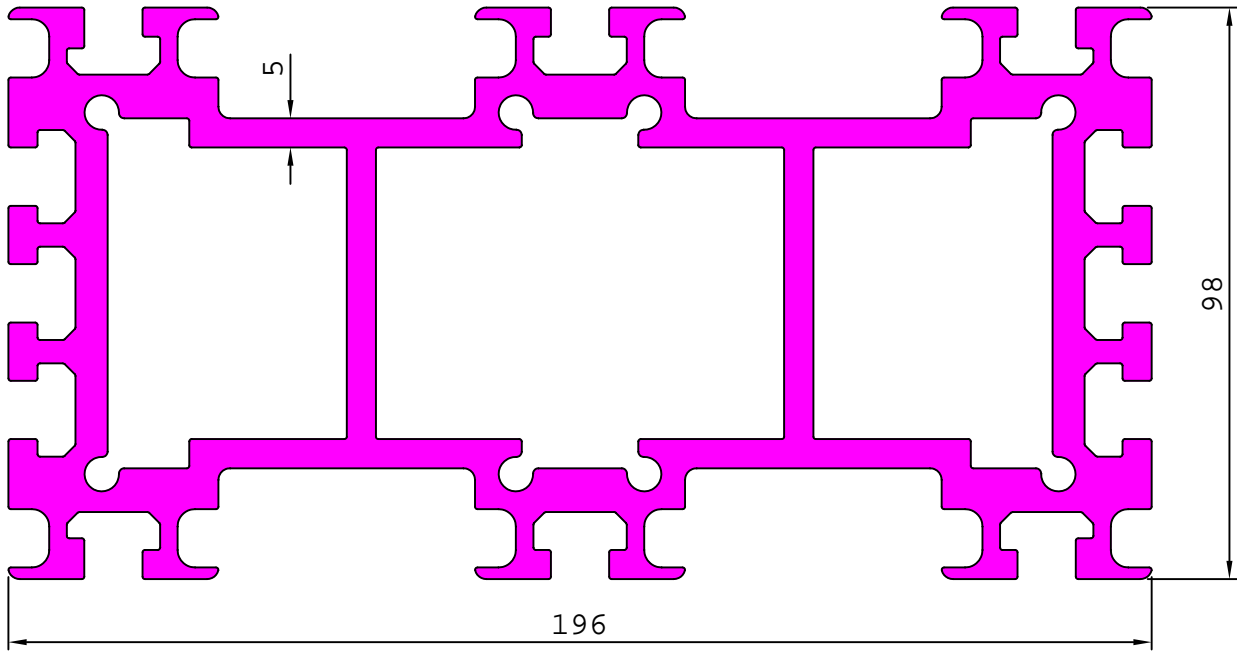

27938

2.588 kg/m

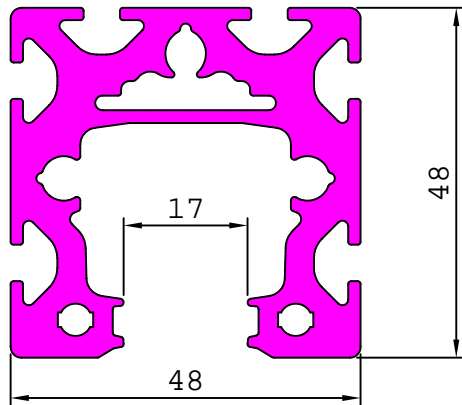

S4815

7.699 kg/m

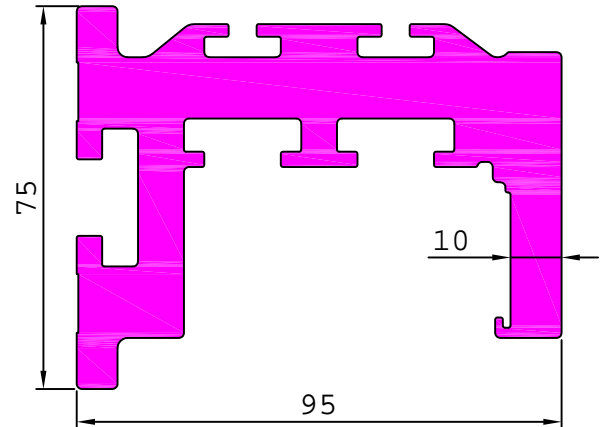

28000

11.252 kg/m

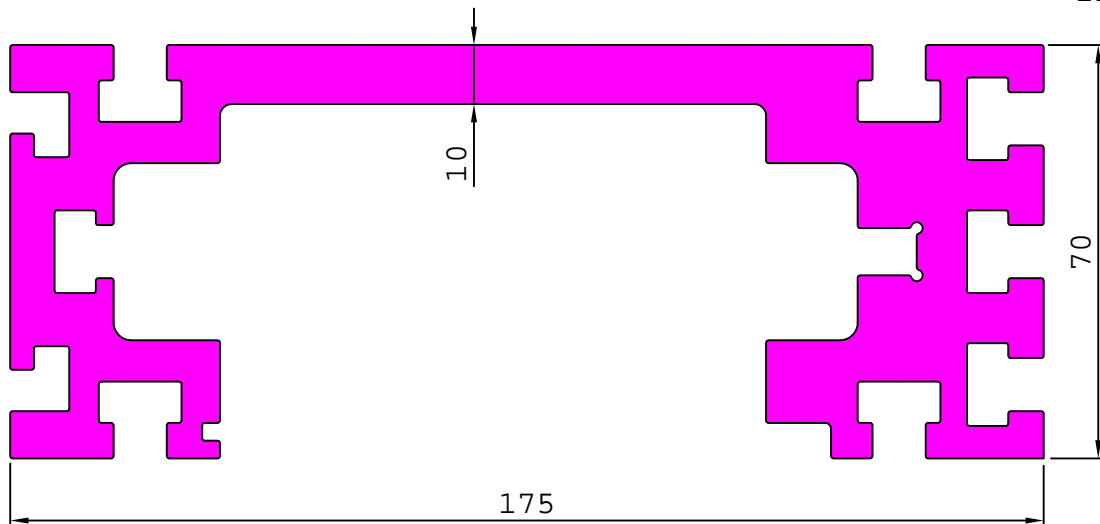

INDUSTRIAL

CONVEYOR SECTION

27859

3.686 kg/m

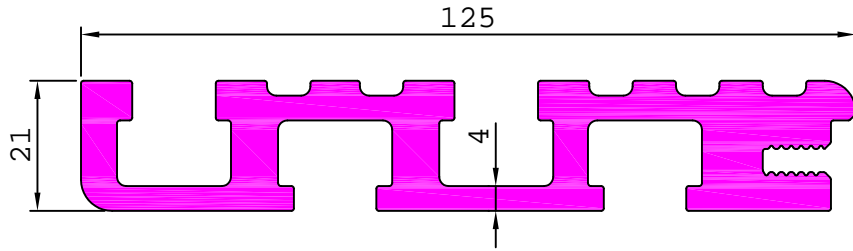

28673

0.427 kg/m

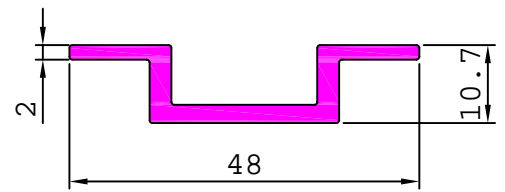

28672

2.905 kg/m

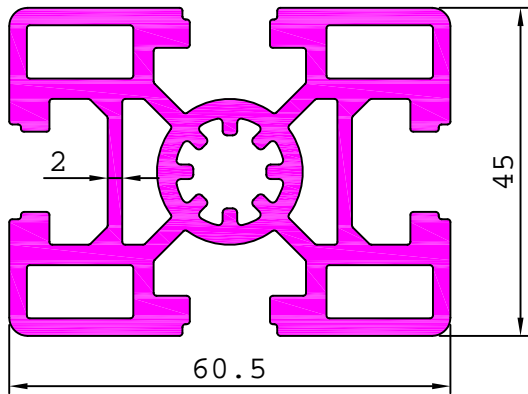

28674

4.523 kg/m

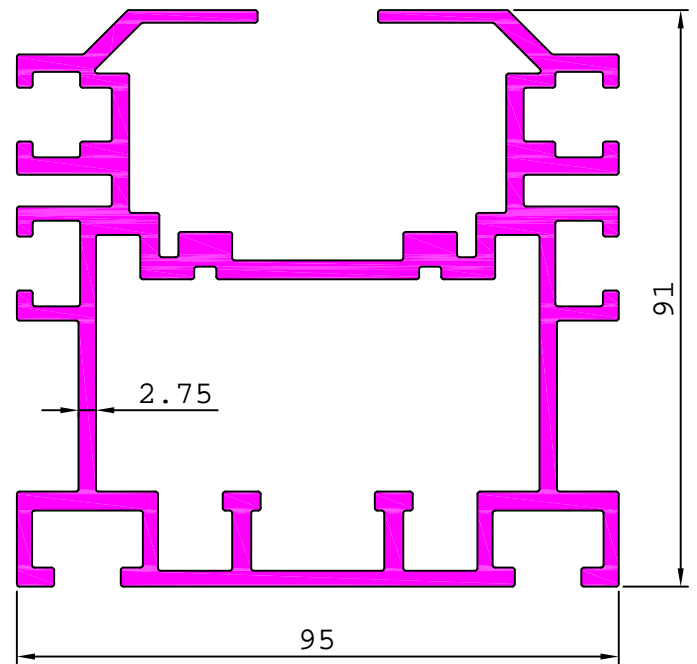

S4373

1.161 kg/m

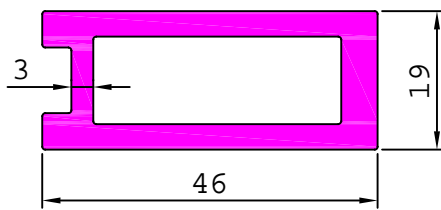

29598

12.170 kg/m

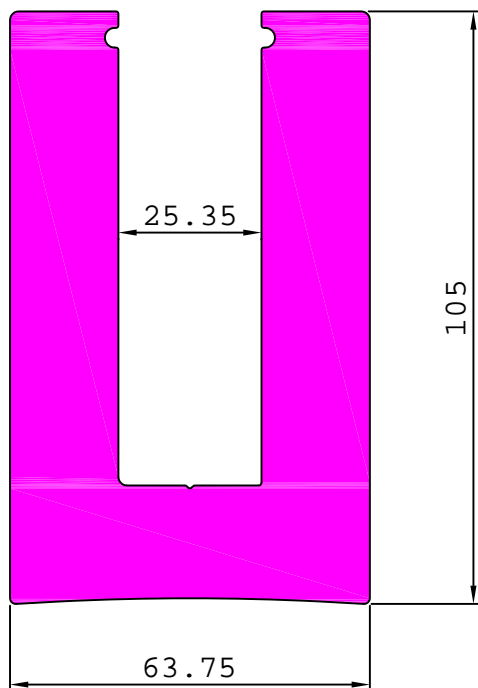

S4968

0.885 kg/m

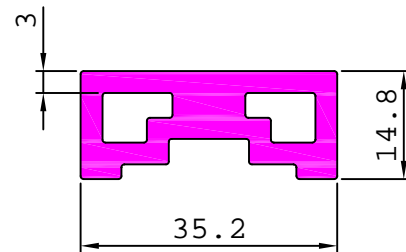

INDUSTRIAL

CONVEYOR SECTION

S4877

3.939 kg/m

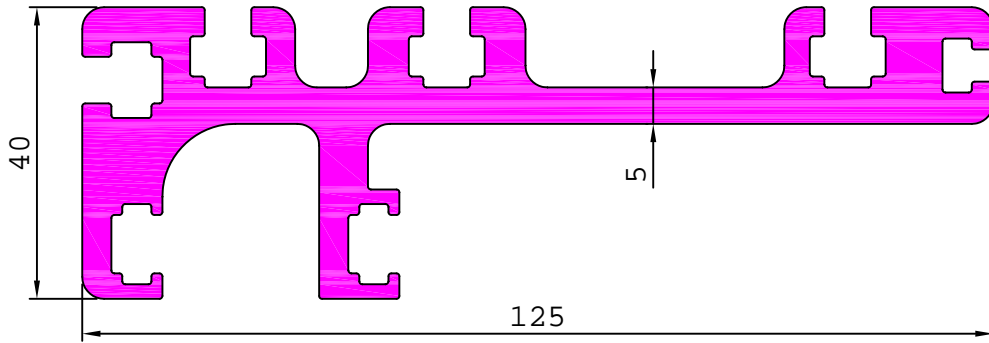

S5214

9.257 kg/m

S5036

5.731 kg/m

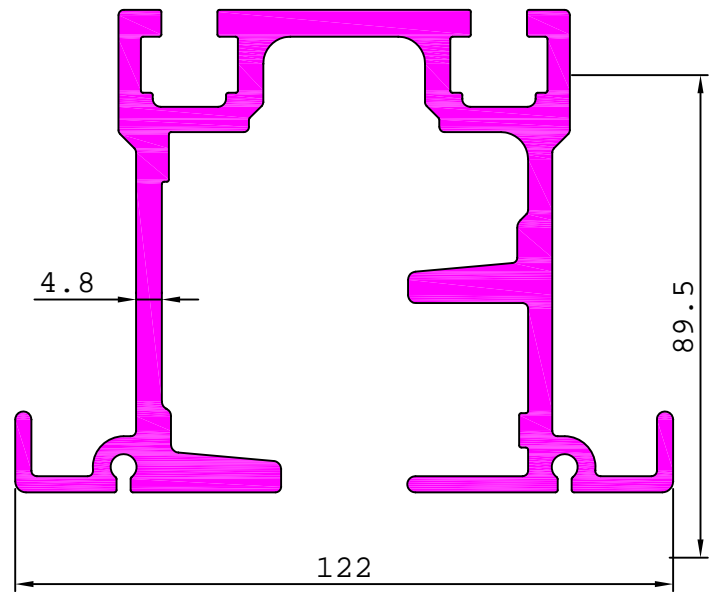
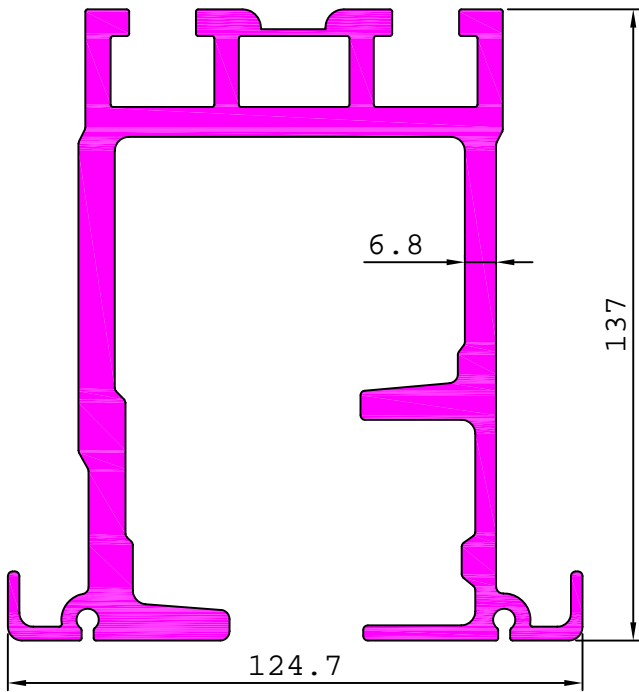

GENERAL

X-RAY FRAMES

28790

0.192 kg/m

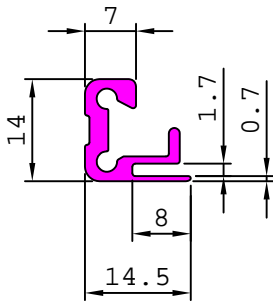

29476

0.211 kg/m

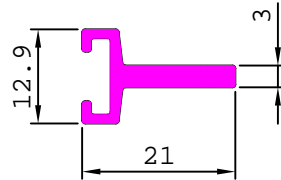

29533

0.165 kg/m

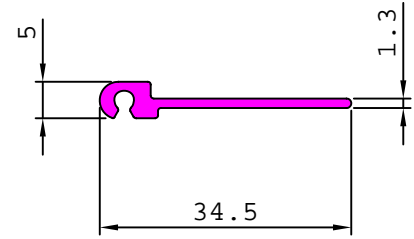

29534

0.216 kg/m

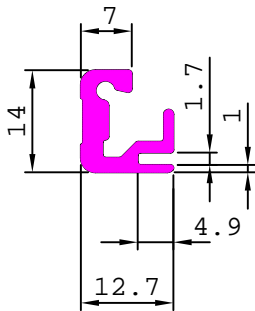

29535

0.207 kg/m

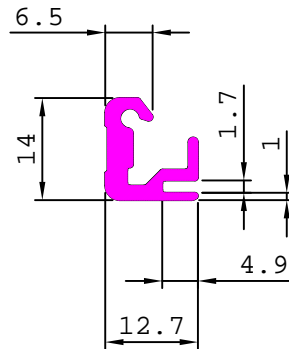

GENERAL

MISCELLANEOUS

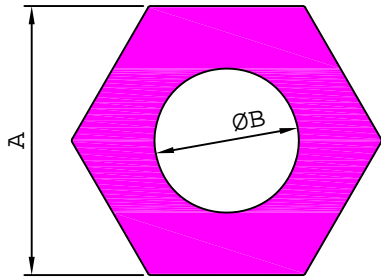

SL. No.	Section No.	A	B	Weight kg/m
1	29572	22.20	14.00	0.737
2	29537	25.40	17.00	0.896
3	29540	27.00	19.50	0.898
4	29541	27.15	18.00	1.036
5	29538	30.15	22.00	1.099
6	29519	33.30	25.00	1.267
7	27991	37.80	16.00	2.798
8	S5076	39.67	32.00	1.508
9	S5077	42.87	35.00	1.700
10	29064	46.00	32.00	2.776
11	28822	50.00	22.00	4.819
12	S5078	50.75	41.00	2.458
13	28824	55.00	25.00	5.748
14	28823	55.00	33.50	4.693
15	27631	60.00	32.00	6.246
16	27630	60.00	40.00	5.025
17	29143	65.00	52.00	4.145
18	28887	70.00	38.00	8.395
19	28886	70.00	45.00	7.163
20	29144	70.50	58.00	4.488
21	29139	75.00	60.00	5.519
22	28856	75.00	38.00	10.091
23	29142	75.00	55.00	6.738
24	29124	80.00	55.00	8.550
25	27632	85.00	50.00	11.593
26	29125	85.00	60.00	9.260
27	28857	110.00	74.00	16.681
28	28864	110.00	66.00	19.056
29	28858	133.40	80.00	28.039

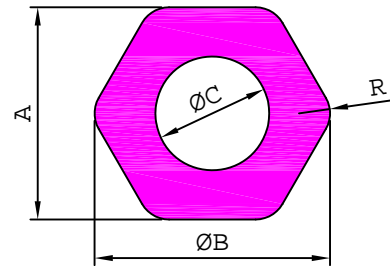

SL. No.	Section No.	A	ØB	C	R	Weight kg/m
1	28990	41.00	45.49	22.00	6.00	2.873
2	29093	65.00	71.96	35.00	10.0	7.194
3	29257	90.00	99.75	60.00	13.50	11.147

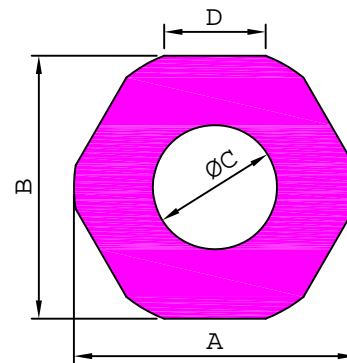

SL. No.	Section No.	A	B	C	D	Weight kg/m
1	29244	50.80	47.75	18.00	17.34	4.498
2	29312	54.10	50.80	24.00	18.61	4.651
3	29313	56.60	54.10	33.00	16.64	4.258
4	29127	68.07	63.50	30.00	24.52	7.308
5	29237	71.30	66.80	32.00	24.93	7.999
6	29183	77.70	73.15	38.00	26.20	9.093
7	29314	81.00	76.20	39.00	27.47	9.971

29140

0.764 kg/m

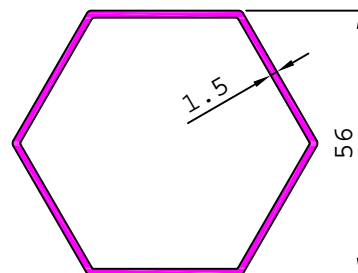

GENERAL

MISCELLANEOUS

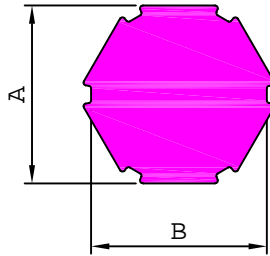

	SECTION No	A	B	WEIGHT kg/m
1	29384	30.50	30.14	2.068
2	29385	37.50	37.30	3.125
3	29391	46.00	45.88	4.727
4	29400	52.00	52.36	6.047

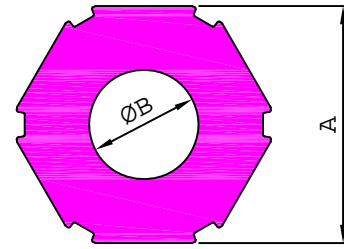

SL No	SECTION No	A	ØB	WEIGHT kg/m
1	29582	46.00	25.00	3.401
2	29583	46.00	18.00	4.040
3	29597	52.00	24.00	4.826
4	29430	60.00	30.00	6.127
5	29438	65.00	30.00	7.535
6	29439	70.00	38.00	7.885
7	29440	75.00	35.00	9.976
8	29437	90.00	40.00	14.735
9	29443	110.00	52.00	21.296
10	29444	123.00	64.00	25.216
11	29445	133.40	76.00	27.647

28187

1.839 kg/m

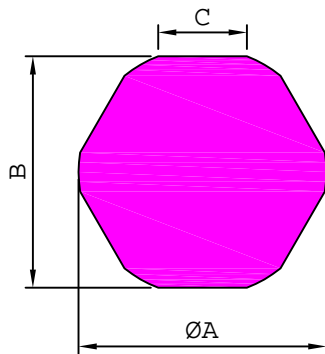
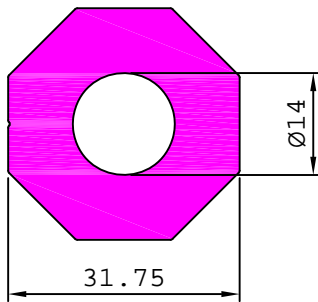

SL. No.	Section No.	A	B	C	Weight kg/m
1	28997	34.00	31.75	12.16	2.303
2	29126	41.40	38.10	16.20	3.344
3	29434	48.00	44.00	19.18	4.468

GENERAL

MISCELLANEOUS

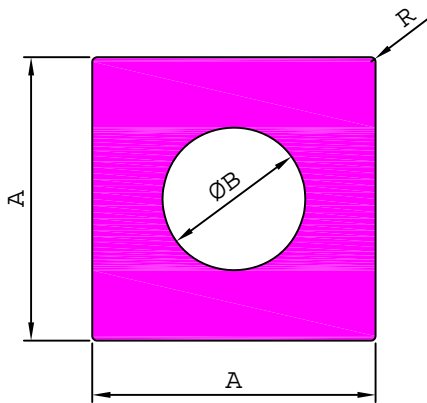

SL No	SECTION No	A	ØB	R	WEIGHT kg/m
1	29010	25.40	12.70	0.40	1.400
2	28111	37.00	17.80	4.00	2.987
3	28100	43.00	24.15	5.00	3.698
4	28101	52.80	32.90	5.50	5.162
5	29425	63.50	32.00	1.00	8.713
6	29432	87.00	44.50	1.00	16.235
7	29042	90.00	70.00	8.00	11.331
8	15213	93.00	48.00	1.00	18.464
9	29362	118.00	68.00	1.00	27.787

28735

5.874 kg/m

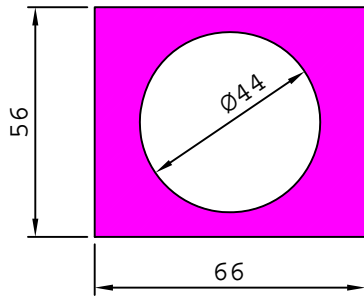

28145

17.018 kg/m

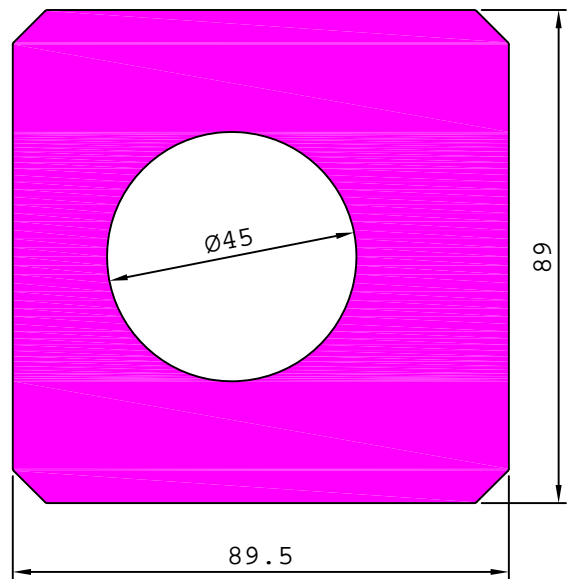

28204

0.736 kg/m

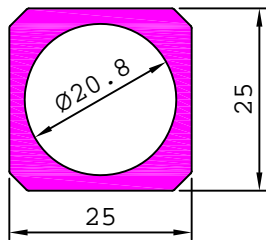

27539

2.066 kg/m

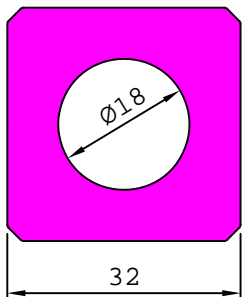

29592

1.039 kg/m

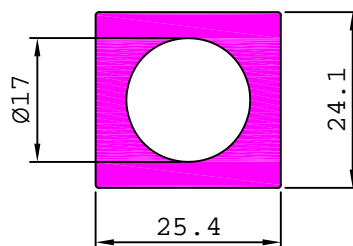

29610

0.934 kg/m

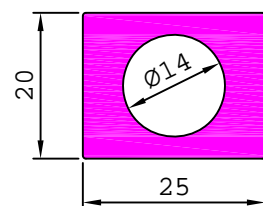

GENERAL

MISCELLANEOUS

15213

18.464 kg/m

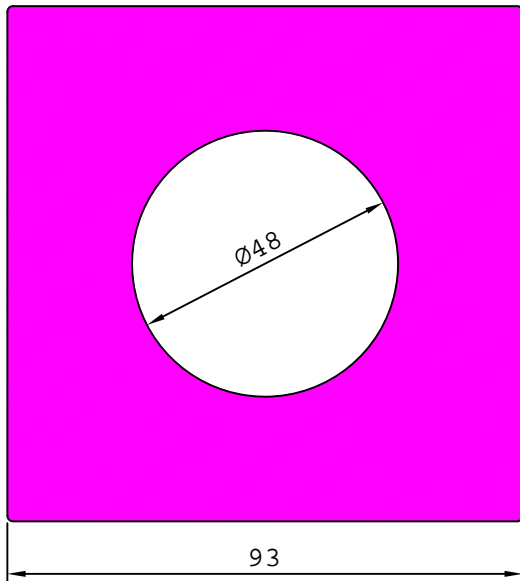

S4511

45.230 kg/m

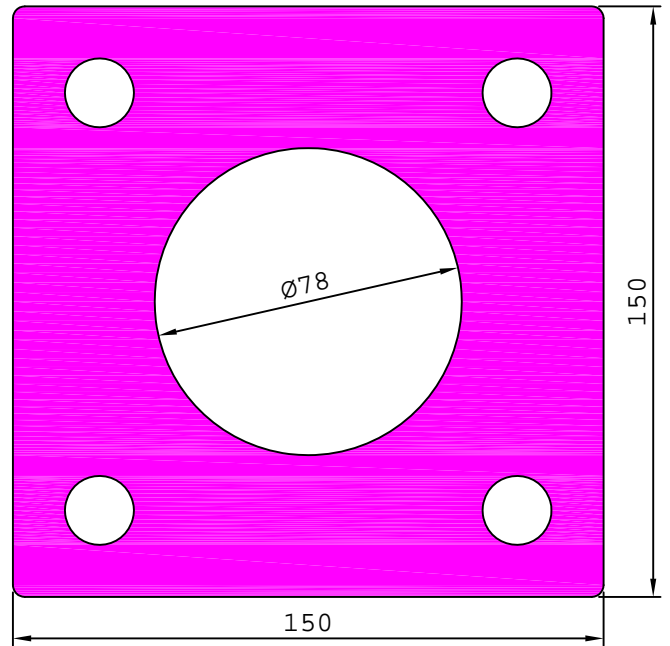

S4534

27.049 kg/m

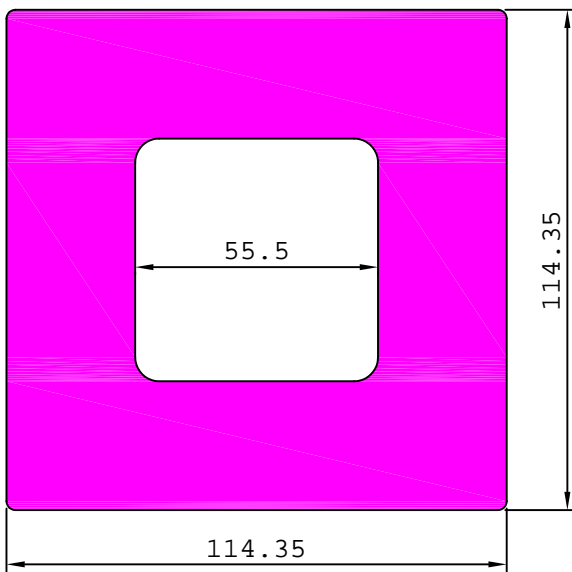

24619

1.271 kg/m

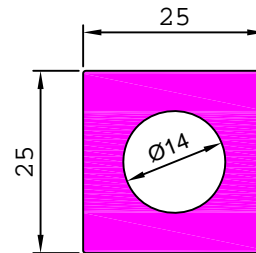

GENERAL

MISCELLANEOUS

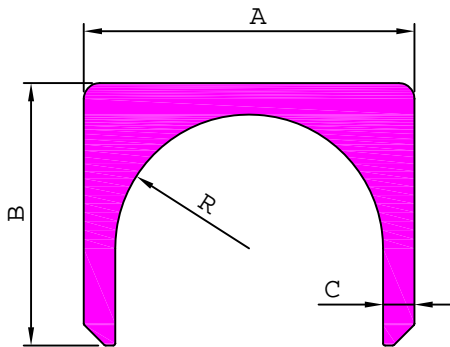

SL. No.	SECTION No	A	B	C	R	WEIGHT kg/m
1	29411	50.00	50.00	6.00	19.00	2.600
2	29410	80.00	70.00	7.00	33.00	5.102
3	29176	63.00	50.00	6.00	25.50	3.146
4	29170	63.00	60.00	6.00	25.50	3.470
5	29171	70.00	50.00	6.00	29.00	3.402
6	29172	94.00	60.00	7.00	40.00	5.569
7	29173	100.00	60.00	7.00	43.00	5.982
8	29174	113.00	75.00	7.00	49.50	7.492
9	29178	120.00	70.00	8.00	52.00	8.350
10	29580	140.00	120.00	8.00	50.00	11.364

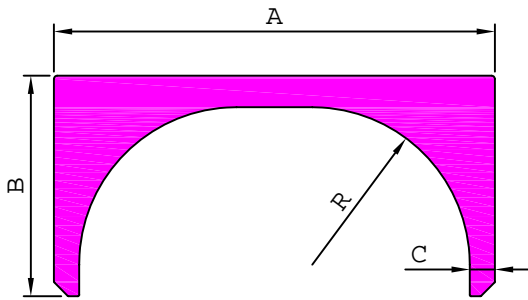

SL. No.	SECTION No	A	B	C	R	WEIGHT kg/m
1	29336	140.00	43.00	8.36	40.00	6.332
2	29335	140.00	53.00	8.00	40.00	6.767
3	29175	140.00	70.00	8.00	50.00	9.213
4	29177	160.00	75.00	7.00	61.00	9.828

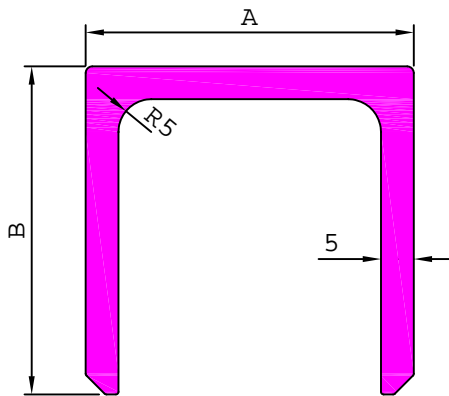

SL. No.	SECTION No	A	B	WEIGHT kg/m
1	29552	50.00	50.00	1.893
2	29553	63.00	60.00	2.339
3	29554	80.00	70.00	2.838
4	29555	94.00	60.00	2.757
5	29556	100.00	60.00	2.838
6	29557	113.00	75.00	3.419

GENERAL

MISCELLANEOUS

28995

11.580 kg/m

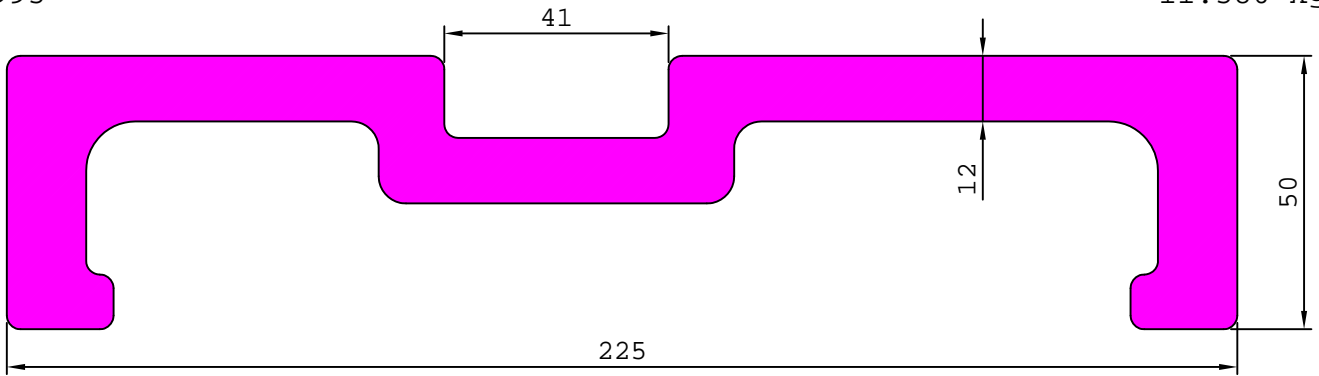

29441

19.280 kg/m

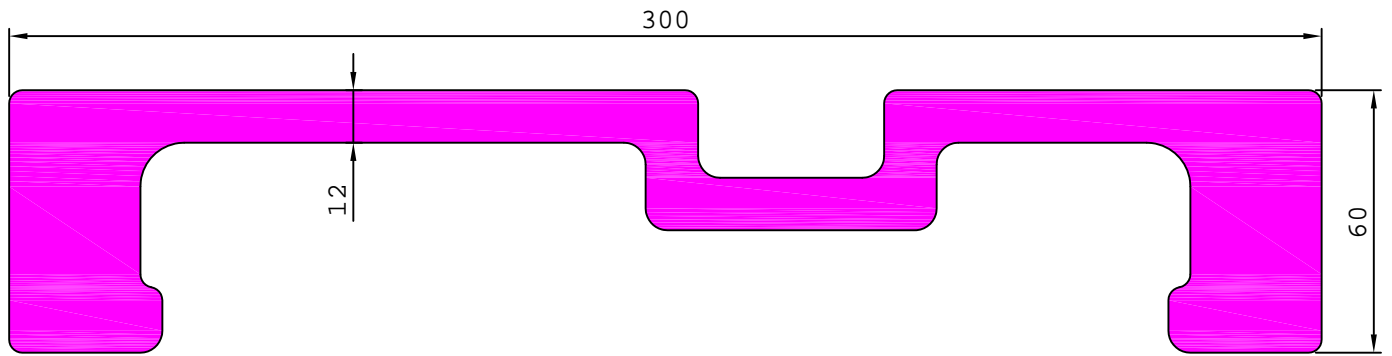

29469

12.576 kg/m

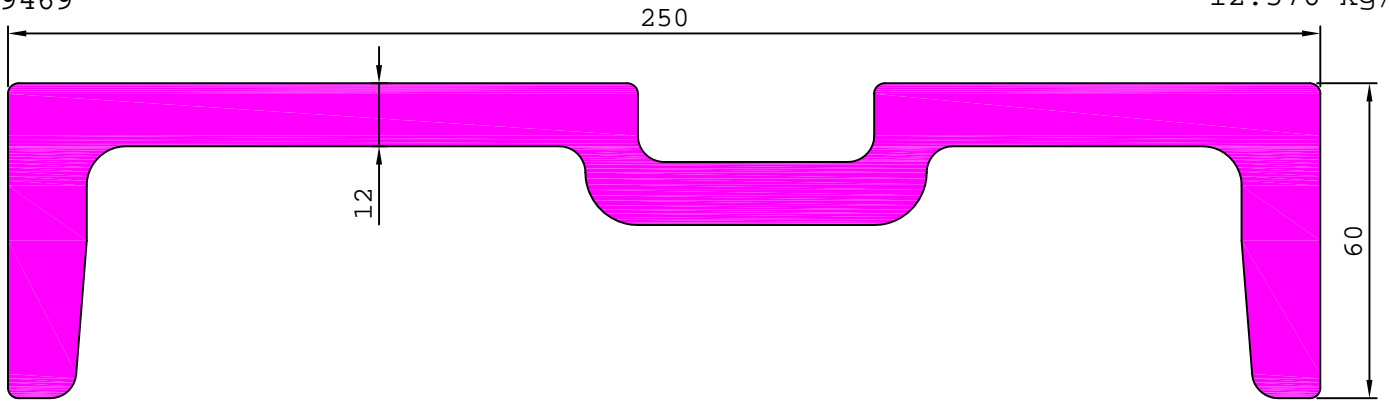

29470

14.712 kg/m

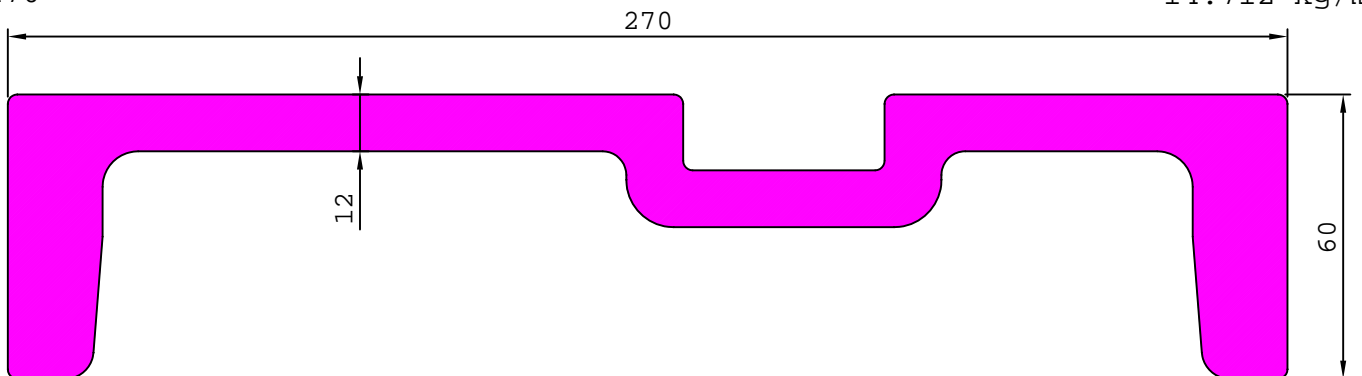

GENERAL

MISCELLANEOUS

29182

13.428 kg/m

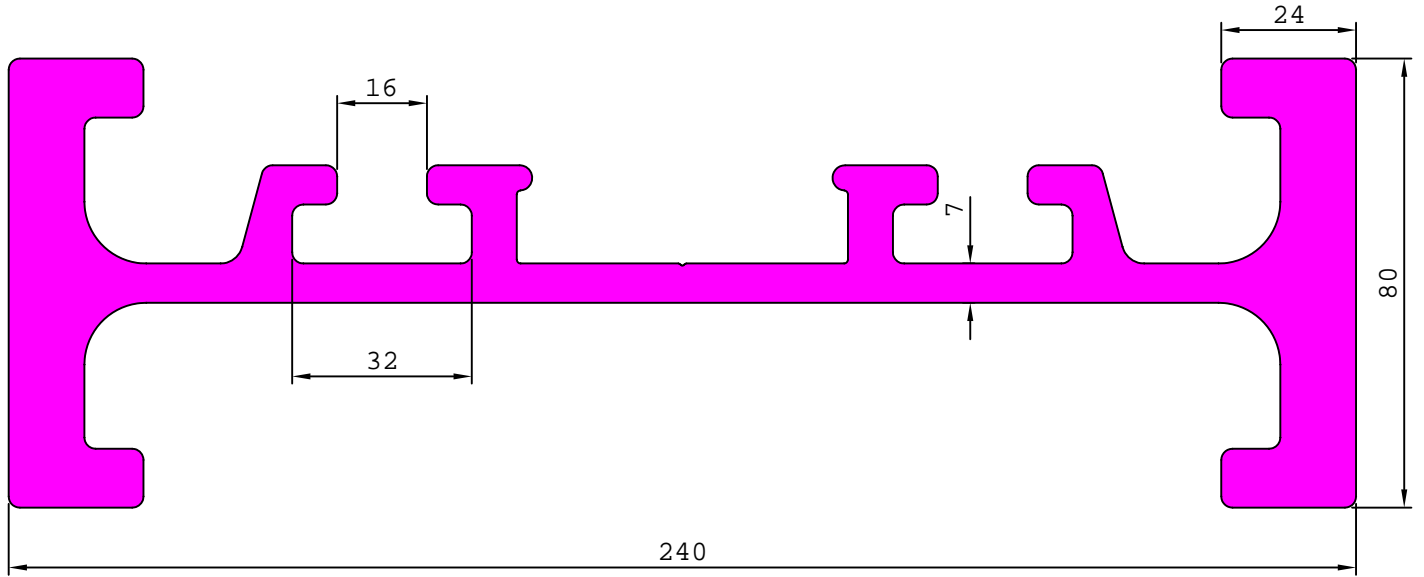

29424

7.802 kg/m

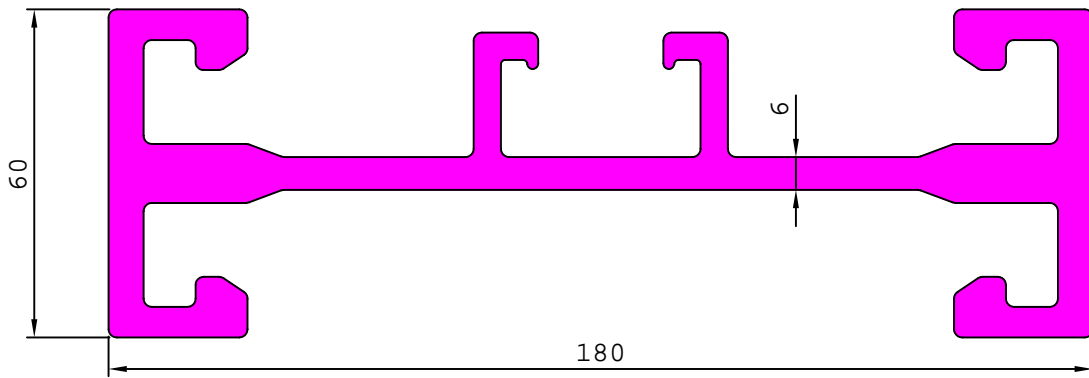

GENERAL

MISCELLANEOUS

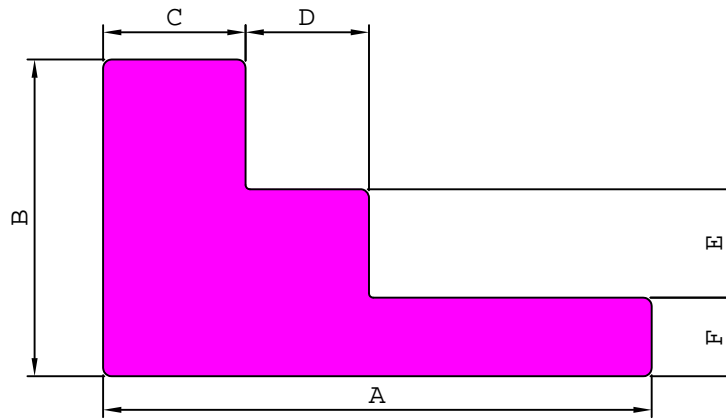

SL. No.	Section No.	A	B	C	D	E	F	Weight kg/m
1	28987	125.00	76.50	35.00	30.00	28.50	19.50	14.264
2	28986	129.00	74.50	33.50	29.00	25.50	18.50	13.493

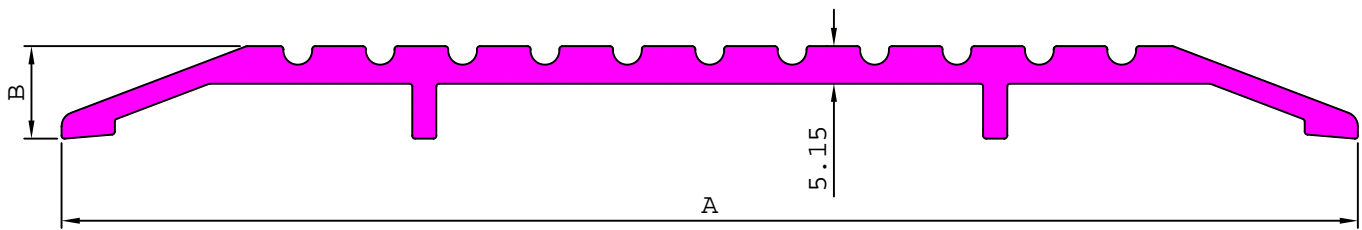

SL. No.	Section No.	A	B	Weight kg/m
1	29075	177.80	12.70	2.151
2	29076	203.20	12.70	2.496

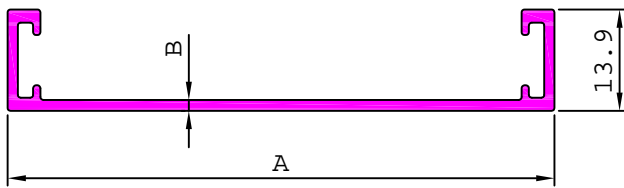

SL. No.	Section No.	A	B	Weight kg/m
1	29388	66.00	1.50	0.414
2	29287	69.00	1.50	0.426
3	29386	75.00	1.50	0.451
4	29387	90.00	1.50	0.511
5	29389	150.00	2.00	1.015

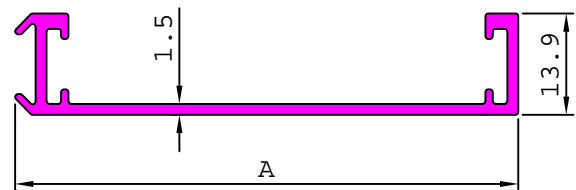

SL. No.	Section No.	A	Weight kg/m
1	29418	69.00	0.440
2	29419	75.00	0.465
3	29420	90.00	0.525

GENERAL

MISCELLANEOUS

28713

2.660 kg/m

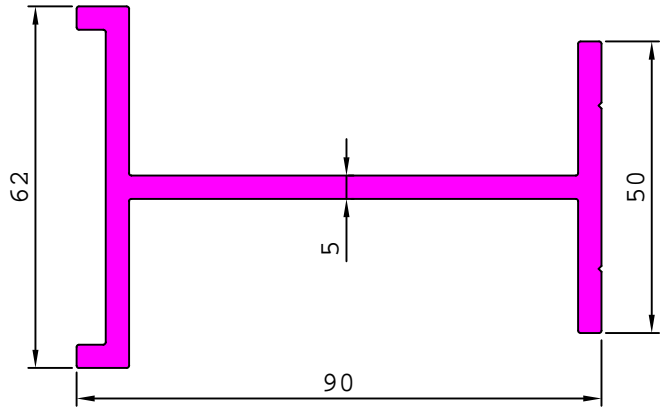

28715

2.635 kg/m

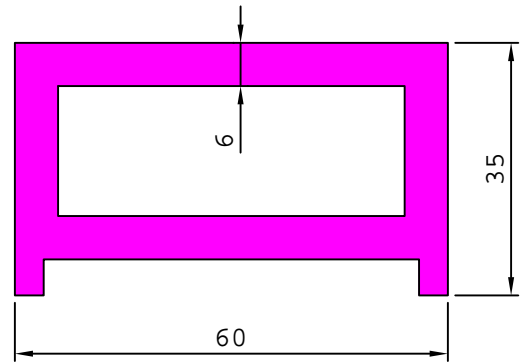

28704

0.282 kg/m

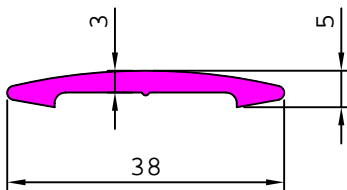

28724

0.278 kg/m

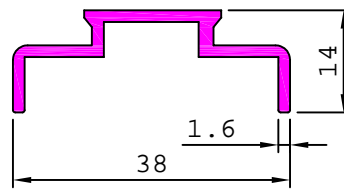

28734

0.078 kg/m

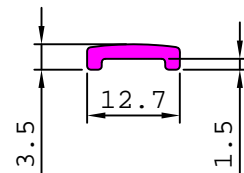

28745

0.156 kg/m

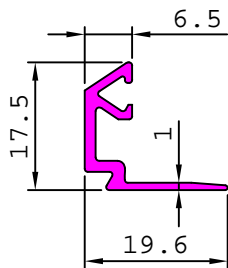

28752

0.362 kg/m

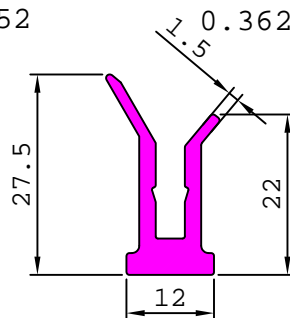

28791

0.046 kg/m

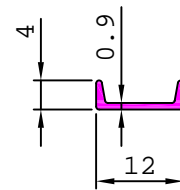

28741

3.240 kg/m

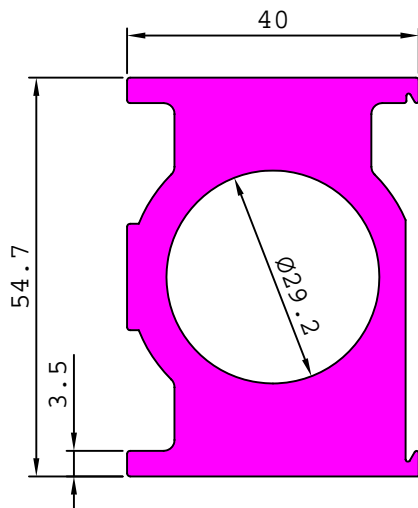

28800

0.727 kg/m

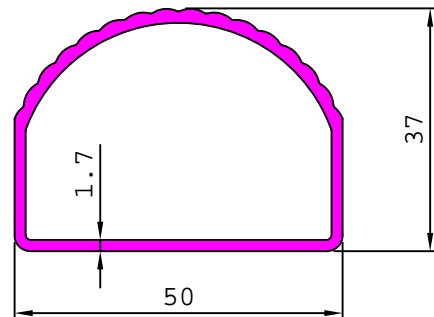

28808

0.359 kg/m

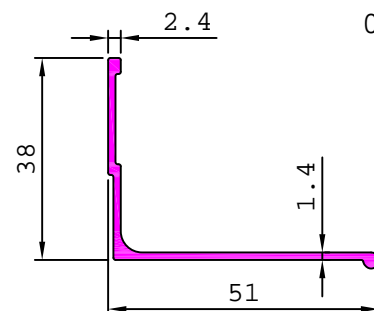

GENERAL

MISCELLANEOUS

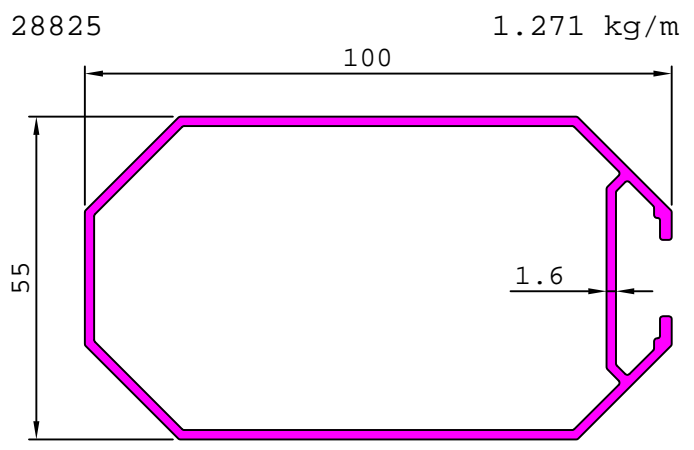
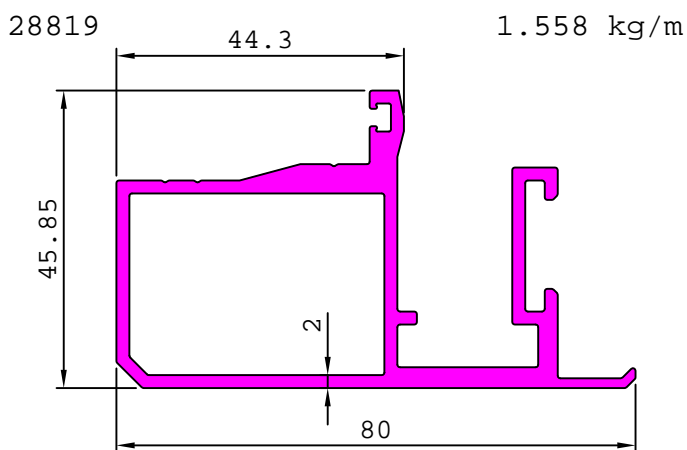
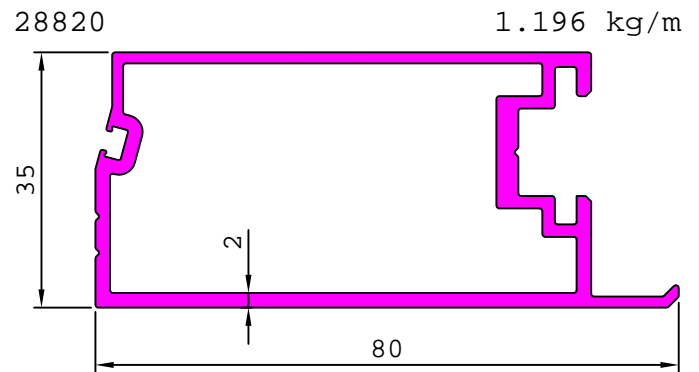
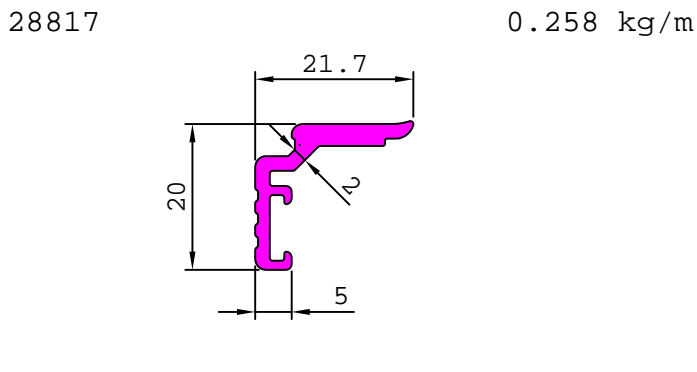
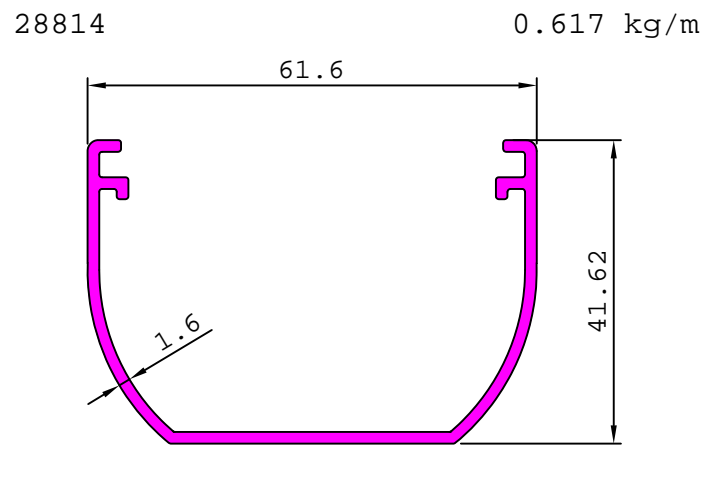
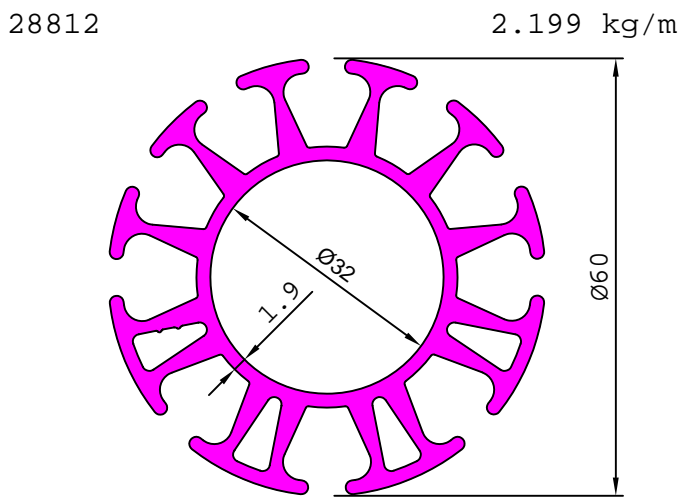
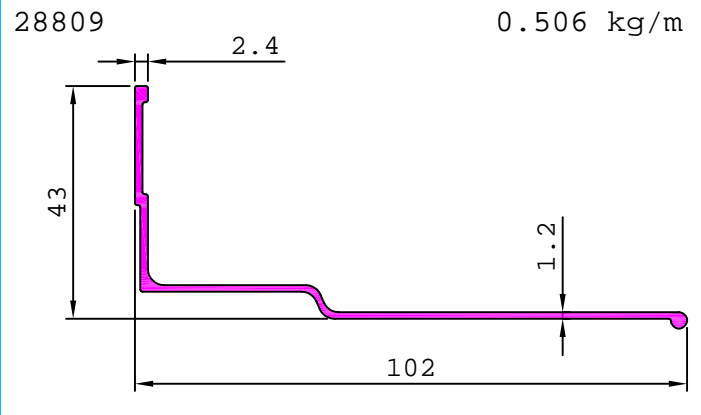
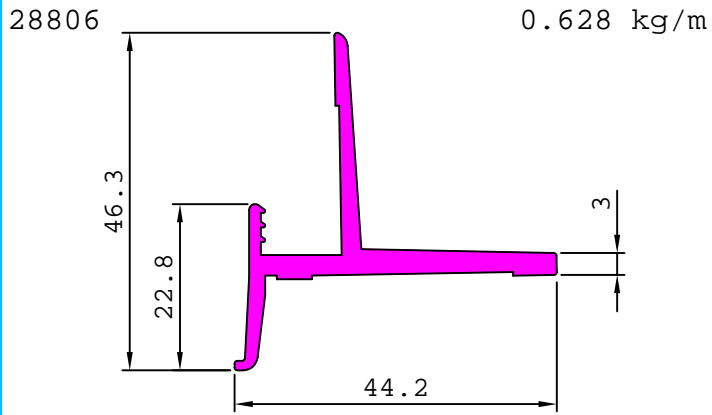

GENERAL

MISCELLANEOUS

28826

0.442 kg/m

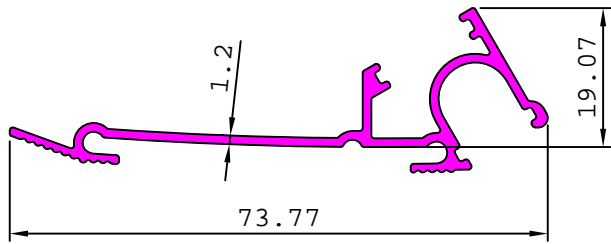

28878

0.534 kg/m

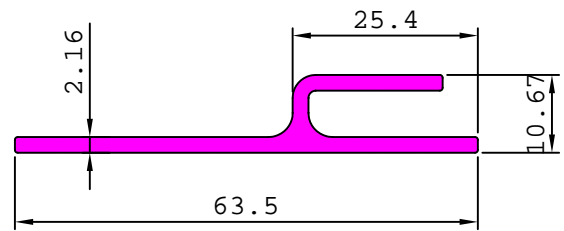

28862

3.370 kg/m

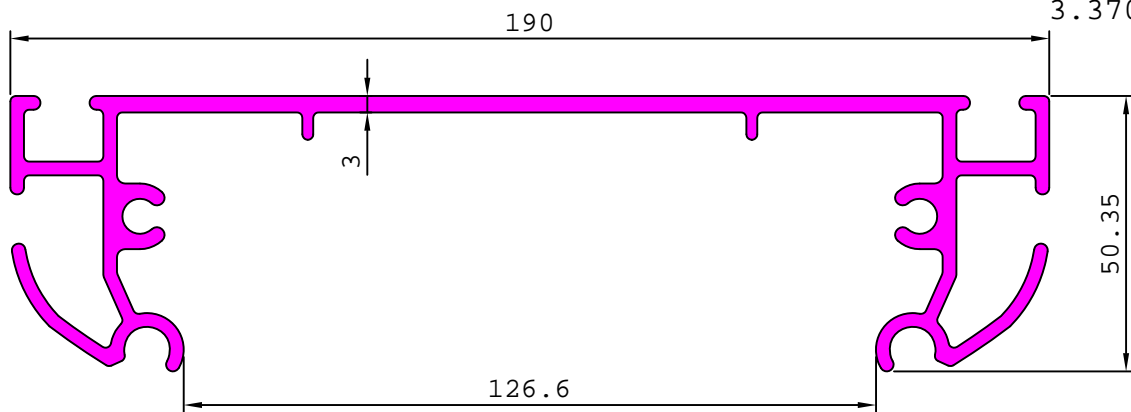

28863

1.209 kg/m

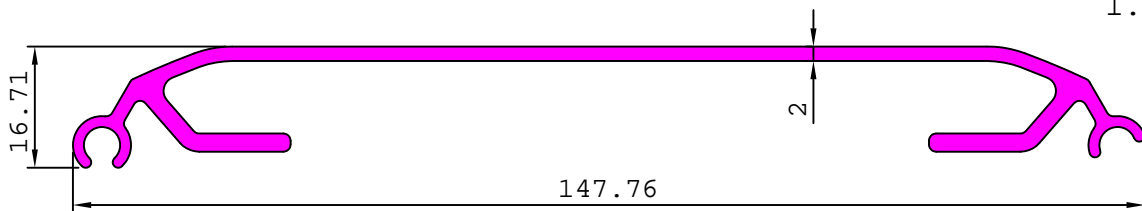

28865

3.888 kg/m

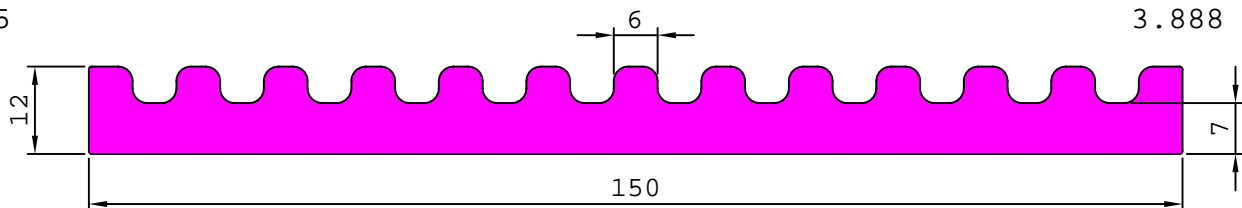

28880

0.853 kg/m

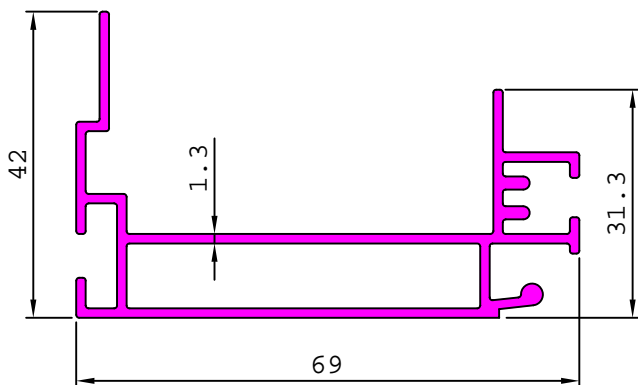

28881

0.131 kg/m

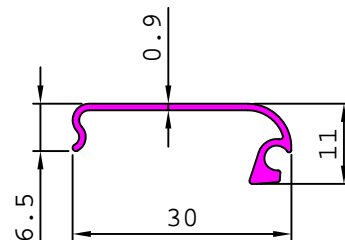

28885

0.198 kg/m

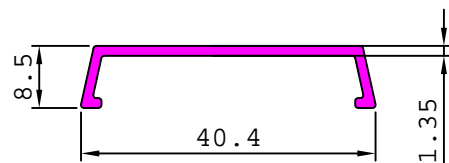

GENERAL

MISCELLANEOUS

28884 2.160 kg/m

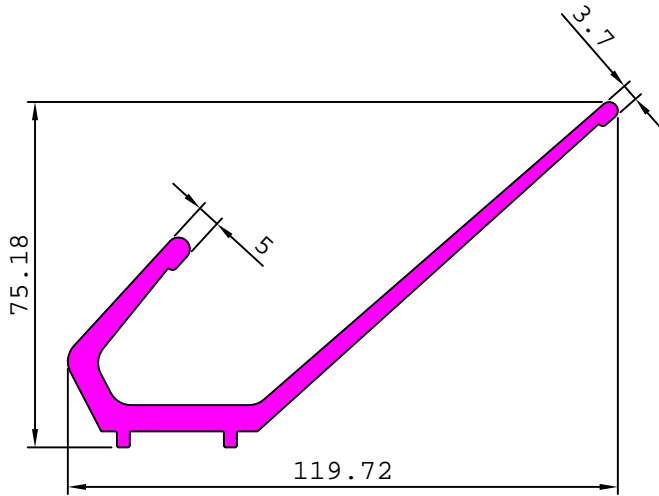

28917 1.590 kg/m

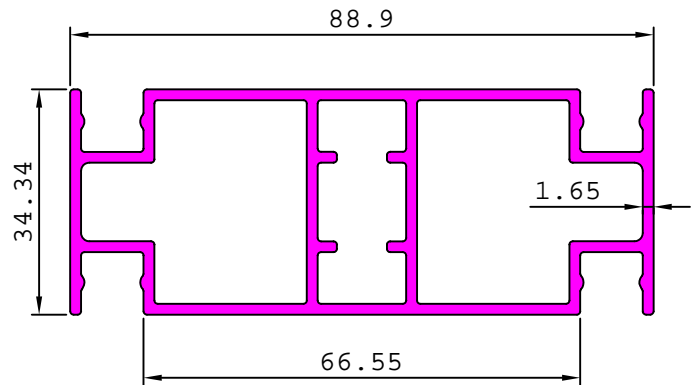

28927 4.932 kg/m

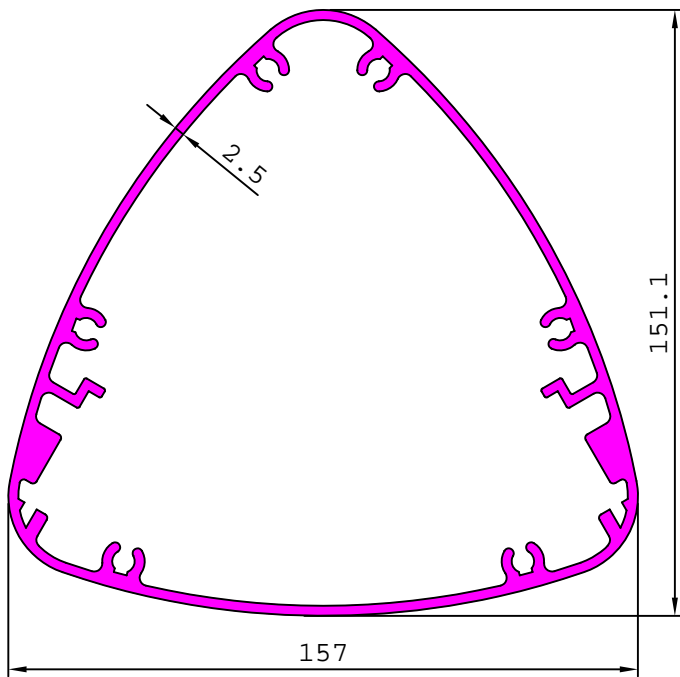

28934 0.950 kg/m

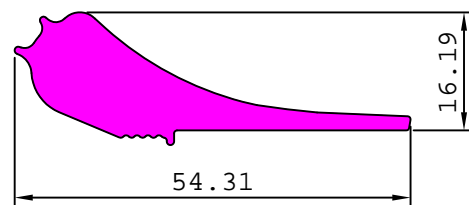

28935 0.560 kg/m

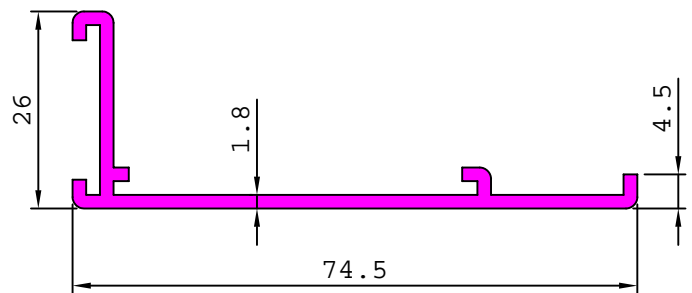

28930 1.770 kg/m

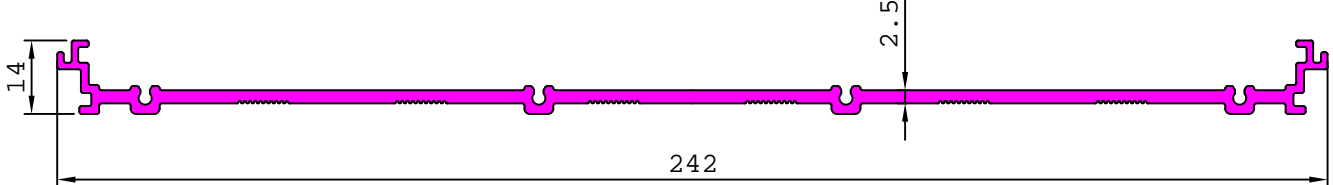

28932 0.836 kg/m

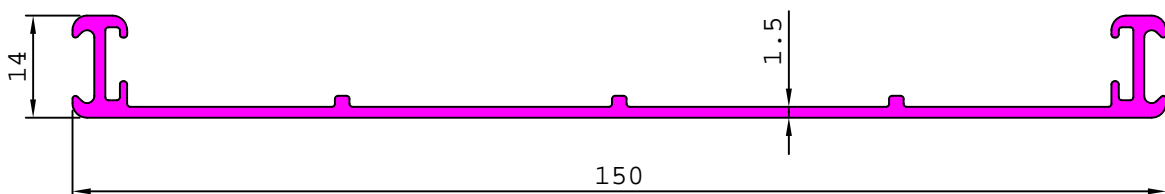

GENERAL

MISCELLANEOUS

28951 2.437 kg/m

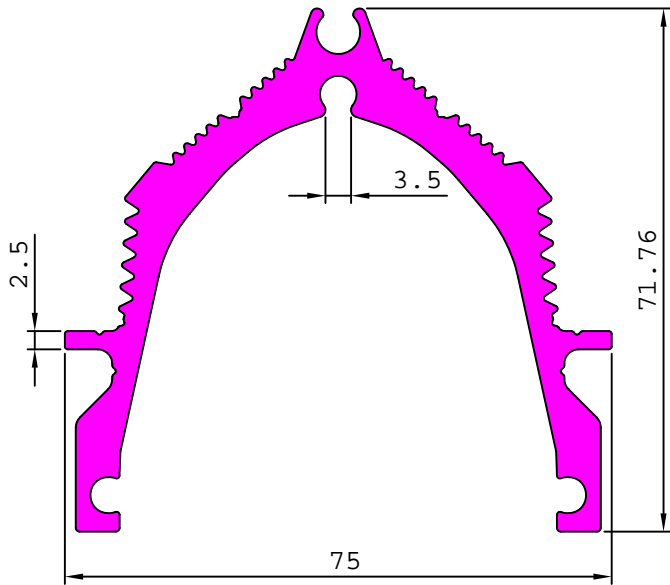

28953 5.858 kg/m

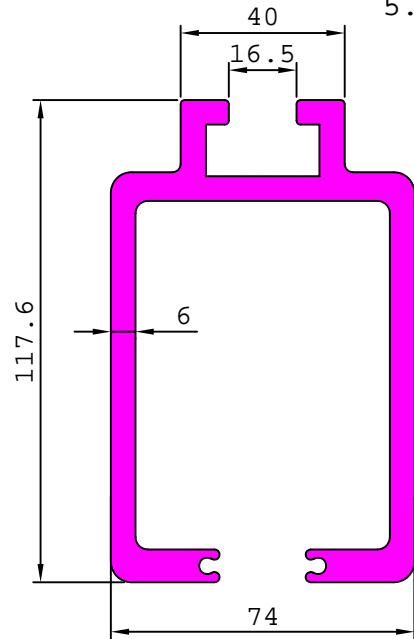

28952 1.081 kg/m

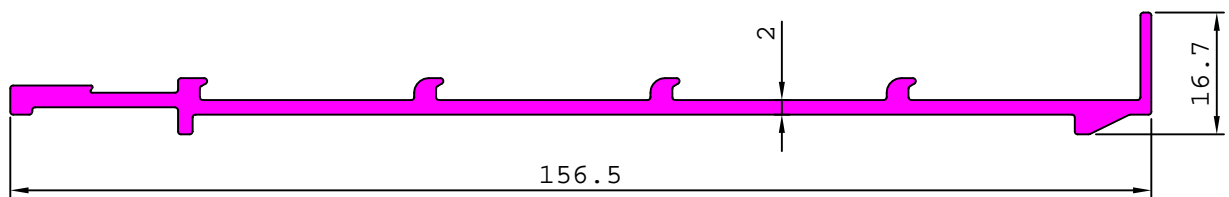

28971 0.789 kg/m

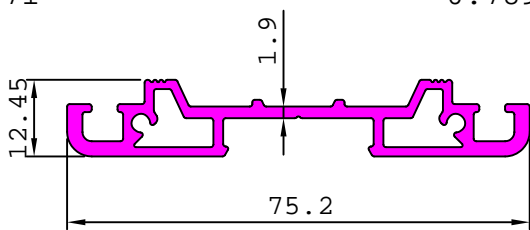

29009 0.585 kg/m

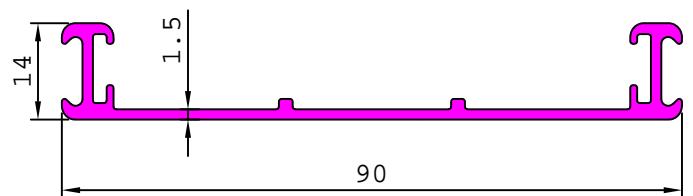

29017 1.865 kg/m

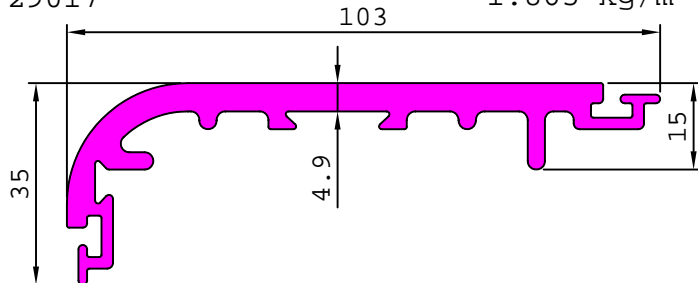

29020 0.484 kg/m

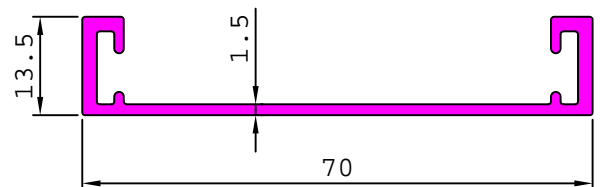

29028 1.282 kg/m

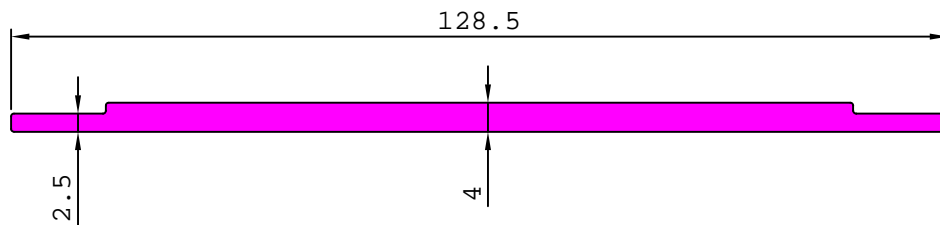

GENERAL

MISCELLANEOUS

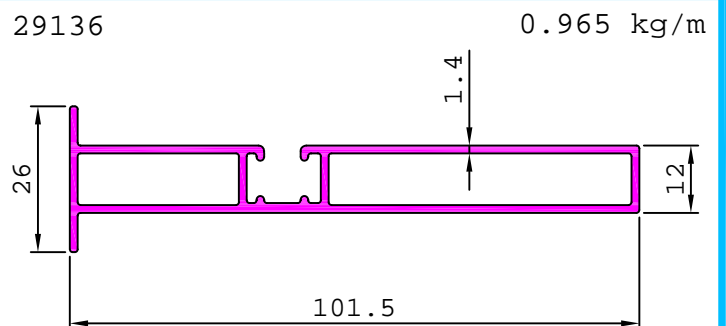
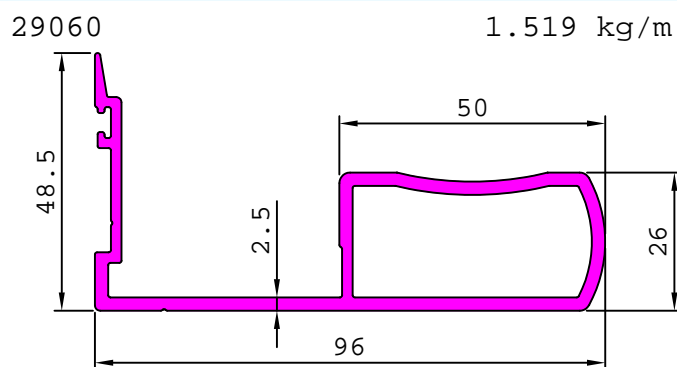
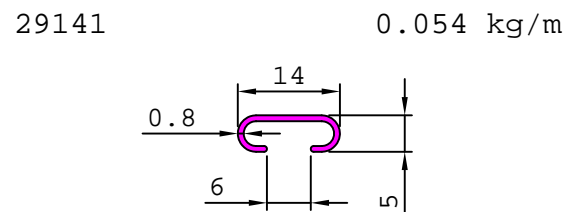
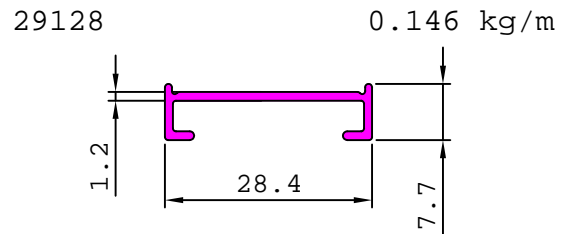
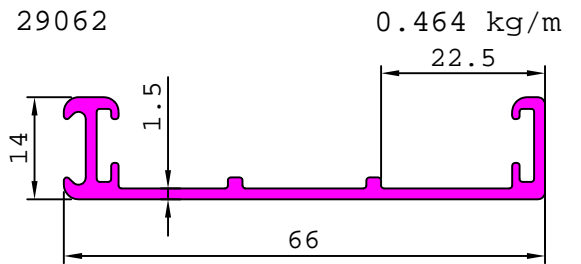
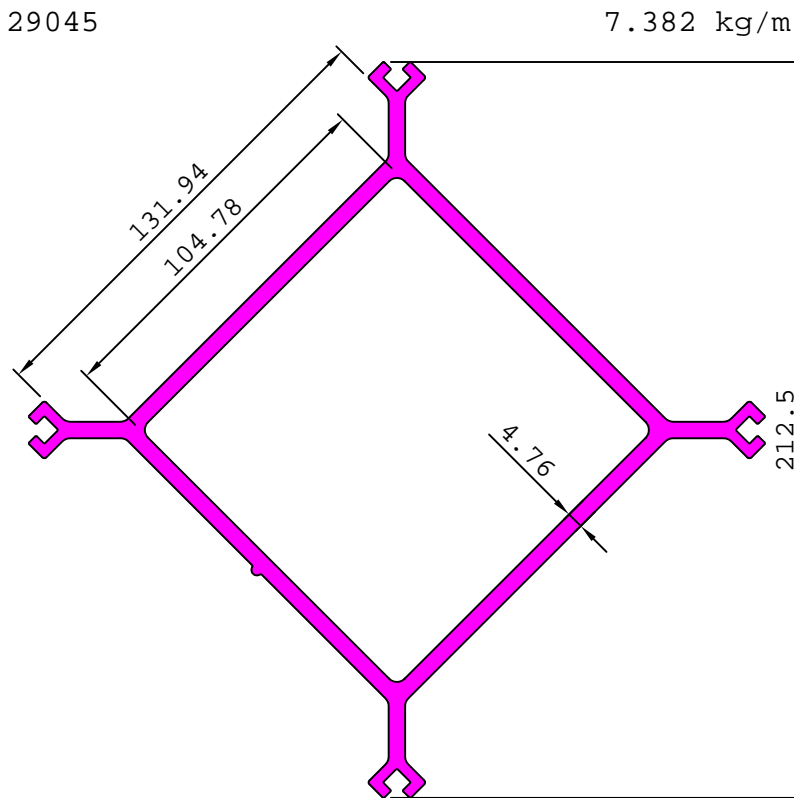
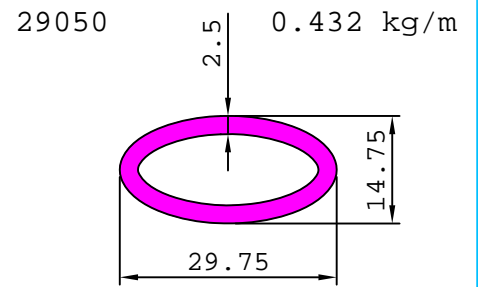
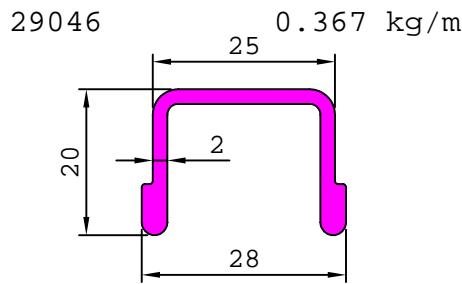
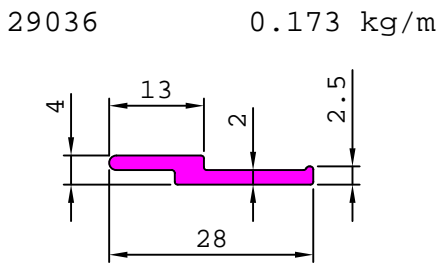
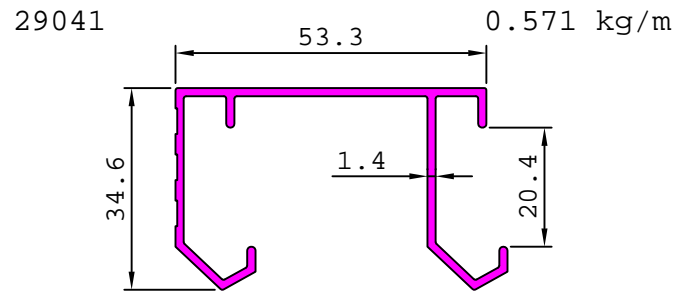
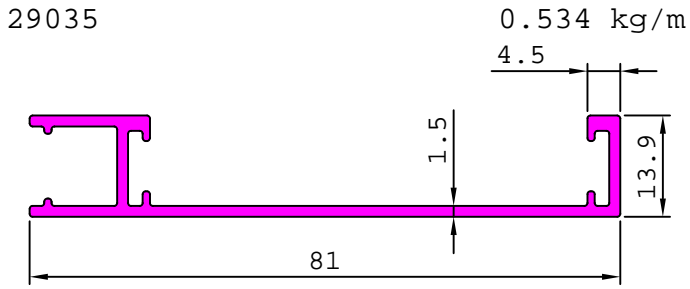

GENERAL

MISCELLANEOUS

29051

5.035 kg/m

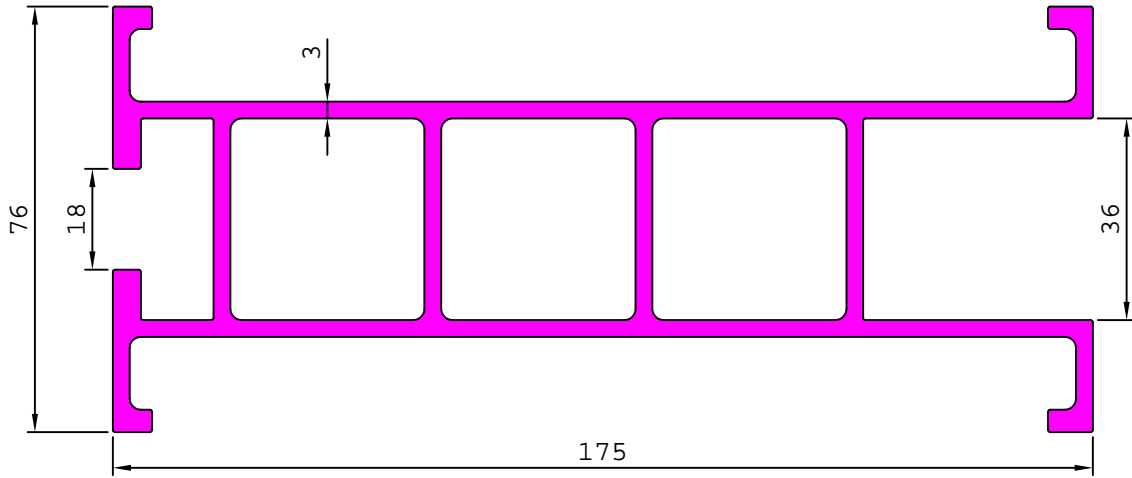

29053

9.514 kg/m

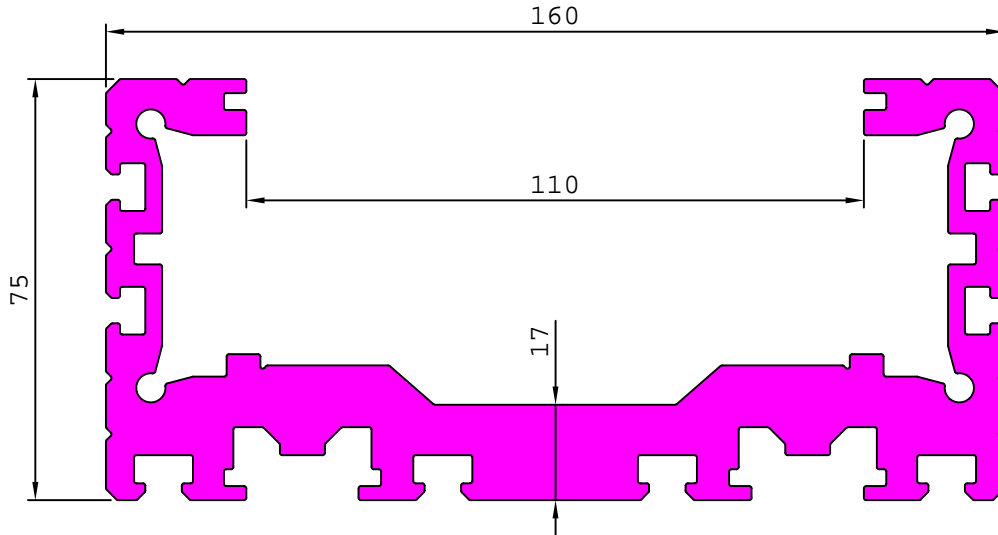

29071

15.919 kg/m

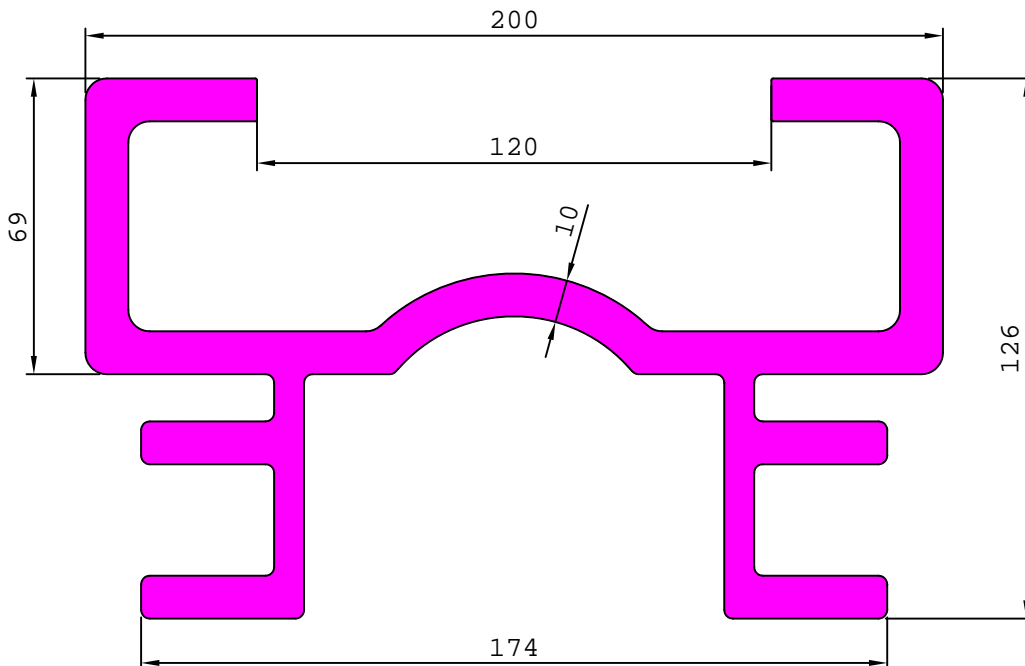

GENERAL

MISCELLANEOUS

29063

5.878 kg/m



29078

7.366 kg/m

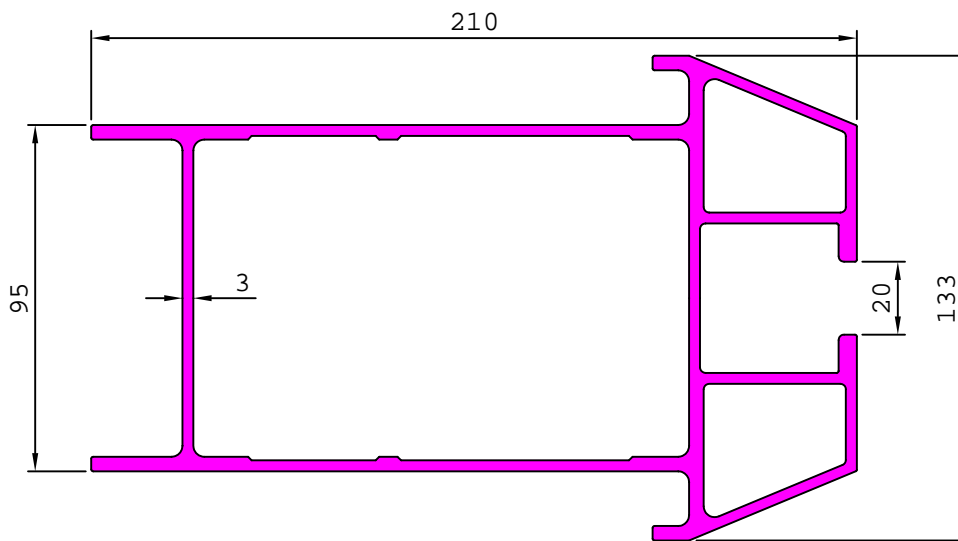

29079

4.564 kg/m

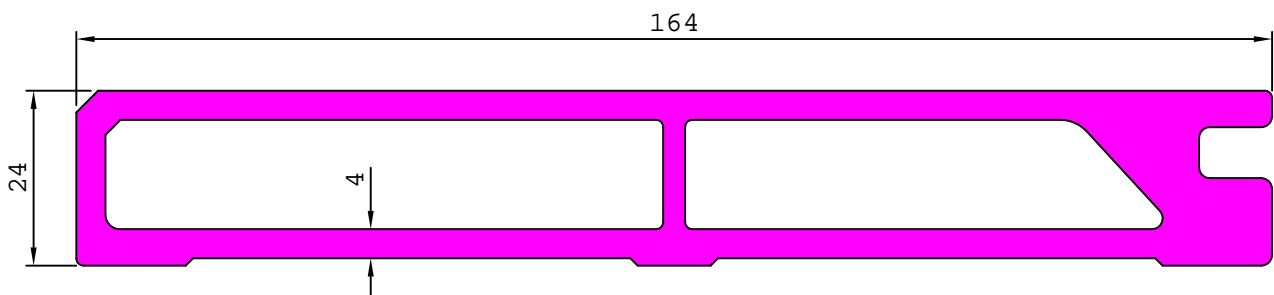

29092

9.153 kg/m

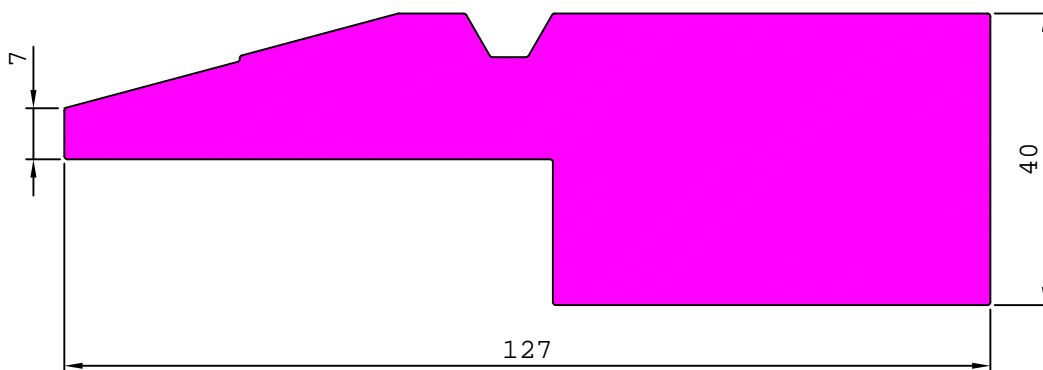

GENERAL

MISCELLANEOUS

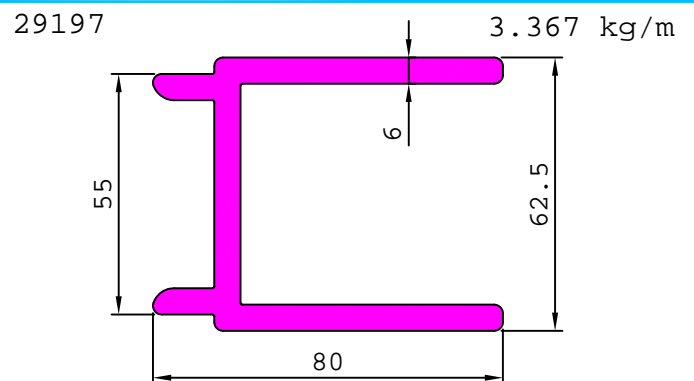
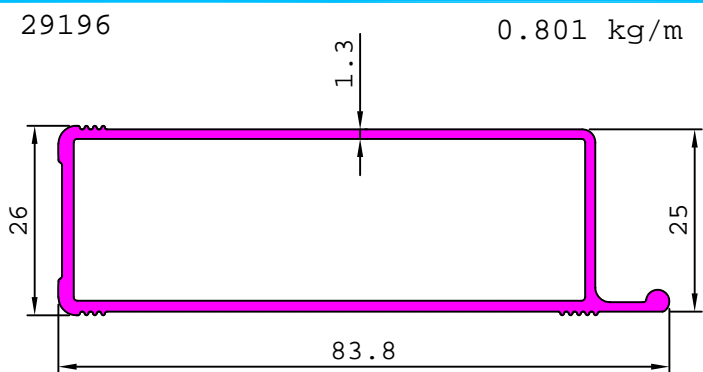
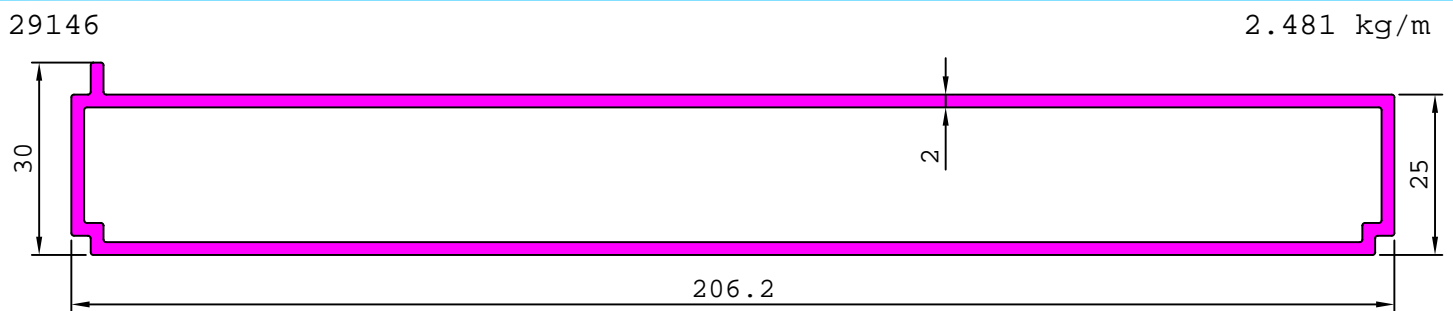
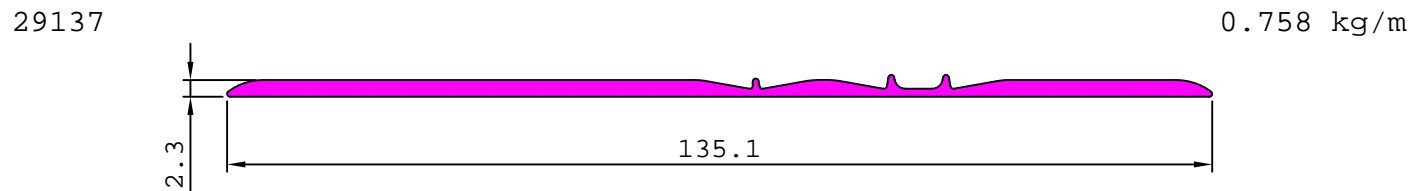
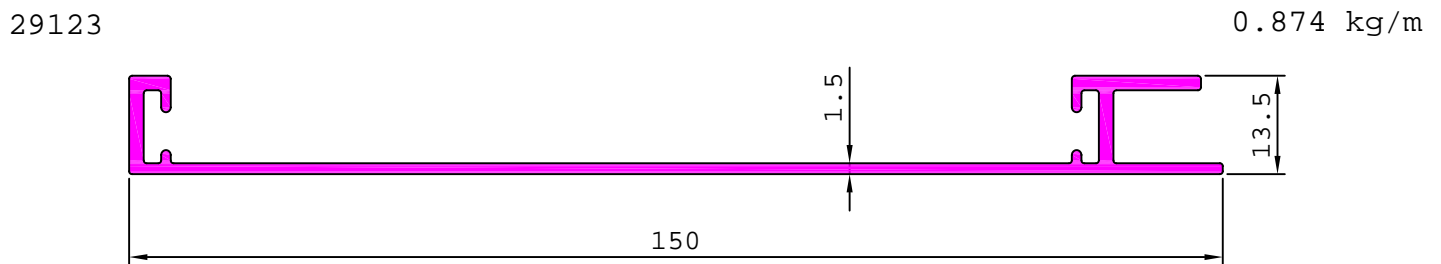
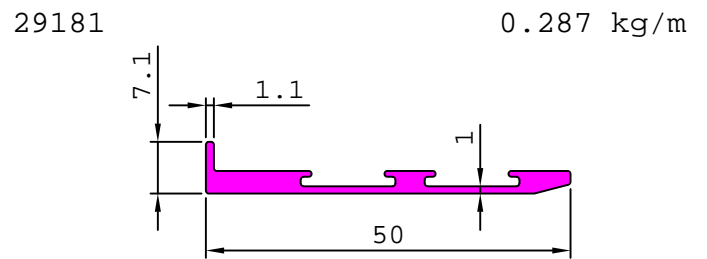
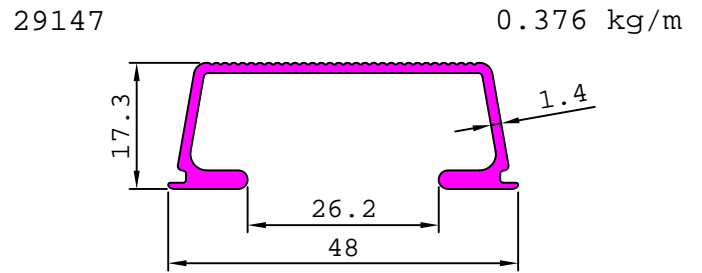
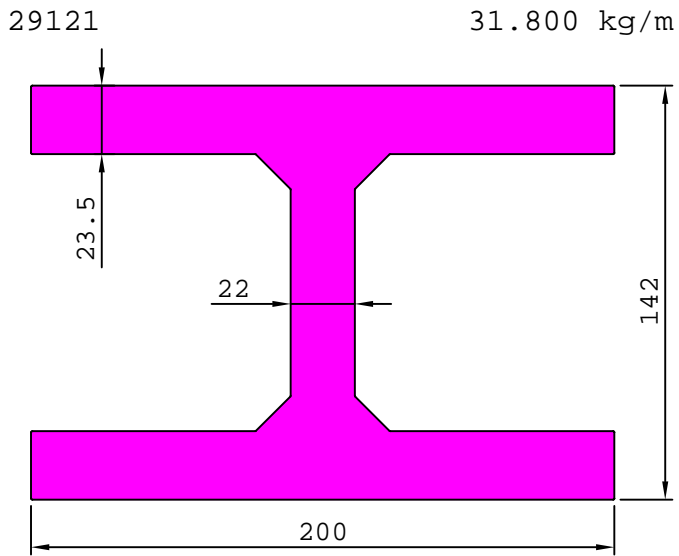

GENERAL

MISCELLANEOUS

29199

0.721 kg/m

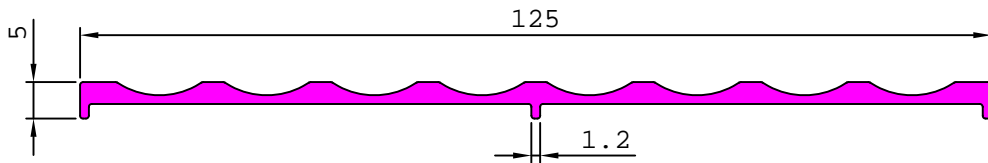

29212

0.431 kg/m

29213

0.778 kg/m

29220

0.518 kg/m

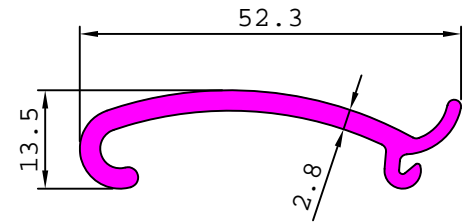
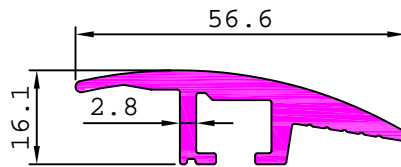
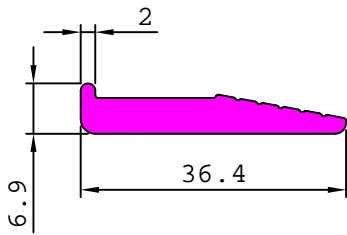

29219

0.594 kg/m

29232

1.215 kg/m

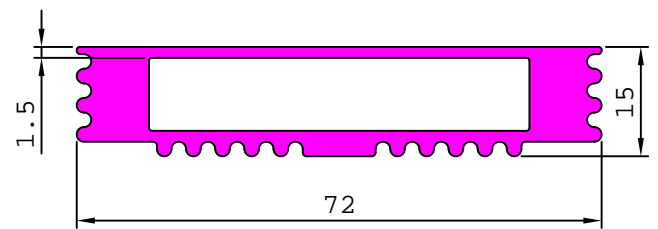
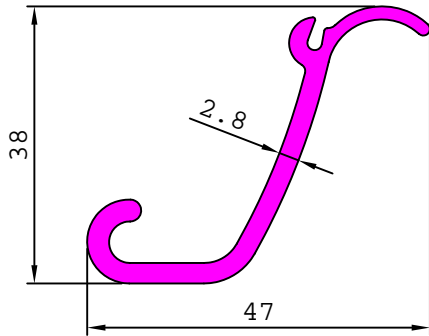

29233

1.675 kg/m

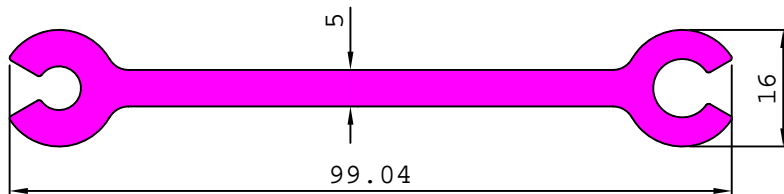

29234

0.428 kg/m

29236

7.371 kg/m

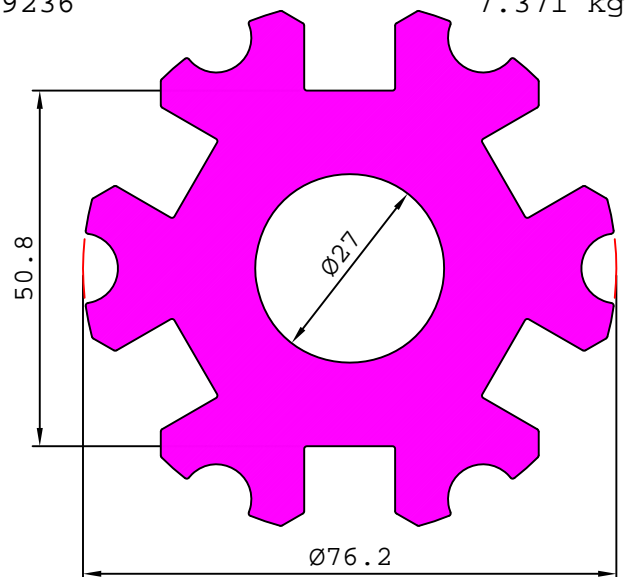
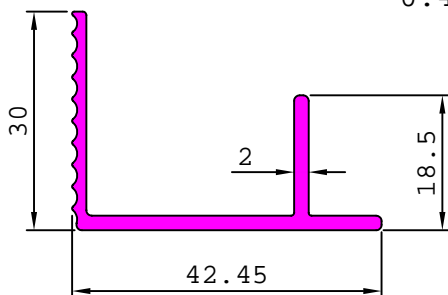

29238

0.351 kg/m

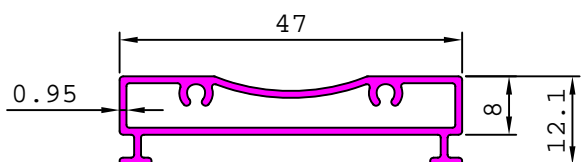

GENERAL

MISCELLANEOUS

29241 0.902 kg/m

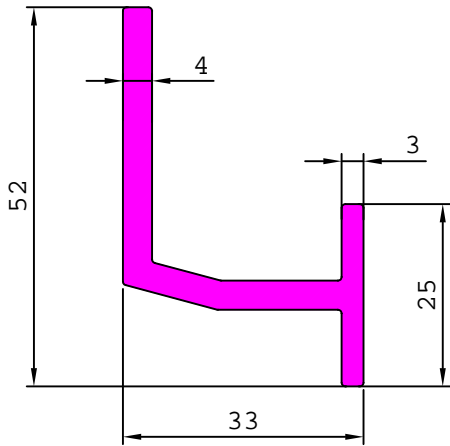

29250 4.459 kg/m

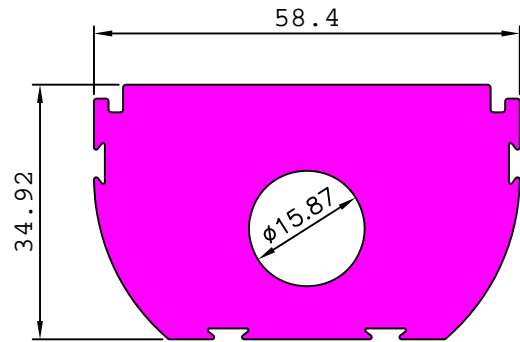

29251 0.575 kg/m

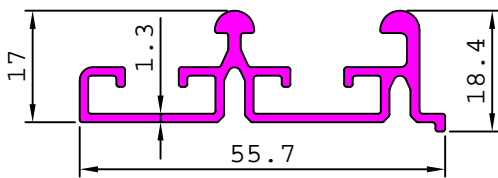

29252 0.716 kg/m

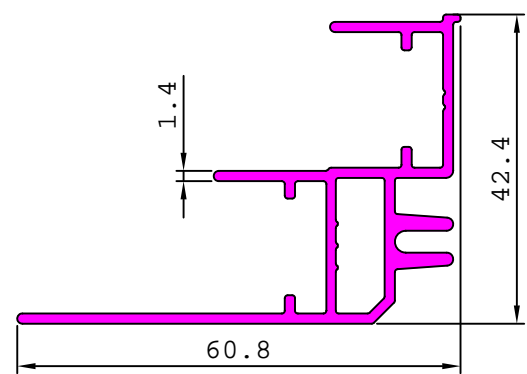

29254 0.482 kg/m

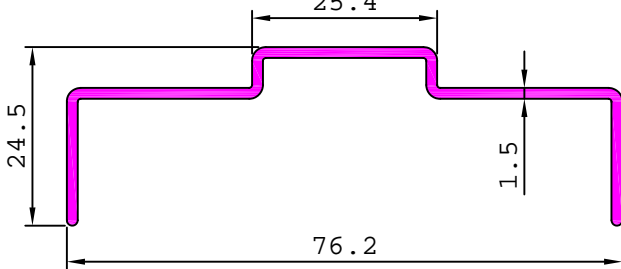

29286 4.360 kg/m

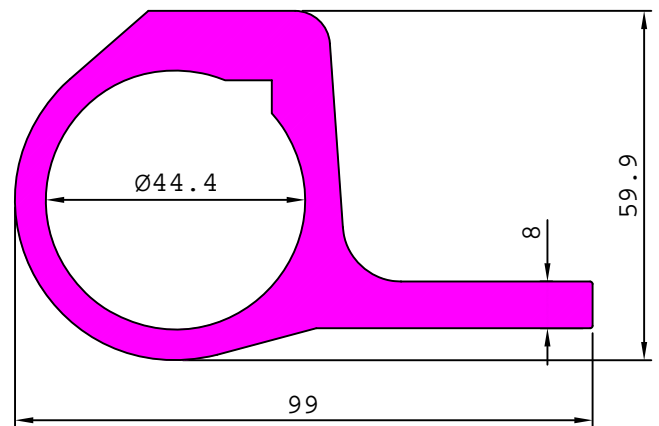

29253 12.970 kg/m

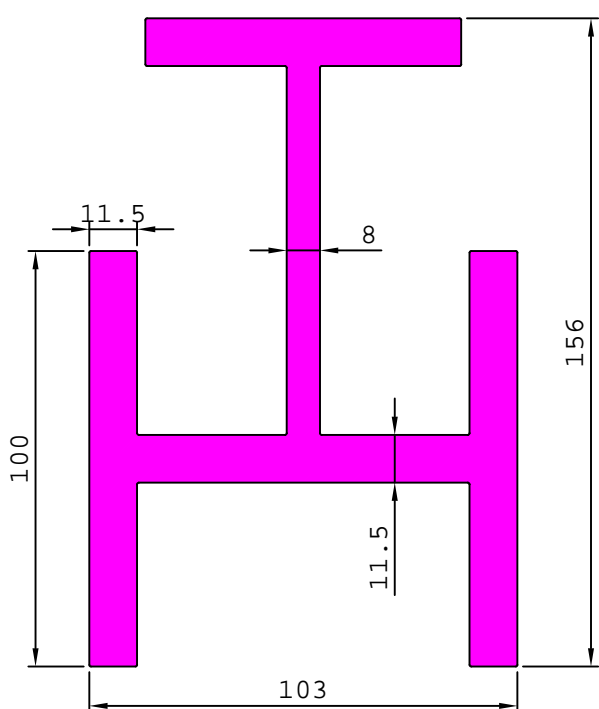

29392 1.811 kg/m

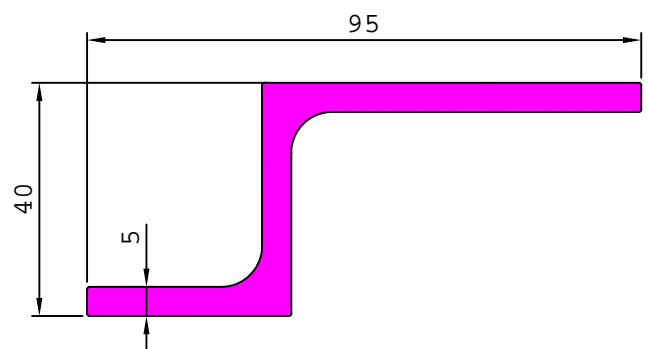

GENERAL

MISCELLANEOUS

29288 0.526 kg/m

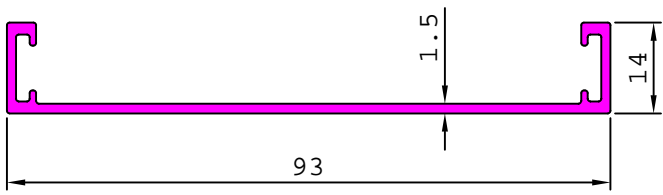

29290 0.147 kg/m

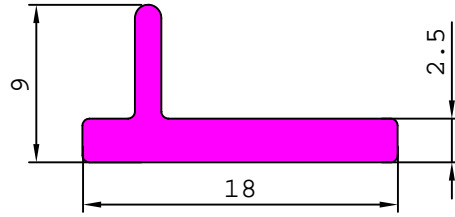

29294 0.629 kg/m

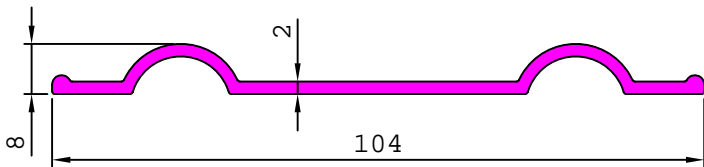

29303 4.944 kg/m

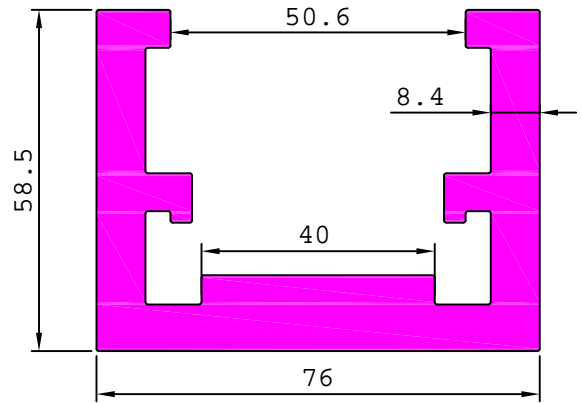

29309 0.251 kg/m

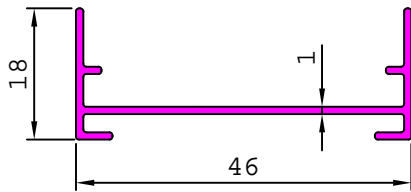

29304 1.701 kg/m

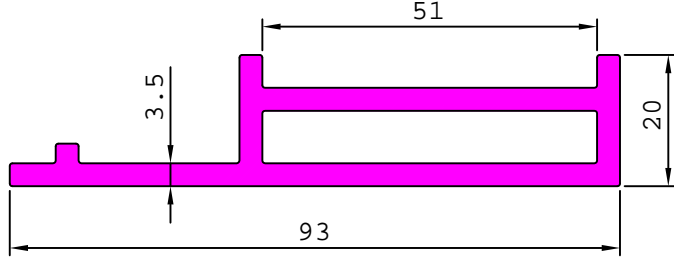

29305 1.858 kg/m

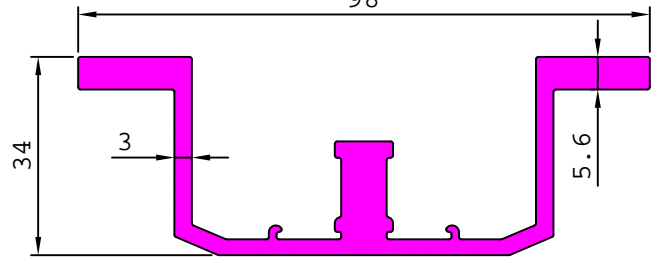

29306 1.294 kg/m

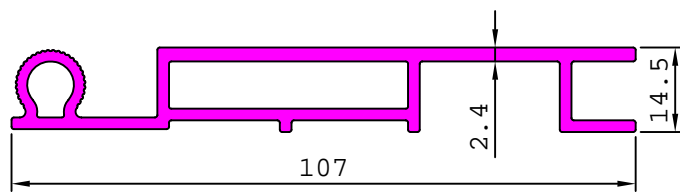

29307 1.193 kg/m

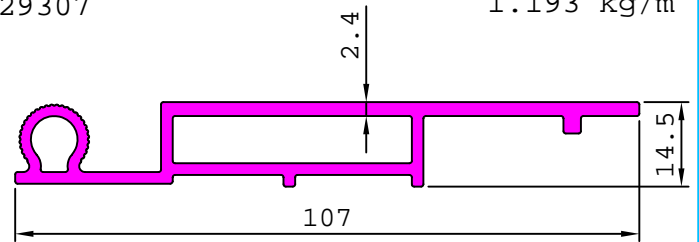

29317 0.449 kg/m

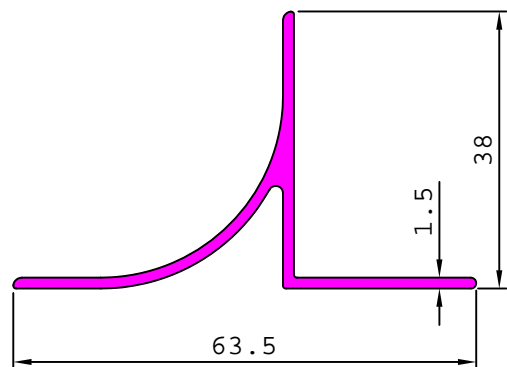

29323 2.251 kg/m

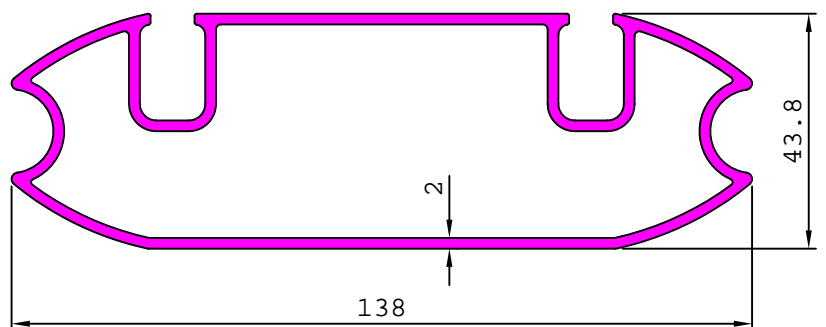

GENERAL

MISCELLANEOUS

29324

1.855 kg/m

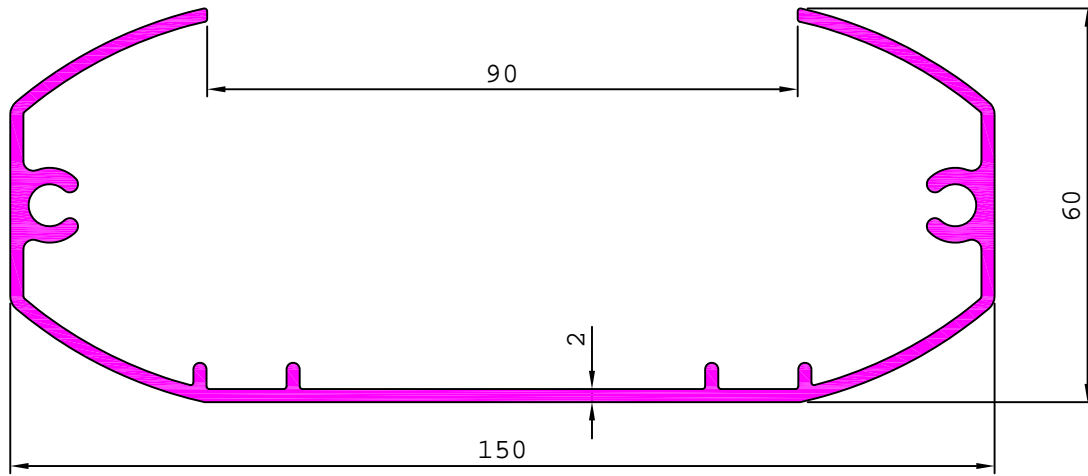

29326

1.053 kg/m

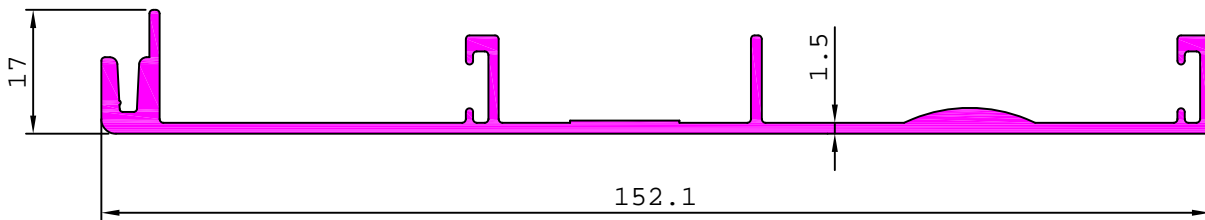

29327

5.219 kg/m

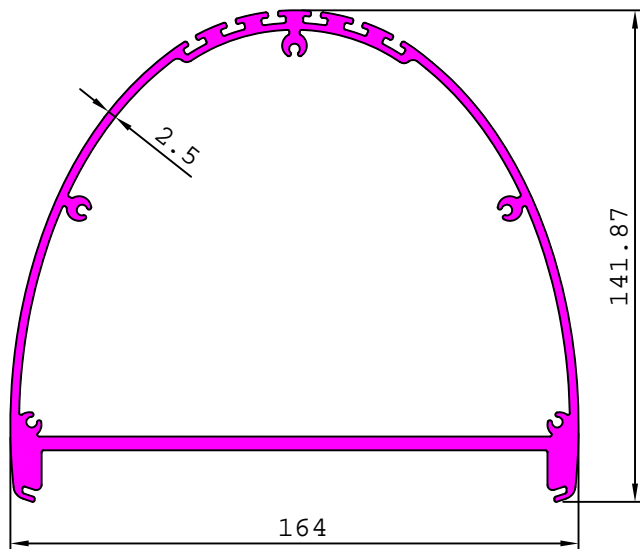

29338

2.653 kg/m

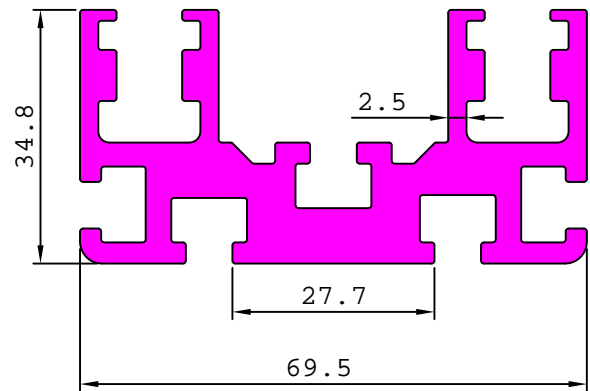

29331

0.253 kg/m

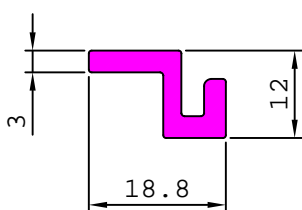

29333

0.473 kg/m

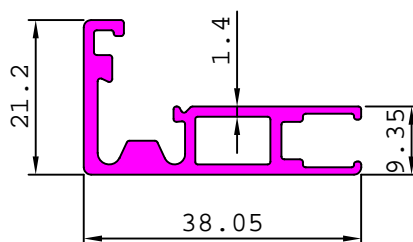

29334

0.315 kg/m

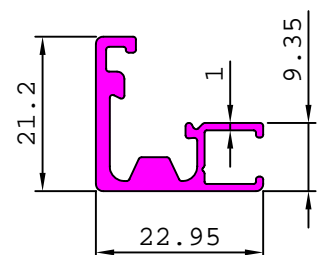

GENERAL

MISCELLANEOUS

29337 0.031 kg/m

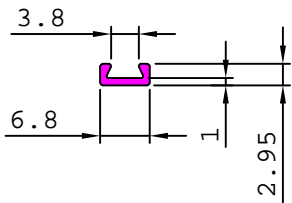

29347 0.587 kg/m

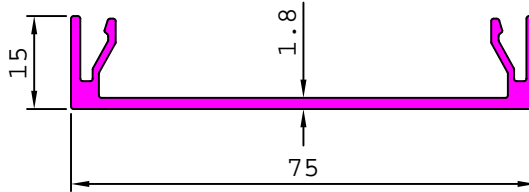

29339 0.225 kg/m

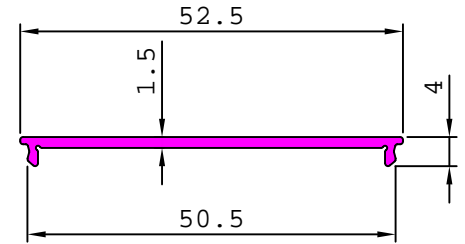

29344 1.326 kg/m

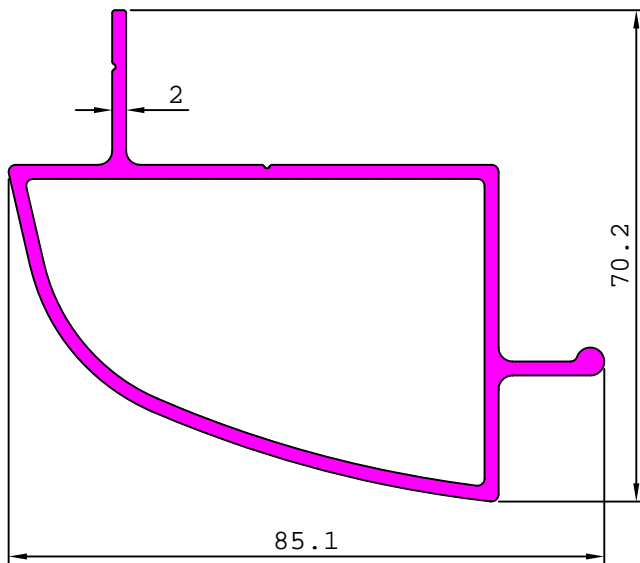

29350 0.993 kg/m

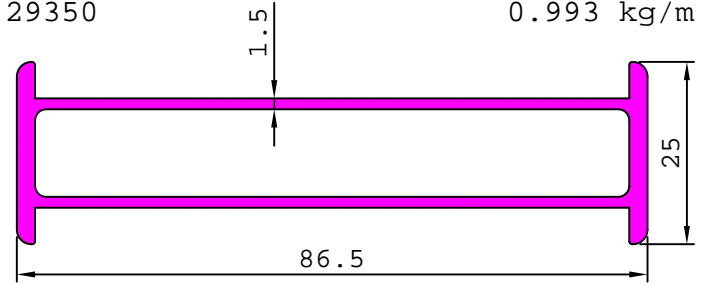

29354 0.058 kg/m

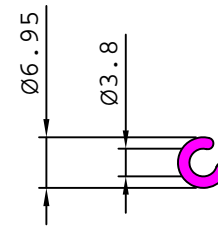

29349

1.347 kg/m

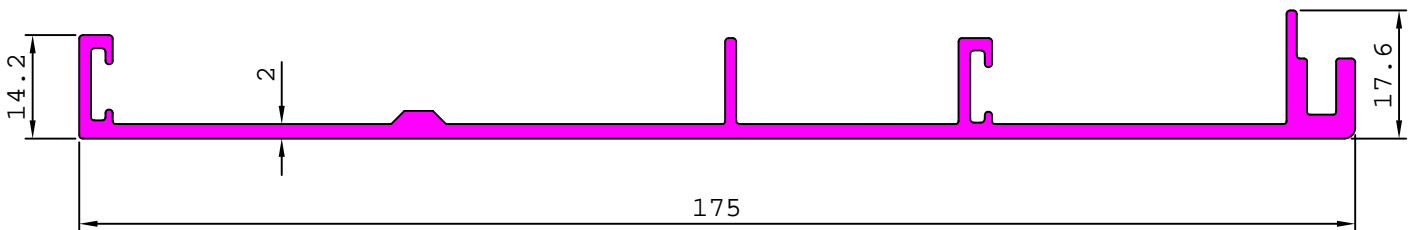

29356 1.408 kg/m

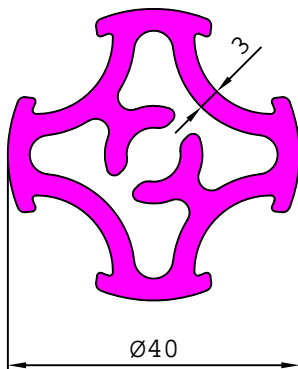

29357 0.918 kg/m

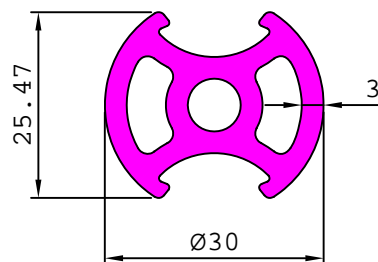

29373 0.753 kg/m

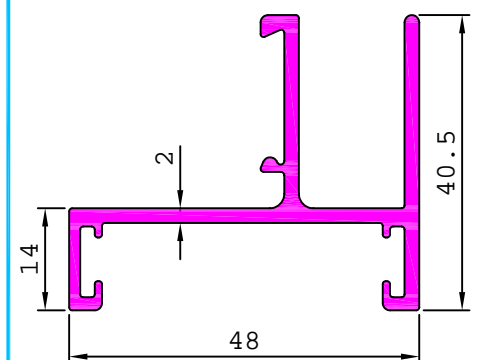

GENERAL

MISCELLANEOUS

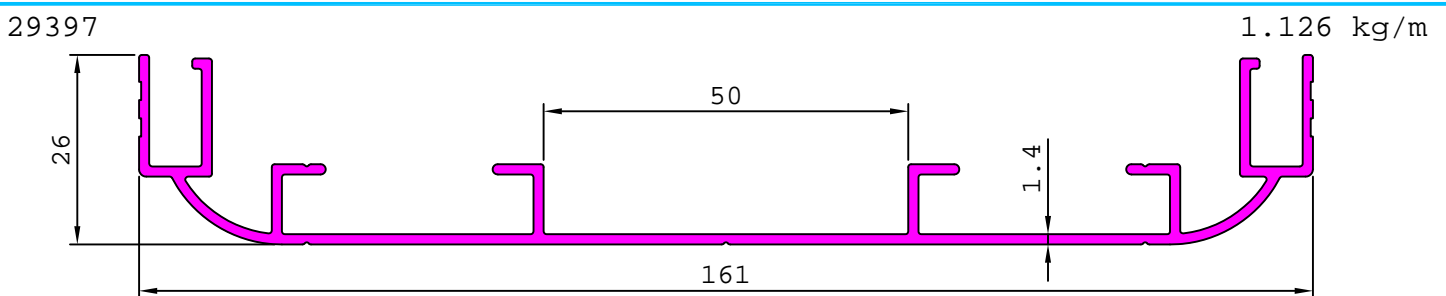
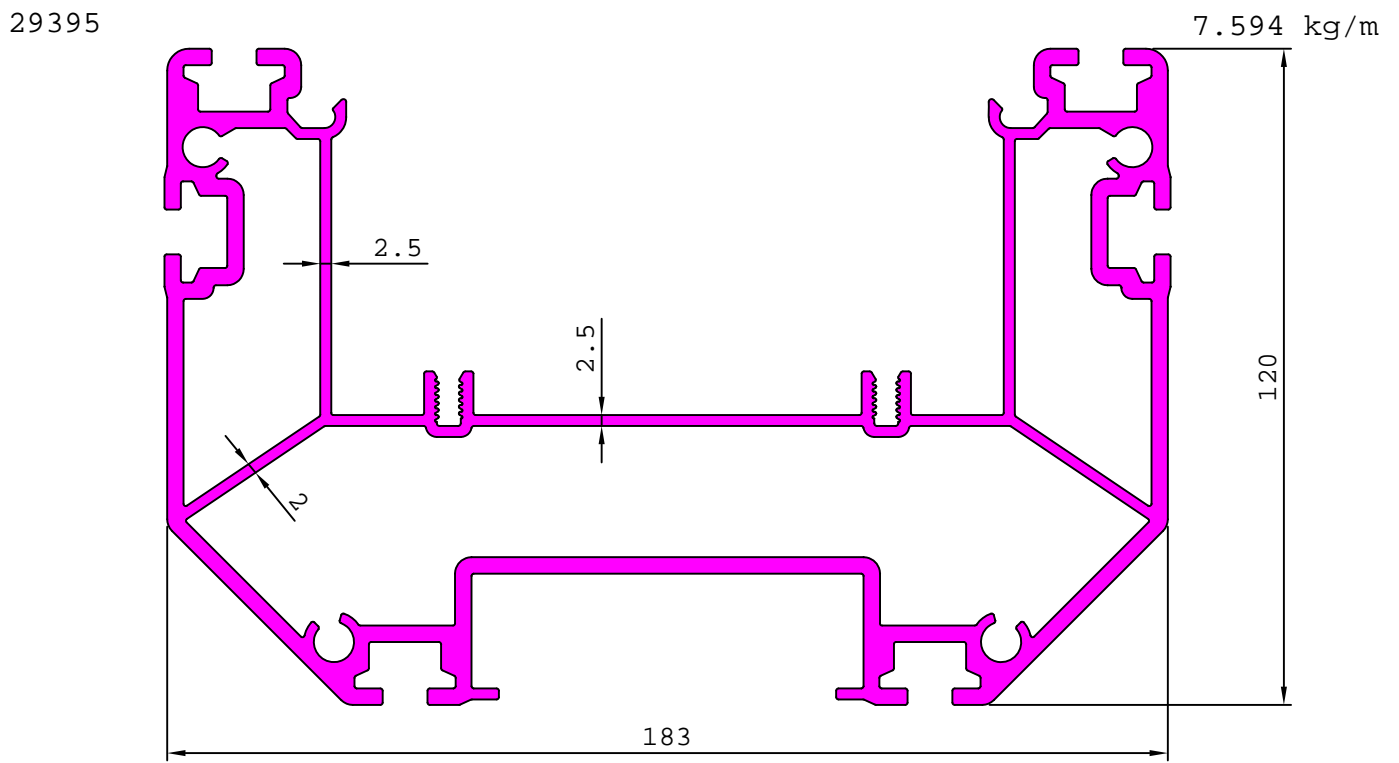
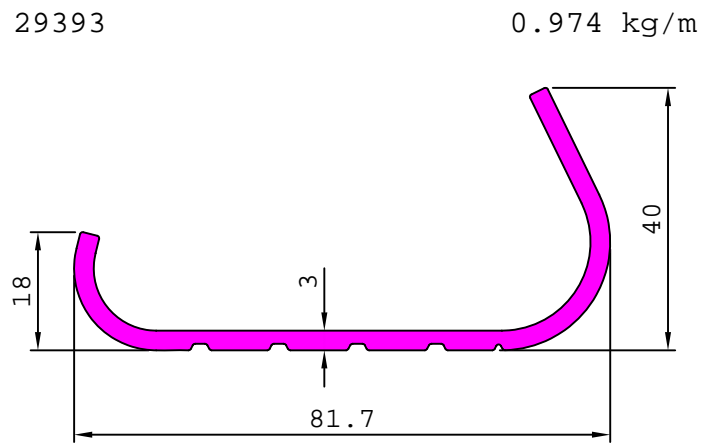
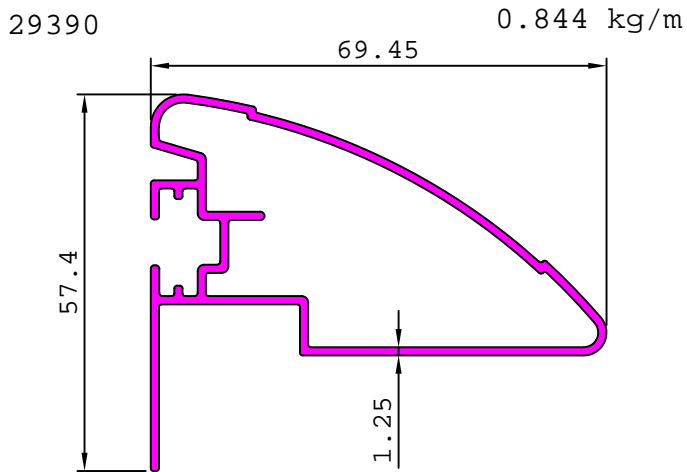
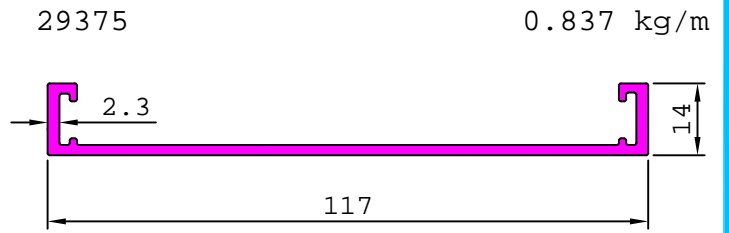
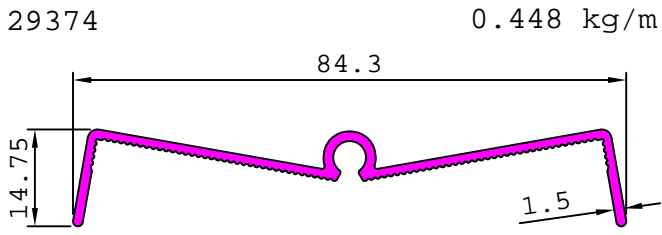

GENERAL

MISCELLANEOUS

29399 2.893 kg/m

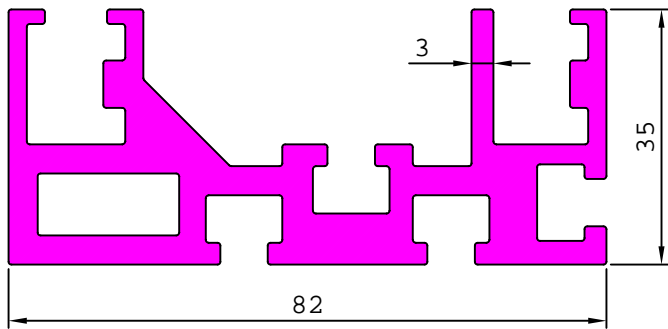

29406 0.459 kg/m

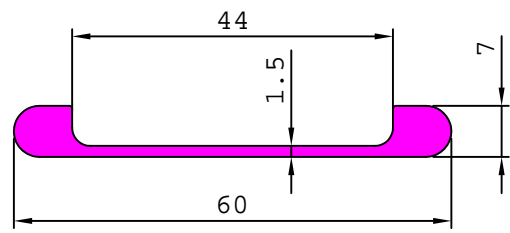

29413 0.403 kg/m

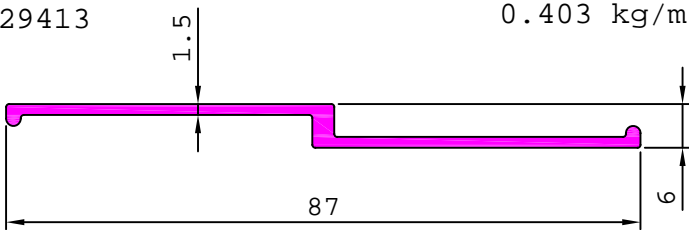

29414 1.480 kg/m

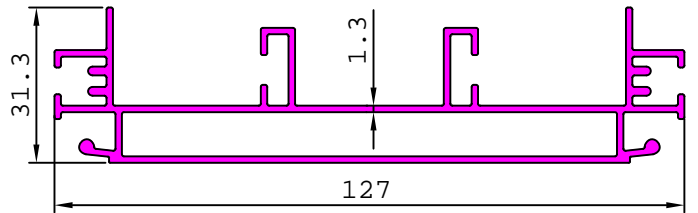

29412 2.167 kg/m

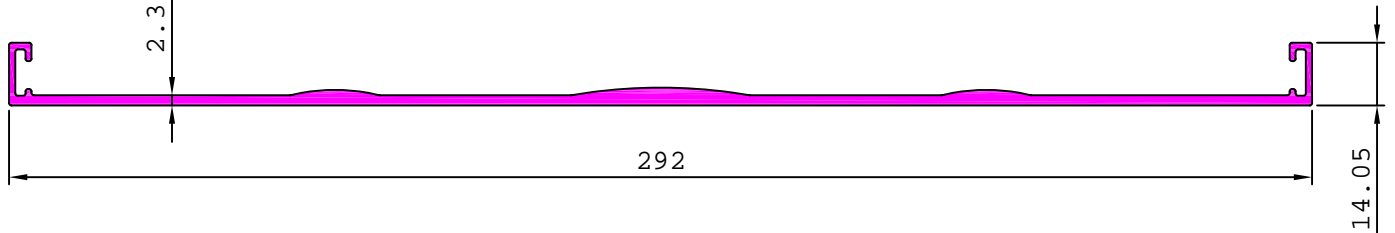

29417 0.910 kg/m

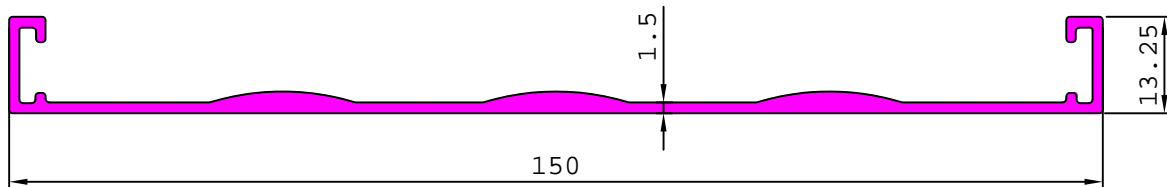

29422 0.475 kg/m

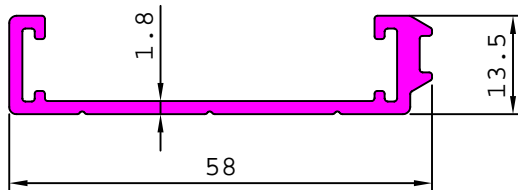

29428 0.660 kg/m

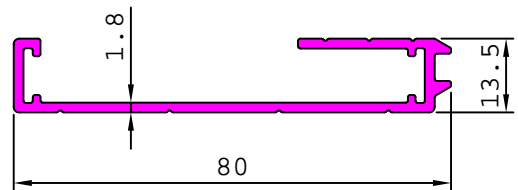

29423 2.353 kg/m

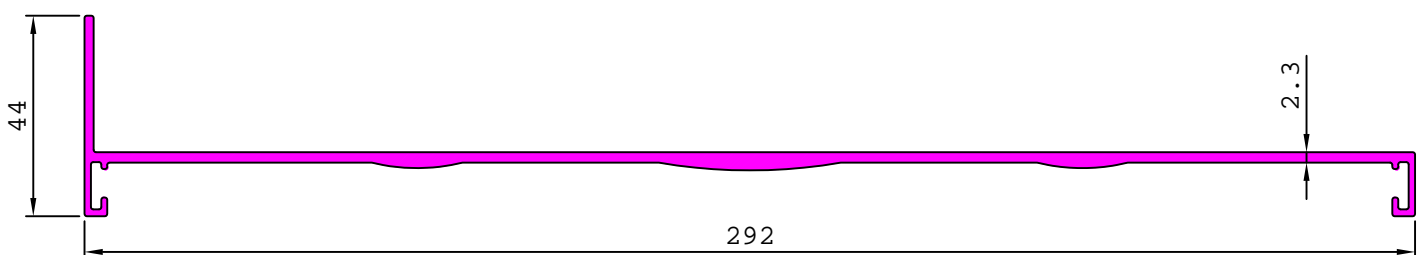

GENERAL

MISCELLANEOUS

29427

5.528 kg/m

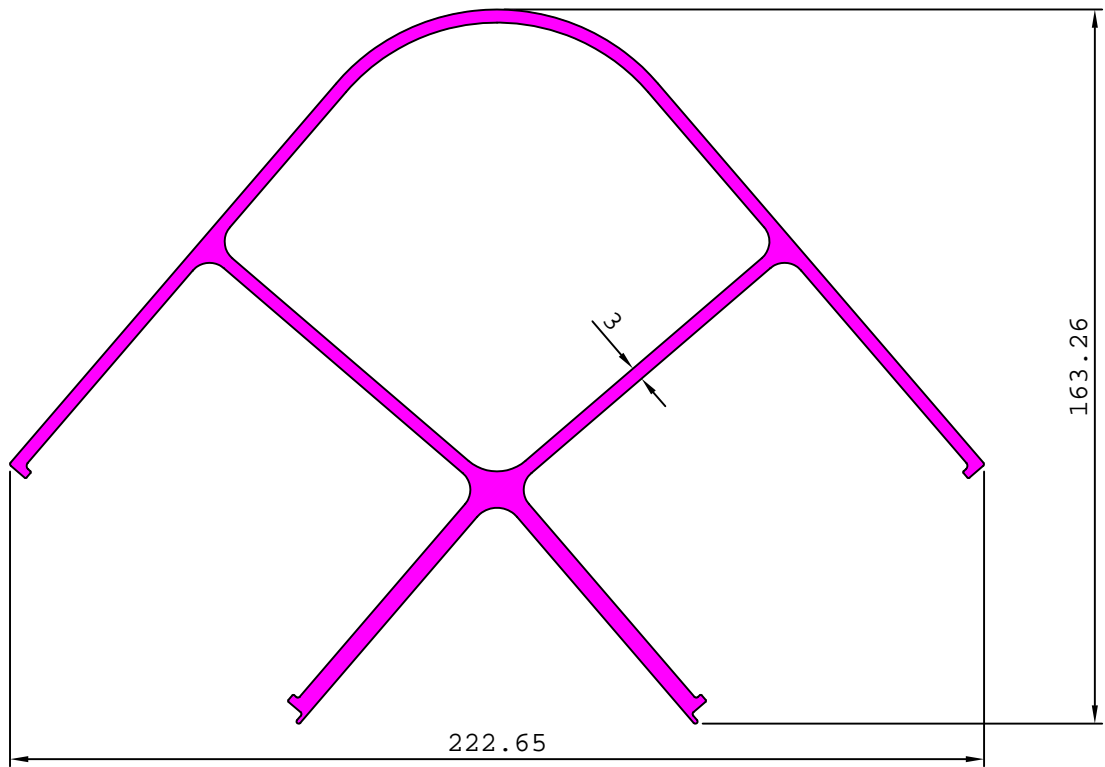

29429

2.284 kg/m

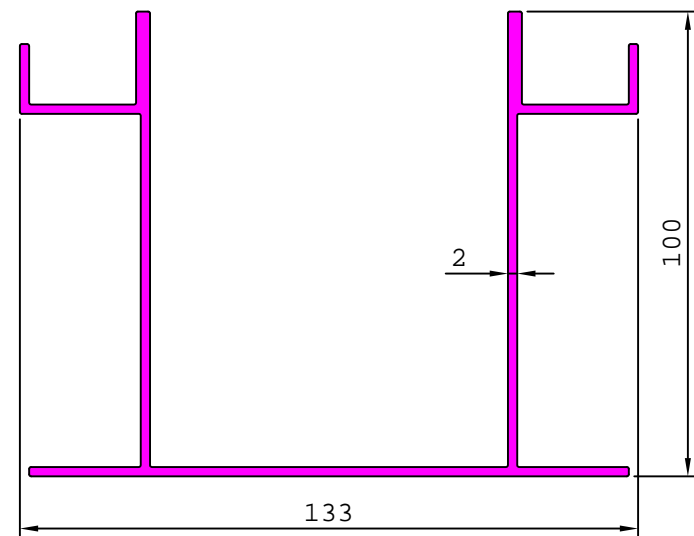

29454

0.734 kg/m

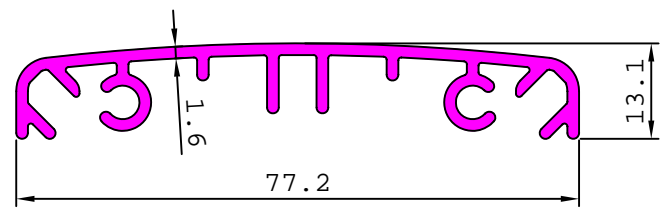

29455

1.072 kg/m

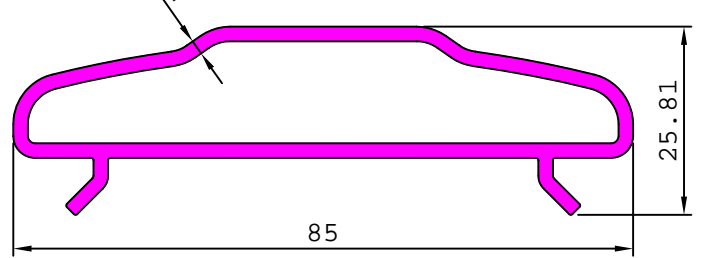

29431

5.666 kg/m

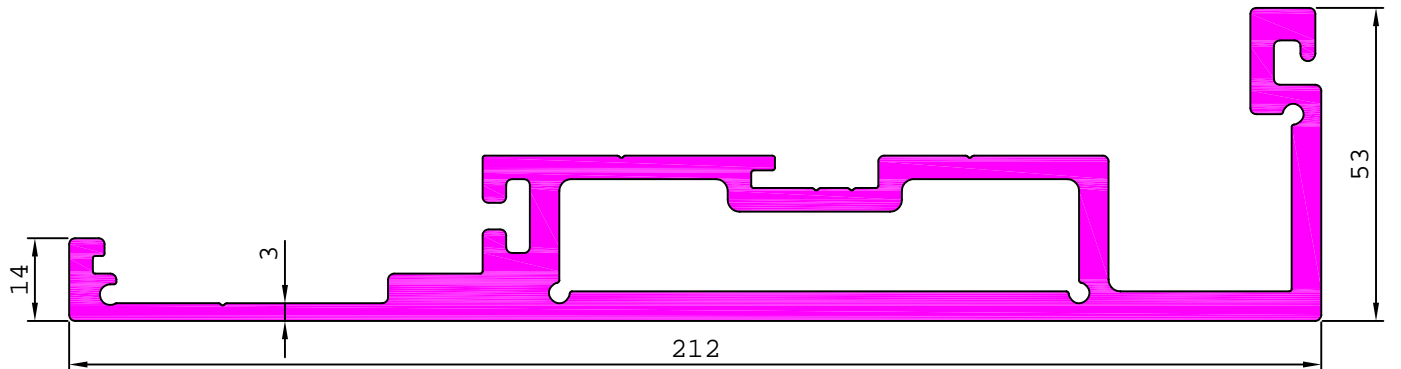

GENERAL

MISCELLANEOUS

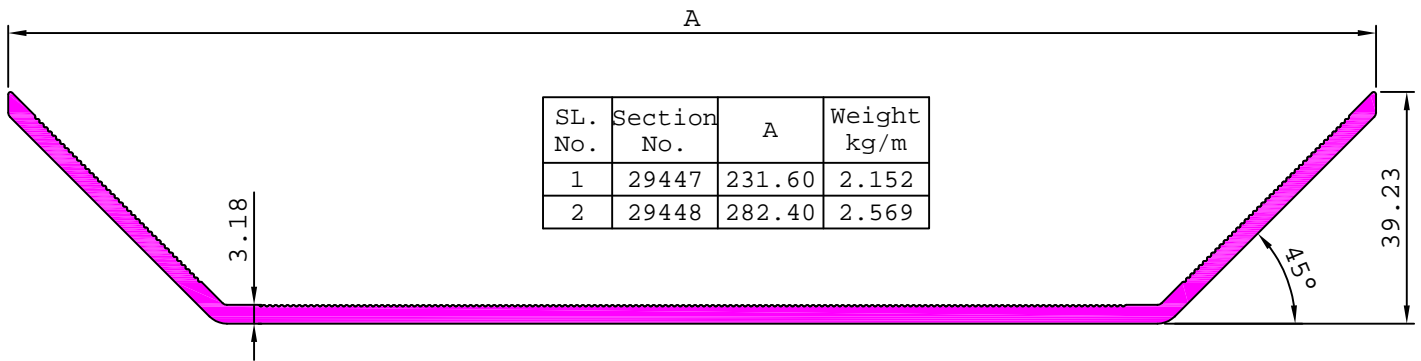

SL. No.	Section No.	A	Weight kg/m
1	29447	231.60	2.152
2	29448	282.40	2.569

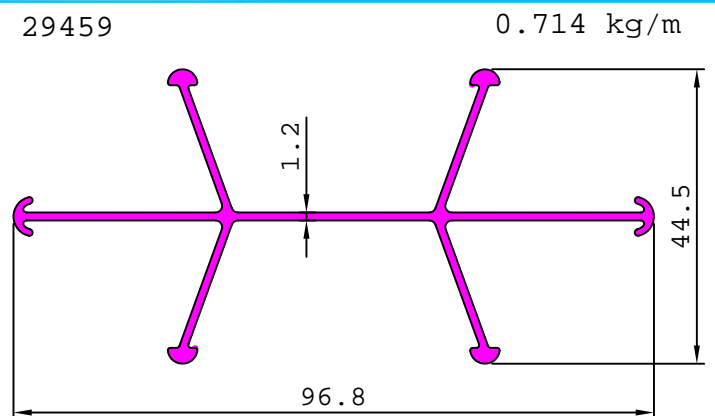
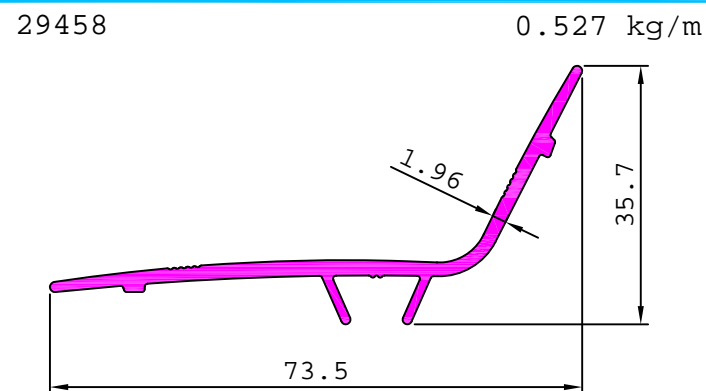
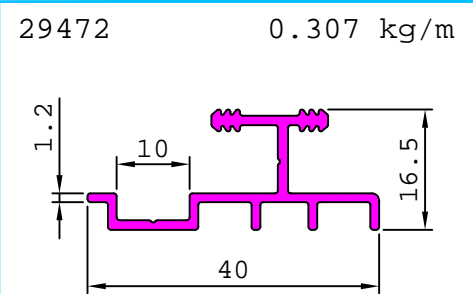
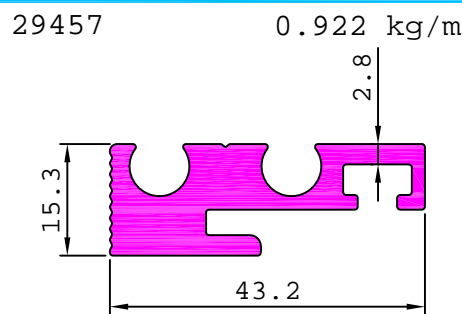
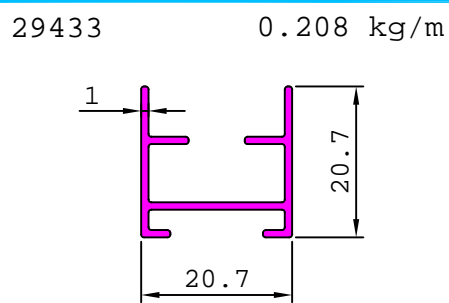
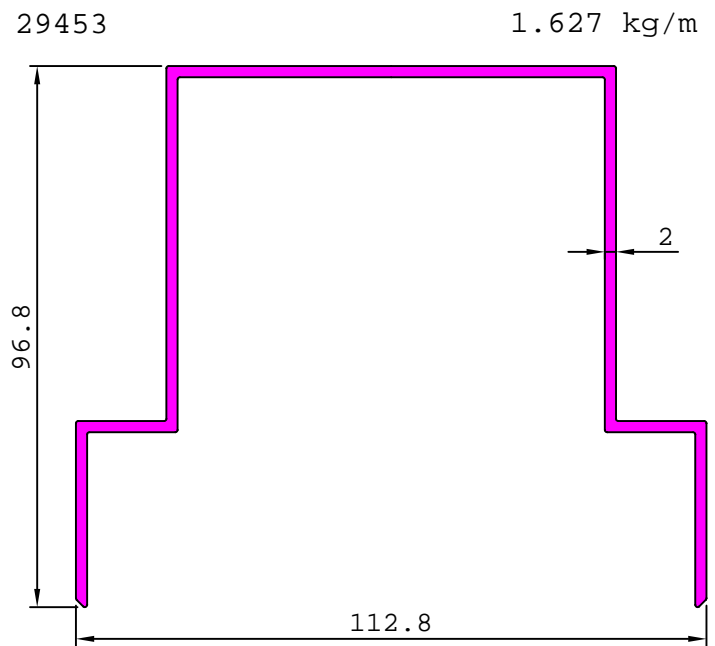
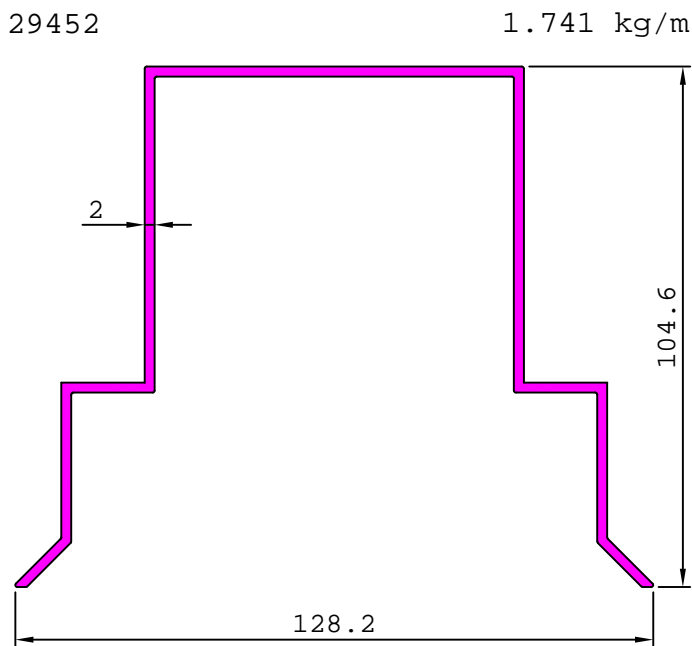

GENERAL

MISCELLANEOUS

29460

1.343 kg/m

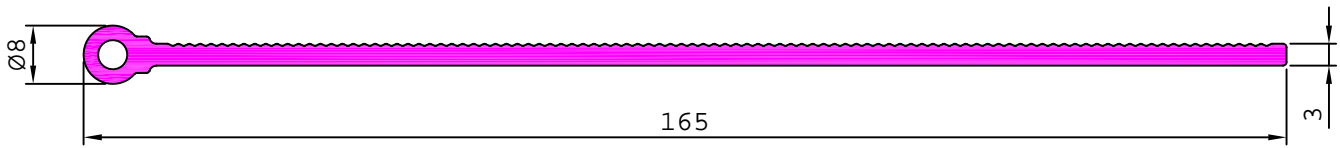

29461

1.340 kg/m

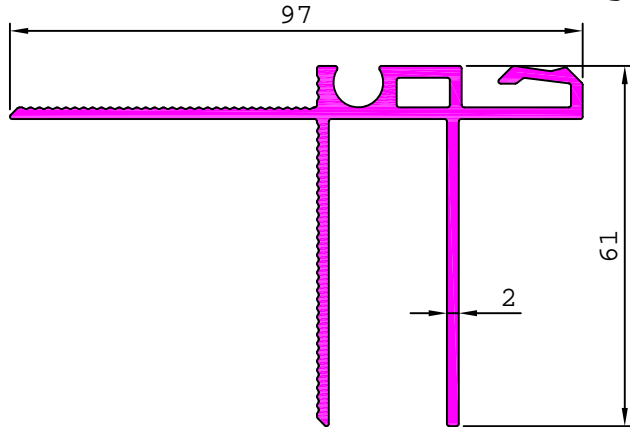

29462

1.754 kg/m

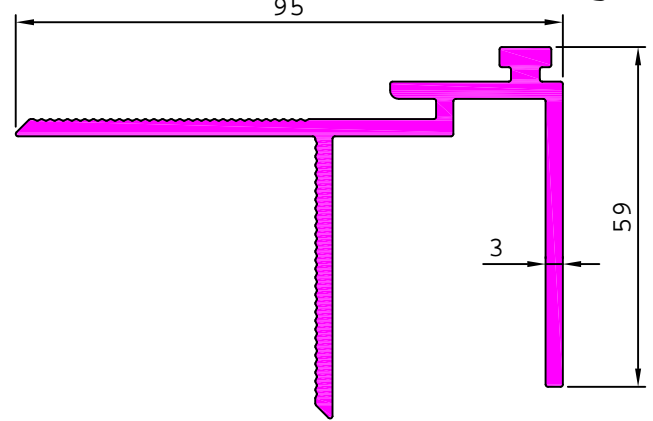

29463

3.397 kg/m

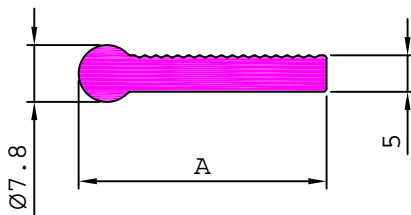
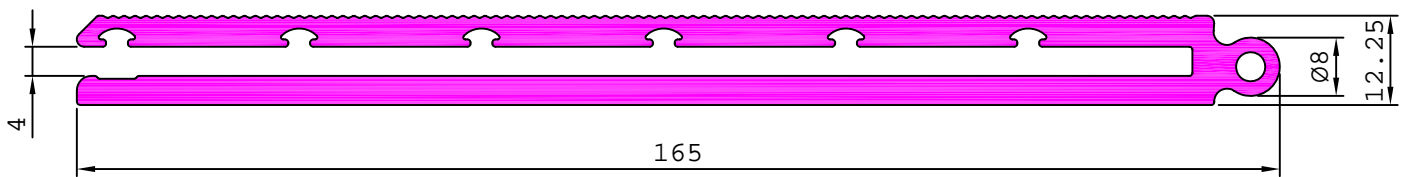

SL. No.	Section No.	A	Weight kg/m
1	29480	34.00	0.476
2	29481	56.00	0.765
3	29531	92.80	1.248
4	29464	160.00	2.130

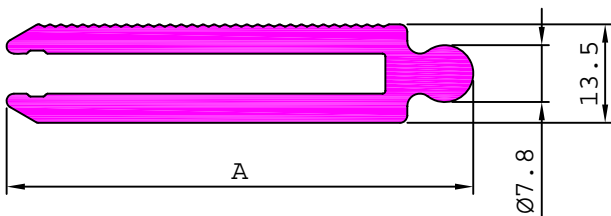

SL. No.	Section No.	A	Weight kg/m
1	29478	64.00	1.334
2	29513	96.20	2.020
3	29571	135.00	2.839
4	29465	142.00	3.000

29468

0.479 kg/m

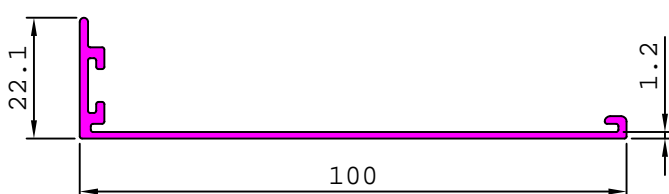

29471

1.425 kg/m

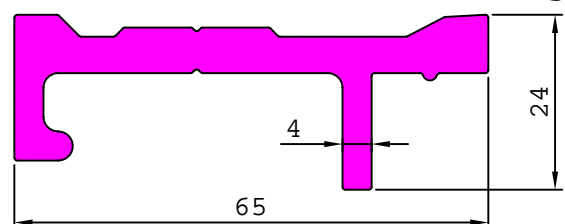

GENERAL

MISCELLANEOUS

29467 2.795 kg/m

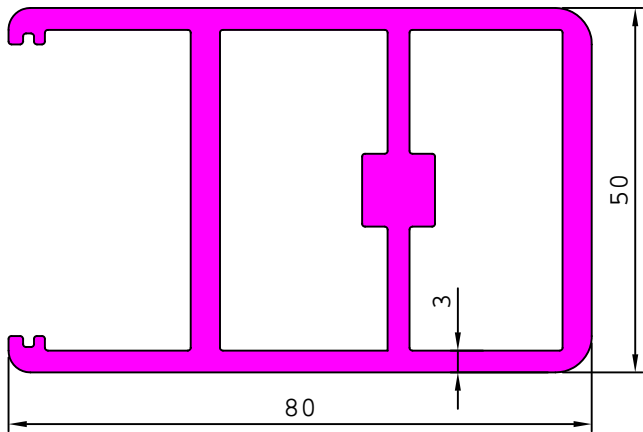

29473 0.254 kg/m

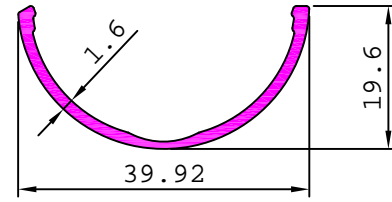

29479 0.816 kg/m

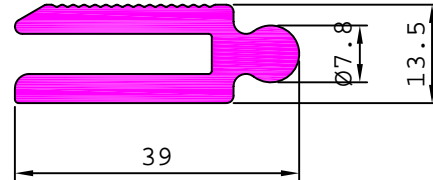

29474 1.301 kg/m

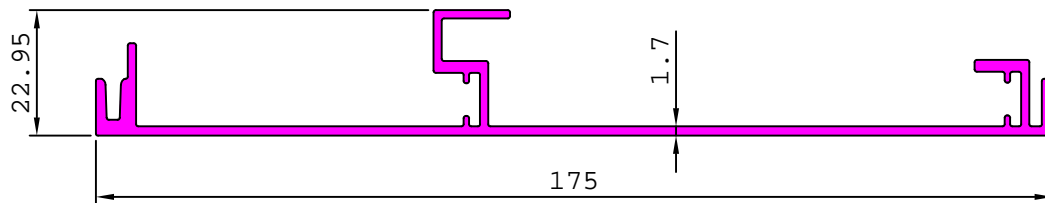

29475 10.947 kg/m

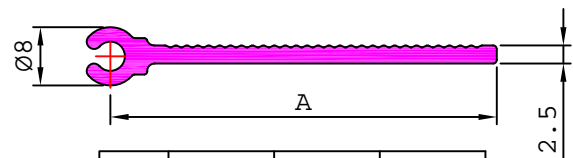
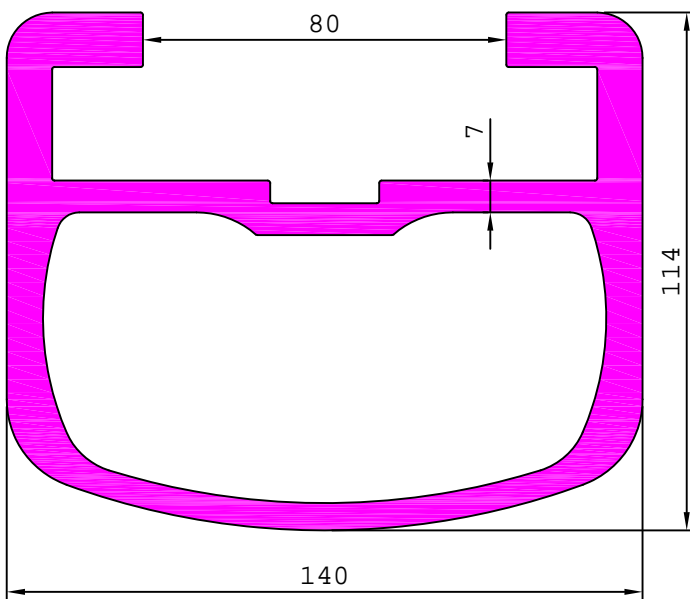

SL. No.	Section No.	A	Weight kg/m
1	29486	28.00	0.252
2	29485	53.00	0.412
3	29529	100.20	0.712
4	29484	128.00	0.888

29488 1.133 kg/m

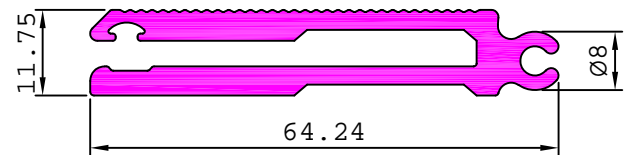

29482 1.414 kg/m

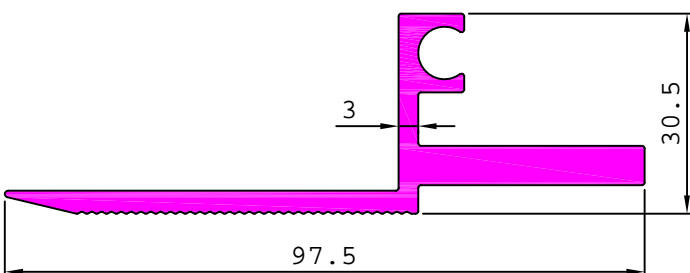

29483 1.562 kg/m

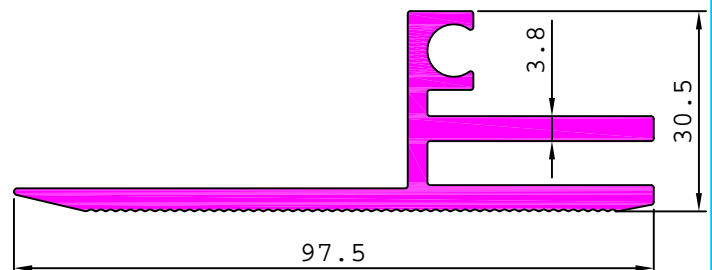

GENERAL

MISCELLANEOUS

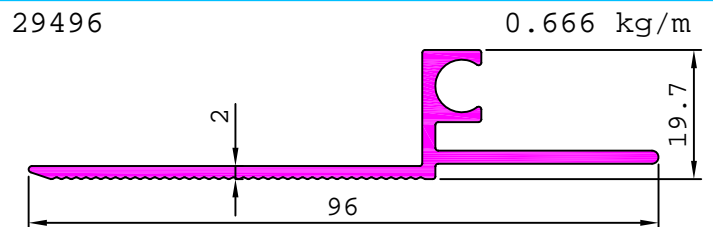
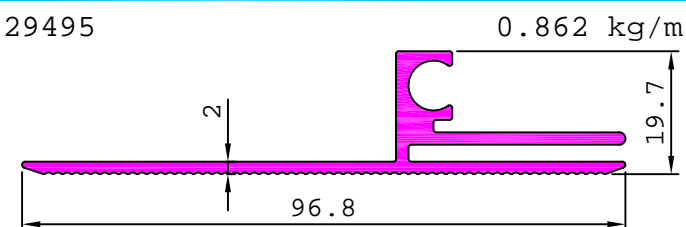
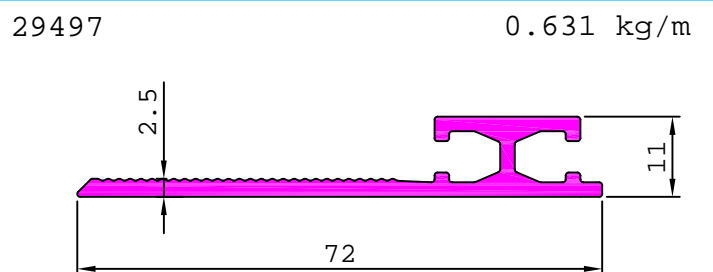
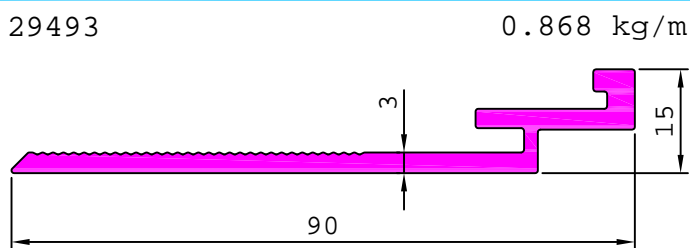
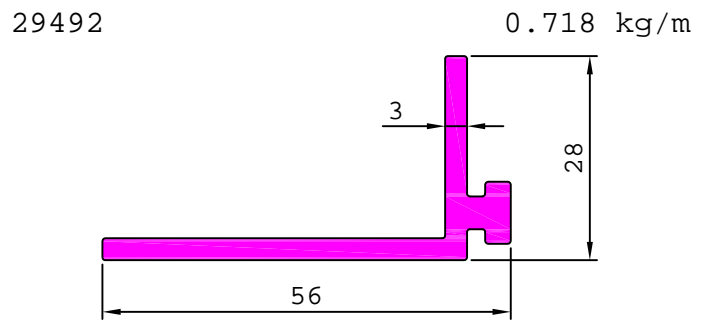
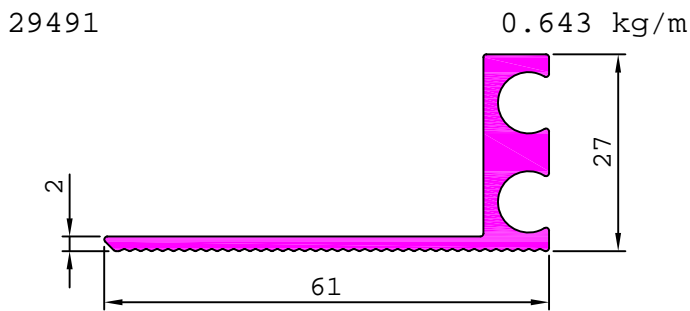
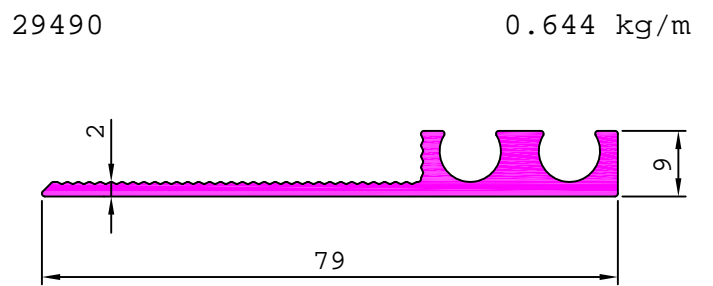
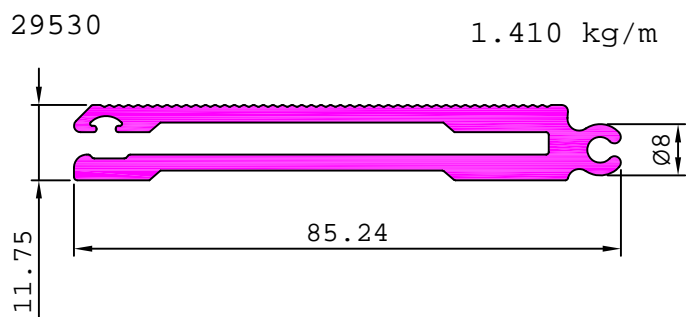
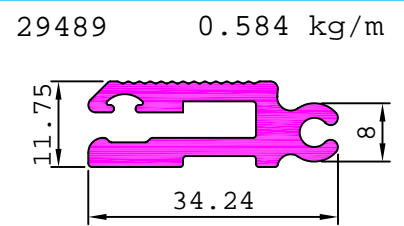
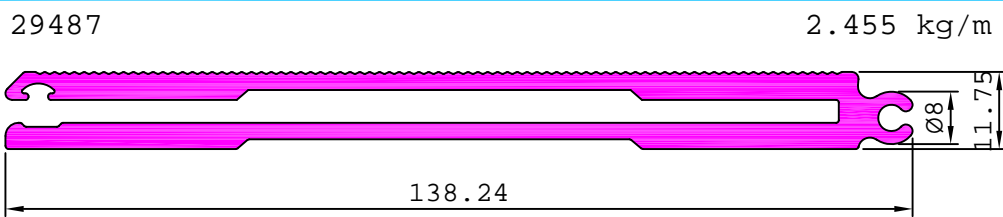
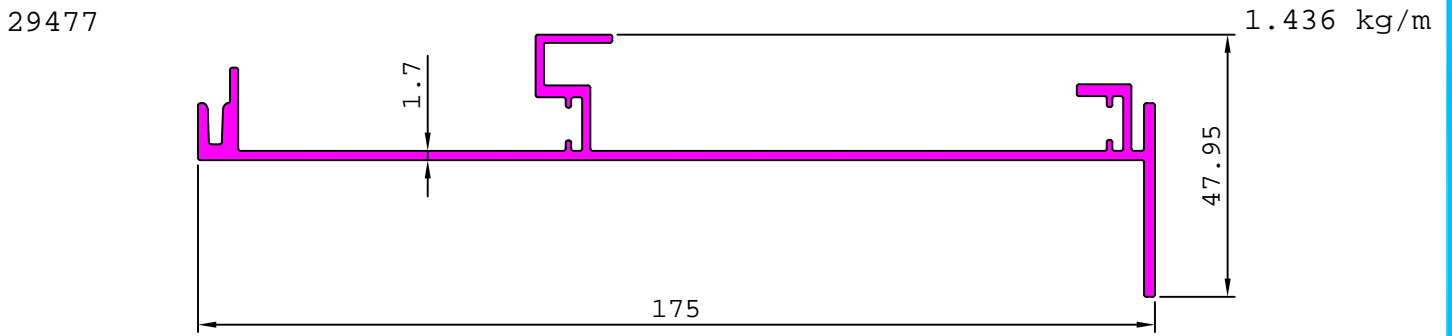

GENERAL

MISCELLANEOUS

29494 0.866 kg/m

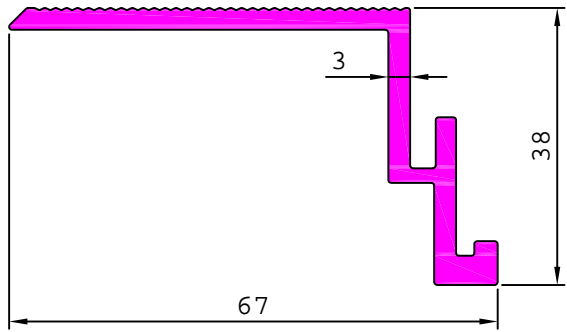

29498 0.725 kg/m

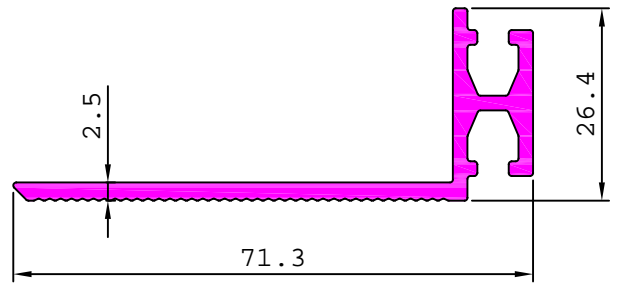

29499 0.319 kg/m

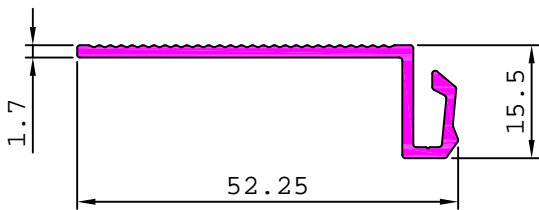

29532 0.462 kg/m

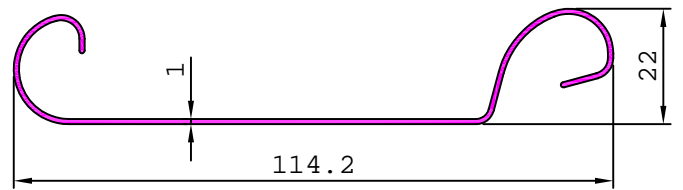

29500 1.196 kg/m

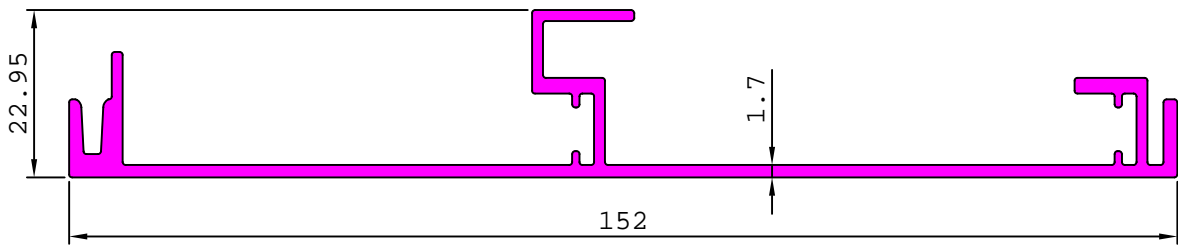

29501 1.325 kg/m

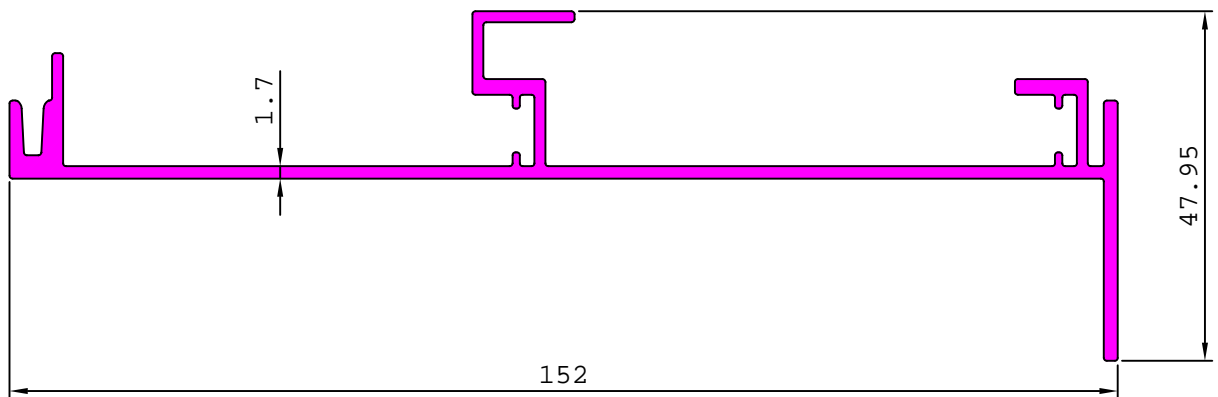

29503 0.188 kg/m

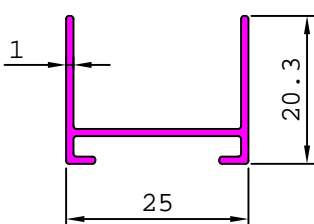

29504 0.326 kg/m

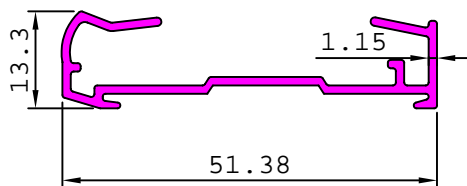

29526 0.275 kg/m

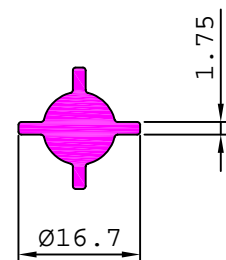

GENERAL

MISCELLANEOUS

29505

0.895 kg/m

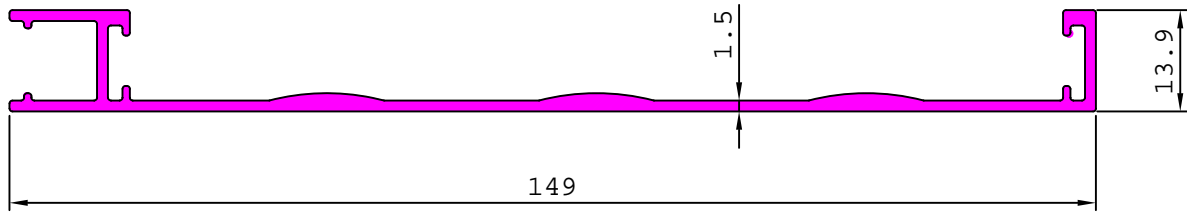

29506

1.717 kg/m

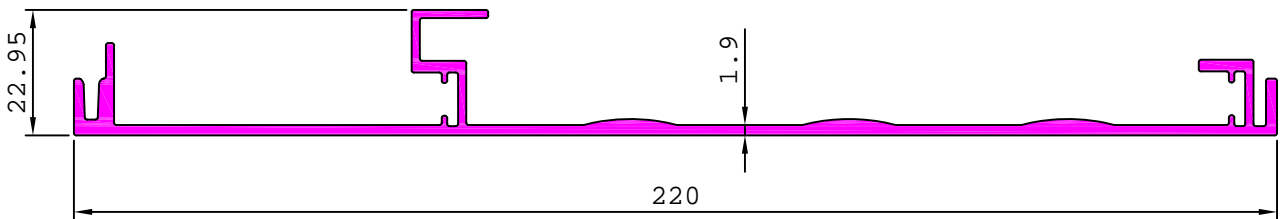

29507

3.353 kg/m

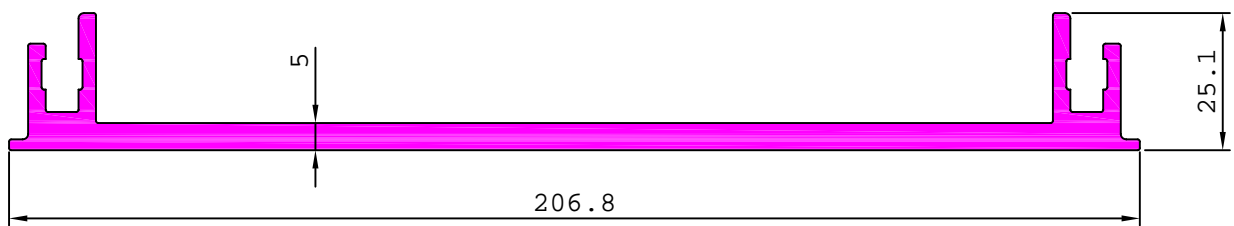

29508

4.436 kg/m

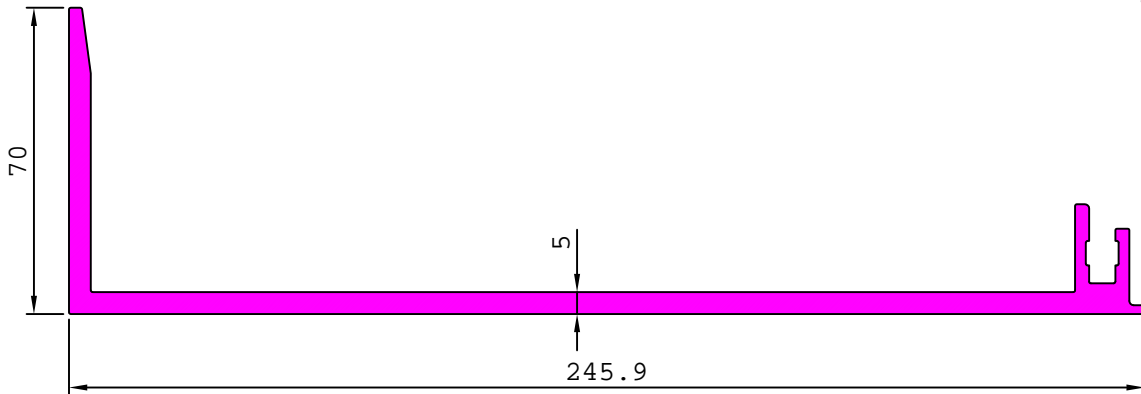

29511

1.627 kg/m

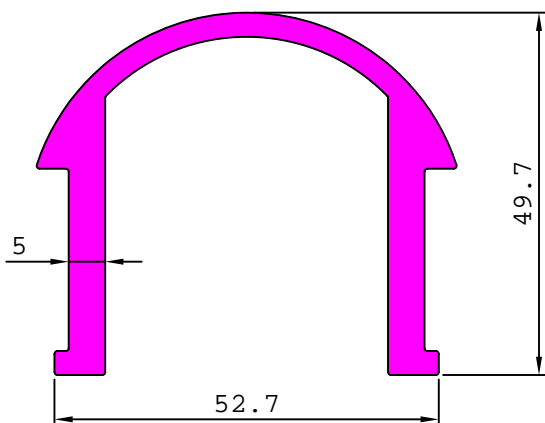

29510

0.914 kg/m

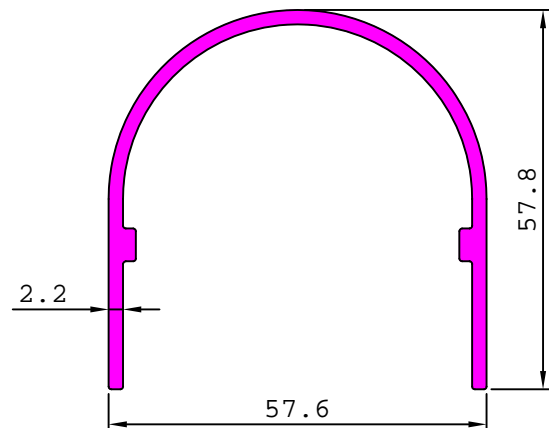

GENERAL

MISCELLANEOUS

29515 0.640 kg/m

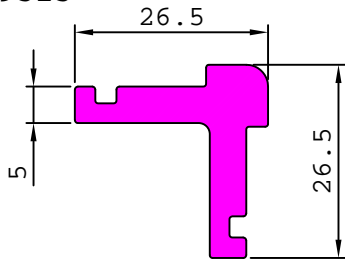

29516 0.941 kg/m

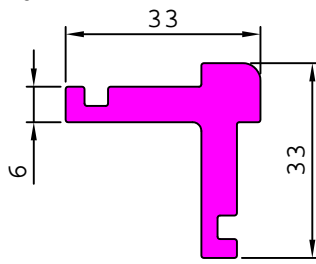

29536 0.166 kg/m

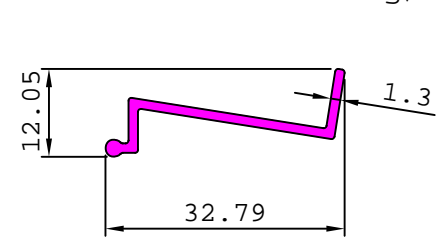

29518

2.620 kg/m

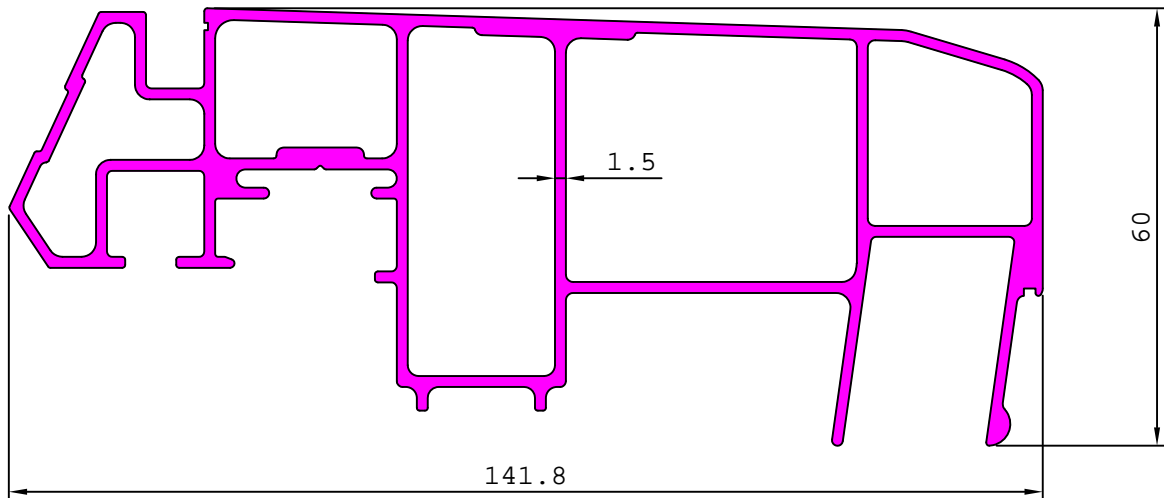

29520

1.872 kg/m

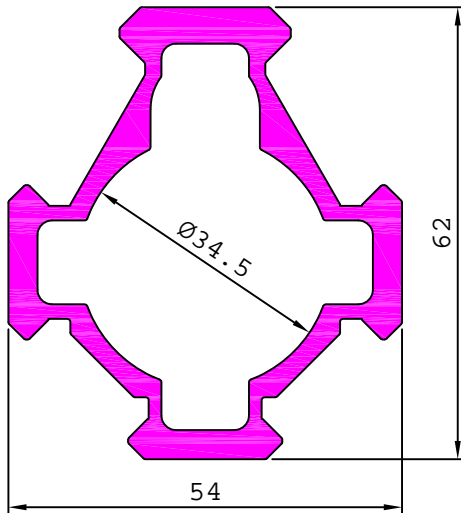

29523

3.730 kg/m

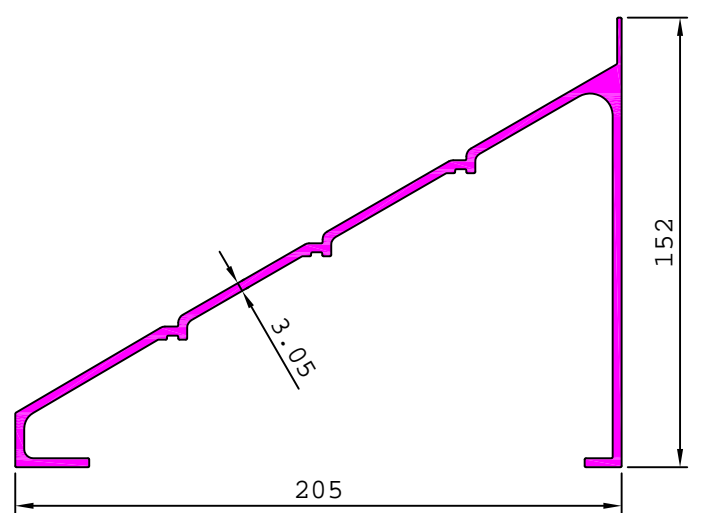

29522

2.267 kg/m

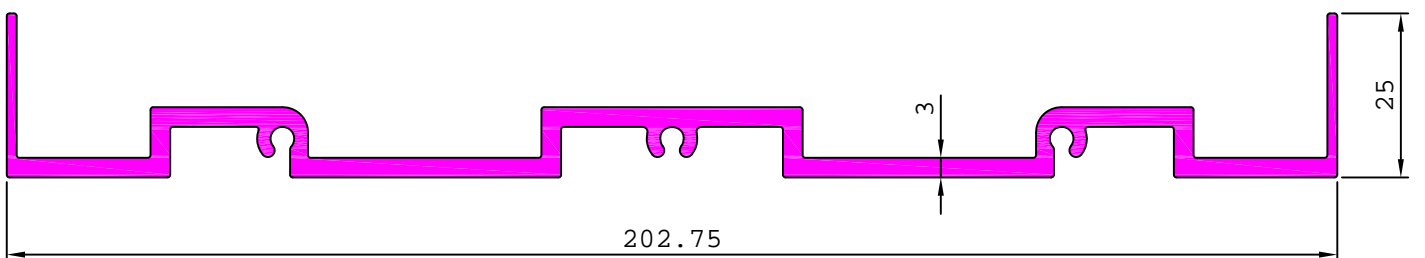

GENERAL

MISCELLANEOUS

29521

4.823 kg/m

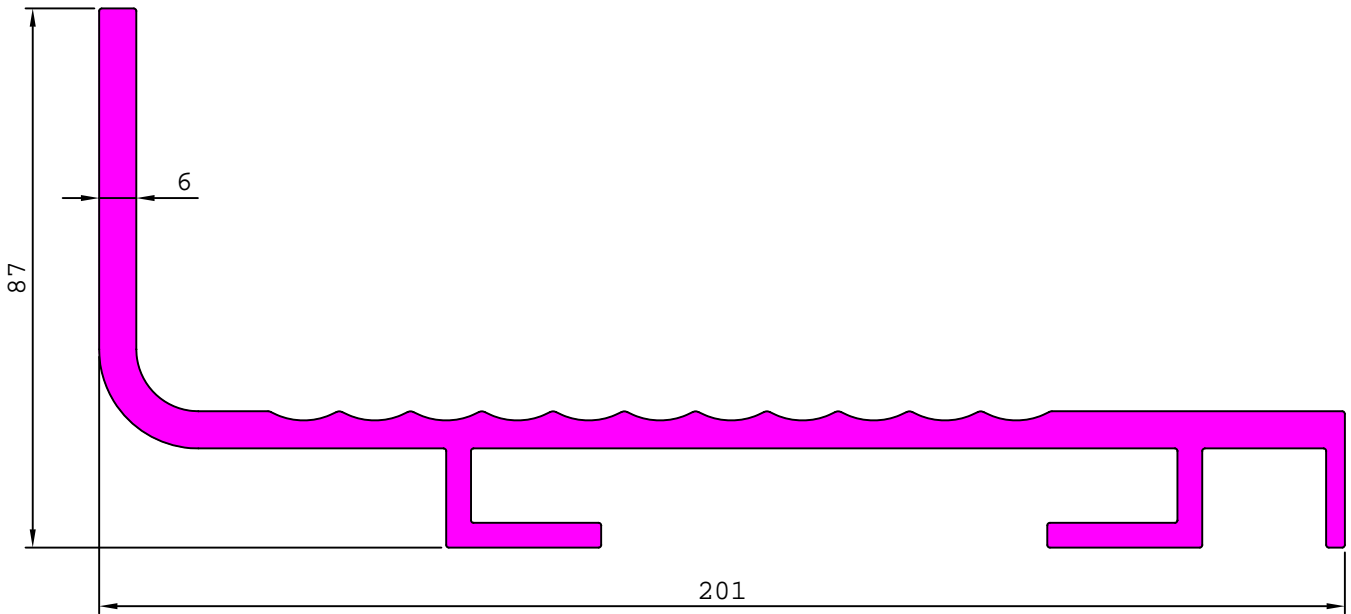

29524

2.219 kg/m

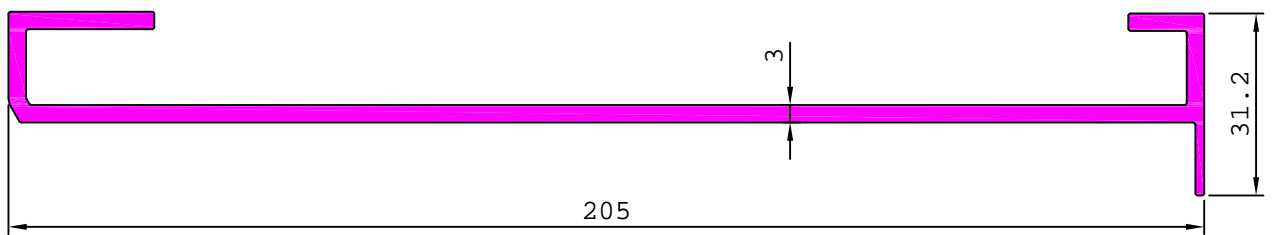

29525

1.724 kg/m

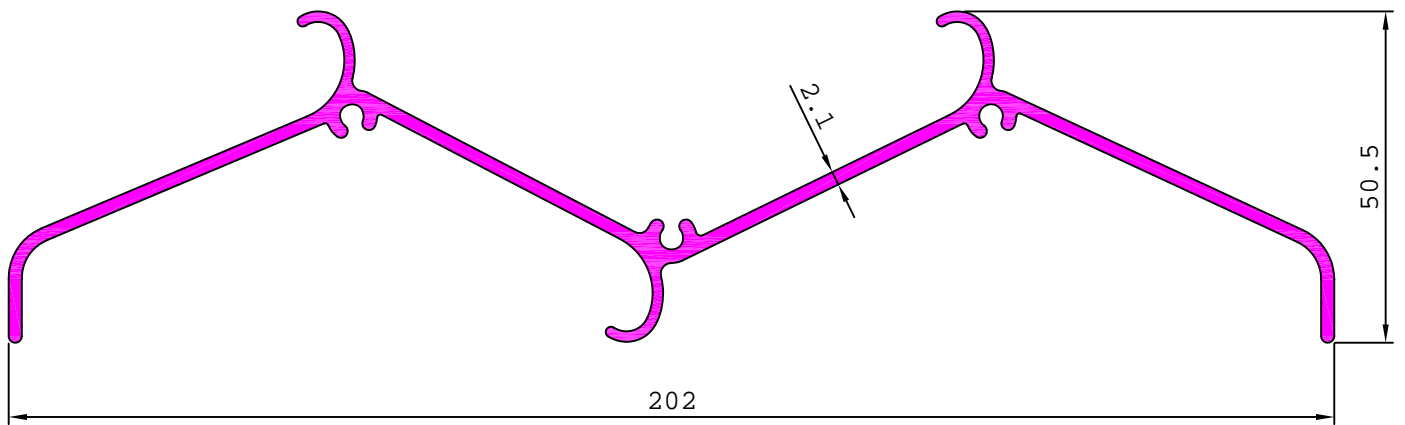

29544

12.440 kg/m

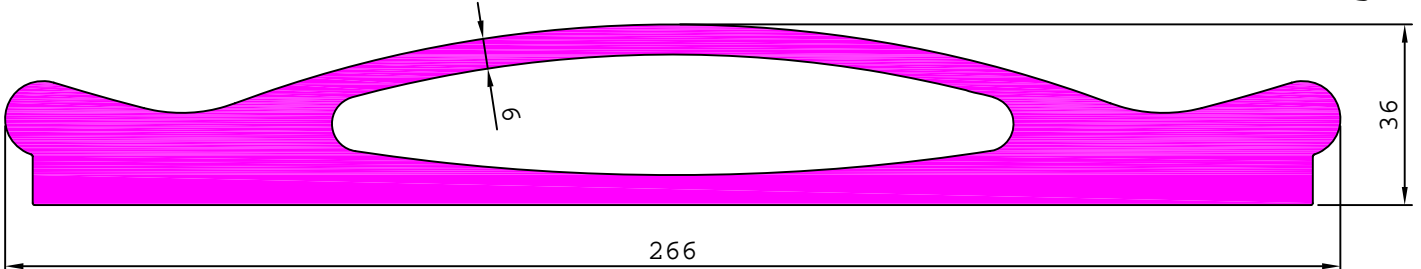

GENERAL

MISCELLANEOUS

29548

2.357 kg/m

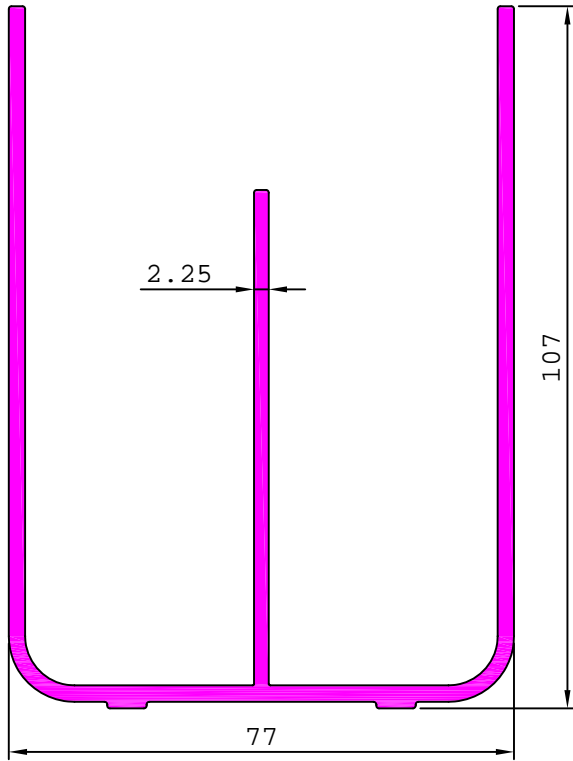

29570

3.087 kg/m

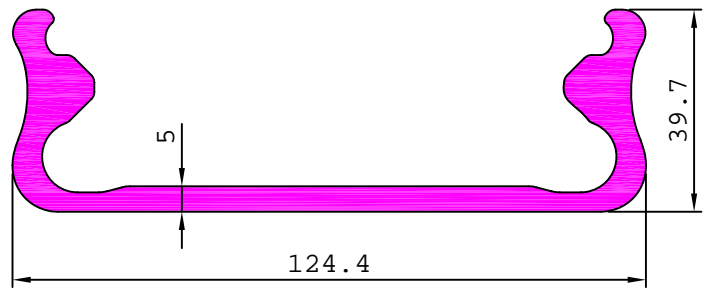

28006

3.077 kg/m

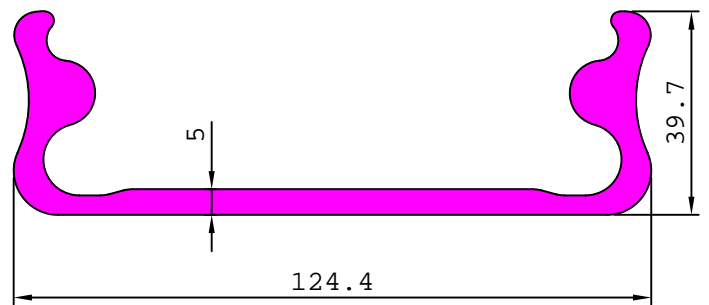

29549

8.485 kg/m

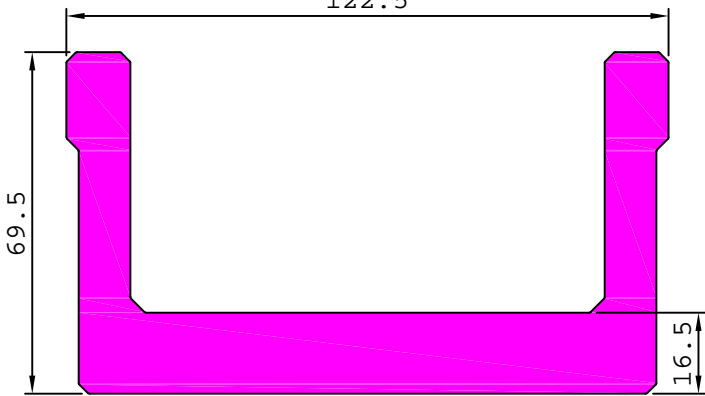

29550

17.923 kg/m

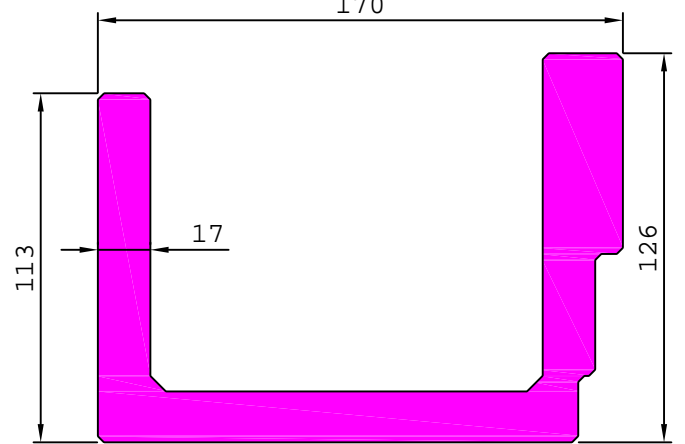

29558

0.655 kg/m

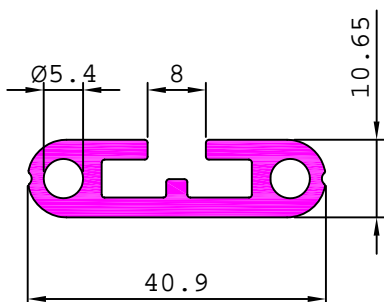

29564

0.381 kg/m

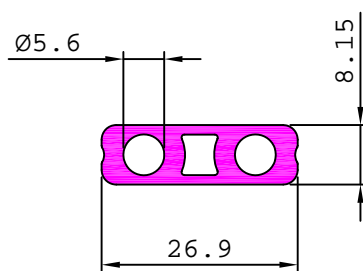

29565

0.171 kg/m

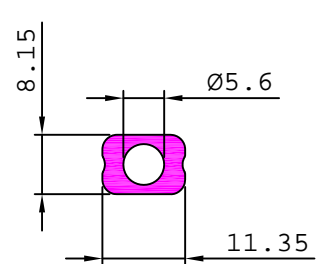

GENERAL

MISCELLANEOUS

29566

3.131 kg/m

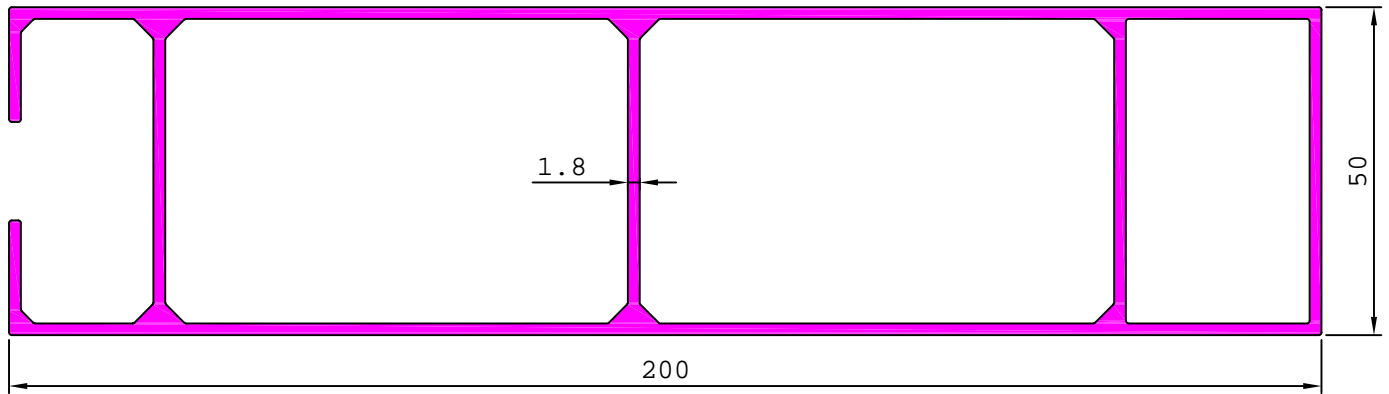

29567

0.086 kg/m

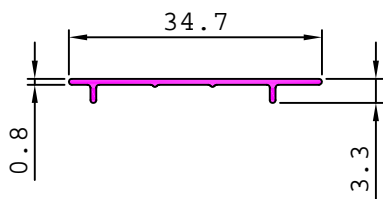

29568

0.146 kg/m

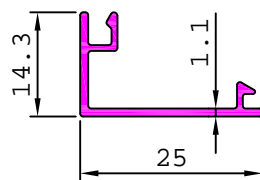

29569

0.091 kg/m

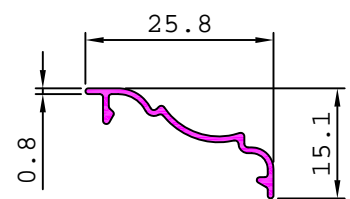

29573

1.443 kg/m

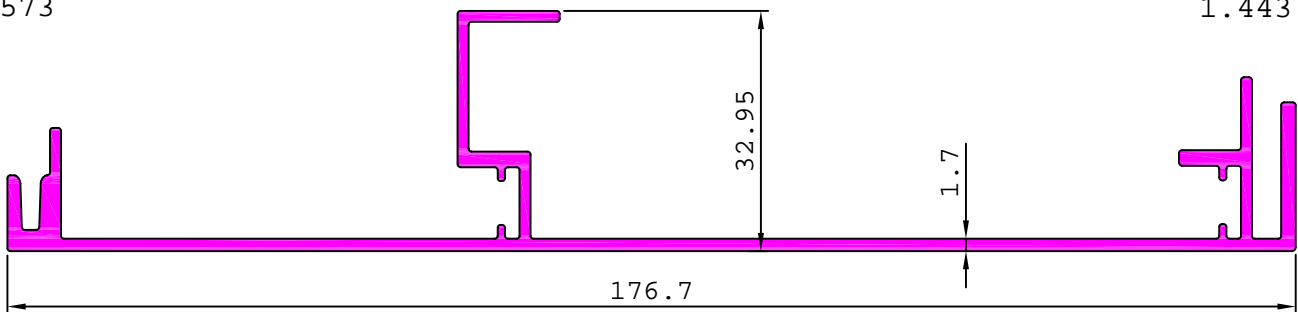

29574

0.399 kg/m

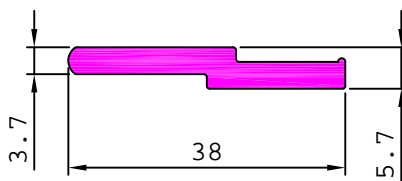

29587

2.972 kg/m

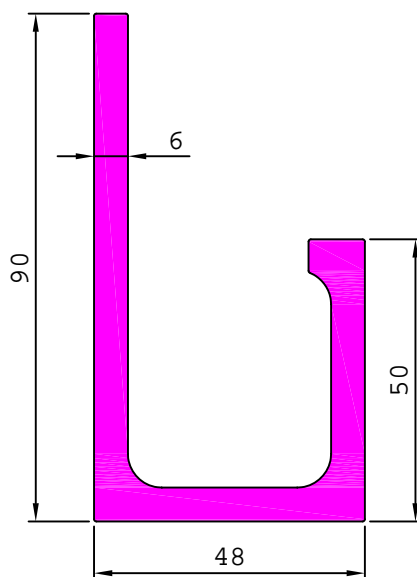

29591

25.919 kg/m

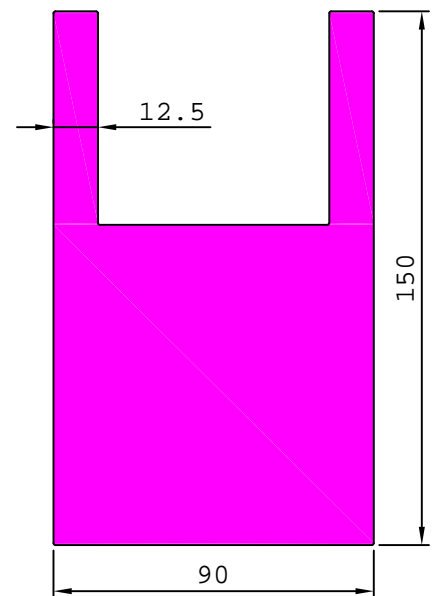

29581

0.231 kg/m

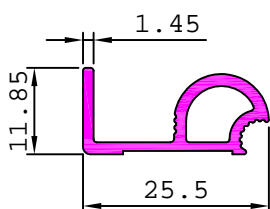

GENERAL

MISCELLANEOUS

29577

1.191 kg/m

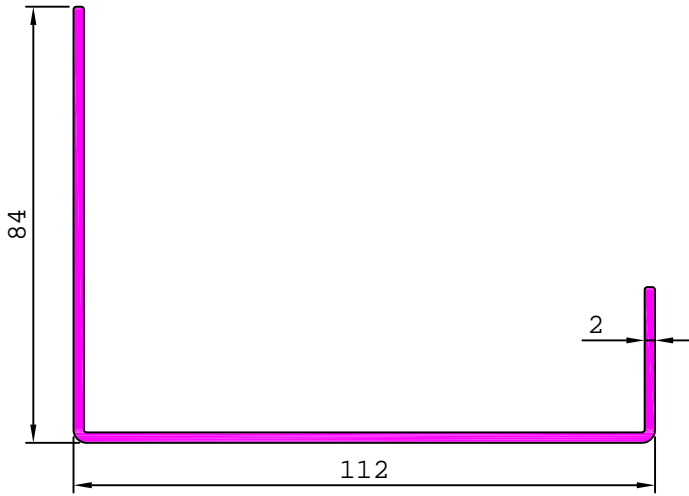

29578

2.883 kg/m

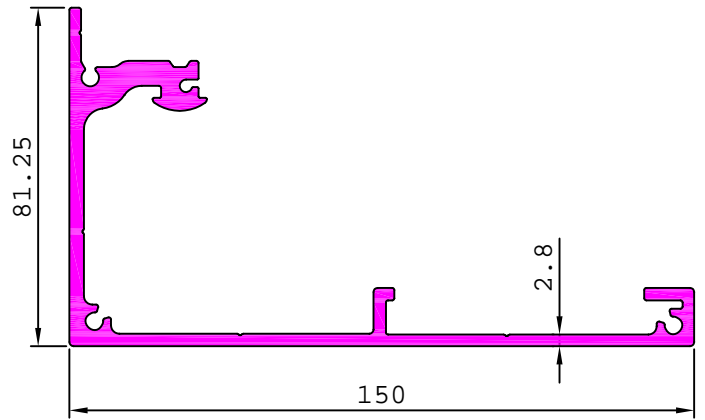

29579

2.096 kg/m

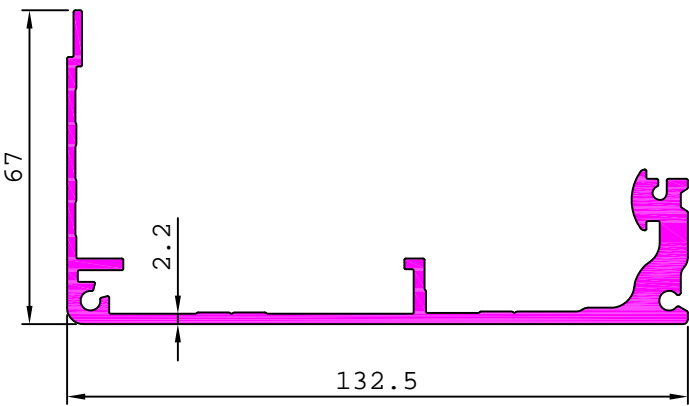

29599

9.436 kg/m

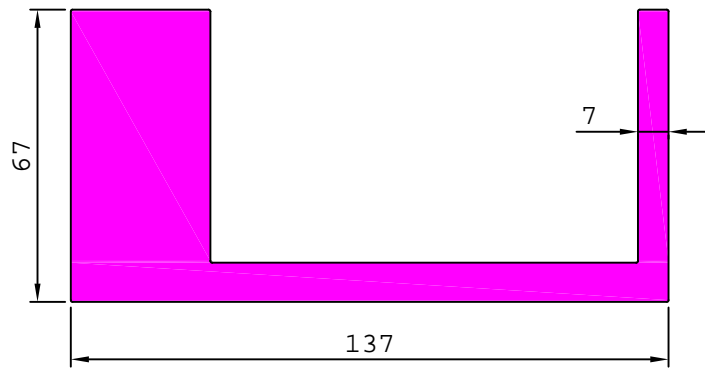

29585

1.474 kg/m

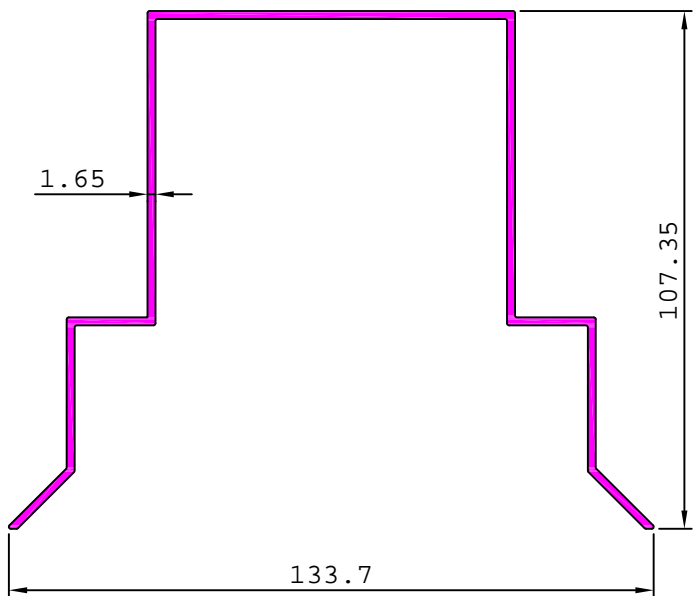

29586

1.407 kg/m

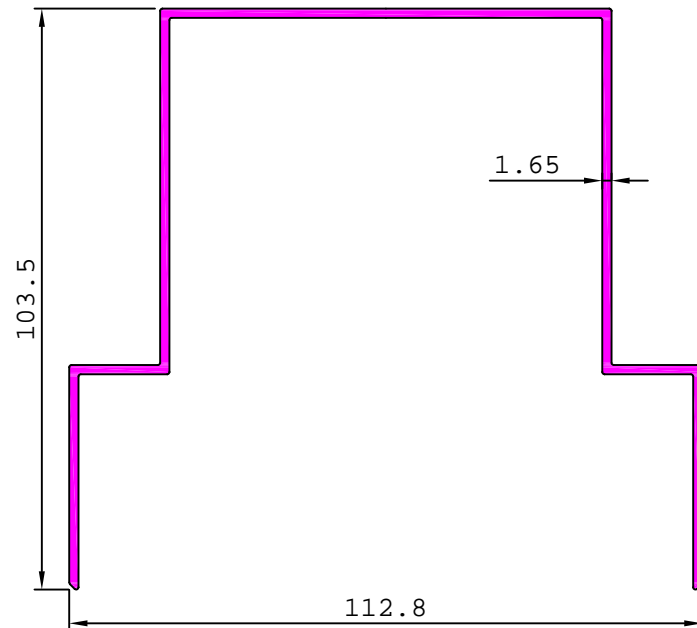

GENERAL

MISCELLANEOUS

29588

4.237 kg/m

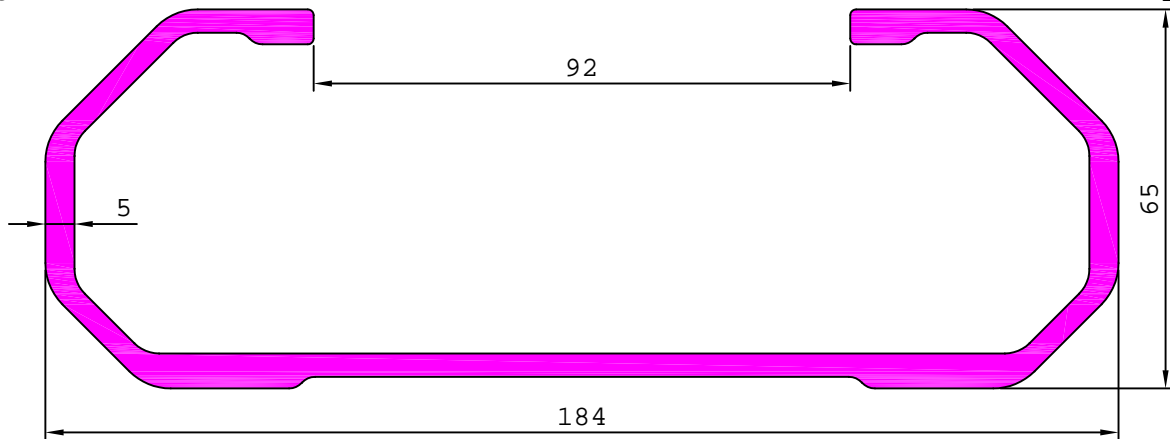

29593

1.749 kg/m

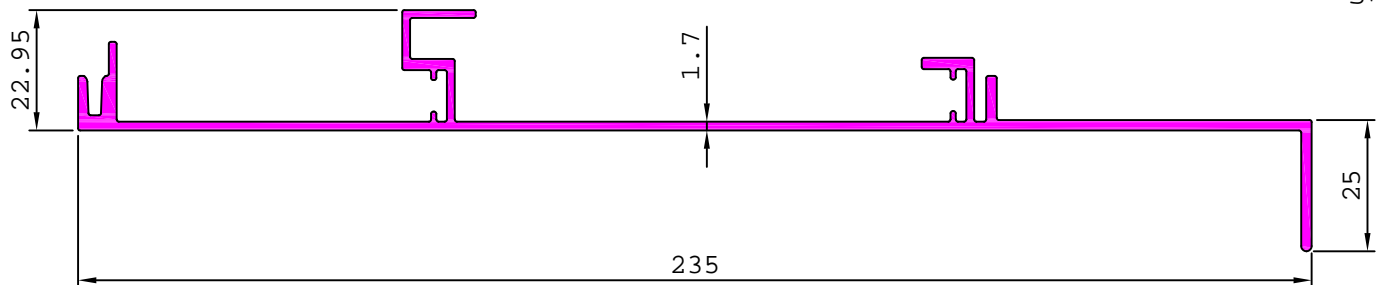

29603

1.568 kg/m

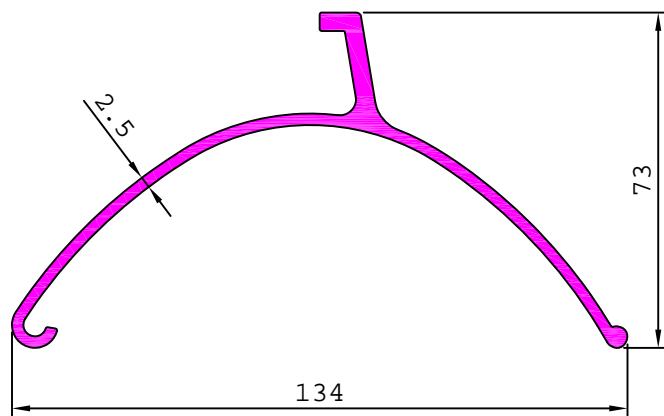

29614

4.489 kg/m

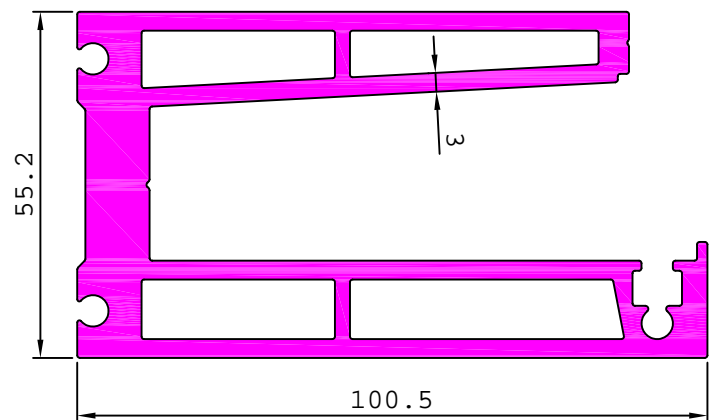

29604

1.700 kg/m

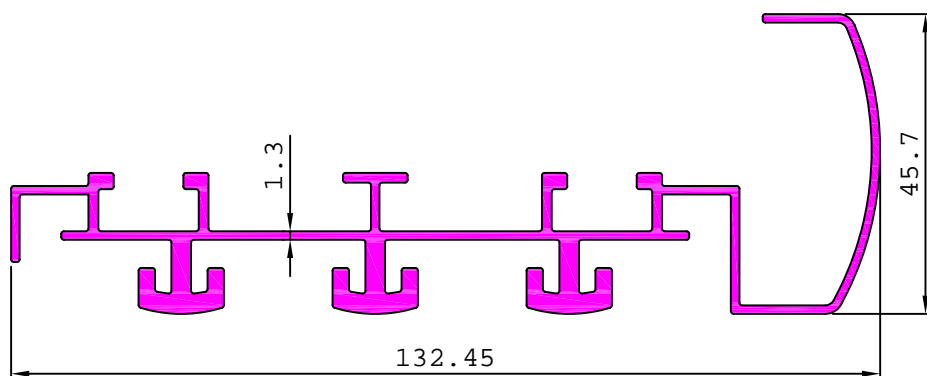

29606

0.628 kg/m

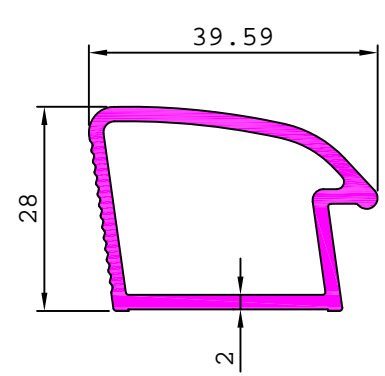

GENERAL

MISCELLANEOUS

29607 0.414 kg/m

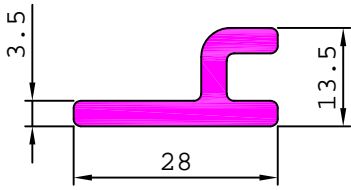

29609 0.083 kg/m

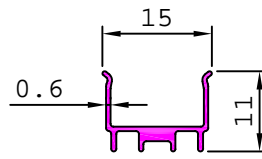

29615 0.333 kg/m

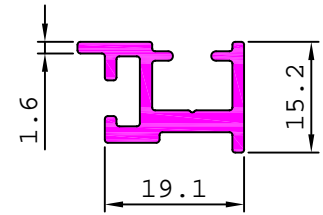

29612

1.210 kg/m

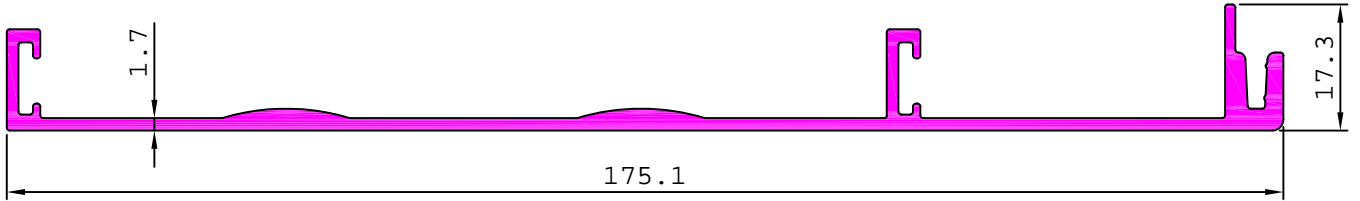

29616

1.939 kg/m

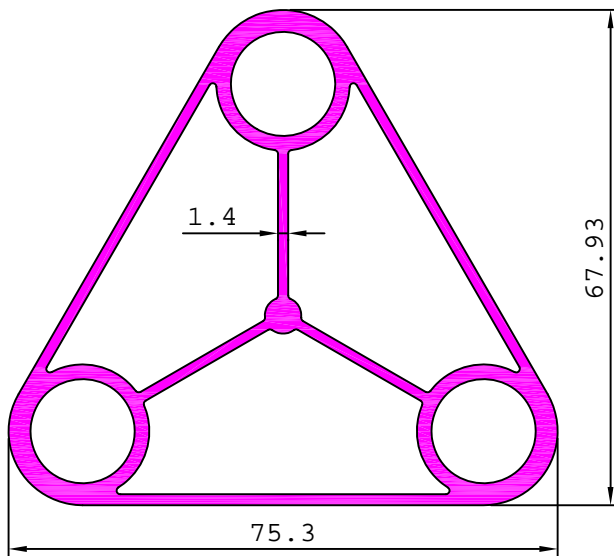

29618

0.312 kg/m

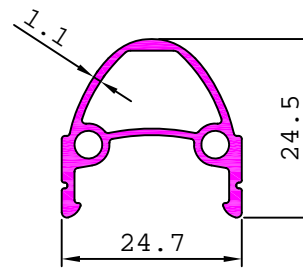

29619

0.344 kg/m

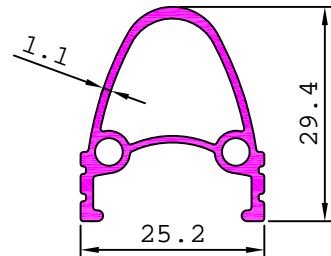

29639

3.387 kg/m

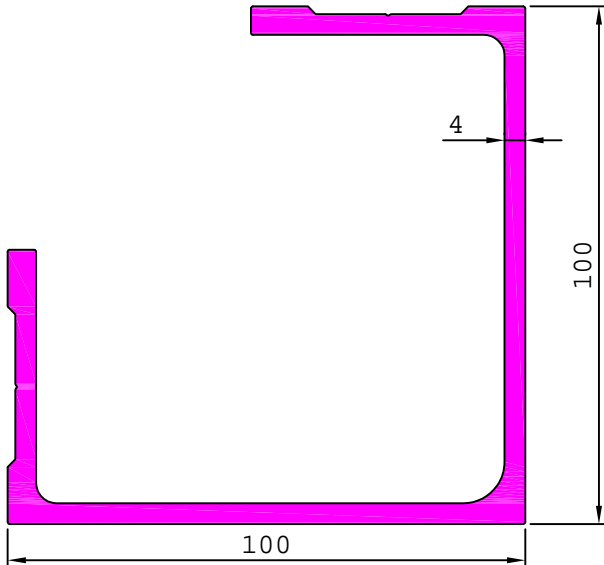

29643

1.311 kg/m

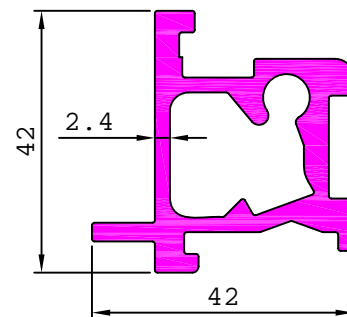

29640

0.831 kg/m

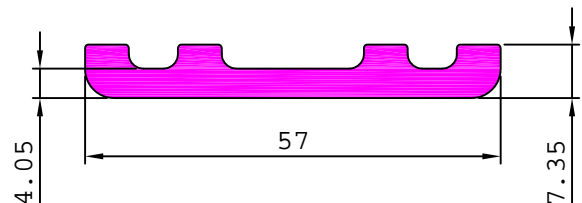

GENERAL

MISCELLANEOUS

29644

3.676 kg/m

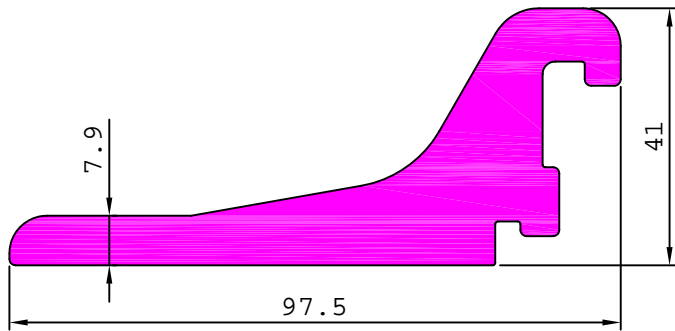

29647

0.717 kg/m

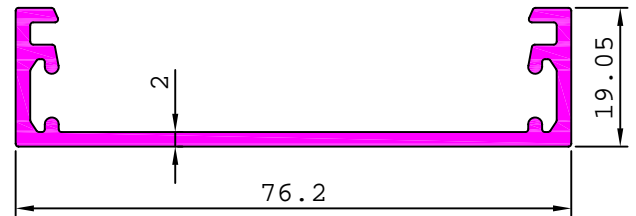

29649

0.204 kg/m

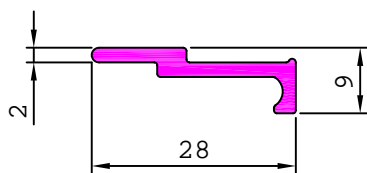

29650

2.585 kg/m

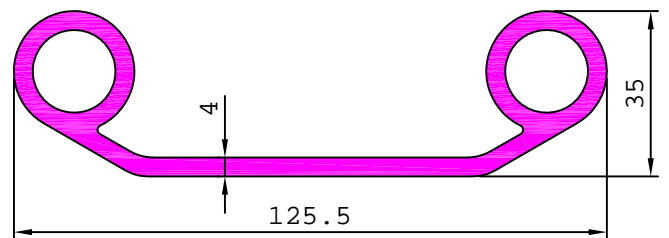

29652

2.742 kg/m

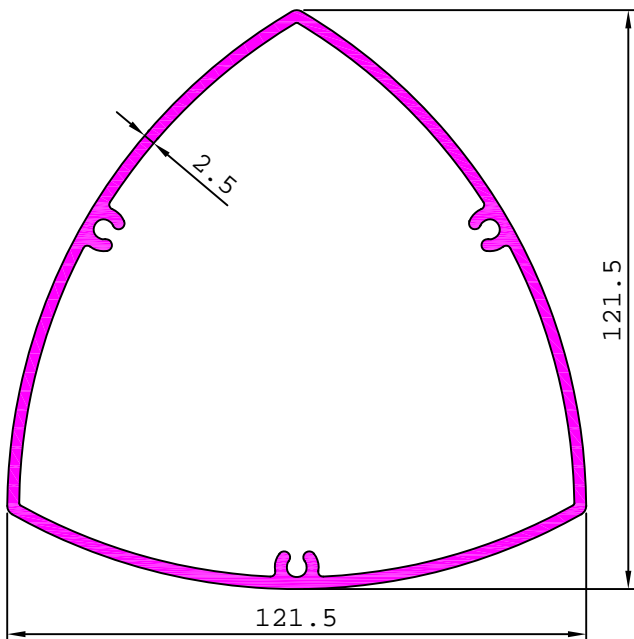

S4922

7.655 kg/m

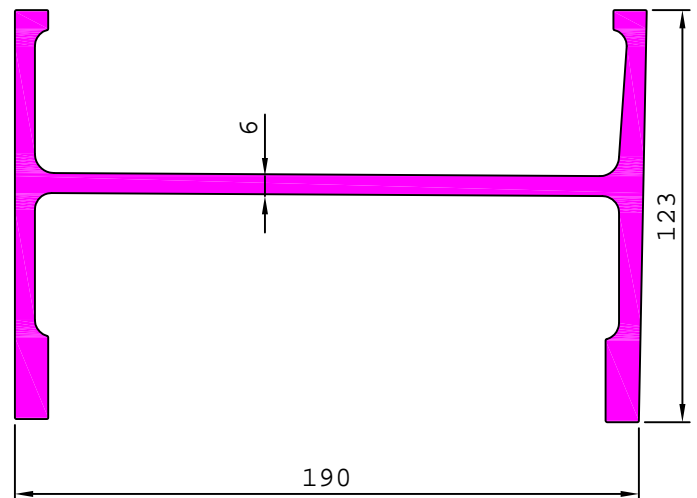

28770

1.176 kg/m

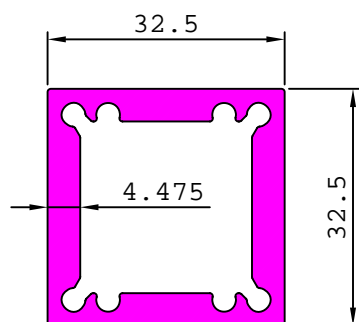

S4629

0.292 kg/m

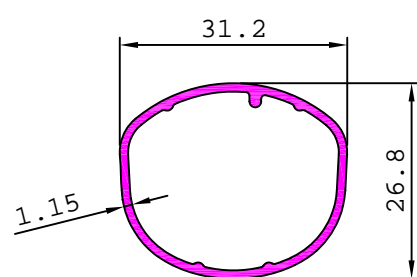

GENERAL

MISCELLANEOUS

27952

1.056 kg/m

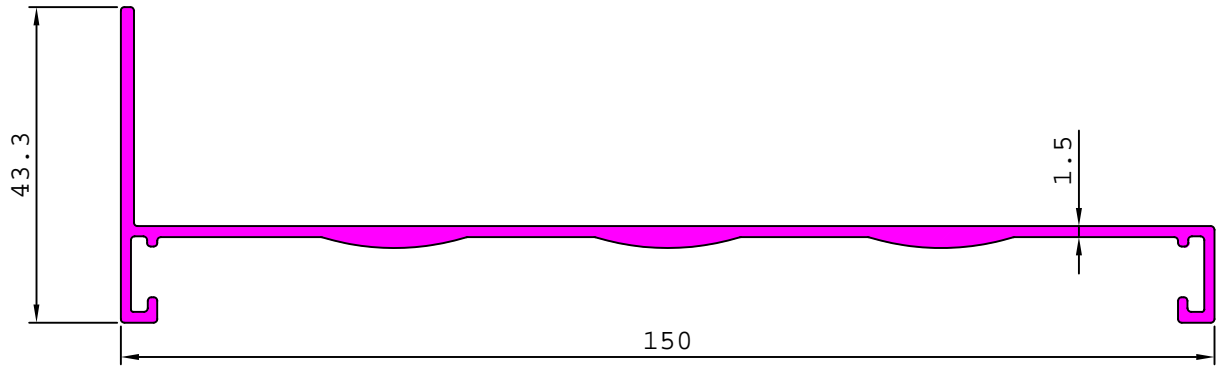

S5185

1.254 kg/m

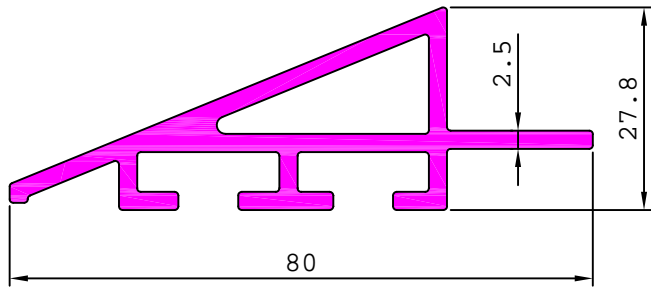

S5186

1.647 kg/m

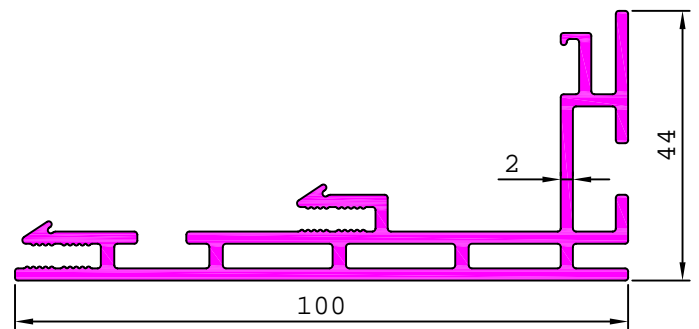

A BEACON IN INDIA'S ALUMINIUM INDUSTRY

Jindal Aluminium Limited (JAL) specializes in a smart array of solutions as the true measure of success for the building and architecture industry. With a reputation that is built on reliability, innovation and flexibility, JAL is the only company in India equipped with 7 extrusion presses ranging from 750 US Tons to 4000 US Tons with installed capacity of 75000 tons per annum. The company offers an array of nearly 9500 Aluminium extruded profiles. Jindal extrusions are also exported to USA, Canada, UK, Europe, South America, Middle East and other African countries with widespread applications in the field of Construction, Aerospace, Aviation, Transport, Solar Energy etc.,

JAL has diversified into Aluminium rolled products by manufacturing Aluminium sheets, coils and Aluminium foils with installed capacity of 40,000 TPA. JAL has gained good market share and reputation with supplies of good quality products.

It is good to note that Jindal prices are not higher as presumed by some customers and our customers are always satisfied using 'Jindal' material due to its durability, fine finish and guaranteed properties due to superior process and use of finest materials.



Aluminium Extrusions & Flat Rolled Products



Jindal Aluminium Limited

Regd. Office & Works: Jindal Nagar, Tumkur Road, Bangalore – 560 073, India, Ph: +91 80 2371 5555(6lines)
Fax: +91 80 2371 3333/34, Email: jindal@jindalaluminium.com, **DELHI:** 'Naturelle' 11, Green Avenue, Behind Sector-D-III, Bhatta Road, Vasant Kunj, New Delhi-110070 Phone: 011-26890962/63 Fax: 26135000, Email: jaldel@jindalaluminium.com, **MUMBAI:** The Capital, 508, 5th floor, Opp: ICICI Bank gate No.1, Bandra Kurla Complex, Bandra East, Mumbai 400051 Phone: 022 66745555, Email: jalmumbai@jindalaluminium.com



IS / ISO-9001



www.jindalaluminium.com